

Measurement processes in quantum physics: a new theory of measurements in terms of statistical ensembles

W. A. Hofer
Technische Universität Wien
A-1040 Vienna, Austria

Considering the recently established arbitrariness the Schrödinger equation has to be interpreted as an equation of motion for a statistical ensemble of particles. The statistical qualities of individual particles derive from the unknown intrinsic energy components, they depend on the physical environment by way of external potentials. Due to these statistical qualities and wave function normalization, non-locality is inherent to the fundamental relations of Planck, de Broglie and Schrödinger. A local formulation of these statements is introduced and briefly assessed, the modified and local Schrödinger equation is non-linear. Quantum measurements are analyzed in detail, the exact interplay between causal and statistical reasons in a measurement process can be accounted for. Examples of individual measurement effects in quantum theory are given, the treatment of diffraction experiments, neutron interferences, quantum erasers, the quantum Zeno effect, and interaction-free measurements can be described consistent with the suggested framework. The paper additionally provides a strictly local and deterministic calculation of interactions in a magnetic field. The results suggest that quantum theory is a statistical formalism which derives its validity in measurements from considering every possible measurement of a given system. It can equally be established, that the framework of quantum physics is *theoretically* incomplete, because a justification of ensemble qualities is not provided.

03.65.Bz, 03.75.Dg, 04.20.Gz, 41.20.Gz

I. INTRODUCTION

In recent papers we demonstrated that quantum theory allows for a layer of hidden variables, which determines the properties of individual electrons and photons [1,2,3]. The aim of the new theory was to estimate, whether the current axiomatic interpretation of quantum theory is the only possible solution to wave-like properties of micro physical systems, especially since the current standard does not allow for a *physical* interpretation of wave functions.

By revealing intrinsic potentials inherent to wave properties of moving particles the wave structures of individual particles could be deduced, which provided the fundamental relations of quantum theory as well as electrodynamics. The Schrödinger equation [4] was identified as a mechanical modification of the particle wave equation, and it was demonstrated, that it allows for a level of arbitrariness described by the uncertainty relations.

As many discussions with readers of the previous summary of the theory [3] showed, the exact range of the concept was not defined clearly enough. Equally did the logical relation between the theory and measurements in quantum theory not be clearly determined. This was partly intended, since the first step of establishing a new concept must be the definition of fundamental properties and relations. As ensembles and interactions of ensembles are somewhat more complex than single particles, the issue of measurements and systems of particles was left aside. But as the logical implications of measurements in quantum theory present a substantial problem not solved in any other way than by applying the axioms of the *Copenhagen interpretation* [5], the issue surely requires to be clarified.

This paper is therefore aimed at determining the *exact* interface, where the deterministic picture of material wave theory – based on the qualities of single electrons and photons and their interactions – is replaced by the statistical picture of quantum theory. It is equally sought to clarify, how quantum theory combines the two different perspectives in a single picture, more precise, what the mathematical procedures employed actually signify.

In order to clarify the essential issues of this paper some initial remarks seem necessary, especially in view of current concepts. The standard framework (classical electrodynamics and quantum field theory) employs three central concepts for the description of physical events: a *particle* is thought to be a *physical* entity with definite mechanical qualities (mass and charge, enhanced with the non-classical quality of spin) and local boundaries commonly considered insignificant (this is also the case for de Broglie's particle and Renninger's conception of the photon). Dealing with particles, physics tends to consider them as reasonably stable units (even in case of short decay times). A *wave* possesses neither limited dimensions, nor can it be described in terms of mechanical quantities. The notion of *coherence length*, used to describe the maximum extension of a field in order to produce interference effects, is already a combination: while in a strictly classical context, the concept of light pulses with small cross-sections (an everyday experience in laser-optics), would lead to severe boundary problems at the local limits of the laser beam, a more practical approach has to account for the limited extensions of electromagnetic fields and reduces classical theories to the region well within the beam boundaries. Given this limited extension of fields in phenomena of light absorption and emission – verified in abundance in spectroscopic mea-

surements –, it seems evident that the classical theory cannot be employed to describe events in a large system without substantial adaptations. Therefore neither the concept of a mechanical particle (usually considered point-like), nor the concept of a wave (essentially unlimited) are strictly valid.

These, practical, limitations have so far not found sufficient resonance in theoretical modeling. More important, these limitations have not even been used in any fundamental way to modify the physical frameworks.

As the Maxwell equations are verified to the point of certainty, the question of their validity needs to be analyzed from the viewpoint of limited field extensions. If unlimited space is thought to be filled by electromagnetic fields, the actual value of these fields within the coherence length of a beam should yield results which are not initially compatible with the solutions of the Maxwell equations, since, after all, energy conservation in the classical framework does not account for beam boundaries. As the solutions of Maxwell's equations are determined but for a constant of integration, the absolute quantity cannot be calculated: the solutions therefore do not allow for an evaluation of energy density in specific regions of the system. The problems of compatibility, as soon as quantities are considered, points to the essential limitations of classical electrodynamics: which is, in our view, one more reason for the infinity problems inherent to quantum electrodynamics.

Similar considerations apply to the problem of point-like particles: in this case an aggregation is determined by the absolute quantity of mass or charge. The energy density then acquires a statistical meaning.

The decisive results of previous papers on material wave theory do not allow for either of these interpretations: as found by considering the intrinsic properties of *single* particles, their internal structure complies with the Maxwell equation, i.e. with a strictly deterministic and causal framework. The theory introduced the concept of a *limited extension* of single particles, and it was shown, that the local extension does not alter the results achieved. The consequence of this notion was developed on a fundamental level. On the one hand, the physical units of electrodynamics were analyzed in view of interaction processes, achieved by photons: the result of this analysis was that the units actually signify *mechanical* energy densities. On the other hand, it was sought to clarify the notion of an *energy quantum* in interaction processes: and the essential result, in this respect, was that the decisive properties are energy densities and not energy quanta.

In this paper, the fundamental ideas of the new approach are developed in view of current standards. Since a particle, or the limited extension of a physical entity complying with the Maxwell equations, cannot be the origin of statistical measurement results, we have to consider an ensemble of these entities. The structure of the ensemble considered derives from the, equally derived, fundamental uncertainty in any evaluation of the

Schrödinger equation: contrary to Maxwell's equations this equation does not provide causal and deterministic results, because it is essentially arbitrary. The fundamental entity of this new approach could be called a *wave particle*: wave-like qualities are retained as internal structures and polarizations of the intrinsic fields, while the particle aspect is due to its limited extensions. The duality is therefore replaced by a physically rigorous simultaneity: and it is equally shown, that the classical limit is a specific form of the resulting ensemble. An ensemble with exactly defined energy values.

We are well aware that this treatment is not fully causal, because it includes statistical ensembles. This statistical feature, as will be demonstrated, is also inherent to classical electrodynamics: if the coherence length of single photons and the intensity of radiation are successively decreasing, then the overall formalization of electrodynamics *must* become a statistical limit. That is not to say, though, that the statistical qualities are inherent to the interactions or interferences of a single photon: the individual process is causal and deterministic, but neither electrodynamics, nor quantum theory deal with these single processes, but only with statistical ensembles of many single entities.

The main advantage of this new approach as well as its essential justification is to provide a theoretical framework which is neither limited to mechanical nor to strictly field theoretical concepts. The fundamental results of current theories can be derived in a close to local framework (the only concession to non-locality is the assumption that frequency and wavelength remain fairly constant within the considered region), and the concept of "spin" as well as the logically puzzling results of diffraction and interference measurements can be understood without recurring to extraneous sources or potentials.

In section II we develop the principal consequences of the arbitrariness inherent to the Schrödinger equation, by including all particle wave functions for a specific energy eigenvalue E . The result is a statistical ensemble, which is changed in different potential environments. On this basis the probability amplitude $\psi^*(\vec{r})\psi(\vec{r})$ of the ensemble is derived, which is a function of E and $V(\vec{r})$. The wave-particle duality, which is inherent to conventional models, is found to be a result of misinterpreting the properties of ensembles as properties of single particles. In the suggested model the duality is replaced by a hierarchical structure of single particles, particle ensembles, and their mathematical description.

Section III proposes a local modification of the Schrödinger equation. It is shown that the local equation is non-linear and the consequences for the superposition of two plane waves are developed: while the wave equation and the electromagnetic framework are not affected by non-linearity, the modification leads to interference effects if system development is evaluated with the Schrödinger equation.

In section IV the collapse of the wave-function due to external potentials is analyzed, it is shown that the

process has to be seen as change of statistical ensembles.

In section V we analyze the original diffraction experiments and its modern version, the neutron interferences. Magnetic interactions are calculated, and it is established that interaction energy does not depend on the orientation of magnetic fields.

Section VI and VII treat two specific measurements effects in quantum theory, the quantum Zeno paradox and the interaction free measurements.

In section VIII the statistical model of particle manifolds is compared to hidden variable theories and to the proofs by von Neumann and Jauch and Piron, that a statistical interpretation of quantum theory is contradictory. It is shown, that the particle ensemble, treated in quantum theory, is not dispersion-free, which renders the theoretical proofs against hidden variables inapplicable.

As a new theory can only gain by deviating viewpoints and controversial opinions, any feedback is greatly appreciated: readers are encouraged to contact me directly via email at the email address: whofer@epa04.iap.tuwien.ac.at

II. QUANTUM ENSEMBLES

Rejecting the orthodox Copenhagen interpretation of quantum theory requires, in principle, a clarification of the interface between causal behavior of the intrinsic properties of single particles (described by the classical theory of electrodynamics and additional results on electron-photon interactions), and the results of measurements in microphysics, which are generally of a statistical nature. Or, in David Bohm's words [6]:

The usual interpretation of the quantum theory is self-consistent, but it involves an assumption that cannot be tested experimentally, viz., that the most complete possible specification of an individual system is in terms of a wave function that determines only probable results of actual measurement processes. The only way of investigating the truth of this assumption is by trying to find some other interpretation of the quantum theory in terms of at present "hidden" variables, which in principle determine the precise behavior of an individual system, but which are in practice averaged over in measurements of the type that can now be carried out.

In the previous paper [3] it was found that the Schrödinger equation can be seen as the linear differential equation of internal particle structures. Its derivation by way of the wave equation employed a mechanical concept, the total energy of a particle wave. This total energy was, like in classical mechanics, determined by kinetic energy of the particle and potential energy of a given environment. The essential difference from *any* current interpretation is the result, that Schrödinger's equation does not completely define the intrinsic properties of any single particle, because it generally omits intrinsic potentials. It could be shown, in this context, that the immediate

consequence of this arbitrariness is the fundamental uncertainty in Heisenberg's relations [7].

In the following section we will determine the structure of the statistical ensembles pertaining to this fundamental arbitrariness. To differentiate between solutions applying to single particle waves from solutions applying to the whole ensemble, we will use the terms *particle*, *wave particle*, or *particle wave* to denote the intrinsic properties of any specific particle with finite dimensions, while the term *ensemble* refers to all particles or particle waves meeting the described requirement.

A. Quantum ensemble of free particles

Due to periodic wave functions, the intrinsic potential at an arbitrary moment t can take any value, and the wave vector of the problem therefore is not exactly determined, but covers the whole range from $k^2 = 0$ to $k^2 = \frac{m}{\hbar^2} E_T$. The interpretation of this result reveals a rather interesting feature of the Schrödinger equation. The differential equation in its time-free formulation does not only describe one specific particle or one specific wave function, but a whole range of individual particle wave functions for every single point of a given region. When seen from the viewpoint of intrinsic particle properties it describes therefore an allowed range of particle states. And the formalism is basically a statistical distribution, where every single result has the same statistical weight.

Consider a point \vec{r} , where the external potential vanishes $V(\vec{r}) = 0$. Due to the disregard for intrinsic potentials the Schrödinger equation at this location applies for all particle waves described by:

$$\begin{aligned} \vec{k}^2(\vec{r}) + \vec{k}_i^2(t) &= \frac{m}{\hbar^2} E_T \\ 0 \leq \vec{k}_i^2(t) &\leq \frac{m}{\hbar^2} E_T \end{aligned} \quad (2.1)$$

$\vec{k}_i^2(t)$ denotes the intrinsic potential, not accounted for in quantum theory, which is the origin of the inherent arbitrariness. E_T is the total energy of the particle. The two variables are given by:

$$E_T = mu^2 \quad \frac{\hbar^2}{m} \vec{k}_i^2(t) = \phi_i(t) V_P \quad (2.2)$$

where u is the velocity and V_P the volume of a particle. The *quantum ensemble* is the Fourier integral over allowed wave states. The wave function $\psi(\vec{r})$ can then be written as:

$$\begin{aligned} \psi(\vec{r}) &= \frac{1}{(2\pi)^{3/2}} \int_0^{k_0} d^3k \phi_0(\vec{k}) e^{i\vec{k}\vec{r}} \\ k_0 &= \sqrt{\frac{m}{\hbar^2} E_T} \end{aligned} \quad (2.3)$$

Using the Fourier transformation the amplitudes of the ensemble are consequently:

$$\phi_0(\vec{k}) = \frac{1}{(2\pi)^{3/2}} \int_{-\infty}^{+\infty} d^3r \psi(\vec{r}) e^{-i\vec{k}\vec{r}} \quad (2.4)$$

The quantum ensemble in simplified accounts of quantum theory (especially the simplifications in fundamental treatments of wave mechanics, see, for example [8]) is reduced to its member of half the total energy. The reduction follows from the conventional solution of the Schrödinger equation, where a solution in the orthogonal basis of plane waves will be:

$$\begin{aligned} \psi(\vec{r}) &= \frac{1}{(2\pi)^{3/2}} e^{i\vec{k}_{qm}\vec{r}} \\ \phi_0(\vec{k}) &= \frac{1}{(2\pi)^3} \int_{-\infty}^{+\infty} d^3r e^{i(\vec{k}_{qm}-\vec{k})\vec{r}} = \delta^3(\vec{k}_{qm}-\vec{k}) \\ \phi_0(\vec{k}_{qm}) &= 1 \quad \phi_0(\vec{k} \neq \vec{k}_{qm}) = 0 \end{aligned} \quad (2.5)$$

From the viewpoint of material wave theory and equally quantum theory the reduction is an approximation (in quantum theory due to particle properties, while in material wave theory due to the fundamental arbitrariness). To describe the full ensemble of possible waves including intrinsic potentials the Fourier integral has to be retained, the quantum ensemble in this case is:

$$\begin{aligned} \psi(\vec{r}) &= \frac{1}{(2\pi)^{3/2}} \int_0^{k_0} d^3k \phi_0(\vec{k}) e^{i\vec{k}\vec{r}} \\ k_0 &= \sqrt{\frac{m}{\hbar^2} E_T} \quad E_T = mu^2 \end{aligned} \quad (2.6)$$

In view of intrinsic properties of particles the general solution of the Schrödinger equation of free particles considered at a specific location \vec{r} is thus not a defined state of the particle, but a defined range of possible particle states. The consideration applies to every single point.

The result differs from Bohm's analysis of the measurement process [9]. In Bohm's view the Schrödinger equation could not account for an ensemble of particles due to its mathematical properties. Since it is a linear differential equation of second order it completely determines the development of the wave function from initial values. The Schrödinger equation, Bohm concluded, is therefore the deterministic part of quantum theory. And he continued:

Yet it is not immediately clear how the ensembles, to which . . . probabilities refer, are formed and what their individual elements are. For the very terminology of quantum mechanics contains an unusual and significant feature, in that what is called the physical state of an individual quantum mechanical system is assumed to manifest itself only in an ensemble of systems.

Translating *system* into *particle*, the very features Bohm describes as inherent to quantum theory are

found by estimating the effect of arbitrariness on the results provided by the Schrödinger equation. The time-dependent Schrödinger equation will not be treated separately, because it is standard practice in quantum theory to separate the time-dependent part either by a linear harmonic including the energy or frequency of the particle, or by a unitary transformation yielding the development of time-free solutions of the Schrödinger equation.

B. Quantum ensemble in external potentials

An external potential at \vec{r} basically has two effects: the range of allowed particle waves and therefore the quantum ensemble will be changed, and the internal properties of single particle waves will be altered. If the potential at \vec{r} equals $V(\vec{r})$, the allowed k -values will comply with:

$$\begin{aligned} k^2(\vec{r}) + k_i^2(t) &= \frac{m}{\hbar^2} (E_T - V(\vec{r})) \\ 0 \leq k_i^2(t) &\leq \frac{m}{\hbar^2} (E_T - V(\vec{r})) \end{aligned} \quad (2.7)$$

$$k_1^2 = \frac{m}{\hbar^2} (E_T - V(\vec{r})) \quad E_T = mu^2 \quad (2.8)$$

For reasons of consistency the potential $V(\vec{r})$ is double the potential if only kinetic properties are considered. The range of allowed k -values in this case depends on the energy E_T of a single particle as well as the potential applied. There are two distinct cases: $E_T - V(\vec{r})$ is either a positive or a negative value, corresponding to particle waves in a potential or to exponential decay of single waves.

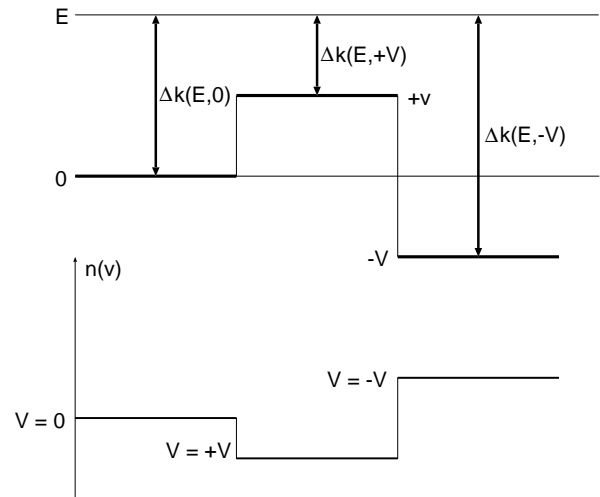

FIG. 1. Quantum ensemble of particle waves for three different potentials. A negative potential increases the number of allowed k -values, a positive potential has the opposite effect

1. Positive solutions $E_T - V(\vec{r}) \geq 0$

The potential applied can either be a positive or a negative value, leading to an enhancement or a reduction of the quantum ensemble of valid solutions. The general solutions for both cases are then:

$$\psi(\vec{r}) = \frac{1}{(2\pi)^{3/2}} \int_0^{k_1} d^3k \phi_0(\vec{k}) e^{i\vec{k}\vec{r}}$$

$$k_1 = \sqrt{\frac{m}{\hbar^2}(E_T \pm |V(\vec{r})|)} \quad E_T = mu^2 \quad (2.9)$$

The range of individual particle waves defines, as in the case of a vanishing external potential, an ensemble of particles, which comply with the differential Schrödinger equation. Any integration of the equation therefore also contains a – hidden – manifold of individual particle waves.

It is interesting to consider the effect of opposite signs of the external potential. A positive potential essentially limits the number of individual waves contained in the ensemble, because it diminishes the range of k . A negative potential has the opposite effect: the number of waves in the ensemble is increased, and their statistical weight in the whole system is equally higher. Fig. 1 displays the quantum ensembles for different external potentials.

2. Negative solutions $E_T - V(\vec{r}) \leq 0$

The mathematical formalism of Schrödinger's equation in this case allows for solutions with a negative square of \vec{k} , equivalent to an exponential decay of single particle waves:

$$k^2(\vec{r}) + k_i^2(t) = \frac{m}{\hbar^2} (E_T - V(\vec{r})) \leq 0$$

$$0 \geq \vec{k}_i^2(t) \geq \frac{m}{\hbar^2} (E_T - V(\vec{r})) \quad (2.10)$$

$$\psi(\vec{r}) = \frac{1}{(2\pi)^{3/2}} \int_0^{k_1} d^3k \phi_0(\vec{k}) e^{-\vec{k}\vec{r}}$$

$$k_1 = \sqrt{\frac{m}{\hbar^2}(V(\vec{r}) - E_T)} \quad E_T = mu^2 \quad (2.11)$$

The question in this case concerns not so much the mathematical formalism but the physical validity. Considering, that electrodynamics is a description of intrinsic properties of single particles, applicable to photons as well as electrons, the results of electrodynamics in different media should also have relevance for the wave properties of single particles. And considering, furthermore, that an exponential decay into a medium at a boundary is one type of solution, the same must generally hold for single particle waves. Therefore the exponential decay results from wave properties of single particles and has to be included in the overall picture. It is a basically *classical* solution to boundary value problems and, so far, no specific feature of a quantum system.

C. Wave function normalization

We have not yet defined the amplitude $\phi_0(\vec{k})$ of single components in the quantum ensemble. This can be done by requiring single particle waves to comply with the mass relations of particles. Since:

$$\phi^*(\vec{k})\phi(\vec{k}') = \frac{1}{(2\pi)^3} \phi_0(\vec{k})\phi_0(\vec{k}') e^{i\vec{r}(\vec{k}' - \vec{k})} \quad (2.12)$$

an integration over infinite space yields the result:

$$\int_{-\infty}^{+\infty} d^3r \phi^*(\vec{k})\phi(\vec{k}') =$$

$$+ \int_{-\infty}^{+\infty} d^3r \delta^3(\vec{k} - \vec{k}') \phi_0(\vec{k})\phi_0(\vec{k}') \quad (2.13)$$

$$m = \int_{-\infty}^{+\infty} d^3r |\phi(\vec{k})|^2 = \phi_0^2(\vec{k})$$

Using this amplitude the square of the wave function $\psi(\vec{r})$ in different external potentials can be calculated.

$$\int_{-\infty}^{+\infty} d^3r |\psi(\vec{r})|^2 = \frac{m}{(2\pi)^3} \int d^3r \int_0^k d^3k d^3k' e^{i\vec{r}(\vec{k}' - \vec{k})}$$

$$= m \int_0^k d^3k d^3k' \delta^3(\vec{k} - \vec{k}') = \frac{4\pi m}{3} k^3 \quad (2.14)$$

And since k can be written in terms of momentum of a particle the calculation yields the result, that the wave function of the electron ensemble integrated over the whole space is proportional to u^3 :

$$\int_{-\infty}^{+\infty} d^3r |\psi(\vec{r})|^2 = \frac{4\pi m^4}{3\hbar^3} u^3 = 2.46 \times 10^{-18} \cdot u^3 \quad (2.15)$$

The left term, the integral of the ensemble wave function, does not depend on the exact location, whereas the right term, the velocity or the wave vector of the quantum ensemble, clearly is a local function because it depends on the potential $V(\vec{r})$.

$$\int_{-\infty}^{+\infty} d^3r |\psi(\vec{r})|^2 = \alpha \cdot u^3(\vec{r})$$

$$u(\vec{r}) = \sqrt{\frac{1}{m}(E_T - V(\vec{r}))} \quad (2.16)$$

If $\psi(\vec{r})$ is therefore interpreted as the wave function of any *single* particle, the formalism must yield non-local effects. The result sheds some light on non-locality in quantum theory. While individual particle waves and the quantum ensemble are strictly local, the normalization of $\psi(\vec{r})$ and the subsequent interpretation of $\psi(\vec{r})$ as the wave function of single particles suffices to introduce non-locality into the basically statistical framework.

The problem can be avoided by considering intensive properties rather than quantities. If the potential $V(\vec{r})$

is constant throughout the system, the integral over the wave function $\psi(\vec{r})$ can be written:

$$\int_{-\infty}^{+\infty} d^3r |\psi(\vec{r})|^2 = V_S \psi^*(\vec{r})\psi(\vec{r}) = m \frac{4\pi}{3} k^3(\vec{r}) \quad (2.17)$$

And setting the volume of the system V_S equal to a particle volume V_P , the right term reduces to density $\bar{\rho}$ and a function of energy:

$$\psi^*(\vec{r})\psi(\vec{r}) = \bar{\rho} \frac{4\pi}{3} \left(\frac{m}{\hbar^2} \right)^{3/2} (E_T - V(\vec{r}))^{3/2} \quad (2.18)$$

The effect of these definitions will be that the *probability density* of the quantum ensemble can be determined, it will be a local function and depend on the potential as well as particle energy, while the average density $\bar{\rho}$ of the ensemble, which is a non-local function, can be calculated by an integral over the whole system of varying potentials:

$$\int d^3r |\psi(\vec{r})|^2 := 1 \quad \bar{\rho} = \frac{1}{\int d^3r [(E_T - V(\vec{r}))]^{3/2}}$$

$$\psi^*(\vec{r})\psi(\vec{r}) = \frac{(E_T - V(\vec{r}))^{3/2}}{\int d^3r (E_T - V(\vec{r}))^{3/2}} \quad (2.19)$$

It is evident that these definitions yield a local and steady function for the probability density of the quantum ensemble. The relation between probability density and energy at a point \vec{r} is non-linear. As the probability density of the quantum ensemble must be positive definite, this solution does not include situations where the total energy is lower than the external potential $V(\vec{r})$.

D. Boundary conditions

The decisive difference in the interpretation of quantum systems is the statistical interpretation of the manifold contributing to solutions to Schrödinger's equation. The difference becomes especially obvious, if boundary conditions are considered. One of the easiest examples in quantum theory, which suffices for this purpose, is the square potential well. We take a one dimensional potential well, the external potentials described by:

$$V = 0 \quad \forall |x| \leq x_0$$

$$V = V_0 \quad \forall |x| \geq x_0 \quad (2.20)$$

To solve the problem we have to consider the behavior of single members of the quantum ensemble as well as the behavior of the whole ensemble. The limiting k values can again be inferred from the solution of the one-dimensional Schrödinger equation, they will be for $E_T < V_0$:

$$k_0^2 \leq \frac{m}{\hbar^2} E_T \quad |x| \leq x_0$$

$$k_0'^2 \leq \frac{m}{\hbar^2} (V_0 - E_T) \quad |x| \geq x_0 \quad (2.21)$$

On the physical level any single member of the quantum ensemble then is subject to boundary conditions at the two boundaries $\pm x_0$. The problem on this level has to be treated by field theory, and we will use an analogy in electrodynamics. As electromagnetic waves, and also electron waves, are described by the same basic equations, the results of electrodynamics on wave reflection and exponential decay into a region, where oscillation is physically impossible, must equally apply. And as the energy is not sufficient for wave propagation in the potential barrier, the result in this area should be an exponential decay. As we generally are confronted with incident, reflected and penetrating waves, the three components of the wave are a wave of positive and a wave of negative propagation in the region $|x| < x_0$, and a decaying component in the region $|x| > x_0$. It has to be noted, that the concept of a particle does not arise at this level. If we use plane waves, it can be assumed that we only use the real or the complex component to satisfy the boundary conditions, since this component is periodic it will be proportional to a component of the intrinsic electromagnetic fields, and the boundary conditions imposed are then basically electromagnetic conditions.

Considering individual members of the ensemble, the lowest k value should correspond to maximum decay in the potential, while the member with maximum total energy should display maximum penetration. The relation between an arbitrary wave vector k_1 and its corresponding member k_2 must therefore be:

$$k_2^2 = \frac{m}{\hbar^2} V_0 - k_1^2 \quad k_1^2 + k_2^2 = \frac{m}{\hbar^2} V_0 \quad (2.22)$$

The wave functions in the three separate regions shall be described by standard solutions. Accounting for the boundary conditions for steady transition of the particle wave the coefficients can be determined and the solution for an individual wave is therefore, equivalent to the solution in quantum theory [10]:

$$\begin{aligned} \phi_0 \cdot e^{k_2 x} & \quad x \leq -x_0 \\ \phi(x) = \phi_0 \cdot e^{-k_2 x_0} \frac{\cos k_1 x}{\cos k_1 x_0} & \quad |x| \leq x_0 \\ \phi_0 \cdot e^{-k_2 x} & \quad x \geq x_0 \end{aligned} \quad (2.23)$$

The normalization conditions for a member of the ensemble allow to calculate the amplitude of the particle wave:

$$\phi_0(k_1, k_2) = \sqrt{\frac{mk_2}{1 + k_2 x_0}} e^{k_2 x_0} \cos k_1 x_0 \quad (2.24)$$

And the total ensemble can equally be calculated by integrating over the full range of allowed k values.

$$\int_{-\infty}^{\infty} dx |\psi(x)|^2 = 2 \int_0^{\infty} dx \left[\theta(x_0 - x) \int_0^{k_0} dk_1 \phi_0^2(k_1) \times \right. \\ \left. \times e^{-2k_1 x_0} \frac{\cos^2(k_1 x)}{\cos^2(k_1 x_0)} + \theta(x - x_0) \int_0^{k_0'} dk_2 \phi_0^2(k_2) e^{-2k_2 x} \right]$$

The amplitude $\phi_0(k)$ must finally be renormalized, and the square of the wave function then describes the probability distribution of the whole ensemble. The procedure described is equal to the standard procedure in quantum theory, since a single electron in quantum theory must be described as a Fourier integral over k space. The essential difference is, though, that in the present context k space is not unlimited, the cutoff is determined by the energy E_T .

The parallel treatment of quantum ensembles in different environments and the conventional treatment in quantum theory could basically be performed for arbitrary environments and initial conditions, for the present purpose it suffices to demonstrate, that the framework of quantum theory allows for a statistical interpretation. The causal level of the concept treats single particle waves and their boundary conditions, while the statistical level refers to manifolds of possible physical properties. Quantum theory is therefore a statistical concept, and the statistical distribution is equal to the quantum ensemble defined in this section.

E. Local ensembles

The particle waves treated in the context of intrinsic properties were *local* entities, the volume of any single wave is therefore finite. The normalization of the wave function for a full quantum ensemble of allowed energy values and arbitrary locations within the system has the effect, that the results of any integration of Schrödinger's equation are no longer strictly local. Consider a system with an arbitrary number of individual particle waves, which could be named, in an allusion to Louis de Broglie's term [11], *solitons*. In de Broglie's view a soliton possesses insignificant volume, its motion within the limits of the wave function was later referred to a hidden quantum potential (Bohm [6]) or to Brownian motion (Nelson [12,13]). In our view the term soliton shall only signify the exact energy value and the limited local extensions of a single particle wave, retaining all its intrinsic properties described by a field theoretical approach. The difference of the current approach to de Broglie's concept is the interpretation and the significance of the wavefunction for the qualities of ensembles: while de Broglie's suggestion that the wavefunction be associated with an ensemble of identical particles is accepted (these particles possess different positions within a considered system), the influence of the wavefunction on motion of the particles (or the concept of a pilot-wave) is rejected. In our view the wavefunction is not a strictly physical entity in ensembles, but a statistical measure. The current theory therefore combines two hitherto separate methods: the statistical interpretation of quantum theory by Ballentine [14], and the causal interpretation of the theory by de Broglie and Bohm [15,16,6]. But while the de Broglie-Bohm theory is highly non-local [17], the current frame-

work retains locality and refers physical processes to a change of the internal structure of the particles. That this essentially local concept is equivalent to the conventional one in the description of measurement processes, will be demonstrated in the following sections. But that it additionally allows to treat fundamental processes in a local and determinist manner, seems to be a major achievement.

Let us take an ensemble of particles with exactly defined energies. We will describe, how the quantum ensemble can be reduced to constant energy values in the following sections, currently we only assume, that it is feasible. Then a soliton covers only a comparatively small region of the whole system S , which we shall not specify. In this case the quantum ensemble consists of an arbitrary number of solitons, covering the whole of the considered system. The only arbitrariness retained is the local arbitrariness, the reason being again, that the time variable in Schrödinger's equation is accounted for by a unitary transformation removing any explicit local dependency. The solutions of Schrödinger's equations then cover the whole local range of the system. Since the amplitude of the wave function is arbitrary, the exact number of solitons cannot be estimated. The local ensemble $\psi_\nu(\vec{r})$ is given by:

$$\begin{aligned} \{\psi(\vec{r}, t \in [-\infty, +\infty])\} &\rightarrow \{\psi_\nu(\vec{r})\} \\ \vec{r} \in S &\quad \nu \in [0, \infty] \end{aligned} \quad (2.25)$$

And together with the normalization condition for the square of the wave function we are forced to accept the probability interpretation of the wave function.

$$\begin{aligned} \int_\nu \int_S d^3r d\nu |\psi_\nu(\vec{r})|^2 &=: 1 \\ \Rightarrow \int_\nu d\nu |\psi_\nu(\vec{r})|^2 &= w(\vec{r}) \end{aligned} \quad (2.26)$$

The concept clearly does not allow for any causal interpretation of the wave function. The structure of physical statements is therefore multidimensional. The causal dimension reflects interactions of single solitons due to fundamental processes, which can be seen as photon interactions. The interaction processes were extensively analyzed, and it was shown that the subsequent quantization rules apply to every single point of the intrinsic particle structure [3]. But the causal dimension is not sufficient, neither to account for the features of quantum systems, nor indeed for a physical formalization of measurement processes, which generally have to account for statistical ensembles. On this level the probability interpretation as well as the subsequent Copenhagen interpretation of quantum theory are *practical conventions* to deal with the statistical nature of microphysical processes. It must be stressed, though, that it is not a physical interpretation deriving from the structure of microphysical processes, but only an interpretation based on the features of quantum ensembles.

The local ensemble is a special case of the full quantum ensemble, the case where the energy of individual particles is exactly determined. Comparing classical field theories with ensemble structures, it will be seen further on, that the local ensemble is also the classical limit of quantum theory.

The ensemble is introducing, by way of normalization procedures, a non-local component into fundamental statements of quantum theory. That is, though, not the whole story. Based on this result it could be assumed, that some clever structure of physical statements will enable us to refer the statements to a strictly local theory. That this is not possible, even on the level of fundamental particles without fundamental changes in the mathematical structure of quantum theory, can be demonstrated as follows:

Take a particle (photon or electron) of finite volume V_P and exactly defined energy $\hbar\omega$. Consider now the frequency or wavelength of the particle wave at an arbitrary position \vec{r} within the particle. Then the frequency ω at this point is given by:

$$\omega(\vec{r}) = \frac{\rho(\vec{r}) \cdot V_P}{\hbar} \cdot u(\vec{r})^2 \quad (2.27)$$

Since the volume of the particle cannot be described as a function of location (or only, again, via a normalization condition $\rho(\vec{r}) \cdot V_P = m_P$), the frequency of the wave is not a function of location: the wave itself therefore has a non-local element to its structure, which remains only insignificant, as long as the volume is not measurable.

F. Classical limit

The intrinsic functions of a single particle waves describe the classical limit of physical theories, the case when the energy of the particle is exactly defined. Since the wave function (due to the relation $\rho \propto \psi^2$ see [3]) has the same periodicity as intrinsic electromagnetic fields, the classical electromagnetic solutions for an infinite system must be proportional to the wave functions for an infinite local ensemble. The classical limit of quantum theory therefore is the local quantum ensemble.

G. Spreading of a wave packet

It may seem that the definition of the ensembles is only justified in view of intrinsic potentials, that it is not originally a concept of quantum theory. That this is not the case can be shown by a calculation of developments with the time-dependent Schrödinger equation. The notorious *spreading of a wave packet* due to the application of Schrödinger's equation cannot be interpreted in a physical way, because the implicit experimental result has always been falsified.

If it is not a physical effect, it is nevertheless a feature inherent to the qualities of the wave function. And since the wave function is, in conventional reasoning, a measure for the probability density of particles, the problem remains, why the statistical nature of a quantum system of free particles is altered. This effect, so far not really understood, is a common source of irritation, and concepts have been put forth to eliminate it in a modified version of quantum theory (see, for example, Mackinnon [18,19]).

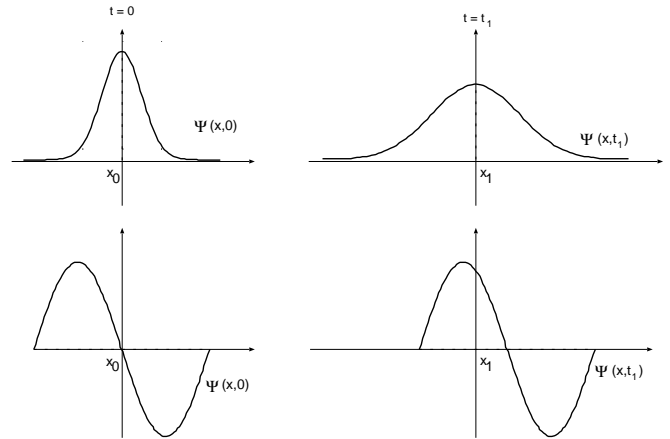

FIG. 2. Development of ensembles. An ensemble of arbitrary energy and Gaussian distribution will develop into a quantum ensemble of equal probability for all energy values (top). The development of a particle with exactly defined energy due to the Schrödinger equation or the wave equation leads to a local ensemble over the whole local range of the system (bottom)

We consider a quantum system of presently undefined k -vectors and local extension. Then the quantum ensemble at an initial moment $t = 0$ shall be given by the Fourier components of the wave function, $\hat{\psi}(\vec{k})$, the development of initial components shall be described by plane waves, for the sake of simplicity we treat the one-dimensional model:

$$\psi(x, t) = \int dk e^{i(kx - \omega t)} \hat{\psi}(k) \quad (2.28)$$

The essential feature to consider is the development of an initial distribution of a system only governed by the Schrödinger equation. The two initial distributions we estimate are the local ensemble with exactly defined energies and wave vectors and an inhomogeneous quantum ensemble, where the wave function shall be centered around a value $x_0 = 0$:

$$\begin{aligned} \psi_1(x, t = 0) &= e^{-\frac{x^2}{b^2} + ik_0 x} \\ \psi_2(x, t = 0) &= e^{ik_0 x} \end{aligned} \quad (2.29)$$

The Fourier transform can be calculated from the initial state of the wave functions, it will be:

$$\begin{aligned}\hat{\psi}_1(k) &= \int dx \psi_1(x, 0) e^{-ikx} = e^{-(k-k_0)^2 b^2/2} \\ \hat{\psi}_2(k) &= \int dx \psi_2(x, 0) e^{-ikx} = \delta(k - k_0)\end{aligned}\quad (2.30)$$

And the wave functions of the two systems are at $t > 0$:

$$\begin{aligned}\psi_1(x, t > 0) &= \frac{e^X}{\sqrt{b^2 + \frac{i\hbar t}{m}}} \\ X &= \frac{1}{2} \left(b^4 + \frac{\hbar^2 t^2}{m^2} \right)^{-1} \cdot \left(-k_0^2 b^2 \frac{\hbar^2 t^2}{m^2} + \dots \right) \\ \psi_2(x, t > 0) &= \exp(i(k_0 x - \omega_0 t))\end{aligned}\quad (2.31)$$

The norm of the two wave functions is consequently:

$$\begin{aligned}|\psi_1(x, t > 0)|^2 &= \left(1 + \frac{\hbar^2 t^2}{m^2 b^4} \right)^{-1} \times \\ \exp \left[-b^{-2} \left(1 + \frac{\hbar^2 t^2}{m^2 b^4} \right)^{-2} \cdot \left(x - \frac{\hbar k_0 t}{m} \right)^2 \right] \\ |\psi_2(x, t > 0)|^2 &= 1\end{aligned}\quad (2.32)$$

The norm of the wave functions in the infinite limit $t \rightarrow \pm\infty$, the probability density, will in both cases be an equal distribution over the whole range of the system: in case of the initial Gaussian distribution it does no longer reflect the initial structure of the Fourier transform, different components can then no longer be distinguished. It is, in the infinite limit, an equal distribution over the whole range of k values, or an infinite quantum ensemble. The second wave function will retain its kinetic properties, although it will cover the whole local range of the system. The wave therefore has the same qualities as the local ensemble. The development of the two ensembles is displayed in Fig. 2

As it is always possible to decompose an arbitrary distribution of initial k values in Gaussian distributions, the result holds quite generally. In case the system is left to itself, an application of the Schrödinger equation thus leads to a gradual change of the system qualities until, in the infinite limit, the qualities are equal to a quantum ensemble.

The spreading of the wave packet therefore appears to be a statistical process of restructuring: it reveals an entropy-like principle inherent to the conventional formulations of quantum theory, which is not quite easy to analyze. Apart from the requirement, that the final state of a system must be an equal distribution of physical qualities, it cannot be based on any physical foundation. That the equal distribution is physically relevant in measurement processes, will be derived later on. But that this groundstate of physical properties is arrived at without any interaction seems hard to accept.

There are two possibilities to account for this feature: (1) Either the restructuring is referred to some potential not covered by field theories, in this case we would have

to recur to Bohm's quantum potential [6]. (2) The initial conditions contain an assumption which affects the physical properties of particles. The answer to this problem can be found on the level of intrinsic properties of particles. Since $\psi(x)^2 \propto \rho(x) \propto \phi(x)$, an inhomogeneous distribution like $\psi_1(x, 0)$ gives rise to an intrinsic potential $\phi(x)$, described by:

$$\begin{aligned}\psi_1(x, 0) &= \psi_0 e^{ik_0 x} & \psi_0 &= e^{-x^2/2b^2} \\ \phi(x, 0) &= \psi_0^2 = e^{-x^2/b^2}\end{aligned}\quad (2.33)$$

And the system is therefore not, as implied by the mathematical formulations, free of forces, but will experience a force along the direction x :

$$F_x = -\frac{\partial \phi}{\partial x} = \frac{2x}{b^2} e^{-x^2/b^2}\quad (2.34)$$

The exact evaluation of this existing force and its effects for the propagating wave need not occupy us at this point: it suffices to prove that the initial assumption (free waves) cannot be sustained in view of intrinsic properties, and that the result of quantum theory, which served as a proof against Schrödinger's initial concept of physical waves, is physically invalid.

Along this line of reasoning we may reconsider the question of quantum ensembles from the viewpoint of intrinsic potentials and forces. The most general form of a wave function is given by its Fourier integral over all components:

$$\psi(\vec{r}) = \int d^3 k \psi_{0,\vec{k}}(\vec{r}, \vec{k}) e^{i\vec{k}\vec{r}}\quad (2.35)$$

The potentials due to the qualities of the amplitude are then responsible for intrinsic potentials additional to the constant potential of a plane wave. They are given by:

$$\phi_i(\vec{r}, \vec{k}) = u^2 \left| \psi_{0,\vec{k}}(\vec{r}, \vec{k}) \right|^2 = \frac{\hbar^2 k^2}{m^2} \left| \psi_{0,\vec{k}}(\vec{r}, \vec{k}) \right|^2\quad (2.36)$$

The forces within the propagating wave are either periodic – the total potential of the plane wave is constant –, or they are forces due to the properties of the amplitude. These forces will be:

$$\vec{F} = \frac{\hbar^2 k^2}{m^2} \left[\psi_{0,\vec{k}}^* \nabla \psi_{0,\vec{k}} + \psi_{0,\vec{k}} \nabla \psi_{0,\vec{k}}^* \right]\quad (2.37)$$

A stable state of the system can only be expected, if these forces vanish. The equilibrium condition for a system of particles described as plane waves is therefore:

$$\psi_{0,\vec{k}}^* \nabla \psi_{0,\vec{k}} + \psi_{0,\vec{k}} \nabla \psi_{0,\vec{k}}^* = 0\quad (2.38)$$

The two ensembles defined, the local ensemble as well as the general quantum ensemble, comply with this condition since in both cases the amplitudes $\psi_{0,\vec{k}}(\vec{k})$ do not depend on \vec{r} . The distribution used for the calculation of

the spreading wave packet clearly is not compatible with this condition.

However, given the condition of stability, the quantum ensemble seems unnecessarily restrictive: it is not excluded, that the amplitudes change with the wave vector \vec{k} , although the quantum ensemble does not allow for an interpretation in terms of inhomogeneous \vec{k} distributions. The restriction is not a physical result, meaning that it does not derive from physical processes, but a logical consequence of the fundamental arbitrariness of Schrödinger's equation (see the discussion).

III. A LOCAL SCHRÖDINGER EQUATION

As the conventional framework is non-local, it might be interesting to consider its local modification. A feasible method to regain locality is a different basic set of variables in field theory. If the concept of *particles* is given up altogether, and if the decisive variables of physical systems are the intrinsic values of density ρ , charge density σ , as well as the intrinsic fields of motion ϕ_k and electromagnetic complements ϕ_E , and their correlating vector fields \vec{p} , \vec{E} , and \vec{B} , the Planck and de Broglie relations can be formulated in a local way. We take the result on hydrogen atoms, where the atomic radius equals 3.3×10^{-10} m [20]. And we assume that the density of electron mass at the atomic radius shall be the density of a free electron. The volume V_{el} of a free electron shall therefore be:

$$V_{el}^0 = 2\pi R_0^3 \approx 2.26 \times 10^{-28} m^3$$

Therefore the Planck and de Broglie relations can be formulated as local statements, the frequency and wavelength of a free electron given by the relations:

$$\begin{aligned} \lambda(\vec{r}, t) \cdot u(\vec{r}, t) &= \frac{2\pi\beta_{el}}{\rho_{el}^0(\vec{r}, t)} \\ \rho_{el}^0(\vec{r}, t) \cdot \vec{u}^2(\vec{r}, t) &= \beta_{el} \omega(\vec{r}, t) \\ \beta_{el} &= \frac{\hbar}{V_{el}} \approx 4.67 \times 10^{-7} [kg/ms] \end{aligned} \quad (3.1)$$

In view of current results, the volume of an electron is far too high. But as recently established [3], the energy exchange in interactions not only applies to the electron as a whole, but to every single point within the electron. Scattering experiments are therefore no way to detect definite electron extensions.

Rewriting the Schrödinger equation for electrons in a strictly local manner, we get furthermore (density ρ_0 , frequency ω , and velocity \vec{u} equal to the functions defined in (3.1), indices and variables omitted for brevity):

$$\begin{aligned} \rho_0 \left(-\frac{\beta_{el}^2}{\rho_0^2} \Delta + \phi(\vec{r}, t) \right) \psi &= \beta_{el} \omega \psi \\ \psi(\vec{r}, t) &= \psi_0 \exp i \left(\frac{\rho_0 \vec{u}}{\beta_{el}} \vec{r} - \omega t \right) \end{aligned} \quad (3.2)$$

It can be seen, that the local version of Schrödinger's equation is no longer linear, the linearity of the relation, which corresponds to the principle of superposition only holds in the non-local case.

The general case of a local Schrödinger equation, in its time-free and time-dependent form can be written as the nonlinear system of the following equations:

$$\begin{aligned} A \quad & [-\beta_{el}^2 \Delta + \rho_0^2 \phi(\vec{r}, t)] \psi = \rho_0 \beta_{el} \omega \psi \\ B \quad & [-\beta_{el}^2 \Delta + \rho_0^2 \phi(\vec{r}, t)] \psi = i \rho_0 \beta_{el} \dot{\psi} \\ C \quad & \rho_0 = |\psi(\vec{r}, t)|^2 \end{aligned} \quad (3.3)$$

Or if we define the Hamiltonian density $\mathcal{H}(\vec{r}, t)$, the local system of equations for electron motion will be given by:

$$\begin{aligned} \mathcal{H}(\vec{r}, t) &:= \rho_0 \left(-\frac{\beta_{el}^2}{\rho_0^2} \Delta + \phi(\vec{r}, t) \right) \\ \mathcal{H} \psi &= \beta_{el} \omega \psi \\ \mathcal{H} \psi &= -\frac{\beta_{el}}{i} \frac{\partial \psi}{\partial t} \\ \rho &= \psi^* \psi \end{aligned} \quad (3.4)$$

In view of these results it can be concluded that non-locality is a feature inherent to the conventional formulation of quantum theory, it can be derived from its fundamental statements without any experimental consideration. The local formulation of these statements yields non-linear differential equations, a local theory therefore will not comply with the principle of superposition.

If we calculate the effect of superimposing two single solutions of the local Schrödinger equation, we may proceed from the two plane waves at \vec{r}, t :

$$\begin{aligned} \psi_1 &= \psi_0^1 \exp i \left(\frac{\rho_0^1 \vec{u}_1}{\beta_{el}} \vec{r} - \omega_1 t \right) \quad |\psi_0^1|^2 (u_1^2 + \phi) = \beta_{el} \omega_1 \\ \psi_2 &= \psi_0^2 \exp i \left(\frac{\rho_0^2 \vec{u}}{\beta_{el}} \vec{r} - \omega_2 t \right) \quad |\psi_0^2|^2 (u_2^2 + \phi) = \beta_{el} \omega_2 \end{aligned}$$

A superposition of the two solutions leads to a relation containing additional interference-terms of the two original waves:

$$\psi_s := \psi_1 + \psi_2 \quad (3.5)$$

$$\begin{aligned} \mathcal{H} \psi_s &= \beta_{el} \frac{|\psi_0^1|^2 \omega_1 + |\psi_0^2|^2 \omega_2}{|\psi_1 + \psi_2|^2} + \\ &+ \phi \frac{|\psi_1 + \psi_2|^4 - |\psi_0^1|^4 - |\psi_0^2|^4}{|\psi_1 + \psi_2|^2} \neq \beta_{el} (\omega_1 + \omega_2) \end{aligned}$$

The fundamental relations are therefore essentially non-linear and depend on the interference of the two original waves. The difference between the non-local and the local formulation of the equation, furthermore, implies the intensity of the potential in interactions of electrons. If the amplitudes of the original waves ψ_1 and

ψ_2 are unity, then a superposition of the two waves to ψ_s means, that the potential, and therefore the photons of emission, must be:

$$\begin{aligned}\phi &:= \phi_1 + \phi_2 = \omega_1 \cdot \Gamma(\vec{r}, t) + \omega_2 \Gamma(\vec{r}, t) \\ \Gamma(\vec{r}, t) &\equiv \beta_{el} \cdot \frac{1 + 2 \cos \Delta\varphi}{4(1 + \cos \Delta\varphi)^2 - 2} \\ \Delta\varphi &= \frac{\vec{u}_1 - \vec{u}_2}{\beta_{el}} \vec{r} - (\omega_1 - \omega_2)t\end{aligned}\quad (3.6)$$

The effect must be considered a result of the mechanical formulation, which does not allow for any simple evaluation of particle interactions. The wave equation is not affected in the same way: it remains a linear differential equation of second order still allowing for the superposition of single solutions, as can easily be established:

$$\begin{aligned}\left(\Delta - \frac{1}{u^2} \frac{\partial^2}{\partial t^2}\right) \psi &= 0 \\ \psi &= \psi_0 \exp i \left(\frac{\rho_0 \vec{u}}{\beta} \vec{r} - \omega t \right)\end{aligned}\quad (3.7)$$

And the dispersion relation for the monochromatic wave yields the local form of Planck's relation or the relation between the total energy density and frequency of the plane wave.

$$\beta = \frac{\rho_0 \vec{u}^2}{\omega} \quad \vec{k} = \frac{\rho_0 \vec{u}}{\beta} \quad (3.8)$$

Since electromagnetic formulations are derived from the wave equation, the theory of classical electrodynamics is equally not affected.

IV. COLLAPSE OF THE WAVE FUNCTION

In his rather fundamental and comprehensive analysis of measurement processes in quantum theory Ballentine [14,21] proceeded from two mutually exclusive statements on the quality of the state concept, i.e. that (1) *a pure state provides a complete and exhaustive description of an individual system*, and (2) *a pure (or mixed) state describes the statistical properties of an ensemble of similarly prepared systems*. The subsequent analysis of measurement processes proved that [21] *any interpretation of the type (1) ... is untenable*. Ballentine remarks, furthermore, that the *collapse of the wave function* is a necessary consequence of an interpretation type (1) and, since this interpretation of the wave function is disproved, the theory gives no evidence of this collapse to occur.

The process is conventionally described as follows: a particle with its wave function $\psi(q)$, where q denotes some generalized coordinates is thought to interact with a measurement apparatus described by the wave function $\phi(\xi)$, where ξ equally describes the generalized coordinates of the measurement system. After the interaction

the combined wave function of the measurement apparatus and the particle is described by $\psi_n(q) \phi_n(\xi)$, where n is a single eigenstate and pointer position. In von Neumann's view (see Ref. [38]) the process must occur in two steps: (1) the interaction of particle and measurement device leads to a superposition of states described by:

$$\Psi = \sum_n \psi_n(q) \phi_n(\xi)$$

(2) The observation of the measurement leads to the collapse of the wave function to its actually measured state given by:

$$\Psi = \psi_n(q) \phi_n(\xi)$$

The formalization is not changed if instead of discrete pointer positions a range of continuous measurement values is considered. One just has to substitute the index n by a continuous index ν describing the range of measurements. The basic problem is that this process cannot be described within the framework of quantum theory, which leads, in the more orthodox interpretations, to the negation of every process which is not an actual measurement result (Heisenberg's view in Ref [22]), or even to metaphysical interpretations of the effects of consciousness (which seemed to be Bohr's view, stating that the process of observation is essentially *non-causal* and *irreversible*). In more ingenious interpretations the result has been used as the basis of a *many world interpretation* (Everett [23]), where every outcome of a measurement occurs in a different universe. For a complete survey as well as a critical analysis of the many world interpretations see Adrian Kent's original paper [24], or his recent update in the eprint archive [25]. Recently theoretical models focus on the concept of *quantum-entanglement*. Clearly, the problem is still rather disputed.

If the state vector of a system, or the wave function in quantum theory were an exhaustive information about the system, the logical problems seem indeed severe if not unsurmountable. The situation changes, though, if one concedes that the quantum mechanical description of systems is essentially arbitrary and does not provide a full account of physical variables, as demonstrated in the previous paper [3]. The results obtained do not exclude a collapse of the wave function during a measurement process leading to a *coherent superposition* of different measurement values (or, in Ballentine's words "pointer positions"), although the specific wave function is not a complete and exhaustive description of a quantum system: this is, incidentally, the result obtained in the previous section. From a physical point of view, it remains to clarify, how the measurement affects the quantum ensemble, and if the total number of ensemble members is reduced in this process.

A simple example of the reduction of the wave function in a measurement process is a retarding field analyzer frequently employed in LEED (low energy electron

diffraction) measurements. The reason that we do not use the commonly used spin-measurements is the oscillating feature of particle-spins when defined according to the definition in quantum theory [3].

A retarding field analyzer is basically a positive potential, assumed rectangular for simplicity, which selects only electrons above a certain energy threshold. We equally assume, that the electrons initially are free, their energy shall be given by a value E_k (see Fig. 3).

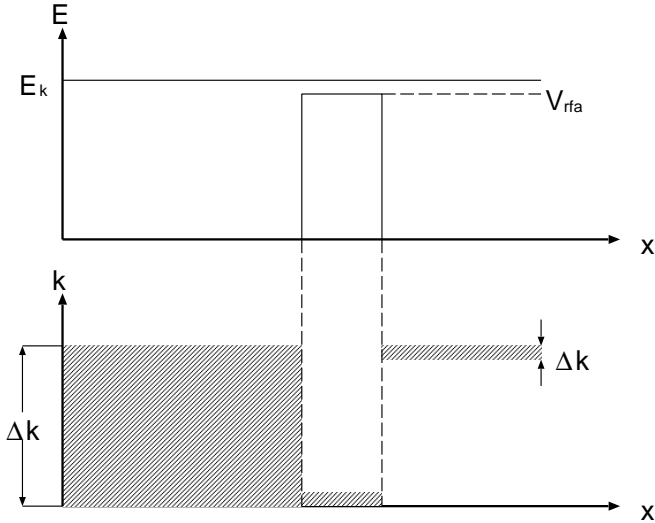

FIG. 3. Reduction of the wave function due to retarding field analyzer. The positive potential V_{rfa} is lower than the total energy of the ensemble limit E_k (top), the selection of members of the ensemble leads to a reduction of the statistical ensemble after the measurement (bottom)

From a strictly causal point of view, the electrons below an exactly defined threshold value $E_{rfa} < E_k$ cannot pass the filter and the number of electrons after the filter is therefore reduced to single particles with an energy above the threshold value. Naively one could assume, that the wave function after the barrier must be the same as before the barrier, since all the electrons had sufficient energy. This assumption is only correct, though, if intrinsic potentials remain unconsidered.

As the calculation in quantum theory accounts for the arbitrariness by integrating over all possible particle states at a given location \vec{r} , and since the range of allowed k -values depends on the level of kinetic energy, the total of density $\rho(\vec{r})$ at an arbitrary location before the analyzer will be:

$$\rho(\vec{r}) = \psi^*(\vec{r})\psi(\vec{r}) = \int_0^{k_0} d^3k \phi^*(\vec{k}, \vec{r})\phi(\vec{k}, \vec{r})$$

$$k_0^2 = \frac{2m}{\hbar^2} E_k \quad (4.1)$$

while after the analyzer the wave function will be limited to states with energy values higher than the threshold:

$$\rho'(\vec{r}) = \psi'^*(\vec{r})\psi'(\vec{r}) = \int_{k_1}^{k_0} d^3k \phi^*(\vec{k}, \vec{r})\phi(\vec{k}, \vec{r})$$

$$k_1^2 = \frac{2m}{\hbar^2} (E_k - E_{rfa}) \quad (4.2)$$

Clearly the wave function, or the quantum ensemble, have been reduced. The interesting question now seems to be whether this collapse is a causal process, a statistical one, or a process only found in quantum mechanical systems.

Let's say we want to make sure, that only particles of a specific energy will be part of the measurement process. Thus some sort of preselection has to be established, which guarantees that the total potential of the particles meets the required conditions. This sort of preselection requires, though, that the particles are initially *prepared*, the same way the retarding field analyzer makes sure, that only particles above the threshold will pass. If the particles are prepared, then the reduction will occur at the preparation process, exactly in the same way as above. Then all the particles prepared will pass the analyzer and no further reduction is required. If particles are not prepared, then the result is the previous one, although this result is a consequence of a lack of knowledge about individual particles. It is therefore, like in statistical kinetics, a result of statistical distributions of intrinsic potentials at every arbitrary point \vec{r} of the system, formalized in quantum theory by way of the fundamental arbitrariness.

The measurement of particle energies by retarding fields is therefore a causal and deterministic process on a statistical ensemble. The same applies to the reduction of the wave function. A special quantum process, apart from the intrinsic features of single particles, is therefore not required.

In an ideal limit, where the field analyzer selects only particles of a defined energy E_k , the quantum ensemble after the measurement is reduced to the local ensemble. In this case the wave function describes an ensemble of exactly defined energies and infinite extensions: this ensemble has the structure of infinite electromagnetic fields, it is therefore equal to the classical limit of quantum theory. The same could basically be achieved by a monochromator, and, as will be seen further down, particle properties in this case only prevail as limited regions of space of individual particle waves. That this limitation is not described by classical formulations, is equally understandable, since the classical limit is based on an infinite local ensemble.

V. DIFFRACTION EXPERIMENTS

A. Double-slit experiments

Diffraction experiments have long been difficult to analyze since the exact interplay between causal reasons and

statistical considerations remained something of a puzzle to logical reasoning. Especially the existence of interference terms in the notorious double-slit experiments has been hard to explain (see for example Bohm's analysis of the double slit experiment in [9], or recent experiments on complementarity and quantum erasers [26]). The main problem, from the viewpoint of logical reasoning, is the fact that the path of a single particle through one aperture (an electron for example) should be determined by the second aperture, since it is evident, from the results of measurements, that the interference pattern changes with the state of the second aperture. There remained basically only two solutions to the problem: (1) the Copenhagen interpretation [5] stating that an individual particle is only to be seen as a statistical ensemble of particles, the statistical quality is therefore inherent to the trajectory of any single one (which is essentially the complementarity argument), or (2) Bohm's interpretation that the trajectory of a single particle is exactly determined by the Schrödinger equation, and that the statistical qualities derive from hidden variables [9].

From the viewpoint of intrinsic particle properties and the interpretation of Schrödinger's equation as an equation of motion for statistical manifolds of particles, both solutions are partly correct, although neither of them provides a full account of the problem.

The Copenhagen interpretation is correct, as far as the quantum ensemble of the measurement is concerned. That the non-local formulation of quantum theory is theoretically incapable of describing the field type interactions of a *single* particle wave in the potentials of the slit environment, cannot be used – as the dogmatic version of the interpretation holds – to assume any metaphysical connection between the observed particle and the observing experimenter. It is, in the present context, the result of the local quantum ensemble, which yields the characteristic interference patterns. As every single particle wave only covers a small local range of the whole ensemble, the *individual* measurement result exhibits point like features. And since this specific ensemble is equivalent to the classical limit, a classical theory of diffraction will provide a suitable model to describe the experimental result.

The question of self interference of a particle with a volume similar to the volume of an electron derived in section III thus indicates the point, where the particle interpretation breaks down: all the intrinsic relations remain valid, if an electron beam is thought to be split in two components (which in fact is the only possible interpretation concerning neutron interferences treated further down), the same holds for every single point in interactions. That the measurement after the double-slit system then is registering a limited region of space for the trajectory, is only a consequence of the limited volume of space covered by the wave structure of a "single" electron. In this case as well as in the case of neutron interferences the problem to a consistent physical interpretation of events (a causal chain at that), is the parti-

cle picture of quantum theory deriving from the basically mechanical outlook and the subsequent normalization.

Self interaction of single particles is therefore an unsuitable term: the internal structure of the particle interacts with the slit environment (this is the causal and local level, which is *not* described by quantum theory, but classical field theories). And as the ensemble of particles in this measurement covers the whole local range, all results of the classical limit will eventually be covered (this is the statistical level, described by the ensemble wave function as well as the classical variable of intensity). The interface between the causal level and the statistical one in this case is the local range of intrinsic structures covering, eventually, the whole system.

Bohm's result is not quite consistent with the qualities of the Schrödinger equation: as the Schrödinger equation is not a causal – i.e. physical – description of single particles (due to non-locality in the normalization and arbitrariness because of omitted intrinsic potentials), it can only describe the behavior of ensembles, while the proposed deterministic quantum potential [6] implies physical origins for the change of the wave function during measurement. This interpretation, in our view, combines two aspects of the problem which have nothing in common: the wave function is not a *physically* valid description of any single particle, therefore the change of the wave function has a physical (field interactions) as well as a statistical (over the whole local range of the system) aspect. Reducing the physical aspect to the statistical one (which is, essentially, the content of the Copenhagen interpretation), or reducing the statistical aspect to physical ones (which is the content of Bohm's theory) is equally unjustified: the whole picture is only emerging, if both aspects are included simultaneously.

To display the essential features of these experiments, it suffices to describe diffractions by a modification of classical electrodynamics. The theoretical account sheds some light on the seeming paradox of single particles and individual measurements, which are, in the limit of infinite repetitions, equal to classical interference patterns [27]. Let the wave function of a particle (photon or electron) in the vacuum be described by the Helmholtz equation:

$$(\Delta + k^2) \psi(\vec{r}) = 0 \quad (5.1)$$

With Green's theorem and using a vacuum Green's function we may rewrite the conditions for $\psi(\vec{r})$ to:

$$\begin{aligned} \psi(\vec{r}) = & \oint_{R(V)} d^2 \vec{f}' \frac{e^{ik|\vec{r}-\vec{r}'|}}{4\pi|\vec{r}-\vec{r}'|} \times \\ & \times \left[\nabla' \psi(\vec{r}') + \frac{2\pi i \psi(\vec{r}')}{\lambda} \frac{\vec{r}-\vec{r}'}{|\vec{r}-\vec{r}'|} \left(1 + \frac{i}{k|\vec{r}-\vec{r}'|} \right) \right] \end{aligned} \quad (5.2)$$

The surface $R(V)$ denotes the boundary of the volume of integration. To account for particle separation we describe the wavefunction of the ensemble as an integral over all measurements:

$$\psi(\vec{r}) = \int_{-\infty}^{+\infty} dt \psi_t(\vec{r}, t)$$

The time dependency and the limited extensions of an individual particle are included with a δ function, the wave function at the aperture of the diffractometer is then:

$$\psi(\vec{r}') = \int_{-\infty}^{+\infty} dt \delta^3(\vec{r}' - \vec{c}_p t) \cdot e^{ik|\vec{R} - \vec{c}_p t|} \quad (5.3)$$

$-\vec{R}$ shall be the location of the particle source and c_p the velocity of the particle. If we neglect the derivatives of the δ function (which, after all, shall only denote the existence of single entities), the following relation is derived:

$$\psi_{t=0}(\vec{r}) = e^{ikR} \Gamma(k, \vec{r}) \quad (5.4)$$

$$\Gamma(k, \vec{r}) = \frac{i}{2\lambda} \oint_{R(V)} d^2 \vec{f}' \frac{\vec{r} - \vec{r}'}{|\vec{r} - \vec{r}'|^2} \left(1 + \frac{i}{k|\vec{r} - \vec{r}'|} \right) e^{ik|\vec{r} - \vec{r}'|}$$

With a Kirchoff approximation the calculation yields the familiar results of classical electrodynamics: the amplitude $\Gamma(k, \vec{r})$ depends on the geometrical setup of the diffractometer and particle wavelength. But due to the δ function, it yields these amplitudes for *individual* particles passing the device.

This, rather simple, example reveals much of the logical problems of quantum theory in interference measurements. If the concept of a particle is retained, then the wavefunction at the moment $t = 0$, the moment when it passes the slit, contains already the future measurement results in form of the amplitude $\Gamma(\vec{k}, \vec{r})$. But since the amplitude depends on the number of slits – which, for a single particle, cannot be a determinant of particle motion through a specific one – the experimental result (interference fringes depending on the experimental setup) cannot be described by a causal *and* local model. A causal theory therefore *must be* non-local (which applies to the de Broglie–Bohm approach). If the particle model is given up and replaced by a model of single wave-particles with dimensions comparable or larger than the slit geometry, the amplitude given by classical calculations results essentially from the requirements of continuity after the interaction (contained in the form of the Green's function), while interference is referred to a statistical effect due to varying local distributions. It seems to confirm the interpretation of classical electrodynamics as a theory, which gains its validity from two separate origins: the formalization of internal particle structures and the consideration of infinite local ensembles.

The total wavefunction of the system $\psi(\vec{r})$ and the wavefunction of single measurements $\psi_t(\vec{r})$ are numerically equal but for the delta function. While the total wavefunction, therefore, may be said to contain the infinite repetition of the measurement in the form of measurement *results*, the individual wavefunction contains

the same information in the form of measurement *probabilities*. The wavefunction in this case has a double significance: a statistical as well as a determinist one.

B. Neutron interference

As a further example we may consider the modern version of these measurements, the neutron interference experiments by Rauch and Zeilinger [28,29,30].

We postulate initially that neutrons are physical entities similar to electrons or photons, in that they possess wave like properties described by a wave function ψ of single particles, intrinsic potentials to account for periodic mass distributions, and they shall be subject to the fundamental Planck and de Broglie relations in non-local formulation. Since the theoretical framework so far has not been extended to nuclear fields and properties, the postulate is a generalization yet without an indisputable proof. Additionally, we take intrinsic magnetic fields into account by postulating, that neutron mass in motion possesses an intrinsic magnetic field of a specific orientation ϑ , which shall be perpendicular to the axis of particle motion \vec{u} .

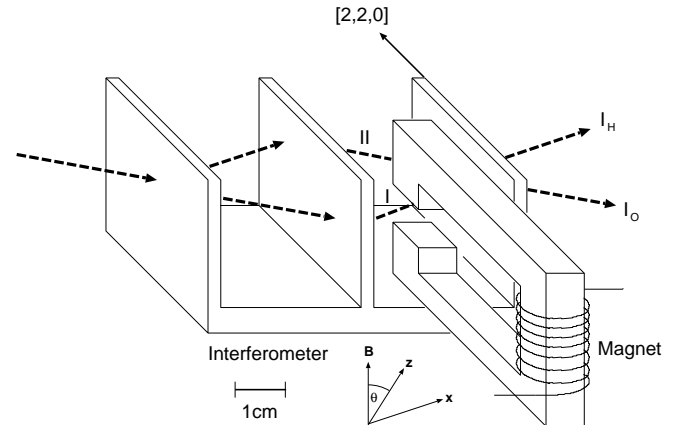

FIG. 4. Neutron interferometer for spin superposition measurement according to Rauch. The incident neutron beam is split coherently at the first plate and reflected at the middle plate. The two beam components *I* and *II* are coherently superposed at the third plate of the interferometer, a static magnetic field in the path of beam *I* leads to interference patterns depending on magnetic intensity

The most interesting results were obtained by a perfect crystal interferometer based on amplitude division, which yields a macroscopic (in the range of cm) beam separation. The intensity of the incident neutron beam was in every case such that only a single neutron passed the interferometer at a given moment. The separated beams could be manipulated by an insertion of attenuation and absorption devices, in single but highly significant experiments magnetic fields were employed to change the

spin-orientation [28]. According to Rauch all experimental results can be accounted for, if they are evaluated in the wave picture of quantum theory, while the particle picture can only be preserved by applying the concept of de Broglie's pilot waves (see Fig. 4).

From the viewpoint of material waves the result is not surprising: as the incident neutrons were initially passing a monochromator, the resulting quantum ensemble is the local one, which is, as established in section II, equal to the classical limit of quantum theory. It does seem, therefore, completely acceptable to treat the experiments within the framework of classical optics. And the theoretical calculations then are equal to the classical ones for x-ray interferences, where the amplitude of the wave function and electromagnetic intensity are related by (I_{qt} is the intensity due to quantum theory, I_{em} the intensity obtained in classical electrodynamics):

$$\begin{aligned} I_{qt} &\propto \psi^* \psi \propto |\vec{E}|^2 \propto I_{em} \\ \Rightarrow I_{qt} &\propto I_{em} \end{aligned} \quad (5.5)$$

There are, though, two results which require a closer scrutiny: the first is the proximity of experiments with single neutrons to the thought-experiments by Renninger [36] on single photons, the second is the change of wave properties by external magnetic fields.

As derived in the section on photons of the previous paper [3] the mass of a photon cannot be confined to an infinitesimal volume within the electromagnetic field, if Maxwell's relations are correct descriptions of the intrinsic electromagnetic fields. The kinetic properties of photons thus had to apply to every single point of the electromagnetic field, and the total energy density within the photon therefore was an intrinsic constant. The experimental and theoretical basis of this result was the deterministic relation between the electromagnetic fields of a photon and the experimental result. If the experimental results of neutron interferences are, therefore, described by the deterministic theory of classical electrodynamics, the same must apply to the relation between kinetic and electromagnetic properties of neutrons. And the kinetic properties of a neutron shall then prevail throughout the region of its complementary intrinsic fields: the initial assumptions about neutrons are then backed by the experimental results of interference measurements in conjunction with their theoretical description. This result suggests a wide range of speculative questions about the *physical* nature of neutrons, which cannot, at present, be treated, since the qualities of nuclear fields and interactions have not yet been included into the framework of material wave theory.

C. Magnetic interactions of particles

Quantum theory bases the interaction of magnetic fields and particles on the intrinsic qualities of spin and

magnetic momenta. Spin is a non-local property, in previous calculations it was found, that the concept is theoretically questionable [3]. The following calculation is a *local* and *deterministic* deduction of magnetic interactions, based on intrinsic electromagnetic fields and the field equations of electromagnetic properties as well as intrinsic potentials:

$$\begin{aligned} \frac{1}{u^2} \frac{\partial \vec{E}}{\partial t} &= \nabla \times \vec{B} & - \frac{\partial \vec{B}}{\partial t} &= \nabla \times \vec{E} \\ \phi_{em} &= \frac{1}{2} \left(\frac{1}{u^2} \vec{E}^2 + \vec{B}^2 \right) \end{aligned} \quad (5.6)$$

We consider the change of intrinsic fields due to a constant external magnetic field \vec{B}_{ext} , the field vectors shall be given by:

$$\begin{aligned} \vec{B} &= (0, 0, B_0) \cos(k_0 x - \omega_0 t) \\ \vec{E} &= (0, E_0, 0) \cos(k_0 x - \omega_0 t) \\ \vec{B}_{ext} &= (0, -\sin \vartheta, \cos \vartheta) B_{ext} \end{aligned} \quad (5.7)$$

Accounting for the dynamic qualities of the process by linear increase of the magnetic field $t \in [0, \tau]$, the internal fields will be at τ :

$$\begin{aligned} E'_y &= E_0 \cos(k_0 x - \omega_0 t) - B_{ext} \frac{\cos \vartheta}{\tau} x \\ E'_z &= -B_{ext} \frac{\sin \vartheta}{\tau} x \\ B'_y &= -B_{ext} \sin \vartheta \\ B'_z &= B_0 \cos(k_0 x - \omega_0 t) + B_{ext} \cos \vartheta \end{aligned} \quad (5.8)$$

Additional informations about the system can be inferred from the relation between the variables x and t as well as from the relation between amplitudes from Eq. 5.6:

$$\frac{x}{\tau} = u_0 \quad E_0 = u_0 B_0 \quad (5.9)$$

The electromagnetic potential due to interaction with the magnetic field is then given by:

$$\begin{aligned} 2\phi_{em} &= [B_0 \cos(k_0 x - \omega_0 t) - B_{ext} \cos \vartheta]^2 + [B_{ext} \sin \vartheta]^2 + \\ &+ [B_0 \cos(k_0 x - \omega_0 t) + B_{ext} \cos \vartheta]^2 + [B_{ext} \sin \vartheta]^2 \\ \phi_{em} &= B_0^2 \cos^2(k_0 x - \omega_0 t) + B_{ext}^2 \end{aligned} \quad (5.10)$$

The result is interesting due to two features: (1) The potential of interaction does not depend on the angle ϑ of the magnetic field: it can therefore not be formalized as the scalar product of an intrinsic magnetic moment $\vec{\mu}$ and an external field \vec{B}_{ext} , or only, if the magnetic moment is a non-local variable: the non-local definition of particle spin in quantum theory can therefore be seen as a different expression of an equivalent result. And the motivation for this definition has to be seen in the missing

account of deterministic and dynamic developments of the intrinsic variables.

The result confirms a conclusion already drawn by analyzing electron photon interactions: the framework of quantum theory is essentially limited to interactions, its logical implications only become obvious, if interaction processes are considered. In the context of particle spin it explains, why spin in quantum theory *cannot* be a local property: *because* interactions do not depend on the direction of field polarization.

(2) The electromagnetic potential of the particle is higher than the original potential. This result leaves two possibilities: either total energy density of the particle remains constant – which should be the case for neutral particles, which do not alter their energy due to magnetic interactions –, or the kinetic energy density of the particle is equally altered by interactions: which should apply for charged particles. In both cases the kinetic potential during magnetic interaction is changed, the alteration can be described by:

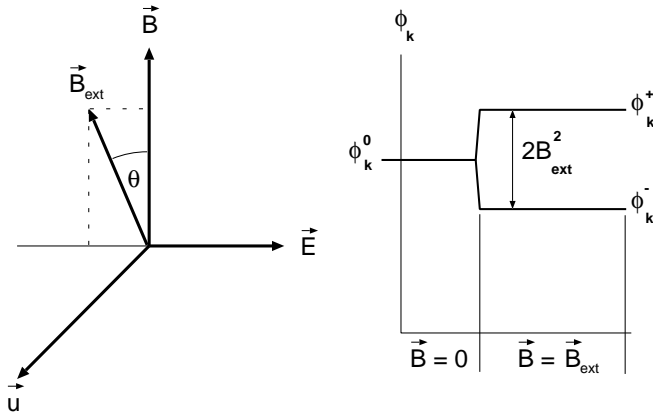

FIG. 5. Intrinsic electromagnetic fields and applied magnetostatic field of the neutron beam (left). Shift of kinetic potential due to interactions (right)

$$\phi'_k = \phi_k^0 \pm B_{ext}^2 \quad (5.11)$$

Fig. 5 displays the intrinsic electromagnetic fields and the energy terms due to magnetic interactions. Due to the relations between kinetic potential and density of mass $\phi_k = \rho u^2$ and the relation between the wave function and density of mass $\rho \propto \psi^2$ the properties of the wave function in the region of interaction will equally be changed, which means, that posterior superposition of the two separated beam parts will yield a changed interference pattern. The easiest way to calculate the changes in the affected beam is by estimating the difference of velocity. Since:

$$\langle \phi'_k - \phi_k^0 \rangle =: \Delta\phi_k = -\bar{\rho}(\Delta u)^2 = -B_{ext}^2 \quad (5.12)$$

$\bar{\rho}$ denotes average density of the beam, as the wave length is much shorter than the macroscopic region of the magnetic field in the interaction process, averaging

is physically justified. Then the phase difference α of the beam after $t_1 = l/u_0$ seconds, where l is the linear dimension of the magnet, will be:

$$\alpha = 2\pi \frac{\Delta u \cdot t_1}{\lambda} = 2\pi \left(\frac{l}{\lambda} \cdot \frac{B_{ext}}{\sqrt{\bar{\rho} u_0^2}} - n \right) \quad (5.13)$$

$n \in \mathbb{N}$

The theoretical result is consistent with the experimental result by Rauch, that the phase of the beam is linear with the intensity of the magnetic field applied [28]. Fig 6 displays the phase shift of the beam component I in a magnetic field.

That this phase shift is sufficient for an experimental proof of the 4π -symmetry of spinors seems to be a matter of convention, since it depends, essentially, on the scaling of the magnetic fields in terms of kinetic potentials. All that can be inferred from measurements is that magnetic fields affect the phase of the neutron beam, and equally, that this effect does not depend on the orientation of the magnetic field or the incident beam: both results can in a local and deterministic manner be accounted for by this deduction of magnetic interactions.

It should be noted, that the theoretical concept is only applicable to the local ensemble or the classical limit of quantum theory (As a consequence of monochromatic neutron beams). If the ensemble considered contains particles of arbitrary energies then an equivalent theoretical framework additionally has to account for the phase shifts of specific members of the ensemble: a close to classical interference pattern in this case cannot be expected.

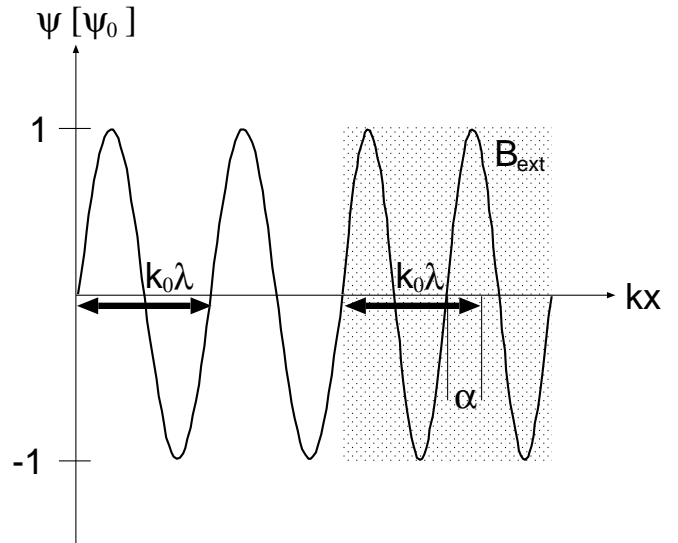

FIG. 6. Phase shift α in a magnetic field. The phase shift of the beam component I depends on the scale of the external magnetic field B_{ext}

D. The quantum eraser

That the intrinsic properties and, especially, the polarization of the intrinsic fields is decisive for interference measurements can be demonstrated by an analysis of *quantum eraser* phenomena. In this case the which-path information of the photon is said to preclude interference. Conventionally, the measurement is formalized as follows [31]:

The amplitude of an incident photon of horizontal polarization is split coherently in two separate beams, described by the quantum state vector (1 denotes the first, 2 the second of the two paths)

$$\psi_{12}^0 = \frac{1}{\sqrt{2}} (\psi_{1,H} + \psi_{2,H}) \quad (5.14)$$

The square of ψ , or the probability density in this case contains an interference term $\psi_{1,H}^* \psi_{2,H}$:

$$|\psi_{12}^0|^2 = \frac{1}{2} (|\psi_{1,H}|^2 + |\psi_{2,H}|^2 + \psi_{1,H}^* \psi_{2,H} + \psi_{2,H}^* \psi_{1,H})$$

If a polarization rotator changing the polarization of the beam to vertical (V) orientation is placed in path 1, the interference pattern is no longer observable, and the measurement yields random results for the local probability density on the measurement screen. In quantum theory the result is referred to the orthogonality of the two states H , and V , and the state vector of the photon described by

$$\begin{aligned} \psi_{12}^1 &= \frac{1}{\sqrt{2}} (\psi_{1,V} + \psi_{2,H}) \quad (5.15) \\ |\psi_{12}^1|^2 &= \frac{1}{2} (|\psi_1|^2 + |\psi_2|^2) \end{aligned}$$

The result can be changed by inserting a diagonal polarizer into the path of the recombined beams, in this case the wave function and probability density will again show interference effects: the which-path information, connected to the polarization of the two separate beams is said to have been "erased".

$$\begin{aligned} \psi_{12}^2 &= \frac{1}{2\sqrt{2}} (\psi_1 + \psi_2) (\psi_V + \psi_H) \quad (5.16) \\ |\psi_{12}^2|^2 &= \frac{1}{4} (|\psi_1|^2 + |\psi_2|^2 + 2\text{Re}[\psi_1^* \psi_2]) \end{aligned}$$

The result can be understood in the context of intrinsic properties and polarizations of intrinsic fields, since the intensity of electromagnetic radiation is described by the electromagnetic potential ϕ_{em} (for a general description the field vectors are assumed complex):

$$\phi_{em} = \frac{1}{2} \left(\frac{1}{c^2} |\vec{E}|^2 + |\vec{B}|^2 \right) \quad (5.17)$$

If the beam of horizontal polarization (direction x) is split into two separate beams, the electric and magnetic fields after recombination will be:

$$\begin{aligned} \vec{E}_{12}^0 &= \frac{1}{\sqrt{2}} (E_1 \vec{e}_x + E_2 \vec{e}_x) \\ \vec{B}_{12}^0 &= \frac{1}{\sqrt{2}} (B_1 \vec{e}_y + B_2 \vec{e}_y) \end{aligned} \quad (5.18)$$

where the fields E_2, B_2 contain the phase information $e^{i\varphi}$. The intensity measured after recombination will consequently contain interference terms:

$$\phi_{em}^0 = \frac{1}{2} \left(\frac{1}{c^2} |E_1|^2 + |B_1|^2 \right) (1 + \cos\varphi) \quad (5.19)$$

A polarization rotator in path 1 changes the polarization of the electric and magnetic fields to \vec{e}_y and $-\vec{e}_x$ respectively, and the intensity after recombination is then not affected by the phase φ :

$$\begin{aligned} \vec{E}_{12}^1 &= \frac{1}{\sqrt{2}} (E_1 \vec{e}_y + E_2 \vec{e}_x) \\ \vec{B}_{12}^1 &= \frac{1}{\sqrt{2}} (-B_1 \vec{e}_x + B_2 \vec{e}_y) \end{aligned} \quad (5.20)$$

$$\phi_{em}^1 = \left(\frac{1}{c^2} |E_1|^2 + |B_1|^2 \right) \quad (5.21)$$

If the recombined beam is passing through a diagonal polarizer (plane of polarization in xy -direction), the electromagnetic fields after polarization are:

$$\begin{aligned} \vec{E}_{12}^2 &= \frac{1}{2} (E_1 \vec{e}_{xy} + E_2 \vec{e}_{xy}) \\ \vec{B}_{12}^2 &= \frac{1}{2} (-B_1 \vec{e}_{yx} + B_2 \vec{e}_{yx}) \end{aligned} \quad (5.22)$$

And the intensity of the beam shows again the interference pattern of the phase φ :

$$\phi_{em}^2 = \frac{1}{4} \left(\frac{1}{c^2} |E_1|^2 + |B_1|^2 \right) (1 + \cos\varphi) \quad (5.23)$$

Mathematically, the description by way of intrinsic potentials and polarizations yields the same result as the conventional calculation in quantum theory. However, the interesting aspect of the effect is its interpretation. While in the conventional framework the which-path information (and its relation to the conception of *complementarity*) is seen as the ultimate reason for the experimental results, it is, in the new theory, the intrinsic information due to the electromagnetic fields and their vector features, which are held responsible.

In more general terms it is the concept of the wave function and its dogmatic interpretation, which *creates* the logical problems of interpretation contained in the conventional approach: since the wave function contains, a priori, all the information about the particle, and since it is a scalar function, it does not contain a vector variable. But in this case the transformation of its features due to a change of intrinsic directional information must

be explained by some auxiliary conception, in case of quantum erasers by the conception of complementarity, in case of magnetic fields by the non-local conception of spin. The whole formalism, in this way, gains a highly artificial and abstract quality, which makes it increasingly difficult to render a straightforward account of physical processes. What this analysis amounts to, is not so much a theoretical or logical flaw of the current concept, but rather a defect in terms theoretical simplicity.

VI. THE QUANTUM ZENO EFFECT

The quantum Zeno effect, or the unusual feature of unstable quantum systems that measurements slow down the decay of unstable particles, has been introduced by Misra and Sudarshan [32] and further analyzed by Peres [33]. Its experimental implications have recently been tested by Kwiat et al., and the theoretical feature has been exploited to realize interaction free measurements with an efficiency exceeding 50 % [34,35].

The proof of this feature depends on the development of an initial state ϕ , it shall belong to the domain of the operator H , which does not explicitly depend on time. In second order approximation the probability of the state to survive will be, for small time intervals t ($\hbar = 1$):

$$|\langle \phi, e^{-iHt} \phi \rangle|^2 \approx 1 - (\Delta H)^2 t^2 + \dots \quad (6.1)$$

where t is assumed sufficiently small, and the finite term ΔH shall be described by:

$$(\Delta H)^2 = (H\psi, H\psi) - (\psi, H\psi)^2 \quad (6.2)$$

The decisive step now is to perform a measurement of the system state n times in the given interval, in this case the probability to find the system always in its initial state will be:

$$P_\phi = [1 - (\Delta H)^2 (t/n)^2]^n > 1 - (\Delta H)^2 t^2 \quad (6.3)$$

Clearly the probability has increased, and the logical reason for it is the repetition of measurements. In the infinite limit $n \rightarrow \infty$ the probability equals 1, which obviously signifies that an unstable system in constant observation does not decay.

In order to determine the physical content of the statement, we may first consider an experimental realization by way of polarization rotators [35]. Polarization rotators interspersed with polarizers can be used to establish, that the additional polarizers (equivalent to measurements of polarization) allow for transmission of photons, which are otherwise blocked out in the final polarization measurement.

Seen from the viewpoint of classical electrodynamics, the result is completely understandable, since the transmitted intensity depends on the angle of polarization. But from the viewpoint of quantum theory the result is

puzzling, because it indicates that the decay of unstable states "is not a property of the particle" [32]. The paradox has been clarified to some extent by A. Peres, who referred the effect to the features of the Schrödinger equation [33]. Expanding the time dependent wave function ψ in an orthonormal basis u_i and applying the time dependent Schrödinger equation, we get:

$$\begin{aligned} \psi &= \sum a_k(t) u_k e^{-iE_k t} \\ i\dot{a}_j &= \sum V_{jk} a_k e^{i(E_j - E_k)t} \end{aligned} \quad (6.4)$$

Selecting one eigenfunction of the orthonormal basis to represent $\phi = u_0$, it becomes clear that the change of the survival amplitude is due to the amplitudes of the decay products a_k (since $V_{jj} = 0$). Although the result is reasonably well explaining the effect within the limits of quantum theory, it is interesting to consider the same behavior from the viewpoint of quantum ensembles. Considering a local ensemble with exactly defined energy, the development describes the propagation of a particle wave with energy E :

$$\psi(t) = \phi(0) e^{-i\omega t} \quad (6.5)$$

And the probability P_ϕ after an arbitrary interval t is consequently equal to 1. The same applies for every component of a quantum ensemble in an external potential.

Now let us assume, that the ensemble is unstable, like the initial configuration used to calculate the spreading wave packet (section II G). And additionally, that this configuration was brought about by some kind of measurement process. Whether such a measurement process is possible, would require an extended discussion, for the quantum Zeno effect its existence may be taken for granted. Using the result of Peres Eq. 6.4, the change of this initial configuration depends on the existence of interactions between different components of the ensemble. As long as the measurement process is repeated fast enough to stall the development of interacting ensemble components, the initial configuration is conserved. The argument of Peres [33], that the interactions within an atomic nucleus are equivalent to a measurement process, does not seem justified in this case. As the stable system state is equal to a quantum ensemble of single particles, the unstable configuration requires some sort of energy exchange. And since an isolated system cannot provide this energy in infinite repetition, the argument then would lead to postulating some sort of perpetual mobile explicitly forbidden by the entropy principle.

The quantum Zeno effect thus derives its validity from several sources: (1) The existence of measurements leading to an unstable system state, and (2) the provision of additional energy to regain the initial state in infinite repetitions. From a physical point of view, the repetition contains an infinity problem which makes the effect theoretically viable but physically infeasible in isolated systems.

VII. INTERACTION-FREE MEASUREMENTS

The essential feature of an interaction-free measurement, which is based on a thought experiment by Renninger [36], is that it provides information about the existence of an object in a closed system without necessarily interacting with this object. The essentials of such a measurement, recently undertaken by Kwiat et al. [34,35], can be seen in Fig. 7.

Interaction free measurements, usually performed with down-converted photons, are interesting due to two features: the wave function of the system and consequently system energy is changed, even if no interaction occurs. And the results are seemingly incompatible with classical field theories because the trajectories of single particles through the measurement apparatus can be identified.

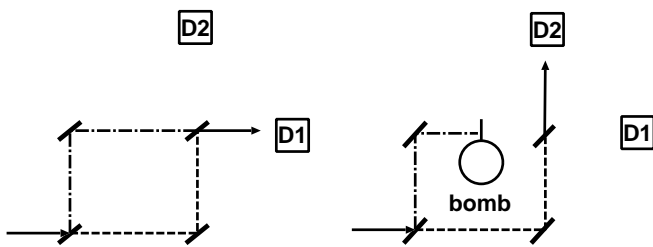

FIG. 7. Mach-Zehnder interferometer with or without a sensitive bomb-trigger in one path

The first feature was modeled by Dicke [37] using a modified Heisenberg microscope and calculating the state vectors of photons and a non-interacting atom in first order perturbation theory. The result of Dicke's calculation seemed to prove that even interaction free measurements correlate with an exchange of virtual photons or, in Dicke's words: *The apparent lack of interaction between the atom and the electromagnetic field is only illusory.*

On the statistical basis developed in this paper, the result must be modified. The local modification of ensemble ranges means, in this context, that an interaction free measurement corresponds to a different ensemble, i.e. an ensemble which has zero probability in the range, where an interacting particle is appreciable. It is therefore the limitation imposed, the change of boundary conditions, which is the ultimate reason for the change of the wave function. And if this local range affects system energy like in Dicke's model of an harmonic oscillator in a magnetic field [37], then the energy of the system changes. The changed result is therefore not of physical, but statistical origin. The logical difficulties of interpretation arise, once more, from the Copenhagen interpretation: if wave functions in quantum theory are interpreted as physical determinants of single particle properties, interaction free measurements must indeed be referred to physical origins. But once this interpretation is rejected, the whole problem changes its qualities: instead of a physical effect it becomes a change of statistical ensembles. And that

different ensembles do have different qualities is not all too surprising.

The second feature of interaction free measurements, the assertion by Kwiat et al. [35] that "complementarity is essential" to the experimental results achieved, requires a critical analysis. What the argument indicates, is the impossibility for a single photon in the interferometer to trigger the bomb *and* detector D2 (see Fig. 7). Given the experimental facts, the argumentation is not wholly convincing.

For their "proof of principle" experiment [35] a Michelson interferometer was employed with an insertable mirror in one light path (the bomb-in configuration). The interferometer was initially adjusted in such a way, that the detector counts on D_{ifm} were a minimum, and it was shown that with gradual reduction of beam-splitter reflectivity the "figure of merit" (the fraction of measurements allowing to conclude the presence of the bomb without triggering it) yields a 50 % probability (see Fig. 8).

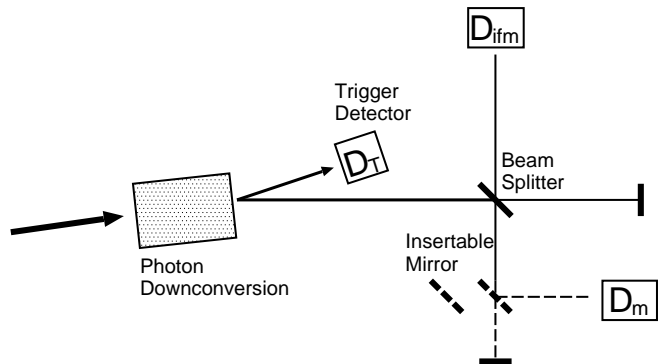

FIG. 8. Experiment to demonstrate the principle of interaction-free measurements according to Kwiat et al. [35]. The insertable mirror in one arm of the Michelson interferometer equals the bomb-in configuration, the reflectivity of the central mirror can be changed. Note that the detector counts of detector D_{ifm} and D_m are perfectly in accordance with classical intensities.

From the viewpoint of classical field theory the initial configuration requires destructive interference of the two wave components in the path of the detector. Thus the interferences, or the wave features, are decisive in this case. If, in the bomb-in configuration, one of the components is removed, interference is avoided and the intensity in the detector path is the intensity of the transmitted and reflected (TR) wave component. From the viewpoint of electromagnetic fields and potentials, the reaction of the detector then is critical. The same applies, basically, to the bomb detector. If detection efficiency were high enough to allow for the conclusion that every photon is detected at one of the two detectors, and if it could be established, that coincidences between the two *detectors* certainly do not exist, the argument of complementarity would be valid. But as detection efficiency

is only two percent, about 98 % of the incident energy (triggering a detector by one of the down-converted photons) is not accounted for. And in this case the argument of complementarity as well as the whole argumentation of interaction-free measurements seems questionable. What is missing in the experimental results of Kwiat et al. [34,35] is the proof, that triggering the detector D_{ifm} is invariably related to no energy passing the bomb detector. As long as this proof is not provided, the results can easily be accounted for by the model of photons already developed [3], and which allows for interactions of arbitrary fractions of a single photon.

VIII. HIDDEN VARIABLES

We lastly have to consider the proofs of quantum theory, that the theory cannot contain hidden variables. A lot of scientific research has been applied to that problem, since the standard proofs by von Neumann [38] and by Jauch and Piron [39] have not remained undisputed. Especially David Bohm [40] and John Bell [41] criticized the proofs as inadequate.

Bell's refutation of von Neumann's proof stresses, that *it was not the objective measurable predictions of quantum mechanics which ruled out hidden variables. It was the arbitrary assumption of the particular (and impossible) relation between the results of incompatible measurements either of which might be made on a given occasion but only one of which can in fact be made.* His objection against the proof by Jauch and Piron stresses the same point, i.e. that the basic assumptions contain very peculiar properties of systems which are unnecessarily restrictive. An additional analysis of Gleason's proof [42] shows, in Bell's view, that this proof is in fact a circular argument since the implicit assumptions of the proof are essential to its conclusion.

The arguments of Bohm against von Neumann's and Jauch's and Piron's proofs [9,40] are similar, although centered around the linearity requirement.

Since the theory of measurements developed in this paper depends explicitly on the existence of hidden variables (the intrinsic potentials), it seems necessary to reconsider the proofs against the very possibility of hidden variables from this angle. We shall begin the analysis with von Neumann's proof.

A. von Neumann

Von Neumann's proof centers around an analogy with classical statistical mechanics in his description of the hidden variables potentially contained in quantum theory. And he stresses that the impossibility of dispersion free states implies the impossibility of hidden variables in quantum theory. Dispersion free states meaning the conception, that a quantum system is composed of a number

of individual particles with precisely determined mechanical properties. Let us consider the mathematical procedure employed in quantum theory for an energy measurement. The expectation value of an operator H in a given state ψ of the system is:

$$\langle H \rangle = \int d^3 r |\psi(\vec{r})|^2 H(\vec{r}) \quad (8.1)$$

and in case of eigenstates of H the expectation value is equal to an precise kinetic energy E_k

$$\langle H \rangle = \int d^3 r |\psi_i(\vec{r})|^2 H(\vec{r}) = E_{k,i} \quad (8.2)$$

Since this expectation value can be derived from Schrödinger's equation, we may consider the statistical ensemble underneath the state vector $|\psi_i\rangle$. First of all, the statistical ensemble for a given energy value is a *homogeneous* ensemble, meaning that it cannot be broken down in sub-ensembles with different statistical properties. This structure of the hidden variables derives from their properties at every single point of a system. For a specific eigenvalue E_k it comprises all k -values within defined limits. And this structure of the statistical ensemble could only be split in components, if different regions of the system are considered. But then the expectation values refer to different subsystems and are no longer a linear combination. This requirement of linearity in the hidden variables, on which von Neumann's proof is based, has been disputed by Bohm [40] on the grounds, that the relation between the hidden variables and the expectation value for a given distribution need not be linear. We will consider his proposed theory of quantum measurements further down.

Secondly, due to the arbitrariness in the time-variable of the Schrödinger equation, it is not dispersion free, since it cannot be described as a statistical ensemble of precisely defined physical properties. It is therefore, in von Neumann's terminology, a *normal* ensemble. And as von Neumann only proved, that the existence of *non-normal* ensembles underneath the formulations of quantum theory must be excluded, it does not exclude the type of hidden variables found in material wave theory.

Bell based his refutation of von Neumann's proof on the spin properties of particles [41]. As already derived, the definition of spins in quantum theory does not allow for dispersion free spin states of individual particles, if spin variables are considered from the viewpoint of intrinsic variables. Therefore the assumptions, on which von Neumann's proof is based, do not apply also in this case.

B. Jauch and Piron

The argument of Jauch and Piron is slightly different in that it employs projection operators into different

states and subspaces. And they conclude that a dispersion free state defined by the intersection of two given states a and b cannot exist [39]. Bell's refutation [41] of the argument given is that it refers to logical reasons not necessarily applicable to the statistical ensembles of hidden variables. The argument concerning von Neumann's proof can be repeated here. Since the states of the intrinsic variables are not dispersion free, it cannot be the question of referring measurements in quantum theory to an ensemble of exactly determined particles. As soon as internal fluctuations due to the wave features of particles are considered, the proof is no longer applicable.

C. Bell's inequalities and spin measurements

Bell's inequalities provided an experimental way of checking on the existence of hidden variables. Basically, as already deduced, the measurements of spin-variables of photons would in all likelihood violate the uncertainty relations [3]. The result of such a measurement can only be (1) the possibility of hidden variables is rejected, or (2) the possibility of hidden variables is confirmed. But measurements are only valid under the condition that (3) the uncertainty relations have been violated. As the result in either case does not allow for a refutation of hidden variables within the framework of quantum theory, the result cannot contradict the theoretical background developed.

D. Bohm and Bub

It might be interesting to consider the proposed solution of the measurement problem in quantum theory given by Bohm and Bub [9]. It is based on their assessment of von Neumann's proof and the result, that a non-linear type of relation between hidden variables and expectation values is not explicitly excluded.

To allow for hidden variables, the authors develop a two-dimensional subspace of state vectors $|\psi\rangle$ and $\langle\xi|$, which comply with a nonlinear and equally nonlocal equation of motion. This equation of motion determines the development of the state vectors during measurement processes. The interesting consequence of the theory is, that the state vectors depend in a complicated way on the values of the vectors in every other part of space. Their theory allows to describe measurement processes in quantum theory due to a fundamental irreversibility of the dynamical formulations.

We consider the argument of irreversibility in comparison with the collapse of the wave function due to external potentials.

On the level of individual particles an applied potential, which shall be electrostatic, affects intrinsic variables and motion of the particle in a deterministic way. From

the viewpoint of individual particles, irreversibility cannot be confirmed, because electromagnetic interactions are essentially reversible. But considering the qualities of the ensembles before and after the measurement, the whole process is no longer reversible, since the full quantum ensemble cannot be obtained by an application of a positive potential to the collapsed one. The collapse of the wavefunction therefore indicates an irreversible measurement process in quantum theory. From the viewpoint of causality it can be understood as the selection of ensemble members with defined qualities.

The decisive change in the measurement occurs on the level of information. While the range of allowed k -values extended from $k = 0$ to $k = k_0$ before the measurement, the range is diminished after the measurement. Our information about the system clearly has increased. Relating information to thermodynamic entropy it could be said that a measurement process diminishes the entropy of the system. Carrying the analogy to entropy and information one step further, it could be said that the natural state of system should be the state of minimum knowledge, which is, in case of non-interacting particles of a defined total energy, the state where all the intrinsic potentials are equally possible.

While, therefore, the statistical and thermodynamic qualities do not enter in the interactions of single particles with a given measurement environment, they do enter on the level of our total knowledge about the system. A measurement in quantum theory is therefore objectively defined in terms of single particle interactions and applied external potentials. The measurement apparatus enters only in our evaluation of the experiment, on the level of general system entropy. Which means, that the problem of the interface between measured objects (particles) and measurement facilities in quantum measurements reveals an entropy principle inherent in the framework of quantum theory by way of intrinsic variables and wave functions of the system.

IX. CONCLUSION

We have shown in this paper that the arbitrariness of the fundamental formulations of quantum theory signifies, theoretically, that the theory is to be seen as a theory of statistical manifolds. The structure of these manifolds, called *quantum ensembles*, was developed for different physical environments and the results deduced. It was also clarified, where the logical borderline between the usually causal and deterministic picture of classical field theory and the probabilistic picture of quantum theory is situated, and it was established that classical electrodynamics gains its validity also by considering a specific ensemble of individual wave particles, the local ensemble. As an additional confirmation of the framework suggested, the spreading of the wave packet can be referred to the initial conditions commonly considered and which

are, from the viewpoint of intrinsic potentials, not equilibrium states. The results are generally not, as could have been expected by a formal approach, independent of the physical process considered. The classical limit of the statistical ensembles treated in quantum theory was defined, it was identified as the limit of infinite field extension.

The question of locality was analyzed in-depth, and the results are completely novel regarding the prevailing controversy of non-locality: non-locality must be assumed in every formulation of fundamental equations employing mechanical analogies. The result means, that the Schrödinger equation as well as the fundamental Planck and de Broglie relations are non-local statements. A strictly local formulation of the theory was suggested, the Schrödinger equation in this case is no longer a linear differential equation.

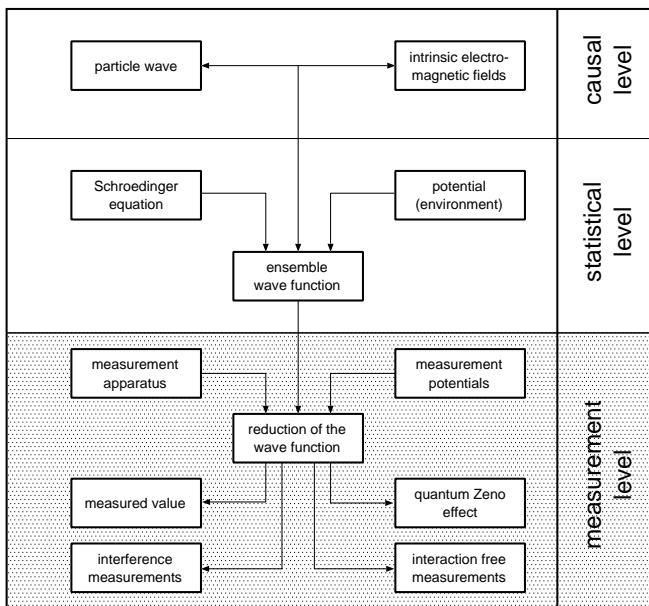

FIG. 9. Particles and measurements in quantum theory. The causal level refers to individual particles, they are statistically formalized in quantum theory as a manifold of allowed particle waves, in measurement processes the manifold is reduced due to the conditions of the measuring apparatus, which effects the collapse of the wave function

Fundamental measurement processes were treated in detail. The reduction of the wave function, which currently is a major issue in attempts of a causal reformulation of quantum theory, can be accounted for if the change of quantum ensembles in measurement processes is considered. Diffraction experiments as well as neutron interference measurements can be treated in the framework developed, the theory yields a *local* and *deterministic* theory of particle interactions in magnetic fields, which does not require the non-local concept of particle spin.

Regarding existing proofs against theories of "hidden

variables" it was shown that the statistical ensembles treated in quantum theory do not possess a structure which is explicitly excluded in the proofs by von Neumann and Jauch and Piron. Since these ensembles cannot be split in sub-ensembles of different physical qualities, they are, in von Neumann's terminology *normal ensembles*: and the proofs given focus specifically on the quality of non-normality. The experimental proof by Aspect et al. [43], based on Bell's inequalities, is equally unsuitable to disprove the statistical sublayer of quantum theory established, since the experimental result can only be obtained, if the uncertainty relations are violated, as already deduced [3]. A valid violation of Bell's inequalities with regard to hidden variables is therefore equal to a violation of fundamental principles of quantum theory.

Generally it can be concluded, that the interface between the field theory of particles, developed in previous papers [3], and the actual measurement process in experimental practice can, without any logical inconsistency, be achieved by the suggested statistical framework of particle waves, particle ensembles, and the change of ensemble properties due to physical environments. Fig. 9 displays the logical and hierarchical structure of particle waves, particle ensembles, and measurement processes.

X. DISCUSSION

What is, therefore, it might be asked, the fundamental difference between classical theories and quantum theory? In one or another form this question has, since the early Twenties, raised a considerable amount of controversy and ingenious argumentation. A part of the problem results from an imprecise definition of the regions, where the different theoretical frameworks apply. And the usually quoted criterion ($\hbar \rightarrow 0$) for the classical limit is not all too convincing, since the derivation of the classical Hamilton-Jacobi equation from Schrödinger's equation is by no means unambiguous (for a detailed account, see Holland [17], chapter 6). From a formal point of view, the difference could be interpreted as a result of the *state* concept, proper to quantum theory. But what does this concept signify apart from discrete interaction energies: a property, which can equally be referred to energy densities and transition rates, with the result that the energy quanta appear to be a logical consequence of the basic mechanical outlook [3]. The differences to classical models are, furthermore, only superficial and closely related to the fundamental interpretations employed in quantum theory. A statement which seems to be especially appropriate considering the logical circle of interpreting wavefunctions as probability waves and accounting for this interpretation by a normalization condition. From another point of view the framework of quantum theory appears to be the kinetic counterpart of classical electrodynamics: both theories treat, essentially, the same phenomena, but they employ completely different

methods.

Leaving the problem of interpretation aside for the moment, the main theoretical features of quantum theory are, in the present context, the following:

1. A micro structure of moving mass corresponding to wave like distributions.
2. A process of interaction described by constant transfer rates.
3. A statistical ensemble of possible energies (quantum ensembles) and trajectories (local ensemble).
4. A normalization procedure which treats the manifold of single particles as a distribution of probabilities of one single particle.
5. And an equation of motion for the ensembles considered (Schrödinger equation).

It is therefore a decidedly new theoretical framework – contrary to the reductionist’s ambitions –, and which can be understood better by analogy. While statistical mechanics is a statistical superstructure of classical mechanics, quantum theory is best understood as a “statistical field theory”. The result suggests to reverse the conventional logic of development: while quantum field theory proceeds from foundations in quantum theory and arrives, eventually, at the structure of electromagnetic fields, the physical qualities of mass and charge are the foundations, on which the results in quantum theory have to be based. Since the same should apply to the relation between other particles and their corresponding fields, it seems justified to consider all fundamental particles as an expression of field type interactions and statistical measurement processes. In itself, the approach therefore provides a new and fairly extensive field of theoretical possibilities.

There exists, additionally, an essential difference between quantum theory as a statistical framework and classical statistics. Statistical mechanics is composed of single entities subject to the same physical laws (classical mechanics), the ensemble can therefore be decomposed. Quantum ensembles result from an imprecise and arbitrary formulation of the fundamental law of motion (Schrödinger’s equation). The quantum ensemble can therefore neither be decomposed in sub-ensembles, nor is the development of the ensemble or a possible equilibrium state taken into account. The quantum ensemble is not calculated, but defined by the arbitrariness of the equation of motion.

This analysis points to a gap, or rather a big hole in the framework of current physics, obviously brought about by the all too dominating Copenhagen interpretation: while a reasonable scientific approach long ago should have questioned the foundations of quantum physics especially in view of abundant inconsistencies and the obvious fundamental difference between classical electrodynamics and mechanics in their method of modelling,

the prevailing mood of mathematical indulgence served to hide the missing foundations of the framework developed (for a precise and up to date analysis on the history of this error see James Cushing [44]). Up to this date the structure of ensembles, which quantum theory refers to, has been addressed (Bohm) but not conclusively determined. The analysis in this paper revealed that the ensembles are not determined by physical processes – which, in a consistent framework, they have to be – but by mere *possibilities*, which says nothing about the probability of members with exactly defined physical properties. There are two solutions to this problem: (1) The proof, that the ensembles we deal with in measurements are in fact distributions of equal weight (in this case the current approach is justified), or (2) the proof that ensemble members of different properties do have different probabilities (which is rather to be expected from other statistical frameworks): in this case the procedure of quantum theory is but a simplification. In any case it points to a missing theoretical justification, which must be, in future, addressed.

Returning to the problem of interpretation, it can be said, that the Copenhagen interpretation is definitely unjustified: firstly, because the wave properties are of physical significance, and secondly, because it does not provide a full account of physical processes. But the same is true for the alternative interpretations: de Broglie’s interpretation is unsuitable, because the double solution is not correctly describing the physical events and variables (the energy is distributed within the whole region of wave properties, although the wave properties of the wave function are not, generally, the wave properties of single particle waves). Bohm’s interpretation can also not be considered accurate, because the Schrödinger equation is not a deterministic equation, but an equation of statistical ensembles. The correct interpretation is simultaneously more complex and more simple than these approaches signify: quantum theory has to be understood as a statistical framework of particle properties (consistent with the Copenhagen interpretation), although there exists a sublayer of still more fundamental information (consistent with the hidden variables concept): and this sublayer treats the dynamical and intrinsic qualities of mass in motion (consistent with de Broglie’s approach), although not in a way that suggests a double solution.

In view of the fundamental relations described by classical electrodynamics a causal interpretation requires a *local* and *intensive* framework of quantum theory yet to be formulated. The modification of Schrödinger’s equation, derived in section III has not yet been tested. But the relation is non-linear, which precludes superposition, and the potential applied can be made consistent with the process of electron photon interaction.

As quantum theory provides an abstract and widely applicable framework, the second line of research will have to establish differences between different physical situations. It can be assumed, that not all situations described by current quantum theory do really require

a modification of classical electrodynamics other than including the kinetic effects (which was, for example, proved for a simple case of Compton scattering).

Due to the presented combination of classical field theory and intrinsic particle properties it can be expected that the picture of micro physics eventually emerging may be far less prone to excuse sloppy physical theories with limited human understanding. Or, in other words, that a future theory of micro physics may be understandable even from the viewpoint of common sense.

-
- [1] Hofer W. A. Internal energy of free particles: de Broglie waves in electrodynamics. *Specs. Sci. Tech.* **18**, 157 (1995)
- [2] Hofer W. A. An inertial model of atoms: atomic spectra as a resonance problem. *Specs. Sci. Tech.*, in print
- [3] Hofer W. A. Beyond Uncertainty: the internal structure of electrons and photons. *Internet publication*: <http://xxx.lanl.gov/quant-ph/9611009> (1996)
- [4] Schrödinger E. *Ann. Physik* **79**, 361; 489 (1926)
- [5] Bohr N. “Discussion with Einstein on Epistemological Problems in Atomic Physics”, in *A. Einstein: Philosopher-Scientist*, Schilpp P.A. (ed.), Harper and Row, New York (1959)
- [6] Bohm D. *Phys. Rev.* **85**, 166 (1952)
- [7] Heisenberg W. *Z. Physik* **43**, 172 (1927)
- [8] Messiah A. *Quantum Mechanics*, Amsterdam (1964)
- [9] Bohm D. and Bub J. *Rev. Mod. Phys.* **38**, 453 (1966)
- [10] Cohen-Tannoudji C., Diu B., and Laloe F. *Quantum Mechanics* Wiley & Sons, New York (1977)
- [11] de Broglie L. *J. Phys. Radium* **8**, 225 (1927)
- [12] Nelson E. *Phys. Rev.* **150**, 1079 (1966)
- [13] Nelson E. *Dynamical Theories of Brownian Motion*, Princeton (1967)
- [14] Ballentine L. E. *Rev. Mod. Phys.* **42**, 358 (1970)
- [15] de Broglie L. *Nature* **118**, 441 (1926)
- [16] de Broglie L. *J. de Phys.* **8**, 225 (1927)
- [17] Holland P. R. *The quantum theory of motion*, Cambridge University Press, Cambridge UK (1993)
- [18] Mackinnon L. *Found. Phys.* **8**, 157 (1978)
- [19] Datzef A.B. On the non-linear Schrödinger equation, in Tarozzi G. and van der Merwe A. (eds.) *Open Questions in Quantum Physics*, Reidel Publishing, Dordrecht (1985)
- [20] the reduction of the atomic radius compared to the value derived in a previous paper [2] results from including the electron-proton interaction in hydrogen, a complete account will be given in *A dynamic model of atoms: structure, internal interactions and photon emissions of hydrogen*, to be published
- [21] Ballentine L.E. Quantum theory of measurement, in Roth L.M. and Inomata A. (eds.) *Fundamental questions in quantum mechanics*, Gordon & Breach New York (1984)
- [22] in Renninger M. *Z. Physik* **136**, 251 (1953)
- [23] Everett H. *Rev. Mod. Phys.* **29**, 454 (1957)
- [24] Kent A. *Int. J. Mod. Phys. A*, 1745 (1990)
- [25] Kent A. <http://xxx.lanl.gov/gr-qc/9703089> (1997)
- [26] Herzog T.J., Kwiat P.G., Weinfurter H., and Zeilinger A. *Phys. Rev. Lett.* **75**, 3034 (1995)
- [27] Tonomura A., Endo J., Matsuda T., Kawasaki T., and Ezawa H. *Am. J. Phys.* **57**, 117 (1989)
- [28] Rauch H. Neutron interferometric tests of quantum mechanics, in Selleri F. (ed.) *Wave-particle duality* Plenum Press, New York (1992)
- [29] Zeilinger A., Gaehler R., Shull C.G., and Teimer W. *Symposium on Neutron Scattering, Argonne National Laboratory* (Amer. Ints. Phys., 1981)
- [30] Greenberger D.M. The neutron interferometer and the quantum mechanical superposition principle, in Roth L.M. and Inomata A. (eds.) *Fundamental questions in quantum mechanics*, Gordon & Breach New York (1984)
- [31] Scully M.O., and Drühl K. *Phys. Rev. A* **25**, 2208 (1982)
- [32] Misra B. and Sudarshan E. C. G. *J. Math. Phys.* **18**, 765 (1977)
- [33] Peres A. *Am. J. Phys.* **48**, 931 (1989)
- [34] Kwiat P., Weinfurter H., Herzog T., Zeilinger A., and Kashevich M.A. *Phys. Rev. Lett.* **74**, 4763 (1995)
- [35] Kwiat P., Weinfurter H., Herzog T., Zeilinger A., and Kashevich M.A. *Ann. New York Acad. Sci.* **755**, 383 (1995)
- [36] Renninger M. *Z. Physik* **158**, 417 (1960)
- [37] Dicke R.H. *Amer. J. Phys.* **49**, 925 (1981)
- [38] von Neumann J. *Mathematische Grundlagen der Quantenmechanik* Springer, Berlin (1932) pp.305–324
- [39] Jauch J.M. and Piron C. *Helv. Phys. Acta* **36**, 827 (1963)
- [40] Bohm D. and Bub J. *Rev. Mod. Phys.* **38**, 470 (1966)
- [41] Bell J.S. *Rev. Mod. Phys.* **38**, 447 (1966)
- [42] Gleason A.M. *J. Math. & Mech.* **6**, 885 (1957)
- [43] Aspect A., Dalibard J., and Roger G. *Phys. Rev. Lett.* **49**, 1804 (1982)
- [44] Cushing J. T. Causal quantum theory: why a non-starter?, in Selleri F. (ed.) *Wave-particle duality* Plenum Press, New York (1992)