

A Categorical Quantum Logic

Samson Abramsky Ross Duncan

Oxford University Computing Laboratory

15 December 2005

Abstract

We define a strongly normalising proof-net calculus corresponding to the logic of strongly compact closed categories with biproducts. The calculus is a full and faithful representation of the free strongly compact closed category with biproducts on a given category with an involution. This syntax can be used to represent and reason about quantum processes.

1 Introduction

Recent work by Abramsky and Coecke [AC04] develops a complete axiomatization of finite dimensional quantum mechanics in the abstract setting of strongly compact closed categories with biproducts. This is used to formalize and verify a number of key quantum information protocols. In this setting, classical information flow is explicitly represented by the biproduct structure, while the compact closed structure models quantum behaviour: preparation, unitary evolution and projection, including powerful algebraic methods for representing and reasoning about entangled states. Mediating between the two levels is a semiring of scalars, which is an intrinsic part of the structure, and represents the probability amplitudes in the abstract.

Compact closed categories can be seen as degenerate models of multiplicative linear logic in which the connectives, tensor and par, are identified. Similarly, the biproduct is a connective in which the additives of linear logic are combined. The system resulting from these identifications has a very different flavour to linear logic, indeed to any familiar system of logic. Cyclic structures abound, and every sequent is provable. These apparent perversities are, however, no cause for alarm: the resulting equations faithfully mirror calculations in quantum mechanics as shown in [AC04]. Moreover, the cyclic proof structures give rise to *scalars*, and allow quantitative aspects to be expressed.

Beginning with a category \mathcal{A} of basic types and maps between them we develop a logical presentation of the free strongly compact closed category with biproducts $F\mathcal{A}$. By varying the choice of \mathcal{A} it is possible to explore what are the minimal requirements to achieve various “quantum” effects. For example, let \mathcal{A}

be the category with the single object \mathbb{C}^2 , and the Pauli maps as the non-identity arrows. In this case the only possible preparations are the elements of the Bell basis, and their composites. This is sufficient for entanglement swapping, but not logic gate teleportation.

We extend the work of Kelly and Laplaza [KL80] by explicitly describing the arrows of this category in terms of a system of proof-nets. We prove that this syntax is a faithful and fully complete representation of FA .

In this system the axiom links represent the preparation of atomic states, while cuts encode projections. The biproduct is used to represent the classical branching structure. Hence proof-nets can encode physical networks of quantum state preparations and measurements, and a compilation process to quantum circuits is easily defined. Cut-elimination reduces each such network to one without measurements and as such expresses the outcome of executing a quantum protocol or algorithm. Cut-elimination preserves denotational equality and hence can serve as a correctness proof for the protocol encoded by the proof-net.

The cut-elimination procedure provides an easily implemented method for performing calculations about the structure of entangled states. Such a concrete implementation promises to be a useful tool for reasoning qualitatively about quantum protocols. For example, in [AC04], the correctness of several significant quantum protocols is captured as the commutativity of a certain diagram, which expresses the fact that the protocol meets its specification. Such reasoning can be automated by representing the protocol as a proof-net containing Cuts, and normalizing it to show its equality with the specification, which can be represented as a Cut-free proof-net.

Furthermore, the system can be viewed as a step towards a quantum programming language equipped with an entanglement-aware type system.

In order to give a flavour of how the proof-net syntax may be used to represent quantum systems we develop an example, the entanglement swapping protocol, in the next section. In section 3 we reprise the requisite categorical structures, and in sections 4 and 5 we develop the syntax and semantics of our proof-net calculus, and prove strong normalisation. We sketch the proofs of faithfulness and full completeness. More detailed proofs are given in the Appendix.

Previous work Shirahata has studied a sequent calculus for compact closed categories in [Shi96], while Soloviev has studied natural transformations of definable functors on compact closed categories with biproducts in [Sol87]. In [Abr05], the first author has given a comprehensive survey of free constructions for various forms of monoidal category, including traced, compact closed and strongly compact closed categories. Neither biproducts, nor an explicit logical syntax of proof-nets, were considered in that paper.

2 An Example: Entanglement Swapping

Before proceeding to the details of the proof-calculus and its categorical model, we present informally a simple example of a quantum protocol represented as a proof-net. First proposed in [ZZHE93], *entanglement swapping* allows two parties, Alice and Bob, to share an entangled state without directly interacting with each other. Instead they each share a Bell pair with an intermediary, Charlie, who performs a projective Bell-basis measurement on his part of the two entangled states. After this measurement, the qubits retained by Alice and Bob are jointly in a Bell state, and the outcome of Charlie's measurement will indicate which state it is.

For any finite dimensional vector spaces, A , and B there is an isomorphism between $A \otimes B$ and the linear maps $A \rightarrow B$ via

$$\sum_{ij} \lambda_{ij} a_i \otimes b_j \cong a_i \mapsto \sum_{ij} \lambda_{ij} b_j.$$

We label states by the maps which they are related to under this isomorphism. For example the 4 elements of the Bell basis are related to the Pauli maps, up to a global phase. Since $\frac{1}{\sqrt{2}}(|00\rangle + |11\rangle) \leftrightarrow 1_Q$, we represent a Bell state as a proof-net as shown below.

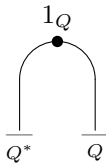

We view this as representing a 2-qubit state, but if read from top to bottom, it can also be seen as the quantum process which produces the state. In general proof-nets are understood as processes but if, as in this case, the proof-net is *normal* then there is no danger in identifying the quantum state with the process which prepares it.

The other component of this protocol is the measurement in the Bell basis. Suppose that the measurement performed by Charlie yields the state X ; then the effect of this measurement is to project his two qubits onto that state. This is dual to preparing the state, and represented by the following diagram fragment

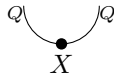

Combining two Bell states and the projection we get the proof-net labelled (a)

below

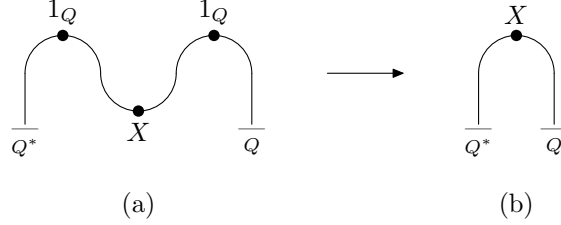

which represents the whole protocol: the preparation of two Bell states in parallel, and the projection of two of the qubits onto the state X . This is a process which prepares a 2-qubit state — we view measurements as destructive — and by *normalising* the proof-net we can compute which state is prepared. For a proof-net as simple as this one, the result is simply the state which codes the composition of the functions labelling the arcs. In this case the resulting state is that coded by $1_Q \circ X \circ 1_Q = X$, labelled (b) above.

In reality, there are four possible outcomes of a Bell measurement; these distinct possibilities are represented as *slices*, which are in a sense different pages of the diagram. In this case each slice represents a different element of the Bell basis.

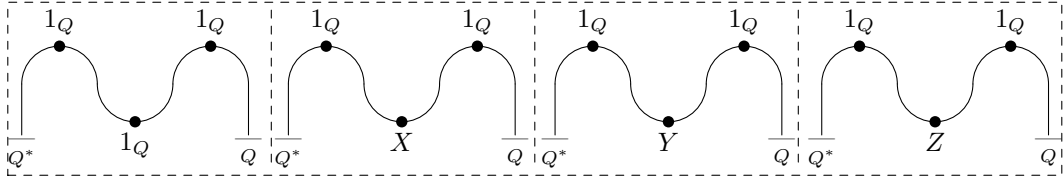

Further, the party who performs the measurement knows which outcome actually occurred; we represent this classical information with a “gearstick”. In each slice we use a different index to label each possible outcome. The final protocol is shown below.

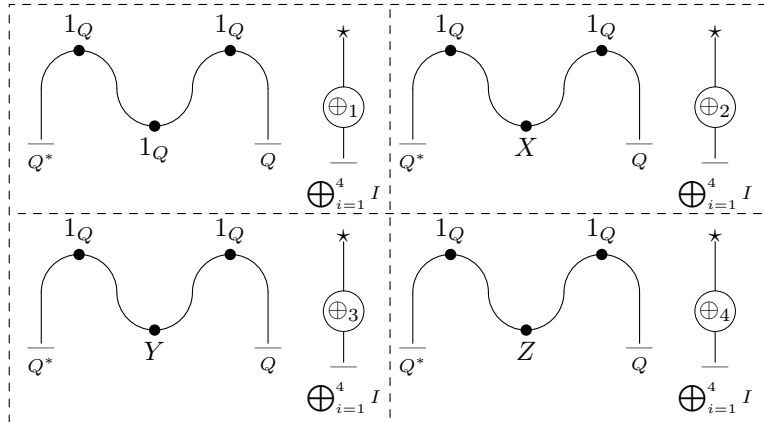

In the following sections we formalise the syntax and semantics of this proof calculus, and prove that the diagrammatic reasoning employed is correct with respect to any suitable category.

3 Categorical Preliminaries

We recall the definitions and key properties of strongly compact closed categories with biproducts (SCCCBs). Considered separately, compact closure and biproducts are standard structures, and may be found in [Mit65, ML97, KL80] for example. Compact closed categories with biproducts have also been studied by Soloviev [Sol87] and, with some strong additional assumptions, as *Tannakian categories* [Del91]. They have also been studied in a Computer Science context in the first author's work on Interaction Categories [AGN96]. Strong compact closure is introduced, and an axiomatic approach to quantum mechanics based on strongly compact closed categories with biproducts is developed, in [AC04].

We will use **FDHilb**, the category of finite dimensional complex Hilbert spaces and linear maps as a running example. Another example of an SCCCB is **Rel**, the category of sets and relations.

Definition 1 (Symmetric Monoidal Category). *A symmetric monoidal category is a category \mathcal{C} equipped with a bifunctor*

$$- \otimes - : \mathcal{C} \times \mathcal{C} \longrightarrow \mathcal{C},$$

a monoidal unit object I and certain natural isomorphisms

$$\lambda_A : A \simeq I \otimes A \qquad \rho_A : A \simeq A \otimes I$$

$$\alpha_{A,B,C} : A \otimes (B \otimes C) \simeq (A \otimes B) \otimes C$$

$$\sigma_{A,B} : A \otimes B \simeq B \otimes A$$

which satisfy certain coherence conditions [ML97]. Without essential loss of generality, we can assume that λ, ρ and α are all identities; that is, we can assume a strict monoidal category.

In any symmetric monoidal category \mathcal{C} , the endomorphisms $\mathcal{C}(I, I)$ form a commutative monoid [KL80]. We call these endomorphisms the *scalars* of \mathcal{C} . For each scalar $s : I \rightarrow I$ we can define a natural transformation

$$s_A : A = I \otimes A \xrightarrow{s \otimes 1_A} I \otimes A = A.$$

Hence, we can define *scalar multiplication* $s \bullet f := f \circ s_A = s_B \circ f$ for $f : A \rightarrow B$. Then we have

$$(s \bullet g) \circ (r \bullet f) = (s \circ r) \bullet (g \circ f)$$

for $r : I \rightarrow I$ and $g : B \rightarrow C$.

Definition 2 (Compact Closed Category). A symmetric monoidal category is compact closed if to each object A there is an assigned left adjoint $(A^*, \eta_A, \epsilon_A)$ such that the composites

$$\begin{aligned} A &= A \otimes I \xrightarrow{1_A \otimes \eta_A} A \otimes A^* \otimes A \xrightarrow{\epsilon_A \otimes 1_A} I \otimes A = A \\ A^* &= I \otimes A^* \xrightarrow{\eta_A \otimes 1_{A^*}} A^* \otimes A \otimes A^* \xrightarrow{1_{A^*} \otimes \epsilon_A} A^* \otimes I = A^* \end{aligned}$$

are both identities.

In **FDHilb** the tensor product is just the usual Kronecker tensor product, and $I = \mathbb{C}$. Since any linear map from \mathbb{C} to itself is fixed by its value at 1, the formal scalars in **FDHilb** are indeed the complex numbers. If A is some finite dimensional Hilbert space then, we can take A^* to be the usual dual, the space of linear maps $A \rightarrow \mathbb{C}$. Given a basis $\{a_i\}_i$ for A , and its dual basis $\{\bar{a}_i\}_i$, the required maps are

$$\begin{aligned} \eta_A : 1 &\mapsto \sum_i \bar{a}_i \otimes a_i; \\ \epsilon_A : a_i \otimes \bar{a}_j &\mapsto \delta_{ij}. \end{aligned}$$

A routine calculation verifies that the required equalities hold, **FDHilb** is indeed compact closed.

For each morphism $f : A \rightarrow B$ in a compact closed category we can construct its *name*, $\lrcorner f \lrcorner : I \rightarrow A^* \otimes B$, *coname*, $\llcorner f \lrcorner : A \otimes B^* \rightarrow I$, and *dual*, $f^* : B^* \rightarrow A^*$, by

$$\begin{array}{ccc} I \xrightarrow{\eta_A} A^* \otimes A & & A \otimes B^* \\ \searrow \lrcorner f \lrcorner \quad \downarrow 1_{A^*} \otimes f & & \downarrow f \otimes 1_{B^*} \quad \swarrow \llcorner f \lrcorner \\ & A^* \otimes B & B \otimes B^* \xrightarrow{\epsilon_A} I \end{array}$$

$$\begin{array}{ccc} B^* & = & I \otimes B^* \xrightarrow{\eta_A \otimes 1_{B^*}} A^* \otimes A \otimes B^* \\ \downarrow f^* & & \downarrow 1_{A^*} \otimes f \otimes 1_{B^*} \\ A^* & = & A^* \otimes I \xleftarrow{1_{A^*} \otimes \epsilon_B} A^* \otimes B \otimes B^* \end{array}$$

In particular, the map $f \mapsto f^*$ extends to a contravariant endofunctor with $A \cong A^{**}$.

Each compact closed category admits a categorical trace. That is, for every morphism $f : A \otimes C \rightarrow B \otimes C$ certain axioms [JSV96] are satisfied by $\text{Tr}_{A,B}^C(f) : A \rightarrow B$, defined as the composite:

$$A = A \otimes I \xrightarrow{1_A \otimes \eta_C} A \otimes C \otimes C^* \xrightarrow{f \otimes 1_{C^*}} B \otimes C \otimes C^* \xrightarrow{1_B \otimes \epsilon_C} B \otimes I = B.$$

The following results are proved in [AC04].

Lemma 3. *Suppose we have maps $E \xrightarrow{k} A \xrightarrow{f} B \xrightarrow{g} C \xrightarrow{h} D$. Then we have the following equations.*

(a). *Absorption:*

$$(1_{A^*} \otimes g) \circ \ulcorner f \urcorner = \ulcorner g \circ f \urcorner$$

(b). *Backward absorption:*

$$(k^* \otimes 1_{A^*}) \circ \ulcorner f \urcorner = \ulcorner f \circ k \urcorner$$

(c). *Compositionality:*

$$\lambda_C^{-1} \circ (\lrcorner f \lrcorner \otimes 1_C) \circ (1_A \otimes \ulcorner g \urcorner) \circ \rho_A = g \circ f$$

(d). *Compositional cut:*

$$(\rho_A^{-1} \otimes 1_{D^*}) \circ (1_{A^*} \otimes \lrcorner g \lrcorner \otimes 1_D) \circ (\ulcorner f \urcorner \otimes \ulcorner h \urcorner) \circ \rho_I = \ulcorner h \circ g \circ f \urcorner$$

The obvious analogues of Lemma 3(a) and 3(b) for conames also hold.

Definition 4 (Zero Object). *A zero object in \mathcal{C} is both initial and terminal. If $\mathbf{0}$ is a zero object, there is an arrow $0_{A,B} : A \longrightarrow \mathbf{0} \longrightarrow B$ between any pair of objects A and B .*

Definition 5 (Biproduct). *Let \mathcal{C} be a category with a zero object and binary products and coproducts. Any arrow*

$$A_1 \coprod A_2 \rightarrow A_1 \prod A_2$$

can be written uniquely as a matrix (f_{ij}) , where $f_{ij} : A_i \rightarrow A_j$. If the arrow

$$\begin{pmatrix} 1 & 0 \\ 0 & 1 \end{pmatrix}$$

is an isomorphism for all A_1, A_2 , then we say that \mathcal{C} has biproducts, and write $A \oplus B$ for the biproduct of A and B .

If \mathcal{C} has biproducts then we can define an operation of addition on each hom-set $\mathcal{C}(A, B)$ by

$$f + g = \nabla \circ (f \oplus g) \circ \Delta$$

for $f, g : A \rightarrow B$, where $\Delta = \langle 1_A, 1_A \rangle$ and $\nabla = [1_B, 1_B]$. This operation is associative and commutative, with 0_{AB} as a unit. Moreover, composition is bilinear with respect to this semi-additive structure.

In **FDHilb** the direct sum of Hilbert spaces gives a biproduct, with the vector space $\{0\}$ as the zero object; the addition on hom sets is normal addition

of maps. In **Rel** the biproduct is given by disjoint union of sets; addition of relations is given by their union.

If \mathcal{C} has biproducts, we can choose projections p_1, p_2 and injections q_1, q_2 for each $A \oplus B$ satisfying:

$$p_i \circ q_j = \delta_{ij} \quad q_1 \circ p_1 + q_2 \circ p_2 = 1_{A \oplus B}$$

where $\delta_{ii} = 1$, and $\delta_{ij} = 0$, $i \neq j$.

Remark 1. *We note that if \mathcal{C} is already equipped with a semiadditive structure as above then one can define the biproduct directly as a diagram,*

$$A \begin{array}{c} \xleftarrow{p_1} \\ \xrightarrow{q_1} \end{array} A \oplus B \begin{array}{c} \xrightarrow{p_2} \\ \xleftarrow{q_2} \end{array} B$$

satisfying

$$p_i \circ q_j = \delta_{ij} \quad q_1 \circ p_1 + q_2 \circ p_2 = 1_{A \oplus B}.$$

This fact will be used for the biproduct structure of the proof calculus.

Of course, the biproduct defines a monoidal structure, with unit object $\mathbf{0}$. As before, we will take it to be strict:

$$(A \oplus B) \oplus C = A \oplus (B \oplus C), \quad \mathbf{0} \oplus A = A = A \oplus \mathbf{0}.$$

Proposition 6 (Distributivity of \otimes over \oplus). *In monoidal closed categories with biproducts there are natural isomorphisms*

$$d_{A,B,C} : A \otimes (B \oplus C) \cong (A \otimes B) \oplus (A \otimes C)$$

$$d_{A,\cdot,\cdot} = \langle 1_A \otimes p_1, 1_A \otimes p_2 \rangle \quad d_{A,\cdot,\cdot}^{-1} = [1_A \otimes q_1, 1_A \otimes q_2].$$

A left distributivity isomorphism can be defined similarly.

Proposition 7. *In a monoidal closed category with a $\mathbf{0}$ object there are natural isomorphism $A \otimes \mathbf{0} \cong \mathbf{0} \cong \mathbf{0} \otimes A$.*

Proposition 8 (Self-duality for $(\cdot)^*$). *In a compact closed category with biproducts the following natural isomorphisms exist.*

$$\begin{array}{lll} A^{**} \cong A & (A \otimes B)^* \cong A^* \otimes B^* & I^* \cong I \\ (A \oplus B)^* \cong A^* \oplus B^* & \mathbf{0}^* \cong \mathbf{0} & \end{array}$$

It will be notationally convenient to take all the canonical maps of Prop. 7 and 8 as equalities.

Definition 9 (Strong Compact Closure). *A compact closed category \mathcal{C} is strongly compact closed if the assignment $A \mapsto A^*$ extends to a covariant involutive compact closed functor. Write f_* for the action of this functor on arrow f . (See [AC05] for an alternative definition of strong compact closure).*

Given $f : A \rightarrow B$ in a strongly compact closed category \mathcal{C} we can define its adjoint $f^\dagger : B \rightarrow A$ by $f^\dagger = (f_*)^* = (f^*)_*$. The assignments $A \mapsto A$ on objects and $f \mapsto f^\dagger$ on arrows define an involutive functor \cdot . If \mathcal{C} has biproducts then $(\cdot)^\dagger$ preserves them, and hence is additive.

If \mathcal{C} is strongly compact closed and has biproducts we require a compatibility condition, namely that the coproduct injections

$$q_i : A_i \rightarrow \bigoplus_{k=1}^{k=n} A_k$$

satisfy $q_j^\dagger \circ q_i = \delta_{ij}$. It then follows that the projections and injections additionally satisfy $(p_i)^\dagger = q_i$.

In **FDHilb** the $(\cdot)^\dagger$ is the usual adjoint of a linear map, given by

$$\langle \psi \mid f\phi \rangle = \langle f^\dagger\psi \mid \phi \rangle.$$

The functorial action f_* is defined by

$$f_*(\phi)(v) = \phi \circ f^\dagger(v).$$

Remark 2. *In [AC04], A^* is defined to be the conjugate space of A , which has the advantage of being strictly involutive.*

4 The Logic of SCCCBs

The purpose of this paper is to present a logic whose syntax captures the structure of the free strongly compact closed category with biproducts generated by a category with an involution. The formulae of the logic represent the objects of the free category, while the proofs represent the arrows¹.

Let F be the functor which takes a category with involution to the free strongly compact closed category with biproducts generated upon it.

$$\mathbf{InvCat} \begin{array}{c} \xrightarrow{F} \\ \perp \\ \xleftarrow{U} \end{array} \mathbf{SCCCB}$$

Here **InvCat** is the category of categories with involutions, *i.e.* identity-on-objects, contravariant, involutive functors, and functors preserving the given

¹See the remarks at the end of [KL80] which explain why a description of the free compact closed category is the strongest available form of coherence theorem for such categories.

involutions. We will define a logic relative to a ground category \mathcal{A} (standing for “axioms” or “atoms” according to taste) with involution $(\cdot)^\dagger$. The objects of \mathcal{A} will form the atomic formulas of the syntax, and its arrows will give non-logical axioms. The formulas of the resulting logic will represent the objects of the generated category $F\mathcal{A}$, while the proofs will represent its arrows.

We can simplify our task, following [Abr05]. It is shown there that F_{CC} , the functor that constructs the free compact closed category generated by a category, lifts to **InvCat** to yield the free strongly compact closed category over a category with involution. This amounts to the observation that, given an involution on the base category, it lifts to one on the freely generated compact closed category, and moreover this lifted involution is compatible with the compact closed structure in the required fashion—so that, in particular,

$$\epsilon_A = \sigma_{A^*, A} \circ \eta_A^\dagger.$$

Lemma 27 in the Appendix recalls how the involution is lifted.

Henceforth we will assume that \mathcal{A} has an adjoint f^\dagger assigned to every arrow f .

Definition 10. *The formulae of the logic are built from the following grammar:*

$$F ::= \mathbf{0} \mid \mathbf{I} \mid A \mid A^* \mid F \otimes F \mid F \oplus F,$$

where A ranges over the objects of \mathcal{A} , which we shall refer to as atoms. In order to capture the strictness of the connectives with respect to their units, the use of the units is restricted: $\mathbf{0}$ may not occur as a subformula of any formula other than itself; while \mathbf{I} may only occur immediately under a biproduct, i.e. $\mathbf{I} \otimes A$ is banned, but $(\mathbf{I} \oplus A) \otimes B$ is permitted. While it is technically convenient to admit \mathbf{I} as a valid formula, a correctness condition for proof-nets will guarantee that \mathbf{I} never occurs in a conclusion of a correct proof without an accompanying \oplus . We define $(\cdot)^*$ on arbitrary formulae by the following equations:

$$\begin{aligned} X^{**} &= X \\ (X \otimes Y)^* &= X^* \otimes Y^* \\ (X \oplus Y)^* &= X^* \oplus Y^* \\ \mathbf{I}^* &= \mathbf{I} \\ \mathbf{0}^* &= \mathbf{0}. \end{aligned}$$

We use the notation convention that upper case letters A, B, C from the start of the latin alphabet are atoms and those from the end of the alphabet X, Y, Z are arbitrary formulae. Upper case Greek letters Γ, Δ, Σ signify lists of formulae.

Definition 11. *We shall use axiom synonymously with arrow of \mathcal{A} .*

Cyclic structures play an important role in the theory of compact closed categories and we shall have need of them in the syntax. Define the set of endomorphisms $E(\mathcal{A})$ by the disjoint union

$$E(\mathcal{A}) = \sum_{A \in |\mathcal{A}|} \mathcal{A}(A, A),$$

and let the set of *loops* $[\mathcal{A}]$ be the quotient of $E(\mathcal{A})$ generated by the relation $f \circ g \sim g \circ f$ whenever $A \xrightarrow{f} B \xrightarrow{g} A$.

5 Proof-nets

We present a graphical proof notation which captures precisely the structure of strongly compact closed categories with biproducts; in fact we offer a faithful and fully complete representation of $F\mathcal{A}$.

5.1 Syntax

Definition 12 (slice). *A slice is a finite oriented graph with edges labelled by formulae. The graph is constructed by composing the following nodes, which we call links, while respecting the labelling on the incoming and outgoing edges.*

Axiom : *No incoming edges; two out-going edges. The link itself is labelled by an axiom $f : A \rightarrow B$. One outgoing edge is labelled A^* , the other, B .*

Cut : *Two incoming edges; no outgoing edges. Each cut is labelled either by an axiom $f : A \rightarrow B$ with incoming edges are labelled by atoms A and B^* , or else it is labelled by an identity with the incoming edges labelled by X and X^* for an arbitrary formula X .*

Times : *Two incoming edges labelled A and B ; one outgoing edge labelled $A \otimes B$.*

Plus 1 : *One incoming edge labelled A ; one outgoing edge labelled $A \oplus B$.*

Plus 2 : *One incoming edge labelled B ; one outgoing edge labelled $A \oplus B$.*

I : *No incoming edges; one outgoing edge labelled by I .*

*The orientation is such that edges enter the node from the top, and exit from the bottom. The conclusions of the slice are those labels on outgoing edges of links which are left unconnected. The order of the conclusions is significant. There is one correctness criterion: every I -link must be connected to either a *Plus*-link or a cut labelled with 1_I .*

Definition 13 (net). *A net (or proof-net) is a finite multiset of slices where each slice has the same conclusions. The conclusions of the net are the same as those of its slices.*

We emphasise that empty slice is a valid slice, having no conclusions, and the empty set of slices is a valid net. In particular the empty net may be considered as having any conclusions; since there is no rule for introducing it otherwise, the additive unit $\mathbf{0}$ can only occur among the conclusions of an empty net.

Example 14. This net represents the distribution of \otimes over \oplus .

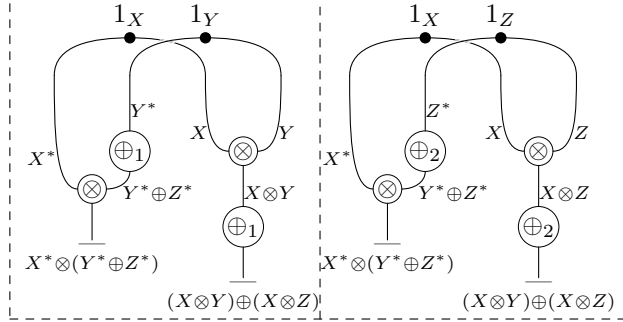

Definition 15 (Normal Forms). A slice is normal if every connected component either has no cut links, or is a closed loop formed by an axiom link and an identity cut. We identify loops if their labels are related by the equivalence relation on endomorphisms give in section 4. A net is normal if every slice is normal.

Definition 16 (β -Reduction). Let \rightarrow_β be the reflexive transitive closure of the relation defined on slices by the following set of rewrites on cut links.

1. A cut between atomic formulae. Atomic formulae are only introduced by axiom links, so there are two subcases.

(a) If both formulae belong to the same axiom (say f):

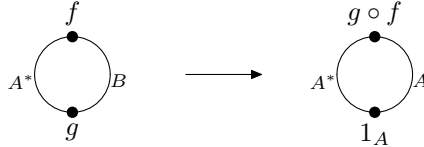

(b) If the cut formulae are conclusions of different axioms, say f and h :

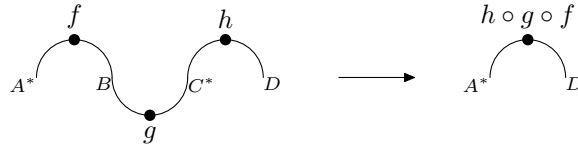

2. Cut between two tensor products:

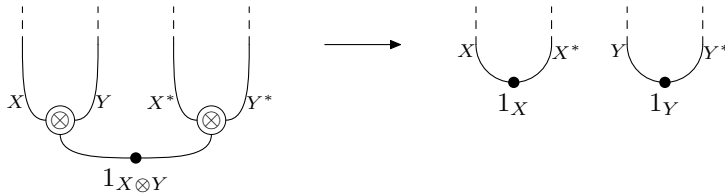

3. Cut between two biproducts:

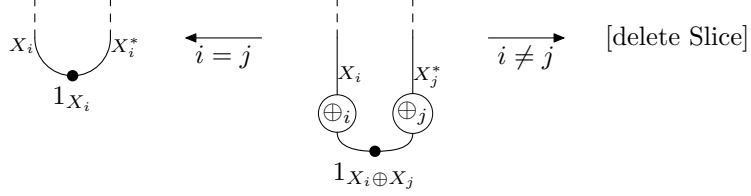

4. Cut between two I-links:

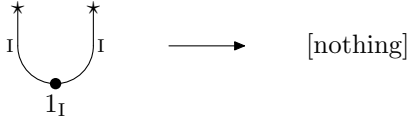

Extend \rightarrow_β to proof-nets by $\pi \rightarrow_\beta \pi'$ iff there is an injective map p from the slices of π' to those of π , such that if $p(s') = s$ then $s \rightarrow_\beta s'$, and for every slice s of π not in the image of p , there is a \rightarrow_β sequence ending in “Delete Slice”. Let $=_\beta$ be the symmetric closure of \rightarrow_β .

Theorem 17 (Cut Elimination). *The relation \rightarrow_β is confluent and terminating; further the β -normal forms are normal in the sense of Def. 15 above.*

Proof. It suffices to consider \rightarrow_β on slices alone.

In the case of 1(b) pairs of rewrites may interfere as shown in figure 1. However associativity in the underlying category \mathcal{A} prevents any conflict.

Case 1(a) may also conflict with 1(b) as shown in figure 2; in this case the two resulting components are identified by the equivalence on loops.

With these exceptions, each reduction step is purely local — no rewrite can affect any other — hence the process is confluent. Since each step reduces the complexity of the net, there is no infinite reduction sequence, and hence every net is strongly normalising.

The only situation where a cut will not be eliminated are those in case 1(a); hence when no more rewrites can be done the slice is normal, as required. \square

5.2 Semantics

Definition 18 (Semantics of proof-nets). *Let ν be a proof-net with conclusions Γ . Define an arrow of FA , $\llbracket \nu \rrbracket : I \rightarrow \bigotimes \Gamma$, by recursion on the structure of ν . Consider each slice s of ν .*

- *If s is just an axiom link corresponding to the arrow $f : A \rightarrow B$, then let $\llbracket s \rrbracket = \ulcorner f \urcorner : I \rightarrow A^* \otimes B$.*

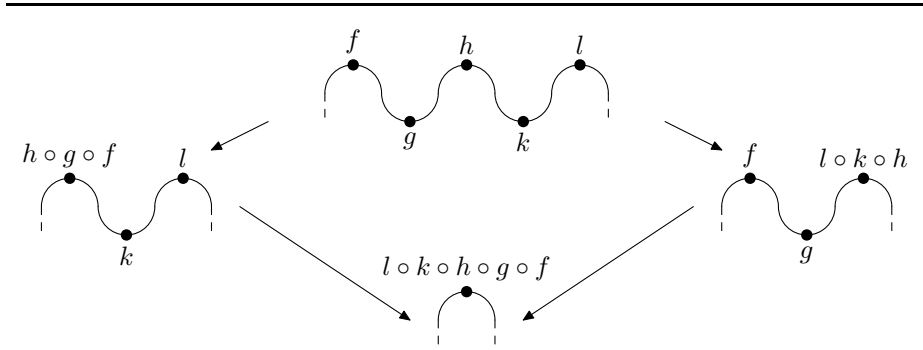

Figure 1: Confluence of cut elimination step 1(b)

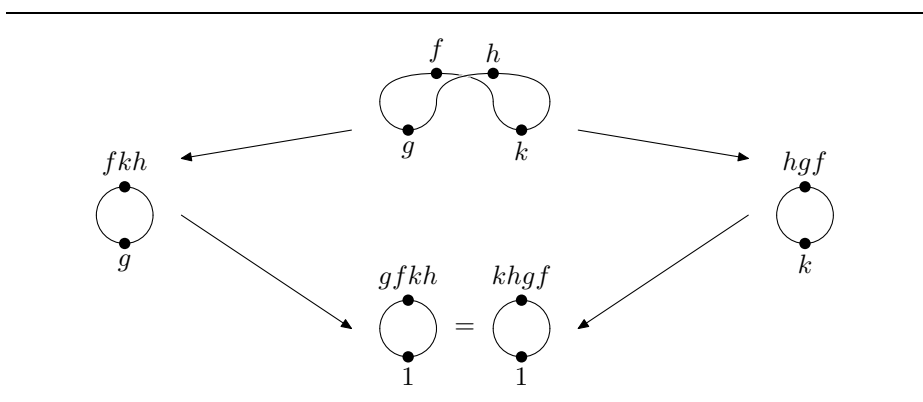

Figure 2: Confluence of cut elimination step 1(a)/1(b)

- If s has several disconnected components s_1, \dots, s_n then define

$$\llbracket s \rrbracket = \bigotimes_{i=1}^n \llbracket s_i \rrbracket.$$

- If s is built by applying a cut labelled by $f : A \rightarrow B$ between conclusions A and B^* of s' , suppose that we have constructed $\llbracket s' \rrbracket : I \rightarrow \Gamma \otimes A \otimes B^* \otimes \Delta$. Then define $\llbracket s \rrbracket$ by the composition

$$I \xrightarrow{\llbracket s' \rrbracket} \Gamma \otimes A \otimes B^* \otimes \Delta \xrightarrow{1_\Gamma \otimes \lrcorner g \lrcorner \otimes 1_\Delta} \Gamma \otimes \Delta.$$

- If s is built by applying a \otimes -link between conclusions A and B of s' then let $\llbracket s \rrbracket = \llbracket s' \rrbracket$.
- If s is built by applying a \oplus_i link to conclusion A_j of s' , construct $\llbracket s' \rrbracket : I \rightarrow \Gamma \otimes A_j \otimes \Delta$ then define $\llbracket s \rrbracket$ by the composition

$$I \xrightarrow{\llbracket s' \rrbracket} \Gamma \otimes A_j \otimes \Delta \xrightarrow{1_\Gamma \otimes q_i \otimes 1_\Delta} \Gamma \otimes (A_1 \oplus A_2) \otimes \Delta.$$

- If s is an I-link, then $\llbracket s \rrbracket = 1_I$.
- If s is the empty slice $\llbracket s \rrbracket = 1_I$.

All these constructions commute wherever the required compositions are defined due to the functoriality of the tensor, hence $\llbracket s \rrbracket$ is well defined. Let ν be the net composed of the slices s_1, \dots, s_n . We define

$$\llbracket \nu \rrbracket = \sum_{i=1}^n \llbracket s_i \rrbracket.$$

If ν is the empty proof-net (i.e. it has no slices) $\llbracket \nu \rrbracket = 0_{I, \Gamma}$.

Theorem 19 (Soundness). *If a net $\nu \rightarrow_\beta \nu'$ then $\llbracket \nu \rrbracket = \llbracket \nu' \rrbracket$.*

Proof. Each of the one step rewrite rules preserves denotation. For each rewrite rule we show the corresponding equation.

1. Suppose we have arrows $B \xrightarrow{e} A \xrightarrow{f} B \xrightarrow{g} C \xrightarrow{h} D$ in \mathcal{A} ; then

(a) We have

$$\begin{aligned} \lrcorner e \lrcorner \circ \lrcorner f \lrcorner &= \epsilon_{A^*} \circ (1_{A^*} \otimes e) \circ (1_{A^*} \otimes f) \circ \eta_A \\ &= \epsilon_{A^*} \circ (1_{A^*} \otimes (e \circ f)) \circ \eta_A \\ &= \epsilon_{A^*} \circ \lrcorner e \circ f \lrcorner \end{aligned}$$

directly from the definition of the name and coname.

(b) The required equation

$$(1_{A^*} \otimes \lrcorner g \lrcorner \otimes 1_D) \circ (\ulcorner f \urcorner \otimes \ulcorner h \urcorner) = \ulcorner h \circ g \circ f \urcorner$$

is lemma 3.(d) verbatim.

2. The case for tensor follows from $\epsilon_{A \otimes B} = \sigma \circ (\epsilon_A \otimes \epsilon_B)$.

3. By using forwards and backwards absorption (lemmas 3.(a),3.(b)) we have

$$\epsilon_{A_i \oplus A_j} \circ (q_i \otimes q_j) = \lrcorner p_j \circ 1_{A_i \oplus A_j} \circ q_i \lrcorner = \begin{cases} \epsilon_{A_i} & \text{if } i = j \\ \lrcorner 0_{A_i, A_j} \lrcorner & \text{if } i \neq j \end{cases}$$

Consider the case where $i \neq j$. We note that $\lrcorner 0_{A_i, A_j} \lrcorner = 0_{A_i \otimes A_j^*, I}$, and since any arrow composed with, or tensored with, a zero map is itself a zero map the denotation of the entire slice must be zero. Hence we may delete it without altering the denotation of the net.

4. Since $F\mathcal{A}$ is strict, we have that $\epsilon_I \circ (1_I \otimes 1_I) = 1_I$ as required.

The result follows by the functoriality of the tensor. \square

Now we show that the proof-net syntax is a faithful representation of the category $F\mathcal{A}$. For the purposes of the following proof, by *involution on a set X* we will mean a category consisting of a finite coproduct of copies of the category $\mathbf{2}$ (with objects 0, 1, and one non-identity arrow $0 \rightarrow 1$), whose objects are in bijective correspondence with the elements of X .

Lemma 20. *In order to specify a normal slice uniquely the following data are required:*

1. *The list of conclusions Γ ;*
2. *A list of booleans B , indicating, for each occurrence of the connective \oplus in Γ , whether the left or right subformula was the premise of the link which introduced it;*
3. *An involution θ on those atoms of Γ which are not introduced by the \oplus rules such that each atom is paired with a copy of 0 iff it is negative, together with a functor $p : \theta \rightarrow \mathcal{A}$;*
4. *A multiset L of loops in \mathcal{A} .*

Proof. Clearly every normal slice will define the four data above, and do so uniquely. We show how to reconstruct the the slice from the data. For each formula X of Γ , the syntax of X combined with B fix a unique set of logical ($\otimes, \oplus, \text{I}$) links which derive the formula from its constituent atoms. Necessarily, there are an equal number of positive and negative atoms; θ specifies an arrangement of axiom links between them labelled by p . This doesn't totally fix the slice, since we may have additional disconnected components. Since they have no conclusions, and the slice is normal, any remaining components must be loops, which are specified by L . \square

Theorem 21 (Faithfulness). *If nets ν, ν' have the same conclusions Γ then $\llbracket \nu \rrbracket = \llbracket \nu' \rrbracket$ implies $\nu =_{\beta} \nu'$.*

Proof. Let s be a normal slice. By Def. 18 $\llbracket s \rrbracket = c \bullet f$, where c is a scalar and f has the following structure:

$$I \xrightarrow{\ulcorner f_1 \urcorner \otimes \dots \otimes \ulcorner f_n \urcorner} \bigotimes_{i=1}^n (A_{2i-1}^* \otimes A_{2i}) \xrightarrow{\sigma} \bigotimes_{i=1}^{2n} A_{\sigma(i)} \xrightarrow{\kappa} \Gamma$$

upto a scalar multiple, where σ is a permutation, and κ is a tensor product of identities and injections. This structure suffices to define the data of the preceding lemma.

Every \oplus in Γ must be introduced by the injections κ , which serve to define B . Given σ and any ordering on the names $\ulcorner f_i \urcorner$ the pair (θ, p) is easily reconstructed.

If $c \neq 1_I$ then the free construction of $F\mathcal{A}$ guarantees that it is product of arrows of the form

$$I \xrightarrow{\ulcorner l \urcorner} A^* \otimes A \xrightarrow{\epsilon_{A^*}} I.$$

Each automorphism l defines a loop, so c defines L . It is easy to verify that the slice reconstructed from c and f will be the original slice s .

Since the addition is freely constructed, $\llbracket \nu \rrbracket = \llbracket \nu' \rrbracket$ implies that both are equal to the same formal sum $\sum_i f_i$, where each f_i is the denotation of a slice. Since each f_i determines a unique normal slice, we have that the normal forms of ν and ν' comprise the same multiset of slices, hence $\nu =_{\beta} \nu'$. \square

It should be noted that the faithfulness result required the conclusions of the nets to be specified. In fact the syntax is not truly injective onto the arrows of $F\mathcal{A}$. For example, the proof-nets

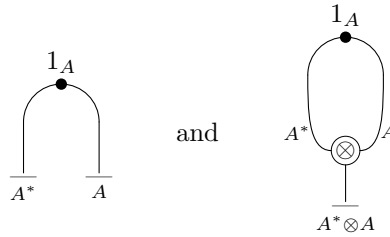

both denote the map η_A .

Let $F_{\text{SCC}} : \mathbf{Cat} \rightarrow \mathbf{ComClCat}$ be the functor which takes a category to the free compact closed category generated by it. This functor has been described in detail in [KL80]. We note that $F_{\text{SCC}}\mathcal{A}$ is a subcategory of $F\mathcal{A}$.

Theorem 22 (Full Completeness). *Let f be an arrow of $F\mathcal{A}$, the free compact closed category with biproducts on \mathcal{A} ; then there exists a net ν such that $\ulcorner f \urcorner = \llbracket \nu \rrbracket$.*

Sketch proof. We note that each object of $F\mathcal{A}$ is canonically isomorphic to an object in additive normal form; that is where no occurrence of \oplus occurs in the scope of any occurrence of \otimes . Hence given an arrow $f : A \rightarrow B$ in $F\mathcal{A}$ one can construct the three other sides of following square

$$\begin{array}{ccc}
 A & \xrightarrow{f} & B \\
 \cong \downarrow & & \uparrow \cong \\
 \bigoplus_i \bigotimes_{j_i} A_{j_i} & \xrightarrow{\bigoplus_i f_i} & \bigoplus_i \bigotimes_{k_i} B_{k_i}
 \end{array}$$

such that each f_i is a (possibly empty) sum of arrows of $F_{\text{SCC}}\mathcal{A}$. The theorem of Kelly-Laplaza [KL80] gives an explicit description the arrows in $F_{\text{SCC}}\mathcal{A}$ and hence immediately a proof-net for each one. Then each f_i yields a collection of slices. From here it is straightforward to construct the proof-net of $\bigoplus_i f_i$. \square

The appendix contains a more detailed proof of the theorem.

6 Further Work

In the present paper, we have focused on freely generating the structure over a category with no additional structure. If the category in question has an object for the type of qubits, then the resulting free structure will not contain, for example, the controlled not gate, nor any other multi-qubit operation. Without such maps the expressivity of the system is limited. Therefore an important further step is to consider the structure of the freely generated strongly compact closed category with biproducts over a category with a *given* symmetric monoidal structure. This is carried out in the forthcoming thesis [Dun] of the second author.

Furthermore, although it has not been discussed here, the model may be further tuned by the choice of the semiring of scalars $I \rightarrow I$. These represent the “amplitudes” of the different terms of a state, and hence give rise to the probabilities of different outcomes of a quantum process. The equational structure of the scalars constrains the representable quantum processes. For example it is known that the category **Rel** does not have enough scalars to represent the teleportation protocol. It is possible to specify a desired semiring R of scalars as a separate parameter to a free construction, together with a map from the loops of \mathcal{A} to R [Abr05]. Given a suitable rewriting theory for R , this can be combined with the proof-net calculus to yield a system in which it should be possible to extract concrete probabilities and other quantitative information. These ideas will be developed in future work.

References

- [Abr05] S. Abramsky. Abstract scalars, loops, and free traced and strongly compact closed categories. In J. Fiadeiro, editor, *Proceedings of CALCO 2005*, volume 3629 of *Springer Lecture Notes in Computer Science*, pages 1–31, 2005.
- [AC04] S. Abramsky and B. Coecke. A categorical semantics of quantum protocols. In *Proceedings of the 19th Annual IEEE Symposium on Logic in Computer Science: LICS 2004*, pages 415–425. IEEE Computer Society, 2004.
- [AC05] S. Abramsky and B. Coecke. Abstract physical traces. *Theory and Applications of Categories*, 14(6):111–124, 2005.
- [AGN96] S. Abramsky, S. Gay, and R. Nagarajan. Interaction categories and the foundations of typed concurrent programming. In M Broy, editor, *Proceedings of the 1994 Marktoberdorf Summer School on Deductive Program Design*, pages 35–113. Springer-Verlag, 1996.
- [Del91] P. Deligne. Catégories tannakiennes. In *Grothendieck Festschrift*, volume 2, pages 111–194. Birkhauser, 1991.
- [Dun] R Duncan. *Types for Quantum Computation*. PhD thesis, Oxford University. Forthcoming.
- [JSV96] A. Joyal, R. Street, and D. Verity. Traced monoidal categories. *Math. Proc. Camb. Phil. Soc.*, 119:447–468, 1996.
- [KL80] G.M. Kelly and M.L. Laplaza. Coherence for compact closed categories. *Journal of Pure and Applied Algebra*, 19:193–213, 1980.
- [Mit65] B. Mitchell. *Theory of Categories*. Academic Press, 1965.
- [ML97] S. Mac Lane. *Categories for the Working Mathematician (2nd Ed.)*. Springer-Verlag, 1997.
- [Shi96] M. Shirahata. A sequent calculus for compact closed categories, 1996.
- [Sol87] S. V. Soloviev. On natural transformations of distinguished functors and their superpositions in certain closed categories. *Journal of Pure and Applied Algebra*, 47, 1987.
- [ZZHE93] M. Zukowski, A. Zeilinger, M. A. Horne, and A. K. Ekert. Event ready detectors bell experiment via entanglement swapping. *Phys. Rev. Lett.*, 71(26):4287, 4290 1993.

A Proof of full completeness

Firstly, we remark that there is a well-known description of the free construction BC of a category with finite biproducts generated by a category \mathcal{C} (for which see e.g. [ML97]). The objects of BC are finite tuples of objects of \mathcal{C} , written $\bigoplus_{i=1}^n A_i$; morphisms $\bigoplus_{i=1}^n A_i \rightarrow \bigoplus_{j=1}^m B_j$ are $n \times m$ matrices whose components are finite multisets of arrows $A_i \rightarrow B_j$, *i.e.* elements of the free Abelian monoid generated by $\mathcal{C}(A_i, B_j)$. Composition is by “matrix multiplication”, with the composition of \mathcal{C} bilinearly extended to multisets. This construction, as is also well-known, extends to the construction of free *distributive biproducts* over monoidal categories, with the tensor defined on BC by distributivity:

$$\left(\bigoplus_{i=1}^n A_i\right) \otimes \left(\bigoplus_{j=1}^m B_j\right) = \bigoplus_{i,j} A_i \otimes B_j.$$

The following is a straightforward extension of this standard result:

Proposition 23. *The matrix construction lifts to strongly compact closed categories.*

Proof. The adjoint of a matrix (m_{ij}) is (m_{ji}^\dagger) , where the adjoint of the generating strongly compact closed category is applied pointwise to the multiset m_{ji} . The unit for $\bigoplus_{i=1}^n A_i$ is the diagonal matrix with diagonal elements $\{\eta_{A_i}\}$. \square

This yields a factorization of the adjunction

$$\text{InvCat} \begin{array}{c} \xrightarrow{F} \\ \perp \\ \xleftarrow{U} \end{array} \text{SCCCB}$$

as $F = B \circ F_{\text{SCC}}$:

$$\text{InvCat} \begin{array}{c} \xrightarrow{F_{\text{SCC}}} \\ \perp \\ \xleftarrow{U_{\text{SCC}}} \end{array} \text{SCCC} \begin{array}{c} \xrightarrow{B} \\ \perp \\ \xleftarrow{U_{\text{SCCB}}} \end{array} \text{SCCCB}.$$

This factorization underlies the structure of the following argument. One particular consequence we shall use is the following:

Proposition 24. $F_{\text{SCC}}(\mathcal{C})$ embeds faithfully in $F(\mathcal{C})$.

We will refer to the objects of \mathcal{A} , their images under $(\cdot)^*$ and the constants $\mathbf{0}$ and I as the *literals* of $F\mathcal{A}$. Since $F\mathcal{A}$ is freely generated, its objects are formed from the literals by repeated application of the functors $(- \otimes -)$ and $(- \oplus -)$. Hence any object may be described by such a functor and a vector of literals. For the rest of the section, it will be understood that by functor we refer only to those constructed from tensors and biproducts². Let $\otimes_n : F\mathcal{A} \times \cdots \times F\mathcal{A} \rightarrow F\mathcal{A}$

²Soloviev has treated the natural transformations of such functors in detail [Sol87], but here we are only interested in one particular case.

be the n -fold tensor; similarly let \oplus_n be the n -fold biproduct. Call N a *normal* functor if it is has the form

$$N = \oplus_n(\otimes_{m_1}(-), \dots, \otimes_{m_n}(-)).$$

Lemma 25. *Every functor G is naturally isomorphic to a normal functor N_G .*

Sketch proof. Use induction on the structure of G ; the required isomorphism is constructed from the distributivity $A \otimes (B \oplus C) \cong (A \otimes B) \oplus (A \otimes C)$. \square

Long proof. We construct N_G and a natural isomorphism d_G simultaneously, by recursion on the structure of G . There are two principal cases.

If $G = G_1(-) \oplus G_2(-)$ then, by induction, we have natural isomorphisms $d_1 : G_1 \Rightarrow N_{G_1}$ and $d_2 : G_2 \Rightarrow N_{G_2}$. Then $N_{G_1} \oplus N_{G_2}$ is a normal functor, and $d_1 \oplus d_2$ is the required natural isomorphism.

If $G = G_1(-) \otimes G_2(-)$ then we have natural isomorphisms $d_1 : G_1 \Rightarrow N_{G_1}$ and $d_2 : G_2 \Rightarrow N_{G_2}$. Since N_{G_1} is normal it has the form $\bigoplus_i A_i$, where each A_i is multi-ary tensor product; similarly $N_{G_2} = \bigoplus_j B_j$. Hence we have a natural isomorphism

$$d = \langle \langle \pi_i \otimes 1 \rangle_i \otimes \pi_j \rangle_j : N_{G_1} \otimes N_{G_2} \Rightarrow \bigoplus_{ij} A_i \otimes B_j$$

to a normal functor, which we take to be N_G . The composition $d \circ (d_1 \otimes d_2)$ is the required map $G \Rightarrow N_G$. \square

Lemma 26. *Let N_F, N_G be normal functors. For each arrow $f : N_F \bar{A} \rightarrow N_G \bar{B}$ there exist maps g, h, f_1, \dots, f_n such that*

$$\begin{array}{ccc} N_F \bar{A} & \xrightarrow{f} & N_G \bar{B} \\ g \downarrow & & \uparrow h \\ \bigoplus_i A_i & \xrightarrow{\bigoplus_i f_i} & \bigoplus_i B_j \end{array}$$

commutes, where the A_i, B_j are multi-ary tensors of literals.

Proof. We will construct the required maps by recursion on the structure of f . There are three cases.

Case 1. Suppose $A = A_1 \oplus A_2$, and $B = B_1 \oplus B_2$. Then f has a matrix representation $\begin{pmatrix} f_1 & f_2 \\ f_3 & f_4 \end{pmatrix}$. We reconstruct f as

$$\begin{array}{ccc}
A_1 \oplus A_2 & \xrightarrow{f} & B_1 \oplus B_2 \\
\Delta_{A_1} \oplus \Delta_{A_2} \downarrow & & \uparrow \nabla_{B_1 \oplus B_2} \\
A_1 \oplus A_1 \oplus A_2 \oplus A_2 & \xrightarrow{f_1 \oplus f_2 \oplus f_3 \oplus f_4} & B_1 \oplus B_2 \oplus B_1 \oplus B_2
\end{array}$$

and recurse on each f_i .

Case 2. Suppose that $A = A_1 \oplus A_2$, but B is not a biproduct of two other objects. Since the biproduct structure is freely constructed it is guaranteed that $f = [f_1, f_2] : A_1 \oplus A_2 \rightarrow B$. This is reconstructed as

$$A_1 \oplus A_2 \xrightarrow{f_1 \oplus f_2} B \oplus B \xrightarrow{\nabla_B} B.$$

Case 3. If $B = B_1 \oplus B_2$ but A is not a biproduct the treatment is dual to that of case 2. \square

Now consider the f_i constructed above. Each one has the form

$$f_i : \otimes_n \overline{A} \rightarrow \otimes_m \overline{B}.$$

Suppose that $\mathbf{0}$ is a component of \overline{A} . In that case $\otimes_n \overline{A} = \mathbf{0}$ and hence f_i is completely determined; a similar situation applies to \overline{B} . Let us suppose then, that $\mathbf{0}$ does not occur in either \overline{A} or \overline{B} .

Since the hom sets of $F\mathcal{A}$ form a (freely generated) commutative monoid, f is a finite sum of non-zero arrows, $f_i = \sum_j f_{ij}$, or else is zero itself. Furthermore, every f_{ij} must be an arrow of the subcategory $F_{\text{SCC}}\mathcal{A}$, that is the free strongly compact closed category upon \mathcal{A} . (Here we are relying on Proposition 24). At this point we appeal to a theorem of [KL80, Abr05]:

Theorem. *Each arrow $f : A \rightarrow B$ of the free (strongly) compact closed category on a category \mathcal{A} is completely described by the following data:*

1. An involution θ on the atoms of $A^* \otimes B$;
2. A functor $p : \theta \rightarrow \mathcal{A}$ agreeing with θ on objects (i.e. a labelling of θ with arrows of \mathcal{A});
3. A multiset L of loops from \mathcal{A} .

Lemma 27. *Suppose that \mathcal{A} has an identity on objects, contravariant, involutive functor $()^\dagger$. Then $F_{\text{SCC}}\mathcal{A}$ is strongly compact closed.*

Proof. It suffices to show how to extend $()^\dagger$ to $F_{\text{SCC}}\mathcal{A}$. Using the description of morphisms in $F_{\text{SCC}}\mathcal{A}$ given in the previous theorem, we define

$$(\theta, p, L)^\dagger = (\theta^{-1}, ()^\dagger \circ p \circ ()^{-1}, L^\dagger).$$

□

Lemma 28. *For each arrow f in $F_{\text{SCC}}\mathcal{A}$ there is a proof-net ν such that $\llbracket \nu \rrbracket = \ulcorner f \urcorner$.*

Proof. By Kelly-Laplaza $f \approx (\theta, p, L)$. The involution θ specifies the axiom links, labelled as per the functor p . We add tensor links to join up all the conclusions which are subformulae of A , and likewise B . For each loop $h : A \rightarrow A$ in L , an h -axiom link is added; the loop is closed up with an identity cut. Since $\ulcorner s \bullet f \urcorner = s \bullet \ulcorner f \urcorner$ this suffices. □

Lemma 29. *Given $f_1 : X_1 \rightarrow Y_1$ and $f_2 : X_2 \rightarrow Y_2$, if there exist proof-nets π_1, π_2 such that $\llbracket \pi_1 \rrbracket = \ulcorner f_1 \urcorner$ and $\llbracket \pi_2 \rrbracket = \ulcorner f_2 \urcorner$ then there exists π such that $\llbracket \pi \rrbracket = \ulcorner f_1 \oplus f_2 \urcorner$.*

Proof. First note that

$$f_1 \oplus f_2 = (q_1 \circ f_1 \circ p_1) + (q_2 \circ f_2 \circ p_2),$$

where p_i, q_j are the biproduct projections and injections. Hence

$$\begin{aligned} \ulcorner f_1 \oplus f_2 \urcorner &= (1_{X_1^* \oplus X_2^*} \otimes ((q_1 \circ f_1 \circ p_1) + (q_2 \circ f_2 \circ p_2))) \circ \eta_{X_1 \oplus X_2} \\ &= ((1_{X_1^* \oplus X_2^*} \otimes (q_1 \circ f_1 \circ p_1)) \circ \eta_{X_1 \oplus X_2}) + ((1_{X_1^* \oplus X_2^*} \otimes (q_2 \circ f_2 \circ p_2)) \circ \eta_{X_1 \oplus X_2}) \\ &= ((p_1^* \otimes (q_1 \circ f_1)) \circ \eta_{X_1}) + ((p_2^* \otimes (q_2 \circ f_2)) \circ \eta_{X_2}) \\ &= ((p_1^* \otimes (q_1 \circ f_1)) \circ \eta_{X_1}) + ((p_2^* \otimes (q_2 \circ f_2)) \circ \eta_{X_2}) \\ &= ((q_1 \otimes q_1) \circ (1_{X_1^*} \otimes f_1) \circ \eta_{X_1}) + ((q_2 \otimes q_2) \circ (1_{X_2^*} \otimes f_2) \circ \eta_{X_2}) \\ &= ((q_1 \otimes q_1) \circ \ulcorner f_1 \urcorner) + ((q_2 \otimes q_2) \circ \ulcorner f_2 \urcorner). \\ &= ((q_1 \otimes q_1) \circ \llbracket \pi_1 \rrbracket) + ((q_2 \otimes q_2) \circ \llbracket \pi_2 \rrbracket). \end{aligned}$$

If π_1 has slices s_i then

$$(q_1 \otimes q_1) \circ \llbracket \pi_1 \rrbracket = (q_1 \otimes q_1) \circ \sum_i \llbracket s_i \rrbracket = \sum_i (q_1 \otimes q_1) \circ \llbracket s_i \rrbracket.$$

hence we require a slice s'_i such that $\llbracket s'_i \rrbracket = (q_1 \otimes q_1) \circ \llbracket s_i \rrbracket$. We assume that s_i has conclusions X_1^* and Y_1 ; if it does not, then necessarily its conclusions differ from this only by the arrangement of the tensor links, and since these have no impact on the denotation we can rearrange them as needed. Then the required slice is shown in Fig. 3. The required proof-net π is formed by combining all the s'_i into a single proof-net, along with similarly constructed slices for f_2 . By its construction we have $\llbracket \pi \rrbracket = \ulcorner f_1 \oplus f_2 \urcorner$. □

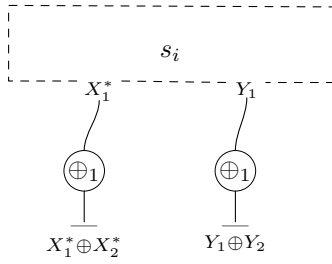

Figure 3: Proof-net for lemma 29
