

Bounds on localisable information via semidefinite programming

Barbara Synak⁽¹⁾, Karol Horodecki⁽²⁾, Michał Horodecki⁽¹⁾

⁽¹⁾*Institute of Theoretical Physics and Astrophysics, University of Gdańsk, Poland and*

⁽²⁾*Department of Mathematics, Physics and Computer Science University of Gdańsk, Poland*

We investigate so-called *localisable information* of bipartite states and a parallel notion of *information deficit*. Localisable information is defined as the amount of information that can be concentrated by means of classical communication and local operations where only maximally mixed states can be added for free. The information deficit is defined as difference between total information contents of the state and localisable information. We consider a larger class of operations: the so called PPT operations, which in addition preserve maximally mixed state (PPT-PMM operations). We formulate the related optimization problem as semidefinite program with suitable constraints. We then provide bound for fidelity of transition of a given state into product pure state on Hilbert space of dimension d . This allows to obtain general upper bound for localisable information (and also for information deficit). We calculated the bounds exactly for Werner states and isotropic states in any dimension. Surprisingly it turns out that related bounds for information deficit are equal to relative entropy of entanglement (in the case of Werner states - regularized one). We compare the upper bounds with lower bounds based on simple protocol of localisation of information.

I. INTRODUCTION

In recent development [1, 2] an idea of *localizing information (or concentrating)* in paradigm of distant laboratories was devised. It originated from the concept of drawing thermodynamical work from heat bath and a source of negentropy (see e.g. [3, 4]). Namely, using one qubit in pure state, one can draw $kT \ln 2$ of work [5] from heat bath of temperature T . More generally, using n qubit state ρ one can draw $n - S(\rho)$ of work. (We neglect the obvious factor $\ln kT$, counting work in bits). In [1] this idea was applied to the distant labs paradigm. There are distant parties, who share some n qubit quantum state, and have local heat baths of temperature T . If the parties can communicate quantum information, then they can use the shared state to draw $n - S(\rho)$ bits work. This can be achieved, by sending the whole subsystem to one party. The party can then draw work from local heat bath by use of the total state. However, if they can only use local operations and classical communication (LOCC), then they usually will not be able to draw such amount of work. Indeed, if they try to send all subsystems to one party, the state will be decohered, due to transmission via classical channel. Thus all quantum correlations will disappear, which will result in increase of entropy of the state to some value $S' > S$. Thus we will observe a difference between total information $n - S$ and information localisable by LOCC. The difference is called *quantum deficit* and denoted by Δ . Since it represents the information that must be destroyed during travel through classical channel, it reports quantumness of correlations of a state. In this way tracing what is local, we can also understand what is non-local.

The basic problem arises: *Given a quantum compound state, how much information can be localized by LOCC?* Or, equivalently, *How large is quantum deficit for a given state?* For pure state the answer is known [2]: the amount of information that cannot be localized is precisely entanglement of formation of the state [6], given by entropy of subsystem. However, for mixed states even separable states can have nonzero deficit. Thus the deficit can account for quantumness that is not covered by entanglement. One could also expect that deficit is the measure of all quantumness of correlations, so that reasonable entanglement measures should not exceed it. In any case, it is important to evaluate deficit for different states.

In [7] the problem of localising information into subsystem was translated into a problem of distilling pure local states. In this paper, basing on this concept, we provide general upper bound for the localisable information, which gives in turn lower bound for information deficit. We calculate the bound for symmetric states, like Werner states [8] and isotropic states [9]. We use method of semidefinite programming following Rains approach to the problem of entanglement distillation [10]. Though our problem is quite opposite: instead of singlets, we want to draw pure product states, the technique can be still applied, and the bounds we obtain share some features of Rains bound for distillable entanglement. Even more surprisingly, the bounds for information deficit obtained for Werner and isotropic states are just *equal* to Rains bounds for those states, which in turn are equal to relative entropy of entanglement (regularized in the case of Werner states). We also present lower bounds, obtained by some specific protocols of localizing information.

II. DEFINITIONS

In this section we will set some definitions. A quantum operation is completely positive trace preserving (CPTP) map. In entanglement theory one distinguishes among others LOCC operations [6](local operations and classical communication) - these are operations that can be applied to a state of compound system by using any local measurements, local operations and classical communication. For bipartite systems there is also *PPT* class. There belong operations Λ for which $\Gamma\Lambda\Gamma$ is still an legitimate operation (where partial transpose Γ is given by $\Gamma = I \otimes T$, with T being matrix transposition).

If we are interested in localizing information, we have to find a way to count the information. In the above classes, one can add pure local states for free. Thus we have to restrict the classes, to be able to trace the information flow. Consequently, following [2], we consider the class NLOCC (noisy LOCC), which differs from original LOCC in one detail: one cannot add arbitrary local ancilla. Only maximally mixed ancillas can be added.

We will also consider operations, which preserves maximally mixed state and are PPT simultaneously. They will be called **PPT-PMM** operations.

One can ask whether adding pure ancillas can help in case when we can control amount of information given by them and subtract it from final result. In [11] it will be shown, that in general, such catalysis is not useful.

In any paradigm of manipulating states by operations the basic notion is *rate of transition*. Given a class of operations, one can ask, at what rate it is possible to transform state ρ into σ , given large n independent copies of ρ ,

$$\rho^{\otimes n} \rightarrow \sigma^{\otimes m} \quad (1)$$

The above means that acting on $\rho^{\otimes n}$ by one of allowed operations, we get some state σ_m that is close to the desired state $\sigma^{\otimes m}$ in trace norm for large n . The optimal rate $R(\rho \rightarrow \sigma)$ is defined as \limsup of $\frac{m}{n}$, where we take limit of large n .

In our case, the target state is local pure state. The localisable information I_l of ρ is the amount of such local pure qubits obtained from ρ per input pair, by NLOCC. Throughout the paper, we will work with converting states into *pairs of qubits*, as this is more convenient. We will use to denote twice rate of transition in specific protocols, as well as, depending on the context, in maximal protocol. Thus given n copies of initial state ρ and m copies of final two qubit pair $|0\rangle|0\rangle$, by r we mean $2m/n$. Sometimes we will write $r_{\mathcal{P}}$ which denotes rate in protocol \mathcal{P} . Optimal r over all protocols is of course I_l .

The information deficit Δ is the difference between total information and localisable information

$$\Delta(\rho) = n - S(\rho) - I_l(\rho) \quad (2)$$

We will also need definitions of entanglement measures.

1. *Entanglement of distillation* [6] E_D is a maximal number of singlets per copy distillable by LOCC operations from the state ρ in asymptotic regime of $n \rightarrow \infty$ copies.
2. *Entanglement cost* E_c is minimal number of singlets per copy needed to create a state ρ by LOCC operations in asymptotic regime of $n \rightarrow \infty$ copies.
3. *Relative entropy of entanglement* E_R is defined as follows:

$$E_R(\rho) = \inf_{\sigma \in SEP} S(\rho|\sigma) \quad (3)$$

where $S(\rho|\sigma) = \text{tr} \rho \log_2 \rho - \text{tr} \rho \log_2 \sigma$ is relative entropy and the infimum is taken over all separable states σ .

4. *Regularized relative entropy of entanglement* E_R^∞ is given by the formula:

$$E_R^\infty(\rho) = \lim_{n \rightarrow \infty} \frac{E(\rho^{\otimes n})}{n} \quad (4)$$

A. Werner and isotropic state

Here we will recall two well known families of states. Let us consider states, which do not change if subjected to the same unitary transformation to both subsystems:

$$\rho = U \otimes U \rho U^\dagger \otimes U^\dagger \quad \text{for any unitary } U \quad (5)$$

Such state (called Werner state) must be of the following form [8]:

$$\varrho_W = \frac{1}{d^2 + d\beta}(I + \beta V), \quad -1 \leq \beta \leq 1 \quad (6)$$

where V a unitary flip operator V on $d \otimes d$ system defined by $V\phi \otimes \varphi = \varphi \otimes \phi$. Other form for ϱ_W is

$$\varrho_W = p \frac{P_A}{N_A} + (1-p) \frac{P_S}{N_S} \quad (7)$$

where $P_S(P_A)$ is projector onto symmetric (antisymmetric) subspace of total space, $N_A = (d^2 - d)/2$ ($N_S = (d^2 + d)/2$) is the dimension of the antisymmetric (symmetric) subspace.

There are states, which are invariant under $U \otimes U^*$ transformation [9]. The state, called isotropic state are of the following form:

$$\varrho_{iso} = \lambda P_+ + \frac{1-\lambda}{d^2} I \quad \lambda \in [-\frac{1}{d}, 1] \quad (8)$$

where P_+ is maximally entangled state and I is the identity state.

III. BOUNDS ON THE FIDELITY OF TRANSITIONS

Given a quantum mixed state ρ one may ask how much of the information it contains which can be concentrated to a local form [1]. In other words how much pairs of a pure *product* states P_{00} one can achieve from ρ per copy of ρ in asymptotic regime under noisy local operations and classical communication (NLOCC) [2]. The class of NLOCC maps is rather difficult to deal with. Then similarly as in entanglement theory, it is more convenient to consider some larger class that has clear mathematical characterization. In [12] a class of PPT maps was introduced which is larger than LOCC. In our case, the analogous larger class will be PPT-PMM maps. If we are able to get upper bound for the rate of distillation of pure product states with this new class it will be also upper bound for rate achievable by NLOCC maps. Our analysis of the rate under PPT-PMM maps, will be analogous to the analysis of distillation of entanglement in [10]. Having fixed the rate of conversion from ρ to P_{00} we evaluate the fidelity of conversion i.e. the overlap of the current output with desired output. If the fidelity can approach 1 in limit of many input copies, the rate is attainable.

Let us then fix the rate r which means, that for n input copies of a given state we will obtain $m = nr/2$ output copies. The m pairs are in a final joint state $\rho' = \Lambda(\rho^{\otimes n})$, where Λ is an operation of conversion. In the following we will assume, that operations of conversion (operations) are PPT-PMM. Then we will maximize the following quantity:

$$F = \text{Tr}[P_{00}^{\otimes m} \Lambda(\rho^{\otimes n})]. \quad (9)$$

The fidelity F is a function of n , since the rate r is fixed. Our general argument will be the following. If for given rate F optimized over such operations is smaller than one, then the rate is not achievable. The smallest such (achievable) rate is the upper bound for the optimal achievable rate, hence for I_L .

Optimization of F will have two stages: first we will change the problem of optimization over Λ to optimization over set of some positive operators Π , which fulfill some (rather complicated) conditions. The optimization over those constraints is an example of so-called semidefinite program. In second stage by duality method used in semidefinite programming we will find the bound on F expressed as infimum over Hermitian operators (without any additional constraints). We will then obtain bounds for localisable information for Werner and isotropic states by choosing appropriate Hermitian operator or by optimizing over a class of Hermitian operators.

It is useful to observe, that since Λ is a CPTP map we have

$$\text{Tr}[P_{00}^{\otimes m} \Lambda(\rho^{\otimes n})] = \text{Tr}[P_{00}^{\otimes m} \sum_i V_i \rho^{\otimes n} V_i^\dagger] = \text{Tr}[\sum_i V_i^\dagger P_{00}^{\otimes m} V_i \rho^{\otimes n}], \quad (10)$$

where V_i are Kraus operators of the map. We used here the fact $\text{Tr}AB = \text{Tr}BA$ for any operators A and B . The map $\sum_i V_i^\dagger(\cdot)V_i \equiv \Lambda^\dagger$ is called dual map (with respect to Λ). It is clearly a CP map too (yet it need not be trace preserving). The meaning of dual maps to NLOCC operations is exhibited in [13]. Here we are interested in the following operator

$$\Pi = \Lambda^\dagger(P_{00}^{\otimes m}). \quad (11)$$

We can write fidelity by means of Π as follows

$$F = \sup_{\Pi} \text{Tr}[\rho^{\otimes n} \Pi] \quad (12)$$

where supremum is taken over all Π of the form (11). Let us now prove the following fact, which amounts to first stage of optimization.

Fact 1 *For given rate r and the number of input copies n of any state $\rho \in \mathcal{C}^d \otimes \mathcal{C}^d$, the optimal fidelity is bounded by*

$$F \leq \sup_{\Pi} \text{Tr}[\Pi(\rho^{\otimes n})], \quad (13)$$

where

$$0 \leq \Pi \leq \text{I}, \quad \Pi^\Gamma \geq 0, \quad \text{Tr}[\Pi] = 2^{n(2 \log d - r)} \equiv K. \quad (14)$$

Proof. We need to show that Π satisfies the displayed constraints. To this end we will need some properties of partial transposition, which we write down here for clarity. Namely for any operators A and B one has

$$\begin{aligned} (\Gamma_1) \quad & \text{Tr} A^\Gamma = \text{Tr} A \\ (\Gamma_2) \quad & \text{Tr} A^\Gamma B = \text{Tr} A B^\Gamma \\ (\Gamma_3) \quad & \text{Tr}(AB) = \text{Tr} A^\Gamma B^\Gamma \\ (\Gamma_4) \quad & (A^\Gamma)^\Gamma = A \\ (\Gamma_5) \quad & \Gamma \text{ preserves hermiticity} \end{aligned} \quad (15)$$

Now, let us first check if the Π defined above operator fulfills the stated constraints. Actually, we will see, that $0 \leq \Pi \leq \text{I}$ is a consequence of the fact that Λ is CPTP map and that $P_{00}^{\otimes m} \leq \text{I}$, and positivity of Π^Γ is a consequence of Λ being PPT map and the fact that $(P_{00}^{\otimes m})^\Gamma \geq 0$. We will use P instead of $P_{00}^{\otimes m}$ for convenient notation.

Positivity of Π is rather clear, since - as it came up - Λ^\dagger is a positive map. Comparing Π with identity is simple, too. For any state σ we have $\sigma \leq \text{I}$, which implies that for any positive operator A

$$\text{Tr}[\Lambda(A)\sigma] \leq \text{Tr}\Lambda(A) = \text{Tr}A, \quad (16)$$

where the equality expresses the fact that Λ is trace preserving. This however is equivalent to the

$$\text{Tr}[A \Lambda^\dagger(\sigma)] \leq \text{Tr}[A \text{I}] \quad (17)$$

which for $\sigma = P$ gives $\Pi \leq \text{I}$. To check positivity of partially transposed Π we need to show, that for any state σ

$$\text{Tr}[\sigma[\Lambda^\dagger(P)]^\Gamma] \geq 0. \quad (18)$$

Applying (Γ_2) one gets

$$\text{Tr}[\sigma^\Gamma \Lambda^\dagger(P)] \geq 0, \quad (19)$$

what by definition of dual map is equivalent to

$$\text{Tr}[\Lambda(\sigma^\Gamma)P] \geq 0. \quad (20)$$

Applying subsequently (Γ_1) and (Γ_3) one ends up with

$$\text{Tr}[(\Gamma\Lambda\Gamma)(\sigma)P^\Gamma] \geq 0, \quad (21)$$

which is true, since both $(\Gamma\Lambda\Gamma)(\sigma)$ and P^Γ are positive operators. First because Λ is a PPT map and second because P is a product state for which Peres separability criterion guarantees positivity of partial transposition.

To prove the last property of Π we use the fact, that Λ is PMM i.e. $\Lambda(\frac{\text{I}}{d_{in}}) = \frac{\text{I}}{d_{out}}$. We then obtain,

$$\text{Tr}\Pi \equiv \text{Tr}\Lambda^\dagger(P)\text{I}_{in} = d_{in} \text{Tr}P\Lambda(\frac{\text{I}_{in}}{d_{in}}) = d_{in} \text{Tr}P\frac{\text{I}}{d_{out}} = \frac{d_{in}}{d_{out}} = K, \quad (22)$$

where $d_{in} = d^{2n}$ and $d_{out} = 2^{2m}$. This ends the proof. ■

Now, in second stage of optimization of the fidelity, we can rearrange our task, using the concept of duality in semidefinite programming. We will need the notion of positive part of operator. For Hermitian operator H positive H_+ and negative H_- parts are defined by $H_+ - H_- = H$ and $H_+ H_- = 0$, i.e. $H_+ = \sum_i \lambda_i^+ |\psi_i^+\rangle\langle\psi_i^+|$, $H_- = \sum_i \lambda_i^- |\psi_i^-\rangle\langle\psi_i^-|$ where λ_i^+ (λ_i^-) are nonnegative (negative) eigenvalues and ψ_i^\pm are corresponding eigenvectors.

Theorem 1 For any state ρ acting on $(\mathcal{C}^d \otimes \mathcal{C}^d)^{\otimes n}$ and a fixed rate r

$$F \leq \inf_D [\text{Tr}(\rho - D)_+ + K \lambda_{\max}(D^\Gamma)] \quad (23)$$

where $\lambda_{\max}(D^\Gamma)$ is the maximal eigenvalue of hermitian operator D^Γ ; and $K = 2^{n(2 \log d - r)}$.

Proof. By just adding and subtracting proper terms which is similar to the Lagrange's multipliers method, using (Γ_2) we can state that for any operators A, B and for any real parameter λ , we have

$$\text{Tr} \Pi \rho = \text{Tr} A - \text{Tr}(-\rho + A - B^\Gamma + \lambda \mathbf{I}) \Pi + \lambda K - \text{Tr} A (\mathbf{I} - \Pi) - \text{Tr} B \Pi^\Gamma + \lambda (\text{Tr} \Pi - K) \quad (24)$$

Now if A and B are positive operators and $A \geq \rho + B^\Gamma - \lambda \mathbf{I}$ we have:

$$\text{Tr} \Pi \rho \leq \text{Tr} A + \lambda K, \quad (25)$$

since absent terms in LHS are non-positive according to the constraints on Π . Then

$$\sup_{\Pi} \text{Tr} \Pi \rho \leq \inf_{A, B, \lambda} \text{Tr} [A + \lambda \frac{K}{d^2} \mathbf{I}] \quad (26)$$

where $A \geq 0$, $B \geq 0$, $A - B^\Gamma + \lambda \mathbf{I} \geq \rho$, $\lambda \in \mathbb{R}$. By introducing new variable $D = \lambda \mathbf{I} - B$ it can be changed into the following form:

$$F \leq \inf_{\substack{A \geq 0, B \geq 0 \\ A \geq \rho - D^\Gamma \\ D = \lambda \mathbf{I} - B, \lambda \in \mathbb{R}}} \text{Tr} [A + \lambda \frac{K}{d^2} \mathbf{I}]. \quad (27)$$

Taking subsequently infimum over D , A and B we obtain

$$F \leq \inf_D \left\{ \inf_{\substack{A \geq 0 \\ A \geq \rho - D^\Gamma}} [\text{Tr} A] + \inf_{\substack{B \geq 0 \\ \lambda \mathbf{I} = D + B, \lambda \in \mathbb{R}}} \left[\lambda \frac{K}{d^2} \right] \right\}, \quad (28)$$

where D (as a combination of positive operators) is a Hermitian operator. Having D fixed one can easily minimize two separate terms over A and B respectively. Concerning the first term, since $A \geq 0$ and $A \geq \rho - D^\Gamma$, the eigenvalues λ_i^A of A must be greater than zero, and greater than the eigenvalues $\lambda_i^{\rho - D^\Gamma}$ of the $\rho - D^\Gamma$ operator. Thus we have $\lambda_i^A = \max(\lambda_i^{\rho - D^\Gamma}, 0)$ which gives:

$$\inf_{\substack{A \geq 0 \\ A \geq \rho - D^\Gamma}} [\text{Tr} A] = \text{Tr}(\rho - D^\Gamma)_+ \quad (29)$$

Turning now to the second term, one can see, that $\lambda \mathbf{I} - D \geq 0$, hence λ must be not less than maximal eigenvalue of D , thus we end up with:

$$\inf_{\substack{B \geq 0 \\ \lambda \mathbf{I} = D + B \\ \lambda \in \mathbb{R}}} \left[\lambda \frac{K}{d^2} \right] = K \lambda_{\max}(D). \quad (30)$$

This leads to the formula

$$F \leq \inf_D \{ \text{Tr}(\rho - D^\Gamma)_+ + K \lambda_{\max}(D) \}. \quad (31)$$

By Γ_4 and Γ_5 any Hermitian operator D is of the form \tilde{D}^Γ , where \tilde{D} is also Hermitian operator, hence we can rewrite the formula in the following way

$$F \leq \inf_D \{ \text{Tr}(\rho - D)_+ + K \lambda_{\max}(D^\Gamma) \}, \quad (32)$$

which ends the proof. ■

The above result, gives us the condition on F with much simpler constraints - we optimize over set of hermitian operators. Analogously, one can prove similar theorem for $\rho \in (\mathcal{C}^{d_1} \otimes \mathcal{C}^{d_2})^{\otimes n}$.

IV. BOUND FOR RATE OF CONCENTRATING INFORMATION

In previous section we showed that the fidelity of concentrating information by NLOCC is bounded by

$$F \leq \inf_D \text{Tr}(\rho^{\otimes n} - D)_+ + 2^{n(2\log_2 d - r)} \lambda_{\max}(D^\Gamma) \quad (33)$$

Starting from this inequality we can find two bounds for the rate r (by PPT-PMM operations) denoted by B_1 and B_2 . The bound B_1 is weaker than B_2 , however we derive it separately, as the proof is more transparent than that for B_2 .

Theorem 2 *For any states ρ*

$$r \leq 2 \log_2 d + \log_2 \lambda_{\max}(|\rho^\Gamma|) \equiv B_1(\rho) \quad (34)$$

Proof. We will show that inequality (34) must be true to make the fidelity converge to 1. Let us take $D = \rho^{\otimes n}$. Then

$$F \leq \limsup_{n \rightarrow \infty} 2^{n(2\log_2 d - r)} \lambda_{\max}((\rho^{\otimes n})^\Gamma) \quad (35)$$

The requirement $F \rightarrow 1$ is equivalent to condition

$$\limsup_{n \rightarrow \infty} n(2 \log_2 d - r) + \log_2 \lambda_{\max}((\rho^{\otimes n})^\Gamma) \rightarrow 0 \quad (36)$$

It implies

$$r \leq 2 \log_2 d + \limsup_{n \rightarrow \infty} \frac{1}{n} \log_2 \lambda_{\max}(\rho^\Gamma)^{\otimes n} \quad (37)$$

Notice that

$$\begin{aligned} \limsup_{n \rightarrow \infty} \frac{1}{n} \log_2 \lambda_{\max}(\rho^\Gamma)^{\otimes n} &= \limsup_{n \rightarrow \infty} \frac{1}{n} \log_2 (\max |\lambda(\rho^\Gamma)|)^n \\ &= \limsup_{n \rightarrow \infty} \log_2 \lambda_{\max}(\rho^\Gamma) = \log_2 \lambda_{\max}(\rho^\Gamma) \end{aligned}$$

Then we have

$$r \leq 2 \log_2 d + \log_2 \lambda_{\max}(|\rho^\Gamma|) \quad (38)$$

This ends the proof.

Theorem 3 *For any states ρ and σ ,*

$$r(\rho) \leq 2 \log_2 d + S(\rho|\sigma) + \log_2 \lambda_{\max}(|\sigma^\Gamma|) \equiv B_2(\rho, \sigma) \quad (39)$$

Remark 1. Notice, that $\lambda_{\max}(|\rho^\Gamma|) = \|\sigma^\Gamma\|_{op}$, where $\|A\|_{op}$ is operator norm. Then the bound can be written as:

$$B_2(\rho, \sigma) = 2 \log_2 d + S(\rho|\sigma) + \log_2 \|\sigma^\Gamma\|_{op} \quad (40)$$

It is interesting to compare this expression this formula with Rains bound for PPT distillable entanglement D :

$$D \leq S(\rho|\sigma) + \log_2 \|\sigma^\Gamma\|_{Tr} \quad (41)$$

Proof. Let $S = S(\rho|\sigma)$ and $L = \log_2 \lambda_{\max}(|\sigma^\Gamma|) = \log_2 \|\sigma^\Gamma\|_{op}$. We will show that if

$$r - 2 \log_2 d \equiv x > S + L \quad (42)$$

then F cannot converge to 1. We have

$$F \leq \text{Tr}(\rho^{\otimes n} - D)_+ + 2^{-nx} \lambda_{\max}(D^\Gamma) \quad (43)$$

Let us take

$$D = 2^{ny} \sigma^{\otimes n} \quad (44)$$

where $S < y < x - L$. (We can find such y , because $x > S + L$)
Notice that

$$2^{-nx} \lambda_{max}[(2^{ny} \sigma^{\otimes n})^\Gamma] \leq 2^{n(y-x+L)} \quad (45)$$

Then

$$F \leq Tr(\varrho^{\otimes n} - 2^{ny} \sigma^{\otimes n})_+ + 2^{n(y-x+L)} \quad (46)$$

$2^{n(y-x+L)}$ converges to 0 because

$$y - x + L < 0 \quad (47)$$

The first term in (46) cannot converge to 1 because $y > S(\varrho|\sigma)$, as shown by Rains [10]. (It follows from quantum Stein lemma, see e.g. [14].) This ends the proof.

Remark 2 To obtain the full strength of bound of Theorem 3, one should optimize the choice of σ . In what follows, we will say that σ is optimal for ϱ if

$$B_2(\varrho, \sigma) = \min_{\sigma'} B_2(\varrho, \sigma') \stackrel{\text{df}}{=} B_2(\varrho) \quad (48)$$

where σ' ranges over all states.

V. RESULTS FOR WERNER AND ISOTROPIC STATE.

In this section we will find bounds for rate for states possessing high symmetry: Werner states and isotropic ones. We will compare bounds B_1 and B_2 with one other.

Let us start with Werner state. We describe our results for Werner state of the form (6). Using Theorem 2 we obtained the following bound:

$$B_1 = \begin{cases} 2 \log_2 d - \log_2(d^2 + d\beta) & \text{for } -\frac{2}{d} < \beta < 0 \\ 2 \log_2 d + \log_2 \left| \frac{1+d\beta}{d^2+d\beta} \right| & \text{for } 0 \leq \beta \leq 1 \quad \text{and} \quad -1 \leq \beta \leq -\frac{2}{d} \end{cases} \quad (49)$$

If we want to find the bound using Theorem 3 we have to optimize $B_2(\varrho, \sigma)$. Luckily, as in [10], it boils down to minimizing only over Werner states. It is due to the following two facts. First, any state ϱ if subjected to random transformation of form $U \otimes U$ (called $U \otimes U$ twirling) becomes Werner state.

$$\int U \otimes U \varrho U^\dagger \otimes U^\dagger dU = \varrho_W \quad (50)$$

Second, value of $B_2(\varrho, \sigma)$ is nonincreasing after twirling operation. Third, $B_2(\varrho, \sigma)$ is convex function, because the quantities S and L possess these properties. Then for any state σ

$$\begin{aligned} B_2(\varrho_W, \sigma) &= \int B_2(\varrho_W, \sigma) dU = \int B_2(U \otimes U \varrho_W U^\dagger \otimes U^\dagger, U \otimes U \sigma U^\dagger \otimes U^\dagger) dU \geq \\ B_2\left(\int U \otimes U \varrho_W U^\dagger \otimes U^\dagger dU, \int U \otimes U \sigma U^\dagger \otimes U^\dagger dU\right) &= B_2(\varrho_W, \int U \otimes U \sigma U^\dagger \otimes U^\dagger dU) = B_2(\varrho_W, \sigma_W) \end{aligned}$$

where σ_W is a Werner state. Thus, we can see that for any state σ we can find such Werner state σ_W , which gives no grater value of B_2 than σ . This fact simplifies our calculation to optimize $B_2(\varrho_W, \sigma)$ on Werner state. Now, we can find the smallest value of $B_2(\varrho_W, \sigma_W)$, where ϱ_W is given by the formula (6) and σ_W is of the following form:

$$\varrho_W = \frac{1}{d^2 + d\alpha} (I + \alpha V), \quad -1 \leq \alpha \leq 1 \quad (51)$$

In this case $B_2(\varrho_W, \sigma)$ is a function of three parameters: d , β and α , where the first two parameters are fixed. So to optimize $B_2(\varrho_W, \sigma)[\alpha]$ it is enough to find a minimum of this function depending on α . This way we obtain the following value of $B_2(\varrho)$:

$$B_2 = \begin{cases} 2 \log_2 d - S(\varrho_W) - \frac{d^2+d}{2} \frac{1+\beta}{d^2+d\beta} \log_2 \frac{d-2}{d} - \frac{d^2-d}{2} \frac{1-\beta}{d^2+d\beta} \log_2 \frac{d+2}{d} & \text{for } -1 \leq \beta < \frac{-3d}{d^2+2} \\ 2 \log_2 d - S(\varrho_W) - \frac{d^2+d}{2} \frac{1+\beta}{d^2+d\beta} \log_2 (1+\alpha) - \frac{d^2-d}{2} \frac{1-\beta}{d^2+d\beta} \log_2 (1-\alpha) & \text{for } \frac{-3d}{d^2+2} \leq \beta < \frac{-1}{d} \\ 2 \log_2 d - S(\varrho_W) & \text{for } \frac{-1}{d} \leq \beta \leq 1 \end{cases} \quad (52)$$

where $\alpha = \frac{1+d\beta}{d+\beta}$. The entropy $S(\varrho_W)$ is given by:

$$S(\varrho_W) = -\frac{d^2-d}{2} \frac{1-\beta}{d^2+d\beta} \log_2 \frac{1-\beta}{d^2+d\beta} - \frac{d^2+d}{2} \frac{1+\beta}{d^2+d\beta} \log_2 \frac{1+\beta}{d^2+d\beta} \quad (53)$$

We have obtained two upper bounds for amount of information, we can localize. Of course B_2 is always not worse than B_1 , so we will consider B_1 only to compare with B_2 . Now, we would like to find a lower bound for I_l . Consider some NLOCC (one-way) protocol \mathcal{P} for concentrating information to local form. The amount of information we can concentrate using \mathcal{P} is a lower bound for I_l . Our protocol \mathcal{P} is following: (i) Alice makes an optimal complete von Neumann measurement represented by $P_i = |i\rangle\langle i|$ on her subsystem. (ii) After that she sends her part to Bob. Alice can do this, because after measurement her part of state is classical-like and classical channel does not destroy it, if we do it adequately, i.e. sometimes before sending we perform some unitary operation to avoid changing the state by the channel. (iii) Bob upon receiving the whole state can extract $2 \log_2 d - S(\varrho'_{AB})$ bits of information, where ϱ'_{AB} is obtained from ϱ_{AB} by Alice's operation (i), (ii).

Lemma V.1 For $d \otimes d$ state ϱ_{AB} with maximally mixed subsystem A by use of the protocol \mathcal{P} , we can concentrate to local form $r_{\vec{\mathcal{P}}}$ information, where $r_{\vec{\mathcal{P}}}$ is described by:

$$r_{\vec{\mathcal{P}}} = \sup_{P_i} (\log_2 d - \sum_i p_i S(\varrho_B^i)) \quad (54)$$

$$\text{where } p_i = \text{tr}(\varrho_{AB} P_i \otimes I) \quad \text{and} \quad \varrho_B^i = \frac{1}{p_i} \text{tr}_A(P_i \otimes I \varrho_{AB} P_i \otimes I)$$

Proof. After sending by Alice her part, Bob possesses the whole state and can extract $2 \log_2 d - S(\varrho'_{AB})$, where $\varrho'_{AB} = \sum_i p_i |i\rangle\langle i| \otimes \varrho_B^i$. The states $|i\rangle$ are orthogonal and it implies that $S(\varrho'_{AB}) = H(p_i) + \sum_i p_i S(\varrho_B^i)$. Shannon entropy $H(p_i)$ is amount to entropy of Alice's part after her measurement. We know, that entropy cannot decrease after measurement but also cannot increase, because is maximal. It implies that $H(p_i) = \log_2 d$. Then we have

$$\begin{aligned} r_{\vec{\mathcal{P}}} &= 2 \log_2 d - S(\varrho'_{AB}) = 2 \log_2 d - (\log_2 d + \sup_{P_i} (\sum_i p_i S(\varrho_B^i))) = \\ &= \log_2 d - \sup_{P_i} (\sum_i p_i S(\varrho_B^i)) \end{aligned}$$

This ends the proof.

For Werner states $r_{\vec{\mathcal{P}}}$ is achieved by any measurement of Alice. It follows from the fact that ϱ_W is $U \otimes U$ invariant. We obtain:

$$r_{\vec{\mathcal{P}}}(\varrho_W) = \log_2 d + \frac{1+\beta}{d+\beta} \log_2(1+\beta) - \log_2(d+\beta) \quad (55)$$

Let us here compare the bounds for amount of localizable information with each other.

Fig. 1 shows lower and upper bounds for rate in comparison to information content of state. For Werner states bound B_2 is much better than B_1 . For separable state B_2 is trivial, it coincides with information contents of state $I = 2 \log_2 d - S(\varrho)$. For entangled states it is better than I .

Looking at Fig. 2 we can see B_2 and $r_{\vec{\mathcal{P}}}$ for some different dimensions of Hilbert space of Werner state. Continuous lines represent bounds for $d=3$, the long dashed lines bounds for $d=4$ and the short dashed for $d=5$.

Now, let us present results for isotropic state. For these states the bound B_1 is given by:

$$B_1 = \begin{cases} \log_2[-\lambda(d+1)+1] & \text{for } \lambda < 0 \\ \log_2[\lambda(d-1)+1] & \text{for } \lambda \geq 0 \end{cases} \quad (56)$$

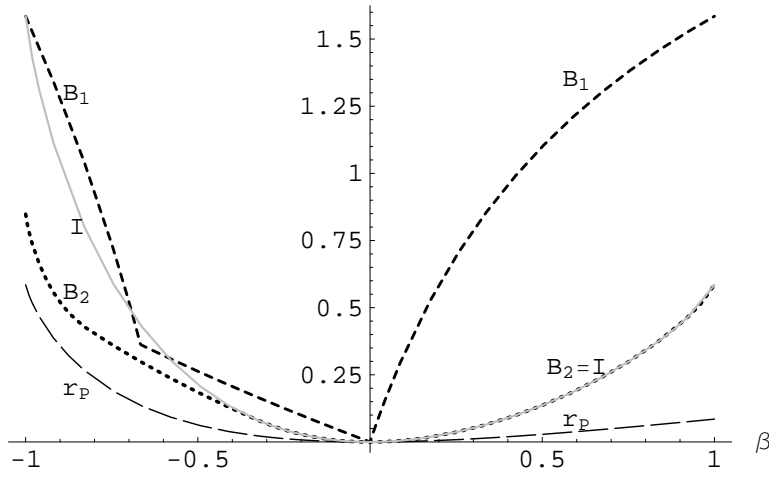

FIG. 1: The dashed lines represent bounds of rate for Werner states ($d=3$) ($r_{\vec{P}} \leq B_2 \leq B_1$) and continuous line represents quantity described by $I = 2 \log_2 d - S(\rho)$. Note that B_2 is equal to information content of state in whole range of separability ($\beta \geq -\frac{1}{3}$)

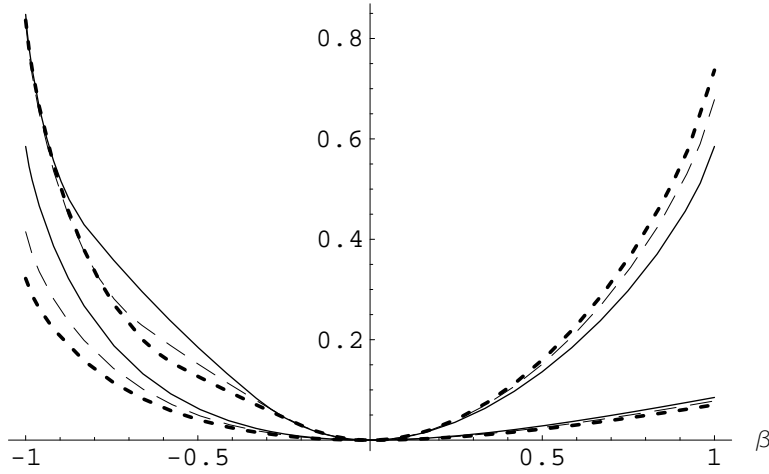

FIG. 2: Upper bound B_2 and lower bound $r_{\vec{P}}$ of rate for Werner states ($d=3,4,5$).

Using the same arguments like for Werner state we can show that if we want to find value of $B_2(\rho_{iso})$ we ought to optimize $B_2(\rho_{iso}, \sigma)$ on isotropic state. Analogously, as in previous case, we can find out that :

$$B_2 = \begin{cases} 2 \log_2 d - S(\rho_{iso}) & \text{for } \frac{-1}{d^2-1} \leq \lambda \leq \frac{1}{d+1} \\ 2 \log_2 d - S(\rho_{iso}) + \log_2 \frac{1+p(d-1)}{1-p} - \frac{1+\lambda(d^2-1)}{d^2} \log_2 \frac{1-p}{1+p(d^2-1)} & \text{for } \frac{1}{d+1} \leq \lambda \leq 1 \end{cases} \quad (57)$$

where $p = \frac{(d+1)\lambda-1}{(1-d^2)(\lambda-1)+d}$. The entropy of isotropic state is given by:

$$S(\rho_{iso}) = -\frac{1+\lambda(d^2-1)}{d^2} \log_2 \frac{1+\lambda(d^2-1)}{d^2} - \frac{(1-\lambda)(d^2-1)}{d^2} \log_2 \frac{1-\lambda}{d^2} \quad (58)$$

Isotropic state possess similar properties like Werner states, so if we want to obtain a value of $r_{\vec{P}}$ we should proceed similarly like for that family of state. Then we have

$$r_{\vec{P}} = \log_2 d + \left(\lambda + \frac{1-\lambda}{d}\right) \log_2 \left(1 + \frac{1-\lambda}{d}\right) \quad (59)$$

For isotropic state the bound B_2 is better again than B_1 and also only for entangled isotropic state the upper bound is nontrivial. The upper and lower bounds agree for P_+ and are obviously equal to $\log_2 d$. The bounds and information

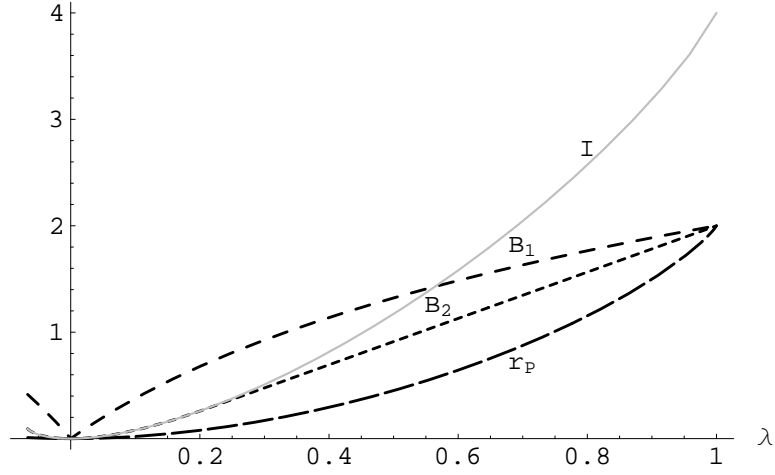

FIG. 3: The dashed lines represent bounds of rate for isotropic states ($d=3$) and continuous line information content of state. Note that B_2 is equal to $I = 2 \log_2 d - S(\varrho)$ for whole range of separability ($\lambda \leq \frac{1}{1+d}$)

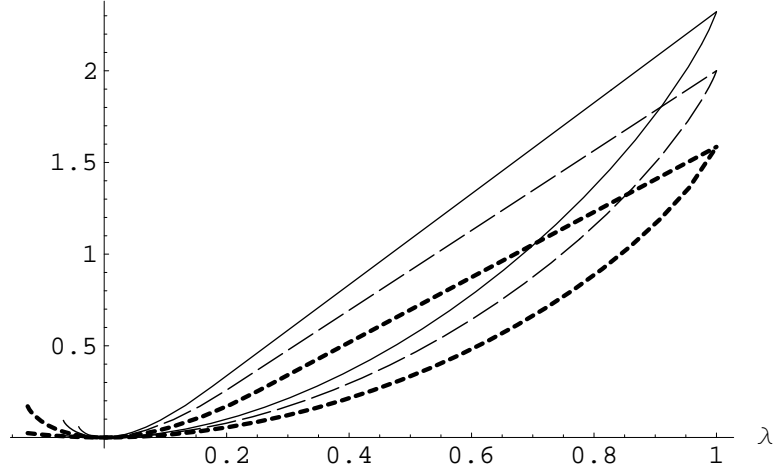

FIG. 4: Upper bound B_2 and lower bound $r_{\vec{P}}$ of rate for isotropic states ($d=3,4,5$).

content are compared on figure (3) for $d=3$. The upper dashed line represent B_2 , the lower $r_{\vec{P}}$. The gray continuous line is a information content of state, i.e. $2 \log_2 d - S(\varrho_{iso})$.

On Figure 4 give us ability to compare quantity B_2 and $r_{\vec{P}}$ for some different dimension ($d=3,4,5$).

VI. COMPARISON QUANTUM DEFICIT WITH MEASURES OF ENTANGLEMENT

As one knows that quantum deficit Δ can be treated as a measure of quantum correlations [1]. Having bound localisable information we can find bounds for Δ . We can do this, because quantum deficit is defined as a difference between total information and information I_l , which can be localized by NLOCC (2) and we know that I_l is bounded by information localisable by using PPT-PMM operation.

We would like to compare quantum deficit with another measure of entanglement, because we suppose that this quantity is more general measure of "quantumness" of state that well-known measure of entanglement.

This way we get lower bound δ_B for Δ :

$$\delta_B(\varrho) = 2 \log_2 d - S(\varrho) - B_2 \quad (60)$$

and upper bound δ_P :

$$\delta_P(\varrho) = 2 \log_2 d - S(\varrho) - r_{\vec{P}} \quad (61)$$

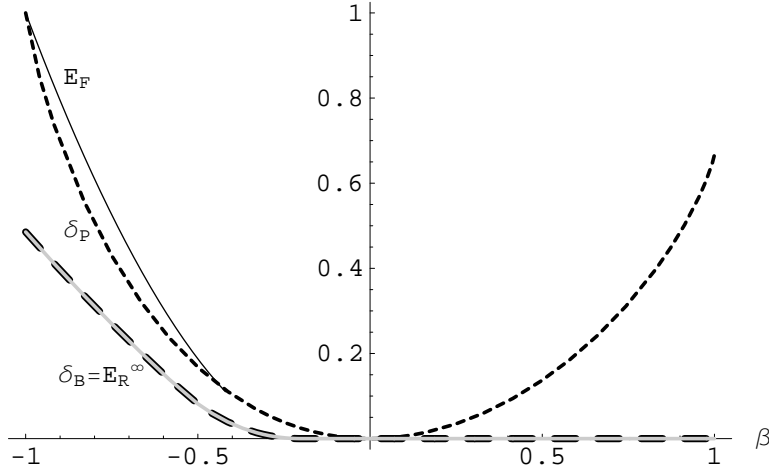

FIG. 5: The dashed lines represent upper and lower bounds of Δ for Werner states ($d=5$), grey continuous regularized relative entropy of entanglement E_R^∞ and black continuous entanglement of formation E_F .

We can compare Δ with known measures of entanglement.

The regularized relative entropy of entanglement E_R^∞ for Werner states is given by [15]:

$$E_R^\infty = \begin{cases} \log_2 \frac{d-2}{d} + \frac{(d-1)(1-\beta)}{2(d+\beta)} \log_2 \frac{d+2}{d-2} & \text{for } -1 \leq \beta \leq -\frac{3d}{d^2+2} \\ 1 + H\left(\frac{(d-1)(1-\beta)}{2(d+\beta)}\right) & \text{for } -\frac{3d}{d^2+2} \leq \beta \leq -\frac{1}{d} \\ 0 & \text{for } -\frac{1}{d} \leq \beta \leq 1 \end{cases} \quad (62)$$

Entanglement of formation is described by the following formula:

$$E_F = \begin{cases} H\left(\frac{1}{2}\left(1 + \sqrt{1 - \left(\frac{1+d\beta}{d+\beta}\right)^2}\right)\right) & \text{for } -1 \leq \beta \leq -\frac{1}{d} \\ 0 & \text{for } -\frac{1}{d} < \beta \leq 1 \end{cases} \quad (63)$$

We can see on Fig. (5) the graphs of δ_B , δ_P , E_F and E_R^∞ for Werner states. We obtain that δ_B and E_R^∞ are equal. For Werner states with $\beta < 0.42$ we have that quantum deficit is not less than entanglement of formation: $\Delta \leq E_F$.

Let us now pass to isotropic states. For entangled ones with parameter $\lambda \in (\frac{1}{d+1}, 1)$ the relative entropy of entanglement E_R is given by:

$$E_R = \log_2 d + f \log_2 f + (1-f) \log_2 \frac{1-f}{d-1} \quad (64)$$

where $f = \frac{(d^2-1)\lambda+1}{d^2}$. For another isotropic states it is surely zero. The formula of entanglement of formation we can find in paper [16]. For nonseparable states it is in form of:

$$E_F(\varrho) = \text{co}(g(\gamma)) \quad (65)$$

$$g(\gamma) = (H_2(\gamma) + (1-\gamma) \log_2(d-1)) \quad (66)$$

where $\gamma = \frac{1}{d^2} \left(\sqrt{d\lambda + \frac{1-\lambda}{d}} + \sqrt{(d-1) \frac{(d^2-1)(1-\lambda)}{d}} \right)^2$ and **co** means a convex hull [16]. On figure (6) we can see graphs of two measure of entanglement and bounds for delta.

We can notice that the graphs of δ_B agree with E_R . Similary as for Werner states we have $\delta_B = E_R$. δ_P is grater than E_F for most isotropic states. (We do not know, if it is true for all isotropic states). For maximally entangled state P_+ all these quantities are equal.

VII. FIDELITY FOR DISTILLATION OF LOCAL PURE STATES AND SINGLET

The well known counterpart of a qubit which represents the unit of local information is ebit - one bit of entanglement, represented by singled state i.e. unit of nonlocal information. It has been stated in [7] that these two forms of

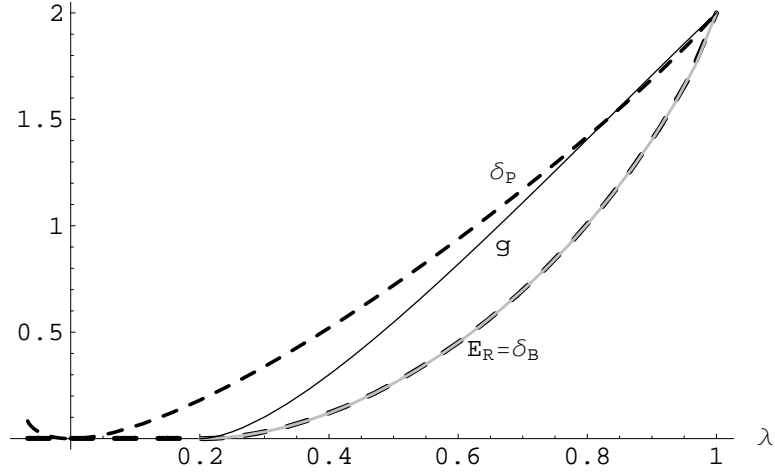

FIG. 6: The dashed lines represent bounds for Δ for isotropic states ($d=3$), grey continuous regularized relative entropy of entanglement E_R and black continuous $g(\gamma)$ (whose convex hull is entanglement of formation E_F).

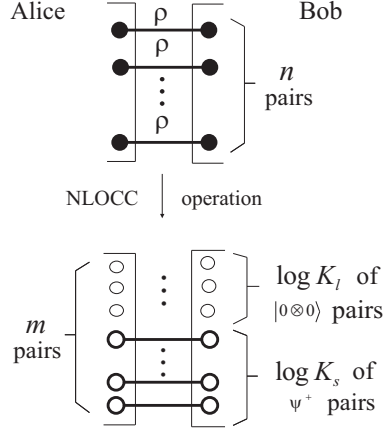

FIG. 7: Scenario of distillation of pure states in their two extremal forms: purely local (product) states and purely nonlocal (maximally entangled) states. The fixed rates of transition gives the proportion of the number of input copies n of state ρ to the numbers of output copies of *local* states ($\log K_l$) and singlet states ($\log K_s$).

information are complementary. If one distills maximal possible amount of one type of information, possibility of gaining the second type disappears. The optimal protocol in case of pure initial state $\psi_{AB}^{\otimes n}$, in which both types are obtained with some ratios, has been also shown there. We will find a bound for the fidelity of such transition, in which both qubits and ebits are drawn in an NLOCC protocol in case of general mixed state $\rho_{AB}^{\otimes n}$. One can view this as a *purity distillation protocol*, because purity in general has two extreme forms: purely local, and purely nonlocal one. This is due to the fact, that any nonproduct pure state, is asymptotically equivalent to the singlet state under the set of NLOCC operations [2]. To this end - as before - we will consider broader class than the NLOCC, namely the class PPT-PMM. This time we have to fix two rates: the one which tell us how many pure local qubits we would like to obtain (r_l), but also how many singlet states (r_s) will be achieved per n copies of input state (see fig. 7).

Namely

$$r_s = \frac{\log K_s}{n}, \quad r_l = \frac{2m - 2 \log K_s}{n} \quad (67)$$

where n is the number of input states, m is the number of qubits which output states occupies (both pure qubits, and singlets together) and $\log K_s$ is the output number of singlet states. We get less than $\frac{2m}{n}$ pure qubits since $\log K_s$ singlets use up $2 \log K_s$ qubits out of $2m$ final. We should maximize the fidelity of transition:

$$F = \text{Tr}[P_+^{\otimes \log K_s} \otimes P_{00}^{\otimes (m - \log K_s)} \Lambda(\rho^{\otimes n})]. \quad (68)$$

where $P_+^{\otimes \log K_s}$ is the projector onto the singlet state on $\mathcal{C}^{K_s} \otimes \mathcal{C}^{K_s}$. Instead of tensor product of singlets and product states, we can equally well consider the output state as the same singlet state embedded in the larger Hilbert space $\mathcal{C}^m \otimes \mathcal{C}^m$. Thus we shall maximize the following quantity:

$$F = \text{Tr}[P_+^{K_s} \Lambda(\rho^{\otimes n})]. \quad (69)$$

where K_s reminds that P_+ is of less dimension than the whole Hilbert space it is embedded in. The rest of the space is occupied by pure local qubits i.e. the second resource drawn in this process.

Consequently we will first consider the fidelity in terms of the $\Pi = \Lambda^\dagger(P_+^{K_s})$ operator where Λ^\dagger is dual (hence CP) to the Λ which is CPTP from assumption.

Analogously as in section III we can obtain the following fact

Fact 2 For given rates r_l, r_s and the number of input copies n , the optimal fidelity is given by

$$F \leq \sup_{\Pi} \text{Tr}[\Pi(\rho^{\otimes n})], \quad (70)$$

where

$$0 \leq \Pi \leq \text{I}, \quad \frac{-\text{I}}{K_s} \leq \Pi^\Gamma \leq \frac{\text{I}}{K_s}, \quad \text{Tr}[\Pi] = 2^{n(2 \log d - r_l - 2r_s)} \equiv K. \quad (71)$$

Passing to dual problem, after some algebra we get

Theorem 4 For any state ρ acting on $(\mathcal{C}^d \otimes \mathcal{C}^d)^{\otimes n}$ and rates r_l and r_s we have

$$F \leq \inf_D \{ \text{Tr}(\rho - D)_+ \} + \inf_{\lambda} \left[\frac{1}{K_s} \text{Tr} |D^\Gamma - \lambda \text{I}| + \lambda K \right] \quad (72)$$

where infimum are taken over all hermitian operators D and all real numbers λ respectively; $K = 2^{n(2 \log d - r_l - 2r_s)}$ and $K_s = 2^{nr_s}$.

It is not easy to obtain nontrivial results. Suppose that we want to apply analogous ideas to those applied in section (IV). Let us rewrite fidelity as follows (for some fixed D ,

$$F \leq \text{Tr}(\rho^{\otimes n} - D) + 2^{-nr_s} \text{Tr} |D^\Gamma - \lambda \text{I}| + \lambda 2^{n(2 \log d - r_l)} \quad (73)$$

The simplest approach would be to force first terms to vanish, and to try to put $D = \rho^{\otimes n}$. However, even by this simplification it is very difficult to find any bound for rates.

Yet, there are also "higher level" problems. Namely the main problem within the connection between distillation of entanglement and the paradigm of localising information, is whether distillation process consume local information [17]. It seems that our class of operations cannot feel this problem at all. Indeed, it is likely, that any distillation process is a map that preserve maximally mixed state [18]. Thus one should perhaps improve the approach, by imposing more stringent constraints on class of operations. This is because for initial maximally mixed state, we impose only final maximally mixed state. However generically, final dimension is smaller than initial one. This means that some tracing out must take place, and we do not require the state that was traced out must be maximally mixed. Thus in our class, pure ancillas can be added, under the condition that they are finally traced out.

VIII. DISCUSSION

In this paper we have investigated *localisable information* and associated *information deficit* of quantum bipartite states. We used the fact, that localisable information can be defined as the amount of pure local qubits (per input copy) that can be distilled by use of classical communication and local operations that do not allow adding local ancilla in non-maximally mixed state. We considered a larger class of operations which we called PPT-PMM operations. They are those PPT operations which preserve maximally mixed state. Then we managed to formulate the problem of distillation of pure product qubits in terms of semidefinite program. Using duality concept in semidefinite programming we have found bound for fidelity of transition given state into pure product ones by PPT-PMM operations. In this way we obtained a general upper bound for amount of localisable information of arbitrary state. The bound was denoted B_2 (we also obtained a simpler, but weaker bound B_1). It gives bound δ_B for information deficit. We were able to evaluate exactly the value of the bound B_2 for states exhibiting high symmetry - Werner states and isotropic states. Quite surprisingly, the obtained related lower bound δ_B for information deficit turned out to coincide with

relative entropy of entanglement in the case of isotropic states, and with regularized relative entropy of entanglement for Werner states. In other words: in those two cases, our bound for information deficit, turned out to be equal to Rains bound for distillable entanglement. We also analysed a simple lower bound r_P for localisable information, and a parallel upper bound δ_P for information deficit. We compared the latter bound with entanglement of formation. In particular we obtained that for Werner states ($d = 3$), in entangled region it is strictly smaller than entanglement of formation. If one believes that information deficit is a measure of total quantumness of correlations, the conclusion would be that E_F does not describe the entanglement present in state. Rather it includes also the entanglement that got dissipated during formation of the state. Finally, we also discussed possibility of application of our approach to the problem of simultaneous distillation of singlets and pure local states. We provided bound for fidelity in this case. However it is likely, that the chosen class of operations is too large to describe information consumption in the process of distillation of entanglement. We believe that our results will stimulate further research towards evaluating localisable information and information deficit. An important open question is also the connection between information deficit and entanglement measures. In particular, it is intriguing, how general is the equality of our lower bound for deficit, and E_r - upper bound for distillable entanglement.

Acknowledgments: We thank Paweł Horodecki, Ryszard Horodecki and Jonathan Oppenheim for helpful discussion. This work is supported by EU grants RESQ, Contract No. IST-2001-37559 and QUPRODIS, Contract No. IST-2001-38877 and by the Polish Ministry of Scientific Research and Information Technology under the (solicited) grant No. PBZ-MIN-008/ P03/ 2003.

-
- [1] J. Oppenheim, M. Horodecki, P. Horodecki, and R. Horodecki, Phys. Rev. Lett **89**, 180402 (2002), quant-ph/0112074.
 - [2] M. Horodecki, K.Horodecki, P.Horodecki, R. Horodecki, J. Oppenheim, A. Sen(De), and U. Sen, Phys. Rev. Lett. **90**, 100402 (2003), quant-ph/0207168.
 - [3] M. O. Scully, Phys. Rev. Lett **87**, 220601 (2001).
 - [4] V. Vedral, quant-ph/9903049.
 - [5] R. Alicki, M. Horodecki, P. Horodecki, and R. Horodecki, quant-ph/0402012.
 - [6] C. H. Bennett, D. P. DiVincenzo, and J. S. W. K. Wootters, Phys. Rev. A **54**, 3824 (1997), quant-ph/9604024.
 - [7] J. Oppenheim, K. Horodecki, M. Horodecki, P. Horodecki, and R. Horodecki (2002), quant-ph/0207025.
 - [8] R. Werner, Phys. Rev. A **40**, 4277 (1989).
 - [9] M. Horodecki and P. Horodecki, Phys. Rev. A **59**, 4206 (1999), quant-ph/9708015.
 - [10] E. Rains (2000), quant-ph/0008047.
 - [11] M.Horodecki, P.Horodecki, R.Horodecki,J.Oppenheim, A.Sen(De), U.Sen and B. Synak-In preparation.
 - [12] E. Rains, Phys. Rev. A **60**, 179 (1999), quant-ph/9809082.
 - [13] M. Horodecki, P. Horodecki, and J. Oppenheim (2003), quant-ph/0302139.
 - [14] T. Ogawa and M. Hayashi, quant-ph/0110125.
 - [15] K. Audenaert, J. Eisert, E. Jane, M. Plenio, S. Virmani, and B. D. Moor, Phys. Rev. Lett. p. 217902 (2001).
 - [16] K.G.H.Vollbrecht and R.F.Werner, Phys. Rev. A **64**, 0623074 (2001), quant-ph/0010095.
 - [17] J. Oppenheim, M. Horodecki, and R. Horodecki, Phys. Rev. Lett **90**, 010404 (2003), quant-ph/0207169.
 - [18] We found this in discussion with J. Oppenheim.