

# Quantum freeze of fidelity decay for a class of integrable dynamics

Tomaz Prosen and Marko Žnidarič

Physics Department, Faculty of Mathematics and Physics, University of Ljubljana, Ljubljana, Slovenia

E-mail: [prosen@fiz.uni-lj.si](mailto:prosen@fiz.uni-lj.si), [znidaricm@fiz.uni-lj.si](mailto:znidaricm@fiz.uni-lj.si)

**Abstract.** We discuss quantum fidelity decay of classically regular dynamics, in particular for an important special case of a vanishing time averaged perturbation operator, *i.e.* vanishing expectation values of the perturbation in the eigenbasis of unperturbed dynamics. A complete semiclassical picture of this situation is derived in which we show that the quantum fidelity of *individual coherent initial states* exhibits three different regimes in time: (i) first it follows the corresponding classical fidelity up to time  $t_1 \sim \hbar^{-1/2}$ , (ii) then it freezes on a plateau of constant value, (iii) and after a time scale  $t_2 \sim \min\{\hbar^{1/2}\delta^{-2}, \hbar^{-1/2}\delta^{-1}\}$  it exhibits fast ballistic decay as  $\exp(-\text{const}\delta^4 t^2/\hbar)$  where  $\delta$  is a strength of perturbation. All the constants are computed in terms of classical dynamics for sufficiently small effective value  $\hbar$  of the Planck constant. A similar picture is worked out also for general initial states, and specifically for random initial states, where  $t_1 \sim 1$ , and  $t_2 \sim \delta^{-1}$ . This prolonged stability of quantum dynamics in the case of a vanishing time averaged perturbation could prove to be useful in designing quantum devices. Theoretical results are verified by numerical experiments on the quantized integrable top.

Submitted to: *New J. Phys.*

PACS numbers: 03.65.Yz, 03.65.Sq, 05.45.Mt

## 1. Introduction

Squared modulus of the overlap between a pair of time evolving quantum states propagated by two slightly different Hamiltonians, known as the fidelity or the quantum Loschmidt echo, has recently attracted a lot of attention [1, 2, 3, 4, 5, 6, 7]. In addition to numerous numerical simulations, several theoretical results have been proposed to describe the fidelity decay in relation to the nature of the (corresponding classical) dynamics. Jalabert and Pastawski [2] have related fidelity decay for coherent initial states at very short times, namely below or around the Ehrenfest time  $\propto \log \hbar$ , to the classical phase space stretching rate as characterized by the Lyapunov exponents. In more general situations, and in particular for longer time scales, fidelity decay has been

related to the integrated time correlation function of the perturbation through a kind of fluctuation-dissipation relationship [4, 5, 6].

In a recent paper [6] we have developed a general theory of fidelity decay based on a semiclassical treatment of this fluctuation-dissipation formula. It turns out that if the corresponding classical dynamics is fully chaotic then the decay of fidelity is, after a short  $\sim \log \hbar$  (Ehrenfest) timescale, independent of the structure of the initial state in accordance with the quantum ergodicity. On the contrary, if the corresponding classical dynamics is regular then the long time asymptotics sensitively depend on the structure of the initial state and range from a *Gaussian* fidelity decay for *coherent initial states* to a *power-law* fidelity decay for *random initial states*. For regular classical dynamics the theory [6] predicts *faster* decay of fidelity on a short time scale  $\propto \delta^{-1}$  ( $\delta$  = strength of the perturbation), as the time correlation function of the perturbation observable does not decay, *compared* to the chaotic classical dynamics where the decay time scale is longer  $\propto \delta^{-2}$ , and is longer the faster the decay of correlations we have. However, the fast — ballistic decay of fidelity in the case of regular classical dynamics described by the theory [6] does not happen in one special but important case, namely when the time average of the perturbation (*i.e.* the observable which perturbs the Hamiltonian) vanishes. Classically, this means that the perturbation does not change the frequencies of the invariant (KAM) tori in the leading order in  $\delta$ , at least in the phase space region of interest.

Such a case of regular classical dynamics with vanishing time-averaged perturbation is the subject of the present paper. Though this is not a generic case for a sufficiently large class of perturbations, it may emerge naturally if the system and the perturbation possess appropriate discrete or continuous symmetries. We will discuss general initial states, and specifically also coherent and random initial states. We find a very surprising result, namely that the quantum fidelity, after decaying for a short time (e.g. following the classical fidelity [6, 8, 9] for coherent initial states), *freezes* on a plateau of constant value. This is purely a quantum effect and has no analogue in the classical fidelity. The relative time span of the plateau is of the order of inverse perturbation strength  $1/\delta$  and can be made arbitrary large for small perturbations. However for long times after the plateau ends, the fidelity displays a ballistic decay with the characteristic time scale  $\propto 1/\delta^2$ , *e.g.* Gaussian for coherent initial states and power law  $t^{-d}$  for random initial states where  $d$  is the number of freedoms. This ballistic decay can be explained semiclassically due to perturbative changes of the frequencies of invariant tori in the second order in  $\delta$ . For coherent initial states in one dimension we find and explain another quite surprising general phenomenon, which we call ‘the echo resonance’ where the fidelity displays sudden and significant revivals which can, under certain conditions, come back even to value 1. This happens at particular values of times, which depend on the derivative of the classical frequency with respect to the canonical action and do not depend on  $\delta$ .

Using the formalism of action-angle variables and its semiclassical quantization we derive explicit semiclassical formulae, in the leading order in  $\hbar$ , for the fidelity in all the

regimes. Our results are demonstrated with high precision by numerical experiments using a regular quantum top which is perturbed by periodic kicking. The quantum saturation of fidelity, which is a central result of this paper, may also be of some practical importance as it provides a mechanism for stabilizing the regular quantum dynamics.

In section 2 we define the basic quantities and study the general properties of the so-called *echo operator* whose expectation value gives the fidelity. We propose a useful asymptotic ansatz for the echo operator, which is used later in section 3, in combination with the semiclassical action-angle dynamics, to derive explicit general results on the echo operator and fidelity and to identify different regimes. In section 4 we define a numerical model on which the results for two specific classes of initial states, namely coherent and random states, are later quantitatively validated in sections 5 and 6, respectively. In section 7 we discuss the general picture and summarize the results.

## 2. Quantum mechanics of the echo operator

Let  $H_0$  and  $H_\delta = H_0 + \delta \cdot H'$  denote the *unperturbed* and the *perturbed* Hamiltonian, respectively. In order to cover the even more general case of periodically time-dependent (e.g. kicked) systems, say of period  $\tau$ ,  $H_\delta(\tau' + \tau) = H_\delta(\tau')$ , we utilize our formalism in terms of the Floquet map  $U_\delta = \left[ \hat{\mathcal{T}} \exp(i \int_0^\tau d\tau' H_\delta(\tau')/\hbar) \right]^\dagger$ , where  $\hat{\mathcal{T}}$  denotes *left-to-right* time ordered product. Dynamics is now generated by a discrete group  $U_\delta^t, t \in \mathbb{Z}$ , where an autonomous continuous time flow is approached in the limit  $\tau \rightarrow 0$ . It seems convenient to postulate slightly different but completely general form of a *small* perturbation

$$U_\delta = U_0 \exp(-iV\tau\delta/\hbar) \quad (1)$$

generated by a hermitean operator  $V$  which in the leading order matches  $H'$ ,  $V = H' + \mathcal{O}(\tau\delta)$ . We note that all the results in the paper can be trivially translated to the continuous time case by substituting  $t\tau \rightarrow T$ ,  $\tau \sum_{\nu=0}^{t-1} \rightarrow \int_0^T d\tau'$ .

Starting from the same initial state  $|\psi\rangle$ , the *fidelity* or the *Loschmidt echo*  $F(t)$  is defined as the squared modulus of the overlap between  $U_0^t|\psi\rangle$  and  $U_\delta^t|\psi\rangle$ , namely

$$F(t) = |f(t)|^2, \quad f(t) = \langle \psi | M_\delta(t) | \psi \rangle, \quad (2)$$

where  $f(t)$  is called the *fidelity amplitude* and

$$M_\delta(t) = U_\delta^{-t} U_0^t \quad (3)$$

is the *echo operator*. Equivalently,  $M_\delta(t)$  is the time-ordered propagator generated by the perturbation  $V_t = U_0^{-t} V U_0^t$  in the interaction picture [4, 6]

$$M_\delta(t) = \prod_{\nu=0}^{t-1} \exp\left(i \frac{\tau\delta}{\hbar} V_\nu\right) = \hat{\mathcal{T}} \exp\left(i \frac{\tau\delta}{\hbar} \sum_{\nu=0}^{t-1} V_\nu\right). \quad (4)$$

The essential results on the behaviour of fidelity [6] are then derived from the combination of perturbative and semiclassical considerations of the formula (4). For

example, the essential physics is contained in a linear response approximation which is obtained by expanding (4) to second order in  $\delta$ ,

$$F(t) = 1 - \frac{\tau^2 \delta^2}{\hbar^2} \sum_{t', t''=0}^{t-1} C(t', t'') + \dots, \quad (5)$$

$$C(t', t'') = \langle V_{t'} V_{t''} \rangle - \langle V_{t'} \rangle \langle V_{t''} \rangle, \quad (6)$$

where  $\langle \bullet \rangle := \langle \psi | \bullet | \psi \rangle$  is the expectation value in the initial state  $|\psi\rangle$ . Thus stronger decay of correlations qualitatively enhances the stability of quantum motion [4, 5, 6]. It is useful to rewrite the double-sum on the RHS of linear response formula (5) in terms of the uncertainty of the *integrated perturbation operator*

$$\Sigma_t = \tau \sum_{t'=0}^{t-1} V_{t'}, \quad (7)$$

namely

$$F(t) = 1 - \frac{\delta^2}{\hbar^2} \left\{ \langle \Sigma_t^2 \rangle - \langle \Sigma_t \rangle^2 \right\} + \mathcal{O}(\delta^4). \quad (8)$$

Here we take a slightly different route and apply the Baker-Campbell-Hausdorff (BCH) expansion  $e^A e^B = \exp(A + B + (1/2)[A, B] + \dots)$  to the echo operator (4)

$$\begin{aligned} M_\delta(t) &= \exp \left\{ i \frac{\tau \delta}{\hbar} \sum_{t'=0}^{t-1} V_{t'} - \frac{\tau^2 \delta^2}{2\hbar^2} \sum_{t'=0}^{t-1} \sum_{t''=t'}^{t-1} [V_{t'}, V_{t''}] + \dots \right\} \\ &= \exp \left\{ \frac{i}{\hbar} \left( \Sigma_t \delta + \frac{1}{2} \Gamma_t \delta^2 + \dots \right) \right\} \end{aligned} \quad (9)$$

where  $[A, B] := AB - BA$ , introducing another operator valued series

$$\Gamma_t = \frac{i\tau^2}{\hbar} \sum_{t'=0}^{t-1} \sum_{t''=t'}^{t-1} [V_{t'}, V_{t''}]. \quad (10)$$

Note that for systems with a well defined classical limit the operator  $\Gamma_t$  corresponds to  $\hbar$ -independent classical observable as  $-i/\hbar[\bullet, \bullet]$  corresponds to the classical Poisson bracket. In the ergodic and mixing case, of say classically strongly chaotic dynamics, straightforward expansion of the exponential (4) gives the Fermi-golden-rule [7] exponential decay  $F(t) = \exp(-\kappa t)$  [4, 6] where the argument  $\kappa t$  is precisely the double-sum of correlation function on RHS of (5) for sufficiently long times. However in the opposite case of classically regular (integrable) dynamics, on which we focus in the following sections of this paper, the BCH form (9) will turn out to be particularly useful.

Let us first generally discuss the expression (9) from the point of view of exact unitary quantum dynamics. For a typical observable  $V$ , one can define a nontrivial time-average operator

$$\bar{V} = \lim_{t \rightarrow \infty} \frac{\Sigma_t}{t\tau} = \lim_{t \rightarrow \infty} \frac{1}{t} \sum_{t'=0}^{t-1} V_{t'}, \quad (11)$$

which is by construction an invariant of motion,  $[U_0, \bar{V}] = 0$ . In a generic case of *non-degenerate spectrum* of  $U_0$ , the time average is simply the diagonal part in the eigenbasis  $|n\rangle$  of the unperturbed evolution,  $U_0|n\rangle = e^{-i\varphi_n}|n\rangle$ , namely

$$\bar{V} = \sum_n V_{nn}|n\rangle\langle n|, \quad (12)$$

where  $V_{nm} := \langle n|V|m\rangle$ . In general we split the perturbation into a sum of diagonal and residual part

$$V = \bar{V} + V_{\text{res}}. \quad (13)$$

We say that the observable  $V$  is *residual* if  $V = V_{\text{res}}$ . This corresponds to ergodicity of this specific observable, namely  $\bar{V} = 0$ , meaning that  $V$  has zero diagonal elements, and this is clearly a special (non-generic) situation.‡ In this paper we discuss integrable dynamics and the class of residual perturbations. For non-degenerate eigenphases  $\{\varphi_n\}$  the matrix elements of the second order term (10) in BCH expansion can be straightforwardly calculated in the leading order in  $t$  as

$$\begin{aligned} \frac{\langle n|\Gamma_t|n\rangle}{t\tau} &= \frac{\tau}{\hbar} \sum_{k \neq n} |V_{nk}|^2 \cot\left[\frac{1}{2}(\varphi_k - \varphi_n)\right] + \mathcal{O}(t^{-1}), \\ \frac{\langle n|\Gamma_t|m\rangle}{t\tau} &= \frac{\tau}{\hbar} (V_{nn} - V_{mm})V_{nm} \frac{e^{-i\frac{1}{2}(\varphi_n - \varphi_m)} + e^{-i(\varphi_n - \varphi_m)(\frac{1}{2} - t)}}{2 \sin\left[\frac{1}{2}(\varphi_m - \varphi_n)\right]} + \mathcal{O}(t^{-1}), \quad n \neq m. \end{aligned} \quad (14)$$

Hence we see that, provided the perturbation is residual,  $\bar{V} = 0$ , the limit of *doubly-averaged perturbation* defined as

$$\bar{\bar{V}} = \lim_{t \rightarrow \infty} \frac{\Gamma_t}{t\tau} = \frac{i\tau}{\hbar} \lim_{t \rightarrow \infty} \frac{1}{t} \sum_{t'=0}^{t-1} \sum_{t''=t'}^{t-1} [V_{t'}, V_{t''}] \quad (15)$$

exists and is *diagonal* in the eigenbasis of  $U_0$ :

$$\bar{\bar{V}} = \sum_n \bar{\bar{V}}_{nn}|n\rangle\langle n|, \quad \bar{\bar{V}}_{nn} = \frac{\tau}{\hbar} \sum_{k \neq n} |V_{nk}|^2 \cot\left[\frac{1}{2}(\varphi_k - \varphi_n)\right]. \quad (16)$$

Note that  $\bar{\bar{V}}$  is again an invariant of motion,  $[U_0, \bar{\bar{V}}] = 0$ , and that, unlike for the time average  $\bar{V}$ , its trace always vanishes  $\text{tr} \bar{\bar{V}} = 0$ .

In the *generic* case,  $\bar{V} \neq 0$  is a non-trivial operator. For sufficiently small perturbation the second term in the exponent of RHS of (9) can always be neglected, since its arbitrary (finite) norm grows as  $\propto t\delta^2$  following from  $|\langle n|\Gamma_t|m\rangle| < \text{const} \times t$  [see eq. (14)], in comparison to the first term whose norm grows as  $\propto t\delta$ . For sufficiently long times, *i.e.* longer than the effective convergence time of the limit (11), we can write  $\Sigma_t \rightarrow t\tau\bar{V}$  so the echo operator can be written as  $M_\delta(t) = \exp(i\bar{V}t\tau\delta/\hbar)$  from which useful semiclassical expressions for different types of initial states were derived [6], all showing fidelity decay on an effective time scale  $\propto \delta^{-1}$ . In the specific case of *residual* perturbation,  $\bar{V} = 0$ , the norm of the first term in the exponential on RHS of

‡ We can always choose the perturbation  $V$  to be *traceless*, since subtracting a constant  $V \rightarrow V - \mathbb{1} \text{tr} V / \text{tr} \mathbb{1}$  only changes the phase of the amplitude  $f$  and does not affect the fidelity  $F = |f|^2$ .

(9) does not grow in time, as we shall discuss in the next section, so the second term will dominate for sufficiently long times.

Although residual perturbations are not generic in the entire set of physically admissible perturbations  $V$ , they may nevertheless be of particular interest in cases where one is allowed to shift the entire diagonal part of the matrix  $V_{nm}$  to the unperturbed Hamiltonian matrix, which is diagonal by definition. Also, it is easy to imagine practically or experimentally important situations where vanishing of the diagonal part,  $V_{nn} \equiv 0$ , is required by the *symmetry*. For example, it is obvious that having a unitary symmetry operation  $R$ ,  $R^\dagger R = 1$ , commuting with the unperturbed evolution,  $[R, U_0] = 0$ , and the perturbation  $V$  which has a negative 'parity' with respect to the symmetry operation,  $R^\dagger V R = -V$ , is sufficient to give  $V_{nn} = 0$ .

As the case of generic perturbations has been treated in detail in previous publications [4, 6], we shall from now on entirely concentrate on the residual case  $\bar{V} = 0$ , unless explicitly stated otherwise. In this case we have thus found the following uniform approximation of the echo operator

$$M_\delta(t) = \exp \left\{ \frac{i}{\hbar} \left( \Sigma_t \delta + \frac{1}{2} \bar{V} t \tau \delta^2 \right) \right\}, \quad (17)$$

which is accurate, for sufficiently small  $\delta$ , up to long times at least of the order  $1/\delta^2$ . This is a consequence of the fact, that for  $\bar{V} = 0$  the third-order term in BCH expansion (9) again grows only linearly in time  $\sim t\delta^3$ , and that the fourth-order term cannot grow faster than  $\sim t^2\delta^4$ . The rest of the paper will be dedicated to the semiclassical exploration of the formula (17).

### 3. Semiclassical asymptotics

Since the classical mechanics is assumed to be completely integrable (at least locally, by KAM theorem, in the phase space part of interest) we can write the classical limit  $v(\mathbf{j}, \boldsymbol{\theta})$  of the perturbation operator  $V$  in canonical action-angle variables  $\{j_k, \theta_k, k = 1 \dots d\}$  in  $d$  degrees of freedom as the Fourier series in  $d$  dimensions

$$v(\mathbf{j}, \boldsymbol{\theta}) = \sum_{\mathbf{m} \in \mathbb{Z}^d} v_{\mathbf{m}}(\mathbf{j}) e^{i\mathbf{m} \cdot \boldsymbol{\theta}}. \quad (18)$$

We shall throughout the paper use lower/upper case letters to denote the corresponding classical/quantum observables. Note that the classical limit of the unperturbed Hamiltonian  $H_0$  can be written as a function  $h_0(\mathbf{j})$  of the canonical actions only, yielding the well-known quasi-periodic solution of the Hamilton's equations

$$\begin{aligned} \dot{\mathbf{j}}_t &= \mathbf{j}, \\ \dot{\boldsymbol{\theta}}_t &= \boldsymbol{\omega}(\mathbf{j})t \pmod{2\pi} \end{aligned} \quad (19)$$

with the dimensionless frequency vector

$$\boldsymbol{\omega}(\mathbf{j}) := \tau \frac{\partial h_0(\mathbf{j})}{\partial \mathbf{j}}. \quad (20)$$

The classical limit of the time-averaged perturbation  $\bar{V}$  is  $\bar{v} = v_0(\mathbf{j})$  which is here assumed to vanish  $v_0(\mathbf{j}) \equiv 0$ .

In quantum mechanics, one quantizes the action-angle variables using the famous EBK procedure [13] where one defines the action (momentum) operators  $\mathbf{J}$  and angle operators  $\exp(i\mathbf{m} \cdot \Theta)$  satisfying the canonical commutation relations

$$[J_k, \exp(i\mathbf{m} \cdot \Theta)] = \hbar m_k \exp(i\mathbf{m} \cdot \Theta), \quad k = 1, \dots, d. \quad (21)$$

As the action operators are mutually commuting they have a common eigenbasis  $|\mathbf{n}\rangle$  labeled by  $d$ -tuple of quantum numbers  $\mathbf{n} = (n_1, \dots, n_d)$ ,

$$\mathbf{J}|\mathbf{n}\rangle = \hbar(\mathbf{n} + \boldsymbol{\alpha})|\mathbf{n}\rangle \quad (22)$$

where  $0 \leq \alpha_k \leq 1$  are the Maslov indices which are irrelevant for the leading order semiclassical approximation employed in this paper. It follows from eq. (21) that the angle operators act as shifts

$$\exp(i\mathbf{m} \cdot \Theta)|\mathbf{n}\rangle = |\mathbf{n} + \mathbf{m}\rangle. \quad (23)$$

The Heisenberg equations of motion can be trivially solved, disregarding the operator ordering problem in the leading semiclassical order,

$$\begin{aligned} \mathbf{J}_t &= e^{iH_0\tau t/\hbar} \mathbf{J} e^{-iH_0\tau t/\hbar} = \mathbf{J}, \\ e^{i\mathbf{m} \cdot \Theta_t} &= e^{iH_0\tau t/\hbar} e^{i\mathbf{m} \cdot \Theta} e^{-iH_0\tau t/\hbar} \cong e^{i\mathbf{m} \cdot \boldsymbol{\omega}(\mathbf{J})t} e^{i\mathbf{m} \cdot \Theta}, \end{aligned} \quad (24)$$

in terms of the frequency operator  $\boldsymbol{\omega}(\mathbf{J})$ . In the whole paper we use the symbol  $\cong$  for 'semiclassically equal', *i.e.* asymptotically equal in the leading order in  $\hbar$ . Similarly, time evolution of the perturbation observable is obtained in the leading order by substitution of classical with quantal action-angle variables in the expression (18)

$$V_t = e^{iH_0\tau t/\hbar} V e^{-iH_0\tau t/\hbar} \cong \sum_{\mathbf{m} \neq \mathbf{0}} v_{\mathbf{m}}(\mathbf{J}) e^{i\mathbf{m} \cdot \boldsymbol{\omega}(\mathbf{J})t} e^{i\mathbf{m} \cdot \Theta}. \quad (25)$$

Now we are ready to write the semiclassical expressions of the two-term BCH expansion (17). The operator  $\Sigma_t$  (7) giving the first order BCH term can be computed as a trivial geometric series

$$\Sigma_t \cong \sum_{\mathbf{m} \neq \mathbf{0}} \tilde{v}_{\mathbf{m}}(\mathbf{J}) \left(1 - e^{i\mathbf{m} \cdot \boldsymbol{\omega}(\mathbf{J})t}\right) e^{i\mathbf{m} \cdot \Theta} \quad (26)$$

yielding a quasi-periodic and hence bounded temporal behaviour (due to  $v_0(\mathbf{j}) = 0$ ). Here we have introduced modified Fourier coefficients  $\tilde{v}_{\mathbf{m}}(\mathbf{j})$  of the perturbation

$$\tilde{v}_{\mathbf{m}}(\mathbf{j}) = \frac{\tau v_{\mathbf{m}}(\mathbf{j})}{1 - e^{i\mathbf{m} \cdot \boldsymbol{\omega}(\mathbf{j})}} = i e^{-i\mathbf{m} \cdot \boldsymbol{\omega}(\mathbf{j})/2} \frac{\tau v_{\mathbf{m}}(\mathbf{j})}{2 \sin(\frac{1}{2} \mathbf{m} \cdot \boldsymbol{\omega}(\mathbf{j}))}. \quad (27)$$

As for the operator  $\bar{V}$ , or  $\Gamma_t$ , giving the second order BCH term, the calculation is more tedious. First, we plug the semiclassical dynamics (25) into the definition (15). Second, we compute the resulting commutators of the form

$$[v_{\mathbf{m}'}(\mathbf{J}) e^{i\mathbf{m}' \cdot \boldsymbol{\omega}(\mathbf{J})t'} e^{i\mathbf{m}' \cdot \Theta}, v_{\mathbf{m}''}(\mathbf{J}) e^{i\mathbf{m}'' \cdot \boldsymbol{\omega}(\mathbf{J})t''} e^{i\mathbf{m}'' \cdot \Theta}],$$

in the leading order in  $\hbar$ , by means of the Poisson brackets

$$i\hbar \left( \partial_{\boldsymbol{\theta}}(v_{\mathbf{m}'} e^{i\mathbf{m}' \cdot (\boldsymbol{\theta} + \boldsymbol{\omega} t')}) \cdot \partial_{\mathbf{j}}(v_{\mathbf{m}''} e^{i\mathbf{m}'' \cdot (\boldsymbol{\theta} + \boldsymbol{\omega} t'')}) - \partial_{\mathbf{j}}(v_{\mathbf{m}'} e^{i\mathbf{m}' \cdot (\boldsymbol{\theta} + \boldsymbol{\omega} t')}) \cdot \partial_{\boldsymbol{\theta}}(v_{\mathbf{m}''} e^{i\mathbf{m}'' \cdot (\boldsymbol{\theta} + \boldsymbol{\omega} t'')}) \right)$$

and substitution of variables  $\mathbf{j}, e^{i\mathbf{m} \cdot \boldsymbol{\theta}}$  by operators  $\mathbf{J}, e^{i\mathbf{m} \cdot \boldsymbol{\Theta}}$ . Third, we drop the terms for which  $\mathbf{m}' + \mathbf{m}'' \neq \mathbf{0}$ , since these contain the shift operator  $e^{i(\mathbf{m}' + \mathbf{m}'') \cdot \boldsymbol{\Theta}}$  [eq. (23)], giving off-diagonal matrix elements only which we know should give vanishing overall contribution for a residual observable, see eqs. (14,16)†. As a result we find the following semiclassical expression

$$\begin{aligned} \bar{\bar{V}} &\cong \bar{v}(\mathbf{J}), \\ \bar{v}(\mathbf{j}) &= -\frac{\tau}{2} \sum_{\mathbf{m} \neq \mathbf{0}} \mathbf{m} \cdot \partial_{\mathbf{j}} \left\{ |v_{\mathbf{m}}(\mathbf{j})|^2 \cot \left( \frac{1}{2} \mathbf{m} \cdot \boldsymbol{\omega}(\mathbf{j}) \right) \right\}. \end{aligned} \quad (28)$$

We have derived the semiclassical expression for both terms occurring in the echo operator (17), for the integrated perturbation  $\Sigma_t$  (26), and for the doubly-averaged perturbation  $\bar{\bar{V}}$  (28). However, we note that both semiclassical expressions (26,28) are subject to a potential ‘small denominator’ problem which is closely related to the one in KAM theory. This well known problem of divergence of sums over the Fourier index  $\mathbf{m}$  can be avoided in a generic case. First, strict singularities at resonances  $\mathbf{m} \cdot \boldsymbol{\omega} = 0 \pmod{2\pi}$ , where frequencies  $\boldsymbol{\omega}$  are evaluated in the eigenstates  $|\mathbf{n}\rangle$ , happen with probability zero. Second, the *near resonances* give a finite total contribution if one assumes that the classical limit of the perturbation  $v(\mathbf{j}, \boldsymbol{\theta})$  is sufficiently smooth, *e.g.* analytic in angles  $\boldsymbol{\theta}$  such that the Fourier coefficients  $v_{\mathbf{m}}$  fall off exponentially in  $|\mathbf{m}|$ . This will be assumed throughout the rest of this paper, whereas the cases of more singular perturbations call for further investigations. The problem is even less severe if the Fourier series (18) is finite as will be the case in our numerical example. The results (26,28) enable us to proceed with the actual calculation of fidelity decay for ‘long’ and ‘short’ times, where the operators  $\bar{\bar{V}}$  and  $\Sigma_t$  are dominating, respectively.

### 3.1. Asymptotic regime of long times

Thus for sufficiently long times  $t$ , say longer than a certain  $t_2 \propto \delta^{-1}$  such that the second term  $\bar{\bar{V}} t \tau \delta^2 / 2$  in BCH expansion (9,17) dominates the first one  $\Sigma_t \delta$ , the fidelity (amplitude) can be written as

$$f(t) \cong \left\langle \exp \left( i \frac{\tau \delta^2}{2\hbar} \bar{\bar{V}} t \right) \right\rangle, \quad \text{for } t > t_2. \quad (29)$$

Since both operators,  $\Sigma_t$  and  $\bar{\bar{V}}$ , have well defined classical limits, it is clear that  $t_2$  will generally *not depend* on  $\hbar$ , however it may depend on the precise structure of the initial state. Roughly it can be estimated semiclassically as

$$t_2 = \left( \frac{1}{|\bar{v}|} \sqrt{\sum_{\mathbf{m} \neq \mathbf{0}} |\tilde{v}_{\mathbf{m}}|^2} \right)_{\text{ef}} \frac{2}{\tau \delta} \quad (30)$$

† Actually, in the off-diagonal matrix elements of the *Poisson bracket* we have oscillating functions of time  $e^{i(\mathbf{m}' + \mathbf{m}'') \cdot \boldsymbol{\omega} t}$  which, for times longer than  $\sim 1/\hbar$ , can no longer reproduce the matrix element of the *commutator*.



where subscript ef means *effective value* in the action space region of interest, *i.e.* where the initial state is distributed. Note that the actual timescale  $t_2$  of the dominance of the second order can be in fact up to a factor  $\sim \hbar^{-1/2}$  longer for coherent initial states and for sufficiently small perturbation, as explained in section 5.

The formula (29) can be transformed, following Ref.[6], into a very useful expression for the semiclassical analysis by, first, writing out the average as the trace in EBK basis  $|\mathbf{n}\rangle$ , second, using the fact that  $\bar{V}$  is diagonal in  $|\mathbf{n}\rangle$  with eigenvalues  $\cong \bar{v}(\hbar\mathbf{n})$ , and third, semiclassically approximating the sum  $\sum_{\mathbf{n}}$  by an integral over the action space  $\hbar^{-d} \int d^d\mathbf{j}$ :

$$f(t) \cong \hbar^{-d} \int d^d\mathbf{j} \exp\left(i\frac{\tau\delta^2}{2\hbar}\bar{v}(\mathbf{j})t\right) D_\psi(\mathbf{j}), \quad t_2 < t < t^* \quad (31)$$

$$D_\psi(\hbar\mathbf{n}) := |\langle\psi|\mathbf{n}\rangle|^2. \quad (32)$$

The last step is justified for (classically long) times up to  $t^*$ , such that the variation of the exponential in (31) across one Planck cell of diameter  $\hbar$  is small,

$$t^* = \frac{1}{|\partial_{\mathbf{j}}\bar{v}|_{\text{ef}}} \frac{1}{\tau\delta^2} \sim \hbar^0\delta^{-2} \quad (33)$$

We note a strong formal similarity between the action-space-integral (ASI) representation of fidelity for a residual perturbing observable (31) and the ASI representation for a generic observable [6] for times up to  $\sim \hbar^0\delta^{-1}$

$$f_{\text{generic}}(t) \cong \hbar^{-d} \int d^d\mathbf{j} \exp\left(i\frac{\tau\delta}{\hbar}\bar{v}(\mathbf{j})t\right) D_\psi(\mathbf{j}). \quad (34)$$

This means that only  $\bar{v}\delta$  has to be replaced by  $\bar{v}\delta^2/2$  in the semiclassical analysis of formula (34) elaborated in [6]. This shall be discussed in detail for the specific cases of coherent and random initial states in sections 5 and 6.

### 3.2. The plateau: linear response and beyond

For times  $t$  smaller than  $t_2$  (30) the first term in the exponential of (17) dominates over the second one, so we may write the fidelity amplitude generally as

$$f(t) \cong \left\langle \exp\left(i\frac{\delta}{\hbar}\Sigma_t\right) \right\rangle, \quad \text{for } t < t_2. \quad (35)$$

Let us first discuss the regime of sufficiently small perturbation such that the fidelity is close to 1, *i.e.* the norm of the exponential is small,  $|\delta\Sigma_t/\hbar| \ll 1$ , so we can use the second order expansion of (35) which is precisely the linear response formula (8). We have to compute the uncertainty of the time integrated perturbation operator  $\Sigma_t$ . From semiclassical expression for  $\Sigma_t$  (26) we can directly compute the expectation value

$$\langle\Sigma_t\rangle \cong \sum_{\mathbf{n}} \sum_{\mathbf{m} \neq \mathbf{0}} \tilde{v}_{\mathbf{m}}(\hbar\mathbf{n}) \left(1 - e^{i\mathbf{m}\cdot\boldsymbol{\omega}(\hbar\mathbf{n})t}\right) \psi_{\mathbf{n}-\mathbf{m}}\psi_{\mathbf{n}}^*, \quad (36)$$

where  $\psi_{\mathbf{n}} := \langle\mathbf{n}|\psi\rangle$ . Similarly, we compute the expectation value of its square

$$\begin{aligned} \langle\Sigma_t^2\rangle &\cong \sum_{\mathbf{n}} \sum_{\mathbf{m}, \mathbf{m}' \neq \mathbf{0}} \tilde{v}_{\mathbf{m}}(\hbar\mathbf{n})\tilde{v}_{\mathbf{m}'}(\hbar\mathbf{n}) \\ &\times \left(1 - e^{i\mathbf{m}\cdot\boldsymbol{\omega}(\hbar\mathbf{n})t} - e^{i\mathbf{m}'\cdot\boldsymbol{\omega}(\hbar\mathbf{n})t} + e^{i(\mathbf{m}+\mathbf{m}')\cdot\boldsymbol{\omega}(\hbar\mathbf{n})t}\right) \psi_{\mathbf{n}-\mathbf{m}}\psi_{\mathbf{n}+\mathbf{m}'}^*. \end{aligned} \quad (37)$$

For sufficiently *many non-vanishing components*  $\psi_{\mathbf{n}}$  and/or for sufficiently *large times*  $t > t_1$ , and away from certain *resonance condition* (all three conditions will be discussed in detail later) the terms with explicitly time-dependent oscillating factors  $\exp(i\mathbf{m} \cdot \boldsymbol{\omega}(\hbar\mathbf{n})t)$  can be argued to give vanishing or (semiclassically) negligible contributions. In fact, the time scale  $t_1$  will be determined by the condition that at typical later times *random phase approximation* can be used in dealing with the exponentials in eqs. (36,37). Thus the above expectation values should be *time independent* and equal to their time averages

$$\langle \Sigma_t \rangle \cong \overline{\langle \Sigma \rangle} = \sum_{\mathbf{n}} \sum_{\mathbf{m} \neq \mathbf{0}} \tilde{v}_{\mathbf{m}} \psi_{\mathbf{n}-\mathbf{m}} \psi_{\mathbf{n}}^*, \quad (38)$$

$$\langle \Sigma_t^2 \rangle \cong \overline{\langle \Sigma^2 \rangle} = \sum_{\mathbf{n}} \left\{ \left| \sum_{\mathbf{m} \neq \mathbf{0}} \tilde{v}_{\mathbf{m}}(\hbar\mathbf{n}) \psi_{\mathbf{n}-\mathbf{m}} \right|^2 + \sum_{\mathbf{m} \neq \mathbf{0}} |\tilde{v}_{\mathbf{m}}(\hbar\mathbf{n}) \psi_{\mathbf{n}-\mathbf{m}}|^2 \right\}. \quad (39)$$

This gives us a prediction that, after following a classical decay up to the short time  $t_1$ , the fidelity should reach a constant value – a plateau and stay there up to time  $t_2$ . The linear response value of the fidelity at the plateau is

$$F(t) \cong 1 - \frac{\delta^2}{\hbar^2} \left\{ \overline{\langle \Sigma^2 \rangle} - \overline{\langle \Sigma \rangle}^2 \right\} + \mathcal{O}(\delta^4), \quad \text{for } t_1 < t < t_2. \quad (40)$$

Further, we can easily go beyond the linear response approximation by expanding the formula (35) to all orders in  $\delta$ . For this, we have to calculate the powers of the operator  $\Sigma_t$

$$\Sigma_t^k \cong \sum_{\mathbf{m}_1, \dots, \mathbf{m}_k \neq \mathbf{0}} \prod_{l=1}^k \tilde{v}_{\mathbf{m}_l}(\mathbf{J}) e^{i\mathbf{m}_l \cdot \boldsymbol{\Theta}} \left( 1 - e^{i\mathbf{m}_l \cdot \boldsymbol{\omega}(\mathbf{J})t} \right). \quad (41)$$

We shall use two facts in order to carry through the calculation: (i) That for leading semiclassical order the operator ordering is not important. (ii) Oscillatory time dependent terms, which in any case average to zero, typically give exponentially damped or semiclassically small overall contributions when used in expectation values. Thus we shall approximate  $\Sigma_t^k$  by its time-average  $\overline{\Sigma^k}$ , and the latter is calculated by selecting from the product (41) only the combinations of multi-indices which sum up to zero  $\mathbf{m}_1 + \dots + \mathbf{m}_l = \mathbf{0}$ . Let us write the time average of the operator  $\Sigma_t$  in terms of an explicit function of canonical operators

$$\begin{aligned} \overline{\Sigma} &\cong \tilde{v}(\mathbf{J}, \boldsymbol{\Theta}), \\ \tilde{v}(\mathbf{j}, \boldsymbol{\theta}) &:= \sum_{\mathbf{m} \neq \mathbf{0}} \tilde{v}_{\mathbf{m}}(\mathbf{j}) e^{i\mathbf{m} \cdot \boldsymbol{\theta}}. \end{aligned} \quad (42)$$

Then we calculate

$$\begin{aligned} \overline{\Sigma^k} &\cong \overline{\Sigma^k} + \sum_{l=2}^k (-1)^l \binom{k}{l} \overline{\Sigma}^{k-l} \sum_{\mathbf{m}_1, \dots, \mathbf{m}_l \neq \mathbf{0}} \delta_{\mathbf{m}_1 + \dots + \mathbf{m}_l} \tilde{v}_{\mathbf{m}_1}(\mathbf{J}) \cdots \tilde{v}_{\mathbf{m}_l}(\mathbf{J}) \\ &= \frac{1}{(2\pi)^d} \sum_{l=0}^k (-1)^l \binom{k}{l} \tilde{v}(\mathbf{J}, \boldsymbol{\Theta})^{k-l} \int d^d \mathbf{x} [\tilde{v}(\mathbf{J}, \mathbf{x})]^l. \end{aligned} \quad (43)$$

Please observe that  $\boldsymbol{\Theta}$  is an angle-operator (which always stands in the exponential, so it is well defined), and  $\mathbf{x}$  is a  $d$ -dimensional integration variable, and that in

order to write (43) we have used an integral representation of the Kronecker symbol:  $\delta_{\mathbf{m}} = (2\pi)^{-d} \int d^d \mathbf{x} e^{i\mathbf{m}\cdot\mathbf{x}}$ . Now it is straightforward to compute the power series  $\sum_{k=0}^{\infty} (i\delta/\hbar)^k \overline{\Sigma^k}/k!$  by changing the summation variables to  $k-l$  and  $k$ , yielding a product of two exponentials

$$\overline{\exp\left(\frac{i\delta}{\hbar}\Sigma\right)} \cong \exp\left(\frac{i\delta}{\hbar}\tilde{v}(\mathbf{J}, \Theta)\right) \int \frac{d^d \mathbf{x}}{(2\pi)^d} \exp\left(-\frac{i\delta}{\hbar}\tilde{v}(\mathbf{J}, \mathbf{x})\right), \quad (44)$$

and the plateau of fidelity (amplitude) is the expectation value of this operator

$$f_{\text{plateau}} \cong \int \frac{d^d \mathbf{x}}{(2\pi)^d} \left\langle \exp\left(\frac{i\delta}{\hbar}\tilde{v}(\mathbf{J}, \Theta)\right) \exp\left(-\frac{i\delta}{\hbar}\tilde{v}(\mathbf{J}, \mathbf{x})\right) \right\rangle, \quad (45)$$

$f(t) = f_{\text{plateau}}$  for  $t_1 < t < t_2$ . The very existence of such a plateau of fidelity (high fidelity for small  $\delta/\hbar$ ) is very interesting and distinct property of quantum dynamics. Note that the time scale  $t_1$  only depends on the unperturbed dynamics, namely on the property of the operator  $\Sigma_t$ , so it cannot depend on the strength of the perturbation,  $t_1 = \mathcal{O}(\delta^0)$ . Thus the range of the plateau, *i.e.*  $t_2/t_1 \propto \delta^{-1}$  can become arbitrarily large for small  $\delta$ . The formula (45) becomes very useful whenever one is able to semiclassically compute the quantum expectation value in terms of classical phase space integrals. We shall present this derivation for two extremal cases of *coherent* and *random* initial states, in sections 5 and 6, respectively.

Note that the formulae (44,45) may be very useful in a general case whenever one has to calculate an expectation value of the form  $\left\langle \exp\left(i\frac{\delta}{\hbar}\Sigma_t\right) \right\rangle$  where  $\Sigma_t$  is a time-integrated quasi-periodic process with a zero time-average.

#### 4. Numerical example: integrable top

For numerical illustration of the above theory we take a spin system with the following one-time-step unitary propagator

$$U_0 = \exp\left\{-iS\frac{\alpha}{2}\left(\frac{S_z}{S} - \beta\right)^2\right\}, \quad (46)$$

with parameters  $\alpha$  and  $\beta$ .  $S_k, k = x, y, z$  are standard quantum angular momentum operators with a fixed magnitude  $S$  of angular momentum and with the SU(2) commutator  $[S_k, S_l] = i\epsilon_{klm}S_m$ .

The semiclassical limit is obtained by letting  $S \rightarrow \infty$  while the classical angular momentum  $\hbar S = 1$  is kept fixed, so that the effective Planck constant is given by  $\hbar = 1/S$ . The classical map corresponding to the one-time-step propagator  $U_0$  can be obtained from the Heisenberg equations of angular momentum operators in the  $S \rightarrow \infty$  limit. Defining by  $(x, y, z) = (S_x, S_y, S_z)/S$  a point on a unit sphere, we obtain a classical area preserving map:

$$\begin{aligned} x_{t+1} &= x_t \cos(\alpha(z_t - \beta)) - y_t \sin(\alpha(z_t - \beta)) \\ y_{t+1} &= y_t \cos(\alpha(z_t - \beta)) + x_t \sin(\alpha(z_t - \beta)) \\ z_{t+1} &= z_t. \end{aligned} \quad (47)$$

This classical map represents a twist around z-axis. We note that it corresponds to the stroboscopic map (19) with an arbitrary unit of time, so we put  $\tau = 1$ , of an integrable system with the Hamiltonian  $h_0(j) = \frac{1}{2}\alpha(j - \beta)^2$  generating a frequency field

$$\omega(j) = \frac{dh_0(j)}{dj} = \alpha(j - \beta). \quad (48)$$

Here we used a canonical transformation from a unit-sphere to an action-angle pair  $(j, \theta) \in [-1, 1] \times [0, 2\pi)$ , namely

$$x = \sqrt{1 - j^2} \cos \theta, \quad y = \sqrt{1 - j^2} \sin \theta, \quad z = j. \quad (49)$$

Now we perturb the Hamiltonian by periodic kicking with a transverse pulsed magnetic field in  $x$  direction,

$$h_\delta(j, \theta, \tau) = \frac{1}{2}\alpha(j - \beta)^2 + \delta\sqrt{1 - j^2} \cos \theta \sum_{k=-\infty}^{\infty} \delta(\tau - k). \quad (50)$$

Perturbed quantum evolution is given by a product of two unitary propagators

$$U_\delta = U_0 \exp(-i\delta S_x), \quad (51)$$

so the perturbation generator is

$$V = S_x/S. \quad (52)$$

The classical perturbation has only one Fourier component, namely

$$v(j, \theta) = \sqrt{1 - j^2} \cos \theta, \quad v_{\pm 1}(j) = \frac{1}{2}\sqrt{1 - j^2}, \quad (53)$$

whereas  $v_0 \equiv 0$  indicating that the time-average vanishes  $\bar{v} = 0$ , and  $\bar{V} = 0$ .

In our numerical illustrations two different types of initial states will be used. SU(2) coherent wavepackets are used to probe the correspondence with the classical fidelity, while random states are used to investigate the other end – states without a classical correspondence. The parameter  $\alpha$  in  $U_0$  (46) will be always set to  $\alpha = 1.1$ , while  $\beta = 0$  for coherent initial states, and  $\beta = 0$  and  $\beta = 1.4$  for random initial states. The reason for choosing nonzero shift  $\beta$  for random states will be explained later. We should stress that we have performed calculations also for other choices of regular  $U_0$ , also in KAM regime, *e.g.* for precisely the same model and parameter values as used in Ref. [10], and obtained qualitatively the same results as for the presented case of unperturbed dynamics. The coherent state written in the canonical eigenbasis  $|m\rangle$  of the operator  $S_z$  and centered at the position  $\mathbf{n} = (\sin \vartheta^* \cos \varphi^*, \sin \vartheta^* \sin \varphi^*, \cos \vartheta^*)$  on a unit sphere is

$$|\vartheta^*, \varphi^*\rangle = \sum_{m=-S}^S \binom{2S}{S+m}^{1/2} \cos(\vartheta^*/2)^{S+m} \sin(\vartheta^*/2)^{S-m} e^{-im\varphi^*} |m\rangle. \quad (54)$$

The corresponding classical density reads [11]

$$\rho_{\text{cl}}(\vartheta, \varphi) = \frac{4S+1}{4\pi} \exp\left\{-S\left((\vartheta - \vartheta^*)^2 + (\varphi - \varphi^*)^2 \sin^2 \vartheta\right)\right\}. \quad (55)$$

In the numerical experiments reported below the coherent initial state will always be positioned at the point  $(\vartheta^*, \varphi^*) = (1, 1)$ .

## 5. Semiclassical asymptotics: coherent initial state

Let us now study an important specific case of a (generally squeezed) coherent initial state which can be written in the EBK basis as a general Gaussian centered around a phase space point  $(\mathbf{j}^*, \boldsymbol{\theta}^*)$

$$\langle \mathbf{n} | \mathbf{j}^*, \boldsymbol{\theta}^* \rangle \cong \left( \frac{\hbar}{\pi} \right)^{d/4} |\det \Lambda|^{1/4} \exp \left\{ -\frac{1}{2\hbar} (\hbar \mathbf{n} - \mathbf{j}^*) \cdot \Lambda (\hbar \mathbf{n} - \mathbf{j}^*) - i \mathbf{n} \cdot \boldsymbol{\theta}^* \right\}, \quad (56)$$

with  $\Lambda$  being a positive symmetric  $d \times d$  matrix of squeezing parameters. Note that the shape of the coherent state is generally only asymptotically Gaussian, as  $\hbar \rightarrow 0$ , due to cyclic and discrete nature of coordinates  $\boldsymbol{\theta}$  and  $\mathbf{j}$ , respectively. Let us also write the *structure function* (32) of our coherent state (56)

$$D_\psi(\mathbf{j}) \cong \left( \frac{\hbar}{\pi} \right)^{d/2} |\det \Lambda|^{1/2} \exp \left\{ -\frac{1}{\hbar} (\mathbf{j} - \mathbf{j}^*) \cdot \Lambda (\mathbf{j} - \mathbf{j}^*) \right\} \quad (57)$$

which is normalized as  $\hbar^{-d} \int d^d \mathbf{j} D_\psi(\mathbf{j}) = 1$ .

For example, for SU(2) coherent state of a quantum top (54) when written in the asymptotic form (56), the squeezing parameter reads  $\Lambda = 1/\sin^2 \vartheta^*$ .

### 5.1. The plateau: linear response and beyond

In the regime of linear response, valid for sufficiently small  $\delta$ , we simply evaluate the general expressions (36,37) for the particular case of a coherent initial state (56), namely we write  $\psi_{\mathbf{n}} = \langle \mathbf{n} | \mathbf{j}^*, \boldsymbol{\theta}^* \rangle$ . First we will show that the time dependent terms in expectation values of the powers of  $\Sigma_t$  indeed vanish for  $t > t_1$  as stated in section 3.2. We recall the assumption that the perturbation  $v(\mathbf{j}, \boldsymbol{\theta})$  is sufficiently smooth, *e.g.* analytic in  $\boldsymbol{\theta}$ , so that the Fourier coefficients  $v_{\mathbf{m}}(\mathbf{j})$  decrease sufficiently fast, *e.g.* exponentially, or only a finite number of  $v_{\mathbf{m}}(\mathbf{j})$  is non-vanishing. What we actually need here is that an effective number of Fourier components is smaller than the width of a wavepacket which is  $\sim \hbar^{-1/2}$ . This means that within the range of Fourier series over  $\mathbf{m}$ , or  $\mathbf{m}'$  we can approximate

$$\psi_{\mathbf{n}-\mathbf{m}}^* \psi_{\mathbf{n}+\mathbf{m}'} \cong D_\psi(\hbar \mathbf{n}) e^{-i(\mathbf{m}+\mathbf{m}') \cdot \boldsymbol{\theta}^*}. \quad (58)$$

Let us estimate the general time dependent term of expressions (36,37), where all factors with non-singular classical limit are combined together and denoted as  $g(\mathbf{j})$ , by means of expanding the frequency around the center of the packet  $\boldsymbol{\omega}(\mathbf{j}^* + \mathbf{x}) = \boldsymbol{\omega}(\mathbf{j}^*) + \Omega \mathbf{x} + \dots$ , where  $\Omega$  is a matrix  $\Omega_{kl} = \partial \omega_k(\mathbf{j}^*) / \partial j_l$ , followed by  $d$ -dimensional Gaussian integration

$$\begin{aligned} \sum_{\mathbf{n}} g(\hbar \mathbf{n}) e^{i \mathbf{m} \cdot \boldsymbol{\omega}(\hbar \mathbf{n}) t} D_\psi(\hbar \mathbf{n}) &\cong \hbar^{-d} \int d^d \mathbf{j} g(\mathbf{j}) e^{i \mathbf{m} \cdot \boldsymbol{\omega}(\mathbf{j}) t} D_\psi(\mathbf{j}) \\ &\cong g(\mathbf{j}^*) e^{i \mathbf{m} \cdot \boldsymbol{\omega}(\mathbf{j}^*) t} \left( \frac{\hbar}{\pi} \right)^{d/2} |\det \Lambda|^{1/2} \int d^d \mathbf{x} \exp \left( -\frac{1}{\hbar} \mathbf{x} \cdot \Lambda \mathbf{x} + i t \mathbf{m} \cdot \Omega \mathbf{x} \right) \\ &= g(\mathbf{j}^*) e^{i \mathbf{m} \cdot \boldsymbol{\omega}(\mathbf{j}^*) t} \exp \left( -\frac{\hbar t^2}{4} \mathbf{m} \cdot \Omega \Lambda^{-1} \Omega^T \mathbf{m} \right). \end{aligned} \quad (59)$$

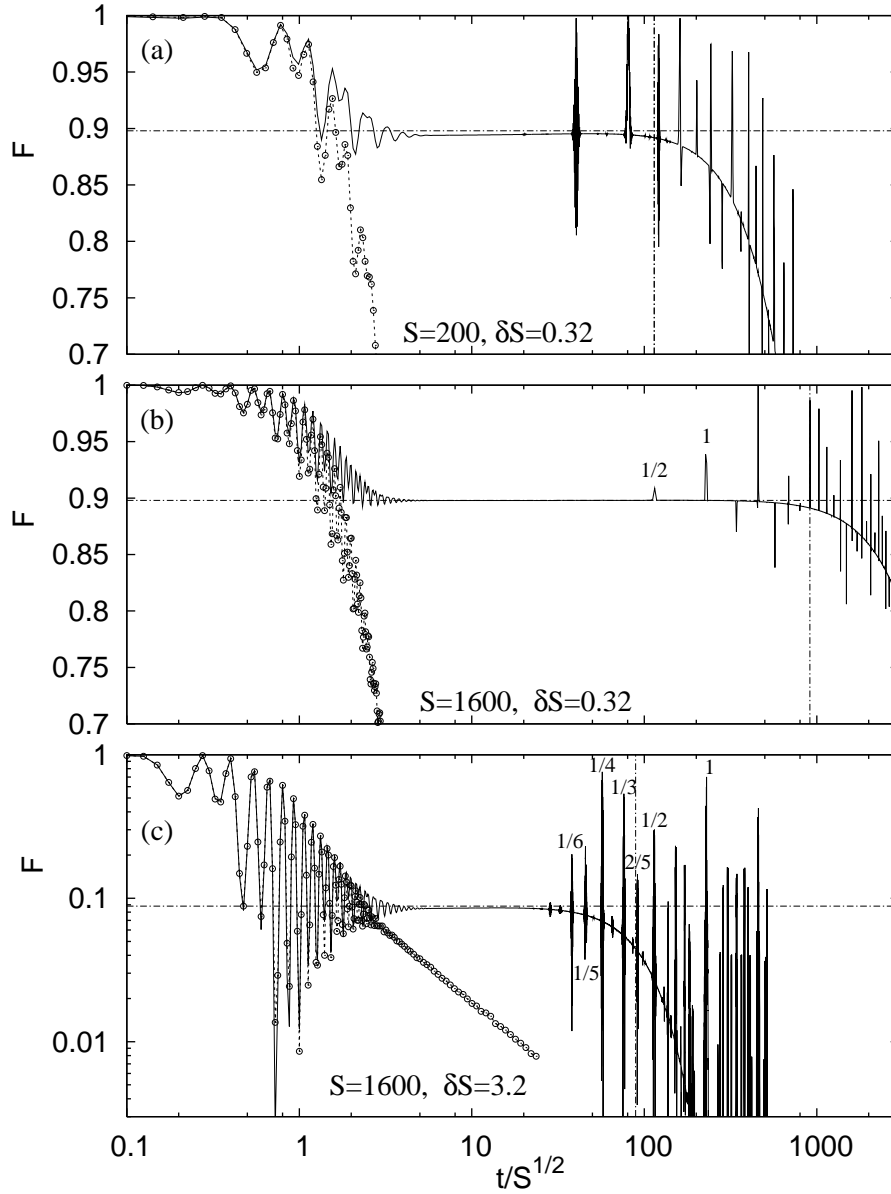

**Figure 1.** The short time fidelity for a quantized top  $\alpha = 1.1, \beta = 0$  is shown for the coherent initial state, for  $S = 200$  (a), and  $S = 1600$  (b), with a fixed product  $\delta S = 0.32$  being well described by the linear response. In (c) we show  $S = 1600$  and stronger perturbation with  $\delta S = 3.2$ . Note that the time axis is rescaled as  $t/t_1$ . Symbols connected with dashed lines denote the corresponding classical fidelity. The horizontal chain line denotes the theoretical value of the plateau (68), while the vertical chain line denotes the estimated theoretical value for  $t_2$  (72). In (b,c) we also indicate fractional  $2\pi k/p$  resonances with  $k/p$  marked on the figure (see text for details).

We see that all these terms decay to zero with Gaussian envelopes with the longest time scale estimated as

$$t_1 = \left( \frac{\hbar}{4} \min_{m \neq 0} (\mathbf{m} \cdot \Omega \Lambda^{-1} \Omega^T \mathbf{m}) \right)^{-1/2} \propto \hbar^{-1/2}. \quad (60)$$

Note that the decay of (59) is absent if  $\Omega = 0$ , *e.g.* in the case of  $d$ -dimensional harmonic oscillator. There may also be a general problem with the formal existence of the scale  $t_1$  (60) if the derivative matrix  $\Omega$  is singular, but this may not actually affect the fidelity for sufficiently fast converging or finite Fourier series (18).

Thus we have shown that for  $t > t_1$  expectation values (36,37) are indeed given by time-independent expressions (38,39) which in the case of a coherent initial state (56) evaluate to

$$\langle \Sigma_t \rangle \cong \sum_{\mathbf{m} \neq \mathbf{0}} \tilde{v}_{\mathbf{m}}(\mathbf{j}^*) e^{i\mathbf{m} \cdot \boldsymbol{\theta}^*} = \tilde{v}(\mathbf{j}^*, \boldsymbol{\theta}^*), \quad (61)$$

$$\langle \Sigma_t^2 \rangle \cong (\tilde{v}(\mathbf{j}^*, \boldsymbol{\theta}^*))^2 + \sum_{\mathbf{m} \neq \mathbf{0}} |\tilde{v}_{\mathbf{m}}(\mathbf{j}^*)|^2. \quad (62)$$

The variance  $\nu = \langle \Sigma_t^2 \rangle - \langle \Sigma_t \rangle^2$  which determines the plateau in the fidelity (8) is the second term on RHS of eq. (62). In terms of original Fourier coefficients (27) the final linear response result reads

$$F_{\text{coh}}(t) = 1 - \frac{\delta^2}{\hbar^2} \nu_{\text{coh}} + \mathcal{O}(\delta^4), \quad t > t_1,$$

$$\nu_{\text{coh}} = \sum_{\mathbf{m} \neq \mathbf{0}} \frac{\tau^2 |v_{\mathbf{m}}(\mathbf{j}^*)|^2}{4 \sin^2(\frac{1}{2} \mathbf{m} \cdot \boldsymbol{\omega}(\mathbf{j}^*))}. \quad (63)$$

Beyond the linear response approximation, the value of the plateau can be computed by applying a general formula for  $f_{\text{plateau}}$  (45). We shall make use of the fact that for coherent states we have the expectation value

$$\langle \exp(-i(\delta/\hbar)g(\mathbf{J}, \boldsymbol{\Theta})) \rangle \cong \exp(-i(\delta/\hbar)g(\mathbf{j}^*, \boldsymbol{\theta}^*)), \quad (64)$$

for some smooth function  $g$ , provided that the diameter of the wavepacket  $\sim \sqrt{\hbar}$  is smaller than the oscillation scale of the exponential  $\sim \hbar/\delta$ , *i.e.* provided  $\delta \ll \hbar^{1/2}$ . Then the squared modulus of  $f_{\text{plateau}}$  (45) rewrites as

$$F_{\text{plateau}} \cong \frac{1}{(2\pi)^{2d}} \left| \int d^d \mathbf{x} \exp\left(-\frac{i\delta}{\hbar} \tilde{v}(\mathbf{j}^*, \mathbf{x})\right) \right|^2. \quad (65)$$

The expression for  $\nu_{\text{coh}}$  (63) is of course just the lowest order expansion of  $F_{\text{plateau}}$  (65). It is interesting to note that the angle  $\boldsymbol{\theta}^*$  does not affect the probability  $F_{\text{plateau}}$  as it only rotates the phase of the amplitude  $f_{\text{plateau}}$ .

For smaller times  $t < t_1 \propto \hbar^{-1/2}$  the quantum fidelity is expected to follow the classical fidelity as defined by the overlap of two initially Gaussian classical phase space densities evolved under slightly different quasi-regular time evolutions [see Ref. [6] for a definition and linear response treatment of the classical fidelity]. More precisely, the quantum fidelity can be written in two equivalent ways as

$$F(t) = (2\pi\hbar)^d \int d^d \mathbf{q} d^d \mathbf{p} W_{U_0^t|\psi\rangle}(\mathbf{q}, \mathbf{p}) W_{U_\delta^t|\psi\rangle}(\mathbf{q}, \mathbf{p}) \quad (66)$$

$$= (2\pi\hbar)^d \int d^d \mathbf{q} d^d \mathbf{p} W_{|\psi\rangle}(\mathbf{q}, \mathbf{p}) W_{M_\delta(t)|\psi\rangle}(\mathbf{q}, \mathbf{p}) \quad (67)$$

where  $W_{|\psi\rangle}(\mathbf{q}, \mathbf{p})$  is the *Wigner function* of some state  $|\psi\rangle$ . The corresponding classical fidelity is defined by the same formula if  $(2\pi\hbar)^{d/2} W_{U^t|\psi\rangle}(\mathbf{q}, \mathbf{p})$  is substituted by the

evolving classical phase space density, a solution of the corresponding classical Liouville equation, with the initial condition  $(2\pi\hbar)^{d/2}W_{|\psi\rangle}(\mathbf{q}, \mathbf{p})$  which is proportional to the Wigner function of the initial state  $|\psi\rangle$ . Of course, this only makes sense if the function  $W_{|\psi\rangle}(\mathbf{q}, \mathbf{p})$  is strictly nonnegative so that it corresponds to some classical state, such as for example for a coherent state where it is a Gaussian. Indeed, time  $t_1 \sim \hbar^{-1/2}$  may also be interpreted as the *integrable Ehrenfest time* up to which phase space point-like quantum-classical correspondence will hold. Namely it is consistent with the time needed for a minimal uncertainty wavepacket of diameter  $\sim \hbar^{1/2}$  to spread ballistically over a region of the classical size ( $\sim \hbar^0$ ) of an invariant torus. After this time, quantum wavepacket will start to coherently interfere with itself, *e.g.* its Wigner function will develop negative values, so the strict quantum-classical correspondence will stop (see subsection 5.4). Therefore we expect initial agreement between the classical and the quantum fidelity up to time  $t_1$  and after that the classical fidelity of a regular dynamics with a residual perturbation decays with a power law  $\propto (\delta\hbar^{-1/2}t)^{-d}$  (factor  $\hbar^{1/2}$  comes from the size of the corresponding classical density) [see Refs.[8, 9]] whereas the quantum fidelity *freezes to a constant value* as computed by our semiclassical theory (65).

This picture is nicely confirmed by the numerical experiment with a quantized integrable top (46) as shown in figure 1, where we choose zero shift  $\beta = 0$ . Agreement between the classical and quantum fidelity up to  $t_1 \sim \sqrt{S}$  ( $\hbar = 1/S$ ) can be nicely observed. After  $t_1$  the fidelity stays constant until  $t_2$ , the point where fidelity again starts to decrease. This second timescale  $t_2$  will be discussed in the next subsection. The value of the plateau can be calculated specifically for our model by means of the semiclassical expression for  $F_{\text{plateau}}$  (65) and using Fourier modes of our numerical model (53). We get  $\tilde{v}(j, \theta) = -\frac{1}{2}\sqrt{1-j^2}\sin(\theta - \frac{1}{2}\alpha j)/\sin(\alpha j/2)$  and the integral occurring in  $F_{\text{plateau}}$  is elementary and gives

$$F_{\text{plateau}} = J_0^2 \left( \delta S \frac{\sqrt{1-j^{*2}}}{2 \sin(\alpha j^*/2)} \right), \quad (68)$$

with  $J_0$  being the zero order Bessel function. Agreement with this theory is excellent both in the linear response regime (figure 1a,b) and also for strong perturbation (figure 1c). Observe also a power law decay of the classical fidelity  $F_{\text{cl}} \sim (t\delta/\hbar)^{-1}$  beyond the regular Ehrenfest time  $t > t_1$  for strong perturbation in figure 1c.

Actually the calculation of  $F_{\text{plateau}}$  can be generalized to any perturbation with a single nonzero Fourier mode  $\pm\mathbf{m}_0$  with the result

$$F_{\text{plateau}} = J_0^2 \left( \frac{\tau\delta}{\hbar} \frac{|v_{\mathbf{m}_0}(\mathbf{j}^*)|}{\sin\{\mathbf{m}_0 \cdot \boldsymbol{\omega}(\mathbf{j}^*)/2\}} \right), \quad (69)$$

whereas for a more general multi-mode perturbations we have to evaluate the integral (65) numerically.

## 5.2. Asymptotic regime of long times

After a sufficiently long time  $t_2$  of order  $\delta^{-1}$  the second order term in BCH expansion (9) will start to dominate over the echo operator so the fidelity can be computed with our



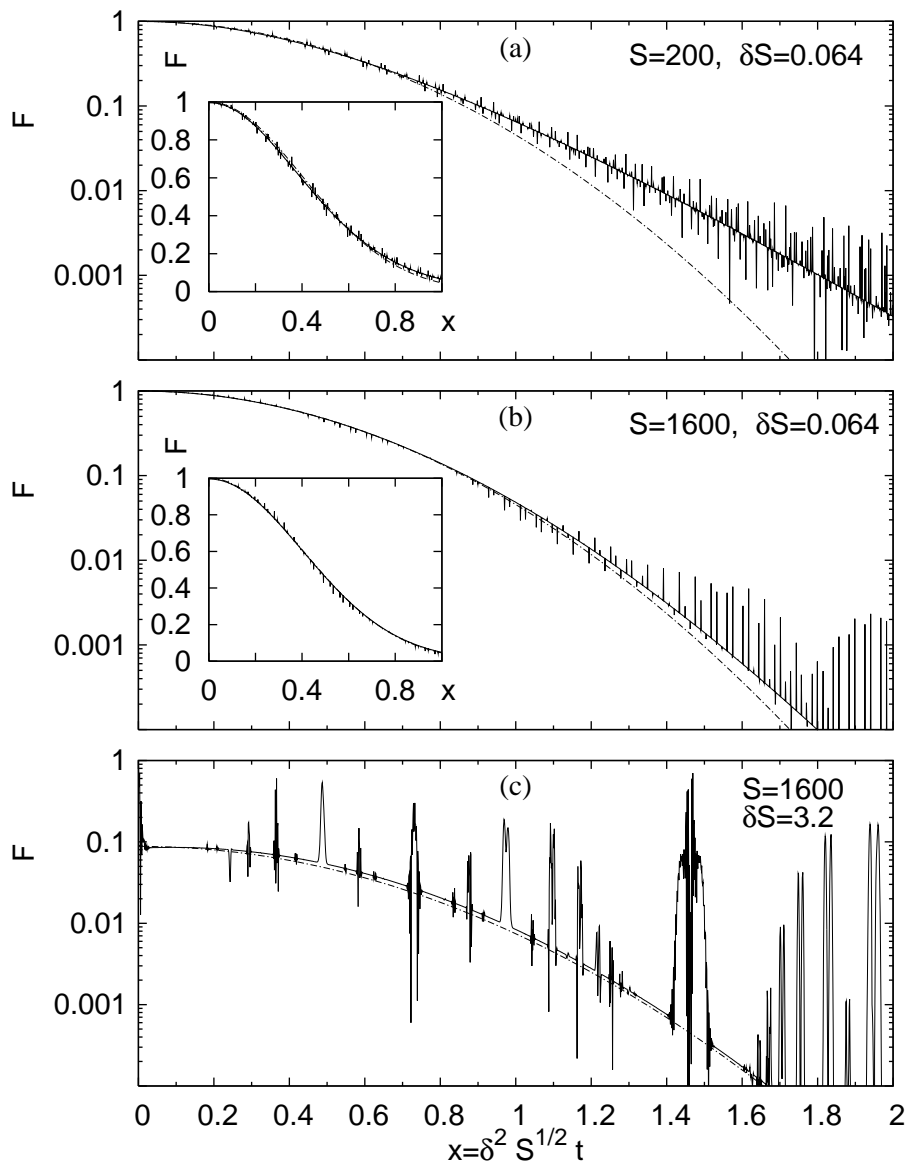

**Figure 2.** Long time ballistic decay of the fidelity for a quantized top with  $\alpha = 1.1, \beta = 0$  and coherent initial state is shown for cases  $S = 200$  (a), and  $S = 1600$  (b), of weak perturbation  $\delta S = 0.064$ , and for strong perturbation  $S = 1600, \delta S = 3.2$  (c). Chain curves indicate theoretical Gaussian (71) with analytically computed coefficients, except in the case (c), where we multiply the theoretical Gaussian decay by a prefactor 0.088 being equal to the theoretical value of the plateau (68), and rescale the exponent of the Gaussian by a factor 0.8 taking into account the effect of non-small first term in the exponent of (17). Note that in the limit  $S \rightarrow \infty$  the agreement with the semiclassical theory improves and that the size of the resonant spikes is of the same order as the drop in the linear response plateau. The insets show the data and the theory in the normal scale.

semiclassical formula (31). The straightforward calculation follows exactly the one for a generic perturbation in Ref.[6], paragraph 2.2.2, where  $\bar{v}\delta$  has to be replaced by  $\bar{v}\delta^2/2$  so we shall not repeat it here. Such a Gaussian approximation is justified provided

the stationary point of the exponent is not moved appreciably from the center  $\mathbf{j}^*$  of the packet (57). This implies that  $t\delta^2 \ll 1$  which is the same condition as required by substituting the sum over quantum numbers by the integral over the action space (31). The final result reads

$$f_{\text{coh}}(t) \cong \exp\left(-(\mathbf{u} \cdot \Lambda^{-1}\mathbf{u})\frac{\delta^4 t^2}{16\hbar} + \frac{i\bar{v}(\mathbf{j}^*)\delta^2 \tau t}{2\hbar}\right), \quad \mathbf{u} := \tau \frac{\partial \bar{v}(\mathbf{j}^*)}{\partial \mathbf{j}}, \quad (70)$$

where the vector  $\mathbf{u}$  is just a gradient of the classical observable  $\bar{v}$  at the center of the wavepacket. Thus we have derived a Gaussian decay of the fidelity

$$F_{\text{coh}}(t) = \exp\left\{-\left(\frac{t}{t_{\text{coh}}}\right)^2\right\}, \quad t_{\text{coh}} = (\mathbf{u} \cdot \Lambda^{-1}\mathbf{u})^{-1/2} \frac{(8\hbar)^{1/2}}{\delta^2} \quad (71)$$

on a timescale  $t_{\text{coh}} \propto \hbar^{1/2}\delta^{-2}$ . Indeed, it can now be checked that in the semiclassical regime of small  $\hbar$  the fidelity decays well before the time limit (33),  $t^* \sim \hbar^0\delta^{-2}$ , of our approximations. The formula (71) can only be expected to be accurate provided the plateau is close to 1 and hence described within the linear response approximation. Only in such a case can the effect of the first term  $\Sigma_t$  in the exponential of the echo operator (17) really be neglected, in the opposite case we can correct the Gaussian (71) by multiplying it with the plateau value and adjusting the coefficient in the exponential (see *e.g.* figure 2c).

In such a *regime of small perturbation*,  $\delta < \nu_{\text{coh}}^{-1/2}\hbar$ , we determine the crossover time  $t_2$  by comparing the linear response formula (63) with the decay law (71), namely  $1 - (t_2/t_{\text{coh}})^2 = 1 - \delta^2\nu_{\text{coh}}/\hbar^2$ . For stronger perturbation, namely up to  $\delta \sim \sqrt{\hbar}$ , time scale  $t_2$  can be simply estimated by  $t_{\text{coh}}$ , so we have a uniform estimation

$$t_2 = \min\left\{1, \frac{\delta}{\hbar}\nu_{\text{coh}}^{1/2}\right\}t_{\text{coh}} = \min\{\text{const } \hbar^{-1/2}\delta^{-1}, \text{const } \hbar^{1/2}\delta^{-2}\} \quad (72)$$

We note that the crossover time  $t_2$ , for coherent initial states and for a small perturbation  $\delta < \nu_{\text{coh}}^{-1/2}\hbar$ , is in fact by a factor  $\hbar^{-1/2}$  longer than the estimate (30). This is due to the fact that coherent states are strongly localized in action coordinates (quantum numbers) for small  $\hbar$ . Therefore, for small  $\delta$ , the operator  $\bar{V}t\delta^2$ , although it may already be dominating  $\Sigma_t\delta$  in norm, will only effectively rotate the overall phase of a coherent initial state since it is diagonal in  $|\mathbf{n}\rangle$  and thus will not (yet) affect the fidelity. So the estimate (30) is expected to be valid only for initial states whose relative support in quantum number lattice is not shrinking as  $\hbar \rightarrow 0$ . It is interesting that for the strongest allowed perturbation  $\delta_{\text{max}} = \text{const } \hbar^{1/2}$  for our semiclassical theory to be valid, the estimate (72) agrees with the general estimate (30),  $t_2 \sim 1/\delta$ .

Timescale  $t_2$  can be seen in figure 1 as the point of departure of fidelity from the plateau value. Using our model and the position of initial coherent state this can be calculated to be  $t_2 = \min\{0.57\sqrt{S}/\delta, 0.57/(\delta^2\sqrt{S})\}$  (similarity of numerical prefactors is just a coincidence) which is shown with vertical chain lines in figure 1. The theoretical position of  $t_2$  is shown with a vertical chain line and is given by  $t_{\text{coh}}$  for a strong perturbation  $\delta S = 3.2$  in figure 1c while it is  $t_{\text{coh}}\nu_{\text{coh}}^{1/2}\delta/\hbar$  in figures 1a,b. The long time decay of fidelity is shown in figure 2. Theoretical Gaussian decay (71), shown

with a chain curve, is again confirmed with an analytical formula for the decay time  $t_{\text{coh}} = 0.57\delta^{-2}\hbar^{1/2}$  evaluated at the particular position of the packet. Note that we do not have any fitting parameters, except in the case of a strong perturbation ( $\delta S \gg 1$ , figure 2c) where the prefactor and the exponent of a Gaussian had to be slightly adjusted due to the non-negligible effect of the first term in (17) [see caption for details]. Quite prominent feature in figures 1 and 2 are also “spikes” occurring at regular intervals, where the fidelity suddenly increases or wildly oscillates. These will be called the *echo resonances* and are particular to one-dimensional systems.

We should remark that, although we obtain asymptotically Gaussian decay of fidelity for a single coherent initial state, one may be interested in an *effective fidelity* averaged with respect to phase space positions of initial coherent state [10]. In such a case one may typically get a power law decay due to possible points in the phase space where the theoretical expression for  $t_{\text{coh}}$  diverges (at the positions of zeroes of  $\mathbf{u}(\mathbf{j}^*)$  of eq. (70)), but still on a time scale  $\propto \delta^{-2}$ . Note that this *effective power law decay* is a general scenario and is not particular to the case of vanishing time-average perturbation (in the case of  $\bar{V} \neq 0$  the decay time scales as  $\delta^{-1}$ ).

### 5.3. Echo resonances in one dimension

Let us now discuss the behaviour of the fidelity for initial wavepackets in the regime of linear response approximation in some more detail. We shall consider possible deviations from the random phase approximation in the time dependent exponentials of eqs. (36,37) which have been invoked previously in order to derive time independent terms (38,39) of the fidelity plateau (40), and also (45). Specifically we will explain the resonances observed *e.g.* in figure 1.

For such a resonance to occur the phases of (36,37) have to build up in a constructive way and this is clearly impossible in a generic case, unless: (i) We have one dimension  $d = 1$  so we sum up over a one-dimensional array of integers  $n$  in the action space<sup>‡</sup>. (ii) The wavepacket is localized over a classically small region of the action space/lattice such that a variation of the frequency derivative  $d\omega(j)/dj$  over this region is sufficiently small. The quantitative conditions for the occurrence together with the strength and the shape of such resonances are discussed below.

In this subsection we thus consider a one-dimensional case,  $d = 1$ . Again we study time dependent terms of (36,37) which can all be cast into a general form (59), however, now the time is not small enough to enable the sum over quantum number to be estimated by an integral. On the contrary, we seek a condition that the consecutive phases in the exponential build up an interference pattern.

**5.3.1.  $2\pi$ -resonance:** Let us expand the frequency around the center of the packet

$$\omega(j) = \omega^* + (j - j^*)\omega' + \frac{1}{2}(j - j^*)^2\omega'' + \dots \quad (73)$$

<sup>‡</sup> In more than one dimension we would clearly need a strong condition on commensurability of frequency derivatives over the entire region of the action lattice where the initial state is supported.

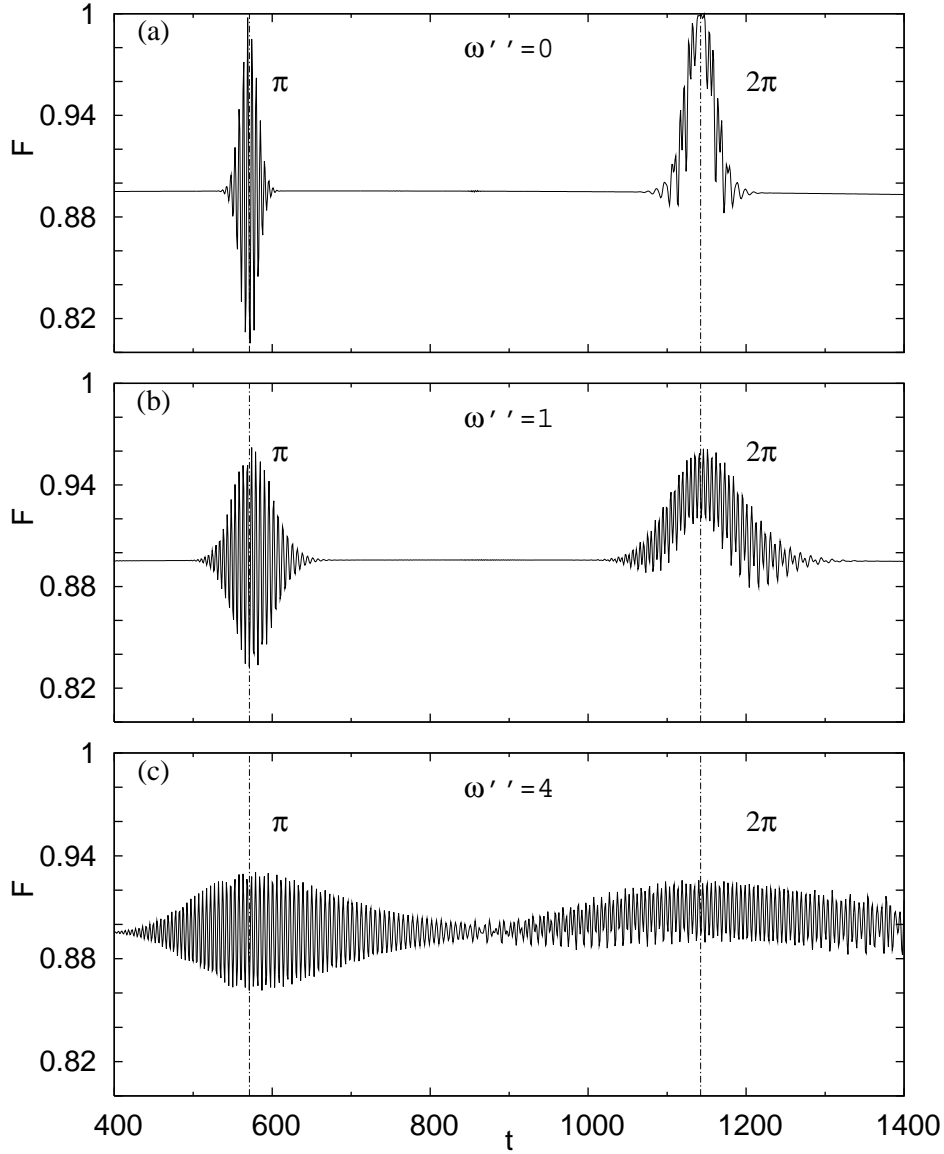

**Figure 3.** Structure of echo resonances for coherent initial states of the modified quantum top  $U_0 = \exp(-iS[\alpha(S_z/S)^2/2 + \gamma(S_z/S - j^*)^3/6])$ ,  $\alpha = 1.1$ ,  $S = 200$ ,  $\delta = 1.6 \cdot 10^{-3}$ , for increasing value of  $\omega'' = \gamma = 0$  (a),  $\omega'' = 1$  (b), and  $\omega'' = 4$  (c), which weakens and broadens the resonances. Note that in (a),  $\omega'' = 0$  we have the same data as in figure 1a. Vertical chain lines show theoretical times  $t_r/2$  for  $\pi$ , and  $t_r$  for  $2\pi$  resonance.

where

$$\omega^* = \omega(j^*), \quad \omega' = \frac{d\omega(j^*)}{dj}, \quad \omega'' = \frac{d^2\omega(j^*)}{dj^2}. \quad (74)$$

The phases in the sums of the form (59) come into resonance, for  $m = 1$  and hence for any higher  $m \geq 1$ , when they change by  $2\pi$  per quantum number, which happens at time  $t_r$

$$\hbar\omega't_r = 2\pi, \quad t_r = \frac{2\pi}{\hbar\omega'}. \quad (75)$$

and its integer multiples\*. Let time  $t$  be close to  $kt_r$ ,  $k \in \mathbb{Z}$ , and write  $t = kt_r + t'$  where  $t' \ll t_r$ , so that

$$\hbar\omega't' \ll 2\pi. \quad (76)$$

Now we can estimate the general time dependent term (59), where  $g(j)$  is again a smooth classical  $\hbar$ -independent function of  $j$  representing a suitable combination of Fourier coefficients  $v_m(j)$ , by: (i) shifting the time variable to  $t'$ , (ii) incorporating the resonance condition (75), and (iii) approximating the resulting sum by an integral, due to smallness of  $t'$  (76), which is a simple Gaussian:

$$\begin{aligned} & \sum_n g(\hbar n) e^{im\omega(\hbar n)t} D_\psi(\hbar n) \\ & \cong \sum_n g(\hbar n) e^{im(\omega^* + (\hbar n - j^*)\omega' + \frac{1}{2}(\hbar n - j^*)^2\omega'')(kt_r + t')} D_\psi(\hbar n) \\ & = e^{im(\omega^*t - \chi)} \sum_n g(\hbar n) e^{im((\hbar n - j^*)\omega't' + \frac{1}{2}(\hbar n - j^*)^2\omega''t)} D_\psi(\hbar n) \\ & \cong e^{im(\omega^*t - \chi)} g(j^*) \sqrt{\frac{\Lambda}{\pi\hbar}} \int dj e^{im((j - j^*)\omega't' + \frac{1}{2}(j - j^*)^2\omega''t) - \frac{\Lambda}{\hbar}(j - j^*)^2} \\ & = e^{im(\omega^*t - \chi)} g(j^*) \left(1 - i\frac{\hbar m\omega''t}{2\Lambda}\right)^{-1/2} \exp\left(-\frac{\hbar m^2\omega'^2t'^2}{4\Lambda} \frac{1 + i\frac{\hbar m\omega''t}{2\Lambda}}{1 + \left(\frac{\hbar m\omega''t}{2\Lambda}\right)^2}\right) \end{aligned} \quad (77)$$

where  $\chi = 2\pi k j^*/\hbar$ . From this calculation we deduce quantitative condition for the appearance and the shape of the resonance. Let  $\Delta_j = \langle (J - j^*)^2 \rangle^{1/2} = \sqrt{\frac{\hbar}{2\Lambda}}$  denote the action width of the wavepacket. Physically, we need that the coherence of linearly increasing phases is not lost along the size of the wavepacket, *i.e.*

$$\zeta := m\omega''t\Delta_j^2 = \frac{\hbar m\omega''t}{2\Lambda} < 2\pi. \quad (78)$$

$\zeta$  is precisely the coefficient appearing in the square-root prefactor and the exponential of the resonance profile (77). Indeed we see that with increasing  $\zeta$  the squared modulus of the peak of the resonance (at  $t' = 0$ ) dies out as  $(1 + \zeta^2)^{-1/2}$ . We note that  $\zeta$  increases with the increasing order  $k$  of the resonance, since  $t \approx kt_r$ , so

$$\zeta = km \frac{\pi \omega''}{\Lambda \omega'}. \quad (79)$$

Therefore we may get strong and numerous resonances, *i.e.* small  $\zeta$ , provided either the second derivative  $\omega''$  is small, or the initial state is squeezed such that  $\Lambda \gg 1$ . For example, if the second derivative vanishes everywhere,  $\omega'' \equiv 0$ , then the resonances may appear even for extended states. This is the case for our numerical model, where resonances can be seen also for a random state in figure 6.

From (77) we read that the temporal profile in such a fidelity resonance has a shape of a Gaussian of effective width

$$\Delta_t = \frac{\sqrt{1 + \zeta^2}}{m\omega'\Delta_j}, \quad (80)$$

\* It is interesting to note that these resonant times correspond precisely to the condition for *revivals* of the wavepacket in the *forward* evolution (apart from a phase-space translation) studied in Refs.[14].

modulated with an oscillation of frequency  $\cong \omega^*$ . Hence in order to feel the effect of the fidelity resonance, time  $t$  has to be within  $\Delta_t$  of the center of the resonance  $kt_r$ . In the semiclassical limit, the resonance positions scale as  $t_r \propto \hbar^{-1}$ , while their widths grow only as  $\Delta_t \propto \hbar^{-1/2}$ , so they are well separated. Also, with increasing order  $k$  the magnitudes of the peaks of the resonances decrease as  $\sim k^{-1/2}$ , while their widths increase as  $\sim k$ , so they will eventually, at  $k \propto \hbar^{-1/2}$ , start to overlap. This will happen at time  $\sim \hbar^{-3/2}$  which is smaller than  $\sim t_2$  provided  $\delta < \nu^{-1/2}\hbar$ .

The resonance described in this paragraph, which will be called a  $2\pi$ -resonance, affects *all* time dependent terms of (36,37), but its precise shape depends on coefficients  $\tilde{v}_m(j^*)e^{im\theta^*}$ . However, it is important to note that the fidelity can be explicitly calculated close to the center of the resonance,  $t' \ll \Delta_t$ , where the Gaussian factor of the right-most expression of (77) can be neglected. In addition we shall neglect the coefficient  $\zeta$  in (77) as we are particularly interested in the case of a strong resonance  $\zeta \ll 1$ . Then a simple calculation gives for the first moment of  $\Sigma_t$  (36)

$$\langle \Sigma_t \rangle \cong \sum_{m \neq 0} \tilde{v}_m(j^*)e^{im\theta^*} (1 - e^{im\omega^*t}), \quad (81)$$

while the second moment can be shown to be just  $\langle \Sigma_t^2 \rangle = \langle \Sigma_t \rangle^2$ , hence the fidelity is, around the center of a  $2\pi$ -resonance, equal to 1 within the linear response approximation

$$F(t) \cong 1, \quad \text{for } |t - kt_r| \ll \Delta_t, \text{ and } \zeta \ll 1. \quad (82)$$

We note that such a ‘flat-top’ structure of  $2\pi$ -resonance is nicely illustrated in a numerical example in figure 3, where we consider a slightly modified model with  $U_0 = \exp(-iS[\alpha(S_z/S)^2/2 + \gamma(S_z/S - j^*)^3/6])$ , and  $h_0(j) = \alpha j^2/2 + \gamma(j - j^*)^3/6$ , such that  $\omega'' = \gamma$  may not be identically vanishing.

*5.3.2.  $\pi$ - and  $2\pi/m$ -resonances:* We note that one may obtain a resonance condition for time dependent term (77) with fixed  $m$  for even shorter time, namely for  $t = t_r/m$ . This is trivially the case for perturbations with many, or at least more than one Fourier components with  $|m| > 1$ . However, in such cases only selected time dependent terms of the moments (36,37) will be affected, so the fidelity will generically *not come back to 1*, even in the linear response regime (8) and in the strongly resonant case  $\zeta \ll 1$ . Such (incomplete) resonances at fractional times  $(k/m)t_r$  will be called  $2\pi/m$ -resonances.

However, we may obtain a resonant condition at  $t = t_r/2$  even for the first Fourier component  $m = 1$  of the perturbation, due to taking the square of the operator  $\Sigma_t$  thus producing Fourier number  $m + m' = \pm 2$  in the last term on the RHS of eq. (37). Such a resonant behaviour at times  $(k + \frac{1}{2})t_r$  will be called a  $\pi$ -resonance.

So for perturbations with a *single* Fourier mode  $m = \pm 1$ , or more generally with only odd-numbered Fourier modes  $m = 2l + 1$ , the  $\pi$ -resonance can affect only the last term of the second moment (37) while it cannot affect the first moment (36), which is given by its time averaged value (61). To see this, we observe that the time dependent parts of form  $g(\hbar n)e^{im\omega t}$  in  $\langle \Sigma_t \rangle$  and  $\langle \Sigma_t^2 \rangle$  are proportional to  $\sum_n D_\psi(\hbar n)g(\hbar n)(-1)^{mn}$ . As  $m$  is an odd number and  $D_\psi(\hbar n)g(\hbar n)$  is a smooth function of  $n$  this sum averages

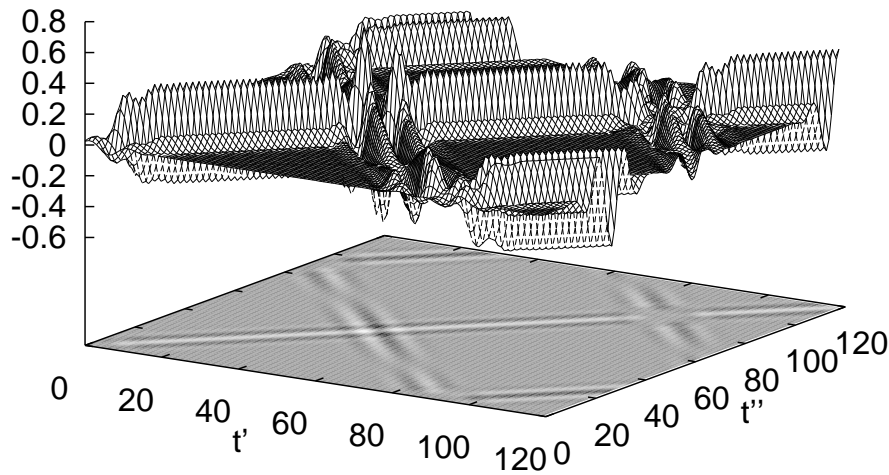

**Figure 4.** The two-time correlation function  $C(t', t'')$  (6) for the quantized top with  $\alpha = 1.1, \beta = 0, \gamma = 0, S = 16$ , and coherent initial state.

to zero. All this allows us to again explicitly compute the linear response fidelity (8) close to the peak in a strongly resonant case, namely

$$\langle \Sigma_t \rangle \cong \sum_{m=2l+1} \tilde{v}_m(j^*) e^{im\theta^*}, \quad \text{for } |t - (k + \frac{1}{2})t_r| \ll \Delta_t, \text{ and } \zeta \ll 1, \quad (83)$$

$$\langle \Sigma_t^2 \rangle \cong \left( \sum_{m=2l+1} \tilde{v}_m(j^*) e^{im\theta^*} \right)^2 + \left( \sum_{m=2l+1} \tilde{v}_m(j^*) e^{im(\theta^* + \omega^* t)} \right)^2, \quad (84)$$

$$F(t) \cong 1 - \frac{4\delta^2}{\hbar^2} \left( \sum_{m=2l+1}^{m>0} |\tilde{v}_m(j^*)| \cos(m\omega^* t + \beta_m) \right)^2, \quad (85)$$

where  $\beta_m$  are phases of complex numbers  $\tilde{v}_m(j^*) e^{im\theta^*}$ . So we have learned that the fidelity at the peak of a  $\pi$ -resonance displays an oscillatory pattern, oscillating precisely around the plateau value  $F_{\text{plateau}}$  (63) with an amplitude of oscillations equal to  $1 - F_{\text{plateau}}$  so that the fidelity comes back to 1 close to the peak of the resonance.

Again, our numerical example illustrates such an oscillatory structure of  $\pi$ -resonance in figure 3. The resonances can also be nicely seen in ‘short-time’ figure 1, and because  $\zeta = 0$  also in the ‘long-time’ figure 2. In figure 4 we depict the structure of  $\pi$ - and  $2\pi$ -resonance as reflected in the two-time correlation function  $C(t', t'')$ . Note that the first intersection of the soliton-like-trains for  $t' - t'' = \text{const}$  and  $t + t' = \text{const}$  happens at  $t_r/2$  and produces a  $\pi$ -resonance, while the second intersection at  $t_r$  produces a  $2\pi$ -resonance.

In analogy to the emergence of a  $\pi$ -resonance as a consequence of the contribution from the *second* moment of  $\Sigma_t$ , even for the first Fourier mode  $m = 1$ , we shall eventually obtain also fractional  $2\pi/p$ -resonances at times  $(k/p)t_r$  in the non-linear-response regimes where higher moments  $\langle \Sigma_t^p \rangle$  contribute to  $F(t) \sim \langle \exp(i\Sigma_t \delta/\hbar) \rangle$ , eq. (45). This is illustrated numerically in figure 1c showing the case of strong perturbation

$\delta S = 3.2$  so that higher orders are important. One indeed obtains fractional resonances, some of which have been marked on the figure.

#### 5.4. Illustration in terms of echoed Wigner functions

All the phenomena described theoretically in the preceding subsections can be nicely illustrated in terms of the *echoed Wigner function* — the Wigner function  $W_{M_\delta(t)|\psi}(\mathbf{q}, \mathbf{p})$  of the echo-dynamics. Namely, according to formula (67) the fidelity  $F(t)$  is given simply by the overlap of the echoed Wigner function and the Wigner function of the initial state. Therefore, the phase-space chart of the echoed Wigner function contains the most detailed information on echo-dynamics and illustrates the essential differences between different regimes of fidelity decay. This is shown in figure 5 (see [15]) for the quantized top where the Wigner function on a sphere is computed according to Ref.[16]. In the initial *classical regime*,  $t < t_1$ , the echoed Wigner function has not yet developed negative values and is in point-wise agreement with the Liouville density of the classical echo-dynamics. In the *plateau regime*,  $t_1 < t < t_2$ , the echoed Wigner function decomposes into several pieces, one of which freezes at the position of the initial packet providing significant and constant overlap — the plateau. At very particular values of time, namely at the echo resonances, different pieces of the echoed Wigner function somehow magically recombine back into the initial state (provided  $\zeta \ll 1$ ). In the asymptotic, *ballistic regime*,  $t > t_2$ , even the frozen piece starts to drift ballistically away from the position of the initial packet, thus explaining a fast Gaussian decay of fidelity.

## 6. Semiclassical asymptotics: random initial state

The second specific case of interest is that of a random initial state. Here we shall assume that our Hilbert space has a finite dimension  $\mathcal{N}$ , like e.g. in the case of the kicked top or a general quantum map with a finite classical phase space, or it is determined by some large classically invariant region of phase space, e.g. we may consider all states  $|\mathbf{n}\rangle$  between two energy surfaces  $E_1 < h_0(\hbar\mathbf{n}) < E_2$  of an autonomous system. In any case we have the scaling

$$\mathcal{N} \cong \frac{\mathcal{V}}{\hbar^d} \tag{86}$$

where  $\mathcal{V}$  is the classical  $d$ -volume of the populated action space region of interest. The notion of a random state refers to an ensemble average over the full Hilbert space of interest. So we treat the complex coefficients  $\psi_{\mathbf{n}}$  as pairs of components of a vector on a  $2\mathcal{N}$ -dimensional unit sphere. In the asymptotic regime of large  $\mathcal{N}$ , these can in turn be replaced by independent complex Gaussian variables with the variance

$$\langle\langle \psi_{\mathbf{n}'}^* \psi_{\mathbf{n}} \rangle\rangle \cong \frac{1}{\mathcal{N}} \delta_{\mathbf{n}'\mathbf{n}}, \quad \langle\langle \psi_{\mathbf{n}'} \psi_{\mathbf{n}} \rangle\rangle \cong 0, \tag{87}$$



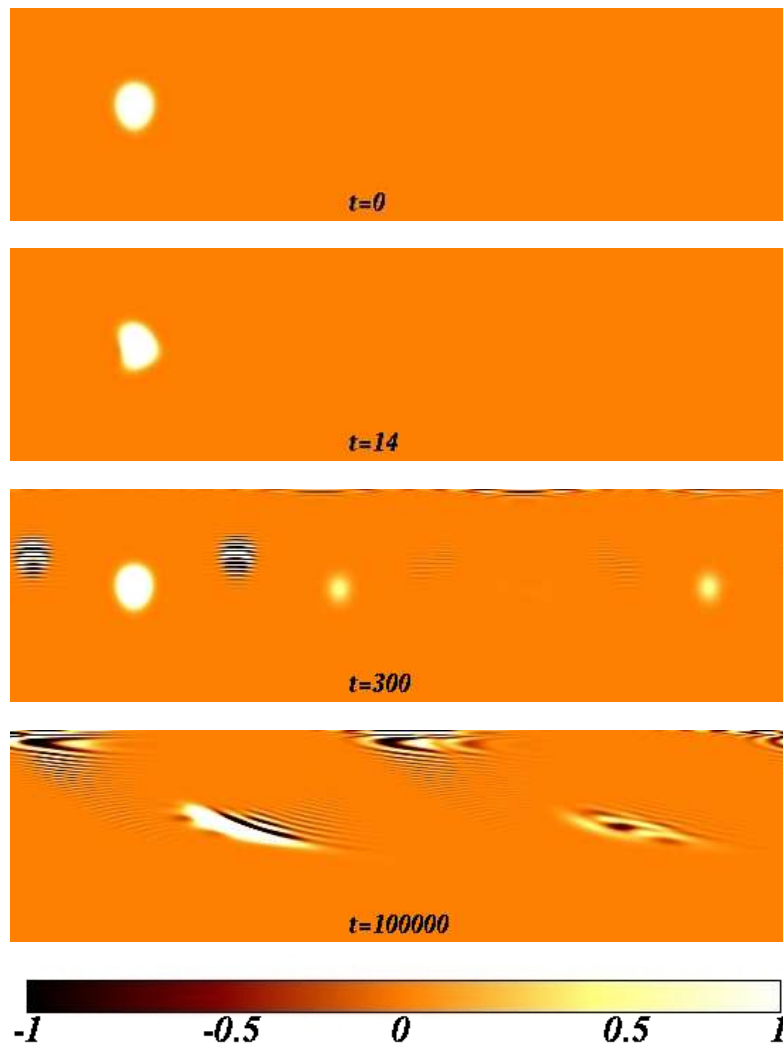

**Figure 5.** (Movies online [15]) Snapshots of the Wigner function of echo-dynamics for quantized top  $\alpha = 1.1, \beta = 0, \gamma = 0$  with  $S = 200$  and for  $\delta = 1.6 \cdot 10^{-3}$  (same as in figures 1a,3a). The upper phase-hemi-sphere is shown with  $j = \cos \vartheta \in [0, 1]$  on the vertical axis and  $\theta = \varphi \in [0, 2\pi]$  on the horizontal axis. From top to bottom we show: the initial state at  $t = 0$ , the state at  $t = 14 \approx t_1$  when we are around the regular Ehrenfest time, at  $t = 300$  in the middle of the plateau, and at  $t = 100000$  in the ballistic regime. The bar below shows the color-code of the Wigner function values.

where  $\langle\langle \bullet \rangle\rangle$  denotes an ensemble average over random states. When we write such an average for an operator, we actually mean

$$\langle\langle A \rangle\rangle := \langle\langle \langle \psi | A | \psi \rangle \rangle \rangle = \frac{1}{\mathcal{N}} \text{tr } A. \quad (88)$$

Note that a trivial application of the pair-contraction rule (Wick theorem) yields that averaged fidelity is asymptotically the same as the averaged fidelity amplitude squared [12]

$$\langle\langle F(t) \rangle\rangle = \langle\langle |f(t)|^2 \rangle\rangle = |\langle\langle f(t) \rangle\rangle|^2 + \frac{1}{\mathcal{N}} \cong |\langle\langle f(t) \rangle\rangle|^2. \quad (89)$$

This means that the fidelity amplitude is self-averaging, *i.e.* its variance with respect to random state averaging is semiclassically vanishing. The same property holds for the fidelity itself,  $\langle\langle F^2 \rangle\rangle - \langle\langle F \rangle\rangle^2 = \mathcal{O}(1/\mathcal{N})$ .

### 6.1. The plateau: Linear response and beyond

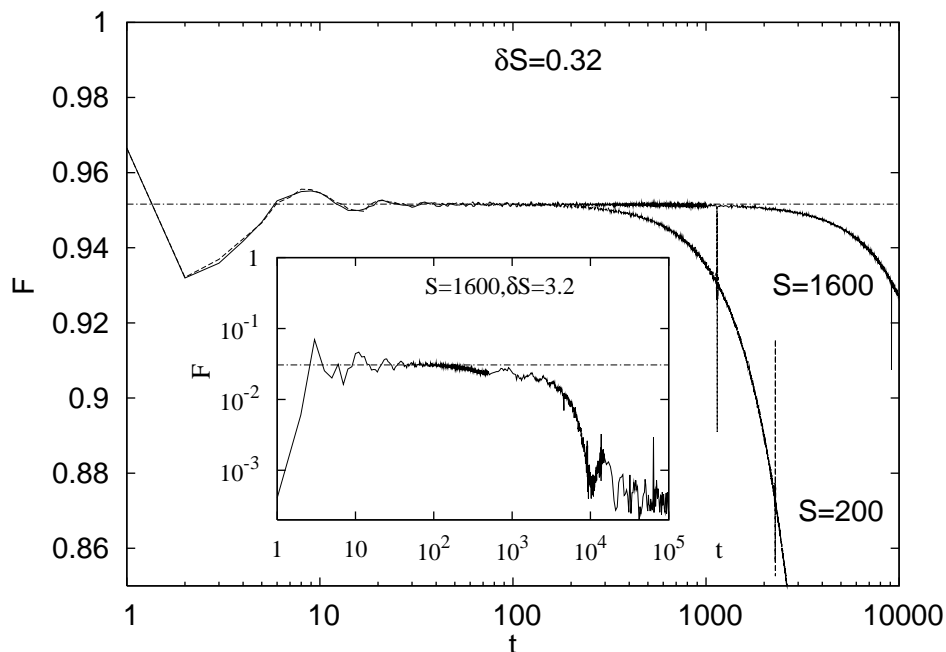

**Figure 6.** Short time fidelity for a quantized top with  $\alpha = 1.1, \beta = 1.4$  and random initial state. To reduce statistical fluctuations, averaging over 20 realizations of initial random states is performed for  $S = 1600$ , and over 100 initial states for  $S = 200$ . The horizontal chain line is the semiclassical theory (78). Resonances are here present due to the special property  $\omega''(j) = 0$  and will be absent for a more generic unperturbed system. The main figure shows the case of weak perturbation  $\delta S = 0.32$ , whereas the inset shows the case of strong perturbation  $\delta S = 3.2$ .

In computing the ensemble average of the linear response formula (8) we have to compute ensemble averages of the expressions (36,37). This is a straightforward application of (87) for (37), and the pair-contraction rule for (36)

$$\begin{aligned} \langle\langle \Sigma_t^2 \rangle\rangle &\cong \frac{\tau^2}{\mathcal{N}} \sum_{\mathbf{n}} \sum_{\mathbf{m} \neq 0} |v_{\mathbf{m}}(\hbar \mathbf{n})|^2 \frac{\sin^2\left(\frac{1}{2} \mathbf{m} \cdot \boldsymbol{\omega}(\hbar \mathbf{n}) t\right)}{\sin^2\left(\frac{1}{2} \mathbf{m} \cdot \boldsymbol{\omega}(\hbar \mathbf{n})\right)} \\ &\cong \frac{\tau^2}{\mathcal{V}} \int d^d \mathbf{j} \sum_{\mathbf{m} \neq 0} |v_{\mathbf{m}}(\mathbf{j})|^2 \frac{\sin^2\left(\frac{1}{2} \mathbf{m} \cdot \boldsymbol{\omega}(\mathbf{j}) t\right)}{\sin^2\left(\frac{1}{2} \mathbf{m} \cdot \boldsymbol{\omega}(\mathbf{j})\right)}, \end{aligned} \quad (90)$$

$$\langle\langle \Sigma_t \rangle\rangle^2 \cong \frac{1}{\mathcal{N}} \langle\langle \Sigma_t^2 \rangle\rangle. \quad (91)$$

We note that the expression (90) is just the classical phase space average  $\langle \sigma_t^2 \rangle_{\text{cl}}$  where  $\sigma_t(\mathbf{j}, \boldsymbol{\theta}) = \sum_{t'=0}^{t-1} v(\mathbf{j}, \boldsymbol{\theta} + \boldsymbol{\omega}(\mathbf{j})t')$  is the classical limit of  $\Sigma_t$ . We see that for a random

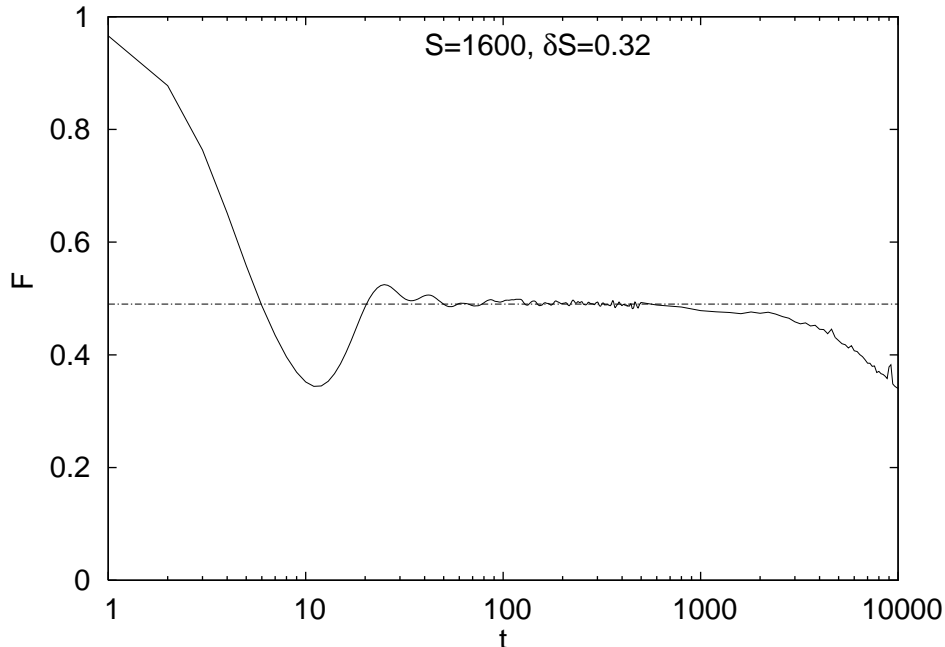

**Figure 7.** Short time fidelity for  $\alpha = 1.1, \beta = 0, S = 1600, \delta S = 0.32$  and random initial state. The chain line shows the theoretical value of the plateau as computed from the formula (98).

state the contribution of the square of the expectation value (91) is semiclassically small so the plateau in fidelity is within the linear response approximation determined by the second moment (90).

On one hand, let us assume that

$$\mathbf{m} \cdot \boldsymbol{\omega}(\mathbf{j}) \neq 0 \pmod{2\pi} \quad (92)$$

for all contributing Fourier components  $\mathbf{m}$  and for all  $\mathbf{j}$  from the classical action space of interest. In such a case the  $\sin^2$  in the denominator of (90) is never vanishing, so the integral has no problem with singularities, while the  $\sin^2$  in the numerator can be averaged, either over a short period of time, or over small regions of phase space for sufficiently long time  $t > t_1$ , in both cases yielding a trivial factor of 1/2. In any case, the convergence timescale  $t_1$  here is classical, and of course, does not depend on the strength of the perturbation  $t_1 \sim \hbar^0 \delta^0$ . Hence in such a *non-singular* case, the linear response plateau of the fidelity reads

$$\langle\langle F(t) \rangle\rangle \cong 1 - \frac{\delta^2}{\hbar^2} \nu_{\text{ran}} + \mathcal{O}(\delta^4), \quad (93)$$

$$\nu_{\text{ran}} = \frac{\tau^2}{\mathcal{V}} \int d^d \mathbf{j} \sum_{\mathbf{m} \neq \mathbf{0}} \frac{|v_{\mathbf{m}}(\mathbf{j})|^2}{2 \sin^2(\frac{1}{2} \mathbf{m} \cdot \boldsymbol{\omega}(\mathbf{j}))}. \quad (94)$$

Going beyond the linear response approximation we again use the general formula (45), and compute the expectation value of an operator in the random state in terms of the

classical phase-space average

$$\langle\langle g(\mathbf{J}, \Theta) \rangle\rangle \cong \frac{1}{(2\pi)^d \mathcal{V}} \int d^d \mathbf{j} \int d^d \boldsymbol{\theta} g(\mathbf{j}, \boldsymbol{\theta}), \quad (95)$$

that is

$$\langle\langle f_{\text{plateau}} \rangle\rangle \cong \frac{1}{\mathcal{V}} \int d^d \mathbf{j} \left| \int \frac{d^d \boldsymbol{\theta}}{(2\pi)^d} \exp\left(\frac{i\delta}{\hbar} \tilde{v}(\mathbf{j}, \boldsymbol{\theta})\right) \right|^2. \quad (96)$$

If, on the other hand, the condition (92) does not hold, i.e. if there exist values of the action  $\mathbf{j}$ , and  $\mathbf{m} \in \mathbb{Z}^d$ ,  $k \in \mathbb{Z}$ , such that  $\mathbf{m} \cdot \boldsymbol{\omega}(\mathbf{j}) = 2\pi k$ , then the denominator of (90) becomes *singular* and the corresponding term (in the appropriate limit) grows in time. However this growth stops, at least on a timescale  $\sim \hbar^{-1}$ , due to a discrete nature of the quantum action space. At this time the value of the correlation integral, the plateau, will be typically so small that it cannot be described within the linear response approximation, so we have to employ the general formula (45). The only modification of the general formula, with respect to a non-singular case (96), is the observation that the quantum phase space is in fact discrete in action so one should semiclassically approximate the expectation value with the sum, instead of an integral,

$$\langle\langle g(\mathbf{J}, \Theta) \rangle\rangle \cong \frac{1}{\mathcal{N}} \sum_{\mathbf{n}} \frac{1}{(2\pi)^d} \int d^d \boldsymbol{\theta} g(\hbar \mathbf{n}, \boldsymbol{\theta}). \quad (97)$$

Furthermore, the diverging terms  $v_{\mathbf{m}}/\sin(\mathbf{m} \cdot \boldsymbol{\omega}/2)$  in  $\tilde{v}_{\mathbf{m}}$  (27) come from the semiclassical approximation for  $\Sigma_t$  whose quantum counterpart has matrix elements proportional to  $V_{mn}/\sin[(\phi_m - \phi_n)/2]$ . As we consider perturbations with a zero average,  $V_{mm} \equiv 0$ , the diverging terms are absent in the quantum operator  $\Sigma_t$ . Therefore to remedy the random state formula for  $f_{\text{plateau}}$  (96) we simply replace an integral with the summation excluding the divergent terms, so the general final result reads

$$\langle\langle f_{\text{plateau}} \rangle\rangle \cong \frac{1}{\mathcal{N}} \sum_{\mathbf{n}}^{\mathbf{m} \cdot \boldsymbol{\omega}(\hbar \mathbf{n}) \neq 2\pi k} \left| \int \frac{d^d \boldsymbol{\theta}}{(2\pi)^d} \exp\left(\frac{i\delta}{\hbar} \tilde{v}(\hbar \mathbf{n}, \boldsymbol{\theta})\right) \right|^2. \quad (98)$$

Again we find an excellent confirmation of our theoretical predictions in the numerical experiment. In the first calculations we choose the shift  $\beta = 1.4$  so that we have no singular frequency throughout the action space. In figure 6 we demonstrate the plateau, which in the case of random states starts earlier than for coherent states, namely at  $t_1 \propto \hbar^0 \delta^0$ . The value of the plateau can be calculated by numerically evaluating the integrals occurring in eq. (94), for the linear response approximation, or eq. (96) in general. The integral over the angle  $\theta$  in the formula for the plateau (96) again gives a Bessel function so that we end up with a numerical integration over  $j$

$$\langle\langle F_{\text{plateau}} \rangle\rangle \cong \left[ \frac{1}{2} \int_{-1}^1 dj J_0^2 \left( \delta S \frac{\sqrt{1-j^2}}{2 \sin\{\alpha(j-\beta)/2\}} \right) \right]^2. \quad (99)$$

Observe that the random state plateau is just a square of the action-space average of a coherent state expression (68). Horizontal chain lines in figure 6 correspond to this theoretical values and agree with the numerics, both for weak perturbation  $\delta S = 0.32$  and strong perturbation  $\delta S = 3.2$  (inset). The plateau lasts up to  $t_2$  which is for random

states  $\hbar$ -independent,  $t_2 \sim 1/\delta$ . Small resonances visible in the figures are due to the fact that the Hamiltonian is a quadratic function of the action and therefore  $\omega'' \equiv 0$ , so that the resonance condition (75) is satisfied also for extended states (78). For a more generic Hamiltonian these narrow resonant spikes will be absent. In figure. 7 we also demonstrate the plateau in the fidelity for the zero-shift case  $\beta = 0$  with a singular-frequency,  $\omega(j = 0) = 0$ , where we again find an excellent agreement with the theoretical prediction (98). In this case the theoretical value has been obtained by replacing an integral in (99) with a sum over  $n$  (replacing  $j = \hbar n$ ) and summing over all quantum numbers except  $n = 0$ . Observe that the value of the plateau is much lower than in the case of a non-zero shift  $\beta = 1.4$  in figure 6.

### 6.2. Asymptotic regime of long times

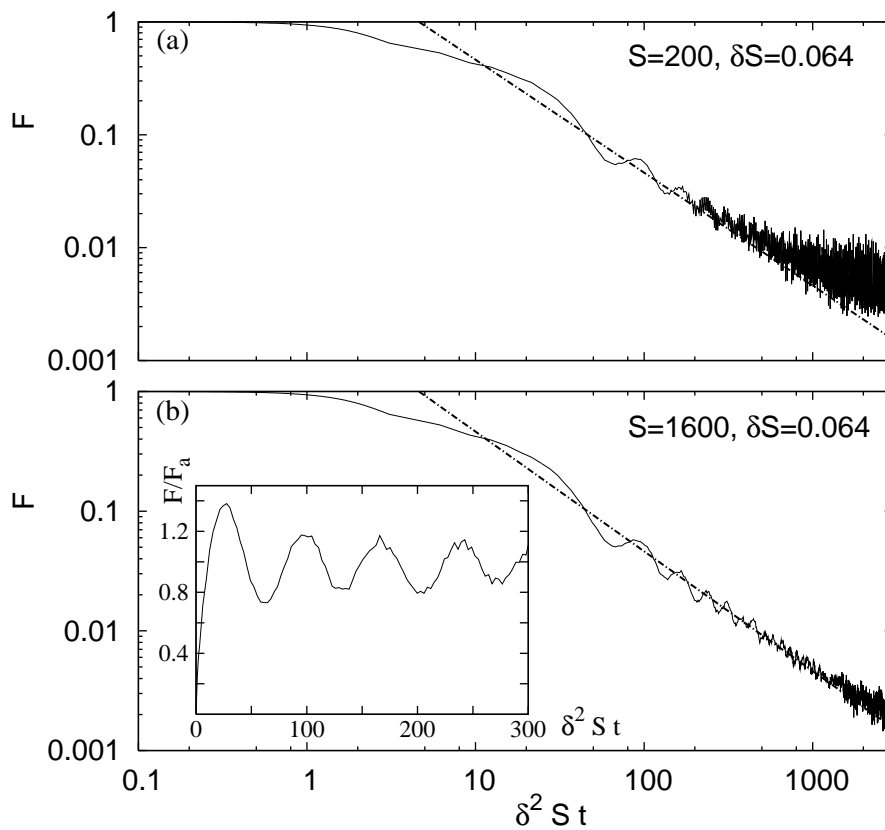

**Figure 8.** Long time fidelity for random states for quantized top with  $\alpha = 1.1$ ,  $\beta = 0$ , for  $S = 200$  (a), and  $S = 1600$  (b). Here  $\delta S = 0.064$  and averaging for  $S = 200$ , and  $S = 1600$ , is performed over 1000, and 20, initial random states, respectively. Heavy chain line is the theoretical asymptotic decay (100) with analytically computed prefactor (no fitting parameters). The inset in the bottom figure shows the diffractive quotient between the numerical fidelity and the asymptotic formula (101) (chain line in the main figure).

Again, after sufficiently long time  $t_2 \sim \delta^{-1}$ , the second term in BCH expansion (17) will be dominating and we shall use the ensemble average of the ASI formula (31) where

$$\langle\langle D_\psi \rangle\rangle = \frac{1}{\mathcal{N}}$$

$$\langle\langle f(t) \rangle\rangle \cong \frac{1}{\mathcal{V}} \int d^d \mathbf{j} \exp \left( i \frac{\tau \delta^2}{2\hbar} \bar{v}(\mathbf{j}) t \right). \quad (100)$$

The semiclassical computation of such an integral is an elementary application of stationary phase method in  $d$ -dimensions, following [6] for the analogous case of a generic observable. The condition for the validity of stationary phase method is that  $t\delta^2/\hbar > 1$  which will turn out to be consistent with the assumption  $t > t_2$ . Let  $\mathbf{j}_\eta, \eta = 1, \dots, p$  be the  $p$  points where the phase of the exponential on RHS of (100) is stationary,  $\partial \bar{v}(\mathbf{j}_\eta)/\partial \mathbf{j} = 0$ . This yields a simple result

$$\langle\langle f(t) \rangle\rangle \cong \frac{(2\pi)^{3d/2}}{\mathcal{V}} \left| \frac{\hbar}{t\tau\delta^2} \right|^{d/2} \sum_{\eta=1}^p \frac{\exp \{ i \bar{v}(\mathbf{j}_\eta) t \tau \delta^2 / (2\hbar) + i \nu_\eta \}}{|\det W_\eta|^{1/2}}, \quad (101)$$

where

$$(W_\eta)_{jk} := \frac{\partial^2 \bar{v}(\mathbf{j}_\eta)}{\partial j_k \partial j_l} \quad (102)$$

is a matrix of second derivatives at the stationary point  $\eta$ , and  $\nu_\eta = \pi(m_+ - m_-)/4$  where  $m_\pm$  are numbers of positive/negative eigenvalues of the matrix  $W_\eta$ . Here we should remember that the asymptotic formula (100) has been obtained as a stationary phase approximation of an integral in the limit of an infinite action space. If we have a finite region of the action space, the stationary phase approximation of (100) gives additional oscillating prefactor, whose amplitude dies out as  $(\hbar/t)^{1/2}$  for  $\hbar \rightarrow 0$  and/or  $t \rightarrow \infty$ , and which can be interpreted as a *diffraction*. This oscillating prefactor can be seen in numerical data for fidelity in the inset of figure 8.

So we have found that, apart from possible oscillation due to phase differences if  $p > 1$ , the fidelity will for a random state asymptotically decrease with a power law

$$\langle\langle F(t) \rangle\rangle \sim \left( \frac{t}{t_{\text{ran}}} \right)^{-d}, \quad t_{\text{ran}} = \text{const} \frac{\hbar}{\delta^2}. \quad (103)$$

Note that for a random initial state, the actual transition time scale  $t_2$ , as predicted by eq.(30), indeed does not depend on  $\hbar$ .

The above theory is again quantitatively confirmed in figure 8 for the quantized top with  $\alpha = 1.1, \beta = 0$ , where a (single) stationary point needed for the formula (101) had to be calculated numerically.

## 7. Discussion

In the present paper we have elaborated a semiclassical theory of quantum fidelity decay for systems with an integrable classical counterparts, perturbed by observables of vanishing time average. Such perturbations may not be generic, but provide important special class of perturbations which are often enforced by symmetries.

We have found that quantum fidelity will generally, after initial decay on a short perturbation independent timescale  $t_1$ , exhibit a saturation around a constant value

— the plateau, and stay there up to time  $t_2$ , such that the time span of the plateau  $t_2/t_1 \sim 1/\delta$  can be made arbitrary long for small perturbation  $\delta$ . After the plateau,  $t > t_2$ , the fidelity will decay as a Gaussian for a coherent initial state, or as a power law  $t^{-d}$  for random initial states, just to name the two most important specific cases, where the timescale of decay is generally proportional to  $\delta^{-2}$ . This must be contrasted with the decay in the regular case of a non-zero time-average perturbation [6] where the decay time scales with the perturbation strength as  $\delta^{-1}$ . In the case of localized initial wavepackets in one dimension, we observe and explain the effect of echo resonances, *i.e.* the sudden revivals of fidelity at perturbation independent and equally spaced instants of time.

The freezing of fidelity is a distinct quantum phenomenon, as the corresponding classical fidelity for the initial Gaussian wavepacket displays a power-law decay  $t^{-d}$  [8] after the point  $t_1$  where the quantum plateau starts. The classical fidelity decays on a time scale  $\delta^{-1}$  no matter what the average value of the perturbation is, while the time scale of quantum fidelity decay drastically changes from  $\delta^{-1}$  to  $\delta^{-2}$ , having  $\bar{V} = 0$ . This increased stability of regular quantum systems to perturbations with a zero time average could be potentially useful in constructing quantum devices [17]. This is even more so because the plateau also exists for random initial states which are expected to be more relevant for efficient quantum information processing.

## Acknowledgements

Useful discussions with T. H. Seligman, G. Veble, G. Benenti and G. Casati are gratefully acknowledged. The work has been financially supported by the Ministry of Science, Education and Sport of Slovenia, and in part by the grant DAAD19-02-1-0086, ARO, United States.

## References

- [1] Peres A 1984 Phys. Rev. A **30** 1610–15; see also Peres A 1995 *Quantum Theory: Concepts and Methods* (Dordrecht: Kluwer).
- [2] Jalabert R A and Pastawski H M 2001 Phys. Rev. Lett. **86** 2490
- [3] Pastawski H M *et al.* 1995 Phys. Rev. Lett. **75** 4310;  
 Levstein P R *et al.* 1998 J. Chem. Phys. **108** 2718;  
 Cerruti N R and Tomsovic S 2002 Phys. Rev. Lett. **88** 054103;  
 Cucchiatti F M *et al.* 2002 Phys. Rev. E **65** 046209;  
 Wisniacki D A *et al.* 2002 Phys. Rev. E **65** 055206;  
 Wisniacki D A and Cohen D 2002 Phys. Rev. E **66** 046209;  
 Berman G P *et al.* 2002 Phys. Rev. E **66** 056206;  
 Wang W G and Baowen Li 2002 Phys. Rev. E **66** 056208;  
 Benenti G and Casati G 2002 Phys. Rev. E **66** 066205;  
 Jacquod Ph *et al.* 2002, Phys. Rev. Lett. **89** 154103;  
 Karkuszewski Z P *et al.* 2002, Phys. Rev. Lett. **89** 170405;  
 Weinstein Y S *et al.* 2002 Phys. Rev. Lett. **89** 214101;  
 Emerson J *et al.* 2002 Phys. Rev. Lett. **89** 284102;

- Kottos T and Cohen D 2003 Europhys. Lett. **61** 431;  
Wisniacki D A 2003 Phys. Rev. E **67** 016205;  
Silvestrov P G *et al* 2003 Phys. Rev. E. **67** 025204;  
M. F. Andersen, A. Kaplan, N. Davidson 2003, Phys. Rev. Lett. **90** 023001;  
Žnidarič M and Prosen T 2003, J. Phys. A:Math. Gen. **36** 2463;  
Benenti G, Casati G and Veble G 2003, Phys. Rev. E **67** 055202(R);  
Vanicek J and Heller E J 2003, preprint [quant-ph/0302192](http://arxiv.org/abs/quant-ph/0302192);  
Sankaranarayanan R and Lakshminarayan A 2003, preprint [nlin.CD/0307005](http://arxiv.org/abs/nlin.CD/0307005);  
Goussev A and Dorfman J R 2003, preprint [nlin.CD/0307025](http://arxiv.org/abs/nlin.CD/0307025).
- [4] Prosen T, 2002 Phys. Rev. E **65** 036208  
[5] Prosen T and Žnidarič M 2001 J. Phys. A: Math. Gen. **34** L681  
[6] Prosen T and Žnidarič M 2002 J. Phys. A: Math. Gen. **35** 1455  
[7] Jacquod Ph, Silvestrov P G and Beenakker C W J 2001 Phys. Rev. E **64** 055203(R)  
[8] Benenti G, Casati G and Veble G 2003, preprint [nlin.SI/0304032](http://arxiv.org/abs/nlin.SI/0304032)  
[9] Eckhardt B 2003 J. Phys. A: Math. Gen **36** 371  
[10] Jacquod Ph, Adagideli I and Beenakker C W J 2003 Europhys. Lett. **61** 729  
[11] Fox R F and Elston T C 1994 Phys. Rev. E **50** 2553  
[12] Prosen T, Seligman T H and Žnidarič M 2003, preprint [quant-ph/0304104](http://arxiv.org/abs/quant-ph/0304104)  
[13] See e.g. Berry M V 1977 Philos. Trans. R. Soc. London A **287** 237  
[14] Braun P A and Savichev V I 1996 J. Phys. B: At. Mol. Opt. Phys. **29** L329; see also related general discussion in Leichtle C, Averbukh I Sh and Schleich W P 1996 Phys. Rev. A **54** 5299  
[15] See movies at <http://chaos.fiz.uni-lj.si/papers/freeze>.  
[16] Agarwal G S 1981 Phys. Rev. A **24** 2889  
[17] Nielsen M A and Chuang I L 2000 *Quantum computation and quantum information* (Cambridge University Press)