

# Conditional two mode squeezed vacuum teleportation

P. T. Cochrane,\* T. C. Ralph, and G. J. Milburn

*Department of Physics, The University of Queensland,*

*St. Lucia, Queensland 4072, Australia*

(Dated: November 3, 2018)

## Abstract

We show, by making conditional measurements on the Einstein-Podolsky-Rosen (EPR) squeezed vacuum, that one can improve the efficacy of teleportation for both the position difference, momentum sum and number difference, phase sum continuous variable teleportation protocols. We investigate the relative abilities of the standard and conditional EPR states, and show that by conditioning we can improve the fidelity of teleportation of coherent states from below to above the  $\bar{F} = 2/3$  boundary.

PACS numbers: 42.50, 03.67, 03.67.H

arXiv:quant-ph/0108051v1 10 Aug 2001

---

\*Electronic address: [cochrane@physics.uq.edu.au](mailto:cochrane@physics.uq.edu.au)

## I. INTRODUCTION

Over recent times teleportation has shown itself to be a fundamental building block in the business of quantum information processing [1, 2, 3, 4, 5, 6] coming in both discrete and continuous formulations [1, 5, 7, 8]. In continuous variable teleportation the entanglement resource is the two-mode squeezed state, or the Einstein-Podolsky-Rosen (EPR) state[18]. The quality of teleportation depends upon how squeezed the EPR state can be made. High levels of squeezing are hard to achieve, so other techniques for improving teleportation can be considered. Opatrný *et al.* [9] showed that one can improve standard continuous variable teleportation by conditioning off detection results from very slightly reflective beam splitters inserted into each arm of the entanglement resource. Making such conditional measurements selects a sub-ensemble of more highly entangled states which can then be used to teleport more effectively. From this point of view it is similar to a distillation protocol. The conditioning procedure also gives information on when one should attempt to teleport the input state, thereby improving the efficiency of teleportation. In this paper we look at a number of generalisations to the original scheme. In particular we consider the relative merits of the conditioned and unconditioned EPR states. We also give an extension to the number difference, phase sum teleportation protocol of Milburn and Braunstein [10], and analyze the effectiveness of conditioning for improving coherent state teleportation for a range of conditions.

## II. IMPROVEMENT OF THE ENTANGLEMENT RESOURCE

Following Opatrný *et al.*, we introduce highly transmitting beam splitters into each EPR beam and look for coincidences occurring from only one photon being “shaved” off each beam. Such coincidences tell us when we have a “good” resource and therefore when we should teleport, it merely being a matter of time to wait for such an occurrence. We introduce two entanglement resources produced by these conditional measurements: the photon subtracted EPR state and the photon added EPR state. Consider the experimental schematic shown in Fig. 1. To obtain an expression for the photon subtracted EPR state we calculate the effect of introducing a beam splitter into each beam of the EPR state and expand to second order in the beam splitter reflectivity  $\theta$  (since  $\theta$  is small) and condition on

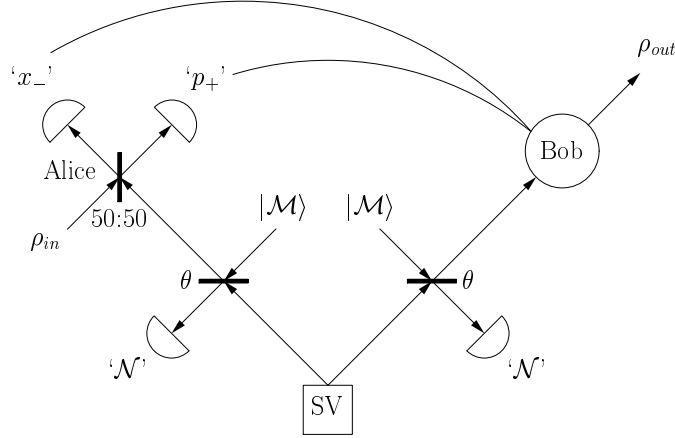

FIG. 1: Schematic of continuous variable teleportation. SV is the two mode squeezed vacuum entanglement resource, one beam of which goes to Alice, the other to Bob. Alice mixes the unknown input state  $\rho_{in}$  on the 50:50 beam splitter and measures position difference  $x_-$ , and momentum sum  $p_+$ . She sends this information to Bob via a classical channel who then makes the relevant unitary operations on his beam dependent upon the information from Alice to recreate the input state at his location  $\rho_{out}$ . The conditional resource is made by inserting beam splitters of reflectivity  $\theta$  in each arm of the teleporter, then putting a Fock state  $|\mathcal{M}\rangle$  at the spare port of the beam splitters and detecting  $\mathcal{N}$  at the detectors.

the result  $\mathcal{N} = 1$  at each detector with the vacuum at the spare port of each beam splitter ( $\mathcal{M} = 0$ ). The photon subtracted state in the Fock basis is

$$|\psi\rangle_{p.s.} = \sqrt{\frac{(1-\lambda^2)^3}{1+\lambda^2}} \sum_{n=0}^{\infty} (n+1)\lambda^n |n, n\rangle_{AB} \quad (1)$$

where  $\lambda$  is the squeezing parameter,  $A$  and  $B$  refer to the sender (Alice) and receiver's (Bob's) modes respectively,  $p.s.$  denotes that this is the photon subtracted resource and we have made the definition  $|n, n\rangle_{AB} \equiv |n\rangle_A \otimes |n\rangle_B$ . The probability of obtaining this state is dependent upon the squeezing parameter and the reflectivity of the beam splitter;

$$P(\theta, \lambda) = \theta^4 \frac{1+\lambda^2}{(1-\lambda^2)^3}. \quad (2)$$

To find the photon added EPR state we perform the same calculation as for the photon subtracted EPR state except condition off the result  $\mathcal{N} = 0$  and have the state  $|\mathcal{M} = 1\rangle$  at the spare port of each beam splitter. The photon added state in the Fock basis is

$$|\psi\rangle_{p.a.} = \sqrt{\frac{(1-\lambda^2)^3}{1+\lambda^2}} \sum_{n=0}^{\infty} (n+1)\lambda^n |n+1, n+1\rangle_{AB} \quad (3)$$

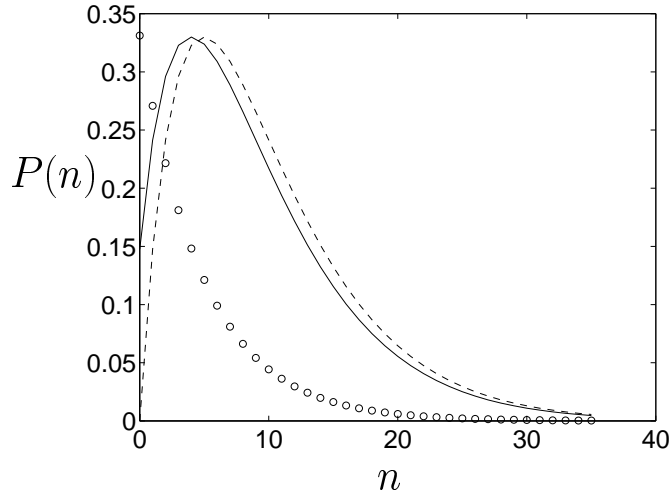

FIG. 2: Photon number distributions for the standard EPR state (circles), the photon subtracted EPR state (solid line) and photon added EPR state (dashed line).

where *p.a.* denotes that this is the photon added resource. This state has the same probability of occurring as the photon subtracted EPR state. For brevity, we will concentrate on the photon subtracted resource, unless stated otherwise, since the conclusions are similar.

The main drawback of this conditioning technique is the small probability of the coincidences occurring. This, however, is offset by the current experimental feasibility of detecting single photon coincidences, the knowledge of when to teleport the input as given by coincidence events, and the realisation that given finite resources (such as squeezing) teleportation can be improved.

### A. Conditioning as entanglement distillation

The photon number distribution for both the photon subtracted and photon added conditional EPR state has a higher weighting for large photon numbers than the standard EPR state (see Fig. 2). This suggests that the conditioning procedure behaves similarly to entanglement distillation. To support this intuition we use the fact that the resource states are pure and calculate the von Neumann entropy  $S = -\text{Tr}(\rho \log \rho)$  as a function of the squeezing parameter  $\lambda$ . It is well known that the von Neumann entropy is a good measure of entanglement for bipartite pure states [11], hence we can analyse the difference in entanglement between the standard EPR state and the photon subtracted EPR state. We show

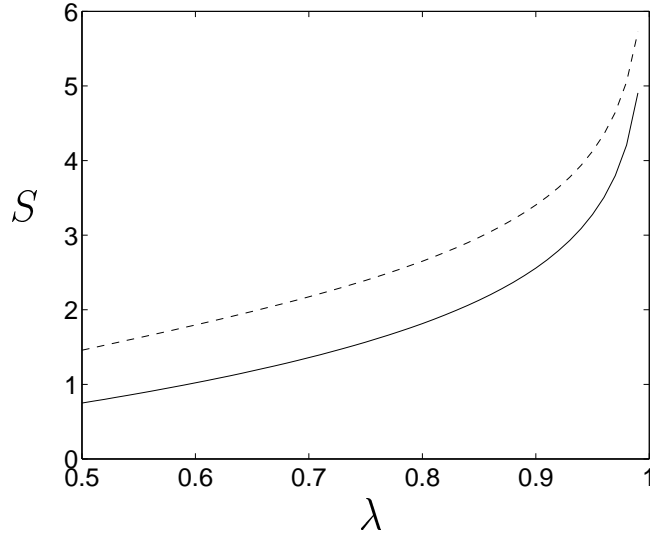

FIG. 3: Von Neumann entropy,  $S$ , versus squeezing parameter  $\lambda$ . The standard EPR state gives the solid curve and the photon subtracted EPR state the dashed curve. The figures shows a higher entanglement content in the photon subtracted EPR state relative to the standard EPR state.

in Fig. 3 the von Neumann entropy as a function of squeezing parameter and see that it is higher, given a certain level of squeezing, for the photon subtracted EPR state (dashed line) than the standard EPR state (solid line). This result shows that the entanglement in the conditional resource is higher than that in the standard resource, hence the conditioning procedure seems to have the effect of distilling entanglement out of the initial EPR state.

### III. TELEPORTATION

Opatrný *et al.* [9] arrive at expressions for the teleportation fidelity, measurement probability and average fidelity (the fidelity average over all measurements, weighted by the measurement probability) by calculating the effect of the teleportation operations on the relevant wavefunctions and then transforming into the Fock basis. In this paper we use the formalism of Hofmann [12] to calculate these parameters. The fidelity is defined as the overlap between the input state  $|\psi\rangle_T$  and the output state  $\rho_{out}$ ;

$$F = {}_T\langle\psi|\rho_{out}|\psi\rangle_T. \quad (4)$$

Teleportation in this formalism proceeds as per normal for continuous variables [3, 4, 5, 7]; Alice has one component of an entangled pair of states and Bob the other. She mixes her

entangled state with the state she wishes to teleport to Bob on a beam splitter, and measures the position difference ( $x_-$ ) and momentum sum ( $p_+$ ). Alice sends the measurement result  $\beta = x_- + ip_+$  to Bob via a classical channel, who now displaces his state by this amount to recreate the input state at his location. The entire teleportation process can be described by a transfer operator  $\hat{T}(\beta)$  such that

$$|\psi(\beta)\rangle_{out} = \hat{T}(\beta)|\psi\rangle_T \quad (5)$$

is the output state, normalised to the probability of measuring the result  $\beta$ ,

$$P(\beta) = {}_{out}\langle\psi(\beta)|\psi(\beta)\rangle_{out}. \quad (6)$$

One is able to describe the probability of measuring a given  $\beta$ , the fidelity of teleportation  $F(\beta)$  and the average fidelity  $\bar{F}$ , in terms of the transfer operator as follows

$$P(\beta) = {}_T\langle\psi|\hat{T}^\dagger(\beta)\hat{T}(\beta)|\psi\rangle_T, \quad (7)$$

$$F(\beta) = \frac{1}{P(\beta)} \left| {}_T\langle\psi|\hat{T}(\beta)|\psi\rangle_T \right|^2, \quad (8)$$

$$\bar{F} = \int d^2\beta P(\beta)F(\beta) = \int d^2\beta \left| {}_T\langle\psi|\hat{T}(\beta)|\psi\rangle_T \right|^2. \quad (9)$$

Following this formalism one merely needs to calculate the transfer operator for the given entanglement resource in order to obtain the parameters of interest. Hofmann *et al.* [13] showed for the standard EPR state that the transfer operator is

$$\hat{T}(\beta) = \sqrt{\frac{1-\lambda^2}{\pi}} \sum_{n=0}^{\infty} \lambda^n \hat{D}_T(g\beta)|n\rangle \langle n|\hat{D}_T(-\beta). \quad (10)$$

Here  $\hat{D}_T(\beta)$  is the displacement of the amount  $\beta$ ,  $g$  is the gain of the teleporter (to be discussed in more depth in Sec. IV C) and  $\lambda$  is the squeezing parameter of the EPR state:

$$|\psi\rangle_{AB} = \sqrt{1-\lambda^2} \sum_{n=0}^{\infty} \lambda^n |n, n\rangle_{AB}. \quad (11)$$

By noting correspondences between the standard EPR state and the photon subtracted and photon added EPR states one can write expressions for the transfer operator for each. The photon subtracted EPR state transfer operator is

$$\hat{T}(\beta) = \sqrt{\frac{(1-\lambda^2)^3}{\pi(1+\lambda^2)}} \sum_{n=0}^{\infty} (n+1)\lambda^n \hat{D}_T(g\beta)|n\rangle \langle n|\hat{D}_T(-\beta) \quad (12)$$

and the photon added EPR state transfer operator is,

$$\hat{T}(\beta) = \sqrt{\frac{(1-\lambda^2)^3}{\pi(1+\lambda^2)}} \sum_{n=0}^{\infty} (n+1)\lambda^n \hat{D}_T(g\beta)|n+1\rangle \langle n+1|\hat{D}_T(-\beta). \quad (13)$$

## IV. POSITION DIFFERENCE, MOMENTUM SUM TELEPORTATION

### A. Teleporting a coherent state

We consider teleportation of a coherent state to gauge the ability of the conditional EPR state relative to the standard EPR state. The fidelity is calculated including a variable gain and output coherent amplitude  $\gamma$ , we do this since we are teleporting coherent states and wish to be sufficiently general so as to include the possibility of the output state being an attenuated or amplified version of the input state. Using the standard EPR state we find the teleportation fidelity for a given measurement  $\beta$  to be

$$F(\beta) = e^{-|\gamma-g\beta|^2-\lambda^2|\alpha-\beta|^2} \left| e^{\lambda(\gamma^*-g\beta^*)(\alpha-\beta)} \right|^2 \quad (14)$$

with a measurement probability of

$$P(\beta) = \left( \frac{1-\lambda^2}{\pi} \right) e^{-(1-\lambda^2)|\alpha-\beta|^2}, \quad (15)$$

and where the \* superscript denotes the complex conjugate. For the photon subtracted EPR state the fidelity is

$$F(\beta) = \frac{e^{-|\gamma-g\beta|^2-\lambda^2|\alpha-\beta|^2}}{\lambda^4|\alpha-\beta|^4+3\lambda^2|\alpha-\beta|^2+1} \left| e^{q(\alpha-\beta)(\gamma^*-g\beta^*)} [(\alpha-\beta)(\gamma^*-g\beta^*)\lambda+1] \right|^2 \quad (16)$$

and the measurement probability is

$$P(\beta) = \frac{(1-\lambda^2)^3}{\pi(1+\lambda^2)} e^{(\lambda^2-1)|\alpha-\beta|^2} (\lambda^4|\alpha-\beta|^4+3\lambda^2|\alpha-\beta|^2+1). \quad (17)$$

Choosing a coherent state of amplitude  $\alpha = 1.5$ , an output amplitude  $\gamma$  also equal to 1.5, unity gain and a squeezing parameter value of  $\lambda = 0.8$ , we find that the average fidelity using the standard EPR state is  $\bar{F} = 0.9000$ , and using the photon subtracted EPR state it is  $\bar{F} = 0.9246$ . Hence by conditioning we can improve the efficacy of teleportation.

### B. Teleporting “cat” states

We next turn to the example of teleporting superpositions of coherent states of equal amplitude but opposite phase, commonly known as “Schrödinger cat states”. Such states are written as

$$|\psi\rangle_{cat} = \mathcal{N}_\alpha (|\alpha\rangle \pm |-\alpha\rangle), \quad (18)$$

where  $\mathcal{N}_\alpha$  is the normalisation given by

$$\mathcal{N}_\alpha = \frac{1}{\sqrt{2 \pm 2e^{-2|\alpha|^2}}}. \quad (19)$$

Even superpositions (the ‘+’ form) lead to states of only even photon number and are hence referred to as “even cats”, while odd superpositions (the ‘-’ form) are referred to as “odd cats”. In the discussion that follows we will leave the  $\pm$  in the equations for generality.

Using the Hofmann formalism, the standard EPR state, a gain  $g$ , an input state of amplitude  $\alpha$  and a comparison state of amplitude  $\gamma$  we find the teleportation fidelity to be

$$F(\beta) = \mathcal{N}_\alpha^2 \mathcal{N}_\gamma^2 \left( \frac{1 - \lambda^2}{\pi P(\beta)} \right) \quad (20)$$

$$\times \left| e^{-|\gamma - g\beta|^2/2 - |\alpha - \beta|^2/2 + \lambda(\gamma^* - g\beta^*)(\alpha - \beta) + i\text{Im}(-\gamma g\beta^*) + i\text{Im}(-\beta\alpha^*)} \right. \quad (21)$$

$$\left. \pm e^{-|\gamma - g\beta|^2/2 - |\alpha + \beta|^2/2 + \lambda(\gamma^* - g\beta^*)(\alpha + \beta) + i\text{Im}(-\gamma g\beta^*) + i\text{Im}(\beta\alpha^*)} \right. \quad (22)$$

$$\left. \pm e^{-|\gamma + g\beta|^2/2 - |\alpha - \beta|^2/2 + \lambda(\gamma^* + g\beta^*)(\alpha - \beta) + i\text{Im}(\gamma g\beta^*) + i\text{Im}(-\beta\alpha^*)} \right. \quad (23)$$

$$\left. + e^{-|\gamma + g\beta|^2/2 - |\alpha + \beta|^2/2 + \lambda(\gamma^* + g\beta^*)(\alpha + \beta) + i\text{Im}(\gamma g\beta^*) + i\text{Im}(\beta\alpha^*)} \right|^2 \quad (24)$$

with a measurement probability of

$$P(\beta) = \mathcal{N}_\alpha^2 \left( \frac{1 - \lambda^2}{\pi} \right) \quad (25)$$

$$\times \left[ e^{(\lambda^2 - 1)|\alpha - \beta|^2} \right. \quad (26)$$

$$\left. \pm e^{-|\alpha - \beta|^2/2 - |\alpha + \beta|^2/2 - \lambda^2(\alpha^* - \beta^*)(\alpha + \beta) + i\text{Im}(-\alpha\beta^*) + i\text{Im}(\beta\alpha^*)} \right. \quad (27)$$

$$\left. \pm e^{-|\alpha - \beta|^2/2 - |\alpha + \beta|^2/2 - \lambda^2(\alpha^* + \beta^*)(\alpha - \beta) + i\text{Im}(\alpha\beta^*) + i\text{Im}(-\beta\alpha^*)} \right. \quad (28)$$

$$\left. + e^{(\lambda^2 - 1)|\alpha + \beta|^2} \right], \quad (29)$$

where  $\mathcal{N}_\gamma$  is the normalisation of the comparison state, having the same form as Eq. (19).

Changing the entanglement resource to the photon subtracted EPR state we obtain the fidelity of teleportation given a result  $\beta$ ,

$$F(\beta) = \mathcal{N}_\alpha^2 \mathcal{N}_\gamma^2 \left( \frac{(1 - \lambda^2)^3}{(1 + \lambda^2)\pi P(\beta)} \right) \quad (30)$$

$$\times \left| e^{-|\gamma - g\beta|^2/2 - |\alpha - \beta|^2/2 + \lambda(\gamma^* - g\beta^*)(\alpha - \beta) + i\text{Im}(-\gamma g\beta^*) + i\text{Im}(-\beta\alpha^*)} \right. \quad (31)$$

$$\times [(\gamma^* - g\beta^*)(\alpha - \beta)\lambda + 1] \quad (32)$$

$$\pm e^{-|\gamma - g\beta|^2/2 - |\alpha + \beta|^2/2 + \lambda(\gamma^* - g\beta^*)(\alpha + \beta) + i\text{Im}(-\gamma g\beta^*) + i\text{Im}(\beta\alpha^*)} \quad (33)$$

$$\times [1 - (\gamma^* - g\beta^*)(\alpha + \beta)\lambda] \quad (34)$$



$$\pm e^{-|\gamma+g\beta|^2/2-|\alpha-\beta|^2/2+\lambda(\gamma^*+g\beta^*)(\alpha-\beta)+i\text{Im}(\gamma g\beta^*)+i\text{Im}(-\beta\alpha^*)} \quad (35)$$

$$\times [1 - (\gamma^* + g\beta^*)(\alpha - \beta)\lambda] \quad (36)$$

$$+ e^{-|\gamma+g\beta|^2/2-|\alpha+\beta|^2/2+\lambda(\gamma^*+g\beta^*)(\alpha+\beta)+i\text{Im}(\gamma g\beta^*)+i\text{Im}(\beta\alpha^*)} \quad (37)$$

$$\times [(\gamma^* + g\beta^*)(\alpha + \beta)\lambda + 1]^2 \quad (38)$$

where

$$P(\beta) = \mathcal{N}_\alpha^2 \left( \frac{(1 - \lambda^2)^3}{(1 + \lambda^2)\pi} \right) \quad (39)$$

$$\times \left[ e^{(\lambda^2-1)|\alpha-\beta|^2} (\lambda^4|\alpha - \beta|^4 + 3\lambda^2|\alpha - \beta|^2 + 1) \right] \quad (40)$$

$$\pm e^{-|\alpha-\beta|^2/2-|\alpha+\beta|^2/2-\lambda^2(\alpha^*-\beta^*)(\alpha+\beta)+i\text{Im}(-\alpha\beta^*)+i\text{Im}(\beta\alpha^*)} \quad (41)$$

$$\times \left( 1 + (\alpha + \beta)(\alpha^* - \beta^*)\lambda^2 \left[ (\alpha + \beta)(\alpha^* - \beta^*)\lambda^2 - 3 \right] \right) \quad (42)$$

$$\pm e^{-|\alpha-\beta|^2/2-|\alpha+\beta|^2/2-\lambda^2(\alpha^*+\beta^*)(\alpha-\beta)+i\text{Im}(\alpha\beta^*)+i\text{Im}(-\beta\alpha^*)} \quad (43)$$

$$\times \left( 1 + (\alpha - \beta)(\alpha^* + \beta^*)\lambda^2 \left[ (\alpha - \beta)(\alpha^* + \beta^*)\lambda^2 - 3 \right] \right) \quad (44)$$

$$+ e^{(\lambda^2-1)|\alpha+\beta|^2} (\lambda^4|\alpha + \beta|^4 + 3\lambda^2|\alpha + \beta|^2 + 1) \left. \right]. \quad (45)$$

For an even cat state of amplitude  $\alpha = 1.5$ , a squeezing parameter  $\lambda = 0.8$ , a comparison cat state amplitude  $\gamma$  of 1.5 and unity gain, we find that the standard EPR state has an average fidelity of  $\bar{F} = 0.6389$  and the photon subtracted EPR state has as average fidelity of  $\bar{F} = 0.7531$ . Again, the conditioning technique improves teleportation efficacy.

Using the result for odd cats, an amplitude of  $1.5i$  and a squeezing parameter of  $\lambda = 0.8178$  we can effectively reproduce the results of Opatrný *et al.* [9]. In our case for the standard EPR state we obtain an average fidelity of  $\bar{F} = 0.6453$  and for the conditioned EPR state  $\bar{F} = 0.7589$ , reproducing the result that the conditioned resource does better than the unconditioned resource.

### C. Varying the gain

Polkinghorne and Ralph [14] (and later Hofmann *et al.* [13]) identified a particular gain for which the output exactly corresponds to an attenuated version of the input. We see the same effect here, for if we use a coherent state of amplitude  $\alpha = 3$  as input, a squeezing parameter of 0.5, and then vary the output comparison state, we find that the average fidelity indeed goes to 1 (see Fig. 4) but producing an output state of amplitude  $\gamma = 1.5$ . This effect

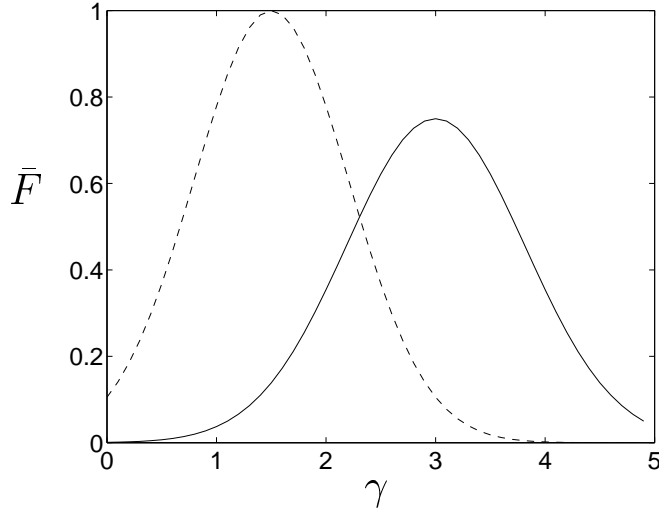

FIG. 4: Average fidelity as a function of comparison state amplitude  $\gamma$  for an input coherent state of amplitude  $\alpha = 3$  using the standard EPR state. The solid curve is the fidelity distribution at unity gain and the dashed curve is at gain 0.5. Note that the fidelity goes to 1, but at a reduced amplitude of  $\gamma = 1.5$ .

is also evident if we use the photon subtracted EPR state, unfortunately the average fidelity is unable to reach unity, as shown in Fig. 5. For this resource the maximum occurs at a gain of 0.7 and a comparison state amplitude of  $\gamma = 2.1$ . Note that although the average fidelity does not quite reach unity, the attenuated amplitude is somewhat higher than that achieved using the standard EPR state, implying that the efficiency of the teleporter may have been improved as a result of the conditioning procedure.

#### D. Generalisation

We wish to briefly note that if one has an entanglement resource of the form

$$|\psi\rangle = \mathcal{N} \sum_{n=0}^{\infty} c_n |n, n\rangle, \quad (46)$$

where  $\mathcal{N}$  is the normalisation of the entangled state and the  $c_n$  are the coefficients that describe the photon number distribution of the state, one can generalise the Hofmann transfer operator to

$$\hat{T}(\beta) = \sqrt{\frac{\mathcal{N}}{\pi}} \sum_{n=0}^{\infty} c_n \hat{D}_T(g\beta) |n\rangle \langle n| \hat{D}_T(-\beta). \quad (47)$$

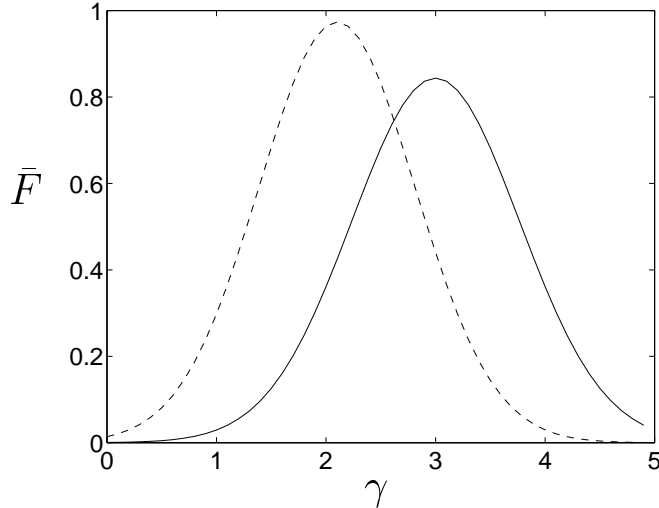

FIG. 5: Average fidelity as a function of comparison state amplitude  $\gamma$  for an input coherent state of amplitude  $\alpha = 3$  using the photon subtracted EPR state. The solid curve is the fidelity distribution at unity gain and the dashed curve is at gain 0.7. The fidelity improves by reducing the gain and is a maximum at lower amplitude ( $\gamma = 2.1$ ) but does quite not reach unity.

It is easy to see that the three entanglement resources discussed in this paper are in this form. The significance of this result is that one has some freedom to choose an entanglement resource applying directly to the given situation, which may help to enhance the teleportation fidelity or ease of implementation of the protocol.

## V. NUMBER DIFFERENCE, PHASE SUM TELEPORTATION

Milburn and Braunstein [10] introduced a teleportation protocol using number difference and phase sum measurements on the standard EPR state. Their protocol has the same structure as the more usual teleportation scheme involving the two mode squeezed vacuum but the measurements made by Alice are of number difference and phase sum. We now show that by making photon subtracted and added conditional measurements on the entanglement resource improves this protocol also.

The usual EPR state is an eigenstate of number difference and a near eigenstate of phase sum for  $\lambda$  close to unity [10]. To see that the photon subtracted and added EPR states also fulfil these criteria we reiterate their form in the Fock basis. Firstly, the photon subtracted

EPR state,

$$|\psi\rangle_{p.s.} = \sqrt{\frac{(1-\lambda^2)^3}{1+\lambda^2}} \sum_{n=0}^{\infty} (n+1)\lambda^n |n, n\rangle \quad (48)$$

and secondly, the photon added EPR state,

$$|\psi\rangle_{p.a.} = \sqrt{\frac{(1-\lambda^2)^3}{1+\lambda^2}} \sum_{n=0}^{\infty} (n+1)\lambda^n |n+1, n+1\rangle \quad (49)$$

These states are obviously eigenstates of number difference, however, it is not so easy to see that they are also near eigenstates of phase sum. To see this we calculate the joint phase probability density

$$P(\phi_1, \phi_2) = |\langle \phi_1 | \langle \phi_2 | \psi \rangle_{AB}|^2 \quad (50)$$

where the  $|\phi_j\rangle$  are the phase states

$$|\phi_j\rangle = \sum_{n=0}^{\infty} e^{-i\phi_j n} |n\rangle. \quad (51)$$

The joint phase probability density for the photon subtracted EPR state may be written more explicitly as

$$P(\phi_+) = \frac{(1-\lambda^2)^3}{1+\lambda^2} \left| \sum_{n=0}^{\infty} e^{in\phi_+} (n+1)\lambda^n \right|^2 \quad (52)$$

where  $\phi_+ = \phi_1 + \phi_2$ . For the photon added EPR state we have

$$P(\phi_+) = \frac{(1-\lambda^2)^3}{1+\lambda^2} \left| \sum_{n=0}^{\infty} e^{i(n+1)\phi_+} (n+1)\lambda^n \right|^2. \quad (53)$$

As  $\lambda \rightarrow 1$  these distributions become more peaked about  $\phi_+ = 0$  on the range  $[\pi, -\pi]$ , showing us that the phase is highly correlated and the states are close to eigenstates of phase sum. This is shown in Fig. 6 for the photon subtracted case only, since the photon added distribution provides the same conclusion.

Teleportation proceeds as described in Refs [10] and [8]. We find for a given (positive) number difference measurement,  $k$ , between Alice's mode and the input state, that for the photon subtracted EPR state the state in Bob's mode is

$$|\psi\rangle_{out} = \sqrt{\frac{(1-\lambda^2)^3}{(1+\lambda^2)P(k)}} \sum_{n=0}^{\infty} c_{n+k} (n+1)\lambda^n |n+k\rangle_B, \quad (54)$$

where the  $c_n$  are the coefficients describing the photon number distribution of the input state and  $P(k)$  is the probability of measuring the number difference  $k$ , which is given by

$$P(k) = \frac{(1-\lambda^2)^3}{1+\lambda^2} \sum_{n=0}^{\infty} |c_{n+k}|^2 (n+1)^2 \lambda^{2n}. \quad (55)$$

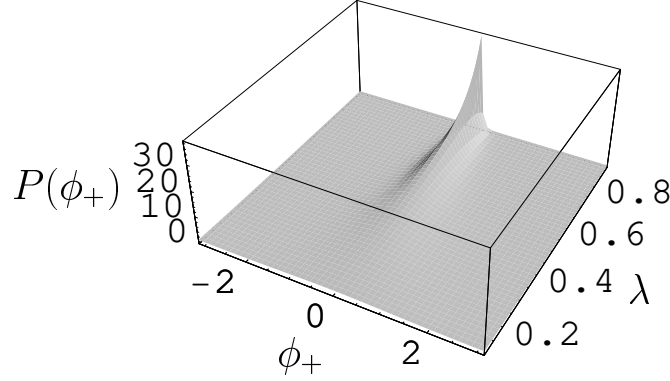

FIG. 6: Joint phase probability distribution as a function of both phase sum  $\phi_+$  and squeezing parameter  $\lambda$ . The distribution becomes sharply peaked with increasing  $\lambda$  indicating that the photon subtracted EPR state is tending towards eigenstates of phase sum.

The teleportation fidelity given  $k$  is

$$F(k) = \frac{(1 - \lambda^2)^3}{(1 + \lambda^2)P(k)} \left| \sum_{n=0}^{\infty} |c_{n+k}|^2 (n+1) \lambda^n \right|^2. \quad (56)$$

For the photon added EPR state the state in Bob's mode is

$$|\psi\rangle_{out} = \sqrt{\frac{(1 - \lambda^2)^3}{(1 + \lambda^2)P(k)}} \sum_{n=0}^{\infty} c_{n+k+1} (n+1) \lambda^n |n+k+1\rangle_B \quad (57)$$

where  $P(k)$  is

$$P(k) = \frac{(1 - \lambda^2)^3}{1 + \lambda^2} \sum_{n=0}^{\infty} |c_{n+k+1}|^2 (n+1)^2 \lambda^{2n} \quad (58)$$

and the teleportation fidelity is

$$F(k) = \frac{(1 - \lambda^2)^3}{(1 + \lambda^2)P(k)} \left| \sum_{n=0}^{\infty} |c_{n+k+1}|^2 (n+1) \lambda^n \right|^2. \quad (59)$$

Reiterating the results for the standard EPR state [8] we have the state in Bob's mode,

$$|\psi\rangle_{out} = \sqrt{\frac{1 - \lambda^2}{P(k)}} \sum_{n=0}^{\infty} c_{n+k} \lambda^n |n+k\rangle_B \quad (60)$$

with corresponding measurement probability

$$P(k) = (1 - \lambda^2) \sum_{n=0}^{\infty} |c_{n+k}|^2 \lambda^{2n} \quad (61)$$

and teleportation fidelity

$$F(k) = \frac{1 - \lambda^2}{P(k)} \left| \sum_{n=0}^{\infty} |c_{n+k}|^2 \lambda^n \right|^2. \quad (62)$$

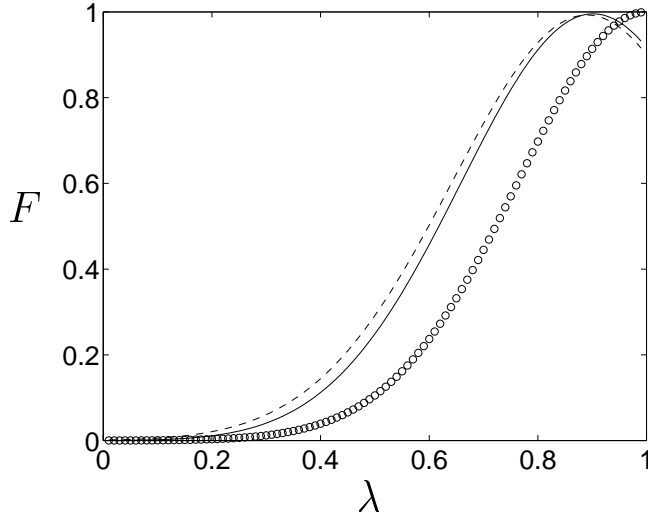

FIG. 7: Fidelity  $F$  as a function of squeezing parameter  $\lambda$  given a measurement result  $k = 0$ . The circles denote the distribution for the standard EPR state, the solid line for the photon subtracted EPR state and the dashed line the photon added EPR state.

To gauge the performance of the entanglement resources we consider teleportation of a coherent state of amplitude  $\alpha = 3$ . Such a choice means the  $c_n$  coefficients are given by

$$c_n = e^{-|\alpha|^2/2} \frac{\alpha^n}{n!} \quad (63)$$

We only wish to illustrate the relative performance of the resources as a function of squeezing parameter, so to simplify the graphical output we consider the cases of a number difference measurement of  $k = 0$  and  $k = 5$ . From Fig. 7 we see that both the photon subtracted (solid line) and photon added (dashed line) EPR states have a higher fidelity than the standard EPR resource for a large range of the squeezing parameter, implying that the conditional resources do a better job of teleportation. The photon added EPR state does slightly better than its counterpart for this value of the number difference measurement, however as we can see from Fig. 8, for larger  $k$  it does not do as well in comparison to the photon subtracted resource, and in fact both conditional EPR states fail to achieve as high a fidelity as the more standard resource. Nevertheless, using the conditional resource still improves the teleportation for a broad range of experimentally realistic levels of squeezing.

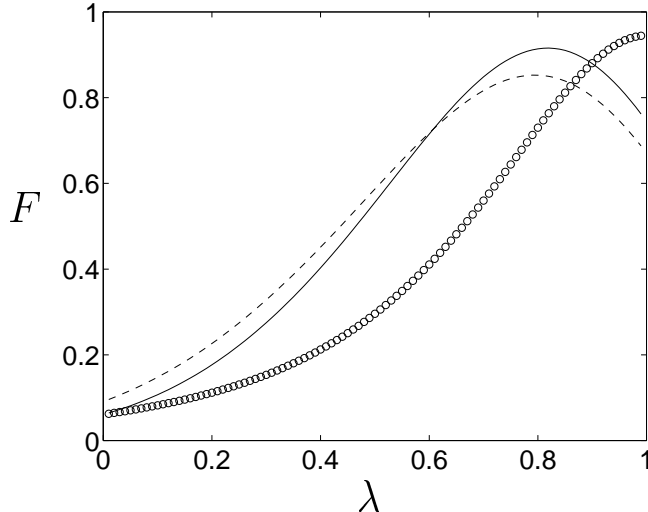

FIG. 8: Fidelity  $F$  as a function of squeezing parameter  $\lambda$  given a measurement result  $k = 5$ . The circles denote the distribution for the standard EPR state, the solid line for the photon subtracted EPR state and the dashed line the photon added EPR state.

## VI. BEATING $\bar{F} = 2/3$ VIA CONDITIONING

The boundary beyond which entanglement is required in continuous variable teleportation of coherent states was found by Furusawa [3] to be  $\bar{F} = 0.5$ . On the other hand a qualitatively different boundary, beyond which the state reproduction is unambiguously quantum was found by Ralph and Lam [7] and has recently been the source of considerable discussion [15, 16, 17]. The criterion for beating this second boundary at unity gain was given by Ralph and Lam [7, 15], and Grosshans and Grangier [16] to be  $\bar{F} > 2/3$ . Consider the average fidelity of both the standard EPR state and the photon subtracted EPR state as functions of the squeezing parameter  $\lambda$ , shown in Fig. 9, where we teleport a coherent state of amplitude  $\alpha = 3$  with the teleporter at unity gain. We can find a region where the conditional resource beats the  $2/3$  successful quantum teleportation limit whilst the standard resource does not; this region is shaded grey in the figure. The horizontal line denotes the  $\bar{F} = 2/3$  boundary and the vertical line gives the upper edge of the shaded region and occurs where the standard EPR state lies on the  $2/3$  boundary.

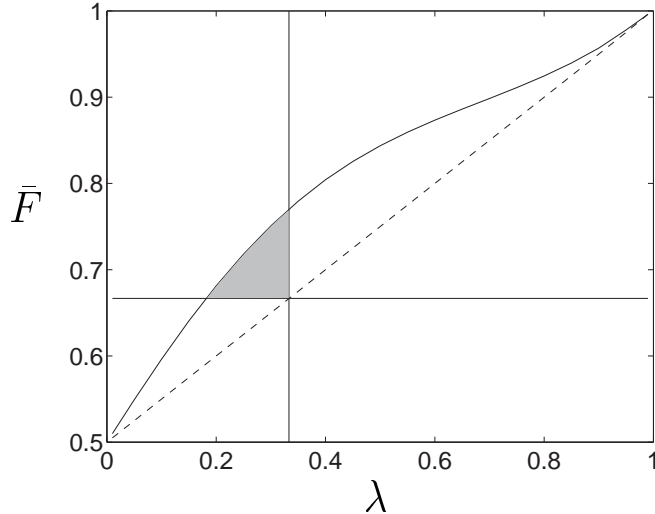

FIG. 9: Average fidelity  $\bar{F}$  as a function of squeezing parameter  $\lambda$  for teleportation of a coherent state of amplitude  $\alpha = 3$  using the standard EPR state (dashed line) and the photon subtracted EPR state (solid line). The grey shaded region denotes where the photon subtracted EPR state beats the  $2/3$  successful quantum teleportation limit whereas the standard EPR state does not. The horizontal line denotes the  $\bar{F} = 2/3$  boundary and the vertical line gives the right hand edge of the shaded region and is where the standard EPR state lies on the boundary. The maximum difference between the two curves occurs at  $\lambda = 0.37$ , giving an improvement of 15%.

## VII. DISCUSSION

We have shown how one can improve the efficacy of teleportation by making conditional measurements on the Einstein-Podolsky-Rosen squeezed vacuum for both the position difference, momentum sum and number difference, phase sum continuous variable teleportation protocols. The conditional measurements only require single photon coincidence detection which is currently feasible in the laboratory, the coincidence events also indicating when is best to teleport. We have also shown that the conditional EPR state gives a resource able to provide successfully quantum teleportation for a large range of squeezing.



## Acknowledgments

PTC acknowledges the financial support of the Centre for Laser Science and the University of Queensland Postgraduate Research Scholarship.

---

- [1] C. H. Bennett, G. Brassard, C. Crepeau, R. Jozsa, A. Peres, and W. K. Wootters, *Phys. Rev. Lett.* **70**(13), 1895 (1993).
- [2] L. Vaidman, *Phys. Rev. A* **49**(2), 1473 (1994).
- [3] A. Furusawa, J. L. Sorensen, S. L. Braunstein, C. A. Fuchs, H. J. Kimble, and E. S. Polzik, *Science* **282**, 706 (1998).
- [4] D. Bouwmeester, J.-W. Pan, K. Mattle, M. Eibl, H. Weinfurter, and A. Zeilinger, *Nature* **390**, 575 (1997).
- [5] S. L. Braunstein and H. J. Kimble, *Phys. Rev. Lett.* **80**(4), 869 (1998).
- [6] D. Gottesman and I. L. Chuang, *Nature* **402**, 390 (1999).
- [7] T. C. Ralph and P. K. Lam, *Phys. Rev. Lett.* **81**(25), 5668 (1998).
- [8] P. T. Cochrane, G. J. Milburn, and W. J. Munro, *Phys. Rev. A* **62** (2000).
- [9] T. Opatrny, G. Kurizki, and D.-G. Welsch, *Phys. Rev. A* **61** (2000).
- [10] G. J. Milburn and S. L. Braunstein, *Phys. Rev. A* **60**(2), 937 (1999).
- [11] M. B. Plenio and V. Vedral, *Contemp. Phys.* **39**(6), 431 (1998).
- [12] H. F. Hofmann, T. Ide, T. Kobayashi, and A. Furusawa, *Phys. Rev. A* **62**, 062304 (2000).
- [13] H. F. Hofmann, T. Ide, T. Kobayashi, and A. Furusawa, *Information losses in continuous variable quantum teleportation* (2001), quant-ph/0102097.
- [14] R. E. S. Polkinghorne and T. C. Ralph, *Phys. Rev. Lett.* **83**(11), 2095 (1999).
- [15] T. C. Ralph, in *Lecture Notes in Physics* (Springer-Verlag, Berlin, Heidelberg, 2001), *Directions in Quantum Optics*, p. 187.
- [16] F. Grosshans and P. Grangier, *Phys. Rev. A* **64**, 010301(R) (2001).
- [17] S. L. Braunstein, C. A. Fuchs, H. J. Kimble, and P. van Loock, *Phys. Rev. A* **64**, 022321 (2001).
- [18] Strictly speaking, the two-mode squeezed vacuum is not an EPR state, however, in the limit of infinite squeezing it tends to the EPR state. This limit is unphysical since infinite squeezing

requires infinite energy, but for moderate squeezing the two-mode squeezed vacuum displays EPR *correlations* and for this reason is often referred to in the literature as an EPR state. We shall follow this convention here.