

PERFECT CRYSTALS OF $U_q(G_2^{(1)})$

Shigenori Yamane

Department of Mathematical Science, Faculty of Engineering Science,
Osaka University, Toyonaka, Osaka 560, Japan

yamane@sigmath.es.osaka-u.ac.jp

1 Introduction

The theory of *crystal base* was introduced by Kashiwara in [3]. He proved the existence and uniqueness of this base for a quantized universal enveloping algebras $U_q(\mathfrak{g})$, where \mathfrak{g} is an arbitrary Kac-Moody Lie algebra with symmetrizable Cartan matrix. The theory of crystal base provides a powerful combinatorial tool for studying the structure of the integrable highest weight modules and the decomposition of tensor products of them.

Let \mathfrak{g} be an arbitrary Kac-Moody Lie algebra with a symmetrizable Cartan matrix. Let I be its index set. Denote the set of simple roots of \mathfrak{g} by $\{\alpha_i \mid i \in I\}$. Let P be the weight lattice of \mathfrak{g} . Take an integrable $U_q(\mathfrak{g})$ -module M and let \tilde{f}_i, \tilde{e}_i be the Kashiwara operators (cf. §3.1.2) on M . Let \mathbf{A} be the subring of $\mathbf{Q}(q)$ consisting of $f \in \mathbf{Q}(q)$ that is regular at $q = 0$. A crystal lattice L of an integrable $U_q(\mathfrak{g})$ -module M is free \mathbf{A} -submodule of M such that $M \cong \mathbf{Q}(q) \otimes_{\mathbf{A}} L$, $L = \bigoplus_{\lambda \in P} L_\lambda$, where $L_\lambda = L \cap M_\lambda$ and $\tilde{e}_i L \subset L$, $\tilde{f}_i L \subset L$. A crystal base of the integrable $U_q(\mathfrak{g})$ -module M is a pair (L, B) such that (i) L is a crystal lattice of M , (ii) B is a \mathbf{Q} -base of L/qL , (iii) $B = \sqcup_{\lambda \in P} B_\lambda$ where $B_\lambda = B \cap (L_\lambda/qL_\lambda)$, (iv) $\tilde{e}_i B \subset B \sqcup \{0\}$, and (v) for $b, b' \in B$, $b' = \tilde{f}_i b$ if and only if $b = \tilde{e}_i b'$ for $i \in I$. We sometimes replace condition (ii) by : $B_{ps} = B' \sqcup (-B')$ where B' is a \mathbf{Q} -base of L/qL . In this case, we call (L, B_{ps}) a *crystal pseudo base*. The quotient $B_{ps}/\{\pm 1\}$ is called an *associated crystal* of (L, B_{ps}) .

In [6], Kashiwara and Nakashima gave an explicit construction of crystal bases for all finite dimensional irreducible modules over $U_q(\mathfrak{g})$, where \mathfrak{g} is of type A_n, B_n, C_n, D_n , in terms of generalized Young tableaux. Kang and Misra gave a construction of crystal bases of $U_q(G_2)$ -module by a method similar to Kashiwara and Nakashima's in [7].

The notion of *perfect crystals* was introduced in [8] and [9] in order to compute the one-point functions of vertex model in 2 dimensional lattice statistical models. If a $U_q(\mathfrak{g})$ -module M has perfect crystal base, we have the notion of paths. Using paths, we can compute one-point functions of vertex models. We define classical part of the weight lattice by $P_{cl} = \sum \mathbf{Z} \Lambda_i$. A P_{cl} -weighted crystal is called a *classical crystal* and P -weighted crystal is called an *affine crystal*. Let c be the central element. Further we define $\varepsilon_i(b), \varphi_i(b)$ by $\max\{k \geq 0 \mid \tilde{e}_i^k b \neq 0\}, \max\{k \geq 0 \mid \tilde{f}_i^k b \neq 0\}$ respectively. We define $\varepsilon(b), \varphi(b)$ by $\sum_i \varepsilon_i(b) \Lambda_i, \sum_i \varphi_i(b) \Lambda_i$ respectively. A classical crystal B is called a *perfect crystal of level l* if B satisfies: (i) $B \otimes B$ is connected, (ii) there exists $\lambda_0 \in P_{cl}$ such that $\text{wt}(B) \in \lambda_0 + \sum_{i \neq 0} \mathbf{Z}_{\leq 0} c l (\alpha_i)$ and that $\#(B_{\lambda_0}) = 1$, (iii) there is a finite dimensional $U'_q(\mathfrak{g})$ -module with a crystal pseudo base (L, B_{ps}) such that $B \cong B_{ps}/\pm 1$, (iv) for any $b \in B$, we have $\langle c, \varepsilon(b) \rangle \geq l$, and (v) the maps $\varepsilon, \varphi : B_l = \{b \in B \mid \langle c, \varepsilon(b) \rangle = l\} \rightarrow (P_{cl}^+)_l = \{\lambda \in \sum \mathbf{Z}_{\geq 0} \Lambda_i \mid \langle c, \lambda \rangle = l\}$ are bijective.

In [8], they give examples of perfect crystals of arbitrary levels for algebras of the following types: $A_n^{(1)}, B_n^{(1)}, C_n^{(1)}, D_n^{(1)}, A_{2n}^{(2)}, A_{2n-1}^{(2)}, D_{n+1}^{(2)}$. Up to now we do not know simple criterion for perfectness of crystals. Further, perfect crystals with arbitrary level for $E_n^{(1)}, F_4^{(1)}, G_2^{(1)}, E_6^{(2)}$ are not known. In this paper, we give a series of perfect crystals of $U_q(G_2^{(1)})$, following method in [8].

Let $U'_q(G_2^{(1)})$ be the subalgebra of $U_q(G_2^{(1)})$, generated by e_i, f_i, q^h ($h \in P_{cl}^* = \sum_{i \in \{0,1,2\}} \mathbf{Z} h_i$). We proceed in the following way.

1. As in [8], for a given level l , our strategy is to employ the fusion procedure in order to construct finite dimensional irreducible module V_l of $U'_q(G_2^{(1)})$ with a crystal pseudo base such that its associated crystal is perfect of level l . As a starting point, we take the following data. Let V be the direct sum of the 14-dimensional module with highest weight Λ_1 and the trivial module over $U_q(G_2)$. The module V has a crystal base which is characterized by a polarization on V . A polarization on $U_q(\mathfrak{g})$ -module M

is the symmetric bilinear such that for $u, v \in M$ (i) $(q^h u, v) = (u, q^h v)$, (ii) $(e_i u, v) = (u, q_i^{-1} t_i^{-1} f_i v)$, (iii) $(f_i u, v) = (u, q_i^{-1} t_i e_i v)$ and (iv) positive definite. Let B^1 be the associated crystal of $U_q(G_2)$. We define the actions of e_0 , f_0 , and q^{h_0} on V to make it an irreducible module for $U'_q(G_2^{(1)})$. Then we show that there exists a polarization for $U'_q(G_2^{(1)})$. We see that B^1 is a perfect crystal of level 1 by direct calculation. Using the global base [5], we compute the R-matrix for V explicitly. By the fusion construction, we obtain a certain finite-dimensional submodule V_l of $V^{\otimes l}$. The existence of polarization on V_l ensures that the submodule V_l has a crystal pseudo base. The associated crystal of V_l is isomorphic to a crystal of $U_q(G_2)$ and a crystal of $U_q(A_2)$ as crystals of $U_q(G_2)$ and $U_q(A_2)$ respectively. These isomorphisms show that the associated crystal is a crystal of $U'_q(G_2^{(1)})$. It is a perfect crystal of level l . This is shown in the section 4.

2. In section 5, we construct a perfect crystal B^l of $U_q(G_2^{(1)})$ in a combinatorial way.

The Dynkin diagram of $G_2^{(1)}$ is $\overset{0}{\circ} - \overset{1}{\circ} \rightleftharpoons \overset{2}{\circ}$. Here, let $J_0 = \{1, 2\}$ and $J_2 = \{1, 0\}$ be the index set of G_2 and A_2 , respectively. We define $\nu_i : J_i \rightarrow I$ by $\nu_i(j) = j$ ($i = 0, 2$). We define crystal \mathcal{G}^l to be

$$\mathcal{G}^l = \bigoplus_{n=0}^l B^{G_2}(n\Lambda_1) \text{ (as crystals for } U_q(G_2) \text{)}.$$

The affine crystal b^l for $U_q(G_2^{(1)})$ is constructed with \mathcal{G}^l and \tilde{f}_0 . To define \tilde{f}_0 on \mathcal{G}^l , we use crystals of $U_q(A_2)$. Here, we define \mathcal{A} by

$$\begin{aligned} \mathcal{A}_i &= \bigoplus_{i \leq j_1, j_0 \leq l-i} B^{A_2}(j_1\Lambda_1 + j_0\Lambda_0) \text{ (as crystals for } U_q(A_2)\text{)}, \\ \mathcal{A} &= \bigoplus_{i=0}^{\lfloor \frac{l}{2} \rfloor} \mathcal{A}_i. \end{aligned}$$

We define operators $E_{\mathcal{A}}$, $F_{\mathcal{A}}$ on \mathcal{A} such that for $b, b' \in \mathcal{A}$, (C1) $E_{\mathcal{A}}b = b'$, if and only if $F_{\mathcal{A}}b' = b$, (C2) $E_{\mathcal{A}}\tilde{f}_0^{\mathcal{A}}(b) = \tilde{f}_0^{\mathcal{A}}E_{\mathcal{A}}(b)$, (C3) $\max\{m \mid F_{\mathcal{A}}^m b \neq 0\} - \max\{m' \mid E_{\mathcal{A}}^{m'} b \neq 0\} = -2\text{wt}_1^{\mathcal{A}}(b) - \text{wt}_0^{\mathcal{A}}(b)$. Operators $E_{\mathcal{A}}$ and $F_{\mathcal{A}}$ are counterpart of $\tilde{e}_2^{\mathcal{G}}$, $\tilde{f}_2^{\mathcal{G}}$ on \mathcal{G}^l . The crystal base \mathcal{A} has an involution $C_{\mathcal{A}}$ such that

$$C_{\mathcal{A}} \left(\left(\tilde{f}_0^{\mathcal{A}} \right)^r \left(\tilde{f}_1^{\mathcal{A}} \right)^q \left(\tilde{f}_0^{\mathcal{A}} \right)^p \bar{b}_{(k,j)}^{l,i} \right) = \left(\tilde{f}_0^{\mathcal{A}} \right)^{j+q-2p-r} \left(\tilde{f}_1^{\mathcal{A}} \right)^{k+j-q} \left(\tilde{f}_0^{\mathcal{A}} \right)^{k-q+p} \bar{b}_{(j,k)}^{l,i},$$

where $0 \leq i \leq \lfloor \frac{l}{2} \rfloor$, $i \leq k, j \leq l-i$, $\bar{b}_{(k,j)}^{l,i}$ is the highest weight element on \mathcal{A}_i with weight $j\Lambda_1 + k\Lambda_0$, $0 \leq p \leq j$, $p \leq q \leq p+k$, $0 \leq r \leq j+q-2p$. By calculation, we see $\sharp\mathcal{A} = \sharp\mathcal{G}^l$. In view of this, we construct one-to-one map $\Phi : \mathcal{A} \rightarrow \mathcal{G}^l$ such that for $b \in \mathcal{A}$ (E1) $\tilde{e}_1^{\mathcal{G}}\Phi(b) = \Phi(\tilde{e}_1^{\mathcal{A}}b)$, (E2) $\tilde{f}_2^{\mathcal{G}}\Phi(b) = \Phi(F_{\mathcal{A}}b)$, (E3) $\text{wt}_1^{\mathcal{G}}(\Phi(b)) = \text{wt}_1^{\mathcal{A}}(b)$, (E4) $\text{wt}_2^{\mathcal{G}}(\Phi(b)) = -2\text{wt}_1^{\mathcal{A}}(b) - \text{wt}_0^{\mathcal{A}}(b)$, (E5) $\tilde{e}_0^{\mathcal{G}}\Phi(b) = 0$ (resp. $\tilde{f}_0^{\mathcal{G}}\Phi(b) = 0$) if and only if $\tilde{e}_0^{\mathcal{A}}(b) = 0$ (resp. $\tilde{f}_0^{\mathcal{A}}(b) = 0$), for $b \in \mathcal{A}$. Then we define \tilde{f}_0 on \mathcal{G}^l by $\Phi\tilde{f}_0^{\mathcal{A}}\Phi^{-1}$. By weight consideration, (C2), involution, etc., we see that the action of \tilde{f}_0 is unique. Therefore we have crystal base of $U_q(G_2^{(1)})$.

3. We show that perfectness are satisfied by direct calculation (§5.4, §5.5).

Graphs of the perfect crystal of level 1 and level 2 are given by Figure 1 and 9 respectively. In Figure 9, for simplicity, we omit arrows of $E_{\mathcal{A}}(b)$ such that $\varepsilon_0^{\mathcal{A}}(b) \neq 0$. By definition, we have $B^2 = B^{G_2}(2\Lambda_1) \oplus B^{G_2}(\Lambda_1) \oplus B^{G_2}(\phi)$ and $\mathcal{A}_0 = \bigoplus_{0 \leq j_1, j_0 \leq 2} B^{A_2}(j_1\Lambda_1 + j_0\Lambda_0)$, $\mathcal{A}_1 = B^{A_2}(\Lambda_1 + \Lambda_0)$, $\mathcal{A} = \mathcal{A}_0 \oplus \mathcal{A}_1$. In this graph, the element $b \in B^2$ from which we draw arrows of $E_{\mathcal{A}}$ satisfies $\Phi(b) \in B^{G_2}(2\Lambda_1)$, $\Phi(\tilde{f}_0^{\mathcal{A}}b) \notin B^{G_2}(\Lambda_1)$ and $\tilde{e}_0^{\mathcal{A}}b = 0$. For $b \in \mathcal{A}$ such that $\Phi(b) \in B^{G_2}(\Lambda_1) \oplus B^{G_2}(\phi)$, the action of $E_{\mathcal{A}}$ is same as the case of level 1. Using commutativity (C2), we obtain the completed graph of the perfect crystal of level 2. We obtain the perfect crystal B^1 of level 1 by restricting B^2 to $B^{G_2}(\Lambda_1) \oplus B^{G_2}(\phi)$. From these examples, we expect that we can obtain the perfect crystal B^{l+1} by extending B^l .

To find perfect crystals of level l , we wrote a C program which judges whether a given representation has perfect crystal on a combinatorial level. In this program, we construct crystal bases B using a Lakshmibai-Seshadri path [11]. A Lakshmibai-Seshadri path is a piecewise linear paths $\pi : [0, 1] \rightarrow (\sum \mathbf{Z}\Lambda_i) \otimes_{\mathbf{Z}} \mathbf{R}$. Operators e_α and f_α on the path are modification by simple reflection σ with respect to the simple root α . When translated into the language of crystal base, a path π is a base and operators e_{α_i} and f_{α_i} are Kashiwara operators \tilde{e}_i and \tilde{f}_i . Let $\delta = \sum a_i \alpha_i$ be the null root. We define the operator \tilde{f}_0 ($b \in B$), by searching bases with weight $\text{wt}(b) + \sum_{i \neq 0} a_i \alpha_i$ and taking into account the conditions for perfectness. The conditions are $\langle c, \varphi(b) \rangle \geq l$, and the map $\varphi : B_l = \{b \in B \mid \langle c, \varphi(b) \rangle = l\} \rightarrow (P_{cl}^+)_l = \{\lambda \in \sum \mathbf{Z}_{\geq 0} \Lambda_i \mid \langle c, \lambda \rangle = l\}$ are bijective (c is the element of the center). If we find suitable action of \tilde{f}_0 , B is perfect crystal on a combinatorial level.

Using this program we find that $\bigoplus_{k=0}^l B(k\Lambda_1)$ is a candidate of perfect crystals of level l also for $U_q(F_4^{(1)})$, $U_q(E_6^{(1)})$, etc, on a combinatorial level. We hope to report on these in a future publication.

The author would like to acknowledge professor Etsuro Date and T. Nakashima for their helpful advices.

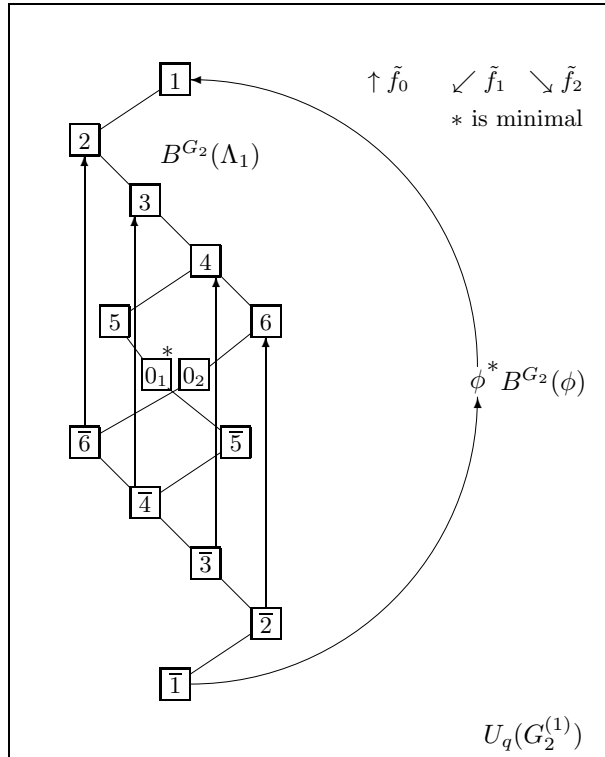

Figure 1: Perfect crystal of level 1

2 Results

Denote the index set of the simple roots of $G_2^{(1)}$ by $I = \{0, 1, 2\}$. We can take $J_0 = \{1, 2\}$ and $J_2 = \{1, 0\}$ as the index set of G_2 and A_2 , respectively. We define $\iota_i : J_i \rightarrow I$ by $\iota_i(j) = j$ ($i = 0, 2$).

Proposition 2.1 For any integer $l \geq 1$, there exists the crystal B^l for $G_2^{(1)}$ such that

$$\iota_0^*(B^l) \cong \bigoplus_{k=0}^l B^{G_2}(k\Lambda_1) \text{ (as crystals of } U_q(G_2) \text{),}$$

and

$$i_2^*(B^l) \cong \bigoplus_{i=0}^{\lfloor \frac{l}{2} \rfloor} \bigoplus_{i \leq j_1, j_0 \leq l-i} B^{A_2}(j_1 \Lambda_1 + j_0 \Lambda_0) \text{ (as crystals of } U_q(A_2) \text{)}.$$

Theorem 2.2 *The crystal B^l is a perfect crystal of level l for $U_q(G_2^{(1)})$.*

3 Preliminaries

3.1 Crystal base

We recall definitions of quantum enveloping algebras $U_q(A_2)$, $U_q(G_2)$, $U_q(G_2^{(1)})$ and crystal bases of $U_q(A_2)$, $U_q(G_2)$.

3.1.1 Definition of $U_q(\mathfrak{g})$

Let \mathfrak{g} be a semi simple (resp. affine) Lie algebra generated by e_i, f_i ($i \in I = \{1, \dots, n\}$ (resp. $\{0, 1, \dots, n\}$)) and \mathfrak{h} the Cartan subalgebra over \mathbf{Q} . Let $\{\alpha_i \mid i \in I\} \subset \mathfrak{h}^*$ and $\{h_i \mid i \in I\} \subset \mathfrak{h}$ denote the simple roots and simple coroots, respectively. We denote a non-degenerate invariant symmetric bilinear form on \mathfrak{h}^* by $(,)$. This bilinear form $(,)$ satisfies $(\alpha_i, \alpha_i) \in \mathbf{Z}_{>0}$. Let P be the weight lattice and P^* be the dual lattice.

The quantized universal enveloping algebra $U_q(\mathfrak{g})$ is the $\mathbf{Q}(q)$ -algebra generated by the symbols e_i, f_i ($i \in I$) and q^h ($h \in P^*$) with the following defining relations:

$$\begin{aligned} q^0 &= 1, q^h q^{h'} = q^{h+h'} \text{ for all } h, h' \in P^*, \\ q^h e_i q^{-h} &= q^{\langle h, \alpha_i \rangle} e_i, q^h f_i q^{-h} = q^{-\langle h, \alpha_i \rangle} f_i \text{ for all } i \in I, h \in P^*, \\ [e_i, f_i] &= \delta_{ij} \frac{t_i - t_i^{-1}}{q_i - q_i^{-1}}, \text{ where } q_i = q^{(\alpha_i, \alpha_i)} \text{ and } t_i = q^{(\alpha_i, \alpha_i) h_i} = q_i^{h_i}, \\ \sum_{k=0}^b (-1)^k e_i^{(k)} e_j e_i^{(b-k)} &= 0 \text{ for } i \neq j \text{ and } b = 1 - \langle h_i, \alpha_j \rangle. \\ \sum_{k=0}^b (-1)^k f_i^{(k)} f_j f_i^{(b-k)} &= 0 \text{ for } i \neq j \text{ and } b = 1 - \langle h_i, \alpha_j \rangle. \end{aligned}$$

Here we use the following notations: $[m]_i = \frac{q_i^m - q_i^{-m}}{q_i - q_i^{-1}}$, $[k]_i! = \prod_{m=1}^k [m]_i$, and $e_i^{(k)} = e_i^k / [k]_i!$, $f_i^{(k)} = f_i^k / [k]_i!$.

For $k < 0$, we put $e_i^{(k)} = f_i^{(k)} = 0$.

It is well-known that $U_q(\mathfrak{g})$ has a Hopf algebra structure with a comultiplication Δ defined by

$$\begin{aligned} \Delta(e_i) &= e_i \otimes t_i^{-1} + 1 \otimes e_i, \\ \Delta(f_i) &= f_i \otimes 1 + t_i \otimes f_i, \\ \Delta(q^h) &= q^h \otimes q^h. \end{aligned}$$

for all $i \in I$, $h \in P^*$. The tensor product of two $U_q(\mathfrak{g})$ -modules has a structure of $U_q(\mathfrak{g})$ -module by this comultiplication.

3.1.2 Definition of crystal bases[3]

For $U_q(\mathfrak{g})$ -module M and $\lambda \in P$, the λ -weight space of M is defined by $M_\lambda = \{u \in M \mid q^h u = q^{\langle h, \lambda \rangle} u \text{ for all } h \in P^*\}$. For $J \subset I$, let $U_q(\mathfrak{g}_J)$ be the subalgebra of $U_q(\mathfrak{g})$ generated by e_i, f_i, t_i and t_i^{-1} ($i \in J$). We say that M is *integrable* if $M = \bigoplus_{\lambda \in P} M_\lambda$ and M is a union of finite-dimensional $U_q(\mathfrak{g}_{\{i\}})$ -modules for each $i \in I$. By the representation theory of $U_q(\mathfrak{sl}_2)$ any element $u \in M_\lambda$ can be uniquely written as

$$u = \sum_{k \geq 0} f_i^{(k)} u_k,$$

where $u_k \in \ker e_i \cap M_{\lambda + k\alpha_i}$. We define the Kashiwara operators \tilde{e}_i and \tilde{f}_i on M as follows.

$$\tilde{e}_i u = \sum f_i^{(k-1)} u_k,$$

$$\tilde{f}_i u = \sum f_i^{(k+1)} u_k.$$

Let \mathbf{A} be the subring of $\mathbf{Q}(q)$ consisting of the rational functions regular at $q = 0$. A *crystal lattice* of integrable $U_q(\mathfrak{g})$ -module M is a free \mathbf{A} -submodule of M such that (1) $M \cong \mathbf{Q}(q) \otimes_{\mathbf{A}} L$, (2) $L = \bigoplus_{\lambda \in P} L_\lambda$ where $L_\lambda = L \cap M_\lambda$, (3) $\tilde{e}_i L \subset L, \tilde{f}_i L \subset L$. A *crystal base* of the integrable $U_q(\mathfrak{g})$ -module M is a pair (L, B) such that

- (i) L is a crystal lattice of M ,
- (ii) B is a \mathbf{Q} -base of L/qL ,
- (iii) $B = \sqcup_{\lambda \in P} B_\lambda$ where $B_\lambda = B \cap (L_\lambda/qL_\lambda)$,
- (iv) $\tilde{e}_i B \subset B \sqcup \{0\}, \tilde{f}_i B \subset B \sqcup \{0\}$,
- (v) for $b, b' \in B, b' \in \tilde{f}_i b$ if and only if $b = \tilde{e}_i b'$ for $i \in I$.

We sometimes replace (ii) by: $B_{ps} = B' \sqcup (-B')$ where B' is a \mathbf{Q} -base of L/qL . We call (L, B_{ps}) a *crystal psuedo-base* and $B_{ps}/\{\pm 1\}$ the associated crystal of (L, B_{ps}) .

For a dominant integrable weight $\lambda \in P_+ = \{\lambda \in P \mid \langle h_i, \lambda \rangle \leq 0 \text{ for all } i\}$, let $V(\lambda)$ denote the irreducible integrable $U_q(\mathfrak{g})$ -module with highest weight λ . Let u_λ be the highest weight vector of $V(\lambda)$, and let $L(\lambda)$ be the smallest \mathbf{A} -submodule of $V(\lambda)$ containing u_λ and stable under \tilde{f}_i 's. Set $B(\lambda) = \{b \in L(\lambda)/qL(\lambda) \mid b = \tilde{f}_{i_1} \cdots \tilde{f}_{i_r} u_\lambda \text{ mod } qL(\lambda)\} \setminus \{0\}$. Then $(L(\lambda), B(\lambda))$ is crystal base of $V(\lambda)$. Crystal graph is an oriented colored (by I) graph with $B(\lambda)$ as the set of vertices and colored arrow $b \xrightarrow{i} b'$ if and only if $b' = \tilde{f}_i b$ (hence $\tilde{e}_i b' = b$). Then graph completely describes the actions of \tilde{e}_i and \tilde{f}_i on $B(\lambda)$. For $b \in B(\lambda)$, we set

$$\begin{aligned} \varepsilon_i(b) &= \max\{k \geq 0 \mid \tilde{e}_i^k b \neq 0\}, \\ \varphi_i(b) &= \max\{k \geq 0 \mid \tilde{f}_i^k b \neq 0\}. \end{aligned}$$

Note that $B(\lambda) = \sqcup_{\mu \in P} B(\lambda)_\mu$ and for $b \in B(\lambda)_\mu$, we have $\langle h_i, \text{wt}(b) \rangle = \varphi_i(b) - \varepsilon_i(b)$, where $\text{wt}(b) = \mu$ denotes the weight of b .

Proposition 3.1 *Let (L_j, B_j) be crystal bases of integrable $U_q(\mathfrak{g})$ -modules M_j ($j = 1, 2$). Set $L = L_1 \otimes_{\mathbf{A}} L_2 \subset M_1 \otimes M_2$ and $B = \{b_1 \otimes b_2 \mid b_j \in B_j \text{ ($j = 1, 2$)}\} \subset L/qL$. Then (L, B) is the crystal base of $M_1 \otimes M_2$ and the action of \tilde{f}_i, \tilde{e}_i is given by*

$$\begin{aligned} \tilde{f}_i(b_1 \otimes b_2) &= \begin{cases} \tilde{f}_i b_1 \otimes b_2 & \text{if } \varphi_i(b_1) > \varepsilon_i(b_2), \\ b_1 \otimes \tilde{f}_i b_2 & \text{if } \varphi_i(b_1) \leq \varepsilon_i(b_2), \end{cases} \\ \tilde{e}_i(b_1 \otimes b_2) &= \begin{cases} \tilde{e}_i b_1 \otimes b_2 & \text{if } \varphi_i(b_1) \geq \varepsilon_i(b_2), \\ b_1 \otimes \tilde{e}_i b_2 & \text{if } \varphi_i(b_1) < \varepsilon_i(b_2). \end{cases} \end{aligned}$$

Corollary 3.2 For $b_j \in B_j$ ($j = 1, 2$), we have

$$\begin{aligned}\varepsilon_i(b_1 \otimes b_2) &= \max(\varepsilon_i(b_1), \varepsilon_i(b_2) + \varepsilon_i(b_1) - \varphi_i(b_1)), \\ \varphi_i(b_1 \otimes b_2) &= \max(\varphi_i(b_2), \varphi_i(b_1) + \varphi_i(b_2) - \varepsilon_i(b_2)).\end{aligned}$$

Proposition 3.3 Let (L_j, B_j) be crystal bases of integrable $U_q(\mathfrak{g})$ -modules M_j ($j = 1, \dots, N$), and let $\{a_k\}$ be the sequence defined by $a_1 = 0$, $a_{k+1} = a_k + \varphi_i(b_k) - \varepsilon_i(b_{k+1})$. Then we have

$$\tilde{f}_i(b_1 \otimes \cdots \otimes b_N) = b_1 \otimes \cdots \otimes b_{k-1} \otimes \tilde{f}_i b_k \otimes b_{k+1} \otimes \cdots \otimes b_N,$$

where $k = \max\{j \mid a_j = \min\{a_1, \dots, a_N\}\}$,

$$\tilde{e}_i(b_1 \otimes \cdots \otimes b_N) = b_1 \otimes \cdots \otimes b_{l-1} \otimes \tilde{e}_i b_l \otimes b_{l+1} \otimes \cdots \otimes b_N,$$

where $l = \min\{j \mid a_j = \min\{a_1, \dots, a_N\}\}$.

We regard integrable $U_q(\mathfrak{g})$ -module M as a union of finite dimensional $U_q(\mathfrak{g}_{\{i\}})$ -module for any $i \in I$. Let u_0 be the base of trivial representation of $U_q(\mathfrak{sl}_2)$ -module, and let u_+ , u_- be a base of 2 dimensional $U_q(\mathfrak{sl}_2)$ -module which satisfy

$$f u_+ = u_-,$$

where f is one of generators of $U_q(\mathfrak{sl}_2)$.

In order to calculate the action of \tilde{e}_i and \tilde{f}_i on tensor products, we will use u_+ , u_- and u_0 . For that purpose we prepare the following. Let B be a crystal base. Let \mathfrak{W} be the set of words generated by u_+ , u_- , u_0 .

Definition 3.4 For $i \in I$ we define a map

$$\Psi_i : B \rightarrow \mathfrak{W}$$

as follows:

(1) for $b \in B$ such that $\tilde{e}_i b = \tilde{f}_i b = 0$, we define

$$\Psi_i(b) = u_0,$$

(2) if b_k is an element of a maximally connected i -colored crystal subgraph $b_1 \xrightarrow{i} b_2 \xrightarrow{i} \cdots \xrightarrow{i} b_n$ where $n \in \mathbf{Z}_{\geq 2}$, we define

$$\Psi_i(b_k) = u_-^{k-1} u_+^{n-k}.$$

We extend Ψ_i to $b'_1 \otimes \cdots \otimes b'_N \in B^{\otimes N}$, $N \in \mathbf{Z}_{>0}$, by

$$\Psi_i(b'_1 \otimes \cdots \otimes b'_N) = \Psi_i(b'_1) \cdots \Psi_i(b'_N) = u_1 \cdots u_N,$$

where, $\Psi_i(b'_k) = u_k \in \mathfrak{W}$.

For $v = v_1 \cdots v_{N'} \in \mathfrak{W}$, we define the length of the word v by $l(v) = N'$. Let \mathfrak{N} be the set of words generated by $\mathbf{Z}_{>0}$.

Definition 3.5 We define a map $\Psi_{\mathfrak{N}} : B^{\otimes N} \rightarrow \mathfrak{N}$ by

$$\Psi_{\mathfrak{N}}(b'_1 \otimes \cdots \otimes b'_N) = 1^{l(\Psi_i(b_1))} 2^{l(\Psi_i(b_2))} \cdots N^{l(\Psi_i(b_N))}$$

For $r = r_1 \cdots r_{N''} \in \mathfrak{N}$, we also define the length of the word r by $l(r) = N''$.

We put $\mathfrak{W}_j = \{v \in \mathfrak{W} \mid l(v) = j\}$, $\mathfrak{N}_j = \{r \in \mathfrak{N} \mid l(r) = j\}$, where $j \in \mathbf{Z}_{\geq 0}$.

Take words $v = v_1 \cdots v_M \in \mathfrak{W}_M$, $r = r_1 \cdots r_M \in \mathfrak{N}_M$, where $M \in \mathbf{Z}_{\geq 0}$. We put

$$s = \#\{s' \mid v_{s'} = u_0, 1 \leq s' \leq M\},$$

$$\{m_1, m_2, \dots, m_s\} = \{s' \mid v_{s'} = u_0, 1 \leq s' \leq M\},$$

where $1 \leq m_1 < m_2 < \cdots < m_s \leq M$.

Definition 3.6 We define a map

$$\text{Red}_0 : \bigcup_{j \in \mathbf{Z}_{\geq 0}} (\mathfrak{W}_j \times \mathfrak{N}_j) \rightarrow \bigcup_{j \in \mathbf{Z}_{\geq 0}} (\mathfrak{W}_j \times \mathfrak{N}_j).$$

The map Red_0 delete all v_{m_i} which equal to u_0 in v and r_{m_i} in r . Namely we can express

$$\text{Red}_0(v, r) = (v_1 \cdots v_{m_1-1} v_{m_1+1} \cdots v_{m_s-1} v_{m_s+1} \cdots v_M, r_1 \cdots r_{m_1-1} r_{m_1+1} \cdots r_{m_s-1} r_{m_s+1} \cdots r_M).$$

We define

$$s_0 = \begin{cases} \min\{m \mid v_m = u_+, v_{m+1} = u_-\} & \text{if there exists } m \text{ such that } v_m = u_+, v_{m+1} = u_-, \\ 0 & \text{otherwise.} \end{cases}$$

Definition 3.7 We define a map

$$\text{Red}_+ : \bigcup_{j \in \mathbf{Z}_{\geq 0}} (\mathfrak{W}_j \times \mathfrak{N}_j) \rightarrow \bigcup_{j \in \mathbf{Z}_{\geq 0}} (\mathfrak{W}_j \times \mathfrak{N}_j),$$

for $v = v_1 \cdots v_M \in \mathfrak{W}_M$, $r = r_1 \cdots r_M \in \mathfrak{N}_M$ by

$$\text{Red}_+(v, r) = \begin{cases} (v_1 \cdots v_{s_0-1} v_{s_0+2} \cdots v_M, r_1 \cdots r_{s_0-1} r_{s_0+2} \cdots r_M) & \text{if } s_0 \geq 1, \\ (v, r) & \text{if } s_0 = 0. \end{cases}$$

Definition 3.8 We define a map

$$\text{Red} : \bigcup_{j \in \mathbf{Z}_{\geq 0}} (\mathfrak{W}_j \times \mathfrak{N}_j) \rightarrow \bigcup_{j \in \mathbf{Z}_{\geq 0}} (\mathfrak{W}_j \times \mathfrak{N}_j)$$

by

$$\text{Red} = \text{Red}_+^n \text{Red}_0,$$

where $n \in \mathbf{Z}_{\geq 0}$ such that $n = \min\{n' \mid \text{Red}_+^{n'+1}(\text{Red}_0(v, r)) = \text{Red}_+^{n'}(\text{Red}_0(v, r))\}$.

By Definition 3.8, we can denote

$$\text{Red}(\Psi_i(b), \Psi_{\mathfrak{N}}(b)) = (v'_1 v'_2 \cdots v'_{M'}, r'_1 r'_2 \cdots r'_{M'})$$

where $M' \in \mathbf{Z}_{\geq 0}$. Let $\text{Pr}_{\mathfrak{W}}$, $\text{Pr}_{\mathfrak{N}}$ be a projection of $\bigcup_{j \in \mathbf{Z}} (\mathfrak{W}_j \times \mathfrak{N}_j)$ to \mathfrak{W} , \mathfrak{N} respectively. We define a map

$$\text{Red}_i : B^{\otimes N} \rightarrow \mathfrak{W},$$

by

$$\text{Red}_i = \text{Pr}_{\mathfrak{W}} \cdot \text{Red}(\Psi_i, \Psi_{\mathfrak{N}})$$

We define a map

$$\text{Red}_{\mathfrak{N}} : B^{\otimes N} \rightarrow \mathfrak{N},$$

by

$$\text{Red}_{\mathfrak{N}} = \text{Pr}_{\mathfrak{N}} \cdot \text{Red}(\Psi_i, \Psi_{\mathfrak{N}})$$

We set

$$s_+ = \begin{cases} \min\{s' \mid v'_{s'} = u_+\} & \text{if there exists } s' \text{ such that } v'_{s'} = u_+, \\ 0 & \text{otherwise,} \end{cases}$$

$$s_- = \begin{cases} \max\{s' \mid v'_{s'} = u_-\} & \text{if there exists } s' \text{ such that } v'_{s'} = u_-, \\ 0 & \text{otherwise.} \end{cases}$$

Proposition 3.9 For $b = b_1 \otimes \cdots \otimes b_N \in B^{\otimes N}$, we have

$$\tilde{f}_i(b) = \begin{cases} b_1 \otimes \cdots \otimes \tilde{f}_i b_{r_{s_+}} \otimes \cdots \otimes b_N & \text{if } s_+ > 0, \\ 0 & \text{if } s_+ = 0, \end{cases}$$

$$\tilde{e}_i(b) = \begin{cases} b_1 \otimes \cdots \otimes \tilde{e}_i b_{r_{s_-}} \otimes \cdots \otimes b_N & \text{if } s_- > 0, \\ 0 & \text{if } s_- = 0. \end{cases}$$

For $b = b_1 \otimes \cdots \otimes b_N \in B^{\otimes N}$, we denote $\Psi_i(b_k) = u_-^{\varepsilon_i(b_k)} u_+^{\varphi_i(b_k)}$. Then we see that Proposition 3.3 and Proposition 3.9 are equivalent.

Remark 3.10 For $b = b_1 \otimes \cdots \otimes b_N$, we denote $\text{Red}_i(b) = u_-^{m_1} u_+^{m_2}$ ($m_1, m_2 \in \mathbf{Z}_{\geq 0}$). Then by Definition 3.4 and Proposition 3.9, we see

$$\varepsilon_i(b) = m_1,$$

$$\varphi_i(b) = m_2.$$

Example 3.11 We assume $b = b_1 \otimes b_2 \otimes b_3$, $\Psi_i(b_1) = u_1 = u_- u_+ u_+$, $\Psi_i(b_2) = u_2 = u_0$ and $\Psi_i(b_3) = u_3 = u_- u_+$. We calculate $\tilde{f}_i b$ as follows:

$$\begin{aligned} \Psi_i(b) &= \Psi_i(b_1) \Psi_i(b_2) \Psi_i(b_3) \\ &= u_1 u_2 u_3 \\ &= u_- u_+ u_+ u_0 u_- u_+, \\ \Psi_{\mathfrak{rt}}(b) &= 111233, \\ \text{Red}_0(\Psi_i(b), \Psi_{\mathfrak{rt}}(b)) &= (u_- u_+ u_+ u_- u_+, 11133), \\ \text{Red}(\Psi_i(b), \Psi_{\mathfrak{rt}}(b)) &= (u_- u_+ u_+, 113), \\ \text{Red}_i(b) &= u_- u_+ u_+. \end{aligned}$$

Then we have $s_+ = 2$, and that s_+ -th integer of the word 113 is 1. Therefore,

$$\tilde{f}_i b = (\tilde{f}_i b_1) \otimes b_2 \otimes b_3.$$

3.1.3 Crystal bases for $U_q(A_2)$ -module[6]

Consider the finite dimensional simple Lie algebra of type A_2 with Cartan matrix $\begin{pmatrix} 2 & -1 \\ -1 & 2 \end{pmatrix}$, Let us denote by $\{\alpha_1, \alpha_2\}$ the set of simple roots and $\{h_1, h_2\}$ the set of simple coroots. Define $\Lambda_i \in \mathfrak{h}^*$ ($i = 1, 2$) by $\Lambda_i(h_j) = \delta_{ij}$, ($j = 1, 2$). We put $P = \mathbf{Z}\Lambda_1 \oplus \mathbf{Z}\Lambda_2$, $P^* = \mathbf{Z}h_1 \oplus \mathbf{Z}h_2$. Thus any dominant integral weight $\Lambda \in P_+$ is of the form $\Lambda = m\Lambda_1 + n\Lambda_2$, ($n, m \in \mathbf{Z}_+$). We define a non-degenerate symmetric bilinear form (\cdot, \cdot) on \mathfrak{h}^* by $(\alpha_1, \alpha_1) = (\alpha_2, \alpha_2) = 1$, $(\alpha_1, \alpha_2) = (\alpha_2, \alpha_1) = -\frac{1}{2}$, $\langle h_i, \alpha_j \rangle$ is the (i, j) -th element of Cartan matrix and set $t_i = q^{h_i}$ for $i = 1, 2$. Then the corresponding quantized universal enveloping algebra $U_q(A_2)$ is the associative algebra over $\mathbf{Q}(q)$ generated by e_i, f_i, t_i, t_i^{-1} ($i = 1, 2$) satisfying the relations:

$$\begin{aligned} t_i t_j &= t_j t_i, & t_i t_i^{-1} &= t_i^{-1} t_i = 1, \\ t_i e_j t_i^{-1} &= q^{\langle h_i, \alpha_j \rangle} e_j, & t_i f_j t_i^{-1} &= q^{-\langle h_i, \alpha_j \rangle} f_j, \\ [e_i, f_j] &= \delta_{ij} \frac{t_i - t_i^{-1}}{q - q^{-1}}, \\ e_i^{(2)} e_j - e_i e_j e_i + e_j e_i^{(2)} &= f_i^{(2)} f_j - f_i f_j f_i + f_j f_i^{(2)} = 0 \quad (i \neq j). \end{aligned}$$

Let V be the 3-dimensional $\mathbf{Q}(q)$ -vector space with a basis $\{\boxed{1}, \boxed{2}, \boxed{3}\}$. We define a $U_q(A_2)$ -module structure on V as follows:

$$\begin{aligned} e_1\boxed{1} &= 0, & e_1\boxed{2} &= \boxed{1}, & e_1\boxed{3} &= 0, \\ e_2\boxed{1} &= 0, & e_2\boxed{2} &= 0, & e_2\boxed{3} &= \boxed{2}, \\ f_1\boxed{1} &= \boxed{2}, & f_1\boxed{2} &= 0, & f_1\boxed{3} &= 0, \\ f_2\boxed{1} &= 0, & f_2\boxed{2} &= \boxed{3}, & f_2\boxed{3} &= 0, \\ t_1\boxed{1} &= q\boxed{1}, & t_1\boxed{2} &= q^{-1}\boxed{2}, & t_1\boxed{3} &= \boxed{3}, \\ t_2\boxed{1} &= \boxed{1}, & t_2\boxed{2} &= q\boxed{2}, & t_2\boxed{3} &= q^{-1}\boxed{3}. \end{aligned}$$

The module V is isomorphic to the integrable highest weight $U_q(A_2)$ -module $V(\Lambda_1)$ with highest weight Λ_1 and highest weight vector $\boxed{1}$.

Proposition 3.12 *Put*

$$\begin{aligned} L(\Lambda_1) &= \mathbf{A}\boxed{1} \oplus \mathbf{A}\boxed{2} \oplus \mathbf{A}\boxed{3}, \\ B(\Lambda_1) &= \{\boxed{1}, \boxed{2}, \boxed{3}\}. \end{aligned}$$

Then $(L(\Lambda_1), B(\Lambda_1))$ is the crystal base of $V(\Lambda_1)$. The crystal graph $B(\Lambda_1)$ is given by:

$$\boxed{1} \xrightarrow{1} \boxed{2} \xrightarrow{2} \boxed{3}.$$

Define an ordering on the set $B(\Lambda_1)$ by

$$\boxed{1} < \boxed{2} < \boxed{3}.$$

We write $\begin{smallmatrix} a \\ b \end{smallmatrix}$ for $\boxed{a} \otimes \boxed{b}$ ($a < b$). Similar to the $B(\Lambda_1)$ -case, the crystal graph $B(\Lambda_2)$ is given by:

$$\begin{smallmatrix} \boxed{1} \\ \boxed{2} \end{smallmatrix} \xrightarrow{2} \begin{smallmatrix} \boxed{1} \\ \boxed{3} \end{smallmatrix} \xrightarrow{2} \begin{smallmatrix} \boxed{2} \\ \boxed{3} \end{smallmatrix}.$$

Proposition 3.13 *The crystal bases of $B(m\Lambda_1 + n\Lambda_2)$ is given by the set of semi-standard Young tableaux of the same shape*

$$\begin{aligned} &B(m\Lambda_1 + n\Lambda_2) \\ &= \left\{ \begin{array}{|c|c|c|c|c|} \hline b_1^{m+n} & \cdots & b_1^{m+1} & b_1^m & \cdots & b_1^1 \\ \hline b_2^{m+n} & \cdots & b_2^{m+1} & & & \\ \hline \end{array} \middle| b_i^j \in \{1, 2, 3\}, b_i^j \leq b_i^{j-1}, b_1^j < b_2^j \right\}. \end{aligned}$$

In particular, highest weight element $\hat{b} \in B(m\Lambda_1 + n\Lambda_2)$ is given by

$$\hat{b} = \begin{array}{|c|c|c|c|c|} \hline 1 & \cdots & 1 & 1 & \cdots & 1 \\ \hline 2 & \cdots & 2 & & & \\ \hline \end{array}.$$

By Definition 3.4 we have

$$\Psi_i(\boxed{j}) = \begin{cases} u_+ & \text{if } i = j, \\ u_- & \text{if } i + 1 = j, \\ u_0 & \text{otherwise.} \end{cases}$$

An element b of $B(m\Lambda_1 + n\Lambda_2)$ can be expressed in the form

$$\boxed{b_1^1} \otimes \cdots \otimes \boxed{b_1^m} \otimes \left(\boxed{b_1^{m+1}} \otimes \boxed{b_2^{m+1}} \right) \otimes \cdots \otimes \left(\boxed{b_1^{m+n}} \otimes \boxed{b_2^{m+n}} \right) \in B(\Lambda_1)^{\otimes m+2n}.$$

Then using Proposition 3.9, we have the action of \tilde{e}_i and \tilde{f}_i .

3.1.4 Crystal bases for $U_q(G_2)$ -module[7]

Consider the finite dimensional simple Lie algebra of type G_2 with Cartan matrix $\begin{pmatrix} 2 & -1 \\ -3 & 2 \end{pmatrix}$. Let $\{\alpha_1, \alpha_2\}, \{h_1, h_2\}$ be the set of simple root and simple coroot respectively. Let $\mathfrak{h}, \Lambda_i (i = 1, 2), P$ and P^* be Cartan subalgebra, fundamental weight, weight lattice and dual lattice, respectively. We define a non-degenerate symmetric bilinear form (\cdot, \cdot) on \mathfrak{h}^* by $(\alpha_1, \alpha_1) = 3, (\alpha_2, \alpha_2) = 1, (\alpha_1, \alpha_2) = (\alpha_2, \alpha_1) = -\frac{3}{2}, \langle h_i, \alpha_j \rangle$ is (i, j) -element of Cartan matrix and set $q_i = q^{(\alpha_i, \alpha_i)}, t_i = q^{h_i}$ for $i = 1, 2$. Then the corresponding quantized universal enveloping algebra $U_q(G_2)$ is the associative algebra over $\mathbf{Q}(q)$ generated by $e_i, f_i, t_i, t_i^{-1} (i = 1, 2)$ satisfying the relations:

$$\begin{aligned} t_i t_j &= t_j t_i, & t_i t_i^{-1} &= t_i^{-1} t_i = 1, \\ t_i e_j t_i^{-1} &= q_i^{\langle h_i, \alpha_j \rangle} e_j, & t_i f_j t_i^{-1} &= q_i^{-\langle h_i, \alpha_j \rangle} f_j, \\ [e_i, f_j] &= \delta_{ij} \frac{t_i - t_i^{-1}}{q_i - q_i^{-1}}, \\ e_1^{(2)} e_2 - e_1 e_2 e_1 + e_2 e_1^{(2)} &= f_1^{(2)} f_2 - f_1 f_2 f_1 + f_2 f_1^{(2)} = 0, \\ \sum_{n=0}^4 (-1)^n e_2^{(n)} e_1 e_2^{(4-n)} &= \sum_{n=0}^4 (-1)^n e_2^{(n)} e_1 e_2^{(4-n)} = 0. \end{aligned}$$

Let V be the 14-dimensional $\mathbf{Q}(q)$ -vector space with a basis

$$\left\{ \boxed{i}, \overline{\boxed{i}} \mid i = 1, \dots, 6 \right\} \cup \left\{ \boxed{0_1}, \boxed{0_2} \right\}.$$

We define a $U_q(G_2)$ -module structure on V as follows:

$$\begin{aligned} e_1 \boxed{2} &= \boxed{1}, e_1 \overline{\boxed{5}} = \boxed{4}, e_1 \boxed{0_2} = [2]_2 \boxed{6}, e_1 \overline{\boxed{6}} = \boxed{0_2} + \frac{1}{[2]_2} \boxed{0_1}, \\ e_1 \overline{\boxed{4}} &= \overline{\boxed{5}}, e_1 \overline{\boxed{1}} = \overline{\boxed{2}}, \\ e_2 \boxed{3} &= [3]_2 \boxed{2}, e_2 \boxed{4} = [2]_2 \boxed{3}, e_2 \boxed{6} = \boxed{4}, e_2 \boxed{0_1} = [2]_2 \boxed{5}, \\ e_2 \overline{\boxed{5}} &= \boxed{0_1} + \frac{[3]_2}{[2]_1} \boxed{0_2}, e_2 \overline{\boxed{4}} = [3]_2 \overline{\boxed{6}}, e_2 \overline{\boxed{3}} = [2]_2 \overline{\boxed{4}}, e_2 \overline{\boxed{2}} = \overline{\boxed{3}}, \\ f_1 \boxed{1} &= \boxed{2}, f_1 \overline{\boxed{4}} = \overline{\boxed{5}}, f_1 \boxed{6} = \boxed{0_2} + \frac{1}{[2]_2} \boxed{0_1}, \\ f_1 \boxed{0_2} &= [2]_2 \overline{\boxed{6}}, f_1 \overline{\boxed{5}} = \overline{\boxed{4}}, f_1 \overline{\boxed{2}} = \overline{\boxed{1}}, \\ f_2 \overline{\boxed{2}} &= \overline{\boxed{3}}, f_2 \overline{\boxed{3}} = [2]_2 \overline{\boxed{4}}, f_2 \overline{\boxed{4}} = [3]_2 \overline{\boxed{6}}, f_2 \overline{\boxed{5}} = \boxed{0_1} + \frac{[3]_2}{[2]_1} \boxed{0_2}, \\ f_2 \boxed{0_1} &= [2]_2 \overline{\boxed{5}}, f_2 \overline{\boxed{6}} = \overline{\boxed{4}}, f_2 \overline{\boxed{4}} = [2]_2 \overline{\boxed{3}}, f_2 \overline{\boxed{3}} = [3]_2 \overline{\boxed{2}}, \\ t_1 \boxed{1} &= q_1 \boxed{1}, t_1 \boxed{2} = q_1^{-1} \boxed{2}, t_1 \boxed{3} = \boxed{3}, t_1 \overline{\boxed{4}} = q_1 \overline{\boxed{4}}, t_1 \overline{\boxed{5}} = q_1^{-1} \overline{\boxed{5}}, \\ t_1 \overline{\boxed{6}} &= q_1^{-2} \overline{\boxed{6}}, t_1 \boxed{0_1} = \boxed{0_1}, t_1 \boxed{0_2} = \boxed{0_2}, t_1 \overline{\boxed{6}} = q_1^{-2} \overline{\boxed{6}}, \\ t_1 \overline{\boxed{5}} &= q_1 \overline{\boxed{5}}, t_1 \overline{\boxed{4}} = q_1^{-1} \overline{\boxed{4}}, t_1 \overline{\boxed{3}} = \overline{\boxed{3}}, t_1 \boxed{2} = q_1 \boxed{2}, t_1 \overline{\boxed{1}} = q_1^{-1} \overline{\boxed{1}}, \\ t_2 \boxed{1} &= \boxed{1}, t_2 \overline{\boxed{2}} = q_2^3 \overline{\boxed{2}}, t_2 \overline{\boxed{3}} = q_2 \overline{\boxed{3}}, t_2 \overline{\boxed{4}} = q_2^{-1} \overline{\boxed{4}}, t_2 \overline{\boxed{5}} = q_2^2 \overline{\boxed{5}}, \\ t_2 \overline{\boxed{6}} &= q_2^{-3} \overline{\boxed{6}}, t_2 \boxed{0_1} = \boxed{0_1}, t_2 \boxed{0_2} = \boxed{0_2}, t_2 \overline{\boxed{6}} = q_2^3 \overline{\boxed{6}}, \\ t_2 \overline{\boxed{5}} &= q_2^{-2} \overline{\boxed{5}}, t_2 \overline{\boxed{4}} = q_2 \overline{\boxed{4}}, t_2 \overline{\boxed{3}} = q_2^{-1} \overline{\boxed{3}}, t_2 \overline{\boxed{2}} = q_2^{-3} \overline{\boxed{2}}, t_2 \overline{\boxed{1}} = \overline{\boxed{1}}. \end{aligned}$$

The other cases, $b \in B(\Lambda_1)$ is annihilated by \tilde{e}_i or \tilde{f}_i .

The module V is isomorphic to the integrable highest weight $U_q(G_2)$ -module $V(\Lambda_1)$ with highest weight Λ_1 and highest weight vector $\boxed{1}$.

Proposition 3.14 *Put*

$$L(\Lambda_1) = \bigoplus_{i=1}^6 \left(\mathbf{A} \boxed{i} \oplus \mathbf{A} \overline{\boxed{i}} \right) \oplus \mathbf{A} \boxed{0_1} \oplus \mathbf{A} \boxed{0_2},$$

$$B(\Lambda_1) = \left\{ \boxed{i}, \mathbf{A} \overline{\boxed{i}} \mid i = 1, 2, \dots, 6 \right\} \cup \left\{ \boxed{0_1}, \boxed{0_2} \right\}.$$

Then $(L(\Lambda_1), B(\Lambda_1))$ is the crystal base of $V(\Lambda_1)$. The crystal graph $B(\Lambda_1)$ is given by:

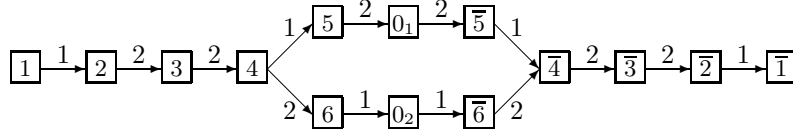

Define an ordering on the set $B(\Lambda_1)$ by

$$\boxed{1} \prec \boxed{2} \prec \boxed{3} \prec \boxed{4} \prec \begin{matrix} \boxed{5} \\ \boxed{6} \end{matrix} \prec \begin{matrix} \boxed{0_1} \\ \boxed{0_2} \end{matrix} \prec \begin{matrix} \boxed{5} \\ \boxed{6} \end{matrix} \prec \boxed{4} \prec \boxed{3} \prec \boxed{2} \prec \boxed{1}.$$

We define the map sgn , x_i , and \bar{x}_i .

For $a \in \mathbf{R}$, we define $\text{sgn}(a)$ by

$$\text{sgn}(a) = \begin{cases} \frac{a}{|a|} & a \neq 0, \\ 0 & a = 0. \end{cases}$$

For $b = \boxed{b_1 \dots b_n}$, we define $x_i(b)$, $\bar{x}_i(b)$ by

$$x_i(b) = \# \left\{ \boxed{b_k} = \boxed{i} \mid k = 1, \dots, n \right\} \quad (i = 1, \dots, 6, 0_1, 0_2),$$

$$\bar{x}_i(b) = \# \left\{ \boxed{b_k} = \overline{\boxed{i}} \mid k = 1, \dots, n \right\} \quad (i = 1, \dots, 6).$$

Proposition 3.15 *The crystal bases of $B(n\Lambda_1)$ is given by following set of restricted semi-standard Young tableaux:*

$$\left\{ \begin{array}{l} b = \boxed{b_1 \dots b_l} \\ = \boxed{b_l} \otimes \dots \otimes \boxed{b_1} \end{array} \left| \begin{array}{l} b_k \leq b_{k+1} \quad (k = 1, \dots, l-1) \\ x_5(b) + x_{0_1}(b) + x_{0_2} + \bar{x}_5(b) \leq 1, \\ x_3(b) + x_4(b) + x_5(b) \leq 1, \\ \bar{x}_5(b) + \bar{x}_4(b) + \bar{x}_3(b) \leq 1, \\ x_5(b) + \text{sgn}(x_6(b)) + x_{0_1}(b) \leq 1, \\ x_{0_1}(b) + \text{sgn}(\bar{x}_6(b)) + \bar{x}_5(b) \leq 1 \end{array} \right. \right\}.$$

By Definition 3.4, we have

$$\begin{aligned} \Psi_1(\boxed{1}) &= u_+, & \Psi_1(\boxed{2}) &= u_-, & \Psi_1(\boxed{3}) &= u_0, & \Psi_1(\boxed{4}) &= u_+, \\ \Psi_1(\boxed{5}) &= u_-, & \Psi_1(\boxed{6}) &= u_+^2, & \Psi_1(\boxed{0_1}) &= u_0, & \Psi_1(\boxed{0_2}) &= u_- u_+, \\ \Psi_1(\boxed{6}) &= u_-^2, & \Psi_1(\boxed{5}) &= u_+, & \Psi_1(\boxed{4}) &= u_-, & \Psi_1(\boxed{3}) &= u_0, \\ \Psi_1(\boxed{2}) &= u_+, & \Psi_1(\boxed{1}) &= u_-, \end{aligned}$$

$$\begin{aligned}
\Psi_2(\overline{1}) &= u_0, & \Psi_2(\overline{2}) &= u_+^3, & \Psi_2(\overline{3}) &= u_-u_+^2, & \Psi_2(\overline{4}) &= u_-^2u_+, \\
\Psi_2(\overline{5}) &= u_+^2, & \Psi_2(\overline{6}) &= u_-^3, & \Psi_2(\overline{0_1}) &= u_-u_+, & \Psi_2(\overline{0_2}) &= u_0, \\
\Psi_2(\overline{6}) &= u_+^3, & \Psi_2(\overline{5}) &= u_-^2, & \Psi_2(\overline{4}) &= u_-u_+^2, & \Psi_2(\overline{3}) &= u_-^2u_+, \\
\Psi_2(\overline{2}) &= u_-^3, & \Psi_2(\overline{1}) &= u_0.
\end{aligned} \tag{3.1.1}$$

3.1.5 Affine crystal

Here we recall the definition of affine crystal. Let \mathfrak{g} be an affine Lie algebra over \mathbf{Q} with an indecomposable generalized Cartan Matrix. Let $c \in \sum_i \mathbf{Z}_{\geq 0} \mathfrak{h}_i$ be the canonical central element. Let $\{\alpha_i \mid i \in I\} \subset \mathfrak{h}^*$ be the set of simple roots, and let $\{h_i \mid i \in I\} \subset \mathfrak{h}$ be the set of coroots. Let $\delta \in \sum_i \mathbf{Z}_{\geq 0} \alpha_i$ be the generator of null roots. Set $\mathfrak{h}_{cl} = \bigoplus_{i \in I} \mathbf{Q}h_i \subset \mathfrak{h}$ and $\mathfrak{h}_{cl}^* = (\bigoplus_{i \in I} \mathbf{Q}h_i)^*$. Let $cl : \mathfrak{h}^* \rightarrow \mathfrak{h}_{cl}^*$ denote the canonical morphism. We have an exact sequence $0 \rightarrow \mathbf{Q}\delta \rightarrow \mathfrak{h}^* \rightarrow \mathfrak{h}_{cl}^* \rightarrow 0$. Fix $i_0 \in I$ and take an integer d such that $\delta - d\alpha_{i_0} \in \sum_{i \neq i_0} \mathbf{Z}\alpha_i$. For simplicity we write 0 for i_0 . We define a map $af : \mathfrak{h}^* \rightarrow \mathfrak{h}^*$ satisfying: $cl \circ af = \text{id}$ and $cl \circ af(\alpha_i) = \alpha_i$ for $i \neq 0$. Let Λ_i be the element of $\mathfrak{h}_{cl}^* \subset \mathfrak{h}^*$ such that $\langle h_j, \Lambda_i \rangle = \delta_{ij}$. Hence we have $\alpha_i = \sum_j \langle h_j, \alpha_i \rangle af(\Lambda_i) + \delta_{i,0} d^{-1} \delta$. We define $P = \sum_i \mathbf{Z}af(\Lambda_i) + \mathbf{Z}d^{-1}\delta \subset \mathfrak{h}^*$ and $P_{cl} = cl(P) \subset \mathfrak{h}_{cl}^*$. An element of P is called an *affine weight* and an element in P_{cl} is called a *classical weight*. Let $U'_q(\mathfrak{g})$ be the quantized universal enveloping algebra associated with P_{cl} . A P -weighted crystal is called an *affine crystal* and a P_{cl} -weighted crystal is called a *classical crystal*. Let $\text{Mod}^f(\mathfrak{g}, P_{cl})$ be the category of $U'_q(\mathfrak{g})$ -module M satisfying the following conditions:

$$M \text{ has the weight decomposition } M = \bigoplus_{\lambda \in P_{cl}} M_\lambda,$$

and

$$M \text{ is finite-dimensional over } \mathbf{Q}(q).$$

For a $U'_q(\mathfrak{g})$ -module M in $\text{Mod}^f(\mathfrak{g}, P_{cl})$, we define the $U_q(\mathfrak{g})$ -module $\text{Aff}(M)$ by

$$\text{Aff}(M) = \bigoplus_{\lambda \in P} \text{Aff}(M)_\lambda, \quad \text{Aff}(M)_\lambda = M_{cl(\lambda)} \text{ for } \lambda \in P.$$

The actions of e_i and f_i are defined by the commutative diagrams

$$\begin{array}{ccccc}
\text{Aff}(M)_\lambda & \xrightarrow{e_i} & \text{Aff}(M)_{\lambda+\alpha_i} & & \text{Aff}(M)_\lambda & \xrightarrow{f_i} & \text{Aff}(M)_{\lambda-\alpha_i} \\
\wr & & \wr & \text{and} & \wr & & \wr \\
M_{cl(\lambda)} & \xrightarrow{e_i} & M_{cl(\lambda+\alpha_i)} & & M_{cl(\lambda)} & \xrightarrow{f_i} & M_{cl(\lambda-\alpha_i)}.
\end{array}$$

We define the $U'_q(\mathfrak{g})$ -linear automorphism T of $\text{Aff}(M)$ by

$$\begin{array}{ccc}
\text{Aff}(M)_\lambda & \xrightarrow{T} & \text{Aff}(M)_{\lambda+\delta} \\
\wr & & \wr \\
M_{cl(\lambda)} & \xrightarrow{id} & M_{cl(\lambda+\delta)}.
\end{array}$$

3.1.6 Quantized universal enveloping algebra $U_q(G_2^{(1)})$ -module

Consider the finite dimensional affine Lie algebra $G_2^{(1)}$ with Cartan matrix $\begin{pmatrix} 2 & -1 & 0 \\ -1 & 2 & -1 \\ 0 & -3 & 2 \end{pmatrix}$.

Let $\{\alpha_0, \alpha_1, \alpha_2\}$, $\{h_0, h_1, h_2\}$ be the set of simple root and simple coroot respectively. Let \mathfrak{h} and Λ_i ($i = 0, 1, 2$) be Cartan subalgebra, fundamental weight, respectively. We define a non-degenerate symmetric bilinear form (\cdot, \cdot) on \mathfrak{h}^* by $(\alpha_0, \alpha_0) = (\alpha_1, \alpha_1) = 3$, $(\alpha_2, \alpha_2) = 1$, $(\alpha_0, \alpha_1) = (\alpha_1, \alpha_0) = (\alpha_1, \alpha_2) = (\alpha_2, \alpha_1) = -\frac{3}{2}$, $\langle h_i, \alpha_j \rangle$ is (i, j) -element of Cartan matrix and set $q_i = q^{(\alpha_i, \alpha_i)}$, $t_i = q^{h_i}$ for $i = 1, 2$. Canonical central

element is $c = h_0 + 2h_1 + h_2$. Then the corresponding quantized universal enveloping algebra $U_q(G_2^{(1)})$ is the associative algebra over $\mathbf{Q}(q)$ generated by e_i, f_i, t_i, t_i^{-1} ($i = 0, 1, 2$) satisfying the relations:

$$\begin{aligned} t_i t_j &= t_j t_i, & t_i t_i^{-1} &= t_i^{-1} t_i = 1, \\ t_i e_j t_i^{-1} &= q_i^{\langle h_i, \alpha_j \rangle} e_j, & t_i f_j t_i^{-1} &= q_i^{-\langle h_i, \alpha_j \rangle} f_j, \\ [e_i, f_j] &= \delta_{ij} \frac{t_i - t_i^{-1}}{q_i - q_i^{-1}} \\ \sum_{n=0}^l (-1)^n e_i^{(n)} e_j e_i^{(l-n)} &= \sum_{n=0}^l (-1)^n e_i^{(n)} e_j e_i^{(l-n)} = 0, & (i \neq j, l = 1 - \langle h_i, \alpha_j \rangle). \end{aligned}$$

3.2 Perfect crystal[9]

Let B be a classical crystal. For $b \in B$, we set $\varepsilon(b) = \sum_i \varepsilon_i(b) \Lambda_i$, and $\varphi(b) = \sum_i \varphi_i(b) \Lambda_i$. Note that $\text{wt}(b) = \varphi(b) - \varepsilon(b)$. Set $P_{cl}^+ = \{\lambda \in P_{cl} \mid \langle h_i, \lambda \rangle \geq 0 \text{ for all } i \in I\}$ and for $l \in \mathbf{Z}_{\geq 0}$, let $(P_{cl}^+)_l = \{\lambda \in P_{cl}^+ \mid \langle c, \lambda \rangle = l\}$.

Definition 3.16 (Definition 4.6.1 in [9])

For $l \in \mathbf{Z}_{\geq 0}$, we say that B is a *perfect crystal of level l* if

- (1) $B \otimes B$ is connected.
- (2) There exists $\lambda_0 \in P_{cl}$ such that $\text{wt}(B) \in \lambda_0 + \sum_{i \neq 0} \mathbf{Z}_{\leq 0} \text{cl}(\alpha_i)$ and that $\sharp(B_{\lambda_0}) = 1$.
- (3) There is a finite dimensional $U'_q(\mathfrak{g})$ -module with a crystal pseudo-base (L, B_{ps}) such that $B \cong B_{ps} / \pm 1$.
- (4) For any $b \in B$, we have $\langle c, \varepsilon(b) \rangle \geq l$.
- (5) The maps $\varepsilon, \varphi : B_l = \{b \in B \mid \langle c, \varepsilon(b) \rangle = l\} \rightarrow (P_{cl}^+)_l$ are bijective.

The elements in B_l are called *minimal elements*.

Definition 3.17 Let M be a $U_q(\mathfrak{g})$ -module. A symmetric bilinear form $(,)$ on M is called a *prepolarization* of M if it satisfies for $u, v \in M$:

- (i) $(q^h u, v) = (u, q^h v)$,
- (ii) $(e_i u, v) = (u, q_i^{-1} t_i^{-1} f_i v)$,
- (iii) $(f_i u, v) = (u, q_i^{-1} t_i e_i v)$.

A prepolarization is called a *polarization* if it is positive definite.

Lemma 3.18 (Lemma 3.4.4 in [9])

Let M be a $U'_q(\mathfrak{g})$ -module in $\text{Mod}^f(\mathfrak{g}, P_{cl})$. Assume that M has a crystal pseudo-base (L, B) such that

- (i) there exists $\lambda \in P_{cl}$ such that $\sharp(B / \{\pm 1\})_\lambda = 1$,
- (ii) $B / \{\pm 1\}$ is connected.

Then M is an irreducible $U'_q(\mathfrak{g})$ -module.

Let us introduce the subalgebras \mathbf{A}_Z and \mathbf{K}_Z of $\mathbf{Q}(q)$ as follows:

$$\begin{aligned} \mathbf{A}_Z &= \{f(q)/g(q) \mid f(q), g(q) \in \mathbf{Z}[q], g(0) = 1\}, \\ \mathbf{K}_Z &= \mathbf{A}_Z[q^{-1}]. \end{aligned}$$

Proposition 3.19 (Proposition 2.6.2 in [8])

Assume that \mathfrak{g} is finite dimensional and let M be a finite dimensional integrable $U_q(\mathfrak{g})$ -module of M . Let $(,)$ be a prepolarization on M , and M_{K_Z} a $U_q(\mathfrak{g})$ -submodule of M such that $(M_{K_Z}, M_{K_Z}) \subset K_Z$. Let $\lambda_1, \dots, \lambda_m \in P_+$ ($\lambda_k = \sum_j a_{kj} \Lambda_j$, $a_{kj} \in \mathbf{Z}_{\geq 0}$, $k = 1, \dots, m$), and we assume the following conditions.

- (i) $\dim M_{\lambda_k} \leq \sum_{j=1}^m \dim V(\lambda_j)_{\lambda_k}$ for $k = 1, \dots, m$.
- (ii) There exists $u_j \in (M_{K_Z})_{\lambda_j}$ ($j = 1, \dots, m$) such that $(u_j, u_k) \in \delta_{jk} + qA$ and $(e_i u_j, e_i u_j) \in qq^{-2(1+\langle h_i, \lambda_j \rangle)} A$ for all $i \in I$.

Set $L = \{U \in M \mid (u, u) \in A\}$ and set $B = \{b \in M_{K_Z} \cap L / M_{K_Z} \cap qL \mid (b, b)_0 = 1\}$. Then we have

- (i) $(,)$ is a polarization on M ,
- (ii) $M \cong \oplus V(\lambda_j)$,
- (iii) $(,)_0$ is positive definite, and (L, B) is a crystal pseudo-base of M .

Lemma 3.20 (Lemma 4.1.2 [8]) A polarization $(,)$ for Kac-Moody Lie algebra with symmetrizable Cartan matrix satisfies following relations.

- (i) Let b be a global base which satisfies $e_i b = 0$ and $\langle h_i, \text{wt}(b) \rangle = 1$. Then $(b, b) = (f_i b, f_i b)$.
- (ii) Let b be a global base which satisfies $e_i b = 0$ and $\langle h_i, \text{wt}(b) \rangle = 2$. Then $(b, b) = (f_i^{(2)} b, f_i^{(2)} b) = q_i^{-1} [2]_i^{-1} (f_i b, f_i b)$.
- (iii) Let b be a global base which satisfies $e_i b = 0$ and $\langle h_i, \text{wt}(b) \rangle = 3$. Then $(b, b) = (f_i^{(3)} b, f_i^{(3)} b) = q_i^{-2} [3]_i^{-1} (f_i^{(2)} b, f_i^{(2)} b) = q_i^{-1} [2]_i^{-1} (f_i b, f_i b)$.

The existence of polarization for Kac-Moody Lie algebra with symmetrizable Cartan matrix is proved in Proposition 3.4.4 [4].

Proposition 3.21 (Proposition 3.4.5 in [8])

Let m be a positive integer and assume the following conditions:

- (i) $\langle h_i, l\lambda_0 + j\alpha_{i_0} \rangle \geq 0$ for $i \neq i_0$ and $0 \leq j \leq m$,
- (ii) $\dim(V_l)_{l\lambda_0 + k\alpha_{i_0}} \leq \sum_{j=0}^m \dim V(l\lambda_0 + j\alpha_{i_0})_{l\lambda_0 + k\alpha_{i_0}}$ for $0 \leq k \leq m$, where $V(\lambda)$ is an irreducible $U_q(\mathfrak{g}_{I \setminus \{i_0\}})$ -module with highest weight λ ,
- (iii) There exists $i_1 \in I$ such that $\{i \in I \mid \langle h_{i_0}, \alpha_i \rangle < 0\} = \{i_1\}$,
- (iv) $-\langle h_{i_0}, l\lambda_0 - \alpha_{i_1} \rangle \geq 0$.

Then we have

$$V_l \cong \oplus_{j=0}^m V(l\lambda_0 + j\alpha_{i_0}) \text{ as a } U_q(\mathfrak{g}_{I \setminus \{i_0\}})\text{-module,}$$

and V_l admits a crystal pseudobase as a $U'_q(\mathfrak{g})$ -module.

4 Level-one representation and fusion construction

4.1 Construction of the polarization of V^1

The space $V^1 \cong V(\Lambda_1) \oplus V(0)$ is endowed with a $U'_q(G_2^{(1)})$ -module structure as follows.

$$f_0 \overline{6} = \overline{2}, f_0 \overline{4} = \overline{3}, f_0 \overline{3} = \overline{4}, f_0 \overline{2} = \overline{6},$$

$$\begin{aligned}
f_0 \overline{1} &= \overline{\cdot} + \frac{1}{[2]_1} \overline{0_2}, f_0 \overline{\cdot} = [2]_0 \overline{1}, \\
f_1 \overline{1} &= \overline{2}, f_1 \overline{4} = \overline{5}, f_1 \overline{6} = \overline{0_2} + \frac{1}{[2]_2} \overline{0_1} + \frac{1}{[2]_1} \overline{\cdot}, \\
f_1 \overline{0_2} &= [2]_2 \overline{6}, f_1 \overline{5} = \overline{4}, f_1 \overline{2} = \overline{1}, \\
f_2 \overline{2} &= \overline{3}, f_2 \overline{3} = [2]_2 \overline{4}, f_2 \overline{4} = [3]_2 \overline{6}, f_2 \overline{5} = \overline{0_1} + \frac{[3]_2}{[2]_1} \overline{0_2}, \\
f_2 \overline{0_1} &= [2]_2 \overline{5}, f_2 \overline{6} = \overline{4}, f_2 \overline{4} = [2]_2 \overline{3}, f_2 \overline{3} = [3]_2 \overline{2}, \\
e_0 \overline{6} &= \overline{2}, e_0 \overline{4} = \overline{3}, e_0 \overline{3} = \overline{4}, e_0 \overline{2} = \overline{6}, \\
e_0 \overline{1} &= \overline{\cdot} + \frac{1}{[2]_1} \overline{0_2}, e_0 \overline{\cdot} = [2]_0 \overline{1}, \\
e_1 \overline{1} &= \overline{2}, e_1 \overline{4} = \overline{5}, e_1 \overline{6} = \overline{0_2} + \frac{1}{[2]_2} \overline{0_1} + \frac{1}{[2]_1} \overline{\cdot}, \\
e_1 \overline{0_2} &= [2]_2 \overline{6}, e_1 \overline{5} = \overline{4}, e_1 \overline{2} = \overline{1} \\
e_2 \overline{2} &= \overline{3}, e_2 \overline{3} = [2]_2 \overline{4}, e_2 \overline{4} = [3]_2 \overline{6}, e_2 \overline{5} = \overline{0_1} + \frac{[3]_2}{[2]_1} \overline{0_2}, \\
e_2 \overline{0_1} &= [2]_2 \overline{5}, e_2 \overline{6} = \overline{4}, e_2 \overline{4} = [2]_2 \overline{3}, e_2 \overline{3} = [3]_2 \overline{2}, \\
q^{h_0} &= q^{-2h_1 - h_2},
\end{aligned}$$

where $\overline{\cdot}$ is the base of $V(0)$.

We put

$$B^1 = \{\overline{i}, \overline{0_1}, \overline{0_2}, \overline{\bar{i}}, \overline{\cdot} \mid i = 1, \dots, 6\}.$$

Let $(\cdot, \cdot)_1$ be the polarization on the $U_q(G_2)$ -module $V(\Lambda_1)$. We shall define a symmetric bilinear form (\cdot, \cdot) on V^1 by

$$\begin{aligned}
(\overline{\cdot}, u) &= (u, \overline{\cdot}) = 0 \quad u \in V(\Lambda_1), \\
(\overline{\cdot}, \overline{\cdot}) &= q_0 [2]_0 (\overline{1}, \overline{1})_1, \\
(u, v) &= (u, v)_1 \quad u, v \in V(\Lambda_1).
\end{aligned}$$

By Lemma 3.20, we have

$$(\overline{a_1}, \overline{a_1}) = q_2^{-2} [3]_2^{-1} (\overline{a_2}, \overline{a_2}) = q_2^{-3} [3]_2^{-1} [2]_2^{-1} (\overline{0_1}, \overline{0_1}) = q_1^{-1} [2]_1^{-1} (\overline{0_2}, \overline{0_2}),$$

where $a_1 = 1, 2, 6, \overline{6}, \overline{2}, \overline{1}$, $a_2 = 3, 4, 5, \overline{5}, \overline{4}, \overline{3}$. It follows that (\cdot, \cdot) is a polarization on the $U'_q(G_2^{(1)})$ -module V^1 .

Therefore we see that B^1 is a crystal base and Kashiwara operators act as follows.

$$\begin{aligned}
\tilde{f}_0 \overline{6} &= \overline{2}, \tilde{f}_0 \overline{4} = \overline{3}, \tilde{f}_0 \overline{3} = \overline{4}, \tilde{f}_0 \overline{2} = \overline{6}, \tilde{f}_0 \overline{1} = \overline{\cdot}, \tilde{f}_0 \overline{\cdot} = [2]_0 \overline{1}, \\
\tilde{f}_1 \overline{1} &= \overline{2}, \tilde{f}_1 \overline{4} = \overline{5}, \tilde{f}_1 \overline{6} = \overline{0_2}, \tilde{f}_1 \overline{0_2} = [2]_2 \overline{6}, \tilde{f}_1 \overline{5} = \overline{4}, \tilde{f}_1 \overline{2} = \overline{1}, \\
\tilde{f}_2 \overline{2} &= \overline{3}, \tilde{f}_2 \overline{3} = [2]_2 \overline{4}, \tilde{f}_2 \overline{4} = [3]_2 \overline{6}, \tilde{f}_2 \overline{5} = \overline{0_1}, \tilde{f}_2 \overline{0_1} = [2]_2 \overline{5}, \tilde{f}_2 \overline{6} = \overline{4}, \\
\tilde{f}_2 \overline{4} &= [2]_2 \overline{3}, \tilde{f}_2 \overline{3} = [3]_2 \overline{2}, \\
\tilde{e}_0 \overline{6} &= \overline{2}, \tilde{e}_0 \overline{4} = \overline{3}, \tilde{e}_0 \overline{3} = \overline{4}, \tilde{e}_0 \overline{2} = \overline{6}, \tilde{e}_0 \overline{1} = \overline{\cdot}, \tilde{e}_0 \overline{\cdot} = [2]_2 \overline{1}, \\
\tilde{e}_1 \overline{1} &= \overline{2}, \tilde{e}_1 \overline{4} = \overline{5}, \tilde{e}_1 \overline{6} = \overline{0_2}, \tilde{e}_1 \overline{0_2} = [2]_2 \overline{6}, \tilde{e}_1 \overline{5} = \overline{4}, \tilde{e}_1 \overline{2} = \overline{1} \\
\tilde{e}_2 \overline{2} &= \overline{3}, \tilde{e}_2 \overline{3} = [2]_2 \overline{4}, \tilde{e}_2 \overline{4} = [3]_2 \overline{6}, \tilde{e}_2 \overline{5} = \overline{0_1}, \tilde{e}_2 \overline{0_1} = [2]_2 \overline{5}, \tilde{e}_2 \overline{6} = \overline{4}, \\
\tilde{e}_2 \overline{4} &= [2]_2 \overline{3}, \tilde{e}_2 \overline{3} = [3]_2 \overline{2},
\end{aligned}$$

By checking of conditions of Definition 3.16, we have following proposition.

Proposition 4.1 B^1 is a perfect crystal of level 1.

4.2 Decomposition of the tensor product

The tensor product $V^1 \otimes V^1$ is decomposed in the following way:

$$\begin{aligned} (V(\Lambda_1) \oplus V(0)) \otimes (V(\Lambda_1) \oplus V(0)) \\ \cong V(2\Lambda_1) \oplus V(3\Lambda_2) \oplus V(2\Lambda_2) \oplus V(\Lambda_1)^{\oplus 3} \oplus V(0)^{\oplus 2}. \end{aligned} \quad (4.2.1)$$

Lemma 4.2 Following vectors $u_{2\Lambda_1}$, $u_{3\Lambda_2}$, $u_{2\Lambda_2}$, $u_{\Lambda_1}^1$, $u_{\Lambda_1}^2$, $u_{\Lambda_1}^3$, u_0^1 and u_0^2 are the highest weight vectors with the weights $2\Lambda_1$, $3\Lambda_2$, $2\Lambda_2$, Λ_1 , Λ_1 , Λ_1 , 0 and 0 respectively.

$$\begin{aligned} u_{2\Lambda_1} &= \boxed{1} \otimes \boxed{1}, \\ u_{3\Lambda_2} &= \boxed{1} \otimes \boxed{2} - q^3 \boxed{2} \otimes \boxed{1}, \\ u_{2\Lambda_2} &= \boxed{1} \otimes \boxed{5} - q^3 \boxed{2} \otimes \boxed{4} + \frac{[2]_2}{[3]_2} q^4 \boxed{3} \otimes \boxed{3} - q^7 \boxed{4} \otimes \boxed{2} + q^{10} \boxed{5} \otimes \boxed{1}, \\ u_{\Lambda_1}^1 &= \boxed{1} \otimes \boxed{\cdot}, \\ u_{\Lambda_1}^2 &= \boxed{\cdot} \otimes \boxed{1}, \\ u_{\Lambda_1}^3 &= \boxed{1} \otimes \boxed{0_2} - [2]_1 q^6 \boxed{2} \otimes \boxed{6} + \frac{[2]_1}{[3]_2} q^5 \boxed{3} \otimes \boxed{4} - \frac{[2]_1}{[3]_2} q^6 \boxed{4} \otimes \boxed{3} \\ &\quad + [2]_1 q^9 \boxed{6} \otimes \boxed{2} - q^{12} \boxed{0_2} \otimes \boxed{1}, \\ u_0^1 &= \boxed{\cdot} \otimes \boxed{\cdot}, \\ u_0^2 &= \boxed{1} \otimes \boxed{\bar{1}} - q^3 \boxed{2} \otimes \boxed{\bar{2}} + \frac{1}{[3]_2} q^2 \boxed{3} \otimes \boxed{\bar{3}} - \frac{1}{[3]_2} q^3 \boxed{4} \otimes \boxed{\bar{4}} \\ &\quad + \frac{1}{[3]_2} q^6 \boxed{5} \otimes \boxed{\bar{5}} + q^6 \boxed{6} \otimes \boxed{\bar{6}} - \frac{q^6}{[2]_2 [3]_2} \boxed{0_1} \otimes \boxed{0_1} - \frac{q^6}{[2]_1} \boxed{0_2} \otimes \boxed{0_2} \\ &\quad + \frac{q^8}{[3]_2} \boxed{\bar{5}} \otimes \boxed{5} + q^{12} \boxed{\bar{6}} \otimes \boxed{6} - \frac{q^{11}}{[3]_2} \boxed{\bar{4}} \otimes \boxed{4} + \frac{q^{12}}{[3]_2} \boxed{\bar{3}} \otimes \boxed{3} \\ &\quad - q^{15} \boxed{\bar{2}} \otimes \boxed{2} + q^{18} \boxed{\bar{1}} \otimes \boxed{1} - \frac{q^6}{[2]_1 [2]_3} \boxed{0_1} \otimes \boxed{0_2} - \frac{q^6}{[2]_1 [2]_3} \boxed{0_2} \otimes \boxed{0_1} \\ &\quad - \frac{q^6}{[2]_2^2} \boxed{0_2} \otimes \boxed{\cdot} - \frac{q^6}{[2]_2^2} \boxed{\cdot} \otimes \boxed{0_2}. \end{aligned}$$

4.3 Calculation of the R -matrix

Let V_x^1 be $U_q(\mathfrak{g})$ -module $\mathbf{Q}[x, x^{-1}] \otimes V^1$ with the actions of e_i , f_i , and t_i given by $x^{\delta_{i0}} e_i$, $x^{-\delta_{i0}} f_i$, and t_i , respectively. The R -matrix for V^1 is an invertible $\mathbf{Q}[x, x^{-1}, y, y^{-1}] \otimes U_q(G_2)$ -linear map

$$R(x, y) : V_x \otimes V_y \rightarrow V_y \otimes V_x$$

satisfying following properties.

- (1) $R(x, y) \in \mathbf{Q}(q)[x/y, y/x] \otimes \text{End}_{\mathbf{Q}(q)}(V^1 \otimes V^1)$.
- (2) $(R(y, z) \otimes 1)(1 \otimes R(x, z))(R(x, y) \otimes 1) = (1 \otimes R(x, y))(R(x, z) \otimes 1)(1 \otimes R(y, z))$.
- (3) $R(x, y)R(y, x) \in \mathbf{Q}(q)[x/y, y/x]$.

By the decomposition 4.2.1, $U_q(G_2)$ -linearity and $R = R(x, y)$, we have

$$\begin{aligned} R(u_{2\Lambda_1}) &= a^{2\Lambda_1} u_{2\Lambda_1}, R(u_{3\Lambda_2}) = a^{3\Lambda_2} u_{3\Lambda_2}, R(u_{2\Lambda_2}) = a^{2\Lambda_2} u_{2\Lambda_2}, \\ R(u_{\Lambda_1}^i) &= \sum_{j=1}^3 a_{ij}^{\Lambda_1} u_{\Lambda_1}^j \quad (i = 1, 2, 3), R(u_0^i) = \sum_{j=1}^2 a_{ij}^0 u_0^j \quad (i = 1, 2). \end{aligned} \quad (4.3.1)$$

Consider the highest weight vectors given in Lemma 4.2. Then we have in $V_x^1 \otimes V_y^1$:

1. $f_0^{(2)} f_1 f_2^{(3)} f_1 u_{\Lambda_1}^1 = [2]_1 q^{-3} x^{-1} y^{-1} u_{2\Lambda_1}$,
2. $f_0^{(2)} f_1 f_2^{(3)} f_1 u_{\Lambda_1}^2 = [2]_1 q^{-3} x^{-1} y^{-1} u_{2\Lambda_1}$,
3. $f_0^{(2)} f_1 f_2^{(3)} f_1 u_{\Lambda_1}^3 = [2]_1 (x - q^6 y)(x + q^{12} y) q^{-6} x^{-2} y^{-2} u_{2\Lambda_1}$,
4. $e_1 e_2^{(3)} e_1^{(2)} e_2^{(3)} e_0 e^{(2)} e_2^{(3)} e_1 e_0 u_{\Lambda_1}^1 = [2]_1 y(x + y) u_{2\Lambda_1}$,
5. $e_1 e_2^{(3)} e_1^{(2)} e_2^{(3)} e_0 e^{(2)} e_2^{(3)} e_1 e_0 u_{\Lambda_1}^2 = [2]_1 q^{-6} x(x + y) u_{2\Lambda_1}$,
6. $e_1 e_2^{(3)} e_1^{(2)} e_2^{(3)} e_0 e^{(2)} e_2^{(3)} e_1 e_0 u_{\Lambda_1}^3 = [2]_2 q^5 (q^4 + 1)(x - q^6 y) u_{2\Lambda_1}$,
7. $f_0 u_{\Lambda_1}^1 = [2]_1 q^{-6} y^{-1} u_{2\Lambda_1}$,
8. $f_0 u_{\Lambda_1}^2 = [2]_1 x^{-1} u_{2\Lambda_1}$,
9. $f_0 u_{\Lambda_1}^3 = 0$,
10. $f_0^{(2)} u_0^1 = [2]_1^2 q^{-3} x^{-1} y^{-1} u_{2\Lambda_1}$,
11. $f_0^{(2)} u_0^2 = q^{-12} (x^2 + q^{30} y^2) x^{-2} y^{-2} u_{2\Lambda_1}$,
12. $f_1^{(2)} f_2^{(6)} f_1^{(4)} f_2^{(6)} f_1^{(2)} f_0^{(2)} f_1 f_2^{(2)} f_1 f_2 f_0 f_1 f_2^{(3)} f_1 f_0 u_0^1 = [2]_1^2 (q^4 + q^2 + 1) q^{-8} (q^6 y^2 + x^2) x y u_{2\Lambda_1}$,
13. $f_1^{(2)} f_2^{(6)} f_1^{(4)} f_2^{(6)} f_1^{(2)} f_0^{(2)} f_1 f_2^{(2)} f_1 f_2 f_0 f_1 f_2^{(3)} f_1 f_0 u_0^2 = [2]_2 q^{-10} (q^4 + q^2 + 1) ((q^{22} + q^{18}) y^2 + (q^6 + 1)(q^{16} - q^{14} + q^{12} - 2q^{10} + q^8 - 2q^6 + q^4 - q^2 + 1) x y + (q^4 + 1) x^2) x y u_{\Lambda_1}$,
14. $f_0^{(2)} f_1 f_2^{(3)} f_1^{(2)} f_2^{(3)} u_{3\Lambda_2} = q^{-3} (x - q^6 y)(x + y) x^{-2} y^{-2} u_{2\Lambda_1}$,
15. $f_0^{(2)} f_1 f_2^{(3)} f_1^{(2)} u_{2\Lambda_2} = q^{-8} (q^4 + q^2 + 1)(x - q^6 y)(x - q^{10} y) x^{-2} y^{-2} u_{2\Lambda_1}$.

From these equations and the relation $[R, \Delta(X)] = 0$ ($X \in U_q(G_2)$), we obtain $a_{2\Lambda_1}(q^6 y, x, (q^4 + 1)[2]_2 q^4 (x - q^6 y)) = (q^6 x, y, (q^4 + 1)[2]_2 q^4 (y - q^6 x)) {}^t(a_{ij}^{\Lambda_1})$,

$$a_{2\Lambda_1}(x, y, 0) = (y, x, 0) {}^t(a_{ij}^{\Lambda_1}),$$

$$a_{2\Lambda_1}([2]_1^2 q^6, (x^2 + q^{30} y^2) q^{-3} x^{-1} y^{-1}) = ([2]_1^2 q^6, (y^2 + q^{30} x^2) q^{-3} x^{-1} y^{-1}) {}^t(a_{ij}^0),$$

$$a_{2\Lambda_1}(s_1(x, y), s_2(x, y)) = (s_1(y, x), s_2(y, x)) {}^t(a_{ij}^0),$$

$$(x - q^6 y) a_{2\Lambda_1} = a_{3\Lambda_2}(y - q^6 x),$$

$$(x - q^6 y)(x - q^{10} y) a_{2\Lambda_1} = a_{2\Lambda_2}(y - q^6 x)(y - q^{10} x),$$

where

$$s_1(x, y) = [2]_1 (q^4 - a^2 + 1)(x^2 + q^6 y^2)$$

$$s_2(x, y) = (q^{22} + q^{18}) y^2 + (q^6 + 1)(q^{16} - q^{14} + q^{12} - 2q^{10} + q^8 - 2q^6 + q^4 - q^2 + 1) x y + (q^4 + 1) x^2.$$

Let $P_{2\Lambda_1}$, $P_{3\Lambda_2}$, $P_{2\Lambda_2}$, $P_{u_{\Lambda_1}^i}$ ($i = 1, 2, 3$) and $P_{u_0^i}$ ($i = 1, 2$) be the projection from $V^1 \otimes V^1$ to $V(2\Lambda_1)$, $V(3\Lambda_2)$, $V(2\Lambda_2)$, $U_q(G_2) u_{\Lambda_1}^i$ ($i = 1, 2, 3$) and $U_q(G_2) u_0^i$ ($i = 1, 2$) respectively.

Proposition 4.3 Put $z = xy^{-1}$. Since the R -matrix $R(x, y)$ depends only on x/y , we denote $R(z) = R(x, y)$. Then we have

$$\begin{aligned} R(z)(u_{2\Lambda_1}) &= (1 - q^{12} z)(1 - q^{10} z)(1 - q^8 z)(1 - q^6 z) u_{2\Lambda_1}, \\ R(z)(u_{3\Lambda_2}) &= (1 - q^{12} z)(1 - q^{10} z)(1 - q^8 z)(z - q^6) u_{3\Lambda_2}, \\ R(z)(u_{2\Lambda_2}) &= (1 - q^{12} z)(z - q^{10})(1 - q^8 z)(z - q^6) u_{2\Lambda_2}, \end{aligned}$$

$$R(u_{\Lambda_1}^i) = \sum_{j=1}^3 a_{ij}^{\Lambda_1} u_{\Lambda_1}^j \quad (i = 1, 2, 3),$$

$$R(u_0^i) = \sum_{j=1}^2 a_{ij}^0 u_0^j \quad (i = 1, 2).$$

Here $(a_{ij}^{\Lambda_1})$ and (a_{ij}^0) are given by

$$\begin{aligned} a_{11}^{\Lambda_1} &= (1 - q^{12}z)(q^6 - 1)(q^2 + 1)z(-q^{16} - q^{14} + q^{12} - q^{10} - q^6)z - (q^4 - q^2 + 1), \\ a_{12}^{\Lambda_1} &= (1 - q^{12}z)q^6(1 - z)(q^{12}z^2 + (q^{12} - q^6 - q^4 - q^2)z + 1), \\ a_{13}^{\Lambda_1} &= (1 - q^{12}z)q^3(q^6 - 1)z(z - 1), \\ a_{21}^{\Lambda_1} &= (1 - q^{12}z)q^6(1 - z)(q^{12}z^2 - (q^{10} + q^8 + q^6 - 1)z + 1), \\ a_{22}^{\Lambda_1} &= (1 - q^{12}z)(q^6 - 1)(q^2 + 1)z((-q^{16} + q^{14} - q^{12})z + (q^{10} + q^6 - q^4 + q^2 - 1)), \\ a_{23}^{\Lambda_1} &= (1 - q^{12}z)q^3(q^6 - 1)(z - 1)z, \\ a_{31}^{\Lambda_1} &= (1 - q^{12}z)q^9(q^{12} - 1)(q^4 + 1)(q^2 + 1)z(1 - z)(z - q^6), \\ a_{32}^{\Lambda_1} &= (1 - q^{12}z)q^3(q^{12} - 1)(q^4 + 1)(q^2 + 1)(1 - z)(q^6 - z), \\ a_{33}^{\Lambda_1} &= (1 - q^{12}z)(z - q^6)(q^6z^2 + (q^{18} - q^{12} - q^{10} - q^8 - q^6 + 1)z + q^{12}), \\ a_{11}^0 &= q^{30}z^4 - q^{24}(q^4 + 1)(q^2 + 1)z^3 + (q^{36} - q^{30} + q^{22} + q^{20} + 2q^{18} + q^{16} + q^{14} - q^6 + 1)z^2 - q^6(q^4 + 1)(q^2 + 1)z + q^6, \\ a_{12}^0 &= -q^3(q^{12} - 1)(q^6 + 1)(1 - z)(1 + z)z, \\ a_{21}^0 &= -q^3 \frac{q^6 - 1}{q^4 - q^2 + 1} (1 - z)(1 + z)((q^{22} + q^{18}) + (q^{40} - q^{38} + q^{36} - q^{34} - q^{30} - q^{26} - q^{20} - q^{14} - q^{10} - q^6 + q^4 - q^2 + 1)z + (q^{22} + q^{18})z^2), \\ a_{22}^0 &= q^{30} - q^{24}(q^4 + 1)(q^2 + 1)z + (q^{36} - q^{30} + q^{22} + q^{20} + 2q^{18} + q^{16} + q^{14} - q^6 + 1)z^2 - q^6(q^4 + 1)(q^2 + 1)z^3 + q^6z^4. \end{aligned}$$

4.4 Fusion construction

Let l be a positive integer and \mathfrak{S}_l the symmetric group of order l . Let s_i be the simple reflection (the permutation of i and $i + 1$). Let $l(w)$ be the length of $w \in \mathfrak{S}_l$. Then for any $w \in \mathfrak{S}_l$, we can define $R_w(x_1, \dots, x_l) : V_{x_1} \otimes \dots \otimes V_{x_l} \rightarrow V_{x_{w(1)}} \otimes \dots \otimes V_{x_{w(l)}}$ as follows:

$$R_1(x_1, \dots, x_l) = 1.$$

$$R_{s_i}(x_1, \dots, x_l) = \left(\otimes_{j < i} \text{id}_{V_{x_j}} \right) \otimes R(x_i, x_{i+1}) \otimes \left(\otimes_{j > i+1} \text{id}_{V_{x_j}} \right).$$

For w, w' with $l(ww') = l(w) + l(w')$,

$$R_{ww'}(x_1, \dots, x_l) = R_{w'}(x_{w(1)}, \dots, x_{w(l)}) \circ R_w(x_1, \dots, x_l).$$

Fix $r \in \mathbf{Z}_{>0}$. For each $l \in \mathbf{Z}_{>0}$, we put

$$R_l = R_{w_0} \left(q^{r(l-1)}, q^{r(l-3)}, \dots, q^{-r(l-1)} \right) :$$

$$V_{q^{r(l-1)}} \otimes V_{q^{r(l-3)}} \otimes \dots \otimes V_{q^{-r(l-1)}} \rightarrow V_{q^{-r(l-1)}} \otimes V_{q^{-r(l-3)}} \otimes \dots \otimes V_{q^{r(l-1)}},$$

where $w_0 \in \mathfrak{S}_l$ is the permutation given by $i \mapsto l + 1 - i$. Then R_l is a $U'_q(\mathfrak{g})$ -linear homomorphism. We define

$$V_l = \text{Im} R_l.$$

Hence taking $\Lambda_1 - 2\Lambda_0$ as λ_0 in Definition 3.16. By Proposition 4.3, we have

$$\varphi(z) = (1 - q^{12}z)(1 - q^{10}z)(1 - q^8z)(1 - q^6z).$$

Putting

$$r = 3.$$

We see that

$$\varphi(q^{2kr}) \text{ does not vanish for any } k > 0.$$

By Proposition 4.3, we see

$$\begin{aligned} R(q^{2r})(u_{2\Lambda_1}) &= (1 - q^{18})(1 - q^{16})(1 - q^{14})(1 - q^{12}), \\ R(q^{2r})(u_{\Lambda_1}^1) &= \sum_{j=1}^3 a_{1j}^{\Lambda_1} u_{\Lambda_1}^j, \\ R(q^{2r})(u_0^1) &= \sum_{j=1}^2 a_{1j}^0 u_0^j, \\ R(q^{2r})(u_{2\Lambda_2}) &= 0, \\ R(q^{2r})(u_{\Lambda_1}^1 - u_{\Lambda_1}^2) &= 0, \\ R(q^{2r})(u_{\Lambda_1}^3) &= 0, \\ R(q^{2r})(q^3(q^{12} - q^6 + 1)u_0^1 - (q^6 + 1)u_0^2) &= 0. \end{aligned}$$

Then $N = \ker R(q^{2r})$ contains $u_{3\Lambda_2}$, $u_{2\Lambda_2}$, $u_{\Lambda_1}^1 - u_{\Lambda_1}^2$, $u_{\Lambda_1}^3$ and $q^3(q^{12} - q^6 + 1)u_0^1 - (q^6 + 1)u_0^2$. Therefore by (4.2.1), we have

$$\begin{aligned} N &\cong U_q(G_2)u_{3\Lambda_2} \oplus U_q(G_2)u_{2\Lambda_2} \oplus U_q(G_2)u_{\Lambda_1}^3 \\ &\quad \oplus U_q(G_2)(u_{\Lambda_1}^1 - u_{\Lambda_1}^2) \oplus U_q(G_2)(q^3(q^{12} - q^6 + 1)u_0^1 - (q^6 + 1)u_0^2). \end{aligned}$$

Then we have

$$\begin{aligned} \dim(V^{\otimes 2}/N) &= \dim\left(\bigoplus_{j=0}^2 V(j\Lambda_1)\right) \\ &= \#\left\{\begin{array}{|c|c|} \hline \boxed{b} & \boxed{a} \\ \hline \boxed{a} & \boxed{b} \\ \hline \end{array} \mid \begin{array}{|c|} \hline \boxed{a} \\ \hline \end{array} \in B(2\Lambda_1)\right\} \\ &\quad + \#\left\{\begin{array}{|c|c|} \hline \boxed{a} & \boxed{\cdot} \\ \hline \boxed{a} & \boxed{\cdot} \\ \hline \end{array} \mid \begin{array}{|c|} \hline \boxed{a} \\ \hline \end{array} \in B(\Lambda_1)\right\} + \#\left\{\begin{array}{|c|c|} \hline \boxed{\cdot} & \boxed{\cdot} \\ \hline \end{array}\right\} \end{aligned}$$

where $a, b \in \{1, \dots, 6, 0_1, 0_2, \bar{6}, \dots, \bar{1}\}$.

Hence,

$$\begin{aligned} \dim\left(V^{\otimes l} / \sum V^i \otimes N \otimes V^{\otimes(l-2-i)}\right) &= \#\left\{\begin{array}{|c|c|c|c|c|c|} \hline \boxed{b_n} & \cdots & \boxed{b_1} & \boxed{\cdot} & \cdots & \boxed{\cdot} \\ \hline \end{array} \mid \begin{array}{|c|c|} \hline \boxed{b_i} & \boxed{b_{i+1}} \\ \hline \boxed{\cdot} & \boxed{b_1} \\ \hline \end{array} \in B(2\Lambda_1), \begin{array}{|c|} \hline \boxed{\cdot} \\ \hline \end{array} \in B(\Lambda_1), 0 \leq i < n \leq l\right\} \\ &= \dim\left(\bigoplus_{j=0}^l V(j\Lambda_1)\right). \end{aligned}$$

By (3.3.10) of [9], V_l is the quotient of $V^{\otimes l} / \sum_{i=0}^{l-2} V^{\otimes i} \otimes N \otimes V^{(l-2-i)}$.

Therefore we have,

$$\dim(V_l)_\lambda \leq \sum_{j=0}^l \dim V(j(\Lambda_1 - 2\Lambda_0))_\lambda.$$

We set $i_0 = 0$, then $\langle h_1, \lambda_0 \rangle = 1$, $\langle h_2, \lambda_0 \rangle = 0$, $\{i_1\} = \{1\}$, $\langle h_0, \lambda_0 \rangle = -2$. Therefore applying Proposition 3.21, we obtain the following results.

Proposition 4.4

1. V_l has a crystal pseudobase.
2. $V_l \cong \bigoplus_{j=0}^l (V(j(\Lambda_1 - 2\Lambda_0)))$ as a $U_q(G_2)$ -module.

5 Perfectness of the crystals

The algebra $U_q(G_2^{(1)})$ is $\mathbf{Q}(q)$ -algebra generated by $\{e_i, f_i, t_i, t_i^{-1} \ (i \in I = \{0, 1, 2\})\}$. Let $U_q((G_2^{(1)})_J)$ be a $\mathbf{Q}(q)$ -algebra generated by $\{e_i, f_i, t_i, t_i^{-1} \ (i \in J \subset I)\}$.

The algebras $U_q((G_2^{(1)})_{\{1,2\}})$ and $U_q((G_2^{(1)})_{\{0,1\}})$ are isomorphic to $U_q(G_2)$ and $U_q(A_2)$ respectively. Let $J_0 = \{1, 2\}$ and $J_2 = \{1, 0\}$ be the index set of A_2 and G_2 , respectively. We define $\iota_i : J_i \rightarrow I$ by $\iota_i(j) = j$ ($i = 0, 2$). In order to show that the crystal B^l is perfect, we have to show the following conditions.

- (1) There exists a crystal base of $U_q(G_2)$ isomorphic to $\iota_0^*(B^l)$.
There exists a crystal base of $U_q(A_2)$ isomorphic to $\iota_2^*(B^l)$. Crystal base B^l is connected.
- (2) For any $b \in B^l$, $\langle c, \varphi(b) \rangle \geq l$.
- (3) The maps ε and $\varphi : B^l = \{b \in B^l \mid \langle c, \varepsilon(b) \rangle = l\} \rightarrow (P_{cl}^+)_l = \{\lambda \in \sum \mathbf{Z}_{\geq 0} \Lambda_i \mid \langle c, \lambda \rangle = 1\}$ are bijective.
- (4) Crystal graph of $B^l \otimes B^l$ is connected.

At first we construct crystal B^l which satisfies condition (1) (§5.2, §5.3). Then we prove conditions (2)(3) in §5.4, and (4) in §5.5.

5.1 Preparation

Let $B^{A_2}(\lambda)$ (resp. $B^{G_2}(\lambda)$) be a crystal base of $U_q(A_2)$ (resp. $U_q(G_2)$) with the highest weight λ . We write $\llbracket [b_1] \cdots [b_n] \rrbracket$ instead of Young tableau $\boxed{b_1} \cdots \boxed{b_n}$. We introduce following notations:

$$\begin{aligned}
 \llbracket a \rrbracket^k &= \overbrace{\llbracket a \rrbracket \cdots \llbracket a \rrbracket}^k \quad (a = 1, \dots, 6, 0_1, 0_2, \bar{6}, \dots, \bar{1}), \\
 \llbracket c \rrbracket^k &= \tilde{f}_1^k \llbracket 6 \rrbracket^k = \begin{cases} \llbracket 6 \rrbracket^{\frac{k}{2}} \llbracket \bar{6} \rrbracket^{\frac{k}{2}}, & k \equiv 0 \pmod{2}, \\ \llbracket 6 \rrbracket^{\lfloor \frac{k}{2} \rfloor} \llbracket 0_2 \rrbracket \llbracket \bar{6} \rrbracket^{\lfloor \frac{k}{2} \rfloor}, & k \equiv 1 \pmod{2}, \end{cases} \\
 \llbracket w \rrbracket^k &= \tilde{f}_2^k \llbracket 2 \rrbracket^k = \begin{cases} \llbracket 2 \rrbracket^{\frac{2k}{3}} \llbracket 6 \rrbracket^{\frac{k}{3}} & k \equiv 0 \pmod{3}, \\ \llbracket 2 \rrbracket^{2\lfloor \frac{k}{3} \rfloor} \llbracket 3 \rrbracket \llbracket 6 \rrbracket^{\lfloor \frac{k}{3} \rfloor} & k \equiv 1 \pmod{3}, \\ \llbracket 2 \rrbracket^{2\lfloor \frac{k}{3} \rfloor + 1} \llbracket 4 \rrbracket \llbracket 6 \rrbracket^{\lfloor \frac{k}{3} \rfloor} & k \equiv 2 \pmod{3}, \end{cases} \\
 \llbracket \bar{w} \rrbracket^k &= \tilde{e}_2^k \llbracket \bar{2} \rrbracket^k = \begin{cases} \llbracket \bar{6} \rrbracket^{\frac{k}{3}} \llbracket \bar{2} \rrbracket^{\frac{2k}{3}} & k \equiv 0 \pmod{3}, \\ \llbracket \bar{6} \rrbracket^{\lfloor \frac{k}{3} \rfloor} \llbracket \bar{3} \rrbracket \llbracket \bar{2} \rrbracket^{2\lfloor \frac{k}{3} \rfloor} & k \equiv 1 \pmod{3}, \\ \llbracket \bar{6} \rrbracket^{\lfloor \frac{k}{3} \rfloor} \llbracket \bar{4} \rrbracket \llbracket \bar{2} \rrbracket^{2\lfloor \frac{k}{3} \rfloor + 1} & k \equiv 2 \pmod{3}. \end{cases}
 \end{aligned}$$

Then we easily have

$$\llbracket c \rrbracket^k = \llbracket 6 \rrbracket \llbracket c \rrbracket^{k-2} \llbracket \bar{6} \rrbracket, \quad (5.1.1)$$

$$\llbracket w \rrbracket^k = \llbracket 2 \rrbracket^2 \llbracket w \rrbracket^{k-3} \llbracket 6 \rrbracket, \quad (5.1.2)$$

$$\llbracket \bar{w} \rrbracket^k = \llbracket \bar{6} \rrbracket \llbracket \bar{w} \rrbracket^{k-3} \llbracket \bar{2} \rrbracket^2, \quad (5.1.3)$$

$$\tilde{f}_1[\mathcal{C}]^k = [\mathcal{C}]^{k-1} [\bar{6}], \quad (5.1.4)$$

$$\tilde{e}_2[\mathcal{W}]^k = [2] [\mathcal{W}]^{k-1}, \quad (5.1.5)$$

$$\tilde{e}_2[\overline{\mathcal{W}}]^k = [\bar{6}] [\overline{\mathcal{W}}]^{k-2} [2]. \quad (5.1.6)$$

Proposition 5.1 For $[\mathcal{C}]^k, [\mathcal{W}]^k, [\overline{\mathcal{W}}]^k$ ($k \in \mathbf{Z}_{\geq 0}$), We have

$$\text{Red}_2([\mathcal{C}]^k) = u_0, \quad (5.1.7)$$

$$\text{Red}_1([\mathcal{W}]^k) = u_0, \quad (5.1.8)$$

$$\text{Red}_1([\overline{\mathcal{W}}]^k) = u_0. \quad (5.1.9)$$

Proof We prove (5.1.7). By Definition 3.4 and (3.1.1) we have

$$\Psi_2([\mathcal{C}]^{2k}) = \Psi_2([6]^k [\bar{6}]^k) = u_+^{3k} u_-^{3k},$$

$$\text{Red}_2([\mathcal{C}]^{2k}) = u_0,$$

$$\Psi_2([\mathcal{C}]^{2k+1}) = \Psi_2([6]^k [0_2] [\bar{6}]^k) = u_+^{3k} u_0 u_-^{3k},$$

$$\text{Red}_2([\mathcal{C}]^{2k+1}) = u_0.$$

In a similar way, we can prove (5.1.8), (5.1.9). \square

We use the following notations for $b \in B^{A_2}(m\Lambda_1 + n\Lambda_2)$,

$$\begin{aligned} b &= \begin{array}{|c|c|c|c|c|c|} \hline b_1^{m+n} & \cdots & b_1^{m+1} & b_1^m & \cdots & b_1^1 \\ \hline b_2^{m+n} & \cdots & b_2^{m+1} & & & \\ \hline \end{array} \in B^{A_2}(m\Lambda_1 + n\Lambda_2) \\ &= \left[[b_1^{m+n}, b_2^{m+n}] \cdots [b_1^{m+1}, b_2^{m+1}] [b_1^m] \cdots [b_1^1] \right]. \end{aligned} \quad (5.1.10)$$

The highest weight element is given by

$$\begin{array}{|c|c|c|c|c|c|} \hline 1 & \cdots & 1 & 1 & \cdots & 1 \\ \hline 2 & \cdots & 2 & & & \\ \hline \end{array} = \left[[1, 2]^n [1]^m \right].$$

Proposition 5.2 Fix $l \in \mathbf{Z}_{>0}$. Take i, j, p such that $0 \leq i \leq \lfloor \frac{l}{2} \rfloor$, $i \leq j \leq l - i$, $0 \leq p \leq j$. Let $\bar{b} \in B^{A_2}((i+j)\Lambda_1 + l\Lambda_2)$ be the highest weight element. Let $\underline{b} \in B^{A_2}((i+j)\Lambda_1 + l\Lambda_2)$ be the lowest weight element. Then we have

$$\varepsilon_2(\tilde{f}_1^{l+j} \tilde{f}_2^l \bar{b}) = 0, \quad (5.1.11)$$

$$\varphi_2(\tilde{f}_1^{l+j} \tilde{f}_2^l \bar{b}) = j, \quad (5.1.12)$$

$$\tilde{f}_2^p \tilde{f}_1^{l+j} \tilde{f}_2^l \bar{b} = \tilde{f}_1^{l+j-p} \tilde{f}_2^{l+p} \tilde{f}_1^p \bar{b}, \quad (5.1.13)$$

$$\tilde{f}_1^{l+j-p} \tilde{f}_2^{l+p} \tilde{f}_1^p \bar{b} = \tilde{e}_1^i \tilde{e}_2^{l-p} \underline{b}. \quad (5.1.14)$$

Proof By Proposition 3.13, we have

$$\bar{b} = \left[\left[\left[1, 2 \right]^l \left[1 \right]^{i+j} \right] \right],$$

$$\underline{b} = \left[\left[\left[2, 3 \right]^l \left[3 \right]^{i+j} \right] \right].$$

We prove (5.1.11), (5.1.12). Using Proposition 3.9, we have

$$\begin{aligned} \Psi_2(\bar{b}) &= u_0^{i+j} (u_0 u_+)^l, \\ \text{Red}_2(\bar{b}) &= u_+^l. \end{aligned}$$

Then we have

$$\tilde{f}_2^l \bar{b} = \left[\left[\left[1, 3 \right]^l \left[1 \right]^{i+j} \right] \right].$$

Similarly, we have

$$\tilde{f}_1^{l+j} \tilde{f}_2^l \bar{b} = \left[\left[\left[1, 3 \right]^i \left[2, 3 \right]^{l-i} \left[2 \right]^{i+j} \right] \right].$$

Using Proposition 3.9, we have

$$\begin{aligned} \Psi_2 \left(\left[\left[\left[1, 3 \right]^i \left[2, 3 \right]^{l-i} \left[2 \right]^{i+j} \right] \right] \right) &= u_+^{i+j} (u_+ u_-)^{l-i} (u_0 u_-)^i, \\ \text{Red}_2 \left(\left[\left[\left[1, 3 \right]^i \left[2, 3 \right]^{l-i} \left[2 \right]^{i+j} \right] \right] \right) &= u_+^j. \end{aligned}$$

Therefore, we have

$$\begin{aligned} \varepsilon_2 \left(\left[\left[\left[1, 3 \right]^i \left[2, 3 \right]^{l-i} \left[2 \right]^{i+j} \right] \right] \right) &= 0, \\ \varphi_2 \left(\left[\left[\left[1, 3 \right]^i \left[2, 3 \right]^{l-i} \left[2 \right]^{i+j} \right] \right] \right) &= j. \end{aligned}$$

Relations (5.1.13), (5.1.14) can be proved by using

$$\tilde{f}_1^{l+j-p} \tilde{f}_2^{l+p} \tilde{f}_1^p \bar{b} = \left[\left[\left[1, 3 \right]^i \left[2, 3 \right]^{l-i} \left[2 \right]^{i+j-p} \left[3 \right]^p \right] \right].$$

□

Proposition 5.3 Let \bar{b} be the highest weight element of the crystal base $B^{A_2}(k\Lambda_1 + j\Lambda_2)$ of $U_q(A_2)$. Then for $0 \leq q < p \leq j$ we have,

$$\tilde{f}_1 \tilde{f}_2 \left(\tilde{f}_1^q \tilde{f}_2^p \bar{b} \right) = \tilde{f}_2 \tilde{f}_1 \left(\tilde{f}_1^q \tilde{f}_2^p \bar{b} \right).$$

Proof By (5.1.10), we have

$$\bar{b} = \left[\left[\left[1, 2 \right]^j \left[1 \right]^k \right] \right].$$

Using Proposition 3.9, we have

$$\begin{aligned} \Psi_2(\bar{b}) &= u_0^k (u_0 u_+)^j, \\ \text{Red}_2(\bar{b}) &= u_+^j. \end{aligned}$$

Therefore we have

$$\tilde{f}_2^p \bar{b} = \left[\left[\left[1, 2 \right]^{j-p} \left[1, 3 \right]^p \left[1 \right]^k \right] \right].$$

Using Proposition 3.9 again, we have

$$\Psi_1 \left(\tilde{f}_2^p \bar{b} \right) = u_+^k (u_+ u_-)^p (u_+ u_-)^{j-p}.$$

Thus we have

$$\tilde{f}_1^q \tilde{f}_2^p \bar{b} = \begin{cases} \llbracket [1, 2]^{j-p} [1, 3]^p [1]^{k-q} [2]^q \rrbracket & (k > q), \\ \llbracket [1, 2]^{j-p} [1, 3]^{p-q+k} [2, 3]^{q-k} [2]^k \rrbracket & (k \leq q). \end{cases}$$

In a similar way we have,

$$\tilde{f}_2 \tilde{f}_1 \left(\tilde{f}_1^q \tilde{f}_2^p \bar{b} \right) = \tilde{f}_1 \tilde{f}_2 \left(\tilde{f}_1^q \tilde{f}_2^p \bar{b} \right) = \begin{cases} \llbracket [1, 2]^{j-p} [1, 3]^p [1]^{k-q-1} [2]^q [3] \rrbracket & (k \geq q), \\ \llbracket [1, 2]^{j-p} [1, 3]^{p-q+k-1} [2, 3]^{q-k+1} [2]^{k-1} [3] \rrbracket & (k < q). \end{cases}$$

In a similar way, we have the following Proposition.

Proposition 5.4 *Let \bar{b} be the highest weight element of $B^{A_2}(k\Lambda_1 + j\Lambda_2)$. For $0 \leq p \leq j$, $0 \leq s \leq k$, we have*

$$\tilde{e}_1 \tilde{f}_2^s \tilde{f}_1^{p+s+1} \tilde{f}_2^p \bar{b} = \tilde{f}_2 \tilde{f}_1^{p+s} \tilde{f}_2^p \bar{b} \neq \tilde{f}_2^{s+1} \tilde{f}_1^{p+s} \tilde{f}_2^{p-1} \bar{b}, \quad (5.1.15)$$

$$\tilde{e}_1 \tilde{f}_2^{s+1} \tilde{f}_1^{p+s+1} \tilde{f}_2^p \bar{b} = \tilde{f}_2^{s+2} \tilde{f}_1^{p+s} \tilde{f}_2^{p-1} \bar{b} \neq \tilde{f}_2^{s+1} \tilde{f}_1^{p+s} \tilde{f}_2^p \bar{b}. \quad (5.1.16)$$

Proposition 5.5 *Let \bar{b} be the highest weight element of crystal base $B^{A_2}(k\Lambda_1 + j\Lambda_2)$. For an element $\tilde{f}_1^q \tilde{f}_2^p \bar{b}$ ($p \leq q \leq p+k$), we have*

$$\varphi_2 \left(\tilde{f}_1^q \tilde{f}_2^p \bar{b} \right) = j + q - 2p. \quad (5.1.17)$$

Proof Using Proposition 3.9 we have,

$$\text{Red}_2 \left(\tilde{f}_1^q \tilde{f}_2^p \bar{b} \right) = u_+^{j+p-2q}.$$

Proposition 5.6 For $b \in B^{G_2}(l\Lambda)$ such that $\tilde{f}_2 b \neq 0$, there exists unique $k' \in \{0, \dots, \varphi_2(b) - 1\}$ such that

$$\varphi_1(\tilde{f}_2^{(k+1)}(b)) = \begin{cases} \varphi_1(\tilde{f}_2^{(k)}(b)) & k \leq k', \\ \varphi_1(\tilde{f}_2^{(k)}(b)) + 1 & k > k'. \end{cases}$$

where $k = 0, \dots, \varphi_2(b) - 1$.

Proof Put $b = b_1 \otimes \dots \otimes b_l$, and $r_1 r_2 \dots r_{\varepsilon_1(b) + \varphi_1(b)} = \text{Red}_{\mathfrak{sl}}(b)$. Let k_1 be $r_{\varepsilon_1(b)}$ if $\varepsilon_1(b) \neq 0$, 0 if $\varepsilon_1(b) = 0$. By Proposition 3.3, there exists integers $k_2 \in \mathbf{Z}_{\geq 0}$ such that

$$\tilde{f}_2 b = b_1 \otimes \dots \otimes \tilde{f}_2 b_{k_2} \otimes \dots \otimes b_l.$$

First we consider $\Psi_1(\tilde{f}_2 b_{k_2})$, using u_+ , u_- in Definition 3.4.

$$\text{if } b_{k_2} = \llbracket 2 \rrbracket, \llbracket 5 \rrbracket, \llbracket \bar{6} \rrbracket, \llbracket \bar{4} \rrbracket, \text{ then } \Psi_1(b_{k_2}) = u_-^n, \Psi_1(\tilde{f}_2 b_{k_2}) = u_-^{n-1} \quad (n = 1, 2). \quad (5.1.18)$$

$$\text{if } b_{k_2} = \llbracket 3 \rrbracket, \llbracket 4 \rrbracket, \llbracket 0_1 \rrbracket, \llbracket \bar{3} \rrbracket, \text{ then } \Psi_1(b_{k_2}) = u_+^{n'}, \Psi_1(\tilde{f}_2 b_{k_2}) = u_+^{n'+1} \quad (n = 0, 1). \quad (5.1.19)$$

We consider $\Psi_1(\tilde{f}_2 b)$. By Remark 3.10, we have $\text{Red}_1(b) = u_-^{\varepsilon_1(b)} u_+^{\varphi_1(b)}$.

The case of $1 \leq k_2 \leq k_1$.

If (5.1.18), we see that

$$\text{Red}_1(\tilde{f}_2 b) = u_-^{\varepsilon_1(b)-1} u_+^{\varphi_1(b)}. \quad (5.1.20)$$

If (5.1.19), we see that the increased u_+ is paired with a neighboring u_- and reduced. Then we have (5.1.20).

The case of $k_1 + 1 \leq k_2 \leq l$.

If (5.1.18), the decreased u_- is paired with u_+ in $\Psi_1(b)$. Then we see

$$\text{Red}_1(\tilde{f}_2 b) = u_-^{\varepsilon_1(b)} u_+^{\varphi_1(b)+1}. \quad (5.1.21)$$

If (5.1.19), we see (5.1.21).

Therefore, we have $\varphi_1(\tilde{f}_2 b)$ equals $\varphi_1(b)$ or $\varphi_1(b) + 1$.

Put $\tilde{f}_2 b = b' = b'_1 \otimes \cdots \otimes b'_l$. If $\tilde{f}_2 b' \neq 0$, we have

$$\tilde{f}_2 b' = b'_1 \otimes \cdots \otimes \tilde{f}_2 b'_{k'_2} \otimes \cdots \otimes b'_l,$$

where $k'_2 \in \mathbf{Z}_{\geq 0}$. Here the action of \tilde{f}_2 is given by changing the leftmost u_+ to u_- in $\text{Red}_2(b)$ and $\text{Red}_2(b') = u_-^{\varepsilon_1(b')} u_+^{\varphi_1(b')}$. Then we see that $k'_2 \geq k_2$.

Thus we have the proposition.

5.2 Construction of crystal base B^l of $U_q(G_2^{(1)})$

5.2.1 Structure of B^l

As we noted earlier, $U_q((G_2^{(1)})_{\{1,2\}})$ is isomorphic to $U_q(G_2)$ and $U_q((G_2^{(1)})_{\{1,0\}})$ is isomorphic to $U_q(A_2)$. Since the structure of $U_q(A_2)$ is simpler than that of $U_q(G_2)$, we define the actions of \tilde{f}_0 on $U_q(G_2)$ by exploiting operators on $U_q(A_2)$. In view of isomorphism between $U_q((G_2^{(1)})_{\{1,0\}})$ and $U_q(A_2)$, we write $\{1,0\}$ as index set of roots of $U_q(A_2)$. The affine crystal B^l for $U_q(G_2^{(1)})$ is constructed on \mathcal{G}^l with $\tilde{f}_0^{\mathcal{G}}$.

Definition 5.7 Fix $l \in \mathbf{Z}_{>0}$. We define crystal base \mathcal{G}^l of $U_q(G_2)$ and crystal base \mathcal{A} of $U_q(A_2)$ as follows.

$$\begin{aligned} \mathcal{G}^l &= \bigoplus_{n=0}^l B^{G_2}(n\Lambda_1), \\ \mathcal{A}_i &= \bigoplus_{i \leq j_1, j_0 \leq l-i} B^{A_2}, (j_1\Lambda_1 + j_0\Lambda_0) \\ \mathcal{A} &= \bigoplus_{i=0}^{\lfloor \frac{l}{2} \rfloor} \mathcal{A}_i. \end{aligned}$$

We denote $\tilde{f}_i, \tilde{e}_i, \varphi_i, \varepsilon_i, \text{wt}, \text{wt}_i$ ($i = 1, 0$) on \mathcal{A} by $\tilde{f}_i^{\mathcal{A}}, \tilde{e}_i^{\mathcal{A}}, \varphi_i^{\mathcal{A}}, \varepsilon_i^{\mathcal{A}}, \text{wt}^{\mathcal{A}}, \text{wt}_i^{\mathcal{A}}$ respectively. In a similar way, we denote $\tilde{f}_i, \tilde{e}_i, \varphi_i, \varepsilon_i, \text{wt}, \text{wt}_i$ ($i = 1, 2$) on \mathcal{G} by $\tilde{f}_i^{\mathcal{G}}, \tilde{e}_i^{\mathcal{G}}, \varphi_i^{\mathcal{G}}, \varepsilon_i^{\mathcal{G}}, \text{wt}^{\mathcal{G}}, \text{wt}_i^{\mathcal{G}}$ respectively.

Proposition 5.8

$$\sharp \mathcal{G}^l = \sharp \mathcal{A}$$

Proof The proposition amounts to show

$$\sum_{n=0}^l \sharp B^{G_2}(n\Lambda_1) = \sum_{i=0}^{\lfloor \frac{l}{2} \rfloor} \sum_{i \leq j_1, j_2 \leq l-i} \sharp B^{A_2}(j_1\Lambda_1 + j_2\Lambda_2). \quad (5.2.1)$$

Let Δ^+ be the set of positive roots, put $\delta = \frac{1}{2} \sum_{\beta \in \Delta^+} \beta$, and let $d(\Lambda)$ be the dimension of finite dimensional irreducible representation with highest weight Λ . Then we have

$$d(\Lambda) = \prod_{\beta \in \Delta^+} \frac{(\Lambda + \delta, \beta)}{(\delta, \beta)}$$

by [13]. Therefore, we have

$$\sharp B^{G_2}(n\Lambda_1) = (n+1) \binom{\frac{1}{2}n+1}{2} \binom{\frac{2}{3}n+1}{3} \binom{\frac{3}{4}n+1}{4} \binom{\frac{3}{5}n+1}{5},$$

$$\#B^{A_2}(n_1\Lambda_1 + n_2\Lambda_2) = \frac{1}{2}(n_1 + 1)(n_2 + 1)(n_1 + n_2 + 2).$$

By calculation, we see that

$$\#B^{G_2}(l\Lambda_1) = \sum_{i=0}^{\lfloor \frac{l}{2} \rfloor} \left(\sum_{k=i}^{l-i-1} \#B^{A_2}(k\Lambda_1 + (l-i)\Lambda_2) + \sum_{j=i}^{l-i} \#B^{A_2}((l-i)\Lambda_1 + j\Lambda_0) \right). \quad (5.2.2)$$

Thus, we have (5.2.1). \square

By Proposition 5.8, we can construct one-to-one correspondence between \mathcal{G}^l and \mathcal{A} as sets.

Let $\bar{b}_{(j_1, j_0)}^{l, i} \in \mathcal{A}_i$ be the highest weight element with weight $j_1\Lambda_1 + j_0\Lambda_0$. Let $\underline{b}_{(-j_1, -j_0)}^{l, i} \in \mathcal{A}_i$ be the lowest weight element with weight $-j_1\Lambda_1 - j_0\Lambda_0$. Elements $\bar{b}_{(j_1, j_0)}^{l, i}$ and $\underline{b}_{(-j_0, -j_1)}^{l, i}$ satisfy

$$\bar{b}_{(j_1, j_0)}^{l, i} = (\tilde{e}_0^A)^{j_0} (\tilde{e}_1^A)^{j_1 + j_0} (\tilde{e}_0^A)^{j_1} \underline{b}_{(-j_0, -j_1)}^{l, i}.$$

For a Lie algebra of type A_2 , it is known that all elements b in the crystal base $B^{A_2}(j_i\Lambda_1 + j_0\Lambda_0)$ are uniquely expressed as

$$b = \left(\tilde{f}_0^A\right)^r \left(\tilde{f}_1^A\right)^q \left(\tilde{f}_0^A\right)^p \bar{b}_{(j_1, j_0)}^{l, i} \quad (0 \leq p \leq j_0, p \leq q \leq p + j_1, 0 \leq r \leq j_0 + q - 2p), \quad (5.2.3)$$

It is possible that there exists crystal bases with same highest weight in \mathcal{A}_i and $\mathcal{A}_{i'}$ ($i \neq i'$). To distinguish them, we define crystal base $B_{(j_1, j_0)}^i \subset \mathcal{A}_i$ by

$$B_{(j_1, j_0)}^i = \left\{ \left(\tilde{f}_0^A\right)^r \left(\tilde{f}_1^A\right)^q \left(\tilde{f}_0^A\right)^p \bar{b}_{(j_1, j_0)}^{l, i} \mid 0 \leq p \leq j_0, p \leq q \leq p + j_1, 0 \leq r \leq j_0 + q - 2p \right\}. \quad (5.2.4)$$

By calculation, we have the following proposition.

Proposition 5.9 For $B_{(k, j)}^i$ ($i < k, j \leq l - i$), we have

$$B_{(k, j)}^i \setminus \left(\left\{ \left(\tilde{f}_1^A\right)^q \left(\tilde{f}_0^A\right)^p \bar{b}_{(k, j)}^{l, i} \mid \begin{matrix} i < k, j \leq l - i \\ 0 \leq p \leq j, 0 \leq q \leq p + k \end{matrix} \right\} \sqcup \left\{ (\tilde{e}_1^A)^q (\tilde{e}_0^A)^p \underline{b}_{(-j, -k)}^{l, i} \mid \begin{matrix} i < k, j \leq l - i \\ 0 \leq p \leq j, 0 \leq q \leq p + k \end{matrix} \right\} \right) \\ \cong B^{A_2}((k-1)\Lambda_1 + (j-1)\Lambda_0). \quad (5.2.5)$$

For $l \in \mathbf{Z}_{>0}$, we define

$$\begin{aligned} \mathcal{A}_i^{(l)} &= \left(\bigsqcup_{i \leq k \leq l-i} B_{(k, i)}^i \right) \sqcup \left(\bigsqcup_{i < j \leq l-i} B_{(i, j)}^i \right) \\ &\quad \sqcup \left(\bigsqcup_{\substack{i < k, j \leq l-i \\ 0 \leq p \leq j, 0 \leq q \leq p+k}} \left(\tilde{f}_1^A\right)^q \left(\tilde{f}_0^A\right)^p \bar{b}_{(k, j)}^{l, i} \right) \sqcup \left(\bigsqcup_{\substack{i < k, j \leq l-i \\ 0 \leq p < k, 0 \leq q \leq p+j}} (\tilde{e}_1^A)^q (\tilde{e}_0^A)^p \underline{b}_{(-j, -k)}^{l, i} \right), \\ \mathcal{A}^{(l)} &= \bigsqcup_{0 \leq i \leq \lfloor \frac{l}{2} \rfloor} \mathcal{A}_i^{(l)}. \end{aligned}$$

Proposition 5.10 For $l \in \mathbf{Z}_{>0}$, we have

$$\#B^{G_2}(l\Lambda_1) = \#\mathcal{A}^{(l)}.$$

Proof By Proposition 5.9, we have

$$\begin{aligned}
\#B^{A_2}((l-i)\Lambda_1 + (l-k)\Lambda_0) &= \#B_{(k,i)}^i \\
&+ \sum_{m=1}^{l-i-k} \# \left\{ \left(\tilde{f}_1^A \right)^q \left(\tilde{f}_0^A \right)^p \bar{b}_{(k+m,i+m)}^{l,i} \mid \begin{array}{l} 0 \leq p \leq i+m \\ 0 \leq q \leq p+k+m \end{array} \right\} \\
&+ \sum_{m=1}^{l-i-k} \# \left\{ \left(\tilde{e}_1^A \right)^q \left(\tilde{e}_0^A \right)^p \underline{b}_{(-i-m,-k-m)}^{l,i} \mid \begin{array}{l} 0 \leq p < k+m \\ 0 \leq q \leq p+i+m \end{array} \right\}, \\
\#B^{A_2}((l-j)\Lambda_1 + (l-i)\Lambda_0) &= \#B_{(i,j)}^i \\
&+ \sum_{m=1}^{l-i-j} \# \left\{ \left(\tilde{f}_1^A \right)^q \left(\tilde{f}_0^A \right)^p \bar{b}_{(i+m,j+m)}^{l,i} \mid \begin{array}{l} 0 \leq p \leq j+m \\ 0 \leq q \leq p+i+m \end{array} \right\} \\
&+ \sum_{m=1}^{l-i-j} \# \left\{ \left(\tilde{e}_1^A \right)^q \left(\tilde{e}_0^A \right)^p \underline{b}_{(-j-m,-i-m)}^{l,i} \mid \begin{array}{l} 0 \leq p < i+m \\ 0 \leq q \leq p+j+m \end{array} \right\}.
\end{aligned}$$

By (5.2.2), we have

$$\sum_{i=0}^{\lfloor \frac{l}{2} \rfloor} \left(\sum_{k=i}^{l-i} \#B^{A_2}((l-k)\Lambda_1 + (l-i)\Lambda_0) + \sum_{j=i+1}^{l-i} \#B^{A_2}((l-i)\Lambda_1 + (l-j)\Lambda_0) \right) = \#B^{G_2}(l\Lambda_1).$$

□

By Proposition 5.9 and Proposition 5.10, we have the following lemma.

Lemma 5.11 For $l \in \mathbf{Z}_{>0}$ we have

$$\mathcal{G}^l \setminus \mathcal{A}^{(l)} \cong \mathcal{G}^{l-1}.$$

as crystal base of $U_q(A_2)$.

5.2.2 Operators $E_{\mathcal{A}}$ and $F_{\mathcal{A}}$ on \mathcal{A}

We are going to define operators $E_{\mathcal{A}}$ and $F_{\mathcal{A}}$ on \mathcal{A} which satisfy properties

- (C1) for $b, b' \in \mathcal{A}$, $E_{\mathcal{A}}b = b'$, if and only if $F_{\mathcal{A}}b' = b$,
- (C2) for $b \in \mathcal{A}$, $E_{\mathcal{A}}\tilde{f}_0^A(b) = \tilde{f}_0^A E_{\mathcal{A}}(b)$,
- (C3) for $b \in \mathcal{A}$, $\max\{m \mid F_{\mathcal{A}}^m b \neq 0\} - \max\{m' \mid E_{\mathcal{A}}^{m'} b \neq 0\} = -2\text{wt}_1^A(b) - \text{wt}_0^A(b)$.

Operators $E_{\mathcal{A}}$ and $F_{\mathcal{A}}$ are counterpart of $\tilde{e}_2^{\mathcal{G}}$ and $\tilde{f}_2^{\mathcal{G}}$, respectively. In view of Lemma 5.2.5 and (C2) we define $E_{\mathcal{A}}$ and $F_{\mathcal{A}}$ inductively. If $l = 0$, \mathcal{A} is trivial. If $l > 0$, we use following relation for induction

$$E_{\mathcal{A}} \left(\left(\tilde{f}_1^A \right)^q \left(\tilde{f}_0^A \right)^p \bar{b}_{(k,j)}^{l,i} \right) = \tilde{e}_0^A \left(E_{\mathcal{A}} \left(\left(\tilde{f}_1^A \right)^{q-1} \left(\tilde{f}_0^A \right)^p \bar{b}_{(k-1,j-1)}^{l-1,i} \right) \right). \quad (5.2.6)$$

Put $\mathcal{A}_+^{(l)} = \{b \mid \tilde{e}_0(b) = 0\}$. Using Proposition 3.9, we see that $\mathcal{A}_+^{(l)}$ is given by

$$\mathcal{A}_+^{(l)} = \left\{ \left(\tilde{f}_1^A \right)^q \left(\tilde{f}_0^A \right)^p \bar{b}_{(k,j)}^{l,i} \mid 0 \leq i \leq \left\lfloor \frac{l}{2} \right\rfloor, i \leq k, j \leq l-i, 0 \leq p \leq j, p \leq q \leq p+k \right\}.$$

By (C1) and (C2), it is sufficient to define the operator $E_{\mathcal{A}}$ for $b \in \mathcal{A}_+^{(l)}$.

Definition 5.12 We define $E_{\mathcal{A}}$ by

$$E_{\mathcal{A}} \left(\left(\tilde{f}_1^{\mathcal{A}} \right)^q \left(\tilde{f}_0^{\mathcal{A}} \right)^p \bar{b}_{(k,j)}^{l,i} \right) = \begin{cases} \left(\tilde{f}_1^{\mathcal{A}} \right)^q \left(\tilde{f}_0^{\mathcal{A}} \right)^p \bar{b}_{(k-1,j)}^{l,i}, & \text{(a1)} \\ \left(\tilde{f}_1^{\mathcal{A}} \right)^{q+1} \left(\tilde{f}_0^{\mathcal{A}} \right)^{p+1} \bar{b}_{(k,j+1)}^{l,i}, & \text{(a2)} \\ \left(\tilde{f}_1^{\mathcal{A}} \right)^{q+1} \left(\tilde{f}_0^{\mathcal{A}} \right)^p \bar{b}_{(k+1,j-1)}^{l,i+1}, & \text{(a3)} \\ \left(\tilde{f}_1^{\mathcal{A}} \right)^{q+1} \left(\tilde{f}_0^{\mathcal{A}} \right)^p \bar{b}_{(k+1,j-1)}^{l,i}, & \text{(a4)} \\ \left(\tilde{f}_1^{\mathcal{A}} \right)^{q+1} \left(\tilde{f}_0^{\mathcal{A}} \right)^p \bar{b}_{(k+1,j-1)}^{l,i-1}, & \text{(a5)} \\ 0, & \text{(a6)} \\ \tilde{e}_0^{\mathcal{A}} \left(E_{\mathcal{A}} \left(\left(\tilde{f}_1^{\mathcal{A}} \right)^{q-1} \left(\tilde{f}_0^{\mathcal{A}} \right)^p \bar{b}_{(k-1,j-1)}^{l-1,i} \right) \right). & \text{(5.2.6)} \end{cases}$$

Conditions for (a1)-(a6) and (5.2.6) are as follows:

- (1) If $i < k \leq l - i$, $i < j \leq l - i$,
 - (i) if $0 \leq q \leq j - 1 - \left\lfloor \frac{j-k}{3} \right\rfloor$, $p = \min(q, j)$, then the action of $E_{\mathcal{A}}$ is given by (a1),
 - (ii) if $j < l - i$, $j - \left\lfloor \frac{j-k}{3} \right\rfloor \leq q \leq j + k$, $p = \min(q, j)$, then the action of $E_{\mathcal{A}}$ is given by (a2),
 - (iii) if $j = l - i$, $j - \left\lfloor \frac{j-k}{3} \right\rfloor \leq q \leq j + k$, $p = \min(q, j)$, then the action of $E_{\mathcal{A}}$ is given by (a6),
 - (iv) if $0 \leq p \leq j - 1$, $p + 1 \leq q \leq p + k$, then we use induction (5.2.6).
- (2) If $k = i$, $i + 2 \leq j \leq l - i$,
 - (i) if $0 \leq p \leq j - 1 - \left\lfloor \frac{j-i}{3} \right\rfloor$, $p \leq q \leq p + i$ then the action of $E_{\mathcal{A}}$ is given by (a3),
 - (ii) if $j < l - i$, $j - \left\lfloor \frac{j-i}{3} \right\rfloor \leq p \leq j$, $p \leq q \leq p + i$ then the action of $E_{\mathcal{A}}$ is given by (a2),
 - (iii) if $j = l - i$, $j - \left\lfloor \frac{j-i}{3} \right\rfloor \leq p \leq j$, $p \leq q \leq p + i$ then the action of $E_{\mathcal{A}}$ is given by (a6).
- (3) If $k = i$, $j = i + 1$,
 - (i) if $0 \leq p \leq i$, $p \leq q \leq p + i$ then the action of $E_{\mathcal{A}}$ is given by (a4),
 - (ii) if $p = i + 1$, $p \leq q \leq p + i$ then the action of $E_{\mathcal{A}}$ is given by (a2).
- (4) If $k = i$, $j = i$,
 - (i) if $0 \leq p \leq i - 1$, $p \leq q \leq p + i$ then the action of $E_{\mathcal{A}}$ is given by (a5),
 - (ii) if $p = i$, $i \leq q \leq 2i$ then the action of $E_{\mathcal{A}}$ is given by (a2).
- (5) If $i + 1 \leq k \leq l - i$, $j = i$,
 - (i) if $0 \leq p \leq i$, $p \leq q \leq p - 1 - \left\lfloor \frac{i-k}{3} \right\rfloor$ then the action of $E_{\mathcal{A}}$ is given by (a1),
 - (ii) if $p = i$, $p - \left\lfloor \frac{i-k}{3} \right\rfloor \leq q \leq p + k$ then the action of $E_{\mathcal{A}}$ is given by (a2),
 - (iii) if $0 \leq p \leq i - 1$, $p - \left\lfloor \frac{i-k}{3} \right\rfloor \leq q \leq p + k$ then the action of $E_{\mathcal{A}}$ is given by (a5).

By (C1) and definition of $E_{\mathcal{A}}$, we see the action of $F_{\mathcal{A}}$ on $\mathcal{A}_+^{(l)}$ is given by

$$F_{\mathcal{A}} \left(\left(\tilde{f}_1^{\mathcal{A}} \right)^q \left(\tilde{f}_0^{\mathcal{A}} \right)^p \bar{b}_{(k,j)}^{l,i} \right) = \begin{cases} \tilde{f}_1^q \tilde{f}_0^p \bar{b}_{(k+1,j)}^{l,i}, & \text{(a1)'} \\ \tilde{f}_1^{q-1} \tilde{f}_0^{p-1} \bar{b}_{(k,j-1)}^{l,i}, & \text{(a2)'} \\ \tilde{f}_1^{q-1} \tilde{f}_0^p \bar{b}_{(k-1,j+1)}^{l,i-1}, & \text{(a3)'} \\ \tilde{f}_1^{q-1} \tilde{f}_0^p \bar{b}_{(k-1,j+1)}^{l,i}, & \text{(a4)'} \\ \tilde{f}_1^{q-1} \tilde{f}_0^p \bar{b}_{(k-1,j+1)}^{l,i+1}, & \text{(a5)'} \\ 0, & \text{(a6)'} \\ \tilde{e}_0^{\mathcal{A}} \left(F_{\mathcal{A}} \left(\left(\tilde{f}_1^{\mathcal{A}} \right)^{q-1} \left(\tilde{f}_0^{\mathcal{A}} \right)^p \bar{b}_{(k-1,j-1)}^{l-1,i} \right) \right). & \text{(5.2.6)'} \end{cases}$$

As in the case of $E_{\mathcal{A}}$, we use induction (5.2.6)'. Conditions for (a1)'-(a6)' are as follows:

- (1) If $i < k \leq l - i$, $i < j \leq l - i$,
 - (i) if $k < l - i$, $0 \leq q \leq j - 1 - \left\lfloor \frac{j-k-1}{3} \right\rfloor$, $p = \min(q, j)$, then the action of $F_{\mathcal{A}}$ is given by (a1)',
 - (ii) if $k = l - i$, $0 \leq q \leq j - 1 - \left\lfloor \frac{j-k-1}{3} \right\rfloor$, $p = \min(q, j)$, then the action of $F_{\mathcal{A}}$ is given by (a6)',
 - (iii) if $j - \left\lfloor \frac{j-k-1}{3} \right\rfloor \leq q \leq j + k$, $p = \min(q, j)$, then the action of $F_{\mathcal{A}}$ is given by (a2)',
 - (iv) if $0 \leq p \leq j - 1$, $p + 1 \leq q \leq p + k$, then we use induction (5.2.6)'.
- (2) If $k = i$, $i + 1 \leq j \leq l - i$,
 - (i) if $0 \leq p \leq j - 1 - \left\lfloor \frac{j-k-1}{3} \right\rfloor$, $q = p$ then the action of $F_{\mathcal{A}}$ is given by (a1)',
 - (ii) if $0 \leq p \leq j - 1 - \left\lfloor \frac{j-k-1}{3} \right\rfloor$, $p + 1 \leq q \leq p + k + 1$ then the action of $F_{\mathcal{A}}$ is given by (a3)',
 - (iii) if $j - \left\lfloor \frac{j-k-1}{3} \right\rfloor \leq p \leq j$, $p \leq q \leq p + k$, then the action of $F_{\mathcal{A}}$ is given by (a2)'.
- (3) If $k = i$, $j = i$,
 - (i) if $0 \leq p \leq i$, $p = q$ then the action of $F_{\mathcal{A}}$ is given by (a2)',
 - (ii) if $0 \leq p \leq i$, $p + 1 \leq q \leq p + i$ then the action of $F_{\mathcal{A}}$ is given by (a3)'.
- (4) If $k = i + 1$, $j = i$,
 - (i) if $0 \leq p \leq i$, $p = q$ then the action of $F_{\mathcal{A}}$ is given by (a2)',
 - (ii) if $0 \leq p \leq i$, $p + 1 \leq q \leq p + i + 1$ then the action of $F_{\mathcal{A}}$ is given by (a4)'.
- (5) If $i + 2 \leq k \leq l - i$, $j = i$,
 - (i) if $0 \leq p \leq i$, $p \leq q \leq p - 1 - \left\lfloor \frac{i-k-1}{3} \right\rfloor$ then the action of $F_{\mathcal{A}}$ is given by (a1)',
 - (ii) if $0 \leq p \leq i$, $p - \left\lfloor \frac{i-k-1}{3} \right\rfloor \leq q \leq p + k$ then the action of $F_{\mathcal{A}}$ is given by (a5)'.

For $b \in \mathcal{A}$, we put

$$\begin{aligned} \varepsilon_{\mathcal{A}}(b) &= \max\{m \mid F_{\mathcal{A}}^m b \neq 0\}, \\ \varphi_{\mathcal{A}}(b) &= \max\{m' \mid E_{\mathcal{A}}^{m'} b \neq 0\}. \end{aligned}$$

We verify that $E_{\mathcal{A}}$ is well-defined. By the definition of $F_{\mathcal{A}}$, we see that for $b, b' \in \mathcal{A}_+^{(l)}$,

$$\text{if } E_{\mathcal{A}}(b) = E_{\mathcal{A}}(b') \neq 0, \text{ then } b = b'. \quad (5.2.7)$$

In order to verify (C2), we prove that $E_{\mathcal{A}}(\tilde{f}_0^{\mathcal{A}}(b)) \neq 0$ if and only if $\tilde{f}_0^{\mathcal{A}}(E_{\mathcal{A}}(b)) \neq 0$. For this, it is sufficient to prove that for $b \in A_+^{(l)}$,

$$\varphi_0(b) = \varphi_0(E_{\mathcal{A}}b). \quad (5.2.8)$$

Using Proposition 5.5, we have following formula in the case of (a1) of Definition 5.12,

$$\begin{aligned} \varphi_0 \left(\tilde{f}_1^q \tilde{f}_0^p \bar{b}_{(k,j)}^{l,i} \right) &= j + q - 2p, \\ \varphi_0 \left(E_{\mathcal{A}} \tilde{f}_1^q \tilde{f}_0^p \bar{b}_{(k,j)}^{l,i} \right) &= \varphi_0 \left(\tilde{f}_1^q \tilde{f}_0^p \bar{b}_{(k-1,j)}^{l,i} \right) = j + q - 2p. \end{aligned}$$

In a similar way we can prove other cases. Therefore we see that for $b \in \mathcal{A}$ such that $E_{\mathcal{A}}(b) \neq 0$, $\tilde{f}_0^{\mathcal{A}}b \neq 0$ we have $E_{\mathcal{A}}(\tilde{f}_0^{\mathcal{A}}b) \neq 0$. Similarly we can show that for $b \in \mathcal{A}$ such that $E_{\mathcal{A}}(b) = 0$ or $\tilde{f}_0^{\mathcal{A}}b = 0$ we have $E_{\mathcal{A}}(\tilde{f}_0^{\mathcal{A}}b) = 0$.

We verify (C3). By calculation, we see

$$\text{wt}^{\mathcal{A}} \left(\tilde{f}_1^q \tilde{f}_0^p \bar{b}_{(k,j)}^{l,i} \right) = (k + p - 2q)\Lambda_1 + (j - 2p + q)\Lambda_0. \quad (5.2.9)$$

If the action of $E_{\mathcal{A}}$ is given by (a1), we have

$$\text{wt}^{\mathcal{A}} \left(E_{\mathcal{A}} \tilde{f}_1^q \tilde{f}_0^p \bar{b}_{(k,j)}^{l,i} \right) = \text{wt}^{\mathcal{A}} \left(\tilde{f}_1^q \tilde{f}_0^p \bar{b}_{(k-1,j)}^{l,i} \right) = (k - 1 + p - 2q)\Lambda_1 + (j - 2p + q)\Lambda_0.$$

Therefore, we have

$$-2\text{wt}_1^{\mathcal{A}}(E_{\mathcal{A}}b) - \text{wt}_0^{\mathcal{A}}(E_{\mathcal{A}}b) = -2\text{wt}_1^{\mathcal{A}}(b) - \text{wt}_0^{\mathcal{A}}(b) + 2. \quad (5.2.10)$$

Similarly we can show (5.2.10) when the action of $E_{\mathcal{A}}$ is given by (a2) - (a5).

We prove (C3) for $b = \left(\tilde{f}_1^{\mathcal{A}} \right)^q \left(\tilde{f}_0^{\mathcal{A}} \right)^p \bar{b}_{(l-i,j)}^{l,i} \in \mathcal{A}_+^{(l)}$ where $i \leq j \leq l - i$, $0 \leq p \leq j$, $p \leq q \leq p + l - i$. By Definition 5.12, b satisfies $F_{\mathcal{A}}(b) = 0$ and

$$\varepsilon_{\mathcal{A}}(b) = 2l - 2i + j - 3q. \quad (5.2.11)$$

1. If $0 \leq p = q \leq \lfloor \frac{i+j}{2} \rfloor$,

The action of $E_{\mathcal{A}}$ on $\tilde{f}_1^p \tilde{f}_0^p \bar{b}_{(k,j)}^{l,i}$ ($i < k \leq l - i$) is given by (a1). Then we have

$$E_{\mathcal{A}}^{l-2i}(b) = \tilde{f}_1^p \tilde{f}_0^p \bar{b}_{(i,j)}^{l,i}.$$

If $\lfloor \frac{j-i}{2} \rfloor > 0$, the action of $E_{\mathcal{A}}$ on $\tilde{f}_1^p \tilde{f}_0^p \bar{b}_{(i,j)}^{l,i}$ is given by (a3). We put $x = \frac{i+j}{2}$, $\hat{x} = \frac{i+j+1}{2}$. Then we have

$$E_{\mathcal{A}}^{l-3i+[x]}(b) = \begin{cases} \tilde{f}_1^{p+\hat{x}-i-1} \tilde{f}_0^p \bar{b}_{(\hat{x}-1,\hat{x})}^{l,\hat{x}-1} & j - i \text{ is odd,} \\ \tilde{f}_1^{p+x-i} \tilde{f}_0^p \bar{b}_{(x,x)}^{l,x} & j - i \text{ is even.} \end{cases}$$

If $i - j$ is odd, the action of $E_{\mathcal{A}}$ on $\tilde{f}_1^{p+\hat{x}-i-1} \tilde{f}_0^p \bar{b}_{((\hat{x}-1),\hat{x})}^{l,\hat{x}-1}$ is given by (a4). Then we have

$$E_{\mathcal{A}}^{l-3i+[x]}(b) = \tilde{f}_1^{p+\hat{x}-i} \tilde{f}_0^p \bar{b}_{(\hat{x},(\hat{x}-1))}^{l,\hat{x}-1}.$$

If $j - p - [\hat{x} - i] > 0$, then the action of $E_{\mathcal{A}}$ on $\tilde{f}_1^{p+x-i} \tilde{f}_0^p \bar{b}_{(x,x)}^{l,x}$, $\tilde{f}_1^{p+\hat{x}-i} \tilde{f}_0^p \bar{b}_{(\hat{x},\hat{x}-1)}^{l,\hat{x}-1}$ are given by (a5). Then we have

$$E_{\mathcal{A}}^{l-2i+j-p}(b) = \tilde{f}_1^j \tilde{f}_0^p \bar{b}_{(j+i-p,p)}^{l,p}.$$

Moreover, the action of $E_{\mathcal{A}}$ on $\tilde{f}_1^j \tilde{f}_0^p \bar{b}_{(j+i-p,p)}^{l,p}$ is given by (a2). Then we have

$$E_{\mathcal{A}}^{2l-2i+j-3p}(b) = \tilde{f}_1^{l+j-2p} \tilde{f}_0^{l-p} \bar{b}_{(j+i-p,l-p)}^{l,p}. \quad (5.2.12)$$

Finally, the action of $E_{\mathcal{A}}$ on $\tilde{f}_1^{l+j-2p} \tilde{f}_0^{l-p} \bar{b}_{(j+i-p,l-p)}^{l,p}$ is given by (a6). Then we have

$$E_{\mathcal{A}}^{2l-2i+j-3p+1}(b) = 0.$$

2. If $\lfloor \frac{i+j}{2} \rfloor < p = q < \frac{2i+i}{3}$, we can calculate in a similar way:

$$\begin{aligned} E_{\mathcal{A}}^{l-2i}(b) &= \tilde{f}_1^p \tilde{f}_0^p \bar{b}_{(i,j)}^{l,i}, & (\text{a1}) \\ E_{\mathcal{A}}^{l-i+2j-3p}(b) &= \tilde{f}_1^{2j+i-2p} \tilde{f}_0^p \bar{b}_{(2j+2i-3p,-j-i+3p)}^{l,2j+2i-3p}, & (\text{a3}) \\ E_{\mathcal{A}}^{2l-2i+j-3p}(b) &= \tilde{f}_1^{l+j-2p} \tilde{f}_0^{l-i-j+p} \bar{b}_{(2j+2i-3p,l-2j-2i+3p)}^{l,2j+2i-3p}, & (\text{a2}) \\ E_{\mathcal{A}}^{2l-2i+j-3p+1}(b) &= 0. & (\text{a6}) \end{aligned} \tag{5.2.13}$$

3. If $\frac{2j+i}{3} < p = q \leq j$ or $j = p < q$, we have

$$\begin{aligned} E_{\mathcal{A}}^{l-i+2j-3q}(b) &= \tilde{f}_1^q \tilde{f}_0^p \bar{b}_{(3q-2j,j)}^{l,i}, & (\text{a1}) \\ E_{\mathcal{A}}^{2l-2i+j-3q}(b) &= \tilde{f}_1^{l-i-j+q} \tilde{f}_0^{l-i-j+p} \bar{b}_{(3q-2j,l-i)}^{l,i}, & (\text{a2}) \\ E_{\mathcal{A}}^{2l-2i+j-3q+1}(b) &= 0. & (\text{a6}) \end{aligned} \tag{5.2.14}$$

4. If $p < j = i$, $p < q < y + j$, we have

$$\begin{aligned} E_{\mathcal{A}}^{l-2i-3(p-q)}(b) &= \tilde{f}_1^q \tilde{f}_0^p \bar{b}_{(i+3(q-p),i)}^{l,i}, & (\text{a1}) \\ E_{\mathcal{A}}^{l-i-3q+2p}(b) &= \tilde{f}_1^{q+i-p} \tilde{f}_0^p \bar{b}_{(2i+3q-4p,l-p)}^{l,p}, & (\text{a5}) \\ E_{\mathcal{A}}^{2l-i-3q}(b) &= \tilde{f}_1^{l+i-3p+q} \tilde{f}_0^{l-p} \bar{b}_{(2i+3q-4p,l-p)}^{l,p}, & (\text{a2}) \\ E_{\mathcal{A}}^{2l-i-3q+1}(b) &= 0. & (\text{a6}) \end{aligned} \tag{5.2.15}$$

5. Other cases are reduced to \mathcal{G}^{l-1} , using (5.2.6).

Then for $b = \left(\tilde{f}_1^A\right)^q \left(\tilde{f}_0^A\right)^p \bar{b}_{(l-i,j)}^{l,i} \in \mathcal{A}_+^{(l)}$ where $i \leq j \leq l-i$, $0 \leq p \leq j$, $p \leq q \leq p+l-i$, we have

$$-2\text{wt}_1^A(b) - \text{wt}_0^A(b) = -(2l - 2i + j - 3q).$$

By (5.2.11), we see

$$\varphi_{\mathcal{A}}(b) - \varepsilon_{\mathcal{A}}(b) = -(2l - 2i + j - 3q).$$

Therefore by (5.2.10), we verify inductively that $E_{\mathcal{A}}$ satisfies (C3).

5.2.3 An involution on \mathcal{A}

Let $\underline{b}_{(j_1,j_0)}^{l,i}$ be the lowest weight element in \mathcal{A}_i with weight $j_1\Lambda_1 + j_0\Lambda_0$. We define a map $C_{\mathcal{A}} : \mathcal{A} \rightarrow \mathcal{A}$ by:

$$\begin{aligned} C_{\mathcal{A}} \left(\left(\tilde{f}_0^A\right)^r \left(\tilde{f}_1^A\right)^q \left(\tilde{f}_0^A\right)^p \bar{b}_{(k,j)}^{l,i} \right) &= (\tilde{e}_0^A)^r (\tilde{e}_1^A)^q (\tilde{e}_0^A)^p \underline{b}_{(-k,-j)}^{l,i} \\ &= \left(\tilde{f}_0^A\right)^{j+q-2p-r} \left(\tilde{f}_1^A\right)^{k+j-q} \left(\tilde{f}_0^A\right)^{k-q+p} \bar{b}_{(j,k)}^{l,i}. \end{aligned} \tag{5.2.16}$$

where $0 \leq p \leq j$, $p \leq q \leq p+k$, $0 \leq r \leq j+q-2p$. It is easy to see that $C_{\mathcal{A}}$ is an involution,

$$C_{\mathcal{A}}(C_{\mathcal{A}}(b)) = b \quad (b \in \mathcal{A}).$$

Proposition 5.13 For $b \in \mathcal{A}$, we have

$$C_{\mathcal{A}}(E_{\mathcal{A}}b) = F_{\mathcal{A}}(C_{\mathcal{A}}(b)). \tag{5.2.17}$$

Proof It is sufficient to prove (5.2.17) for $b \in \mathcal{A}$ such that $\varepsilon_0^A(b) = 0$.

We assume that for $b = \left(\tilde{f}_1^A\right)^q \left(\tilde{f}_0^A\right)^p \bar{b}_{(k,j)}^{l,i} \in \mathcal{A}$, k, j, p, q satisfy $i+1 \leq k \leq l-i$, $i+1 \leq j \leq l-i$, $0 \leq q \leq j-1 - \left\lfloor \frac{j-k}{3} \right\rfloor$, $p = \min(q, j)$. Since this is the condition (1)(i) in Definition 5.12, the action of $E_{\mathcal{A}}$ is given by (a1). Then we have

$$C_{\mathcal{A}}(E_{\mathcal{A}}b) = \left(\tilde{f}_0^A\right)^{j+q-2p} \left(\tilde{f}_1^A\right)^{k+j-q-1} \left(\tilde{f}_0^A\right)^{k-q+p-1} \bar{b}_{(j,k-1)}^{l,i}.$$

We consider the action of $F_{\mathcal{A}}$ on $C_{\mathcal{A}}(b)$. By applying the involution, we have

$$C_{\mathcal{A}}(b) = \left(\tilde{f}_0^A\right)^{j+q-2p} \left(\tilde{f}_1^A\right)^{k+j-q} \left(\tilde{f}_0^A\right)^{k-q+p} \bar{b}_{(j,k)}^{l,i}.$$

Thus the action of $F_{\mathcal{A}}$ on $C_{\mathcal{A}}(b)$ is given by (a2)'. Therefore we have

$$F_{\mathcal{A}}(C_{\mathcal{A}}(b)) = \left(\tilde{f}_0^A\right)^{j+q-2p} \left(\tilde{f}_1^A\right)^{k+j-q-1} \left(\tilde{f}_0^A\right)^{k-q+p-1} \bar{b}_{(j,k-1)}^{l,i}.$$

In a similar way, we have

if the action of $E_{\mathcal{A}}b$ is given by (a1), then the action of $F_{\mathcal{A}}(C_{\mathcal{A}}(b))$ is given by (a2)',
if the action of $E_{\mathcal{A}}b$ is given by (a2), then the action of $F_{\mathcal{A}}(C_{\mathcal{A}}(b))$ is given by (a1)',
if the action of $E_{\mathcal{A}}b$ is given by (a3), then the action of $F_{\mathcal{A}}(C_{\mathcal{A}}(b))$ is given by (a5)',
if the action of $E_{\mathcal{A}}b$ is given by (a4), then the action of $F_{\mathcal{A}}(C_{\mathcal{A}}(b))$ is given by (a4)',
if the action of $E_{\mathcal{A}}b$ is given by (a5), then the action of $F_{\mathcal{A}}(C_{\mathcal{A}}(b))$ is given by (a3)',
if the action of $E_{\mathcal{A}}b$ is given by (a6), then the action of $F_{\mathcal{A}}(C_{\mathcal{A}}(b))$ is given by (a6)'.

Thus we have $C_{\mathcal{A}}(E_{\mathcal{A}}(b)) = F_{\mathcal{A}}(C_{\mathcal{A}}(b))$. □

For $a \in \mathbf{Z}$, we define a_+ by

$$a_+ = \begin{cases} a & (a > 0), \\ 0 & (a \leq 0). \end{cases}$$

We set $B_C, B_W, B_U, B_R \subset \mathcal{A}^{(l)}$ by

$$\begin{aligned} B_C &= \left\{ \left(\tilde{f}_1^A\right)^q \left(\tilde{f}_0^A\right)^p \bar{b}_{(l-i,j)}^{l,i} \mid 0 \leq i \leq \left\lfloor \frac{l}{2} \right\rfloor, i \leq j \leq l-i, 0 \leq q \leq p \leq j \right\}, \\ B_W &= \left\{ \left(\tilde{f}_1^A\right)^q \left(\tilde{f}_0^A\right)^p \bar{b}_{(l-i,j)}^{l,i} \mid 0 \leq i \leq \left\lfloor \frac{l}{2} \right\rfloor, j = i, 0 \leq p \leq j, p < q \leq y + j \right\}, \\ B_U &= \left\{ \left(\tilde{f}_1^A\right)^q \left(\tilde{f}_0^A\right)^p \bar{b}_{(l-i,j)}^{l,i} \mid 0 \leq i \leq \left\lfloor \frac{l}{2} \right\rfloor, i \leq j \leq l-i, p = j, j < q \leq y + 2j - i \right\}, \\ B_R &= \left\{ \left(\tilde{f}_1^A\right)^q \left(\tilde{f}_0^A\right)^p \bar{b}_{(l-i,j)}^{l,i} \mid \begin{array}{l} 0 \leq i \leq \left\lfloor \frac{l}{2} \right\rfloor, i < j \leq l-i, \\ 0 \leq q < j, p < q \leq y + j - (i-p)_+ \end{array} \right\}, \end{aligned}$$

where $y = y \left(\left(\tilde{f}_1^A\right)^q \left(\tilde{f}_0^A\right)^p \bar{b}_{(l-i,j)}^{l,i} \right) = \left\lfloor \frac{l-i-j}{3} \right\rfloor$.

In view of Definition 5.12, the conditions $\varepsilon_0^A(b) = 0$, $\varphi_{\mathcal{A}}(b) = 0$ on $b = \left(\tilde{f}_1^A\right)^q \left(\tilde{f}_0^A\right)^p \bar{b}_{(l-i,j)}^{l,i}$ ($0 \leq i \leq \left\lfloor \frac{l}{2} \right\rfloor, i \leq j \leq l-i, 0 \leq p \leq j$) are rephrased as

$$\begin{cases} 0 \leq q \leq p - \left\lfloor \frac{-l+i+j}{3} \right\rfloor + (j-i) & (p \leq i, l-i-j \equiv 0 \pmod{3}), \\ 0 \leq q \leq p - 1 - \left\lfloor \frac{-l+i+j}{3} \right\rfloor + (j-i) & (p \leq i, l-i-j \not\equiv 0 \pmod{3}), \\ 0 \leq q \leq j - \left\lfloor \frac{-l+i+j}{3} \right\rfloor & (p > i, l-i-j \equiv 0 \pmod{3}), \\ 0 \leq q \leq j - 1 - \left\lfloor \frac{-l+i+j}{3} \right\rfloor & (p > i, l-i-j \not\equiv 0 \pmod{3}). \end{cases}$$

Summarizing, we have

$$0 \leq q \leq \left\lceil \frac{l-i-j}{3} \right\rceil + j - (i-p)_+ = y + j - (i-p)_+.$$

Thus we have

$$\begin{aligned} & \{b \in \mathcal{A} \mid \varepsilon_0^{\mathcal{A}}(b) = 0, \varphi_{\mathcal{A}}(b) = 0\} \\ &= \left\{ \left(\tilde{f}_1^{\mathcal{A}} \right)^q \left(\tilde{f}_0^{\mathcal{A}} \right)^p \bar{b}_{(l-i,j)}^{l,i} \mid 0 \leq i \leq \left\lfloor \frac{l}{2} \right\rfloor, i \leq j \leq l-i, 0 \leq p \leq j, p \leq q \leq y + j - (i-p)_+ \right\}. \end{aligned}$$

Hence, we see easily that

$$\{b \in \mathcal{A} \mid \varepsilon_0^{\mathcal{A}}(b) = 0, \varphi_{\mathcal{A}}(b) = 0\} \subset B_C \cup B_W \cup B_U \cup B_R.$$

By Proposition 5.3, we have

$$\left\{ \left(\tilde{f}_0^{\mathcal{A}} \right)^r \left(\tilde{f}_1^{\mathcal{A}} \right)^p \left(\tilde{f}_0^{\mathcal{A}} \right)^p \bar{b}_{(l-i,j)}^{l,i} \mid 0 \leq p \leq j, 0 \leq r \leq j-p \right\} = B_C. \quad (5.2.18)$$

Proposition 5.14 *For $b \in B_W \cup B_U$, we have*

$$C_{\mathcal{A}} \left(E_{\mathcal{A}}^{\varepsilon_{\mathcal{A}}(b)}(b) \right) \in B_C.$$

Proof By calculation for $b = \left(\tilde{f}_1^{\mathcal{A}} \right)^q \left(\tilde{f}_0^{\mathcal{A}} \right)^p \bar{b}_{(l-i,i)}^{l,i} \in B_W$ ($0 \leq p < i, p < q \leq y+i$) we have

$$C_{\mathcal{A}} \left(E_{\mathcal{A}}^{\varepsilon_{\mathcal{A}}(b)}(b) \right) = \left(\tilde{f}_1^{\mathcal{A}} \right)^{i+2q-2p} \left(\tilde{f}_0^{\mathcal{A}} \right)^{2i+3q-4p} \bar{b}_{(l-p,2i+3q-4p)}^{l,p}.$$

Since $p < q, p < i$, we have

$$2i + 3q - 4p - (i + 2q - 2p) = (i - p) + (q - p) > 0.$$

Then we have

$$C_{\mathcal{A}} \left(E_{\mathcal{A}}^{\varepsilon_{\mathcal{A}}(b)}(b) \right) \in B_C.$$

In a similar way, for $b \in B_U$ we have

$$C_{\mathcal{A}} \left(E_{\mathcal{A}}^{\varepsilon_{\mathcal{A}}(b)}(b) \right) \in B_C.$$

□

Similar to Proposition 5.14, we have following proposition:

Proposition 5.15 *For $b \in B_R$, we have*

$$C_{\mathcal{A}} \left(E_{\mathcal{A}}^{\varepsilon_{\mathcal{A}}(b)}(b) \right) \in B_R.$$

5.2.4 Definition of Φ on \mathcal{A} and $\tilde{f}_0^{\mathcal{G}}$ on \mathcal{G}^l

In this section, we define one-to-one map $\Phi : \mathcal{A} \rightarrow \mathcal{G}^l$ and Kashiwara operator $\tilde{f}_0^{\mathcal{G}}$ on \mathcal{G}^l exploiting operators on \mathcal{A} .

Since roots α_0 and α_2 of algebra $U_q(G_2^{(1)})$ are orthogonal, the Kashiwara operator $\tilde{f}_0^{\mathcal{G}}$ commutes with $\tilde{f}_2^{\mathcal{G}}$.

$$(D1) \quad \tilde{f}_0^{\mathcal{G}} \tilde{f}_2^{\mathcal{G}}(b) = \tilde{f}_2^{\mathcal{G}} \tilde{f}_0^{\mathcal{G}}(b), \quad \tilde{e}_0^{\mathcal{G}} \tilde{e}_2^{\mathcal{G}}(b) = \tilde{e}_2^{\mathcal{G}} \tilde{e}_0^{\mathcal{G}}(b), \quad \text{for } b \in \mathcal{G}^l.$$

In view of Proposition 5.8, we are going to construct the one-to-one map

$$\Phi : \mathcal{A} \rightarrow \mathcal{G}^l,$$

with the following properties;

$$(E1) \quad \tilde{e}_1^{\mathcal{G}} \Phi(b) = \Phi(\tilde{e}_1^{\mathcal{A}} b), \text{ for } b \in \mathcal{A},$$

$$(E2) \quad \tilde{f}_2^{\mathcal{G}} \Phi(b) = \Phi(F_{\mathcal{A}} b), \text{ for } b \in \mathcal{A},$$

$$(E3) \quad \text{wt}_1^{\mathcal{G}}(\Phi(b)) = \text{wt}_1^{\mathcal{A}}(b), \text{ for } b \in \mathcal{A},$$

$$(E4) \quad \text{wt}_2^{\mathcal{G}}(\Phi(b)) = -2\text{wt}_1^{\mathcal{A}}(b) - \text{wt}_0^{\mathcal{A}}(b), \text{ for } b \in \mathcal{A},$$

$$(E5) \quad \tilde{e}_0^{\mathcal{G}} \Phi(b) = 0 \text{ (resp. } \tilde{f}_0^{\mathcal{G}} \Phi(b) = 0) \text{ if and only if } \tilde{e}_0^{\mathcal{A}}(b) = 0 \text{ (resp. } \tilde{f}_0^{\mathcal{A}}(b) = 0), \text{ for } b \in \mathcal{A}.$$

By (E1) and (E2), we see easily

$$(E1)' \quad \tilde{f}_1^{\mathcal{G}} \Phi(b) = \Phi(\tilde{f}_1^{\mathcal{A}} b), \text{ for } b \in \mathcal{A},$$

$$(E2)' \quad \tilde{e}_2^{\mathcal{G}} \Phi(b) = \Phi(E_{\mathcal{A}} b), \text{ for } b \in \mathcal{A}.$$

We call an element $b \in \mathcal{A}$ \mathcal{A} -terminal if $F_{\mathcal{A}}(b) = 0$. An $E_{\mathcal{A}}$ -string is a sequence of elements in \mathcal{A} , b , $E_{\mathcal{A}}(b)$, $E_{\mathcal{A}}^2(b)$, \dots , $E_{\mathcal{A}}^n(b)$, where b is \mathcal{A} -terminal and $E_{\mathcal{A}}^{n+1}(b) = 0$ ($n \in \mathbf{Z}_{\geq 0}$). We first define Φ for \mathcal{A} -terminal elements using (E3)(E4) mainly. Next we define the the action of Φ for elements of an $E_{\mathcal{A}}$ -string using (E2). We verify (E1) completely in §5.3.

Definition 5.16 *We define*

$$\Phi\left(\left(\tilde{f}_0^{\mathcal{A}}\right)^p \bar{b}_{(l,l)}^{l,0}\right) = \left[\left[\left[6\right]\right]^p \left[\left[2\right]\right]^{l-p}\right] \quad (0 \leq p \leq l), \quad (5.2.19)$$

$$\Phi\left(\left(\tilde{e}_0^{\mathcal{A}}\right)^p \underline{b}_{(-l,-l)}^{l,0}\right) = \left[\left[\left[2\right]\right]^{l-p} \left[\left[6\right]\right]^p\right] \quad (0 \leq p \leq l). \quad (5.2.20)$$

We verify the properties (E1)–(E5).

By the definition of $\bar{b}_{(l,l)}^{l,0}$,

$$\text{wt}^{\mathcal{A}}\left(\bar{b}_{(l,l)}^{l,0}\right) = l\Lambda_1 + l\Lambda_0.$$

By (E3) and (E4), we see that $\Phi\left(\bar{b}_{(l,l)}^{l,0}\right)$ is the element with weight $l\Lambda_1 - 3l\Lambda_2$. We can see easily that

$b = \left[\left[\left[6\right]\right]^k \left[\left[2\right]\right]^{l-k}\right]$ ($0 \leq k \leq l$) is the only element such that $\text{wt}_2^{\mathcal{G}}(b) = -3l$. Moreover $b = \left[\left[\left[2\right]\right]^l\right]$ is the only element such that $\text{wt}_1^{\mathcal{G}}(b) = l$. The highest weight element is only element in $B_{(k,j)}^i$ that satisfies $\text{wt}(b) = k'\Lambda_1 + j'\Lambda_0$ ($k' \geq k, j' \geq j$). By the definition of \mathcal{A} , the element $b \in \mathcal{A}$ with $\text{wt}(b) = l\Lambda_1 + l\Lambda_0$ is $\bar{b}_{(l,l)}^{l,0}$. Therefore, we have

$$\Phi\left(\bar{b}_{(l,l)}^{l,0}\right) = \left[\left[\left[2\right]\right]^l\right]. \quad (5.2.21)$$

We verify (E1). Since $\tilde{e}_1^{\mathcal{A}} \bar{b}_{(l,l)}^{l,0} = 0$, we verify $\tilde{e}_1^{\mathcal{G}} \left[\left[\left[2\right]\right]^l\right] = 0$. Using Proposition 3.9,

$$\Psi_1\left(\left[\left[\left[2\right]\right]^l\right]\right) = u_+^l.$$

Then we have

$$\tilde{e}_1^{\mathcal{G}} \left[\left[\left[2\right]\right]^l\right] = 0$$

In a similar way, we verify (E2). We consider $\left(\tilde{f}_0^{\mathcal{A}}\right)^p \bar{b}_{(l,l)}^{l,0}$. We see that the element $b \in \mathcal{G}^l$ which satisfy following formula is unique:

$$\text{wt}^{\mathcal{G}}(b) = (l+k)\Lambda_1 - 3l\Lambda_2.$$

Thus, we can define

$$\Phi\left(\left(\tilde{f}_0^{\mathcal{A}}\right)^p \bar{b}_{(l,l)}^{l,0}\right) = \left[\left[\left[6\right]\right]^p \left[\left[2\right]\right]^{l-p}\right] \quad (0 \leq p \leq l). \quad (5.2.22)$$

Similarly, by the calculation of weight, we can define uniquely

$$\Phi \left((\tilde{e}_0^A)^p \underline{b}_{(-l,-l)}^{l,0} \right) = \left[\left[\left[2 \right] \right]^{l-p} \left[\left[\bar{6} \right] \right]^p \right] \quad (0 \leq p \leq l).$$

□

By (E5) and (5.2.22), we define the action of \tilde{e}_0^G and \tilde{f}_0^G for $\left[\left[\left[6 \right] \right]^p \left[\left[\bar{2} \right] \right]^{l-p} \right]$ ($0 \leq p \leq l$) by

$$\tilde{f}_0^G \left[\left[\left[6 \right] \right]^p \left[\left[\bar{2} \right] \right]^{l-p} \right] = \begin{cases} \left[\left[\left[6 \right] \right]^{p+1} \left[\left[\bar{2} \right] \right]^{l-p-1} \right] & 0 \leq p \leq l-1 \\ 0 & p = l \end{cases} \quad (5.2.23)$$

$$\tilde{e}_0^G \left[\left[\left[6 \right] \right]^p \left[\left[\bar{2} \right] \right]^{l-p} \right] = \begin{cases} \left[\left[\left[6 \right] \right]^{p-1} \left[\left[\bar{2} \right] \right]^{l-p+1} \right] & 1 \leq p \leq l \\ 0 & p = 0 \end{cases} \quad (5.2.24)$$

In view of Definition 5.12, 5.16 and (E2)', following definition is led.

Definition 5.17 *We define*

$$\Phi \left((\tilde{f}_0^A)^p \bar{b}_{(k,l)}^{l,0} \right) = (\tilde{e}_2^G)^{l-k} \left[\left[\left[6 \right] \right]^p \left[\left[\bar{2} \right] \right]^{l-p} \right]. \quad (5.2.25)$$

where $0 \leq k, p \leq l$.

We verify the properties (E1)–(E5). The property (E2) is obvious. We verify (E1)(E3). We see

$$\begin{aligned} \varepsilon_1^A \left((\tilde{f}_0^A)^p \bar{b}_{(k,l)}^{l,0} \right) &= 0, \\ \varphi_1^A \left((\tilde{f}_0^A)^p \bar{b}_{(k,l)}^{l,0} \right) &= p + k. \end{aligned}$$

On the other hand,

$$\begin{aligned} & (\tilde{e}_2^G)^{l-k} \left[\left[\left[6 \right] \right]^p \left[\left[\bar{2} \right] \right]^{l-p} \right] \\ &= \begin{cases} \left[\left[\left[2 \right] \right]^{(l-k)/3} \left[\left[6 \right] \right]^{p-(l-k)/3} \left[\left[\bar{2} \right] \right]^{l-p} \right] & 0 \leq l-k \leq 3p, \quad l-k \equiv 0 \pmod{3} \\ \left[\left[\left[2 \right] \right]^{[(l-k)/3]} \left[\left[4 \right] \right] \left[\left[6 \right] \right]^{p-1-[(l-k)/3]} \left[\left[\bar{2} \right] \right]^{l-p} \right] & 0 < l-k < 3p, \quad l-k \equiv 1 \pmod{3} \\ \left[\left[\left[2 \right] \right]^{[(l-k)/3]} \left[\left[3 \right] \right] \left[\left[6 \right] \right]^{p-1-[(l-k)/3]} \left[\left[\bar{2} \right] \right]^{l-p} \right] & 0 < l-k < 3p, \quad l-k \equiv 2 \pmod{3} \\ \left[\left[\left[2 \right] \right]^p \left[\left[\bar{W} \right] \right]^{l-k-3p} \left[\left[\bar{2} \right] \right]^{k+2p} \right] & l-k > 3p \end{cases} \end{aligned}$$

Using Proposition 3.9, we have

$$\varepsilon_1 \left((\tilde{e}_2^G)^{l-k} \left[\left[\left[6 \right] \right]^p \left[\left[\bar{2} \right] \right]^{l-p} \right] \right) = 0, \quad (5.2.26)$$

$$\varphi_1 \left((\tilde{e}_2^G)^{l-k} \left[\left[\left[6 \right] \right]^p \left[\left[\bar{2} \right] \right]^{l-p} \right] \right) = p + k. \quad (5.2.27)$$

By calculation, we can verify (E4). We verify (E5). By (5.2.24) and (D1), we must have

$$\tilde{e}_0^G \left((\tilde{e}_2^G)^{l-k} \left[\left[\left[\bar{2} \right] \right]^l \right] \right) = 0 \quad (5.2.28)$$

□

By Definition 5.17 and (E1)', following definition is led.

Definition 5.18 *We define*

$$\Phi \left(\left(\tilde{f}_1^{\mathcal{A}} \right)^q \left(\tilde{f}_0^{\mathcal{A}} \right)^l \bar{b}_{(k,l)}^{l,0} \right) = \left(\tilde{f}_1^{\mathcal{G}} \right)^q \left(\Phi \left(\left(\tilde{f}_0^{\mathcal{A}} \right)^l \bar{b}_{(k,l)}^{l,0} \right) \right) \quad (0 \leq q \leq l+j).$$

We can verify (E1),(E2), (E3), (E4). We see easily

$$\tilde{f}_0^{\mathcal{A}} \left(\left(\tilde{f}_1^{\mathcal{A}} \right)^q \left(\tilde{f}_0^{\mathcal{A}} \right)^l \bar{b}_{(k,l)}^{l,0} \right) = 0 \quad (0 \leq q \leq l).$$

By (5.1.11), we see

$$\tilde{e}_0^{\mathcal{A}} \left(\left(\tilde{f}_1^{\mathcal{A}} \right)^q \left(\tilde{f}_0^{\mathcal{A}} \right)^l \bar{b}_{(k,l)}^{l,0} \right) = 0 \quad (l \leq q \leq l+j).$$

In order to satisfy (E4), we define

$$\begin{aligned} \tilde{f}_0^{\mathcal{G}} \left(\Phi \left(\left(\tilde{f}_1^{\mathcal{A}} \right)^q \left(\tilde{f}_0^{\mathcal{A}} \right)^l \bar{b}_{(k,l)}^{l,0} \right) \right) &= 0 \quad (0 \leq q \leq l), \\ \tilde{e}_0^{\mathcal{G}} \left(\Phi \left(\left(\tilde{f}_1^{\mathcal{A}} \right)^q \left(\tilde{f}_0^{\mathcal{A}} \right)^l \bar{b}_{(k,l)}^{l,0} \right) \right) &= 0 \quad (l \leq q \leq l+j). \end{aligned}$$

For $b \in B_{(k,j)}^i$ we define $y(b) \in \mathbf{Z}_{\geq 0}$ by

$$y(b) = \left\lfloor \frac{l-i-j}{3} \right\rfloor.$$

We often write y instead of $y(b)$ for simplicity.

Definition 5.19 *For $\bar{b}_{(l-i,j)}^{l,i}$, we define*

$$\Phi \left(\bar{b}_{(l-i,j)}^{l,i} \right) = \begin{cases} \left[[6]^y [C]^{y+i} [\bar{2}]^{y+i} [\bar{2}]^{j-i} \right] & l-i-j \equiv 0 \pmod{3}, \\ \left[[6]^{y+1} [C]^{y+i-1} [4] [\bar{2}]^{y+i} [\bar{2}]^{j-i} \right] & \left(\begin{array}{l} l-i-j \equiv 1 \pmod{3} \\ y+i > 0 \end{array} \right), \\ \left[[\bar{5}] [\bar{2}]^{j-i} \right] & \left(\begin{array}{l} l-i-j \equiv 1 \pmod{3} \\ y+i = 0 \end{array} \right), \\ \left[[6]^{y+1} [C]^{y+i} [\bar{3}] [\bar{2}]^{y+i} [\bar{2}]^{j-i} \right] & (l-i-j \equiv 2 \pmod{3}). \end{cases} \quad (5.2.29)$$

We verify the properties (E1)–(E5). We verify (E1) and (E3). We see easily

$$\tilde{e}_1^{\mathcal{A}} \left(\bar{b}_{(l-i,j)}^{l,i} \right) = 0, \quad \tilde{f}_1^{\mathcal{G}} \left(\bar{b}_{(l-i,j)}^{l,i} \right) = l-i.$$

By proposition 3.9, we have

$$\begin{aligned} \Psi_1 \left(\left[[6]^y [C]^{y+i} [\bar{2}]^{y+j} \right] \right) &= u_+^{y+j} u_-^{y+i} u_+^{y+i} u_+^{2y}, \\ \text{Red}_1 \left(\left[[6]^y [C]^{y+i} [\bar{2}]^{y+j} \right] \right) &= u_+^{l-i}. \end{aligned}$$

Then we have

$$\begin{aligned} \tilde{e}_1^{\mathcal{G}} \left(\left[[6]^y [C]^{y+i} [\bar{2}]^{y+j} \right] \right) &= 0, \\ \tilde{f}_1^{\mathcal{G}} \left(\left[[6]^y [C]^{y+i} [\bar{2}]^{y+j} \right] \right) &= l-i. \end{aligned}$$

In a similar way, we have

$$\begin{aligned}\tilde{e}_1^{\mathcal{G}}\left(\left[[6]^{y+1}[\mathcal{C}]^{y+i-1}[\overline{4}][\overline{2}]^{y+j}\right]\right) &= 0, & \tilde{f}_1^{\mathcal{G}}\left(\left[[6]^{y+1}[\mathcal{C}]^{y+i-1}[\overline{4}][\overline{2}]^{y+j}\right]\right) &= l-i, \\ \tilde{e}_1^{\mathcal{G}}\left(\left[[\overline{5}][\overline{2}]^{j-i}\right]\right) &= 0, & \tilde{f}_1^{\mathcal{G}}\left(\left[[\overline{5}][\overline{2}]^{j-i}\right]\right) &= l-i, \\ \tilde{e}_1^{\mathcal{G}}\left(\left[[6]^{y+1}[\mathcal{C}]^{y+i}[\overline{3}][\overline{2}]^{y+j}\right]\right) &= 0, & \tilde{e}_1^{\mathcal{G}}\left(\left[[6]^{y+1}[\mathcal{C}]^{y+i}[\overline{3}][\overline{2}]^{y+j}\right]\right) &= l-i,\end{aligned}$$

By calculation, we can verify (E2) and (E4). We verify (E5). We put $b = \left[[6]^y[\mathcal{C}]^{y+i}[\overline{2}]^{y+j}\right]$. By calculation and Lemma 5.17, we have

$$\begin{aligned}(\tilde{e}_2^{\mathcal{G}})^{2l-2i+j} b &= \left[[2]^{y(b)}[\mathcal{C}]^{y(b)+i}[\overline{6}]^{y(b)+j}\right], \\ (\tilde{e}_1^{\mathcal{G}})^{l+j} (\tilde{e}_2^{\mathcal{G}})^{2l-2i+j} b &= \left[[2]^{y(b)}[6]^{2y(b)+i+j}\right], \\ (\tilde{f}_2^{\mathcal{G}})^{l-i-j} (\tilde{e}_1^{\mathcal{G}})^{l+j} (\tilde{e}_2^{\mathcal{G}})^{2l-2i+j} b &= \left[[6]^l\right].\end{aligned}$$

By Definition 5.18, we must have

$$\Phi\left(\left(\tilde{f}_1^{\mathcal{A}}\right)^{l+j}\left(\tilde{f}_0^{\mathcal{A}}\right)^l \overline{b}_{(i+j,l)}^{l,0}\right) = \left[[2]^y[\mathcal{C}]^{y+i}[\overline{6}]^{y+j}\right],$$

$$\tilde{e}_0^{\mathcal{G}}\left[[2]^y[\mathcal{C}]^{y+i}[\overline{6}]^{y+j}\right] = 0.$$

By (D1), we must have

$$\tilde{e}_0^{\mathcal{G}}\left[[6]^y[\mathcal{C}]^{y+i}[\overline{2}]^{y+j}\right] = 0.$$

Similarly, we can prove other cases. □

Definition 5.20 We set $b = \overline{b}_{(l-i,j)}^{l,i}$. We define the action of Φ as follows:
If $0 \leq p \leq i$,

$$\Phi\left(\left(\tilde{f}_0^{\mathcal{A}}\right)^p b\right) = \begin{cases} \left[[1]^p[6]^y[\mathcal{C}]^{y+i-p}[\overline{2}]^{y+j}\right] & (l-i-j \equiv 0 \pmod{3}), \\ \left[[1]^p[6]^{y+1}[\mathcal{C}]^{y+i-p-1}[\overline{4}][\overline{2}]^{y+j}\right] & (y+i > p, l-i-j \equiv 1 \pmod{3}), \\ \left[[1]^i[\overline{5}][\overline{2}]^j\right] & (y+i = p, l-i-j \equiv 1 \pmod{3}), \\ \left[[1]^p[6]^{y+1}[\mathcal{C}]^{y+i-p}[\overline{3}][\overline{2}]^{y+j}\right] & (l-i-j \equiv 2 \pmod{3}), \end{cases}$$

if $i < p \leq j$,

$$\Phi\left(\left(\tilde{f}_0^{\mathcal{A}}\right)^p b\right) = \begin{cases} \left[[1]^i[6]^{p-i+y}[\mathcal{C}]^y[\overline{2}]^{y+j-p+i}\right] & (l-i-j \equiv 0 \pmod{3}), \\ \left[[1]^i[6]^{p-i+y+1}[\mathcal{C}]^{y-1}[\overline{4}][\overline{2}]^{y+j-p+i}\right] & (y > 0, l-i-j \equiv 1 \pmod{3}), \\ \left[[1]^i[6]^{p-i}[\overline{5}][\overline{2}]^{j-p+i}\right] & (y = 0, l-i-j \equiv 1 \pmod{3}), \\ \left[[1]^i[6]^{p-i+y+1}[\mathcal{C}]^y[\overline{3}][\overline{2}]^{y+j-p+i}\right] & (l-i-j \equiv 2 \pmod{3}). \end{cases}$$

By calculation, we can verify (E1)–(E4). In order to satisfy (E5), we define $\tilde{e}_0^{\mathcal{G}}$ on $\Phi\left(\left(\tilde{f}_1^A\right)^p\left(\tilde{f}_0^A\right)^p\bar{b}_{(l-i,j)}^{l,i}\right)$ ($0 \leq p \leq j$) and $\tilde{f}_0^{\mathcal{G}}$ on $\Phi\left(\left(\tilde{f}_1^A\right)^q\left(\tilde{f}_0^A\right)^j\bar{b}_{(l-i,j)}^{l,i}\right)$ ($0 \leq q \leq j$).

Using Proposition 5.14, 5.15 and (E2), it is enough to define the action of Φ on $B_C \cup B_R$.

By (E1)', we are led to the following definition.

Definition 5.21 *We define*

$$\Phi\left(\left(\tilde{f}_1^A\right)^q\left(\tilde{f}_0^A\right)^p\bar{b}_{(l-i,j)}^{l,i}\right) = \left(\tilde{f}_1^{\mathcal{G}}\right)^q\left(\Phi\left(\left(\tilde{f}_0^A\right)^p\bar{b}_{(l-i,j)}^{l,i}\right)\right),$$

where ($0 \leq p \leq j$, $0 \leq q \leq y + j - (i - p)_+$).

Thus we have defined $\Phi(b)$ where $b \in B_C \cup B_R$.

Definition 5.22 *For $b = \llbracket [b_1] \cdots [b_n] \rrbracket \in B^{G_2}(n\Lambda_1)$ ($0 \leq n \leq l$), we define the involution on \mathcal{G}^l by*

$$C_{\mathcal{G}}(b) = \llbracket [\bar{b}_n] \cdots [\bar{b}_1] \rrbracket,$$

where if $b_i = \bar{m}$ ($m = 1, \dots, 6$) then $[\bar{b}_i] = [m]$, if $b_i = 0_1, 0_2$, then $[\bar{b}_i] = [b_i]$.

Remark 5.23 *Let \bar{b} (resp. \underline{b}) be the highest (resp. lowest) weight element of $B^{G_2}(l\Lambda_1)$. By Proposition 3.9, 3.14 and 3.15, we have*

$$\bar{b} = \llbracket [1] \rrbracket^l,$$

$$\underline{b} = \llbracket [\bar{1}] \rrbracket^l.$$

By Definition 5.22, we have

$$C_{\mathcal{G}}(\bar{b}) = \underline{b}.$$

Using Proposition 3.9 again, we see

$$C_{\mathcal{G}}\left(\tilde{f}_{i_N} \cdots \tilde{f}_{i_1} \bar{b}\right) = \tilde{e}_{i_N} \cdots \tilde{e}_{i_1} \underline{b}.$$

Definition 5.24 *We define Φ for $b \in B_C \cup B_R$*

$$\Phi(E_{\mathcal{A}}^m b) = \left(\tilde{e}_2^{\mathcal{G}}\right)^m (\Phi(b)) \quad (0 \leq m \leq \varepsilon_{\mathcal{A}}(b)). \quad (5.2.30)$$

We define Φ for $b \in B_W \cup B_U$,

$$\Phi(E_{\mathcal{A}}^m b) = C_{\mathcal{G}}\left(\Phi\left(C_{\mathcal{A}}\left(E_{\mathcal{A}}^m b\right)\right)\right) \quad (0 \leq m \leq \varepsilon_{\mathcal{A}}(b)). \quad (5.2.31)$$

For $b \in B_R$, we define

$$\Phi\left(E_{\mathcal{A}}^m\left(\left(\tilde{f}_0^A\right)^{\varphi_0(b)}(b)\right)\right) = C_{\mathcal{G}}\left(\Phi\left(F_{\mathcal{A}}^{\varepsilon_{\mathcal{A}}(b)-m} C_{\mathcal{A}}(b)\right)\right). \quad (5.2.32)$$

Remark 5.25 *By Definition 5.24, we see that the relation (5.2.30) satisfies (E2). By (5.2.30) and Proposition 5.14, we see that $C_{\mathcal{A}}(E_{\mathcal{A}}^m b)$ is already defined. By (5.2.31), We see $C_{\mathcal{A}}(C_{\mathcal{A}}(E_{\mathcal{A}}^m b)) = b$ ($0 \leq m \leq \varepsilon_{\mathcal{A}}(b)$).*

We have defined $\Phi(b)$ where $b \in \mathcal{A}^{(l)}$.

Proposition 5.26 For $b \in \mathcal{A}^{(l)}$,

$$C_{\mathcal{G}}(\Phi(b)) = \Phi(C_{\mathcal{A}}(b)).$$

Proof We put $b = (\tilde{f}_1^A)^q (\tilde{f}_0^A)^j \bar{b}_{(l-i,j)}^{l,i}$. By (5.2.12), (5.2.13) and (5.2.14),

$$E_{\mathcal{A}}^{\varepsilon_{\mathcal{A}}(b)} \left((\tilde{e}_0^A)^{j-q} b \right) = \begin{cases} (\tilde{f}_1^A)^{l+j-2q} (\tilde{f}_0^A)^{l-q} \bar{b}_{(j+i-q,l-q)}^{l,q} & \text{if } 0 \leq q \leq \left\lfloor \frac{i+j}{2} \right\rfloor, \\ (\tilde{f}_1^A)^{l+j-2q} (\tilde{f}_0^A)^{l-i-j+q} \bar{b}_{(2i+2j-3q,l-2i-2j+3q)}^{l,2i+2j-3q} & \text{if } \left\lfloor \frac{i+j}{2} \right\rfloor < q \leq \frac{2j+i}{3}, \\ (\tilde{f}_1^A)^{l-i-j+q} (\tilde{f}_0^A)^{l-i-j+q} \bar{b}_{(-2j+3q,l-i)}^{l,i} & \text{if } \frac{2j+i}{3} < q \leq j. \end{cases} \quad (5.2.33)$$

If $0 \leq q \leq \left\lfloor \frac{i+j}{2} \right\rfloor$,

$$\begin{aligned} \Phi \left((\tilde{f}_0^A)^j \bar{b}_{(l-i,j)}^{l,i} \right) &= \left[[1] \right]^i [6]^{j-i+y} [C] \left[\bar{2} \right]^{y+i}, \\ \Phi \left((\tilde{f}_1^A)^q (\tilde{f}_0^A)^j \bar{b}_{(l-i,j)}^{l,i} \right) &= \begin{cases} \left[[1] \right]^i [6]^{j-i+y} [C] \left[\bar{2} \right]^{y+i-q} [\bar{1}]^q & (i > q), \\ \left[[1] \right]^i [6]^{j-q+y} [C]^{y+q-i} [\bar{2}]^y [\bar{1}]^i & (i \leq q), \end{cases} \\ \Phi \left(E_{\mathcal{A}}^{\varepsilon_{\mathcal{A}}(b)} \left((\tilde{f}_1^A)^q (\tilde{f}_0^A)^j \bar{b}_{(l-i,j)}^{l,i} \right) \right) &= \begin{cases} \left[[1] \right]^i [2]^{j-i+y} [C] \left[\bar{6} \right]^{y+i-q} [\bar{1}]^q & (i > q), \\ \left[[1] \right]^i [2]^{j-q+y} [C]^{y+q-i} [\bar{6}]^y [\bar{1}]^i & (i \leq q), \end{cases} \\ C_{\mathcal{G}} \left(\Phi \left(E_{\mathcal{A}}^{\varepsilon_{\mathcal{A}}(b)} \left((\tilde{f}_1^A)^q (\tilde{f}_0^A)^j \bar{b}_{(l-i,j)}^{l,i} \right) \right) \right) &= \begin{cases} \left[[1] \right]^q [6]^{i-q+y} [C] \left[\bar{2} \right]^{y+j-i} [\bar{1}]^i & (i > q), \\ \left[[1] \right]^i [6]^y [C]^{y+q-i} [\bar{2}]^{y+j-q} [\bar{1}]^i & (i \leq q). \end{cases} \end{aligned}$$

On the other hand,

$$\begin{aligned} \Phi \left((\tilde{f}_0^A)^i \bar{b}_{(l-q,i+j-q)}^{l,q} \right) &= \begin{cases} \left[[1] \right]^q [6]^{i-q+y} [C] \left[\bar{2} \right]^{y+j} & (i > q), \\ \left[[1] \right]^i [6]^y [C]^{y+q-i} [\bar{2}]^{y+j+i-q} & (i \leq q), \end{cases} \\ \Phi \left(C_{\mathcal{A}} \left(E_{\mathcal{A}}^{\varepsilon_{\mathcal{A}}(b)} b \right) \right) &= \Phi \left((\tilde{f}_1^A)^i (\tilde{f}_0^A)^i \bar{b}_{(l-q,i+j-q)}^{l,q} \right) \\ &= \begin{cases} \left[[1] \right]^q [6]^{i-q+y} [C] \left[\bar{2} \right]^{y+j-i} [\bar{1}]^i & (i > q), \\ \left[[1] \right]^i [6]^y [C]^{y+q-i} [\bar{2}]^{y+j-q} [\bar{1}]^i & (i \leq q). \end{cases} \end{aligned}$$

By (5.2.31), we have

$$C_{\mathcal{G}}(\Phi(E_{\mathcal{A}}^m b)) = \Phi(C_{\mathcal{A}}(E_{\mathcal{A}}^m b)) \quad (0 \leq m \leq \varepsilon_0(b))$$

In a similar way, we can calculate other cases. \square

Definition 5.27 For $b \in \mathcal{G}^l$, we define $\tilde{f}_0^{\mathcal{G}}(b)$ and $\tilde{e}_0^{\mathcal{G}}(b)$ by

$$\tilde{f}_0^{\mathcal{G}}(b) = \Phi \tilde{f}_0^A \Phi^{-1}(b),$$

$$\tilde{e}_0^{\mathcal{G}}(b) = \Phi \tilde{e}_0^{\mathcal{A}} \Phi^{-1}(b).$$

We define $\varepsilon_0^{\mathcal{G}}(b)$ and $\varphi_0^{\mathcal{G}}(b)$ by

$$\begin{aligned}\varepsilon_0^{\mathcal{G}}(b) &= \max \left\{ n \mid (\tilde{e}_0^{\mathcal{G}})^n b \neq 0 \right\}, \\ \varphi_0^{\mathcal{G}}(b) &= \max \left\{ n \mid (\tilde{f}_0^{\mathcal{G}})^n b \neq 0 \right\}.\end{aligned}$$

By (C2), it is obvious that $\tilde{f}_0^{\mathcal{G}} = \Phi \tilde{f}_0^{\mathcal{A}} \Phi^{-1}$, $\tilde{e}_0^{\mathcal{G}} = \Phi \tilde{e}_0^{\mathcal{A}} \Phi^{-1}$ satisfy (D1).

Remark 5.28 *By Definition 5.27, for $b \in \mathcal{A}$ we have*

$$\begin{aligned}\varepsilon_0^{\mathcal{G}}(\Phi(b)) &= \varepsilon_0^{\mathcal{A}}(b), \\ \varphi_0^{\mathcal{G}}(\Phi(b)) &= \varphi_0^{\mathcal{A}}(b).\end{aligned}$$

Proposition 5.29 *The action of $\tilde{f}_0^{\mathcal{G}}$ is unique.*

Proof Let Φ, Φ' be one-to-one maps $\mathcal{A} \rightarrow \mathcal{G}^l$ which satisfy conditions (E1)(E2)(E3) in §5.2.4. Here, by (E2) we have $\Phi F_{\mathcal{A}} = \tilde{f}_2^{\mathcal{G}} \Phi$, $\Phi' F_{\mathcal{A}} = \tilde{f}_2^{\mathcal{G}} \Phi'$. We see that if for $b \in \mathcal{A}$

$$\Phi(\tilde{f}_0^{\mathcal{A}} b) \neq \Phi'(\tilde{f}_0^{\mathcal{A}} b), \quad \text{for some } b \in \mathcal{A}$$

we have

$$\Phi \left(\tilde{f}_0^{\mathcal{A}} F_{\mathcal{A}}^{\varphi_{\mathcal{A}}(b)}(b) \right) \neq \Phi' \left(\tilde{f}_0^{\mathcal{A}} F_{\mathcal{A}}^{\varphi_{\mathcal{A}}(b)}(b) \right).$$

Therefore it is sufficient to verify that $\Phi(b)$ is unique, for $b \in \mathcal{A}$ such that $F_{\mathcal{A}}(b) = 0$. By (E1), $\Phi \tilde{f}_1^{\mathcal{A}} = \tilde{f}_1^{\mathcal{G}} \Phi$, then it is enough to verify that

$$\Phi \left(\left(\tilde{f}_0^{\mathcal{A}} \right)^p \bar{b}_{(l-i,j)}^{l,i} \right) \quad \left(0 \leq i \leq \left\lfloor \frac{l}{2} \right\rfloor, 0 \leq j \leq l-i, 0 \leq p \leq j \right)$$

is unique. This is obvious by Proposition 5.20. \square

The affine crystal B^l which is constructed with \mathcal{G} and $\tilde{f}_0^{\mathcal{G}}$ satisfies Proposition 2.1.

5.3 Proof of commutativity of $\Phi \tilde{f}_1^{\mathcal{A}} = \tilde{f}_1^{\mathcal{G}} \Phi$

In this section we prove (E1) in §5.2.4, namely for $b \in \mathcal{A}$

$$\begin{array}{ccc} b & \longrightarrow & \Phi(b) \\ \downarrow & & \downarrow \\ \tilde{f}_1^{\mathcal{A}} b & \longrightarrow & \tilde{f}_1^{\mathcal{G}}(\Phi(b)). \end{array}$$

In the proof of commutativity we use $\tilde{e}_1^{\mathcal{A}}$, $\tilde{e}_1^{\mathcal{G}}$ instead of $\tilde{f}_1^{\mathcal{A}}$, $\tilde{f}_1^{\mathcal{G}}$ respectively. Consider an $E_{\mathcal{A}}$ -string b , $E_{\mathcal{A}}(b), \dots, E_{\mathcal{A}}^{\varphi_{\mathcal{A}}(b)}(b)$, where $b \in \mathcal{A}$ is \mathcal{A} -terminal. For any $b \in \mathcal{A}$, we can denote

$$b = E_{\mathcal{A}}^{n'} b',$$

where $n' \in \mathbf{Z}_{\geq 0}$, $b' \in \mathcal{A}$ is an \mathcal{A} -terminal element, namely $F_{\mathcal{A}}(b') = 0$. Similarly, we can denote

$$\tilde{e}_1^{\mathcal{A}} b = E_{\mathcal{A}}^{n''} b'',$$

where $n'' \in \mathbf{Z}_{\geq 0}$, $b'' \in \mathcal{A}$ is an \mathcal{A} -terminal element. In order to show (E1), we will verify

$$\tilde{e}_1^{\mathcal{G}} \left(\Phi \left(E_{\mathcal{A}}^{n'} b' \right) \right) = \Phi \left(E_{\mathcal{A}}^{n''} b'' \right). \quad (5.3.1)$$

Let us define \mathcal{A}_+ , \mathcal{A}_- by

$$\mathcal{A}_+ = \bigoplus_{i=0}^{\lfloor \frac{l}{2} \rfloor} \bigoplus_{i \leq k \leq j \leq l-i} B_{(k,j)}^i,$$

$$\mathcal{A}_- = \bigoplus_{i=0}^{\lfloor \frac{l}{2} \rfloor} \bigoplus_{i \leq j < k \leq l-i} B_{(k,j)}^i.$$

For $b' \in \mathcal{A}_+$ such that $E_{\mathcal{A}}(b') \in \mathcal{A}_-$, we see that the action of $E_{\mathcal{A}}$ is given by (a3) or (a4) or (a5). We take $b = \left(\tilde{f}_1^{\mathcal{A}}\right)^q \left(\tilde{f}_0^{\mathcal{A}}\right)^p \bar{b}_{(l-i,j)}^{l,i} \in B_C$ ($0 \leq q \leq p \leq j$), which is an \mathcal{A} -terminal element of an $E_{\mathcal{A}}$ -string. By consulting the proof of (C3) in §5.2.2, we see that for b the action of $E_{\mathcal{A}}$ has following relations, using sequence depending b , $0 \leq n_1 \leq n_2 \leq \dots \leq n_6 = \varepsilon_{\mathcal{A}}(b)$.

the action of $E_{\mathcal{A}}$ on $E_{\mathcal{A}}^{n'} b$ ($0 \leq n' < n_1$) is given by (a1), if $n_1 \neq 0$,
the action of $E_{\mathcal{A}}$ on $E_{\mathcal{A}}^{n'} b$ ($n_1 \leq n' < n_2$) is given by (a3), if $n_1 < n_2$,
the action of $E_{\mathcal{A}}$ on $E_{\mathcal{A}}^{n'} b$ ($n_2 \leq n' < n_3$) is given by (a4), if $n_2 < n_3$,
the action of $E_{\mathcal{A}}$ on $E_{\mathcal{A}}^{n'} b$ ($n_3 \leq n' < n_4$) is given by (a5), if $n_3 < n_4$,
the action of $E_{\mathcal{A}}$ on $E_{\mathcal{A}}^{n'} b$ ($n_4 \leq n' < n_5$) is given by (a2), if $n_4 < n_5$,
the action of $E_{\mathcal{A}}$ on $E_{\mathcal{A}}^{n_6} b$ is given by (a6).

Then we see that the number $\bar{n}(b) \in \mathbf{Z}_{\geq 0}$ which satisfy following condition is at most one:

$$E_{\mathcal{A}}^{\bar{n}(b)} b \in \mathcal{A}_+,$$

$$E_{\mathcal{A}}^{\bar{n}(b)+1} b \in \mathcal{A}_-.$$

If there does not exist such $\bar{n}(b)$, we put

$$\bar{n}(b) = \varepsilon_{\mathcal{A}}(b) = 2l - 2i + j - 3q.$$

By Proposition 5.13 and induction (5.2.6) it is sufficient to prove (5.3.1) for $b' = E_{\mathcal{A}}^n b$ ($0 \leq n \leq \bar{n}(b)$, $b \in B_C$).

5.3.1 Actions of $\tilde{e}_1^{\mathcal{A}}$

Proposition 5.30 For $\left(\tilde{f}_1^{\mathcal{A}}\right)^q \left(\tilde{f}_0^{\mathcal{A}}\right)^p \bar{b}_{(l-i,j)}^{l,i} \in B_C$ ($0 \leq q \leq p \leq j$), we have following relations.

Put $b_1 = \left(\tilde{f}_1^{\mathcal{A}}\right)^q \left(\tilde{f}_0^{\mathcal{A}}\right)^p \bar{b}_{(l-i,j)}^{l,i}$ ($3q \geq i + 2j - \lfloor \frac{i-j}{2} \rfloor$, $p + 2q > i + 2j$). We have

$$\tilde{e}_1^{\mathcal{A}}(E_{\mathcal{A}}^n b_1) = E_{\mathcal{A}}^n \left(\left(\tilde{f}_1^{\mathcal{A}}\right)^{q-1} \left(\tilde{f}_0^{\mathcal{A}}\right)^p \bar{b}_{(l-i,j)}^{l,i} \right), \quad (5.3.2)$$

$$\tilde{e}_1^{\mathcal{A}} \left(E_{\mathcal{A}}^{l-i-j+3(j-q)+1} b_1 \right) = E_{\mathcal{A}}^{l-i-j+3(j-q)} \left(\left(\tilde{f}_1^{\mathcal{A}}\right)^q \left(\tilde{f}_0^{\mathcal{A}}\right)^{p+1} \bar{b}_{(l-i,j+1)}^{l,i} \right), \quad (5.3.3)$$

$$\tilde{e}_1^{\mathcal{A}} \left(E_{\mathcal{A}}^{l-i-j+3(j-q)+2} b_1 \right) = E_{\mathcal{A}}^{l-i-j+3(j-q)} \left(\left(\tilde{f}_1^{\mathcal{A}}\right)^{q+1} \left(\tilde{f}_0^{\mathcal{A}}\right)^{p+2} \bar{b}_{(l-i,j+2)}^{l,i} \right), \quad (5.3.4)$$

$$\tilde{e}_1^{\mathcal{A}} \left(E_{\mathcal{A}}^{l-i-j+3(j-q)+n'} b_1 \right) = E_{\mathcal{A}}^{l-i-j+3(j-q)+n'} \left(\left(\tilde{f}_1^{\mathcal{A}}\right)^{q+2} \left(\tilde{f}_0^{\mathcal{A}}\right)^{p+3} \bar{b}_{(l-i,j+3)}^{l,i} \right), \quad (5.3.5)$$

where $0 \leq n \leq l - j - i + 3(j - q)$, $0 \leq n' \leq 3(y - 1)$, $y = \lfloor \frac{l-i-j}{3} \rfloor$.

Put $b_2 = \left(\tilde{f}_1^{\mathcal{A}}\right)^q \left(\tilde{f}_0^{\mathcal{A}}\right)^p \bar{b}_{(l-i,j)}^{l,i}$ ($p - q \leq \lfloor \frac{i-j}{2} \rfloor$, $p + 2q \leq i + 2j$). We have

$$\tilde{e}_1^{\mathcal{A}}(E_{\mathcal{A}}^n b_2) = E_{\mathcal{A}}^n \left(\left(\tilde{f}_1^{\mathcal{A}}\right)^{q-1} \left(\tilde{f}_0^{\mathcal{A}}\right)^p \bar{b}_{(l-i,j)}^{l,i} \right), \quad (5.3.6)$$

$$\tilde{e}_1^{\mathcal{A}} \left(E_{\mathcal{A}}^{l-2i+\lfloor (j-i)/2 \rfloor - n'} b_2 \right) = E_{\mathcal{A}}^{l-2i+\lfloor (j-i)/2 \rfloor - 3 - n'} \left(\left(\tilde{f}_1^{\mathcal{A}}\right)^q \left(\tilde{f}_0^{\mathcal{A}}\right)^p \bar{b}_{(l-(i+1),j-1)}^{l,i+1} \right), \quad (5.3.7)$$

where $0 \leq n \leq l - 2i + p - q$, $0 \leq n' \leq \lceil \frac{j-i}{2} \rceil$.

Put $b_3 = \left(\tilde{f}_1^{\mathcal{A}}\right)^q \left(\tilde{f}_0^{\mathcal{A}}\right)^p \bar{b}_{(l-i,j)}^{l,i}$ ($3q < i + 2j - \lceil \frac{j-i}{2} \rceil$, $\lceil \frac{j-i}{2} \rceil < p - q$), then we have

$$\tilde{e}_1^{\mathcal{A}}(E_{\mathcal{A}}^n b_3) = E_{\mathcal{A}}^n \left(\left(\tilde{f}_1^{\mathcal{A}}\right)^{q-1} \left(\tilde{f}_0^{\mathcal{A}}\right)^p \bar{b}_{(l-i,j)}^{l,i} \right), \quad (5.3.8)$$

where $0 \leq n \leq l - 2i + \lceil \frac{j-i}{2} \rceil$.

Proof We consider the action of $\tilde{e}_1^{\mathcal{A}}$ for $\left(\tilde{f}_0^{\mathcal{A}}\right)^r \left(\tilde{f}_1^{\mathcal{A}}\right)^q \left(\tilde{f}_0^{\mathcal{A}}\right)^p \bar{b}_{(k,j)}^{l,i}$ ($0 \leq p \leq j, p \leq q \leq p + k, 0 \leq r \leq j + q - 2p$). By Proposition 5.4, if $q = p$ we have

$$\tilde{e}_1^{\mathcal{A}} \left(\tilde{f}_0^{\mathcal{A}}\right)^r \left(\tilde{f}_1^{\mathcal{A}}\right)^p \left(\tilde{f}_0^{\mathcal{A}}\right)^p \bar{b}_{(k,j)}^{l,i} = \left(\tilde{f}_0^{\mathcal{A}}\right)^r \left(\tilde{f}_1^{\mathcal{A}}\right)^{p-1} \left(\tilde{f}_0^{\mathcal{A}}\right)^p \bar{b}_{(k,j)}^{l,i}$$

where $0 \leq r \leq j - p$. If $q > p$,

$$\tilde{e}_1^{\mathcal{A}} \left(\tilde{f}_0^{\mathcal{A}}\right)^r \left(\tilde{f}_1^{\mathcal{A}}\right)^p \left(\tilde{f}_0^{\mathcal{A}}\right)^p \bar{b}_{(k,j)}^{l,i} \neq \left(\tilde{f}_0^{\mathcal{A}}\right)^r \left(\tilde{f}_1^{\mathcal{A}}\right)^{p-1} \left(\tilde{f}_0^{\mathcal{A}}\right)^p \bar{b}_{(k,j)}^{l,i}$$

where $q - p \leq r \leq j + q - 2p$.

We consider the case of $q = p$ in part I, and the case of $q > p$ in part II.

Part I We consider $\left(\tilde{f}_0^{\mathcal{A}}\right)^r \left(\tilde{f}_1^{\mathcal{A}}\right)^p \left(\tilde{f}_0^{\mathcal{A}}\right)^p \bar{b}_{(k,j)}^{l,i}$ ($0 \leq p \leq j, 0 \leq r \leq j - p$).

We define $b, b' \in B_{(k,j)}^i$ by

$$\begin{aligned} b &= \left(\tilde{f}_1^{\mathcal{A}}\right)^p \left(\tilde{f}_0^{\mathcal{A}}\right)^p \bar{b}_{(k,j)}^{l,i}, \\ b' &= \begin{cases} \left(\tilde{f}_1^{\mathcal{A}}\right)^{p-1} \left(\tilde{f}_0^{\mathcal{A}}\right)^{p-1} \bar{b}_{(k,j)}^{l,i} & (p > 0) \\ 0 & (p = 0) \end{cases}. \end{aligned}$$

Then by Proposition 5.3 we have

$$\tilde{e}_1^{\mathcal{A}} \left(\tilde{f}_0^{\mathcal{A}}\right)^r b = \left(\tilde{f}_0^{\mathcal{A}}\right)^{r+1} b',$$

(Figure 2). We define m_b by

$$m_b = j - k - 3(j - p) = -2j - k + 3p,$$

We consider an $E_{\mathcal{A}}$ -string. We can express b using an \mathcal{A} -terminal element. By Definition 5.12, we have

$$b = E_{\mathcal{A}}^{l-i-k+(m_b)_+} \left(\left(\tilde{f}_1^{\mathcal{A}}\right)^{p-(m_b)_+} \left(\tilde{f}_0^{\mathcal{A}}\right)^p \bar{b}_{(l-i,j-(m_b)_+)}^{l,i} \right) \quad (5.3.9)$$

If $m_b < 0$ the action of $E_{\mathcal{A}}$ is given by (a1) or (a3) of Definition 5.12, and if $m_b \geq 0$ the action is given by (a2).

The case of (a1): $E_{\mathcal{A}} b \in B_{(k-1,j)}^i$.

This case is $b = E_{\mathcal{A}}^{n'} b_1$ ($0 \leq n' < \min\{l - 2i, l - i + 2j - 3q\}$), $b = E_{\mathcal{A}}^{n'} b_2$ ($0 \leq n' < l - 2i$), $b = E_{\mathcal{A}}^{n'} b_3$ ($0 \leq n' < l - 2i$).

If $p = 0$, we have

$$\tilde{e}_1^{\mathcal{A}} E_{\mathcal{A}} b = 0.$$

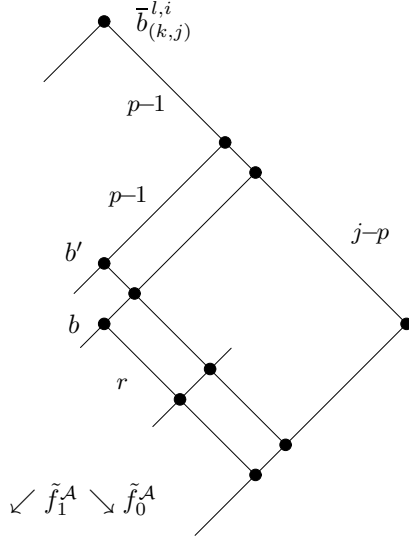

Figure 2: Part I, the location of b and b' in the crystal graph of $B_{(k,j)}^i$.

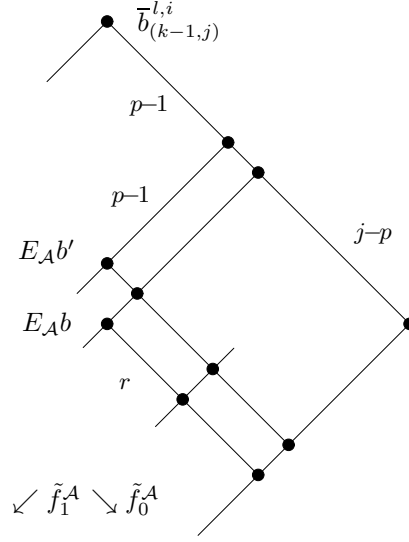

Figure 3: Part I, the case of (a1), the location of $E_{A}b$ and $E_{A}b'$ in the crystal graph of $B_{(k-1,j)}^i$.

If $p > 0$, since $m_b < 0$, we have $m_{b'} < 0$. Then the actions of E_A for b' is given by (a1). Then we have

$$\begin{aligned} E_A b &= \left(\tilde{f}_0^A\right)^p \left(\tilde{f}_1^A\right)^p \bar{b}_{(k-1,j)}^{l,i}, \\ E_A b' &= \left(\tilde{f}_0^A\right)^{p-1} \left(\tilde{f}_1^A\right)^{p-1} \bar{b}_{(k-1,j)}^{l,i}, \end{aligned}$$

(Figure 3). Then we obtain

$$\tilde{e}_1^A E_A \left(\left(\tilde{f}_0^A \right)^r b \right) = E_A \left(\left(\tilde{f}_0^A \right)^{r+1} b' \right). \quad (5.3.10)$$

We have the case of $(0 \leq n \leq \min\{l-2i, l-i+2j-3q\})$ of (5.3.2), the case of $(0 \leq n \leq l-2i)$ of (5.3.6), and the case of $(0 \leq n \leq l-2i)$ of (5.3.8),

The case of (a2): $E_A b \in B_{(k,j+1)}^i$.

This case is $b = E_{A'}^{n'} b_1$ ($l-i+2j-3q \leq n' < 2l-2i+j-3q, l-i+2j-3q < l-2i$).

We denote

$$E_A b = \left(\tilde{f}_1^A\right)^{p+1} \left(\tilde{f}_0^A\right)^{p+1} \bar{b}_{(k,j+1)}^{l,i}.$$

if $m_b = 0, 1, 2$, since $m_{b'} < 0 \leq m_b$, then the action of E_A for b' is given by (a1). Then we have

$$E_A b' = \left(\tilde{f}_1^A\right)^{p-1} \left(\tilde{f}_0^A\right)^{p-1} \bar{b}_{(k-1,j)}^{l,i}.$$

Therefore, we have

$$\tilde{e}_1^A E_A \left(\left(\tilde{f}_0^A \right)^r b \right) \neq E_A \left(\left(\tilde{f}_0^A \right)^{r+1} b' \right).$$

By (5.3.9), we have

$$\tilde{e}_1^{\mathcal{A}} E_{\mathcal{A}} \left(\left(\tilde{f}_0^{\mathcal{A}} \right)^r b \right) = E_{\mathcal{A}}^{l-i-k} \left(\left(\tilde{f}_0^{\mathcal{A}} \right)^{r+1} \left(\tilde{f}_1^{\mathcal{A}} \right)^p \left(\tilde{f}_0^{\mathcal{A}} \right)^p \bar{b}_{(l-i, j+1)}^{l, i} \right).$$

if $m_b \geq 3$, then the action of $E_{\mathcal{A}}$ for b' is given by (a2), since $0 \leq m_{b'} < m_b$. Thus we have

$$E_{\mathcal{A}} b' = \left(\tilde{f}_1^{\mathcal{A}} \right)^p \left(\tilde{f}_0^{\mathcal{A}} \right)^p \bar{b}_{(k, j+1)}^{l, i},$$

(Figure 4). Therefore, we have

$$\begin{aligned} \tilde{e}_1^{\mathcal{A}} E_{\mathcal{A}} \left(\left(\tilde{f}_0^{\mathcal{A}} \right)^r b \right) &= E_{\mathcal{A}} \left(\left(\tilde{f}_0^{\mathcal{A}} \right)^{r+1} b' \right) \\ &= E_{\mathcal{A}}^{l-i-k+m_b-2} \left(\left(\tilde{f}_0^{\mathcal{A}} \right)^{r+1} \left(\tilde{f}_1^{\mathcal{A}} \right)^{p-m_b+2} \left(\tilde{f}_0^{\mathcal{A}} \right)^p \bar{b}_{(l-i, j-m_b+3)}^{l, i} \right). \end{aligned} \quad (5.3.11)$$

Therefore we have (5.3.3), (5.3.4), (5.3.5), if $l-i+2j-3q < l-2i$.

The case of (a3): $E_{\mathcal{A}} b \in B_{(i+1, j-1)}^{i+1}$.

This case is $b = E_{\mathcal{A}}^{l-2i} b_1$, $b = E_{\mathcal{A}}^{l-2i} b_2$, $b = E_{\mathcal{A}}^{l-2i} b_3$.

We denote

$$E_{\mathcal{A}} b = \left(\tilde{f}_1^{\mathcal{A}} \right)^{p+1} \left(\tilde{f}_0^{\mathcal{A}} \right)^p \bar{b}_{(k+1, j-1)}^{l, i+1},$$

Since $m_{b'} < m_b < 0$ the actions of $E_{\mathcal{A}}$ for b' is given by (a3). Then we have

$$E_{\mathcal{A}} b' = \left(\tilde{f}_1^{\mathcal{A}} \right)^p \left(\tilde{f}_0^{\mathcal{A}} \right)^{p-1} \bar{b}_{(k+1, j-1)}^{l, i+1}.$$

Here by Proposition 5.4 we have

$$\begin{aligned} \tilde{e}_1^{\mathcal{A}} \left(\tilde{f}_0^{\mathcal{A}} \right)^r \left(\tilde{f}_1^{\mathcal{A}} \right)^{p+1} \left(\tilde{f}_0^{\mathcal{A}} \right)^p \bar{b}_{(k, j)}^{l, i} &= \left(\tilde{f}_0^{\mathcal{A}} \right)^{r+1} \left(\tilde{f}_1^{\mathcal{A}} \right)^p \left(\tilde{f}_0^{\mathcal{A}} \right)^{p-1} \bar{b}_{(k, j)}^{l, i} \neq \left(\tilde{f}_0^{\mathcal{A}} \right)^r \left(\tilde{f}_1^{\mathcal{A}} \right)^p \left(\tilde{f}_0^{\mathcal{A}} \right)^q \bar{b}_{(k, j)}^{l, i} \quad (r > 0), \\ \tilde{e}_1^{\mathcal{A}} \left(\tilde{f}_1^{\mathcal{A}} \right)^{p+1} \left(\tilde{f}_0^{\mathcal{A}} \right)^p \bar{b}_{(k, j)}^{l, i} &= \left(\tilde{f}_1^{\mathcal{A}} \right)^p \left(\tilde{f}_0^{\mathcal{A}} \right)^p \bar{b}_{(k, j)}^{l, i} \neq \tilde{f}_0^{\mathcal{A}} \left(\tilde{f}_1^{\mathcal{A}} \right)^p \left(\tilde{f}_0^{\mathcal{A}} \right)^{p-1} \bar{b}_{(k, j)}^{l, i}, \end{aligned}$$

(Figure 5). Then we have

$$\tilde{e}_1^{\mathcal{A}} \left(\tilde{f}_0^{\mathcal{A}} \right)^r E_{\mathcal{A}} b = \left(\tilde{f}_0^{\mathcal{A}} \right)^{r+1} E_{\mathcal{A}} b' \quad (r > 0), \quad (5.3.12)$$

$$\tilde{e}_1^{\mathcal{A}} E_{\mathcal{A}} b = E_{\mathcal{A}}^{l-2(i+1)} \left(\left(\tilde{f}_1^{\mathcal{A}} \right)^p \left(\tilde{f}_0^{\mathcal{A}} \right)^p \bar{b}_{(l-i-1, j-1)}^{l, i+1} \right). \quad (5.3.13)$$

Therefore we have the case of $n = l - 2i + 1$ of (5.3.2), (5.3.6), (5.3.8).

Part II. We consider $\tilde{e}_1^{\mathcal{A}} E_{\mathcal{A}} \left(\tilde{f}_0^{\mathcal{A}} \right)^r \left(\tilde{f}_1^{\mathcal{A}} \right)^{p+s} \left(\tilde{f}_0^{\mathcal{A}} \right)^p \bar{b}_{(k, j)}^{l, i}$ ($i \leq k, j \leq l-i, k-i \geq s > 0$)

If $i < k, j \leq l-i$, we use induction (5.2.6). Otherwise, using involution, we have

$$C_{\mathcal{A}} \left(\bar{b}_{(j, i)}^{l, i} \right) = \left(\tilde{f}_0^{\mathcal{A}} \right)^i \left(\tilde{f}_1^{\mathcal{A}} \right)^{i+j} \left(\tilde{f}_0^{\mathcal{A}} \right)^j \bar{b}_{(i, j)}^{l, i}.$$

Then it is sufficient to consider following element:

$$\tilde{e}_1^{\mathcal{A}} E_{\mathcal{A}} \left(\tilde{f}_0^{\mathcal{A}} \right)^r \left(\tilde{f}_1^{\mathcal{A}} \right)^{p+s} \left(\tilde{f}_0^{\mathcal{A}} \right)^p \bar{b}_{(i, j)}^{l, i} \quad (i < j \leq l-i, 0 < s \leq k-i).$$

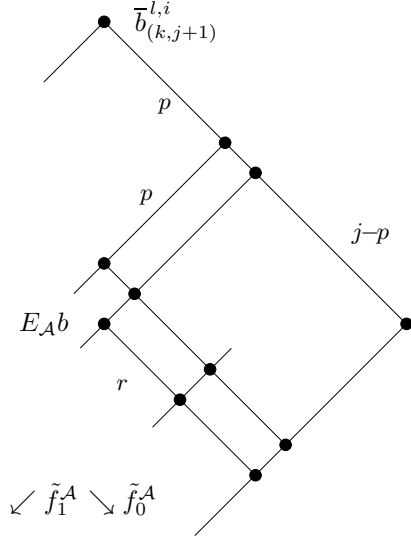

Figure 4: Part I, the case of (a2), the localtion of $E_{\mathcal{A}}b$ in the crystal graph of $B_{(k,j+1)}^i$.

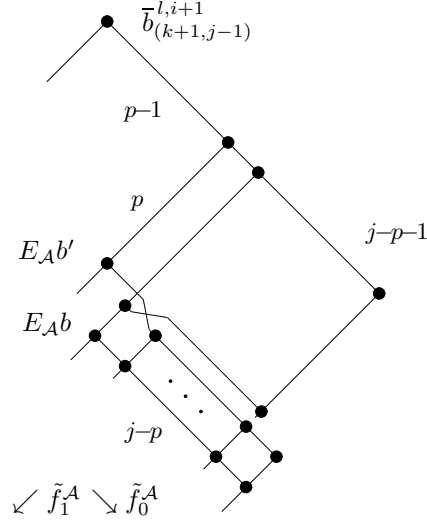

Figure 5: Part I, the case of (a3), the location of $E_{\mathcal{A}}b$ and $E_{\mathcal{A}}b'$ in the crystal graph $B_{(k+1,j-1)}^{i+1}$.

We denote $b, b', b'' \in B_{(k,j)}^i$ by

$$\begin{aligned} b &= (\tilde{f}_1^{\mathcal{A}})^{p+s} (\tilde{f}_0^{\mathcal{A}})^p \bar{b}_{(k,j)}^{l,i}, \\ b' &= (\tilde{f}_1^{\mathcal{A}})^{p+s+1} (\tilde{f}_0^{\mathcal{A}})^{p-1} \bar{b}_{(k,j)}^{l,i}, \\ b'' &= \tilde{e}_1^{\mathcal{A}} b. \end{aligned}$$

Then we have

$$\begin{aligned} \tilde{e}_1^{\mathcal{A}} (\tilde{f}_0^{\mathcal{A}})^r b &= (\tilde{f}_0^{\mathcal{A}})^r b'' \quad (r < s), \\ \tilde{e}_1^{\mathcal{A}} (\tilde{f}_0^{\mathcal{A}})^r b &= (\tilde{f}_0^{\mathcal{A}})^{r+1} b' \quad (r \geq s), \end{aligned}$$

(Figure 6). We rewrite m_b

$$m_b = (j+s) - (k-s) + s - 3((j+s) - p) = -2j - k + 3p.$$

Then we denote b using the \mathcal{A} -terminal element in an $E_{\mathcal{A}}$ -string.

$$b = \begin{cases} E_{\mathcal{A}}^{s+l-2(k-s+1)} (\tilde{f}_1^{\mathcal{A}})^p (\tilde{f}_0^{\mathcal{A}})^p \bar{b}_{(l-(k-s+1),j+s)}^{l,k-s+1} & \text{if } m_b < 0, \\ E_{\mathcal{A}}^{s+l-2(k-s+1)+m_b} (\tilde{f}_1^{\mathcal{A}})^{p-m_b} (\tilde{f}_0^{\mathcal{A}})^{p-m_b} \bar{b}_{(l-(k-s+1),j+s-m_b)}^{l,k-s+1} & \text{if } m_b \geq 0. \end{cases} \quad (5.3.14)$$

The case of (a2): $E_{\mathcal{A}}b \in B_{(i,j+1)}^i$.

This case is $b = E_{\mathcal{A}}^{n'}b_1$ ($l - 2i \leq l - i + 2j - 3q \leq n' < 2l - 2i + j - 3q$).

We denote

$$E_{\mathcal{A}}b = \left(\tilde{f}_1^{\mathcal{A}}\right)^{p+s+1} \left(\tilde{f}_0^{\mathcal{A}}\right)^{p+1} \bar{b}_{(i,j+1)}^{l,i}.$$

if $r < s$, since $m_b = m_{b''}$, then the action of $E_{\mathcal{A}}$ for b'' is given by (a2). Then we have

$$E_{\mathcal{A}}b'' = \left(\tilde{f}_1^{\mathcal{A}}\right)^{p+s} \left(\tilde{f}_0^{\mathcal{A}}\right)^{p+1} \bar{b}_{(i,j+1)}^{l,i}.$$

Therefore we have,

$$\tilde{e}_1^{\mathcal{A}}E_{\mathcal{A}}\left(\left(\tilde{f}_0^{\mathcal{A}}\right)^r b\right) = E_{\mathcal{A}}\left(\left(\tilde{f}_0^{\mathcal{A}}\right)^r b''\right).$$

If $r \geq s$, $m_b = 0, 1, 2$, since $m_{b'} < 0$, then the action of $E_{\mathcal{A}}$ for b' is given by (a3). Then we have

$$E_{\mathcal{A}}b' = \left(\tilde{f}_1^{\mathcal{A}}\right)^{p+s} \left(\tilde{f}_0^{\mathcal{A}}\right)^{p-1} \bar{b}_{(i+1,j-1)}^{l,i+1}.$$

therefore we have

$$\tilde{e}_1^{\mathcal{A}}E_{\mathcal{A}}\left(\left(\tilde{f}_0^{\mathcal{A}}\right)^r b\right) = E_{\mathcal{A}}^{s+l-2(i-s+1)}\left(\left(\tilde{f}_0^{\mathcal{A}}\right)^{r+1} \left(\tilde{f}_1^{\mathcal{A}}\right)^p \left(\tilde{f}_0^{\mathcal{A}}\right)^p \bar{b}_{(l-(i-s+1),j+s+1)}^{l,k-s+1}\right). \quad (5.3.15)$$

If $r \leq s$, $m_b \geq 3$, than the actions of $E_{\mathcal{A}}$ for b' is given by (a2), since $m_{b'} \geq 0$. Then we have,

$$E_{\mathcal{A}}b' = \left(\tilde{f}_1^{\mathcal{A}}\right)^{p+s} \left(\tilde{f}_0^{\mathcal{A}}\right)^p \bar{b}_{(i,j+1)}^{l,i},$$

(Figure 7). Thus we have

$$\begin{aligned} \tilde{e}_1^{\mathcal{A}}E_{\mathcal{A}}\left(\left(\tilde{f}_0^{\mathcal{A}}\right)^r b\right) &= E_{\mathcal{A}}\left(\left(\tilde{f}_0^{\mathcal{A}}\right)^{r+1} b'\right) \\ &= E_{\mathcal{A}}^{s+l-2(i-s+1)+m-2}\left(\left(\tilde{f}_0^{\mathcal{A}}\right)^{r+1} \left(\tilde{f}_1^{\mathcal{A}}\right)^{p-m+2} \left(\tilde{f}_0^{\mathcal{A}}\right)^{p-m+2} \bar{b}_{(l-(i-s+1),j-m+2+s)}^{l,i-s+1}\right) \end{aligned} \quad (5.3.16)$$

Therefore we have the case of (5.3.3), (5.3.4), (5.3.5), if $l - 2i \leq l - i + 2j - 3q$.

The case of (a3): $E_{\mathcal{A}}b \in B_{(i+1,j-1)}^{i+1}$.

This case is $b = E_{\mathcal{A}}^{n'}b_1$ ($l - 2i < n' < l - i + 2j - 3q$), $b = E_{\mathcal{A}}^{n'}b_2$ ($l - 2i < n' < [\frac{l-i}{2}]$), $b = E_{\mathcal{A}}^{n'}b_3$ ($l - 2i < n' < [\frac{l-i}{2}]$). (5.3.8).

Since $m_{b'} < m_{b''} = m_b < 0$, the action of $E_{\mathcal{A}}$ for b' , b'' is given by (a3). Then we have

$$\begin{aligned} E_{\mathcal{A}}b &= \left(\tilde{f}_1^{\mathcal{A}}\right)^{p+s+1} \left(\tilde{f}_0^{\mathcal{A}}\right)^p \bar{b}_{(k+1,j-1)}^{l,i+1}, \\ E_{\mathcal{A}}b' &= \left(\tilde{f}_1^{\mathcal{A}}\right)^{p+s} \left(\tilde{f}_0^{\mathcal{A}}\right)^{p-1} \bar{b}_{(k+1,j-1)}^{l,i+1}, \\ E_{\mathcal{A}}b'' &= \left(\tilde{f}_1^{\mathcal{A}}\right)^{p+s} \left(\tilde{f}_0^{\mathcal{A}}\right)^p \bar{b}_{(k+1,j-1)}^{l,i+1}, \end{aligned}$$

(Figure 8). With Proposition 5.4, we have

$$\begin{aligned} \tilde{e}_1^{\mathcal{A}}E_{\mathcal{A}}\left(\left(\tilde{f}_0^{\mathcal{A}}\right)^r b\right) &= E_{\mathcal{A}}\left(\left(\tilde{f}_0^{\mathcal{A}}\right)^r b''\right) \quad (r < s + 1), \\ \tilde{e}_1^{\mathcal{A}}E_{\mathcal{A}}\left(\left(\tilde{f}_0^{\mathcal{A}}\right)^r b\right) &= E_{\mathcal{A}}\left(\left(\tilde{f}_0^{\mathcal{A}}\right)^{r+1} b'\right) \quad (r \geq s + 1). \end{aligned} \quad (5.3.17)$$

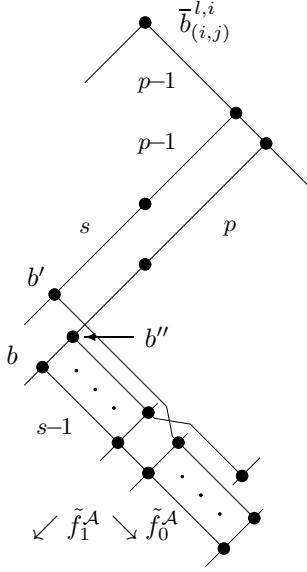

Figure 6: Part II, the location of b, b' and b'' in the crystal graph $B_{(i,j)}^i$.

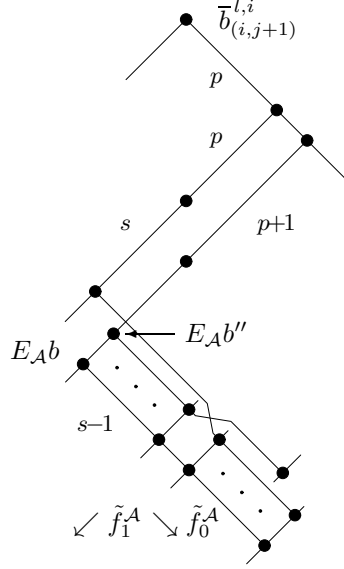

Figure 7: Part II, the case of (a2), the location of $E_{\mathcal{A}}b$ and $E_{\mathcal{A}}b''$ in the crystal graph of $B_{(i,j+1)}^i$.

Therefore we have the case of $(l - 2i < n \leq l - i + 2j - 3q)$ of (5.3.2), the case of $(l - 2i < n \leq \lfloor \frac{l-i}{2} \rfloor)$ of (5.3.6) and (5.3.7),

By (5.3.9) – (5.3.17), we have Proposition 5.30. \square

5.3.2 Actions of $\tilde{e}_1^{\mathcal{G}}$

Proposition 5.31 For $b \in \mathcal{G}$, $n \in \mathbf{Z}_{>0}$ if $\tilde{f}_1^{\mathcal{G}} (\tilde{e}_2^{\mathcal{G}})^n b = (\tilde{e}_2^{\mathcal{G}})^n \tilde{f}_1^{\mathcal{G}} b \neq 0$, we have

$$\tilde{f}_1^{\mathcal{G}} (\tilde{e}_2^{\mathcal{G}})^k b = (\tilde{e}_2^{\mathcal{G}})^k \tilde{f}_1^{\mathcal{G}} b \quad (0 \leq k \leq n).$$

Proof We prove the proposition by the induction on k . We assume

$$\tilde{f}_1 (\tilde{e}_2)^{k'} b = (\tilde{e}_2)^{k'} \tilde{f}_1 b \quad (0 \leq k' < k),$$

then we prove

$$\tilde{f}_1 \tilde{e}_2 (\tilde{e}_2)^{k-1} b = \tilde{e}_2 \tilde{f}_1 (\tilde{e}_2)^{k-1} b. \quad (5.3.18)$$

We write $\tilde{e}_2^{k-1} b = b_1 \otimes \dots \otimes b_l$. We have

$$\tilde{f}_1 (\tilde{e}_2)^{k-1} b = b_1 \otimes \dots \otimes \tilde{f}_1 b_{k_1} \otimes \dots \otimes b_l, \quad (5.3.19)$$

$$\tilde{e}_2 (\tilde{e}_2)^{k-1} b = b_1 \otimes \dots \otimes \tilde{e}_1 b_{k_2} \otimes \dots \otimes b_l, \quad (5.3.20)$$

where $1 \leq k_1, k_2 \leq l$.

The case of $k_1 > k_2$. Similar to Proposition 5.6, by Proposition 3.3 we see that the action of f_1 increase the number of u_+ of $\text{Red}_2(b)$. Then the operator f_1 does not influence the action of \tilde{e}_2 . In a similar way, we see that the operator \tilde{e}_2 does not influence the action of \tilde{f}_1 . Therefore we have (5.3.18).

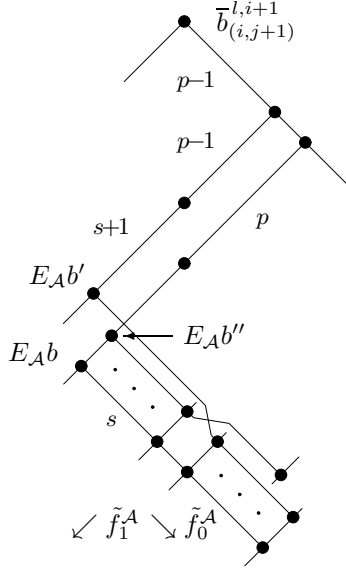

Figure 8: Part II, the case of (a3), the location of $E_A b$, $E_A b'$ and $E_A b''$ in the crystal graph of $B_{(i,j+1)}^{i+1}$.

The case of $k_1 \leq k_2$. We assume

$$\tilde{f}_1 \tilde{e}_2 (\tilde{e}_2)^{k-1} b \neq \tilde{e}_2 \tilde{f}_1 (\tilde{e}_2)^{k-1} b. \quad (5.3.21)$$

By assumption, at most one of following relations are satisfied:

$$\tilde{f}_1 \tilde{e}_2 (\tilde{e}_2^{k-1}) b = \begin{cases} b_1 \otimes \cdots \otimes \tilde{f}_1 \tilde{e}_2 b_{k_2} \otimes \cdots \otimes b_l \\ b_1 \otimes \cdots \otimes \tilde{e}_2 b_{k_2} \otimes \cdots \otimes \tilde{f}_1 b_{k'_1} \otimes \cdots \otimes b_l \end{cases}, \quad (5.3.22)$$

$$\tilde{e}_2 \tilde{f}_1 (\tilde{e}_2^{k-1}) b = \begin{cases} b_1 \otimes \cdots \otimes \tilde{e}_2 \tilde{f}_1 b_{k_1} \otimes \cdots \otimes b_l \\ b_1 \otimes \cdots \otimes \tilde{e}_2 b_{k'_2} \otimes \cdots \otimes \tilde{f}_1 b_{k_1} \otimes \cdots \otimes b_l \end{cases}, \quad (5.3.23)$$

Since $\tilde{f}_1 u_+ = u_-$ and $\Psi_1(b) = u_-^{\varepsilon_1(b)} u_+^{\varphi_1(b)}$, we have $k_1 < k'_1$. In a similar way we have $k'_2 < k_2$. If (5.3.22) is satisfied, we see that k_1 -th element of $\tilde{e}_2^{k'} \tilde{f}_1 \tilde{e}_2^k b$ and $\tilde{f}_1 \tilde{e}_2^{k'} \tilde{e}_2^k b$ ($1 \leq k' \leq n-k$) are different. Then we have

$$\tilde{e}_2^n \tilde{f}_1 b \neq \tilde{f}_1 \tilde{e}_2^n b. \quad (5.3.24)$$

This is contradiction. In a similar way, if (5.3.23) is satisfied, we have contradiction. Thus we have (5.3.18). \square

We prove from (5.3.2) to (5.3.8) exchanging \tilde{e}_1^A with \tilde{e}_1^G . For example, we denote following equations exchanging \tilde{e}_1^A with \tilde{e}_1^G from (5.3.2) to (5.3.5). We put $b_1 = \left(\tilde{f}_1^A\right)^q \left(\tilde{f}_0^A\right)^p \bar{b}_{(l-i,j)}^{l,i} \in B_C$ ($3q \geq i+2j - \lfloor \frac{j-i}{2} \rfloor$, $p+2q > i+2j$).

We are going to show

$$\tilde{e}_1^G \left(\Phi \left(E_A^n b_1 \right) \right) = \Phi \left(E_A^n \left(\left(\tilde{f}_1^A \right)^{q-1} \left(\tilde{f}_0^A \right)^p \bar{b}_{(l-i,j)}^{l,i} \right) \right), \quad (5.3.25)$$

$$\tilde{e}_1^G \left(\Phi \left(E_A^{l-i-j+3(j-q)+1} b_1 \right) \right) = \Phi \left(E_A^{l-i-j+3(j-q)} \left(\left(\tilde{f}_1^A \right)^q \left(\tilde{f}_0^A \right)^{p+1} \bar{b}_{(l-i,j+1)}^{l,i} \right) \right), \quad (5.3.26)$$

$$\tilde{e}_1^{\mathcal{G}} \left(\Phi \left(E_{\mathcal{A}}^{l-i-j+3(j-q)+2} b_1 \right) \right) = \Phi \left(E_{\mathcal{A}}^{l-i-j+3(j-q)} \left(\left(\tilde{f}_1^{\mathcal{A}} \right)^{q+1} \left(\tilde{f}_0^{\mathcal{A}} \right)^{p+2} \bar{b}_{(l-i,j+2)}^{l,i} \right) \right), \quad (5.3.27)$$

$$\tilde{e}_1^{\mathcal{G}} \left(\Phi \left(E_{\mathcal{A}}^{l-i-j+3(j-q+1)+n'} b_1 \right) \right) = \Phi \left(E_{\mathcal{A}}^{l-i-j+3(j-q)+n'} \left(\left(\tilde{f}_1^{\mathcal{A}} \right)^{q+2} \left(\tilde{f}_0^{\mathcal{A}} \right)^{p+3} \bar{b}_{(l-i,j+3)}^{l,i} \right) \right), \quad (5.3.28)$$

where $0 < n < l - j - i + 3(j - q)$, $0 < n' < 3(y - 1)$.

Here we prove the case of $l - i - j \equiv 0 \pmod{3}$, we can prove other cases similarly.

By Proposition 5.20, we have

$$\Phi(b_1) = \left[\left[\left[1 \right] \right]^i \left[\left[6 \right] \right]^{j-q} \left[\left[6 \right] \right]^y \left[\left[\mathcal{C} \right] \right]^{y+q+p-j-i} \left[\left[2 \right] \right]^{y-1} \left[\left[\bar{1} \right] \right]^{j+i-p} \right].$$

The case of (5.3.25), $n = 0$. By (E1), we have

$$\tilde{e}_1^{\mathcal{G}} (\Phi(b_1)) = \Phi \left(\left(\tilde{f}_1^{\mathcal{A}} \right)^{q-1} \left(\tilde{f}_0^{\mathcal{A}} \right)^p \bar{b}_{(l-i,j)}^{l,i} \right).$$

The case of (5.3.25), $n = l - i - j + 3(j - q)$. Put $b_4 = E_{\mathcal{A}}^{l-j-i+3(j-q)} b$. We see

$$\Phi(b_4) = \left[\left[\left[1 \right] \right]^i \left[\left[2 \right] \right]^{j-p} \left[\left[2 \right] \right]^y \left[\left[\mathcal{C} \right] \right]^{y+q+p-j-i} \left[\left[\bar{2} \right] \right]^y \left[\left[\bar{1} \right] \right]^{j+i-p} \right].$$

Using Definition 3.4

$$\begin{aligned} \Psi_1(b_4) &= u_-^{j-p+i} u_+^y u_-^{y+q+p-j-i} u_+^{y+q+p-j-i} u_-^{y+j-p} u_+^i, \\ \text{Red}_1(b_4) &= u_-^{j-p+i} u_-^{q+p-j-i} u_+^{2q+p-2j-i} u_+^i. \end{aligned}$$

By Proposition 3.9, we have

$$\begin{aligned} \tilde{e}_1^{\mathcal{G}} (\Phi(b_4)) &= \left[\left[\left[1 \right] \right]^i \left[\left[2 \right] \right]^{j-p} \left[\left[2 \right] \right]^y \tilde{e}_1^{\mathcal{G}} \left[\left[\mathcal{C} \right] \right]^{y+q+p-j-i} \left[\left[\bar{2} \right] \right]^y \left[\left[\bar{1} \right] \right]^{j+i-p} \right] \\ &= \left[\left[\left[1 \right] \right]^i \left[\left[2 \right] \right]^{j-p} \left[\left[2 \right] \right]^y \left[\left[6 \right] \right] \left[\left[\mathcal{C} \right] \right]^{y+q+p-j-i-1} \left[\left[\bar{2} \right] \right]^y \left[\left[\bar{1} \right] \right]^{j+i-p} \right]. \end{aligned}$$

Put $b'_4 = E_{\mathcal{A}}^n \left(\left(\tilde{f}_1^{\mathcal{A}} \right)^{q-1} \left(\tilde{f}_0^{\mathcal{A}} \right)^p \bar{b}_{(l-i,j)}^{l,i} \right)$. We see

$$\Phi(b'_4) = \left[\left[\left[1 \right] \right]^i \left[\left[2 \right] \right]^{j-p} \left[\left[2 \right] \right]^y \left[\left[6 \right] \right] \left[\left[\mathcal{C} \right] \right]^{y+q+p-j-i-1} \left[\left[\bar{2} \right] \right]^y \left[\left[\bar{1} \right] \right]^{j+i-p} \right].$$

Thus we have

$$\tilde{e}_1^{\mathcal{G}} (\Phi(E_{\mathcal{A}}^n b_1)) = \Phi \left(E_{\mathcal{A}}^n \left(\left(\tilde{f}_1^{\mathcal{A}} \right)^{q-1} \left(\tilde{f}_0^{\mathcal{A}} \right)^p \bar{b}_{(l-i,j)}^{l,i} \right) \right).$$

The case of (5.3.26). We set $b_5 = E_{\mathcal{A}}^{l-j-i+3(j-q)+1} b$.

$$\Phi(b_5) = \left[\left[\left[1 \right] \right]^i \left[\left[2 \right] \right]^{j-p} \left[\left[2 \right] \right]^y \left[\left[\mathcal{C} \right] \right]^{y+q+p-j-i} \left[\left[\bar{3} \right] \right] \left[\left[\bar{2} \right] \right]^{y-1} \left[\left[\bar{1} \right] \right]^{j+i-p} \right].$$

We consider $\tilde{e}_1^{\mathcal{G}}(\Phi(b_5))$ with u_+ and u_- .

$$\begin{aligned} \Psi_1(\Phi(b_5)) &= u_-^{j+i-p} u_+^{y-1} u_0 u_-^{y+q+p-j-i} u_+^{y+q+p-j-i} u_-^{y+j-p} u_+^i, \\ \text{Red}_1(\Phi(b_5)) &= u_-^{j+i-p} u_-^{p+q-j-i+1} u_+^{2q+p-2j-i} u_+^i. \end{aligned}$$

Then we have

$$\begin{aligned}\tilde{e}_1^{\mathcal{G}}(\Phi(b_5)) &= \left[[1]^i [2]^{j-p} [2]^y \tilde{e}_1^{\mathcal{G}} [C]^{y+q+p-j-i} [\bar{3}] [\bar{2}]^{y-1} [\bar{1}]^{j+i-p} \right] \\ &= \left[[1]^i [2]^{j-p} [2]^y [6] [C]^{y+q+p-j-i-1} [\bar{3}] [\bar{2}]^{y-1} [\bar{1}]^{j+i-p} \right].\end{aligned}$$

We put $b'_5 = E_{\mathcal{A}}^{l-i-j+3(j-q)} \left(\left(\tilde{f}_1^{\mathcal{A}} \right)^q \left(\tilde{f}_0^{\mathcal{A}} \right)^{p+1} \bar{b}_{(l-i, j+1)}^{l,i} \right)$. Then we have

$$\Phi(b'_5) = \left[[1]^i [2]^{j-q} [2]^y [6] [C]^{y+p+q-j-i-1} [\bar{3}] [\bar{2}]^{y-1} [\bar{1}]^{j+i-p} \right].$$

Thus we have

$$\tilde{e}_1^{\mathcal{G}} \left(\Phi \left(E_{\mathcal{A}}^{l-i-j+3(j-q)+1} b_1 \right) \right) = E_{\mathcal{A}}^{l-i-j+3(j-q)} \left(\left(\tilde{f}_1^{\mathcal{A}} \right)^q \left(\tilde{f}_0^{\mathcal{A}} \right)^{p+1} \bar{b}_{(l-i, j+1)}^{l,i} \right).$$

Similarly, in case of (5.3.27), $n' = 0$ and $n' = 2(l-i-j) + 3(j-q)$ of (5.3.28), we have

$$\begin{aligned}\tilde{e}_1^{\mathcal{G}} \left(\Phi \left(E_{\mathcal{A}}^{l-i-j+3(j-q)+2} b_1 \right) \right) &= \Phi \left(E_{\mathcal{A}}^{l-i-j+3(j-q)} \left(\left(\tilde{f}_1^{\mathcal{A}} \right)^{q+1} \left(\tilde{f}_0^{\mathcal{A}} \right)^{p+2} \bar{b}_{(l-i, j+2)}^{l,i} \right) \right), \\ \tilde{e}_1^{\mathcal{G}} \left(\Phi \left(E_{\mathcal{A}}^{l-i-j+3(j-p)+3} b_1 \right) \right) &= \Phi \left(E_{\mathcal{A}}^{l-i-j+3(j-q)} \left(\left(\tilde{f}_1^{\mathcal{A}} \right)^{q+2} \left(\tilde{f}_0^{\mathcal{A}} \right)^{p+3} \bar{b}_{(l-i, j+3)}^{l,i} \right) \right), \\ \tilde{e}_1^{\mathcal{G}} \left(\Phi \left(E_{\mathcal{A}}^{2(l-i-j)+3(j-p)} b_1 \right) \right) &= \Phi \left(E_{\mathcal{A}}^{2(l-i-j)+3(j-q-1)} \left(\left(\tilde{f}_1^{\mathcal{A}} \right)^{q+2} \left(\tilde{f}_0^{\mathcal{A}} \right)^{p+3} \bar{b}_{(l-i, j+3)}^{l,i} \right) \right).\end{aligned}$$

By Proposition 5.31, we have $\tilde{e}_1^{\mathcal{G}} \Phi = \Phi \tilde{e}_1^{\mathcal{A}}$ for $E_{\mathcal{A}}^n b_1$ ($0 \leq n \leq \varepsilon_{\mathcal{A}}(b_1) = 2(l-i-j) + 3(j-p)$).

Similarly, we can prove $\tilde{e}_1^{\mathcal{G}} \Phi = \Phi \tilde{e}_1^{\mathcal{A}}$ for any $b \in \mathcal{A}$.

5.4 Selection of minimal

5.4.1 Selection of minimal elements in $B^{G_2}(l\Lambda_1)$

In this section, we only consider crystal B^l , so we denote \tilde{e}_1, \tilde{e}_2 instead of $\tilde{e}_1^{\mathcal{G}}, \tilde{e}_2^{\mathcal{G}}$ respectively for simplicity. By definition 3.16, minimal elements are $b \in B^l$ such that $\langle c, \varphi(b) \rangle = l$. At first we search for the element $b \in B(l\Lambda)$ such that $\langle c, \varphi_1(b)\Lambda_1 + \varphi_1(b)\Lambda_2 \rangle = l$. Next we verify that there does not exist $b \in B(l\Lambda_1)$ such that $\langle c, \varphi_1(b)\Lambda_1 + \varphi_2(b)\Lambda_2 \rangle < l$. Then we verify that for $b \in B^l$ such that $\langle c, \varphi_1(b)\Lambda_1 + \varphi_2(b)\Lambda_2 \rangle = l$, we have $\varphi_0(b) = 0$

Proposition 5.32 For $b \in B^{G_2}(l\Lambda_1)$ such that $\varepsilon_2(b) = 0$, we have

$$\min\{2\varphi_1(\tilde{f}_2^{(k)}(b)) + \varphi_2(\tilde{f}_2^{(k)}(b)) \mid k = 0, \dots, \varphi_2(b)\} \geq l - \left\lfloor \frac{1}{2} wt_0(b) \right\rfloor,$$

Proof We consider

$$\min\{2\varphi_1(b') + \varphi_2(b') \mid b' = \tilde{f}_2^{(k)}(b), k = 0, \dots, \varphi_2(b)\}. \quad (5.4.1)$$

By Proposition 5.6, we have

$$2\varphi_1(\tilde{f}_2^{(k+1)}(b)) + \varphi_2(\tilde{f}_2^{(k+1)}(b)) - (2\varphi_1(\tilde{f}_2^{(k)}(b)) + \varphi_2(\tilde{f}_2^{(k)}(b))) = \begin{cases} 1 & (k < k') \\ -1 & (k \leq k') \end{cases}.$$

We set $b' = \tilde{f}_2^{\varphi_2(b)} b$. Then (5.4.1) is

$$2\varphi_1(b) + \varphi_2(b) - \frac{\varphi_2(b) - (2\varphi_1(b') - (2\varphi_1(b) + \varphi_2(b)))}{2} = \varphi_1(b) + \varphi_1(b').$$

Then we prove

$$\varphi_1(b) + \varphi_1(b') - l + \left\lfloor \frac{1}{2} \text{wt}_0(b) \right\rfloor \geq 0.$$

We recall that $x_i(b) = \#\left\{ \left[\begin{smallmatrix} b_k \\ i \end{smallmatrix} \right] \mid k = 1, \dots, n \right\}$ ($i = 1, \dots, 6, 0_1, 0_2$), $\bar{x}_i(b) = \#\left\{ \left[\begin{smallmatrix} b_k \\ \bar{i} \end{smallmatrix} \right] \mid k = 1, \dots, n \right\}$ ($i = 1, \dots, 6$). We consider b such that $\varepsilon_2(b) = 0$. Such an element b satisfy following conditions:

- (1) $0 \leq x_1(b) + \bar{x}_1(b) \leq l$. This is because $\tilde{f}_2 \left(\left[\begin{smallmatrix} 1 \\ 1 \end{smallmatrix} \right] \right) = 0$, $\tilde{e}_2 \left(\left[\begin{smallmatrix} 1 \\ 1 \end{smallmatrix} \right] \right) = 0$, $\tilde{f}_2 \left(\left[\begin{smallmatrix} 1 \\ \bar{1} \end{smallmatrix} \right] \right) = 0$, $\tilde{e}_2 \left(\left[\begin{smallmatrix} 1 \\ \bar{1} \end{smallmatrix} \right] \right) = 0$.
- (2) $x_{0_2}(b) = 0$ or 1 . Since $\tilde{f}_2 \left(\left[\begin{smallmatrix} 0_2 \\ 2 \end{smallmatrix} \right] \right) = 0$, $\tilde{e}_2 \left(\left[\begin{smallmatrix} 0_2 \\ 2 \end{smallmatrix} \right] \right) = 0$ and by Proposition 3.15 $x_{0_2}(b) < 2$.
- (3) $\bar{x}_2(b) = \bar{x}_3(b) = \bar{x}_4(b) = \bar{x}_5(b) = \bar{x}_{0_1}(b) = 0$. Because if $\bar{x}_2(b) > 0$ or $\bar{x}_3(b) > 0$ or $\bar{x}_4(b) > 0$ or $\bar{x}_5(b) > 0$ or $\bar{x}_{0_1}(b) > 0$ then $\varepsilon_2(b) > 0$.
- (4) $x_3(b) + x_4(b) + x_5(b) = 0$ or 1 . By Proposition 3.15.
- (5) $x_6(b) \leq \bar{x}_6(b)$. In particular, if $x_3(b) = 1$ or $x_4(b) = 1$ then $x_6(b) < \bar{x}_6(b)$ and if $x_5(b)$ then $x_6(b) = 0$.
- (6) $\sum_{i=1}^6 (x_i(b) + \bar{x}_i(b)) + x_{0_1}(b) + x_{0_2}(b) = l$.

We start with the case of $x_5(b) = 0$.

By calculation, we have $x_1(b') = x_1(b)$, $x_6(b') = x_2(b) + x_3(b) + x_4(b) + x_6(b)$, $x_{0_2}(b') = x_{0_2}(b)$, $\bar{x}_6(b') = x_6(b)$, $\bar{x}_4(b') = x_4(b)$, $\bar{x}_3(b') = x_3(b)$, $\bar{x}_2(b') = \bar{x}_6(b) - x_{0_2}(b) - x_6(b) - x_4(b) - x_3(b)$, $\bar{x}_1(b') = \bar{x}_1(b)$. We put $\delta = \text{wt}_0(b) \bmod 2$. Thus we have

$$\begin{aligned} -\text{wt}_0(b) &= 2x_1(b) + x_2(b) + x_3(b) + x_4(b) + x_6(b) - \bar{x}_6(b) - 2\bar{x}_1(b), \\ l &= x_1(b) + x_2(b) + x_3(b) + x_4(b) + x_6(b) + x_{0_2}(b) + \bar{x}_6(b) + \bar{x}_1(b), \\ l - \left\lfloor \frac{1}{2} \text{wt}_0(b) \right\rfloor &= 2x_1(b) + \frac{3}{2}x_2(b) + \frac{1}{2}x_3(b) + \frac{1}{2}x_4(b) + \frac{3}{2}x_6(b) + \frac{1}{2}\bar{x}_6(b) + \frac{\delta}{2}, \\ \varphi_1(b) &= x_1(b) + (x_{0_2}(b) + 2x_6(b) + x_4(b) - x_2(b))_+, \\ \varphi_1(b') &= x_1(b') + x_{0_2}(b') + 2x_6(b') + (\bar{x}_2(b') - \bar{x}_4(b') - \bar{x}_6(b') - x_{0_2}(b'))_+, \\ &= x_1(b) + 2x_2(b) + 2x_3(b) + 2x_4(b) + 2x_6(b) + x_{0_2}(b) \\ &\quad + (\bar{x}_6(b) - x_{0_2}(b) - 3x_6(b) - 2x_4(b) - x_3(b))_+. \end{aligned}$$

$$\begin{aligned} \varphi_1(b) + \varphi_1(b') - l + \left\lfloor \frac{1}{2} \text{wt}_0(b) \right\rfloor &= \frac{1}{2} |x_{0_2}(b) + 2x_6(b) + x_4(b) - x_2(b)| \\ &\quad + \frac{1}{2} |\bar{x}_6(b) - x_{0_2}(b) - 3x_6(b) - 2x_4(b) - x_3(b)| - \frac{\delta}{2} \quad (5.4.2) \\ &\geq 0 \text{ (integer greater than } -\frac{1}{2} \text{)}. \end{aligned}$$

The case of $x_5(b) = 1$. By Proposition 3.15, $x_3(b) = x_4(b) = x_6(b) = x_{0_2}(b) = 0$. Similar to the case of $x_5(b) = 0$, we have

$$\varphi_1(b) + \varphi_1(b') - l + \left\lfloor \frac{1}{2} \text{wt}_0(b) \right\rfloor = \frac{1}{2} x_2(b) + \frac{1}{2} \bar{x}_6(b) - \frac{\delta}{2} \geq 0 \text{ (integer greater than } -\frac{1}{2} \text{)} \quad (5.4.3)$$

□

A minimal element is an element $b \in B^l$ such that $\langle c, \varphi(b) \rangle = l$. By $\langle c, \varphi(b) \rangle = \varphi_0(b) + 2\varphi_1(b) + \varphi_2(b)$ and Proposition 5.32, if $\text{wt}_0(b) > 0$ we have $\langle c, \varphi(b) \rangle > l$. Therefore for a minimal element b we must have $\text{wt}_0(b) = 0$.

Lemma 5.33 *we have*

$$\min\{\langle c, \varphi(b) \rangle \mid b \in B(n\Lambda_1)\} = l.$$

Proof By (5.4.2) and (5.4.3), the elements b such that $\varepsilon_2(b) = 0$, $\varphi_1(b) + \varphi_1(\tilde{f}_2^{\varphi_2(b)}(b)) = l$ satisfy following conditions.

If $x_5(b) = 0$,

$$\begin{aligned} x_2(b) &= 2x_6(b) + x_{0_2}(b) + x_4(b), \\ \bar{x}_2(b) &= 3x_6(b) + x_{0_2}(b) + 2x_4(b) + x_3(b). \end{aligned}$$

If $x_5(b) = 1$,

$$\begin{aligned} x_2(b) &= 0, \\ x_6(b) &= 0. \end{aligned}$$

Then we can express b such that $\varepsilon_2(b) = 0$, $\varphi_1(b) + \varphi_1(\tilde{f}_2^{\varphi_2(b)}(b)) = l$ as:

$$b = \begin{cases} \left[[1]^m [2]^n [c]^n [\bar{6}]^n [\bar{1}]^m \right] & (l = 2m + 3n), \\ \left[[1]^m [2]^n [4] [c]^{n-1} [\bar{6}]^{n+1} [\bar{1}]^m \right] & (n > 0, l = 2m + 3n + 1), \\ \left[[1]^m [5] [\bar{1}]^m \right] & (l = 2m + 1), \\ \left[[1]^m [2]^n [3] [c]^n [\bar{6}]^{n+1} [\bar{1}]^m \right] & (l = 2m + 3n + 2). \end{cases}$$

where $m, n \in \mathbf{Z}_{\geq 0}$. We put

$$\tilde{b}_{(m)} = \tilde{f}_2^{3n} b = \begin{cases} \left[[1]^m [2]^n [c]^n [\bar{2}]^n [\bar{1}]^m \right] & (l = 2m + 3n), \\ \left[[1]^m [2]^n [4] [c]^{n-1} [\bar{4}] [\bar{6}]^n [\bar{1}]^m \right] & (n > 0, l = 2m + 3n + 1), \\ \left[[1]^m [0_1] [\bar{1}]^m \right] & (l = 2m + 1), \\ \left[[1]^m [2]^n [3] [c]^n [\bar{3}] [\bar{2}]^n [\bar{1}]^m \right] & (l = 2m + 3n + 2), \end{cases}$$

where $m \in \mathbf{Z}_{\geq 0}$ such that $l - 2m \geq 0$. We prove $\langle c, 2\varphi_1(\tilde{b}_{(m)})\Lambda_1 + \varphi_2(\tilde{b}_{(m)})\Lambda_2 \rangle = l$ ($k = 1, 2, 3$). We prove the case of $l = 2m + 3n$. By Proposition 3.9

$$\begin{aligned} \Psi_1(\tilde{b}_{(m)}) &= u_-^m u_+^n u_-^n u_+^n u_-^n u_+^m, \\ \text{Red}_1(\tilde{b}_{(m)}) &= u_-^m u_+^m, \end{aligned}$$

we have

$$\varphi_1(\tilde{b}_{(m)}) = m.$$

By Proposition 3.9

$$\begin{aligned} \Psi_2(\tilde{b}_{(m)}) &= u_0 u_-^{3n} u_0 u_+^{2n} u_0, \\ \text{Red}_2(\tilde{b}_{(m)}) &= u_-^{3n} u_+^{3n}, \end{aligned}$$

we have

$$\varphi_2(\tilde{b}_{(m)}) = 3n.$$

Therefore,

$$\langle c, 2\varphi_1(\tilde{b}_{(m)})\Lambda_1 + \varphi_2(\tilde{b}_{(m)})\Lambda_2 \rangle = 2m + 3n.$$

In similar way, we can prove other cases.

Let $B_l^0 \cong \{b \mid b \in B(l\Lambda_1), \langle c, \varphi_1(b)\Lambda_1 + \varphi_2(b) \rangle = l\}$, $(P_{cl}^+)_l^0 \cong \{\lambda \in \mathbf{Z}\Lambda_1 + \mathbf{Z}\Lambda_2 \mid \langle c, \lambda \rangle = l\}$. Then we see following proposition easily.

Proposition 5.34 *The maps $\varepsilon, \varphi : B_l^0 \rightarrow (P_{cl}^+)_l^0$ are bijective.*

5.4.2 Existence of minimal elements on $B^{G_2}(l\Lambda_1)$

We consider $(\tilde{f}_1^A)^i (\tilde{f}_0^A)^i \bar{b}_{(i,i)}^{l,i}$. By Definition 5.12, we have

$$(\tilde{f}_1^A)^i (\tilde{f}_0^A)^i \bar{b}_{(i,i)}^{l,i} = (\tilde{e}_2^A)^{l-2i} (\tilde{f}_1^A)^i (\tilde{f}_0^A)^i \bar{b}_{((l-i),i)}^{l,i}.$$

For $b \in B_{k\Lambda_1+j\Lambda_0}^i$, we define $y = y(b) = \left\lfloor \frac{l-i-j}{3} \right\rfloor$.

By Proposition 5.20 and Lemma 5.21,

$$\Phi \left((\tilde{f}_1^A)^i (\tilde{f}_0^A)^i \bar{b}_{((l-i),i)}^{l,i} \right) = \begin{cases} \left[[1]^i [6]^y [C]^y [\bar{2}]^y [\bar{1}]^i \right] & (l-2i \equiv 0 \pmod{3}), \\ \left[[1]^i [5] [\bar{1}]^i \right] & (l-2i \equiv 1 \pmod{3}, y=0), \\ \left[[1]^i [6]^y [6] [C]^{y-1} [\bar{4}] [\bar{2}]^y [\bar{1}]^i \right] & (l-2i \equiv 1 \pmod{3}, y>0), \\ \left[[1]^i [6]^y [6] [C]^y [\bar{3}] [\bar{2}]^y [\bar{1}]^i \right] & (l-2i \equiv 2 \pmod{3}), \end{cases}$$

we have

$$\Phi \left((\tilde{e}_2^A)^{l-2i} (\tilde{f}_1^A)^i (\tilde{f}_0^A)^i \bar{b}_{((l-i),i)}^{l,i} \right) = \begin{cases} \left[[1]^i [2]^y [C]^y [\bar{2}]^y [\bar{1}]^i \right] & (l-2i \equiv 0 \pmod{3}), \\ \left[[1]^i [0_i] [\bar{1}]^i \right] & (l-2i \equiv 1 \pmod{3}, y=0), \\ \left[[1]^i [2]^y [4] [C]^{y-1} [\bar{4}] [\bar{2}]^y [\bar{1}]^i \right] & (l-2i \equiv 1 \pmod{3}, y>0), \\ \left[[1]^i [2]^y [3] [C]^y [\bar{3}] [\bar{2}]^y [\bar{1}]^i \right] & (l-2i \equiv 2 \pmod{3}), \end{cases}$$

Therefore we have proved existence of minimal elements. By (5.1.12) we see

$$\varphi_0 \left((\tilde{f}_1^A)^i (\tilde{f}_0^A)^i \bar{b}_{(i,i)}^{l,i} \right) = 0.$$

Thus we have

$$\langle c, \varphi(\tilde{b}_{(m)}) \rangle = l,$$

where $m \in \mathbf{Z}_{\geq 0}$.

5.4.3 Selection of minimals on B^l

By (5.2.6), for $n < l$, we have

$$\varphi_0|_{B^{n+1}}(b) = \varphi_0|_{B^n}(b) + 1.$$

Then for $b \in B^n$ such that $\langle c, \varphi(b) \rangle = n$, we have $\langle c, \varphi(b) \rangle = n + 1$ on B^{n+1} . If $l = 1$, by calculation we see $\min \{ \langle c, \varphi(b) \rangle \mid b \in B^1 \} = 1$. Then we see

$$\min \{ \langle c, \varphi(b) \rangle \mid b \in B^l \} = l,$$

inductively. Therefore a minimal element for level $l - 1$ is also a minimal element for level l . Thus it is obvious that ε and φ are bijective.

Example 5.35 *Following elements are minimal ($0 \leq l \leq 7$).*

$$\begin{aligned} \text{if } l \geq 0 & \quad \phi, \\ \text{if } l \geq 1 & \quad \left[[0_1] \right], \\ \text{if } l \geq 2 & \quad \left[[1] [1] \right] \quad \left[[3] [3] \right], \\ \text{if } l \geq 3 & \quad \left[[1] [0_1] [1] \right] \quad \left[[2] [0_2] [2] \right], \\ \text{if } l \geq 4 & \quad \left[[1]^2 [1]^2 \right] \quad \left[[1] [3] [3] [1] \right] \quad \left[[2] [4] [4] [2] \right], \\ \text{if } l \geq 5 & \quad \left[[1]^2 [0_1] [1]^2 \right] \quad \left[[1] [2] [0_2] [2] [1] \right] \quad \left[[2] [3] [0_2] [3] [2] \right], \\ \text{if } l \geq 6 & \quad \left[[1]^3 [1]^3 \right] \quad \left[[1]^2 [3] [3] [1]^2 \right] \\ & \quad \left[[1] [2] [4] [4] [2] [1] \right] \quad \left[[2]^2 [6] [6] [2]^2 \right], \\ \text{if } l \geq 7 & \quad \left[[1]^3 [0_1] [1]^3 \right] \quad \left[[1]^2 [2] [0_2] [2] [1]^2 \right] \\ & \quad \left[[1] [2] [3] [0_2] [3] [2] [1] \right] \quad \left[[2]^2 [4] [0_2] [4] [2]^2 \right]. \end{aligned}$$

5.5 Connectedness of $B^l \otimes B^l$

We will show connectedness of $B^l \otimes B^l$, by showing that any element of $B^l \otimes B^l$ is connected with $\phi \otimes \phi$. We consider decomposition of tensor products $B^{G_2}(m_1\Lambda_1) \otimes B^{G_2}(m_2\Lambda_1)$. Each connected component has a lowest weight element. Then, we prove the lowest elements connected with $\phi \otimes \phi$.

For $b_1 \in B^{G_2}(m_1\Lambda_1)$, $b_2 \in B^{G_2}(m_2\Lambda_1)$, there exist a sequence (i_1, \dots, i_k) ($i_n \in \{1, 2\}, n = 1, \dots, k$) such that $\tilde{f}_{i_1} \cdots \tilde{f}_{i_k} b_1 \otimes b_2$ is a lowest weight element $b'_1 \otimes \left[[1]^{m_2} \right] \in B^{G_2}(m_1\Lambda_1) \otimes B^{G_2}(m_2\Lambda_2)$. We can express

$$\tilde{f}_{i_1} \cdots \tilde{f}_{i_k} b_1 \otimes b_2 = b'_1 \otimes \left[[1]^{m_2} \right].$$

Then there exists $b''_1 \in B^{G_2}(m'_1\Lambda_1)$ such that

$$\tilde{f}_0^{(\varphi_0(b'_1) - m_2) + m_2} b'_1 \otimes \left[[1]^{m_2} \right] = b''_1 \otimes \phi.$$

There exist another sequence $(i'_1, \dots, i'_{k'})$ ($i'_n \in \{1, 2\}, n = 1, \dots, k'$) such that $\tilde{f}_0^{m'_1} \tilde{f}_{i'_1} \cdots \tilde{f}_{i'_{k'}} b''_1$ is lowest weight element $\left[[1]^{m'_1} \right]$. Therefore we can express as

$$\tilde{f}_0^{m'_1} \tilde{f}_{i'_1} \cdots \tilde{f}_{i'_{k'}} b''_1 \otimes \phi = \tilde{f}_0^{m'_1} \left[[1]^{m'_1} \right] \otimes \phi = \phi \otimes \phi.$$

Then we have

$b_1 \otimes b_2$ is connected with $\phi \otimes \phi$.

By §5.4, §5.5 we have Theorem 2.2.

Perfect crystal of level 2

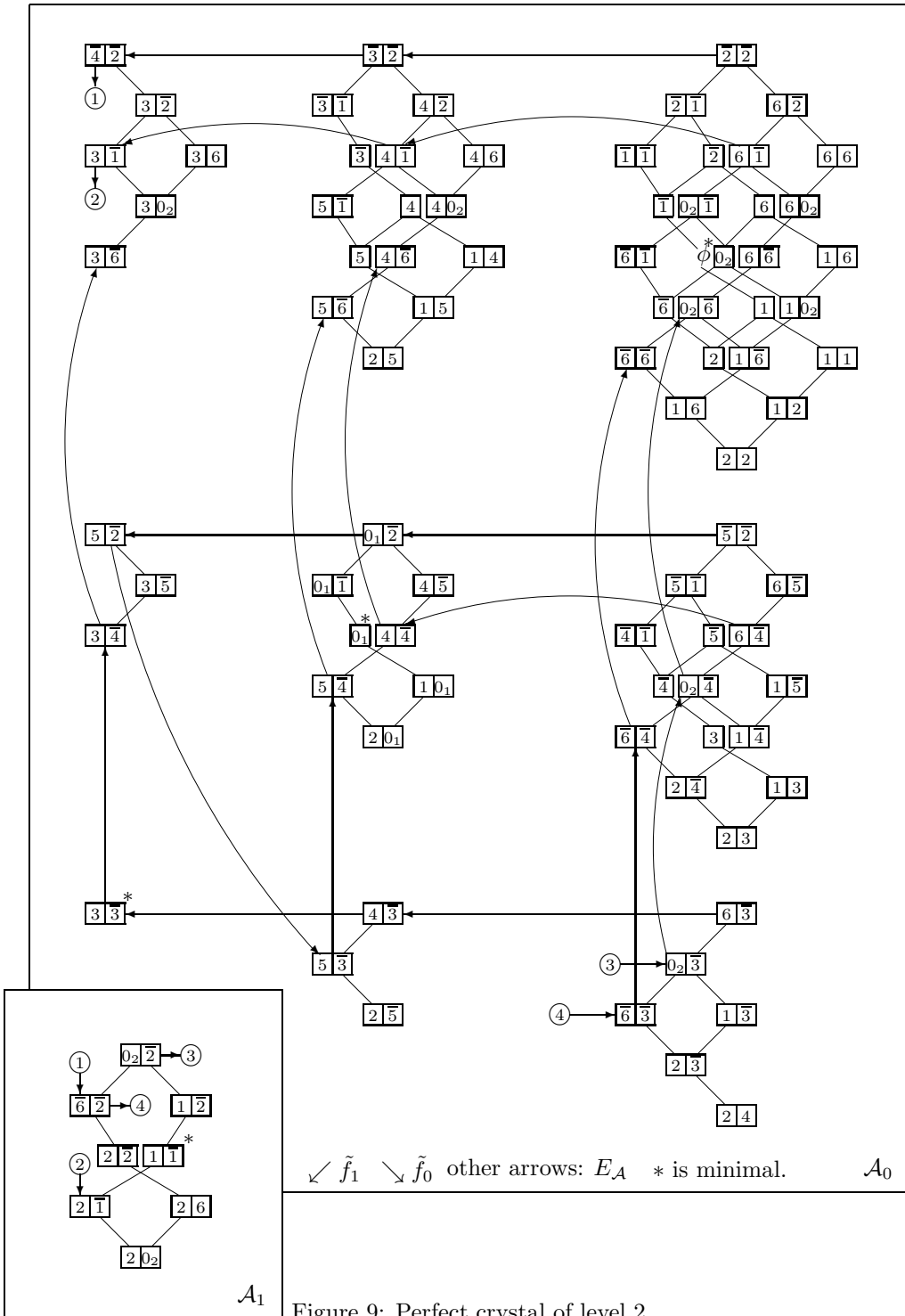

Figure 9: Perfect crystal of level 2

References

- [1] V.G.Drinfeld, Hopf algebra and the Yang-Baxter equation, *Soviet Math. Dokl.* **32** (1985), 254–258.
- [2] M.Jimbo, A q-difference analogue of $U(\mathfrak{g})$ and the Yang-Baxter equation, *Lett. Math. Phys.* **10** (1985), 63–69.
- [3] M.Kashiwara, Crystalizing the q-analogue of universal enveloping algebras, *Comm. Math. Phys.* **133** (1990), 249–260.
- [4] M.Kashiwara, On crystal bases of the q-analogue of universal enveloping algebras, *Duke Math. J.* **63** (1991), 456–516.
- [5] M.Kashiwara, Global crystal bases of quantum groups, *Duke Math. J.* **69** (1993), 455–485.
- [6] M.Kashiwara and T.Nakashima, Crystal graphs for representations of q-analogue of classical Lie algebras, *J. Algebra* **165** (1994), 295–345.
- [7] S-J.Kang and K.C.Misra, Crystal bases and tensor product decompositions of $U_q(G_2)$ -module, *J. Algebra* **163** (1994), 675–691.
- [8] S-J.Kang, M.Kashiwara, K.C.Misra, T.Miwa, T.Nakashima, and A.Nakayashiki, Perfect Crystal of Quantum Affine Lie Algebras, *Duke Math. J.* **68** (1992), 499–607.
- [9] S-J.Kang, M.Kashiwara, K.C.Misra, T.Miwa, T.Nakashima, and A.Nakayashiki, Perfect Crystal and Vertex Models, *Internat. J. Modern Phys. A* **7** (1992) 449–484.
- [10] A.Kuniba, Quantum R Matrix for G_2 and a Solvable 175-vertex model, *J. Phys. A: Math. Gen.* **23** (1990) 1349–1362.
- [11] P.Littelmann, A Littlewood-Richardson Rule for Symmetrizable Kac-Moody Algebra, *Invent. Math.* **116** (1994), 295–345.
- [12] S-J.Kang, M.Kashiwara and K.C.Misra, Crystal bases of Verma Modules for Quantum Affine Lie Algebras, *Compositio Math* **92** (1994), 299–325.
- [13] W.G.McKay, J.Patera and D.W.Rand TABLES OF REPRESENTATIONS OF SIMPLE LIE ALGEBRAS Volume I. Exceptional Simple Lie Algebras *Centre de Recherches Mathématiques Université de Montréal*