

Non-perturbative model for the half-off-shell γNN vertex

S. Kondratyuk, O. Scholten

Kernfysisch Versneller Instituut, 9747 AA Groningen, The Netherlands.

(October 20, 2018)

Abstract

Form factors in the nucleon-photon vertex with one off-shell nucleon are calculated by dressing the vertex with pion loops up to infinite order. Cutting rules and dispersion relations are implemented in the model. Using the prescription of minimal substitution we construct a $\gamma\pi NN$ vertex and show that it has to be included in the model in order that the Ward-Takahashi identity for the γNN vertex be fulfilled. The vertex is to be applied in a coupled-channel K-matrix formalism for Compton scattering, pion photoproduction and pion scattering. The form factors show a pronounced cusp structure at the pion threshold. As an illustration of a consistent application of the model, we calculate the cross section of Compton scattering. To provide gauge invariance in Compton scattering, a four-point $\gamma\gamma NN$ contact term is constructed using minimal substitution.

Key Words: Off-shell form factors, Nucleon-photon vertex, K-matrix formalism, Compton scattering.

1999 PACS: 13.40.Gp, 13.60.-r, 14.20.Dh, 13.60.Fz

Corresponding author:

S. Kondratyuk, Kernfysisch Versneller Instituut
Zernikelaan 25, 9747 AA Groningen, The Netherlands
e-mail: KONDRAT@KVI.NL,
phone: +31-(0)50-3636192, fax: +31-(0)50-3634003

----- October 20, 2018 -----

Typeset using REVTeX

I. INTRODUCTION

The nucleon-photon vertex function is parametrized by form factors that depend on relevant Lorentz-invariants. For instance, the γNN vertex with both nucleons on the mass shell has two form factors that are functions of only one argument, the four-momentum squared of the photon. A more complicated form of the vertex is encountered if one of the nucleons is allowed to be off-shell. In general, such a vertex contains 6 form factors which depend on the four-momentum squared of the off-shell nucleon [1] (so-called half-off-shell form factors).

Electromagnetic vertices of the nucleon with one or both off-shell nucleons have been studied in the past. The method of dispersion relations was applied in Refs. [1–4]. Dynamical models based on a perturbative dressing of the vertex with meson loops, within effective Lagrangian approaches, were developed in articles [5–9]. The role of off-shell nucleon-photon form factors has been investigated, for example, in models for proton-proton bremsstrahlung [10–12] and virtual Compton scattering [13].

In this paper the half-off-shell electromagnetic form factors of the nucleon are calculated in a model based on an integral equation for the γNN vertex. This non-perturbative approach comprises nucleons and pions as hadronic degrees of freedom, and the vertex is dressed with pion loops up to infinite order. The dressed half-off-shell nucleon-pion vertex and the nucleon propagator, necessary for the equation, were calculated in [14] within a framework consistent with the present model. The equation is solved using an iterative procedure, without introducing bare form factors in the zeroth iteration vertex. At each iteration step, the imaginary parts of the loop integrals are found by applying Cutkosky rules [15]. In doing so, only the discontinuities related to the intermediate states with one nucleon and one pion are taken into account in the loop integrals. The real parts are constructed using dispersion relations [1]. The dispersion integrals converge due to the sufficiently fast falloff of the πNN form factors in the loop diagrams. The resulting γNN vertex is normalized in such a way that, at the point where both nucleons are on-shell, it reproduces the physical anomalous magnetic moment of the nucleon.

The γNN vertex must satisfy the Ward-Takahashi identity [16]. This is achieved in our model by including in the equation a loop diagram with a four-point $\gamma\pi NN$ vertex (the contact term). The latter is constructed based on the dressed πNN vertex using the minimal substitution prescription (various constructions of contact terms can be found in, e.g. [17–19]). Here we use the technique of variational derivatives applied to an action functional with higher derivatives corresponding to the half-off-shell πNN vertex. Such a procedure leads to a unique result only for the longitudinal (with respect to the four-momentum of the photon) part of the four-point vertex. To investigate the role of the transverse terms, we calculated the electromagnetic form factors utilizing two different $\gamma\pi NN$ vertices. We found that the transverse terms affect chiefly the form factors related to negative-energy states of the off-shell nucleon.

The principle behind our approach can be outlined as follows. Given an interaction Lagrangian in terms of hadronic fields, one can use it to calculate the scattering amplitude for certain scattering processes (to be specific, we consider Compton scattering, pion photoproduction and pion scattering). In general, both real and imaginary parts of the loop integrals will be included in this amplitude. Instead of the above approach, we follow an alternative

scheme. Namely, first we construct dressed half-off-shell γNN and πNN vertices as well as the dressed nucleon propagator. This corresponds to constructing effective nucleon-photon and nucleon-pion interactions accounting for the real parts of loop integrals in the amplitude. To calculate the full amplitude, these dressed vertices and nucleon propagator have to be used in a K-matrix formalism [20–22] since there the imaginary parts of the loop integrals are generated as part of the method. It is important to note that in such a scheme one avoids double counting of the loop diagrams. This aspect is discussed in Section V.

To provide current conservation in the description of Compton scattering, one needs a contact $\gamma\gamma NN$ term. We build such a term by minimal substitution, applying a technique somewhat different (though equivalent) to that used for the construction of the $\gamma\pi NN$ vertex. As an application of the model, we calculate the cross section for Compton scattering, where the K-matrix is constructed using the dressed γNN and πNN vertices and the nucleon propagator. The result is compared with the cross section computed using the K-matrix in which bare vertices and the free nucleon propagator are substituted. These calculations both satisfy the low-energy theorem [23,24]. It follows from this theorem that in an expansion of the cross section in the photon energy, only the leading term – the Thomson cross section – does not depend on a particular model used for the description of the process. For the simplified case where no magnetic form factors are included in the vertex, we calculated the next-to-leading order term (quadratic in the photon energy) in the expansion of the forward scattering cross section. It is expressed in terms of two scalar functions parametrizing the renormalized dressed nucleon propagator.

In connection with applications of off-shell form factors for calculation of physical observables, the following caveats are in order. In principle, one should utilize off-shell vertices to obtain various reaction amplitudes and calculate the observables from the corresponding S-matrix. However, the off-shell form factors by themselves cannot be directly measured. In particular, they can be changed by a redefinition of the nucleon field. At the same time, the field redefinition will in general also change the four- and higher-point vertices. It is known that the S-matrix is independent of the representation of the fields [25]. Therefore, in a consistent calculation of the observables three- and higher-point Green’s functions should be treated using the same model assumptions and representation of the fields. The link between off-shell effects and contact interactions was emphasized in [26], where Compton scattering by a pion was considered in the framework of chiral perturbation theory. Also, pion-nucleon scattering in a particular model was used recently [27] to demonstrate how a redefinition of the nucleon field changes the off-shell dependence in three-point πNN vertices and leads to occurrence of a four-point $\pi\pi NN$ vertex, such that the total scattering amplitude calculated using the two field representations remains the same. Symmetries of the theory can relate Green’s functions with different numbers of external lines, the electromagnetic Ward-Takahashi identities [16,28] being a relevant example. The four-point $\gamma\pi NN$ and $\gamma\gamma NN$ vertices constructed in this paper are derived observing the requirement of current conservation for the pion photoproduction and Compton scattering amplitudes.

The paper is organized as follows. The general structure of the nucleon-photon vertex and its reduction to the half-off-shell cases are given in Section II. The equation for the vertex is presented in Section III.A. The solution procedure is described in detail in Section III.B. In particular, Section III.B.1 explains a mathematical method used to project the imaginary parts of the form factors from the general expressions for the discontinuities of

the loop integrals on the right-hand side of the equation. The projection method is applied in Sections III.B.2, III.B.3 to two of the three loop integrals. The minimal substitution procedure is employed in Section III.B.4 to construct a contact $\gamma\pi NN$ vertex based on the general expression for the half-off-shell nucleon-pion vertex, followed in Section III.B.5 by the calculation of the discontinuity of the remaining third loop integral. The dispersion relations utilized to find the real parts of the form factors are given in Section III.B.6. Results for the form factors are discussed in Section IV. In Section V we argue that the half-off-shell γNN and πNN vertices and the dressed nucleon propagator calculated in the framework of our model can be consistently applied in a coupled-channel K-matrix formalism in such a way that double counting is avoided. To apply the model to (real) Compton scattering, we need first to construct a contact $\gamma\gamma NN$ vertex. Such a vertex (or rather its matrix element between on-shell nucleon states) is given in Section VI.A. Some results of the application of the model to Compton scattering are presented in Section VI.B. Section VI.B.1 contains a calculation of the next-to-leading order term in the low-energy expansion of the cross section for an illustrative case where the magnetic form factors are excluded from the vertex. Section VII concludes the paper. Appendices A and B contain technical details of the minimal substitution procedure utilized to construct the contact $\gamma\pi NN$ and $\gamma\gamma NN$ vertices. In Appendix C we prove that a gauge invariant amplitude for pion photoproduction can be constructed using the contact $\gamma\pi NN$ term and use this result to show that the equation for the nucleon-photon vertex is consistent with the Ward-Takahashi identity.

II. STRUCTURE OF THE γNN VERTEX

We consider the (irreducible) γNN vertex operator which, in principle, is the sum of all connected Feynman diagrams with one incoming nucleon (carrying the four-momentum p), one outgoing nucleon (p') and one photon ($q = p - p'$), with the propagators for the external legs stripped away. The most general Lorentz covariant form can be written as [1]¹

$$-ie\Gamma_\mu(p', p) = -ie \sum_{k,l=\pm} \Lambda_k(p') \left\{ \gamma_\mu F_1^{kl} - i \frac{\sigma_{\mu\nu} q^\nu}{2m} F_2^{kl} - \frac{q_\mu}{m} F_3^{kl} \right\} \Lambda_l(p). \quad (1)$$

In this formula, e and m are the elementary electric charge and the mass of the nucleon, the operators

$$\Lambda_\pm(p) \equiv \frac{\pm\not{p} + m}{2m}, \quad (2)$$

and the 12 functions (form factors) F_i^{kl} depend on the momenta squared of the three particles in the vertex, $F_i^{kl} = F_i^{kl}(p'^2, p^2, q^2)$. We will consider only real photons throughout the paper, i.e. $q^2 = 0$, and hence omit the argument q^2 of the form factors. In the description of physical processes, the vertex Eq. (1) will always enter in the scalar product $\Gamma(p', p) \cdot \epsilon$ with the polarization vector ϵ^μ of the photon. Since $q \cdot \epsilon = 0$ for real photons, the form factors F_3^{kl} will be dropped from further consideration in this paper. The isospin structure

¹We use the Dirac representation for the γ -matrices (see the appendix in the textbook [29])

of the vertex is $\Gamma_\mu = \Gamma_\mu^s + \tau_3 \Gamma_\mu^v$, where Γ_μ^s and Γ_μ^v are the isoscalar and isovector parts, and $\tau_3 = \text{diag}(1, -1)$ is the third Pauli matrix. Correspondingly, the form factors have a similar decomposition in the isospin space, $F_i^{kl} = (F_i^{kl})^s + \tau_3 (F_i^{kl})^v$. Thus, the cases of the proton-photon and neutron-photon vertices correspond to taking the form factors $(F_i^{kl})^s + (F_i^{kl})^v$ and $(F_i^{kl})^s - (F_i^{kl})^v$, respectively.

Invariance of the theory with respect to charge conjugation and space-time inversion allows one to write the following relations for the vertex [23]:

$$C^{-1} \Gamma_\mu(p', p) C = -\Gamma_\mu^T(-p, -p'), \quad (3)$$

$$\gamma_5 \Gamma_\mu(p', p) \gamma_5 = -\Gamma_\mu(-p', -p), \quad (4)$$

where $C = i\gamma_2\gamma_0$ is the charge conjugation matrix. Applying these two symmetry transformations successively gives

$$\gamma_1\gamma_3 \Gamma_\mu(p', p) \gamma_3\gamma_1 = \Gamma_\mu^T(p, p'). \quad (5)$$

On substituting Eq. (1) in Eq. (5) one obtains the following relations among the form factors:

$$F_{1,2}^{kl}(p'^2, p^2) = F_{1,2}^{lk}(p^2, p'^2). \quad (6)$$

For the course of this paper, we will be interested in the so-called half-off-shell vertices in which only one of the nucleons is off-shell, i.e. either $p'^2 = m^2$ and $\bar{u}(p') \not{p}' = \bar{u}(p') m$ or $p^2 = m^2$ and $\not{p} u(p) = m u(p)$, where $u(p)$ is the positive energy spinor of the nucleon with the four-momentum p . These vertices will be denoted $\Gamma_\mu(m, p)$ and $\Gamma_\mu(p', m)$, respectively. Using Eqs. (6) with $p'^2 = m^2$, one can relate the form factors in the half-off-shell vertices with the incoming and outgoing on-shell nucleons. We denote $F_i^{++}(m^2, p^2) \equiv F_i^+(p^2)$ and $F_i^{+-}(m^2, p^2) \equiv F_i^-(p^2)$ and call these functions the half-off-shell form factors. If the outgoing nucleon is on-shell, one obtains from Eq. (1)

$$\bar{u}(p') \Gamma_\mu(m, p) = \bar{u}(p') \sum_{l=\pm} \left\{ \gamma_\mu F_1^l(p^2) - i \frac{\sigma_{\mu\nu} q^\nu}{2m} F_2^l(p^2) \right\} \Lambda_l(p). \quad (7)$$

Similarly, for the incoming on-shell nucleon,

$$\Gamma_\mu(p', m) u(p) = \left(\sum_{k=\pm} \Lambda_k(p') \left\{ \gamma_\mu F_1^k(p'^2) - i \frac{\sigma_{\mu\nu} q^\nu}{2m} F_2^k(p'^2) \right\} \right) u(p). \quad (8)$$

III. DESCRIPTION OF THE MODEL

A. Basic ingredients

The model is based on the following integral equation for the vertex:

$$\begin{aligned}
\Gamma_\mu(m, p) &= \Gamma_\mu^0(m, p) - i \int \frac{d^4k}{(2\pi)^4} \Gamma_{5,\alpha}(m, p-k) S(p-k) \Gamma_{5,\beta}(p-k, p) D((k-q)^2) \\
&\quad \times V_{\mu,\alpha\beta}(k-q, k) D(k^2) - i \int \frac{d^4k}{(2\pi)^4} \Gamma_{5,\alpha}(m, p'-k) S(p'-k) \\
&\quad \times \Gamma_\mu(p'-k, p-k) S(p-k) \Gamma_{5,\alpha}(p-k, p) D(k^2) \\
&\quad - i \int \frac{d^4k}{(2\pi)^4} M_{\mu,\alpha}(m, p-k, q) S(p-k) \Gamma_{5,\alpha}(p-k, p) D(k^2) \\
&\quad - i \int \frac{d^4k}{(2\pi)^4} \Gamma_{5,\alpha}(m, p'-k) S(p'-k) M_{\mu,\alpha}(p'-k, p, q) D(k^2),
\end{aligned} \tag{9}$$

represented graphically in Fig. 1. This equation expresses the dressing of a bare vertex $\Gamma_\mu^0(m, p)$ with an infinite series of pion loops.

In Eq. (9), $\Gamma_{5,\alpha}(p', p)$ denotes the nucleon-pion vertex function, where the incoming and the outgoing nucleons have four-momenta p and p' , respectively. Although both nucleons can be off-shell in the πNN vertex, we shall need only half-off-shell vertices in our model as will become clear below. For example, if the outgoing nucleon is on the mass shell, one has $p'^2 = m^2$ and $\bar{u}(p') \not{p}' = \bar{u}(p') m$. Acting with the nucleon-pion vertex on $\bar{u}(p')$ to the left gives

$$\bar{u}(p') \Gamma_{5,\alpha}(m, p) = \bar{u}(p') \tau_\alpha \Gamma_5(m, p) = \bar{u}(p') \tau_\alpha \gamma_5 \left(G_1(m^2, p^2, k^2) + \frac{\not{p}' - m}{m} G_2(m^2, p^2, k^2) \right), \tag{10}$$

where $k = p - p'$ is the four-momentum of the pion. The functions $G_{1,2}(m^2, p^2, k^2)$ are the (half-off-shell) form factors in the nucleon-pion vertex. If the incoming nucleon is on-shell and the outgoing one is off-shell, the action of the vertex on $u(p)$ to the right reads

$$\Gamma_{5,\alpha}(p', m) u(p) = \tau_\alpha \Gamma_5(p', m) u(p) = \tau_\alpha \left(G_1(p'^2, m^2, k^2) + \frac{\not{p}' - m}{m} G_2(p'^2, m^2, k^2) \right) \gamma_5 u(p). \tag{11}$$

$S(p)$ is the renormalized dressed nucleon propagator for which the following parametrization is used:

$$(S(p))^{-1} = \alpha(p^2) (\not{p} - \xi(p^2)). \tag{12}$$

The functions $\alpha(p^2)$, $\xi(p^2)$, as well as $G_{1,2}(m^2, p^2, m_\pi^2)$ (m_π being the mass of the pion), were calculated in the model of Ref. [14]. We will use these results here. The dependence of the nucleon-pion form factors on the four-momentum squared of the pion k^2 , at least for $k^2 \leq m_\pi^2$, can be inferred from a generalization of the aforementioned model. This will be discussed below in more detail.

$D(k^2)$ is the pion propagator function. For simplicity, we use the free Feynman propagator, $(D(k^2))^{-1} = k^2 - m_\pi^2$. The pion-photon vertex $V_{\mu,\alpha\beta}(k', k)$ is chosen such that the Ward-Takahashi identity is fulfilled with the free propagator $D(k^2)$,

$$(k' - k)^\mu V_{\mu,\alpha\beta}(k', k) = (\hat{e}_\pi)_{\alpha\beta} \left[(D(k'^2))^{-1} - (D(k^2))^{-1} \right], \tag{13}$$

giving $V_{\mu,\alpha\beta}(k', k) = (\hat{e}_\pi)_{\alpha\beta} (k_\mu + k'_\mu)$, where the pion charge operator $(\hat{e}_\pi)_{\alpha\beta} = -i\epsilon_{\alpha\beta 3}$.

The function $M_{\mu,\alpha}(p', p, q)$ in Eq. (9) denotes a contact $\pi\gamma NN$ vertex, where p' and p are the momenta of the outgoing and incoming nucleons, respectively, and q is the four-momentum of the (outgoing) photon. The construction of the contact vertex will be described in Section III.B.4. Here we only mention that the two last terms in Eq. (9) are required for the γNN vertex to satisfy the Ward-Takahashi identity.

Finally, the first term on the right-hand side of Eq. (9) is a “bare” nucleon-photon vertex. We use the following form:

$$\bar{u}(p')\Gamma_{\mu}^0(m, p) = \bar{u}(p')(\gamma_{\mu}\hat{e}_N - i\kappa_B\frac{\sigma_{\mu\nu}q^{\nu}}{2m}), \quad (14)$$

where the nucleon charge operator $\hat{e}_N = (1 + \tau_3)/2$. The constant κ_B is a bare anomalous magnetic moment of nucleon. It has the standard isospin decomposition $\kappa_B = (\kappa_B)^s + \tau_3(\kappa_B)^v$ and is to be adjusted to provide the normalization of the dressed vertex, which will be discussed in Section III.B.6.

B. Solution procedure

To construct a solution of Eq. (9), an iterative procedure is utilized. First, we note that all integrals on the right-hand side of Eq. (9), except the second one, are inhomogeneities of the equation because they do not depend on the γNN vertex. Therefore, they need to be calculated only once. We start with the first integral which we denote $\Gamma_{\mu}(1)$ (the other three integrals will be denoted $\Gamma_{\mu}(2)$, $\Gamma_{\mu}(3)$ and $\Gamma_{\mu}(4)$). Consider the pole contribution, $\Gamma_{\mu,I}(1)$, to this integral. It comes from cutting the nucleon propagator $S(p-k)$ and the pion propagator $D(k^2)$, i.e. from putting the corresponding particles on their mass shell (see the upper left diagram in Fig. 2). The imaginary parts of the form factors $F_i^{\pm}(p^2)$ are obtained from such pole contributions to all the loop integrals on the right-hand side of Eq. (9). According to Cutkosky rules [15], we replace $S(p-k)$ with $-2i\pi(\not{p} - \not{k} + m)\delta((p-k)^2 - m^2)\Theta(p_0 - k_0)$ and $D(k^2)$ with $-2i\pi\delta(k^2 - m_{\pi}^2)\Theta(k_0)$. One of the advantages of the use of cutting rules is that throughout the solution procedure we need vertices with only one off-shell nucleon. In other words, the knowledge of *full*-off-shell form factors will not be required for the calculation of the pole contributions to the loop integrals, as can be seen from Fig. 2.

In evaluating $\Gamma_{\mu,I}(1)$, only real parts of the nucleon-pion form factors G_i are taken into account. As will be shown in Section V, this is consistent with the usage of these vertices and nucleon self-energy in a K-matrix approach to pion-nucleon scattering, pion photoproduction and Compton scattering [21,22]. The same qualification will apply to the pole contributions of all loop integrals in Eq. (9) (see Fig. 2).

Denoting $g_i \equiv \text{Re}G_i$, we have for the pole contribution:

$$\begin{aligned} \Gamma_{\mu,I}(1) &= \frac{2\tau_3}{8\pi^2} \int d^4k \gamma_5 g_1(m^2, m^2, (k-q)^2) (\not{p} - \not{k} + m) \gamma_5 \\ &\quad \times \left[g_1(m^2, p^2, m_{\pi}^2) + \frac{\not{p} - m}{m} g_2(m^2, p^2, m_{\pi}^2) \right] \frac{2k_{\mu} - q_{\mu}}{(k-q)^2 - m_{\pi}^2} \\ &\quad \times \delta((p-k)^2 - m^2) \Theta(p_0 - k_0) \delta(k^2 - m_{\pi}^2) \Theta(k_0). \end{aligned} \quad (15)$$

The isospin factor $2\tau_3$ occurs due to multiplying Pauli matrices at the nucleon-pion vertices with the pion charge operator: $\tau_{\alpha}(\hat{e}_{\pi})_{\alpha\beta}\tau_{\beta} = 2\tau_3$.

1. Projection method

In this section we describe a method used to project out the imaginary parts of the form factors. This method will be applied to the pole contributions from the integrals in Eq. (9).

Suppose we consider the half-off-shell vertex Eq. (7). It can be regarded as an element of a six-dimensional vector space V_6 with the basis

$$\begin{aligned} (e_1)_\mu &= \Lambda_+(p')\gamma_\mu\Lambda_+(p), & (e_2)_\mu &= \Lambda_+(p')\gamma_\mu\Lambda_-(p), \\ (e_3)_\mu &= \Lambda_+(p')(-i)\frac{\sigma_{\mu\nu}q^\nu}{2m}\Lambda_+(p), & (e_4)_\mu &= \Lambda_+(p')(-i)\frac{\sigma_{\mu\nu}q^\nu}{2m}\Lambda_-(p), \\ (e_5)_\mu &= \Lambda_+(p')(-)\frac{q_\mu}{m}\Lambda_+(p), & (e_6)_\mu &= \Lambda_+(p')(-)\frac{q_\mu}{m}\Lambda_-(p), \end{aligned} \quad (16)$$

defined over a ring of complex-valued functions (form factors). For example, the integral of Eq. (15), multiplied from the left by $\Lambda_+(p')$, belongs to V_6 , $v_\mu(1) = \Lambda_+(p')\Gamma_{\mu,I}(1) \in V_6$. Thus, to find contributions to the imaginary parts of the form factors F_i^\pm from the integral $\Gamma_{\mu,I}(1)$ amounts to finding the coefficients in an expansion of $v_\mu(1)$ over the basis Eq. (16).

The dual space V_6^* can be defined as spanned over the basis $(\theta^i)^\mu = g^{\mu\lambda}(\overline{e_i})_\lambda$, where the over-lining denotes the Dirac conjugate of an operator, $\overline{A} \equiv \gamma_0 A^\dagger \gamma_0$. Explicitly, we have

$$\begin{aligned} (\theta^1)^\mu &= \Lambda_+(p)\gamma^\mu\Lambda_+(p'), & (\theta^2)^\mu &= \Lambda_-(p)\gamma^\mu\Lambda_+(p'), \\ (\theta^3)^\mu &= \Lambda_+(p)i\frac{\sigma^{\mu\nu}q_\nu}{2m}\Lambda_+(p'), & (\theta^4)^\mu &= \Lambda_-(p)i\frac{\sigma^{\mu\nu}q_\nu}{2m}\Lambda_+(p'), \\ (\theta^5)^\mu &= \Lambda_+(p)(-)\frac{q^\mu}{m}\Lambda_+(p'), & (\theta^6)^\mu &= \Lambda_-(p)(-)\frac{q^\mu}{m}\Lambda_+(p'). \end{aligned} \quad (17)$$

For any one-form $\omega^\mu \in V_6^*$ and any vector $v_\mu \in V_6$, we define the action of ω^μ on v_μ by the pairing

$$\langle \omega^\mu, v_\mu \rangle = tr(\omega^\mu v_\mu), \quad (18)$$

with a tacit summation over μ . Now if

$$v_\mu = \sum_{i=1}^6 c^i (e_i)_\mu, \quad (19)$$

then the coefficients are obtained from the formula

$$c^k = \sum_{l=1}^6 (E^{-1})_l^k \langle (\theta^l)^\mu, v_\mu \rangle, \quad (20)$$

where the matrix $E_j^i = \langle (\theta^i)^\mu, (e_j)_\mu \rangle$. The coefficients c^k are the form factors (or, more precisely, contributions to the imaginary parts of the form factors). Thus, we identify

$$\begin{aligned} c^1 &= ImF_1^+, & c^2 &= ImF_1^-, & c^3 &= ImF_2^+, \\ c^4 &= ImF_2^-, & c^5 &= ImF_3^+, & c^6 &= ImF_3^-. \end{aligned} \quad (21)$$

2. Calculating $\Gamma_{\mu,I}(1)$

We consider first the case in which only the contributions from the integral $\Gamma_{\mu,I}(1)$ are implied in Eq. (21), and therefore we denote the coefficients c^k as $c^k(1)$. Then for $v_\mu = v_\mu(1) = \Lambda_+(p')\Gamma_{\mu,I}(1)$, the right-hand side of Eq. (20) is an integral over a scalar function. The latter is found by taking traces of γ -matrices and performing matrix multiplications. These straightforward but tedious operations were done with the help of the algebraic programming system REDUCE [30].

More specifically, using Eq. (15) to find $v_\mu(1)$ and substituting the latter in Eq. (20) in the place of v_μ , we obtain

$$c^i(1) = \frac{2\tau_3}{8\pi^2} \int d^4k V^i(k) \frac{g_1(m^2, m^2, (k-q)^2)}{(k-q)^2 - m_\pi^2} \times \delta((p-k)^2 - m^2) \Theta(p_0 - k_0) \delta(k^2 - m_\pi^2) \Theta(k_0), \quad (22)$$

where

$$V^i(k) = \sum_{j=1}^6 (E^{-1})_j^i \left\langle (\theta^j)^\mu, \Lambda_+(p') \gamma_5 (\not{p} - \not{k} + m) \gamma_5 [g_1(m^2, p^2, m_\pi^2) + \frac{\not{p} - m}{m} g_2(m^2, p^2, m_\pi^2)] (2k_\mu - q_\mu) \right\rangle \quad (23)$$

is a scalar function of the four-momentum k_μ , the variable of integration. The integral in Eq. (22) is a Lorentz-scalar and therefore can be evaluated in any frame of reference. We choose the rest frame of the incoming nucleon, i.e. we put $p_\mu = w \delta_{\mu 0}$, where $w = \sqrt{p^2}$ is the invariant mass of the off-shell nucleon. Further, we call x the cosine of the polar angle between the three-vectors \vec{q} and \vec{k} . Then, due to the delta- and theta-functions, the integral in Eq. (22) can be reduced to the one-dimensional integral

$$c^i(1) = \tau_3 \frac{r(p^2)}{16\pi p^2} \Theta(p^2 - (m + m_\pi)^2) \int_{-1}^1 dx \tilde{V}^i(x) \frac{g_1(m^2, m^2, (k-q)^2)}{(k-q)^2 - m_\pi^2}, \quad (24)$$

where $r(p^2) = \sqrt{\lambda(p^2, m^2, m_\pi^2)}$, with the Källén function defined as $\lambda(x, y, z) \equiv (x - y - z)^2 - 4yz$. Here, the function $\tilde{V}^i(x)$ is obtained from $V^i(k)$ if one expresses scalar products of vectors in the problem in the variable x ,

$$(k \cdot q) = \frac{(p^2 + m_\pi^2 - m^2)(p^2 - m^2)}{4p^2} - \frac{r(p^2)(p^2 - m^2)}{4p^2} x, \quad (25)$$

$$(k \cdot p') = \frac{(p^2 + m_\pi^2 - m^2)(p^2 + m^2)}{4p^2} + \frac{r(p^2)(p^2 - m^2)}{4p^2} x, \quad (26)$$

and takes into account that $q = p - p'$. Finally, the integral in Eq. (24) is done numerically.

One point needs to be addressed here. The form factor $g_1(m^2, m^2, (k-q)^2)$ in Eq. (24) is pertinent to the nucleon-pion vertex with both nucleons on-shell and the pion off-shell. Taking into account that $p^2 \geq (m + m_\pi)^2$, it can be seen from Eq. (25) that $(k-q)^2 < m_\pi^2$,

for any $x \in [-1, 1]$. As mentioned above, the model of Ref. [14] can be generalized to find the form factors in the nucleon-pion vertex with the pion as well as one of the nucleons off-shell. Moreover, this generalization is possible in the framework of Ref. [14] only for the pion four-momenta squared less than or equal to the pion mass squared (otherwise the absolute values of external momenta in the nucleon-pion vertex would become complex). In the approach adopted in [14] we find that the dependence of $g_1(m^2, m^2, k^2)$ on k^2 is very weak (in fact, it is almost constant). A possible reason for this is that t-channel resonances, such as the ρ -meson, have not been included in the model. Thus, we have approximated $g_1(m^2, m^2, (k - q)^2)$ in Eq. (24) by the pion-nucleon coupling constant (we adopt the value from Ref. [22], $g = 13.02$).

3. Calculating $\Gamma_{\mu,I}(2)$

Now we turn to the pinching pole contribution from the second integral on the right-hand side of Eq. (9) (the second diagram in Fig. 2). Contrary to $\Gamma_\mu(1)$ considered above, this integral depends on the unknown half-off-shell γNN vertex and therefore has to be considered in the context of the iterative procedure applied to Eq. (9). Let $F_i^{\pm,n}(p^2)$ denote the form factors found after the n^{th} iteration step. When calculating $\Gamma_\mu^{n+1}(2)$, the $n+1^{\text{st}}$ iteration for $\Gamma_\mu(2)$, we will retain only the real parts of $F_i^{\pm,n}(p^2)$ as well as the nucleon-pion form factors and the functions $\alpha(p^2)$ and $\xi(p^2)$ parametrizing the nucleon propagator. The reason for doing so will be explained in Section V. So we introduce the notation $t_i^\pm(p^2) \equiv \text{Re}(F_i^\pm)^n(p^2)$ and $g_i(p^2) \equiv g_i(m^2, p^2, m_\pi^2)$. Also, only real parts of the functions $\alpha(p^2)$ and $\xi(p^2)$ are implied in the following formulas. The pole contribution to $\Gamma_\mu^{n+1}(2)$ can be explicitly written,

$$\begin{aligned}
\Gamma_{\mu,I}^{n+1}(2) &= \frac{1}{8\pi^2} \int d^4k \tau_\alpha \gamma_5 \left[g_1((p' - k)^2) + \frac{\not{p}' - \not{k} - m}{m} g_2((p' - k)^2) \right] (\not{p}' - \not{k} + \xi((p' - k)^2)) \\
&\times \left\{ \Lambda_+(p' - k) \left[\gamma_\mu t_1^+((p' - k)^2) - i \frac{\sigma_{\mu\nu} q^\nu}{2m} t_2^+((p' - k)^2) \right] \right. \\
&+ \left. \Lambda_-(p' - k) \left[\gamma_\mu t_1^-((p' - k)^2) - i \frac{\sigma_{\mu\nu} q^\nu}{2m} t_2^-((p' - k)^2) \right] \right\} \\
&\times (\not{p} - \not{k} + m) \tau_\alpha \gamma_5 \left[g_1(p^2) + \frac{\not{p} - m}{m} g_2(p^2) \right] \\
&\times \frac{1}{\alpha((p' - k)^2) [(p' - k)^2 - \xi^2((p' - k)^2)]} \\
&\times \delta((p - k)^2 - m^2) \Theta(p_0 - k_0) \delta(k^2 - m_\pi^2) \Theta(k_0). \tag{27}
\end{aligned}$$

Note that this expression contains both isoscalar and isovector parts. Indeed, since $t_i^\pm = (t_i^\pm)^s + \tau_3 (t_i^\pm)^v$, the isospin structure of the integrand is $\tau_\alpha [(t_i^\pm)^s + \tau_3 (t_i^\pm)^v] \tau_\alpha = 3(t_i^\pm)^s - (t_i^\pm)^v$.

In terms of the projection method described above, we have now $v_\mu = v_\mu(2) = \Lambda_+(p') \Gamma_{\mu,I}(2)$. The contributions to the imaginary parts of the form factors coming from $\Gamma_{\mu,I}^{n+1}(2)$ are found from Eq. (20),

$$c^{i,n+1}(2) = \frac{1}{8\pi^2} \int d^4k \frac{U^i(k)}{\alpha((p' - k)^2) [(p' - k)^2 - \xi^2((p' - k)^2)]}$$

$$\times \delta((p-k)^2 - m^2) \Theta(p_0 - k_0) \delta(k^2 - m_\pi^2) \Theta(k_0), \quad (28)$$

where

$$\begin{aligned} U^i(k) = & \sum_{j=1}^6 (E^{-1})_j^i \left\langle (\theta^j)^\mu, \Lambda_+(p') \left\{ \tau_\alpha \gamma_5 \left[g_1((p'-k)^2) + \frac{\not{p}' - \not{k} - m}{m} g_2((p'-k)^2) \right] \right. \right. \\ & \times \left. \left. \left(\not{p}' - \not{k} + \xi((p'-k)^2) \right) \right\} \left\{ \Lambda_+(p'-k) \left[\gamma_\mu t_1^+((p'-k)^2) \right. \right. \right. \\ & \left. \left. \left. - i \frac{\sigma_{\mu\nu} q^\nu}{2m} t_2^+((p'-k)^2) \right] + \Lambda_-(p'-k) \left[\gamma_\mu t_1^-((p'-k)^2) - i \frac{\sigma_{\mu\nu} q^\nu}{2m} t_2^-((p'-k)^2) \right] \right\} \right. \\ & \left. \times \left(\not{p} - \not{k} + m \right) \tau_\alpha \gamma_5 \left[g_1(p^2) + \frac{\not{p} - m}{m} g_2(p^2) \right] \right\rangle. \quad (29) \end{aligned}$$

We calculate the integral in Eq. (28) in the same frame of reference as the integral of Eq. (22). Substituting Eqs. (25,26) in Eq. (29) converts $U^i(k)$ to $\tilde{U}^i(x)$, and we obtain the one-dimensional integral

$$c^{i,n+1}(2) = \frac{r(p^2)}{32\pi p^2} \Theta(p^2 - (m + m_\pi)^2) \int_{-1}^1 dx \frac{\tilde{U}^i(x)}{\alpha((p'-k)^2)[(p'-k)^2 - \xi^2((p'-k)^2)]}, \quad (30)$$

which is evaluated numerically.

4. Construction of a $\gamma\pi NN$ vertex

Let us consider the last two integrals in Eq. (9) or rather the pole contributions associated with them. We cut the nucleon and pion propagators in the loops of the last two diagrams in Fig. 1. The pole contribution of the last integral equals zero for the following reason. By putting the pion and the nucleon in this integral on the mass shell, the following product of delta- and theta-functions emerges:

$$\delta((p'-k)^2 - m^2) \Theta(p'_0 - k_0) \delta(k^2 - m_\pi^2) \Theta(k_0), \quad (31)$$

where in addition $p'^2 = m^2$. This combination can only be non-zero if $m_\pi^2 - 2p'k = 0$. But using Eq. (26), it is clear that the last condition cannot be met for any $x \in [-1, 1]$, and hence the pole contribution to the last integral in Eq. (9) vanishes, $\Gamma_{\mu,I}(4) = 0$.

Consider next the pole contribution $\Gamma_{\mu,I}(3)$ to the second last integral in Eq. (9) (the lower picture in Fig. 2). It contains a ‘‘contact’’ $\gamma\pi NN$ vertex. We build such a vertex based on the dressed half-off-shell πNN vertices Eqs. (10,11). The latter can be rewritten as

$$\Gamma_\alpha^5(m, p) = \tau_\alpha \gamma^5 \left(g_{12}(p^2) + \frac{\not{p}}{m} g_2(p^2) \right) \quad (32)$$

and

$$\Gamma_\alpha^5(p', m) = \tau_\alpha \left(g_{12}(p'^2) + \frac{\not{p}'}{m} g_2(p'^2) \right) \gamma^5, \quad (33)$$

where we have suppressed the irrelevant arguments of the form factors. Also, as before, we retain only the real parts of the form factors, with the notation $g_{12} \equiv \text{Re}(G_1 - G_2)$ and $g_2 \equiv \text{Re} G_2$.

Let $\psi(x)$ and $\phi^\alpha(x)$ denote the nucleon spinor field and the pion pseudoscalar field, where the latter explicitly bears the isospin index. Then one can write an action integral S corresponding to a vertex which reduces to Eq. (32) or Eq. (33) if the outgoing or the incoming nucleon is on-shell, respectively. We write this action as the sum of two functionals, $S = I + J$, where

$$I = -i \int d^4x \bar{\psi} \gamma^5 \tau_\alpha \phi^\alpha [f(-\square)\psi] - i \int d^4x \overline{[f(-\square)\psi]} \phi^\alpha \tau_\alpha \gamma^5 \psi \quad (34)$$

and

$$J = \int d^4x \bar{\psi} \gamma^5 \tau_\alpha \phi^\alpha [g(-\square)\not{\partial}\psi] - \int d^4x \overline{[g(-\square)\not{\partial}\psi]} \phi^\alpha \tau_\alpha \gamma^5 \psi, \quad (35)$$

with the D'Alembertian $\square \equiv \partial^2 = \partial_\mu \partial^\mu$, and

$$f(-\square) = g_{12}(-\square) - \frac{g_1(m^2)}{2}, \quad g(-\square) = \frac{g_2(-\square)}{m}. \quad (36)$$

The functional S is hermitian by construction. $f(-\square)$ is to be understood as a formal series expansion in powers of $(-\square)$, corresponding to an expansion of $f(p^2)$ in powers of p^2 . Note that, in general, S contains higher (i.e. not only first) derivatives of the fields, thus it corresponds to a non-local action [31].

Taking this action functional as a starting point, one can construct a $\gamma\pi NN$ vertex by using the procedure of minimal substitution, see Appendix A.1 for details. The final result for the $\gamma\pi NN$ vertex can be written as

$$\begin{aligned} M_\alpha^\mu(p', p, q) = & -\tau_\alpha \hat{e} \left\{ \frac{2p^\mu + q^\mu}{(p+q)^2 - p^2} [\Gamma^5(m, p+q) - \Gamma^5(m, p)] \right. \\ & \left. + \gamma^5 \frac{g_2((p+q)^2)}{m} [\gamma^\mu - \not{q} \frac{2p^\mu + q^\mu}{(p+q)^2 - p^2}] \right\} \\ & - \hat{e} \tau_\alpha \left\{ \frac{2p'^\mu - q^\mu}{(p'-q)^2 - p'^2} [\Gamma^5(p'-q, m) - \Gamma^5(p', m)] \right. \\ & \left. + [\gamma^\mu + \frac{2p'^\mu - q^\mu}{(p'-q)^2 - p'^2} \not{q}] \frac{g_2((p'-q)^2)}{m} \gamma^5 \right\}, \quad (37) \end{aligned}$$

where Eqs. (A24,A26) and Eqs. (32,33,36) have been used. We emphasize that the photon four-momentum q_μ has been taken *incoming* throughout the construction of the contact term. The $\gamma\pi NN$ vertex with the outgoing photon four-momentum is obtained from Eq. (37) by reversing the signs in front of q_μ .

It should be stressed that Eq. (37) is not a unique form for the contact term in question. However, any other form that can be obtained in the framework of minimal substitution will differ from the given one by a term transverse to the four-momentum of the photon, and hence only the longitudinal part of the contact term is unambiguous. This is demonstrated in Appendix A.1 for an alternative $\gamma\pi NN$ vertex which is derived if one interchanges the

positions of \not{p} and $g(-\square)$ in the functional J . Using Eqs. (A24,A29) and Eqs. (32,33,36), this alternative contact term can be written

$$\begin{aligned}
(M_{alt})_{\alpha}^{\mu}(p', p, q) = & -\tau_{\alpha}\hat{e}\left\{\frac{2p^{\mu}+q^{\mu}}{(p+q)^2-p^2}[\Gamma^5(m, p+q)-\Gamma^5(m, p)]\right. \\
& \left. +\gamma^5\frac{g_2(p^2)}{m}[\gamma^{\mu}-\not{q}\frac{2p^{\mu}+q^{\mu}}{(p+q)^2-p^2}]\right\} \\
& -\hat{e}\tau_{\alpha}\left\{\frac{2p'^{\mu}-q^{\mu}}{(p'-q)^2-p'^2}[\Gamma^5(p'-q, m)-\Gamma^5(p', m)]\right. \\
& \left. +[\gamma^{\mu}+\frac{2p'^{\mu}-q^{\mu}}{(p'-q)^2-p'^2}\not{q}]\frac{g_2(p'^2)}{m}\gamma^5\right\}. \tag{38}
\end{aligned}$$

Minimal substitution was also employed in Ref. [17], where expressions similar to Eqs. (37,38) were obtained. The present method and that of [17] are essentially equivalent, a technical difference being that we explicitly calculate variational derivatives of the action functionals Eqs. (34,35) and extract the contact vertex from the variations of these functionals. As can be seen from the lower diagram in Fig. 2, only contact terms with all external legs on-shell are required in our model.

5. Calculating $\Gamma_{\mu,I}(3)$

Having constructed the $\gamma\pi NN$ vertex, the pole contribution $\Gamma_{\mu,I}(3)$ to the third integral on the right-hand side of Eq. (9) (the lower diagram in Fig. 2) can be calculated. Using the notation introduced above, we have

$$\begin{aligned}
\Gamma_{\mu,I}(3) = & -\frac{3-\tau_3}{2}\frac{1}{8\pi^2}\int d^4k\gamma_5\left\{(2p_{\mu}-2k_{\mu}-q_{\mu})\left[\frac{g_{12}((p-k-q)^2)-g_{12}(m^2)}{(p-k-q)^2-m^2}\right]\right. \\
& \left. +\frac{\not{p}-\not{k}}{m}\frac{g_2((p-k-q)^2)-g_2(m^2)}{(p-k-q)^2-m^2}\right] +\frac{\gamma_{\mu}}{m}g_2((p-k-q)^2)\left\}\right. \\
& \times(\not{p}-\not{k}+m)\gamma_5\left\{g_{12}(p^2)+\frac{\not{p}}{m}g_2(p^2)\right\} \\
& \times\delta((p-k)^2-m^2)\Theta(p_0-k_0)\delta(k^2-m_{\pi}^2)\Theta(k_0) \\
& -\frac{3}{2}(1+\tau_3)\frac{1}{8\pi^2}\int d^4k\left\{(2p'_{\mu}+q_{\mu})\left[\frac{g_{12}((p'+q)^2)-g_{12}(m^2)}{(p'+q)^2-m^2}\right]\right. \\
& \left. +\frac{g_2((p'+q)^2)-g_2(m^2)}{(p'+q)^2-m^2}\frac{\not{p}'}{m}\right] +\frac{\gamma_{\mu}}{m}g_2((p'+q)^2)\left\}\gamma_5(\not{p}-\not{k}+m)\gamma_5\right. \\
& \left.\times\left\{g_{12}(p^2)+\frac{\not{p}}{m}g_2(p^2)\right\}\delta((p-k)^2-m^2)\Theta(p_0-k_0)\delta(k^2-m_{\pi}^2)\Theta(k_0).\tag{39}
\end{aligned}$$

(Please note that, since in the γNN vertex we take the photon four-momentum outgoing, we have used here the contact vertex Eq. (37) where all q_{μ} are replaced with $-q_{\mu}$.) Another expression for $\Gamma_{\mu,I}(3)$ is obtained if, instead of Eq. (37), one uses the alternative contact term Eq. (38) (to save writing, we do not give the explicit formula here). The choice of the contact term has an influence on the nucleon-photon form factors, as will be described when discussing results of the calculations.

Applying Eq. (20) with $v_\mu = v_\mu(3) = \Lambda_+(p')\Gamma_{\mu,I}(3)$, one obtains for the contributions to the imaginary parts of the form factors:

$$c^i(3) = -\frac{r(p^2)}{64\pi p^2} \Theta(p^2 - (m + m_\pi)^2) \left[(3 - \tau_3) \int_{-1}^1 dx \widetilde{W}_1^i(x) + 3(1 + \tau_3) \int_{-1}^1 dx \widetilde{W}_2^i(x) \right], \quad (40)$$

where $r(p^2)$ is defined as in Eq. (22). Here, $\widetilde{W}_{1,2}^i(x)$ are obtained by using Eq. (25) in the functions

$$\begin{aligned} W_1^i(k) = & \sum_{j=1}^6 (E^{-1})_j^i \left\langle (\theta^j)^\mu, \Lambda_+(p') \gamma_5 \left\{ (2p_\mu - 2k_\mu - q_\mu) \left[\frac{g_{12}((p-k-q)^2) - g_{12}(m^2)}{(p-k-q)^2 - m^2} \right] \right. \right. \\ & \left. \left. + \frac{\not{p} - \not{k}}{m} \frac{g_2((p-k-q)^2) - g_2(m^2)}{(p-k-q)^2 - m^2} \right] + \frac{\gamma_\mu}{m} g_2((p-k-q)^2) \right\} (\not{p} - \not{k} + m) \gamma_5 \\ & \times \left\{ g_{12}(p^2) + \frac{\not{p}}{m} g_2(p^2) \right\} \end{aligned} \quad (41)$$

and

$$\begin{aligned} W_2^i(k) = & \sum_{j=1}^6 (E^{-1})_j^i \left\langle (\theta^j)^\mu, \Lambda_+(p') \left\{ (2p'_\mu + q_\mu) \left[\frac{g_{12}((p'+q)^2) - g_{12}(m^2)}{(p'+q)^2 - m^2} \right] \right. \right. \\ & \left. \left. + \frac{g_2((p'+q)^2) - g_2(m^2)}{(p'+q)^2 - m^2} \frac{\not{p}'}{m} \right] + \frac{\gamma_\mu}{m} g_2((p'+q)^2) \right\} \gamma_5 (\not{p} - \not{k} + m) \gamma_5 \\ & \times \left\{ g_{12}(p^2) + \frac{\not{p}}{m} g_2(p^2) \right\}, \end{aligned} \quad (42)$$

where the pairing $\langle \ , \ \rangle$ has been defined in Eq. (18).

Having thus calculated the pinching pole contribution to the loop integrals in Eq. (9), the imaginary parts of the form factors are found from Eq. (21), with $c^i = c^i(1) + c^i(2) + c^i(3)$. Gauge invariance of the full expression for the half-off-shell vertex is proved in Appendix C.

6. Calculating the real parts of the form factors using dispersion relations, and normalization of the vertex

Dispersion relations allow one to construct the real parts of the form factors from their imaginary parts. In the present model, we implement the dispersion relations in the iterative procedure in the following way. First, we note that the unsubtracted dispersion relations of the form

$$Re f(x) = \frac{\mathcal{P}}{\pi} \int_{x_0}^{\infty} dx' \frac{Im f(x')}{x' - x} \quad (43)$$

can be written for a function $f(z)$ which vanishes as $z \rightarrow \infty$ and is analytic in the complex z -plane ($x = Re z$) cut along the real axis from $x = x_0$ to infinity. Bincer proved [1] that the half-off-shell form factors $F_i^\pm(p^2)$ are analytic in the complex plane with the cut from the pion threshold $w_{th}^2 = (m + m_\pi)^2$ to infinity. In our model, the imaginary parts of the

form factors vanish at infinity, as will be seen from the results of the calculations. For the n^{th} iteration, we utilize the following dispersion relations for the form factors $F_2^\pm(p^2)$:

$$\text{Re}(F_2^{s,v})^n(p^2) = \kappa_B^{s,v} + \frac{\mathcal{P}}{\pi} \int_{w_{th}^2}^{\infty} dp'^2 \frac{\text{Im}(F_2^{s,v})^n(p'^2)}{p'^2 - p^2}, \quad (44)$$

where, to keep the expression transparent, we have dropped the superscripts \pm of the form factors on both sides of the equation. The constants $\kappa_B^{s,v}$ originate from the first term on the right-hand side of Eq. (9). Note that, according to Eq. (14), $\kappa_B^{s,v}$ are chosen the same for the form factors $F_2^+(p^2)$ and $F_2^-(p^2)$. They are fixed by the requirement that the vertex reproduces the physical anomalous magnetic moment when both nucleons are on-shell. In other words, the following normalization condition is imposed for the converged form factors:

$$F_2^{+,s}(m^2) = -0.06, \quad F_2^{+,v}(m^2) = 1.85. \quad (45)$$

Now we turn to the dispersion relations for the form factors $F_1^\pm(p^2)$. The behaviour of the real parts of $F_1^\pm(p^2)$ at infinity can be inferred from the Ward-Takahashi identity Eq. (C1). To this end, it is convenient to write down the inverse nucleon propagator Eq. (12) in the form

$$S^{-1}(p) = \not{p} - m - [A(p^2)\not{p} + B(p^2)m - (Z_2 - 1)(\not{p} - m) - Z_2\delta m]. \quad (46)$$

Here, the functions $A(p^2)$ and $B(p^2)$ parametrize the contribution to the nucleon self-energy from the pion loop dressing, and Z_2 and δm are real renormalization constants fixed so that the propagator has a pole at the nucleon mass with a unit residue. Now let the left- and right-hand sides of Eq. (C1) act on the positive-energy spinor $\bar{u}(p')$ from the left. Using Eq. (7) for the half-off-shell vertex and Eq. (46) for the inverse propagator and taking into account that $\bar{u}(p')S^{-1}(p') = 0$, the following expressions for the form factors $(F_1^\pm)^{s,v}(p^2)$ in terms of the self-energy functions A and B can be obtained:

$$(F_1^-)^{s,v}(p^2) = \frac{1}{2}[Z_2 - A(p^2)], \quad (47)$$

$$(F_1^+)^{s,v}(p^2) = -\frac{m}{p^2 - m^2}[mB(p^2) + Z_2(m - \delta m)] + \frac{p^2 + m^2}{2(p^2 - m^2)}[Z_2 - A(p^2)]. \quad (48)$$

As mentioned above, in this model we use the nucleon self-energy calculated in Ref. [14]. One relevant feature of the functions $A(p^2)$ and $B(p^2)$ constructed there is that they vanish at infinity, and thus the functions $(F_1^\pm)^{s,v}(p^2) - Z_2/2$ vanish for $p^2 \rightarrow \infty$, as follows from Eqs. (47,48). In addition, these functions possess the same analyticity properties as the form factors $(F_1^\pm)^{s,v}(p^2)$ themselves. Therefore, for the n^{th} iteration, the form factors $(F_1^\pm)^{s,v}(p^2)$ obey the dispersion relations

$$\text{Re}(F_1^{s,v})^n(p^2) = \frac{Z_2}{2} + \frac{\mathcal{P}}{\pi} \int_{w_{th}^2}^{\infty} dp'^2 \frac{\text{Im}(F_1^{s,v})^n(p'^2)}{p'^2 - p^2}, \quad (49)$$

omitting the superscripts \pm of the form factors.

In terms of the parametrization of the propagator Eq. (12), the relations in Eqs. (47,48) read

$$(F_1^-)^{s,v}(p^2) = \frac{\alpha(p^2)}{2} \quad (50)$$

and

$$(F_1^+)^{s,v}(p^2) = \frac{\alpha(p^2)m}{p^2 - m^2} \left[\frac{p^2 + m^2}{2m} - \xi(p^2) \right], \quad (51)$$

where $\lim_{p^2 \rightarrow m^2} (F_1^+)^{s,v}(p^2)$ is finite because $\lim_{p^2 \rightarrow m^2} \xi(p^2) = m$ due to the correct location of the pole of the renormalized propagator.

IV. RESULTS FOR THE FORM FACTORS

Using the iteration procedure described in the previous section, a solution was obtained for the half-off-shell nucleon-photon form factors. We considered the procedure converged at iteration n if all the results of this iterations were identical up to five significant digits with those of iterations $n + 1, \dots, n + 10$. With this convergence criterion, we needed 20 iterations to obtain the solution. It is noteworthy that the dominant contribution to the form factors is given by the first integral on the right-hand side of Eq. (9). Since this integral is an inhomogeneity of the equation, already the first iteration contains the bulk of the magnitude of the form factors. This, however, does not mean that the other integrals on the right-hand side of Eq. (9) are of minor importance. In particular, they are crucial for the vertex to satisfy the Ward-Takahashi identity.

As stated above, all results presented in this section are obtained using the half-off-shell πNN vertex and the nucleon self-energy calculated in Ref. [14]. In general, the half-off-shell πNN vertex, Eq. (10), contains both pseudovector and pseudoscalar couplings. The solution for the nucleon-pion form factors depends on the choice for the bare vertex in [14]. However, the half-width of the constructed pseudovector form factor is bound from above, and this feature persists independent of the choice of the bare form factor (called the "cut-off function" in [14]). For the present calculation of the half-off-shell form factors in the γNN vertex, we chose that solution for the nucleon self-energy and the πNN vertex in which the bare pseudovector form factor is given by Eq. (23) of Ref. [14], with the maximal half-width $\Lambda^2 = 1.28\text{GeV}^2$. We also did the calculation using the other choice of the bare πNN vertex, given by Eq. (24) of Ref. [14], with the half-width $\Lambda^2 = 1.33\text{GeV}^2$ (not shown). We found that the results for the nucleon-photon form factors do not depend significantly on the choice of the πNN vertex.

In Fig. 5 the imaginary and real parts of the form factors $F_2^+(p^2)$ (the solid line) and $F_2^-(p^2)$ (the dotted line) are shown for the case of the proton-photon vertex. One can see that the slope of $Im F_2^-(p^2)$ at the pion threshold, $p^2 = (m + m_\pi)^2$, is much steeper as compared to that of $Im F_2^+(p^2)$. As a consequence of this, we obtain a pronounced cusp-like behaviour of $Re F_2^-(p^2)$ at the threshold.

The form factors in Fig. 5 are calculated using the $\gamma\pi NN$ contact term of Eq. (37) when evaluating the third diagram in Fig. 2, as described in Section III.B.5. An alternative form of the $\gamma\pi NN$ vertex is given by Eq. (38). As is shown in Appendix A.1, the difference Δ^μ

between these two contact terms, Eq. (A30), is transverse to the photon four-momentum. To illustrate the influence of the different choices of the contact terms on the γNN vertex, in Fig. 6 we show the form factors $F_2^\pm(p^2)$ calculated using the alternative contact term. From a comparison of Figs. 5 and 6, it follows that the different choices of the contact term affect mainly the form factor $F_2^-(p^2)$. The form factor $F_2^+(p^2)$ is normalized at $p^2 = m^2$ to the physical anomalous magnetic moment of the nucleon and is only slightly sensitive to the choice of the contact term.

The results for the form factors $F_2^\pm(p^2)$ in the neutron-photon vertex are shown in Figs. 7 and 8 for the two choices of the $\gamma\pi NN$ vertex. The conclusions drawn above for the proton apply qualitatively to this case as well.

As described above, we normalize the vertex so that Eqs. (45) are fulfilled by the converged form factors $(F_2^+)^{s,v}$. This is achieved by adjusting the bare renormalization constants $\kappa_B^{s,v}$ defined in Eq. (14). Specifically, $\kappa_B^s = 0.03$ and $\kappa_B^v = 1.51$ for the case of the calculation in which the contact term Eq. (37) is employed, and $\kappa_B^s = 0$ and $\kappa_B^v = 1.6$ if the contact term Eq. (38) is used instead.

Since the γNN vertex obeys the Ward-Takahashi identity, the form factors $F_1^\pm(p^2)$ are uniquely determined by the functions parametrizing the nucleon propagator. We checked numerically that Eqs. (50,51) are fulfilled by the converged vertex, whereas a vertex obtained at any iteration before the full convergence has been achieved does not satisfy these constraints. One of the consequences of the Ward-Takahashi identity is that $(F_1^\pm)^s = (F_1^\pm)^v$ and therefore $F_1^\pm = 0$ for the case of the neutron-photon vertex. The form factors $F_1^\pm(p^2)$ in the proton-photon vertex are depicted in Fig. 9. Since the two forms of the contact $\gamma\pi NN$ term differ only by a part transverse to the photon four-momentum, the γNN vertex calculated with both of them will obey the Ward-Takahashi identity. Therefore, contrary to $F_2^\pm(p^2)$, the form factors $F_1^\pm(p^2)$ do not depend on the choice of the $\gamma\pi NN$ vertex.

V. CONSISTENCY OF THE MODEL WITH A K-MATRIX FORMALISM

In this section we will describe the consistency of the present half-off-shell form factors and nucleon self-energy with a coupled channel K-matrix approach [20–22]. In particular, we consider a simplified version of the K-matrix formalism with only the nucleon, pion and photon degrees of freedom, since these are the particles that have been included in our model. Also, only the one-pion threshold discontinuities are taken into account in both the K-matrix approach in question and the present model. An important point to be addressed here is the following. In the iterative procedure applied in the model, only the real parts of the form factors and the nucleon self-energy from the iteration n are retained to calculate the imaginary parts for the iteration $n+1$. We will show that by doing so, we avoid double counting of the pole contributions to the one-particle reducible loop diagrams generated in the K-matrix approach.

Suppose we want to consider simultaneously pion-nucleon scattering, pion photoproduction and Compton scattering. Then the scattering matrix has two indices corresponding to the channel in the initial and final state, $\mathcal{T}_{c'c}$, where the indices can be π or γ for the channels πN or γN , respectively. The Bathe-Salpeter equation for the scattering matrix can be written as

$$\mathcal{T}_{c'c} = V_{c'c} + \sum_{c''} V_{c'c''} \mathcal{G}_{c''} \mathcal{T}_{c''c}, \quad (52)$$

where $V_{c'c}$ is the sum of all irreducible diagrams describing the process $c \rightarrow c'$ and $\mathcal{G}_{c''}$ is the free two-body propagator pertinent to the channel c'' . $\mathcal{G}_{c''}$ contains the on-shell contribution $i\delta_{c''}$ which is imaginary, according to Cutkosky rules, and the principal value (off-shell) part $\mathcal{G}_{c''}^P$ which is real,

$$\mathcal{G}_{c''} = \mathcal{G}_{c''}^P + i\delta_{c''}. \quad (53)$$

The K-matrix can be defined by the equation

$$K_{c'c} = V_{c'c} + \sum_{c''} V_{c'c''} \mathcal{G}_{c''}^P K_{c''c}. \quad (54)$$

According to this formula, the loop diagrams contributing to the K-matrix contain only the principal value part of the two-particle propagator. The remaining pole contribution enters explicitly in the equation for the T-matrix expressed in the K-matrix,

$$\mathcal{T}_{c'c} = K_{c'c} + \sum_{c''} K_{c'c''} i\delta_{c''} \mathcal{T}_{c''c}, \quad (55)$$

which can be obtained from the three previous equations. A formal solution of this equation reads (suppressing the channel indices)

$$\mathcal{T} = \frac{1}{1 - K i\delta} K, \quad (56)$$

from which it follows that if K is hermitian, the S-matrix, $S = 1 + 2i\mathcal{T}$, will be unitary.

In the remainder of this section we show that it is possible to construct a K-matrix as a sum of skeleton diagrams in which the half-off-shell vertices and the nucleon propagator from the present model are used. This K-matrix is thus a solution of Eq. (54), where the kernel $V_{cc'}$ is a sum of tree diagrams. Consequently, the T-matrix found from Eq. (56) with this K-matrix will be a solution of the system of Eqs. (54,55).

We construct the K-matrix in the following way. Let the entry $K_{\gamma\gamma}$, pertinent to Compton scattering, be equal to the sum of the skeleton diagrams depicted in Fig. 10. The pion photoproduction entry $K_{\gamma\pi}$ is chosen as in Fig. 3, and the pion scattering entry $K_{\pi\pi}$ is the sum of the s- and u-type diagrams with the intermediate nucleon exchange. In all these diagrams, the dressed nucleon propagator and the nucleon-pion and nucleon-photon half-off-shell vertices, as well as the contact terms, calculated in our model are substituted.

To interpret this K-matrix in terms of Eq. (54), let us choose $V_{c'c}$ as follows. $V_{\gamma\gamma}$ is the sum of the s- and u-type diagrams for Compton scattering, where the free nucleon propagator and the bare nucleon-photon vertex are used. $V_{\gamma\pi}$ is the sum of the nucleon s- and u-exchange diagrams and the pion exchange diagram in the t-channel, plus the four-point vertex deriving from the minimal substitution in the pseudovector pion-nucleon coupling (the free propagators and bare vertices are used here). Finally, $V_{\pi\pi}$ is the s-channel plus the u-channel nucleon exchange diagrams, again with the bare nucleon-pion vertices and the free nucleon propagator. Now one can consider an iterative solution of Eq. (54) as a formal expansion of $K_{c'c}$ in powers of $V_{c'c}$. Let us concentrate, for definiteness, on the Compton

scattering matrix element up to second order in $V_{cc'}$, denoted as $K_{\gamma\gamma}^{(2)}$. It is natural to neglect the terms suppressed by two powers of the electromagnetic coupling constant. This leaves us with

$$K_{\gamma\gamma}^{(2)} = V_{\gamma\gamma} + V_{\gamma\pi} \mathcal{G}_{\pi}^P V_{\pi\gamma}. \quad (57)$$

The set of diagrams corresponding to the right-hand side of this equation is depicted in Fig. 11. The notation ss , su etc. for the loop diagrams refer to their structure in terms of the s-, u-, t-channel and contact tree diagrams of which $V_{\gamma\pi}$ consists. The index Re at the loops indicates that only the principal value integrals are taken into account, in accordance with Eq. (57). In other words, the self-energy functions and form factors parametrizing these loops are real functions. One can see that the one-particle reducible diagrams in Fig. 11 (diagrams ss , su , st , sc , us , uc , ts , cs and cu) are part of the dressing of the nucleon propagator and half-off-shell nucleon-photon vertices, in exact correspondence with our model. Therefore, the sum of these diagrams and $V_{\gamma\gamma}$ contributes to the s- and u-channel parts of $K_{\gamma\gamma}$, represented by the two upper diagrams in Fig. 10. The other, one-particle irreducible, diagrams in Fig. 11 are part of a dressed contact term. This contact term and the contact term constructed by the minimal substitution, shown by the lower diagram in Fig. 10, play the same role in that they both ensure the gauge invariance of $K_{\gamma\gamma}$. However, those parts of a $\gamma\gamma NN$ vertex which are gauge invariant by themselves cannot be unambiguously determined by the minimal substitution procedure. This ambiguity is quite analogous to that encountered in constructing the $\gamma\pi NN$ vertex, where the term orthogonal to the photon four-momentum cannot be uniquely determined.

The above description of $K_{\gamma\gamma}$ in terms of Eq. (54) has an illustrative character since only terms up to second order in $V_{cc'}$ have been discussed. Considering higher orders in the same fashion would involve full non-perturbative solutions for the nucleon propagator and the vertices. The fact that only principal value parts of the loop integrals (or, equivalently, only the real parts of the form factors and self-energy functions) are taken into account in the iterative procedure for the vertices and the nucleon propagator is consistent with Eq. (54) for the K-matrix. In particular, inclusion of the imaginary parts would lead to double counting of the pole parts of the one-particle reducible loop diagrams contributing to the T-matrix. These pole parts are generated by Eq. (55) and therefore should not be included explicitly in the K-matrix through the imaginary parts of the form factors and self-energy functions.

VI. APPLICATION IN COMPTON SCATTERING

A. $\gamma\gamma NN$ vertex

Motivated by an application to Compton scattering, described in a following section, we first construct a four-point $\gamma\gamma NN$ vertex (contact term) needed to provide current conservation in the process. Similar to the construction of the $\gamma\pi NN$ contact term, the method of minimal substitution is applied. All the details of the derivation can be found in Appendices A.2 and B.

Assume that the initial photon has four-momentum k and polarization index ν , and the initial nucleon has four-momentum p . The final photon has four-momentum $-q$ and

polarization index μ , and the final nucleon has four-momentum p' . Thus, we have the following four-momentum conservation condition: $p' = p + k + q$. Since both incoming and outgoing nucleons are on the mass shell in Compton scattering, we need only the matrix element of the contact $\gamma\gamma NN$ vertex Eq. (B22) between the positive-energy spinors of the incoming and outgoing nucleons:

$$\begin{aligned}
\bar{u}(p') M_{\mu\nu}^{ct}(q, k) u(p) = & \bar{u}(p') i\hat{e}^2 \left\{ \left[\frac{\alpha((p+q)^2)m + \beta((p+q)^2)}{2[(p+q)^2 - m^2]} - \frac{\alpha((p+k)^2)m + \beta((p+k)^2)}{2[(p+k)^2 - m^2]} \right] \right. \\
& \times \left[\frac{(p_\mu + p'_\mu - k_\mu)(p_\nu + p'_\nu + q_\nu)}{(p+q)^2 - m^2} - \frac{(p_\mu + p'_\mu + k_\mu)(p_\nu + p'_\nu - q_\nu)}{(p+k)^2 - m^2} \right] \\
& + g_{\mu\nu} \left[\frac{\alpha((p+k)^2)m + \beta((p+k)^2)}{(p+k)^2 - m^2} + \frac{\alpha((p+q)^2)m + \beta((p+q)^2)}{(p+q)^2 - m^2} \right] \\
& + \frac{\alpha((p+k)^2) - \alpha(m^2)}{2[(p+k)^2 - m^2]} \left[(p_\mu + p'_\mu + k_\mu)\gamma_\nu + (p_\nu + p'_\nu - q_\nu)\gamma_\mu \right] \\
& + \frac{\alpha((p+q)^2) - \alpha(m^2)}{2[(p+q)^2 - m^2]} \left[(p_\nu + p'_\nu + q_\nu)\gamma_\mu + (p_\mu + p'_\mu - k_\mu)\gamma_\nu \right] \\
& + \frac{H(p+k)^2 - H(m^2)}{(p+k)^2 - m^2} \left[[\not{q}, \gamma_\mu](p_\nu + p'_\nu - q_\nu) + (p_\mu + p'_\mu + k_\mu)[\not{k}, \gamma_\nu] \right] \\
& + \frac{H(p+q)^2 - H(m^2)}{(p+q)^2 - m^2} \left[[\not{k}, \gamma_\nu](p_\mu + p'_\mu - k_\mu) + (p_\nu + p'_\nu + q_\nu)[\not{q}, \gamma_\mu] \right] \\
& + F((p+k)^2) \left[[\not{q}, \gamma_\mu]\gamma_\nu + \gamma_\mu[\not{k}, \gamma_\nu] \right] \\
& \left. + F((p+q)^2) \left[[\not{k}, \gamma_\nu]\gamma_\mu + \gamma_\nu[\not{q}, \gamma_\mu] \right] \right\} u(p), \tag{58}
\end{aligned}$$

where the notation introduced in Eqs. (B1,B16,B17) has been used, and $H(p^2) \equiv F(p^2)m + G(p^2)$.

If Compton scattering is described by a scattering amplitude $M_{\mu\nu}(q, k)$, then gauge invariance requires [32]

$$q^\mu \bar{u}(p') M_{\mu\nu}(q, k) u(p) = k^\nu \bar{u}(p') M_{\mu\nu}(q, k) u(p) = 0. \tag{59}$$

We write the full amplitude in terms of three contributions, as depicted in Fig. 6:

$$M_{\mu\nu}(q, k) = M_{\mu\nu}^s(q, k) + M_{\mu\nu}^u(q, k) + M_{\mu\nu}^{ct}(q, k). \tag{60}$$

The pole contributions in this formula (“class A” diagrams, in terms of Ref. [23]) are given by the s-channel skeleton diagram

$$\bar{u}(p') M_{\mu\nu}^s(q, k) u(p) = \bar{u}(p') (-ie^2) \Gamma_\mu(m, p' - q) S(p' - q) \Gamma_\nu(p + k, m) u(p), \tag{61}$$

and the u-channel skeleton diagram

$$\bar{u}(p') M_{\mu\nu}^u(q, k) u(p) = \bar{u}(p') (-ie^2) \Gamma_\nu(m, p' - k) S(p + q) \Gamma_\mu(p + q, m) u(p), \tag{62}$$

which are constructed in terms of the irreducible half-off-shell γNN vertex and the dressed renormalized nucleon propagator. $M_{\mu\nu}^{ct}(q, k)$ denotes the contact term (comprising “class B”

diagrams) whose matrix element is given by Eq. (58). Contracting the sum of Eq. (61) and Eq. (62) with q^μ and k^ν gives, respectively,

$$q^\mu \bar{u}(p') \left[M_{\mu\nu}^s(q, k) + M_{\mu\nu}^u(q, k) \right] u(p) = -i\hat{e}^2 \bar{u}(p') \left[\Gamma_\nu(m, p' - k) - \Gamma_\nu(p + k, m) \right] u(p) \quad (63)$$

and

$$k^\nu \bar{u}(p') \left[M_{\mu\nu}^s(q, k) + M_{\mu\nu}^u(q, k) \right] u(p) = -i\hat{e}^2 \bar{u}(p') \left[\Gamma_\mu(m, p' - q) - \Gamma_\mu(p + q, m) \right] u(p), \quad (64)$$

where the Ward-Takahashi identity Eq. (C1) has been used. Using Eqs. (B14,B15) for the half-off-shell vertices and Eq. (58) for the matrix element of the contact term, it is straightforward to show that the right-hand sides of Eq. (63) and Eq. (64) are equal to $-q^\mu \bar{u}(p') M_{\mu\nu}^{ct}(q, k) u(p)$ and $-k^\nu \bar{u}(p') M_{\mu\nu}^{ct}(q, k) u(p)$, respectively, thus proving Eqs. (59).

B. Compton cross section

In this section, using the K-matrix constructed as described above, we calculate the γN scattering cross section as a function of the energy of the incident photon. Since only nucleon, pion and photon are included in the present calculation, we do not compare the calculated cross section with experimental data. For a definitive comparison with experiment, other important degrees of freedom, such as the Δ -resonance, would have to be included. This extension of the model is in progress.

The result for the forward scattering is shown by the solid line in Fig. 12. For comparison, the dotted line shows the cross section calculated using the K-matrix built with the bare vertices and the free nucleon propagator, $K_{c'c} = V_{c'c}$, thereby neglecting the principal value parts of the loop integrals contributing to the T-matrix (see Eqs. (54,55)). We checked numerically that both these calculations are gauge invariant. At low photon energies, the two cross sections converge to the same limit, the Thomson cross section. This is a consequence of the low-energy theorem [23,24]. At higher energies, however, there is a difference between the two calculations: about 5 % at $E_\gamma = 145$ MeV, which is just below the pion production threshold, and up to 10 % above the threshold. It turns out that the bulk of this difference is due to the inclusion of the form factors F_2^\pm . Also, this effect of including the principal parts of the loop integrals in the T-matrix (by using the dressed vertices and the dressed nucleon propagator in the K-matrix) depends on the kinematics of the process. In particular, the difference between the two cross sections at $\theta_\gamma = 180^\circ$ below the pion threshold has the opposite sign compared to the case of the forward scattering, and it is about two to ten times smaller in absolute value, depending on the photon energy.

The cusp-like structure of the cross section at the pion production threshold is a well-known consequence of unitarity of the scattering matrix and has been observed experimentally (see, e.g., [33] and references therein). Opposed to that, the dashed line in Fig. 12 shows the cross section calculated based on the T-matrix equal to the sum of tree-diagrams $V_{\gamma\gamma}$. The corresponding S-matrix will not be unitary, and the cross section will not, therefore, exhibit the unitary cusp.

1. The low-energy behaviour of the cross section

Throughout this section, we choose p (p') and k (k') to be the four-momenta of the initial (final) proton and photon, respectively, so that the four-momentum conservation in this process is $p + k = p' + k'$. It is convenient to work in the laboratory frame, where the initial proton is at rest, i.e. $\{p_\mu\} = (m, \vec{0})$.

According to the low-energy theorem for Compton scattering [23,24], the leading term in the expansion of the cross section in powers of the small photon energy ω is the Thomson cross section, and it is the only term that can be determined model independently, based on Lorentz and gauge invariance and crossing symmetry. The other terms are of even powers in the energy, and their structure depends on details of the model utilized for the description of the process. Thus, one has

$$\frac{d\sigma}{d\Omega} = \left(\frac{d\sigma}{d\Omega} \right)_{Th} (1 + c_2 \omega^2 + \dots), \quad (65)$$

where the Thomson cross section

$$\left(\frac{d\sigma}{d\Omega} \right)_{Th} = \frac{\alpha^2}{m^2}, \quad (66)$$

with $\alpha \approx 1/137$ being the electromagnetic coupling constant.

In this section we calculate the coefficient c_2 of the quadratic term in the low-energy expansion Eq. (65). We consider the case where the Compton scattering amplitude is described by the sum of the s- and u-channel diagrams and the contact $\gamma\gamma NN$ term, as shown in Fig. 11. It is a good approximation to the unitary amplitude below the pion threshold, because the difference between this amplitude and the fully unitarized one is suppressed by powers of the electromagnetic coupling constant. To simplify the following analytical calculations, we consider only the form factors $F_1^\pm(p^2)$ in the half-off-shell γNN vertices. Also, the dressed nucleon propagator is used in the s- and u-channel diagrams. The Ward-Takahashi identity implies that $F_1^\pm(p^2)$ can be expressed in terms of the functions $\alpha(p^2)$ (not to be confused with the fine structure constant α) and $\xi(p^2)$ parametrizing the renormalized dressed nucleon propagator, see Eqs. (50,51). The term quadratic in the photon energy will therefore be expressed in $\alpha(p^2)$ and $\xi(p^2)$. If one used bare vertices and the free nucleon propagator, no contact diagram would arise and the amplitude would be described by the s- and u-channel diagrams only. In that case, one would obtain just the Thomson cross section in the low-energy limit.

Since the calculated deviation of the cross section from the Thomson limit is largest for the forward scattering, we will consider this case in more detail. We fix the photon scattering angle $\theta_\gamma = 0^\circ$ and hence $k' = k$ and $p' = p$. We also choose the gauge in which the polarizations of the initial and final photons have the form $\{\epsilon_\mu\} = (0, \vec{\epsilon})$ and $\{\epsilon'_\mu\} = (0, \vec{\epsilon}')$, and the photon four-momenta $\{k_\mu\} = \{k'_\mu\} = (\omega, 0, 0, \omega)$, so $k \cdot \epsilon = k' \cdot \epsilon' = 0$. It follows from this choice of the gauge and the frame of reference that the scalar products of all four-momenta in the problem with both ϵ and ϵ' vanish. The Mandelstam variables in the laboratory frame are $s = (p + k)^2 = m^2 + 2m\omega$ and $u = (p - k')^2 = m^2 - 2m\omega$.

The expression for the matrix element of the amplitude reads

$$\mathcal{M}(k, k) = \mathcal{M}_s(k, k) + \mathcal{M}_u(k, k) + \mathcal{M}_{ct}(k, k), \quad (67)$$

where

$$\begin{aligned} \mathcal{M}_s(k, k) &= -ie^2 \bar{u}(p') \not{\epsilon}' \left\{ F_1^+(s) \frac{\not{p} + \not{k} + m}{2m} + F_1^-(s) \frac{-\not{p} - \not{k} + m}{2m} \right\} \frac{\not{p} + \not{k} + \xi(s)}{\alpha(s)[s - \xi^2(s)]} \\ &\times \left\{ \frac{\not{p} + \not{k} + m}{2m} F_1^+(s) + \frac{-\not{p} - \not{k} + m}{2m} F_1^-(s) \right\} \not{\epsilon} u(p), \end{aligned} \quad (68)$$

$$\begin{aligned} \mathcal{M}_u(k, k) &= -ie^2 \bar{u}(p') \not{\epsilon} \left\{ F_1^+(u) \frac{\not{p} - \not{k} + m}{2m} + F_1^-(u) \frac{-\not{p} + \not{k} + m}{2m} \right\} \frac{\not{p} - \not{k} + \xi(u)}{\alpha(u)[u - \xi^2(u)]} \\ &\times \left\{ \frac{\not{p} - \not{k} + m}{2m} F_1^+(u) + \frac{-\not{p} + \not{k} + m}{2m} F_1^-(u) \right\} \not{\epsilon}' u(p) \end{aligned} \quad (69)$$

and

$$\begin{aligned} \mathcal{M}_{ct}(k, k) &= ie^2 \bar{u}(p') \left\{ (\epsilon \cdot \epsilon') \left[\frac{m\alpha(s) - \alpha(s)\xi(s)}{s - m^2} + \frac{m\alpha(u) - \alpha(u)\xi(u)}{u - m^2} \right] \right. \\ &\quad \left. - \frac{\tilde{F}_2^+(s) - \tilde{F}_2^-(s)}{2m^2} \not{\epsilon}' \not{k} \not{\epsilon} + \frac{\tilde{F}_2^+(u) - \tilde{F}_2^-(u)}{2m^2} \not{\epsilon} \not{k} \not{\epsilon}' \right\} u(p). \end{aligned} \quad (70)$$

In the last formula we used Eq. (58) (where, according to the chosen kinematics, $q = k$ and $q' = -k'$) with $\beta(p^2) = -\alpha(p^2)\xi(p^2)$ and Eq. (B16) in which $F_2^\pm(p^2) = 0$. Thus, the contact term in Eq. (70) is consistent with the half-off-shell γNN vertices in which only the form factors $F_1^\pm(p^2)$ are taken into account. Using Eqs. (50,51) and Eqs. (B10,B11) and introducing the notation $x(p^2) \equiv \xi(p^2) - m$, we obtain

$$\begin{aligned} \mathcal{M}(k, k) &= \frac{ie^2}{2m\omega} \bar{u}(p') \left\{ \not{\epsilon}' \not{k} \not{\epsilon} \left[\frac{\alpha(s)x(s)}{\omega} - \alpha(m^2) \right] - \not{\epsilon} \not{k} \not{\epsilon}' \left[\frac{\alpha(u)x(u)}{\omega} + \alpha(m^2) \right] \right. \\ &\quad \left. + [\not{\epsilon}', \not{\epsilon}] \frac{\alpha(s)x(s) + \alpha(u)x(u)}{2} \right\} u(p). \end{aligned} \quad (71)$$

Note that Eq. (71) is explicitly crossing symmetric, i.e. symmetric under the replacements $k \longleftrightarrow -k$ (and consequently, $\omega \longleftrightarrow -\omega$ and $s \longleftrightarrow u$) and $\not{\epsilon} \longleftrightarrow \not{\epsilon}'$.

The differential cross section, averaged (summed) over projections of the spins of the initial (final) proton and the polarizations of the initial (final) photon is obtained in a standard way, by squaring the absolute value of Eq. (71) and evaluating traces of products of the γ -matrices. The result can be written in the form

$$\frac{d\sigma}{d\Omega} = \left(\frac{d\sigma}{d\Omega} \right)_{Th} \left[\alpha(m^2) + \mathcal{A}(\omega) \right]^2, \quad (72)$$

where

$$\mathcal{A}(\omega) = \frac{\alpha(u)x(u) - \alpha(s)x(s)}{2\omega}. \quad (73)$$

To analyze the low-energy expansion of the cross section Eq. (72), we first note that from the fact that the propagator has a simple pole at $\not{p} = m$ with a unit residue, it follows that

$$x(m^2) = 0, \quad 2m \left. \frac{dx}{d(p^2)} \right|_{p^2=m^2} = 1 - \frac{1}{\alpha(m^2)}, \quad (74)$$

in terms of Eq. (12) with $\xi(p^2) = m + x(p^2)$. Using Eqs. (74), we obtain from Eq. (73) that $\mathcal{A}(0) = 1 - \alpha(m^2)$. Further, since $\mathcal{A}(\omega)$ is an even function of ω , we have $(d^k \mathcal{A}/d\omega^k)|_{\omega=0} = 0$, for any odd k . The last property of the function $\mathcal{A}(\omega)$ ensures that the Compton cross section Eq. (72) is crossing symmetric. Thus, the low-energy expansion of the function $\mathcal{A}(\omega)$ contains only even powers of ω ,

$$\mathcal{A}(\omega) = 1 - \alpha(m^2) + \frac{1}{2} \left. \frac{d^2 \mathcal{A}}{d\omega^2} \right|_{\omega=0} \omega^2 + O(\omega^4). \quad (75)$$

Substituting Eq. (75) in Eq. (72) gives the low-energy expansion of the cross section in the form of Eq. (65), where $c_2 = (d^2 \mathcal{A}/d\omega^2)|_{\omega=0}$. Using Eq. (73), the coefficient c_2 can be found based on the nucleon self-energy calculated in [14], with the result $c_2 \approx 1.21 \cdot 10^{-6} \text{Mev}^{-2}$. Otherwise, one can infer c_2 by comparing the calculation of the Compton cross section (below the pion threshold) with the bare vertices and the free nucleon propagator, on the one hand, and the dressed vertices and propagator, on the other. The value obtained in such a way is $c_2 \approx 1.18 \cdot 10^{-6} \text{Mev}^{-2}$. These two numbers are in agreement with each other.

Now let us return to the general case, depicted in Fig. 12 (the photon energy $\omega \equiv E_\gamma$), in which both F_1^\pm and F_2^\pm are kept in the vertex. It is known that the coefficient at the ω^2 -term in the low-energy expansion can be related to the electric and magnetic polarizabilities of the proton $\bar{\alpha}$ and $\bar{\beta}$ [34]: in terms of Eq. (65), the model-dependent part of the coefficient c_2 can be written as

$$-\frac{m}{2\alpha} [(\bar{\alpha} + \bar{\beta})(1 + \cos\theta)^2 + (\bar{\alpha} - \bar{\beta})(1 - \cos\theta)^2]. \quad (76)$$

Thus, this coefficient is given solely by the sum $\bar{\alpha} + \bar{\beta}$ of the polarizabilities in the case of the forward scattering, and by their difference $\bar{\alpha} - \bar{\beta}$ in the case of the backward scattering. Comparing the cross sections shown by the solid and dashed curves in Fig. 12 (below the pion threshold), we can extract the effect on $(\bar{\alpha} + \bar{\beta})$ due to the inclusion of the principal value parts of the nucleon-pion loop integrals in the T-matrix,

$$\Delta(\bar{\alpha} + \bar{\beta}) = -4.76 \cdot 10^{-5} fm^3. \quad (77)$$

The effect on the difference of the polarizabilities can be inferred from the similar calculations at $\theta_\gamma = 180^\circ$,

$$\Delta(\bar{\alpha} - \bar{\beta}) = 2.97 \cdot 10^{-5} fm^3. \quad (78)$$

As pointed out above, the form factors F_2^\pm give the dominant contribution (about 90 %) to these effects.

VII. CONCLUSIONS

The electromagnetic interaction of off-shell nucleons is an important ingredient in the description of many hadronic processes at low and intermediate energies. Compared to the on-shell γNN vertex, the structure of the off-shell nucleon-photon vertex is more complicated. In this paper we consider the situation where only one of the nucleons in the vertex is off the mass shell. We have developed a non-perturbative model to calculate the form factors in such a vertex. The key element of the model is an integral equation which describes dressing of the vertex with an infinite number of pion loops. In the solution procedure we take advantage of unitarity and analyticity considerations in that dispersion relations [1] are utilized to find the real parts of the form factors from their imaginary parts. The latter, in turn, are obtained by applying cutting rules [15], with only the one-pion-nucleon discontinuities of the loop integrals taken into account. The dependence of the form factors on the four-momentum squared of the off-shell nucleon deviates from a monopole- (or dipole-) like shape adopted often in phenomenological applications. In particular, a characteristic feature of our results is a cusp-like structure of the form factors in the vicinity of the one-pion threshold, especially conspicuous for the magnetic form factors corresponding to negative-energy states of the off-shell nucleon.

One of the important requirements for the electromagnetic vertex is obeying the Ward-Takahashi identity, which relates the vertex with the nucleon propagator [16]. Our model is consistent with this condition, thus yielding a vertex satisfying the Ward-Takahashi identity. In this respect, a crucial ingredient of the equation is a four-point $\gamma\pi NN$ term. In a theory with nucleon-pion form factors, the presence of such a term is necessitated by the requirement that the photon field be included consistently with the principle of local gauge invariance. We construct a $\gamma\pi NN$ vertex using the prescription of minimal substitution, in terms of an interaction Lagrangian with higher derivatives. Terms in the contact vertex which are transverse to the photon four-momentum cannot be uniquely determined if the vertex is built using minimal substitution. As an example of such an ambiguity, we have constructed two contact terms with different transverse components. We used these two contact terms in the calculation of the half-off-shell nucleon-photon vertex and found that the negative-energy magnetic form factors are influenced noticeably by the choice of the contact term, while the effect on the positive-energy form factors is rather small.

It should be emphasized that off-shell vertices (as any general Green's functions, for that matter) depend not only on the model used to calculate them, but also on the representation of fields in the Lagrangian. In contrast, the measurable physical observables are obtained from the scattering matrix and are therefore oblivious to the representation of the Lagrangian (see, e.g., [25]). Even though information on the half-off-shell vertices cannot be unambiguously extracted from experiment, they are important for the calculation of observables.

Our approach to the calculation of the observables in scattering processes can be viewed as a two-stage scheme. First, by constructing the dressed half-off-shell vertices and nucleon propagator, we account for the real parts of the loop diagrams contributing to the T-matrix. From the thus constructed effective interaction, the kernel K in the K-matrix approach is built using only skeleton diagrams. We argued that the present model can be consistently applied in a coupled-channel K-matrix approach to Compton scattering, pion photoproduction

and pion scattering (where, apart from the dressed nucleon-photon vertex, also the dressed nucleon propagator and the dressed half-off-shell nucleon-pion vertex, obtained in a previous paper, are needed). We focused our attention on a comparison of the observables obtained without and with the use of the dressed vertices and propagator in the K-matrix. In particular, the cross section of real Compton scattering was calculated, keeping only the nucleon, pion and photon degrees of freedom in the K-matrix model. To ensure the gauge invariance of the full Compton amplitude, a contact $\gamma\gamma NN$ term is added. The latter corresponds to the particular representation of the class A diagrams (see [23] and, for a recent discussion, [35,36]). We have constructed such a term based on the dressed nucleon propagator and the half-off-shell γNN vertex using the minimal substitution prescription. We have shown that the full gauge invariant and crossing symmetric Compton amplitude thus constructed gives the cross section satisfying the low-energy theorem [23,24]. The effect of the using the dressed vertices and nucleon propagator can be up to about 10 % for the cross section, depending on the kinematics. As is known, the next-to-leading order term in a low-energy expansion of the cross section can be related to the electric and magnetic polarizabilities of the proton. By comparing the cross sections calculated with and without the use of the form factors and the nucleon self-energy, we obtained the change of the polarizabilities due to the inclusion of the real parts of the nucleon-pion loop integrals. In a simplified case where the vertices do not contain the magnetic form factors, and for the forward scattering, we expressed the next-to-leading order term in the functions parametrizing the dressed nucleon propagator.

As mentioned above, additional degrees of freedom can be included in the framework of the present model. The model is being currently extended along these lines.

ACKNOWLEDGMENTS

This work is part of the research program of the “Stichting voor Fundamenteel Onderzoek der Materie” (FOM) with financial support from the “Nederlandse Organisatie voor Wetenschappelijk Onderzoek” (NWO). We would like to thank Alex Korchin and Rob Timmermans for discussions.

APPENDIX A: THE TECHNIQUE OF MINIMAL SUBSTITUTION IN DRESSED VERTICES

1. The minimal substitution performed in coordinate space. Example of a $\gamma\pi NN$ vertex

Consider first only the functional Eq. (34). The corresponding vertex has the structure

$$\tau_\alpha \gamma^5 [f(p^2) + f(p'^2)] \quad (\text{A1})$$

Suppose now we introduce an external photon field $A_\mu(x)$. A standard way to make a theory invariant under the local gauge transformations

$$\begin{aligned} \psi(x) &\longrightarrow \exp(-i\hat{e}\alpha(x)) \psi(x), \\ A_\mu(x) &\longrightarrow A_\mu(x) + \partial_\mu\alpha(x), \end{aligned} \quad (\text{A2})$$

is the minimal substitution procedure which consists in replacing all derivatives in the Lagrangian with their covariant counterparts,

$$\partial'_\mu = \partial_\mu + i\hat{e}A_\mu, \quad (\text{A3})$$

where $\hat{e} = e\hat{e}_N \equiv e(1 + \tau_3)/2$. We are going to apply this prescription to the integrand of the functional Eq. (34). The D'Alambertian gets replaced with

$$\square + 2i\hat{e}A_\mu\partial^\mu + i\hat{e}(\partial^\mu A_\mu) - \hat{e}^2 A_\mu A^\mu. \quad (\text{A4})$$

Correspondingly, due to the presence of the electromagnetic field, the functional I undergoes the transformation

$$I \longrightarrow I' = I + \delta I, \quad (\text{A5})$$

with the variation

$$\delta I = \int d^4x \left(\frac{\delta I'}{\delta A_\mu} A_\mu + O(A^2) \right), \quad (\text{A6})$$

where it is tacitly understood that the variational derivative $\delta I'/\delta A_\mu$ is taken at the “point” $A_\mu = 0$. In Eq. (A6), $O(A^2)$ denotes all terms involving two or more photon fields. In addition to the original πNN vertex, the transformed action I' contains the vertex corresponding to the first term in the integrand of Eq. (A6). It comprises two nucleon fields, one pion field and one photon field, i.e. it is the four-point vertex we are after. Thus, the problem of deriving a contact $\gamma\pi NN$ vertex has been re-expressed in terms of finding the variational derivative of I' with respect to A_μ . Incidentally, we note that the last term can be neglected in the covariant D'Alambertian Eq. (A4), because the part of the variational derivative coming from this term will vanish for $A_\mu = 0$. So we will use only the relevant part of the covariant D'Alambertian, which reads

$$\square' = \square + 2i\hat{e}A_\mu\partial^\mu + i\hat{e}(\partial^\mu A_\mu). \quad (\text{A7})$$

The transformed action has the form of Eq. (34) with \square replaced by \square' . It can be written as

$$I' = \int d^4x F(A_\mu, \partial_\nu A_\mu, \partial_\nu \partial_\lambda A_\mu, \dots), \quad (\text{A8})$$

where we have explicitly indicated only the dependence of the integrand F on the photon field and its derivatives. If F depend on A_μ and its derivatives of the order up to and including N , then, by the Euler-Lagrange formula, the variational derivative of I' equals

$$\frac{\delta I'}{\delta A_\mu} = \frac{\partial F}{\partial A_\mu} + \sum_{n=1}^N (-)^n \partial_{\alpha_1} \dots \partial_{\alpha_n} \frac{\partial F}{\partial(\partial_{\alpha_1} \dots \partial_{\alpha_n} A_\mu)}. \quad (\text{A9})$$

To give examples of the procedure outlined, we are going to build contact terms for the functionals I_1 and I_2 which are defined according to Eq. (34) with $f(-\square) = -\square$ and $f(-\square) = \square^2$, respectively. Then we will generalize these results for the case of $f(-\square) =$

$-\square^k$, for any natural k , which will allow us to formulate the contact vertex for the general form of the function $f(-\square)$.

First, let $f(-\square) = -\square = -\partial^2$. Then the corresponding πNN vertex Eq. (A1) with the incoming off-shell nucleon has the form

$$\tau_\alpha \gamma^5 [p^2 + p'^2] \quad (\text{A10})$$

In this case, the action in the presence of the electromagnetic field reads

$$I'_1 = \int d^4x F_1(A_\mu, \partial_\nu A_\mu), \quad (\text{A11})$$

where

$$\begin{aligned} F_1 = & i\bar{\psi}\gamma^5\tau_\alpha\phi^\alpha[\partial^2 + 2i\hat{e}A_\mu\partial^\mu + i\hat{e}(\partial^\mu A_\mu)]\psi \\ & + i\bar{\psi}[\overleftarrow{\partial}^2 - 2i\hat{e}\overleftarrow{\partial}^\mu A_\mu - i\hat{e}(\partial^\mu A_\mu)]\tau_\alpha\phi^\alpha\gamma^5\psi. \end{aligned} \quad (\text{A12})$$

By Eq. (A9),

$$\begin{aligned} \frac{\delta I'_1}{\delta A_\mu} A_\mu = & i\{2i\tau_\alpha\hat{e}\bar{\psi}\gamma^5\phi^\alpha(\partial^\mu\psi) - 2i\hat{e}\tau_\alpha(\bar{\psi}\overleftarrow{\partial}^\mu)\phi^\alpha\gamma^5\psi \\ & - i\tau_\alpha\hat{e}(\partial^\mu[\bar{\psi}\gamma^5\phi^\alpha\psi]) + i\hat{e}\tau_\alpha([\bar{\psi}\phi^\alpha\gamma^5\psi]\overleftarrow{\partial}^\mu)\}A_\mu. \end{aligned} \quad (\text{A13})$$

Substituting this in Eq. (A6) and integrating the last two terms by parts, we obtain for the variation of I_1 ,

$$\begin{aligned} \delta I_1 = & i\int d^4x \{2i\tau_\alpha\hat{e}\bar{\psi}\gamma^5\phi^\alpha(\partial^\mu\psi)A_\mu - 2i\hat{e}\tau_\alpha(\bar{\psi}\overleftarrow{\partial}^\mu)\phi^\alpha\gamma^5\psi A_\mu \\ & + i\tau_\alpha\hat{e}\bar{\psi}\gamma^5\phi^\alpha\psi(\partial^\mu A_\mu) - i\hat{e}\tau_\alpha\bar{\psi}\phi^\alpha\gamma^5\psi(\partial^\mu A_\mu)\}. \end{aligned} \quad (\text{A14})$$

The four-point vertex corresponding to this functional is

$$-\gamma^5\{\tau_\alpha\hat{e}(2p^\mu + q^\mu) + \hat{e}\tau_\alpha(2p'^\mu - q^\mu)\}, \quad (\text{A15})$$

where q^μ is the four-momentum of the incoming photon.

Now let $f(-\partial^2) = \square^2 = \partial^4$. Then the initial πNN vertex is

$$\tau_\alpha \gamma^5 [p^4 + p'^4] \quad (\text{A16})$$

and we have to take the variational derivative of the action

$$I'_2 = \int d^4x F_2(A_\mu, \partial_\nu A_\mu, \partial_\nu\partial_\lambda\partial_\rho A_\mu), \quad (\text{A17})$$

where

$$\begin{aligned} F_2 = & -i\bar{\psi}\gamma^5\tau_\alpha\phi^\alpha[\partial^4 + 4i\hat{e}A_\mu\partial^\mu\partial^2 + 2i\hat{e}(\partial^\mu A_\mu)\partial^2 + 2i\hat{e}(\partial^2 A_\mu)\partial^\mu \\ & + i\hat{e}(\partial^2\partial^\mu A_\mu) + 2i\hat{e}(\partial^\lambda\partial^\mu A_\mu)\partial_\lambda + 4i\hat{e}(\partial^\lambda A_\mu)\partial^\mu\partial_\lambda]\psi \\ & - i\bar{\psi}[\overleftarrow{\partial}^4 - 4i\hat{e}\overleftarrow{\partial}^2\overleftarrow{\partial}^\mu A_\mu - 2i\hat{e}\overleftarrow{\partial}^2(\partial^\mu A_\mu) - 2i\hat{e}\overleftarrow{\partial}^\mu(\partial^2 A_\mu) \\ & - i\hat{e}(\partial^2\partial^\mu A_\mu) - 2i\hat{e}\overleftarrow{\partial}_\lambda(\partial^\lambda\partial^\mu A_\mu) - 4i\hat{e}\overleftarrow{\partial}_\lambda\overleftarrow{\partial}^\mu(\partial^\lambda A_\mu)]\tau_\alpha\phi^\alpha\gamma^5\psi. \end{aligned} \quad (\text{A18})$$

Again, applying Eq. (A9), we find

$$\begin{aligned}
\frac{\delta I'_2}{\delta A_\mu} A_\mu = & -i \left\{ 4i\tau_\alpha \hat{e} \bar{\psi} \gamma^5 \phi^\alpha (\partial^\mu \partial^2 \psi) - 4i\hat{e}\tau_\alpha (\overleftarrow{\bar{\psi}} \overleftarrow{\partial^2} \overleftarrow{\delta^\mu}) \phi^\alpha \gamma^5 \psi - 2i\tau_\alpha \hat{e} (\partial^\mu \bar{\psi} \gamma^5 \phi^\alpha (\partial^2 \psi)) \right. \\
& - 4i\tau_\alpha \hat{e} (\partial_\lambda \bar{\psi} \gamma^5 \phi^\alpha (\partial^\lambda \partial^\mu \psi)) + 2i\hat{e}\tau_\alpha (\partial^\mu (\overleftarrow{\bar{\psi}} \overleftarrow{\partial^2}) \phi^\alpha \gamma^5 \psi) + 4i\hat{e}\tau_\alpha (\partial_\lambda (\overleftarrow{\bar{\psi}} \overleftarrow{\partial^\lambda} \overleftarrow{\delta^\mu}) \phi^\alpha \gamma^5 \psi) \\
& + 2i\tau_\alpha \hat{e} (\partial^2 \bar{\psi} \gamma^5 \phi^\alpha (\partial^\mu \psi)) + 2i\tau_\alpha \hat{e} (\partial^\lambda \partial^\mu \bar{\psi} \gamma^5 \phi^\alpha (\partial_\lambda \psi)) - 2i\hat{e}\tau_\alpha (\partial^2 (\overleftarrow{\bar{\psi}} \overleftarrow{\delta^\mu}) \phi^\alpha \gamma^5 \psi) \\
& \left. - 2i\hat{e}\tau_\alpha (\partial^\lambda \partial^\mu (\overleftarrow{\bar{\psi}} \overleftarrow{\partial_\lambda}) \phi^\alpha \gamma^5 \psi) - i\tau_\alpha \hat{e} (\partial^2 \partial^\mu \bar{\psi} \gamma^5 \phi^\alpha \psi) + i\hat{e}\tau_\alpha (\partial^2 \partial^\mu \bar{\psi} \gamma^5 \phi^\alpha \psi) \right\} A_\mu. \quad (\text{A19})
\end{aligned}$$

Upon substituting this derivative in Eq. (A6) and integrating the second to the sixth terms by parts once, the seventh to the tenth ones twice, and the last two terms thrice, we obtain the following four-point vertex:

$$- \gamma^5 \{ \tau_\alpha \hat{e} (2p^\mu + q^\mu) [(p+q)^2 + p^2] + \hat{e}\tau_\alpha (2p'^\mu - q^\mu) [(p'-q)^2 + p'^2] \}. \quad (\text{A20})$$

Next, let the πNN form factor in Eq. (A1) be a monomial $f(p^2) = p^{2k}$, k being a natural number. It corresponds to $f(-\square) = (-\square)^k$ in Eq. (34). Following the same steps as for the two above considered cases, we obtain for the four-point vertex:

$$- \gamma^5 \{ \tau_\alpha \hat{e} (2p^\mu + q^\mu) \sum_{l=0}^{k-1} p^{2l} (p+q)^{2(k-l-1)} + \hat{e}\tau_\alpha (2p'^\mu - q^\mu) \sum_{l=0}^{k-1} p'^{2l} (p'-q)^{2(k-l-1)} \}. \quad (\text{A21})$$

A generic function $f(p^2)$ in Eq. (A1) can be formally expanded in powers of p^2 ,

$$f(p^2) = \sum_k a_k p^{2k}. \quad (\text{A22})$$

Using Eq. (A21) and the identity

$$\sum_{l=0}^{k-1} x^{2l} y^{2(k-l-1)} = \frac{y^{2k} - x^{2k}}{y^2 - x^2}, \quad (\text{A23})$$

the corresponding $\gamma\pi NN$ vertex can be written

$$- \gamma^5 \left\{ \tau_\alpha \hat{e} (2p^\mu + q^\mu) \frac{f((p+q)^2) - f(p^2)}{(p+q)^2 - p^2} + \hat{e}\tau_\alpha (2p'^\mu - q^\mu) \frac{f((p'-q)^2) - f(p'^2)}{(p'-q)^2 - p'^2} \right\}. \quad (\text{A24})$$

As a following application, consider the functional in Eq. (35). The corresponding πNN vertex reads

$$\tau_\alpha [\gamma^5 g(p^2) \not{p} + \not{p}' g(p^2) \gamma^5], \quad (\text{A25})$$

Following the procedure described above, we can write down the expression for the contact term resulting from the minimal substitution in the functional J of Eq. (35):

$$\begin{aligned}
& -\tau_\alpha \hat{e} \gamma^5 \left\{ (2p^\mu + q^\mu) \not{p} \frac{g((p+q)^2) - g(p^2)}{(p+q)^2 - p^2} + \gamma^\mu g((p+q)^2) \right\} \\
& - \hat{e}\tau_\alpha \left\{ (2p'^\mu - q^\mu) \frac{g((p'-q)^2) - g(p'^2)}{(p'-q)^2 - p'^2} \not{p}' + \gamma^\mu g((p'-q)^2) \right\} \gamma^5. \quad (\text{A26})
\end{aligned}$$

One remark is in order here. Along with J in Eq. (35), an equivalent form of the action functional could be written, corresponding to the vertex Eq. (A25),

$$K = \int d^4x \bar{\psi} \gamma^5 \tau_\alpha \phi^\alpha [\not{\partial} g(-\square) \psi] - \int d^4x \overline{[\not{\partial} g(-\square) \psi]} \phi^\alpha \tau_\alpha \gamma^5 \psi. \quad (\text{A27})$$

Since the operators \square and $\not{\partial}$ commute, $K = J$. Switching on the electromagnetic field amounts to the replacements $\not{\partial} \rightarrow \not{\partial}'$ and $\square \rightarrow \square'$, see Eqs. (A3,A7), and correspondingly $J \rightarrow J'$ and $K \rightarrow K'$. Now we note that $K' \neq J'$, owing to the fact that \square' and $\not{\partial}'$ do not commute,

$$[\square', \not{\partial}'] = i\hat{e}(\partial^2 A) + 2i\hat{e}(\partial_\mu A)\partial^\mu - 2i\hat{e}(\not{\partial} A_\mu)\partial^\mu - i\hat{e}(\not{\partial}\partial^\mu A_\mu) + O(A^2). \quad (\text{A28})$$

One can build the contact term corresponding to the initial functional K in Eq. (A27). It has the form

$$\begin{aligned} & -\tau_\alpha \hat{e} \gamma^5 \left\{ (2p^\mu + q^\mu)(\not{p} + \not{q}) \frac{g((p+q)^2) - g(p^2)}{(p+q)^2 - p^2} + \gamma^\mu g(p^2) \right\} \\ & -\hat{e} \tau_\alpha \left\{ (2p'^\mu - q^\mu) \frac{g((p'-q)^2) - g(p'^2)}{(p'-q)^2 - p'^2} (\not{p}' - \not{q}) + \gamma^\mu g(p'^2) \right\} \gamma^5. \end{aligned} \quad (\text{A29})$$

The difference between the vertices Eq. (A26) and Eq. (A29) equals

$$\begin{aligned} \Delta^\mu &= -\tau_\alpha \hat{e} \gamma^5 \left\{ (2p^\mu + q^\mu) \not{q} \frac{g((p+q)^2) - g(p^2)}{(p+q)^2 - p^2} + \gamma^\mu [g(p^2) - g((p+q)^2)] \right\} \\ & -\hat{e} \tau_\alpha \left\{ (2p'^\mu - q^\mu) \frac{g((p'-q)^2) - g(p'^2)}{(p'-q)^2 - p'^2} (-\not{q}) + \gamma^\mu [g(p^2) - g((p'-q)^2)] \right\} \gamma^5, \end{aligned} \quad (\text{A30})$$

and it is trivial to show that it is orthogonal to the photon four-momentum, $q \cdot \Delta = 0$. This presents one example of the known ambiguity in constructing such contact vertices: the terms orthogonal to the photon four-momentum cannot be uniquely determined if one applies the minimal substitution prescription.

2. The minimal substitution performed in momentum space

The technique applied here is essentially equivalent to that used above to build the $\gamma\pi NN$ vertex, except all manipulations now will be done directly in momentum space, without resorting explicitly to variational derivatives of an action functional with higher derivatives. A similar method of the minimal substitution in nucleon-pion form factors was employed by Ohta [17].

The minimal substitution in momentum space amounts to the following replacement of the nucleon four-momentum: $P_\mu \rightarrow \tilde{P}_\mu = P_\mu - \hat{e} A_\mu$. P_μ has to be considered as an operator acting on the right. If in a given term P_μ is the rightmost operator, the result of its action is the (incoming) nucleon four-momentum p_μ which has c-number components. Therefore, the minimal substitution in \not{p} results in the familiar electromagnetic vertex $-\hat{e}\gamma_\mu$, which we formally denote as the mapping

$$\not{p} \mapsto -\hat{e}\gamma_\mu. \quad (\text{A31})$$

The electromagnetic field A_μ carries the four-momentum q_μ (throughout this appendix, all photon four-momenta are assumed to flow inwards all the vertices). When acting directly on the electromagnetic field, P_μ gives: $(P \cdot A) = A \cdot q$. If we have, for example, P^2 on the left from the scalar product of the electromagnetic field A_μ with a c-number vector v_μ , the result will be

$$P^2 A \cdot v = A \cdot v (p + q)^2. \quad (\text{A32})$$

More generally, considering any function $f(p^2)$ in the sense of the formal expansion Eq. (A22), one obtains

$$f(P^2) A \cdot v = A \cdot v f((p + q)^2). \quad (\text{A33})$$

Under the minimal substitution, the nucleon four-momentum squared changes as

$$P^2 \longrightarrow \tilde{P}^2 = p^2 - 2\hat{e}A \cdot p - \hat{e}A \cdot q + O(A^2) = p^2 - \hat{e}A^\mu(2p_\mu + q_\mu) + O(A^2). \quad (\text{A34})$$

Collecting the coefficients of the terms linear in A^μ results in the mapping

$$p^2 \longmapsto -\hat{e}(2p_\mu + q_\mu). \quad (\text{A35})$$

To generalize this for an arbitrary function $f(p^2)$, we first consider the following combination:

$$\begin{aligned} P^2 \tilde{P}^2 &= p^4 - 2\hat{e}q^2 A \cdot p - 2\hat{e}A \cdot p p^2 - 4\hat{e}q \cdot p A \cdot p - \hat{e}q^2 A \cdot q - \hat{e}A \cdot q p^2 \\ &\quad - 2\hat{e}A \cdot q q \cdot p + O(A^2) = p^4 - \hat{e}A^\mu(2p_\mu + q_\mu)(p + q)^2 + O(A^2), \end{aligned} \quad (\text{A36})$$

where Eq. (A34) has been used. The next step is to find the result of the minimal substitution in the monomials p^{2n} , $n = 1, 2, 3, \dots$. Using Eqs. (A32,A34,A36), we have

$$\begin{aligned} P^{2n} \longrightarrow \tilde{P}^{2n} &= p^{2n} - [2\hat{e}A \cdot p + \hat{e}A \cdot q] \overbrace{P^2 \dots P^2}^{n-1} - P^2 [2\hat{e}A \cdot p + \hat{e}A \cdot q] \overbrace{P^2 \dots P^2}^{n-2} \\ &\quad - \dots - \overbrace{P^2 \dots P^2}^{n-1} [2\hat{e}A \cdot p + \hat{e}A \cdot q] + O(A^2) \\ &= p^{2n} - \hat{e}A^\mu(2p_\mu + q_\mu) \sum_{m=0}^{n-1} (p + q)^{2m} p^{2(n-1-m)} + O(A^2), \end{aligned} \quad (\text{A37})$$

leading to the first part of Eq. (A21) in the case of the $\gamma\pi NN$ vertex. Thus,

$$p^{2n} \longmapsto -\hat{e}(2p_\mu + q_\mu) \frac{(p + q)^{2n} - p^{2n}}{(p + q)^2 - p^2}, \quad (\text{A38})$$

where Eq. (A23) has been used. Having established this and in view of the expansion Eq. (A22), it is trivial to write the result of the minimal substitution for an arbitrary function of p^2 ,

$$f(p^2) \longmapsto -\hat{e}(2p_\mu + q_\mu) \frac{f((p + q)^2) - f(p^2)}{(p + q)^2 - p^2}, \quad (\text{A39})$$

leading to the first term in Eq. (A24).

To find how the product $f(p^2)\not{p}$ changes under the minimal substitution, we make use of Eqs. (A31,A39) and Eq. (A33), as well as Eq. (A22),

$$\begin{aligned} f(P^2)\not{P} &\longrightarrow f(\tilde{P}^2)\tilde{\not{P}} \\ &= f(p^2)\not{p} - \hat{e}A^\mu(2p_\mu + q_\mu) \frac{f(p+q)^2 - f(p^2)}{(p+q)^2 - p^2} \not{p} - \hat{e}A^\mu\gamma_\mu f((p+q)^2) + O(A^2), \end{aligned} \quad (\text{A40})$$

and hence

$$f(p^2)\not{p} \longmapsto -\hat{e}(2p_\mu + q_\mu) \frac{f(p+q)^2 - f(p^2)}{(p+q)^2 - p^2} \not{p} - \hat{e}\gamma_\mu f((p+q)^2). \quad (\text{A41})$$

Now one can do the minimal substitution of one photon with the four-momentum q_μ . Suppose that, using the same framework, we want to add the second photon that carries the four-momentum k_ν flowing inwards. Then, in addition to the formulas given above, we need to have the result of the minimal substitution in a generic function $g(p \cdot q)$. In the manner absolutely analogous to deriving Eq. (A39), one can obtain

$$g(p \cdot q) \longmapsto -\hat{e}q_\mu \frac{g((p+k) \cdot q) - g(p \cdot q)}{k \cdot q}. \quad (\text{A42})$$

An example of this formula, relevant to the construction of a $\gamma\gamma NN$ vertex, is given by

$$\frac{1}{(p+q)^2 - p^2} \longmapsto -\hat{e} \frac{2q_\mu}{[(p+q+k)^2 - (p+k)^2][(p+q)^2 - p^2]}. \quad (\text{A43})$$

Using Eqs. (A39,A42) and Eq. (A33), we find that the minimal substitution in the product of a function f of p^2 and a function g of $p \cdot q$ gives

$$\begin{aligned} f(p^2)g(p \cdot q) &\longmapsto -\hat{e} \left\{ (2p_\mu + k_\mu) \frac{f((p+k)^2) - f(p^2)}{(p+k)^2 - p^2} g(p \cdot q) \right. \\ &\quad \left. + q_\mu f((p+k)^2) \frac{g((p+k) \cdot q) - g(p \cdot q)}{k \cdot q} \right\}. \end{aligned} \quad (\text{A44})$$

Next, it is trivial to show that

$$p_\mu \longmapsto -\hat{e}g_{\mu\nu}. \quad (\text{A45})$$

Suppose now that, instead of the operator P_μ considered above, we are interested in the operator \overleftarrow{P}'_μ corresponding to the four-momentum of the outgoing nucleon. \overleftarrow{P}'_μ acts to the left, yielding from the leftmost position p'_μ , the c-number four-momentum of the outgoing nucleon. Under the minimal substitution, \overleftarrow{P}'_μ changes as $\overleftarrow{P}'_\mu \longrightarrow \widetilde{\overleftarrow{P}'_\mu} = \overleftarrow{P}'_\mu - \hat{e}A_\mu$. Repeating the steps similar to those that led to Eq. (A39), one obtains the result of the minimal substitution in a function of the four-momentum squared of the outgoing nucleon:

$$f(p'^2) \longmapsto -\hat{e}(2p'_\mu - q_\mu) \frac{f((p'-q)^2) - f(p'^2)}{(p'-q)^2 - p'^2}, \quad (\text{A46})$$

leading to the second term in Eq. (A24). Also, the formulas analogous to Eqs. (A42,A44,A45) read

$$g(p' \cdot q) \mapsto \hat{e} q_\mu \frac{g((p' - k) \cdot q) - g(p' \cdot q)}{k \cdot q}, \quad (\text{A47})$$

$$g(p' \cdot q)f(p'^2) \mapsto -\hat{e} \left\{ (2p'_\mu - k_\mu) \frac{f((p' - k)^2) - f(p'^2)}{(p' - k)^2 - p'^2} g(p' \cdot q) \right. \\ \left. - q_\mu f((p' - k)^2) \frac{g((p' - k) \cdot q) - g(p' \cdot q)}{k \cdot q} \right\} \quad (\text{A48})$$

and

$$p'_\mu \mapsto -\hat{e} g_{\mu\nu}. \quad (\text{A49})$$

APPENDIX B: THE $\gamma\gamma NN$ VERTEX

1. The minimal substitution in the inverse nucleon propagator

First we describe the minimal substitution of a photon with four-momentum q_μ in the function

$$iS^{-1}(p) = i[\alpha(p^2)\not{p} + \beta(p^2)] \quad (\text{B1})$$

which is, up to a factor i , the inverse nucleon propagator Eq. (12), with $\beta(p^2) = -\alpha(p^2)\xi(p^2)$. We can use Eqs. (A39,A41) to write the nucleon-photon vertex obtained by the minimal substitution in Eq. (B1),

$$-ie\Gamma_\mu^{min(1)}(p+q, p) = -i\hat{e} \left\{ (2p_\mu + q_\mu) \frac{\alpha((p+q)^2)\not{p} + \beta((p+q)^2) - \alpha(p^2)\not{p} - \beta(p^2)}{(p+q)^2 - p^2} \right. \\ \left. + \gamma_\mu \alpha((p+q)^2) \right\}. \quad (\text{B2})$$

This vertex satisfies the Ward-Takahashi identity Eq. (C1), which is obvious if one rewrites Eq. (B2) in the form

$$\Gamma_\mu^{min(1)}(p', p) = \hat{e}_N \left\{ \frac{2p_\mu + q_\mu}{(p+q)^2 - p^2} [S^{-1}(p') - S^{-1}(p)] + \alpha((p+q)^2) [\gamma_\mu - \not{q} \frac{2p_\mu + q_\mu}{(p+q)^2 - p^2}] \right\}. \quad (\text{B3})$$

(We stress that here the photon four-momentum $q = p' - p$ is incoming, and therefore the sign of the the right-hand side of the Ward-Takahashi identity is reverse compared to Eq. (C1).) In principle, both nucleons can be off-shell in this vertex.

Instead of Eq. (B1) for the inverse nucleon propagator, one could start from the form with the terms \not{p} and $\alpha(p^2)$ interchanged, and proceed along the above lines to build a nucleon-photon vertex. The result then can be written

$$\begin{aligned}
-i e \Gamma_{\mu}^{min(2)}(p', p' - q) = -i \hat{e} \left\{ (2p'_{\mu} - q_{\mu}) \frac{\not{p}' \alpha(p'^2) + \beta(p'^2) - \not{p}' \alpha((p' - q)^2) - \beta((p' - q)^2)}{p'^2 - (p' - q)^2} \right. \\
\left. + \gamma_{\mu} \alpha((p' - q)^2) \right\}. \tag{B4}
\end{aligned}$$

This vertex differs from Eq. (B2) only by a part transverse to the photon four-momentum, which is clear upon rewriting Eq. (B4) in the form

$$\Gamma_{\mu}^{min(2)}(p', p) = \hat{e}_N \left\{ \frac{2p_{\mu} + q_{\mu}}{(p + q)^2 - p^2} [S^{-1}(p') - S^{-1}(p)] + \alpha(p^2) [\gamma_{\mu} - \not{q} \frac{2p_{\mu} + q_{\mu}}{(p + q)^2 - p^2}] \right\}, \tag{B5}$$

to be compared with Eq. (B3).

At this point we note that (a half of) the sum of the inverse propagator Eq. (B1) and the one with interchanged \not{p} and $\alpha(p^2)$ corresponds to a hermitian action functional in coordinate space. Starting from such a form of the propagator, one obtains the vertex

$$-i e \Gamma_{\mu}^{min}(p', p) = \frac{-i e}{2} [\Gamma_{\mu}^{min(1)}(p', p) + \Gamma_{\mu}^{min(2)}(p', p)]. \tag{B6}$$

To obtain the half-off-shell vertex $\Gamma_{\mu}^{min}(m, p)$ with the outgoing on-shell nucleon, we apply Eq. (B6) to the positive-energy spinor $\bar{u}(p')$ to the left, where $p' = p + q$. First, using $\bar{u}(p') \not{p}' = \bar{u}(p') m$ as well as the anticommutator relation for the γ -matrices, it can be shown that

$$\bar{u}(p') (p_{\mu} + p'_{\mu}) = \bar{u}(p') (\gamma_{\mu} \not{p} + \gamma_{\mu} m - i \sigma_{\mu\lambda} q^{\lambda}), \tag{B7}$$

by virtue of which we have

$$\begin{aligned}
\bar{u}(p') \Gamma_{\mu}^{min}(m, p) = \bar{u}(p') \hat{e}_N \left\{ \gamma_{\mu} \frac{\alpha(p^2) p^2 + \beta(p^2) m}{p^2 - m^2} + \gamma_{\mu} \frac{\not{p}}{m} \frac{\alpha(p^2) m^2 + \beta(p^2) m}{p^2 - m^2} \right. \\
\left. + i \frac{\sigma_{\mu\lambda} q^{\lambda}}{2m} m \frac{\alpha(p^2) m + 2\beta(p^2) - \beta(m^2)}{m^2 - p^2} + i \frac{\sigma_{\mu\lambda} q^{\lambda}}{2m} \frac{\not{p}}{m} m^2 \frac{\alpha(p^2) - \alpha(m^2)}{m^2 - p^2} \right\}. \tag{B8}
\end{aligned}$$

This can be cast in the form of Eq. (7) (note that since the photon here is incoming, we have a plus sign in front of the magnetic term),

$$\bar{u}(p') \Gamma_{\mu}^{min}(m, p) = \bar{u}(p') \sum_{l=\pm} \left\{ \gamma_{\mu} F_1^l(p^2) + i \frac{\sigma_{\mu\nu} q^{\nu}}{2m} \tilde{F}_2^l(p^2) \right\} \Lambda_l(p), \tag{B9}$$

where the form factors $F_1^{\pm}(p^2) = (F_1^{\pm})^s(p^2) + \tau_3 (F_1^{\pm})^v(p^2)$ are found from the Ward-Takahashi identities Eqs. (50,51) with $\beta(p^2) = -\alpha(p^2) \xi(p^2)$, and

$$(\tilde{F}_2^+)^{s,v}(p^2) = (F_1^-)^{s,v}(p^2) - (F_1^+)^{s,v}(p^2), \tag{B10}$$

$$(\tilde{F}_2^-)^{s,v}(p^2) = \frac{2m^2}{m^2 - p^2} (F_1^-)^{s,v}(m^2) - \frac{m^2 + p^2}{m^2 - p^2} (F_1^-)^{s,v}(p^2) - (F_1^+)^{s,v}(p^2). \tag{B11}$$

If the initial nucleon is on-shell, we have to apply Eq. (B2) to the spinor $u(p)$ to the right. Taking advantage of the identity

$$(p_\mu + p'_\mu)u(p) = (\not{p}'\gamma_\mu + m\gamma_\mu - i\sigma_{\mu\lambda}q^\lambda)u(p), \quad (\text{B12})$$

the result for this half-off-shell vertex can be written

$$\Gamma_\mu^{min}(p', m) u(p) = \sum_{k=\pm} \Lambda_k(p') \left\{ \gamma_\mu F_1^k(p'^2) + i\frac{\sigma_{\mu\nu}q^\nu}{2m} \tilde{F}_2^k(p'^2) \right\} u(p). \quad (\text{B13})$$

The functions $\tilde{F}_2^\pm(p^2)$ are expressed in terms of $F_1^\pm(p^2)$ and, therefore, determined by the Ward-Takahashi identity. In general, however, the magnetic form factors $F_2^\pm(p^2)$ are not restricted by the Ward-Takahashi identity. Let us introduce two auxiliary functions $F(p^2)$ and $G(p^2)$. Then we can write down the most general form of the half-off-shell vertex with the outgoing nucleon on-shell as

$$\bar{u}(p')\Gamma_\mu(m, p) = \bar{u}(p') \left(\Gamma_\mu^{min}(m, p) + [\not{q}, \gamma_\mu] \{ F(p^2)\not{p} + G(p^2) \} \right), \quad (\text{B14})$$

and of the half-off-shell vertex with the incoming nucleon on-shell as

$$\Gamma_\mu(p', m) u(p) = \left(\Gamma_\mu^{min}(p', m) + \{ \not{p}'F(p'^2) + G(p'^2) \} [\not{q}, \gamma_\mu] \right) u(p). \quad (\text{B15})$$

Now we equate Eq. (B14) and Eq. (7) (with the plus sign in front of the term proportional to $\sigma_{\mu\nu}q^\nu$) to find the functions $F(p^2)$ and $G(p^2)$ in terms of the magnetic form factors $(F_2^\pm)^{s,v}(p^2)$,

$$(F)^{s,v}(p^2) = \frac{(F_2^+)^{s,v}(p^2) - (F_2^-)^{s,v}(p^2) - (\tilde{F}_2^+)^{s,v}(p^2) + (\tilde{F}_2^-)^{s,v}(p^2)}{8m^2}, \quad (\text{B16})$$

$$(G)^{s,v}(p^2) = \frac{(F_2^+)^{s,v}(p^2) + (F_2^-)^{s,v}(p^2) - (\tilde{F}_2^+)^{s,v}(p^2) - (\tilde{F}_2^-)^{s,v}(p^2)}{8m}, \quad (\text{B17})$$

where $(\tilde{F}_2^\pm)^{s,v}(p^2)$ are given by Eqs. (B10,B11).

2. The minimal substitution in the γNN vertex

Let the second photon field carry the four-momentum k_ν flowing inwards. Using results established in Appendix A.2, the two-nucleon–two-photon contact term based on Eq. (B6) can be written (the four-momentum conservation in this formula is $p' = p + q + k$)

$$M_{\mu\nu}^{ct,min}(q, k) = \frac{1}{2} \left[M_{\mu\nu}^{ct,min(1)}(q, k) + M_{\mu\nu}^{ct,min(2)}(q, k) \right], \quad (\text{B18})$$

where

$$\begin{aligned} M_{\mu\nu}^{ct,min(1)}(q, k) = i\hat{e}^2 & \left\{ \frac{\alpha(p'^2)\not{p} + \beta(p'^2) - \alpha((p+q)^2)\not{p} - \beta((p+q)^2)}{[p'^2 - (p+q)^2][(p+q)^2 - p^2]} (2p_\nu + 2q_\nu + k_\nu)(2p_\mu + q_\mu) \right. \\ & - \frac{\alpha(p+k)^2\not{p} + \beta((p+k)^2) - \alpha(p^2)\not{p} - \beta(p^2)}{[(p+k)^2 - p^2][(p+q)^2 - p^2]} (2p_\nu + k_\nu)(2p_\mu + q_\mu) \\ & \left. - \frac{\alpha(p'^2)\not{p} + \beta(p'^2) - \alpha((p+k)^2)\not{p} - \beta((p+k)^2)}{[p'^2 - (p+k)^2][(p+q)^2 - p^2]} 2q_\nu(2p_\mu + q_\mu) \right\} \end{aligned}$$

$$\begin{aligned}
& + \frac{\alpha(p'^2)\not{p} + \beta(p'^2) - \alpha((p+k)^2)\not{p} - \beta((p+k)^2)}{p'^2 - (p+k)^2} 2g_{\mu\nu} \\
& + \frac{\alpha(p'^2) - \alpha((p+k)^2)}{p'^2 - (p+k)^2} (2p_\mu + 2k_\mu + q_\mu)\gamma_\nu \\
& + \frac{\alpha(p'^2) - \alpha((p+q)^2)}{p'^2 - (p+q)^2} (2p_\nu + 2q_\nu + k_\nu)\gamma_\mu \Big\} \tag{B19}
\end{aligned}$$

and

$$\begin{aligned}
M_{\mu\nu}^{ct,min(2)}(q, k) = i\hat{e}^2 \Big\{ & (2p'_\mu - q_\mu)(2p'_\nu - k_\nu) \frac{\not{p}'\alpha((p'-k)^2) + \beta((p'-k)^2) - \not{p}'\alpha(p'^2) - \beta(p'^2)}{[p'^2 - (p'-q)^2][(p'-k)^2 - p'^2]} \\
& - (2p'_\mu - q_\mu)(2p'_\nu - 2q_\nu - k_\nu) \frac{\not{p}'\alpha(p'^2) + \beta(p'^2) - \not{p}'\alpha((p'-q)^2) - \beta((p'-q)^2)}{[p'^2 - (p'-q)^2][p'^2 - (p'-q)^2]} \\
& - 2q_\nu(2p'_\mu - q_\mu) \frac{\not{p}'\alpha((p'-k)^2) + \beta((p'-k)^2) - \not{p}'\alpha(p'^2) - \beta(p'^2)}{[(p'-k)^2 - p'^2][p'^2 - (p'-q)^2]} \\
& + 2g_{\mu\nu} \frac{\not{p}'\alpha((p'-k)^2) + \beta((p'-k)^2) - \not{p}'\alpha(p'^2) - \beta(p'^2)}{(p'-k)^2 - p'^2} \\
& + \gamma_\nu(2p'_\mu - 2k_\mu - q_\mu) \frac{\alpha((p'-k)^2) - \alpha(p'^2)}{(p'-k)^2 - p'^2} \\
& + \gamma_\mu(2p'_\nu - 2q_\nu - k_\nu) \frac{\alpha((p'-q)^2) - \alpha(p'^2)}{(p'-q)^2 - p'^2} \Big\}. \tag{B20}
\end{aligned}$$

Hitherto, we have done the minimal substitution of the second photon only in the vertex Eq. (B6). However, as was stressed above, this vertex does not reproduce the most general magnetic terms for the half-off-shell cases. Therefore, to complete the construction of the contact term, we have to add to Eq. (B18) the results of the minimal substitution of the second photon in those terms in Eqs. (B14,B15) which contain the auxiliary functions $F(p^2)$ and $G(p^2)$ given by Eqs. (B16,B17). This additional term, which we denote $M_{\mu\nu}^{ct,add}(q, k)$, is built using the techniques described in Appendix A.2. It reads

$$\begin{aligned}
M_{\mu\nu}^{ct,add}(q, k) = i\hat{e}^2 \Big\{ & [\not{q}, \gamma_\mu] \left[\frac{F((p+k)^2)\not{p} + G((p+k)^2) - F(m^2)\not{p} - G(m^2)}{(p+k)^2 - p^2} \right. \\
& \times (p_\nu + p'_\nu - q_\nu) + F((p+k)^2)\gamma_\nu \Big] \\
& + \left[\frac{\not{p}'F((p'-k)^2) + G((p'-k)^2) - \not{p}'F(m^2) - G(m^2)}{(p'-k)^2 - p'^2} \right. \\
& \times (p_\nu + p'_\nu + q_\nu) + F((p'-k)^2)\gamma_\nu \Big] [\not{q}, \gamma_\mu] \Big\}. \tag{B21}
\end{aligned}$$

One requirement for the contact term is that it has to be crossing symmetric, i.e. invariant under the simultaneous transformations $\mu \longleftrightarrow \nu$ and $q \longleftrightarrow k$ [23]. The matrix element of the ‘‘minimal’’ contact term Eq. (B18) between the positive-energy spinors of the incoming and outgoing nucleons is crossing symmetric, as can be verified explicitly. This is a consequence of the fact that $M_{\mu\nu}^{ct,min}(q, k)$ is built starting from an explicitly hermitian

inverse nucleon propagator. Contrary to that, $M_{\mu\nu}^{ct,add}(q, k)$ has to be explicitly crossing symmetrized, i.e. the term $M_{\nu\mu}^{ct,add}(k, q)$ has to be added.

Putting all the pieces together, we write the matrix element of the resulting $\gamma\gamma NN$ vertex between the positive-energy spinors of the incoming and outgoing nucleons,

$$\bar{u}(p') M_{\mu\nu}^{ct}(q, k) u(p) = \bar{u}(p') \left[M_{\mu\nu}^{ct,min}(q, k) + M_{\mu\nu}^{ct,add}(q, k) + M_{\nu\mu}^{ct,add}(k, q) \right] u(p), \quad (\text{B22})$$

with its explicit form given in Eq. (58).

APPENDIX C: CONSISTENCY OF THE METHOD WITH THE WARD-TAKAHASHI IDENTITY FOR THE γNN VERTEX

The Ward-Takahashi identity is an important constraint on the nucleon-photon vertex [16],

$$q \cdot \Gamma(p', p) = \hat{e}_N [S^{-1}(p) - S^{-1}(p')], \quad (\text{C1})$$

with the photon four-momentum $q^\mu = p^\mu - p'^\mu$. In this appendix we show that if we assume the validity of the Ward-Takahashi identity for the γNN vertex on the right-hand side of Eq. (9), then the present method of solution is consistent with this assumption, i.e. the left-hand side of Eq. (9) will also obey Eq. (C1).

To this end, we first construct a pion photoproduction amplitude and prove its gauge invariance. Consider the following amplitude for the pion photoproduction process (here both nucleons and the pion are on-shell, and the amplitude is written up to a factor of e , the elementary charge),

$$T_\alpha^\mu = \sum_{i=1}^4 T_{i,\alpha}^\mu, \quad (\text{C2})$$

with

$$\bar{u}(p') T_{1,\alpha}^\mu u(p) = \bar{u}(p') \tau_\alpha \Gamma^5(m, p' - k) S(p' - k) \Gamma^\mu(p' - k, m) u(p), \quad (\text{C3})$$

$$\bar{u}(p') T_{2,\alpha}^\mu u(p) = \bar{u}(p') \Gamma^\mu(m, p' + q) S(p' + q) \tau_\alpha \Gamma^5(p' + q, m) u(p), \quad (\text{C4})$$

$$\bar{u}(p') T_{3,\alpha}^\mu u(p) = \bar{u}(p') \tau_\beta \gamma^5 g D(k - q) V_{\beta\alpha}^\mu(k - q, k) u(p), \quad (\text{C5})$$

$$\begin{aligned} \bar{u}(p') T_{4,\alpha}^\mu u(p) = & \bar{u}(p') \left(-\tau_\alpha \hat{e}_N \left\{ \frac{2p^\mu - q^\mu}{(p - q)^2 - p^2} [\Gamma^5(m, p - q) - \Gamma^5(m, m)] \right. \right. \\ & + \gamma^5 \frac{g_2((p - q)^2)}{m} [\gamma^\mu + \not{q} \frac{2p^\mu - q^\mu}{(p - q)^2 - p^2}] \left. \right\} \\ & - \hat{e}_N \tau_\alpha \left\{ \frac{2p'^\mu + q^\mu}{(p' + q)^2 - p'^2} [\Gamma^5(p' + q, m) - \Gamma^5(m, m)] \right. \\ & \left. \left. + [\gamma^\mu - \frac{2p'^\mu + q^\mu}{(p' + q)^2 - p'^2} \not{q}] \frac{g_2((p' + q)^2)}{m} \gamma^5 \right\} \right) u(p), \quad (\text{C6}) \end{aligned}$$

where the definitions given in Eqs. (10-13) have been used. Eqs. (C3-C6) correspond, respectively, to the u-, s-, t-channel and contact diagrams for the process $N\pi \rightarrow N\gamma$. The four-momentum of the pion k is taken incoming, the four-momentum of the photon q is taken outgoing, p and p' are the momenta of the incoming and outgoing nucleons, respectively; so four-momentum conservation reads $p + k = p' + q$. The πNN vertex in Eq. (C5) is taken as $\tau_\beta \gamma^5 g$, where g is the pion-nucleon coupling constant. The reason for this is that the nucleon-pion vertex with the two on-shell nucleons and an off-shell pion (carrying four-momentum k) reduces to the form (see Eq. (10)) $\tau_\alpha \gamma^5 G_1(m^2, m^2, k^2)$, where the form factor is normalized so that $G_1(m^2, m^2, m_\pi^2) = g$. However, as mentioned above, we have obtained a very weak dependence of the nucleon-pion vertex on the pion four-momentum squared. Thus, we take $G_1(m^2, m^2, k^2) = g$ for all k^2 , which explains the form of the πNN vertex in Eq. (C5). The diagrammatic form of Eqs. (C3-C6) is shown in Fig. 3.

To prove gauge invariance of the pion photoproduction amplitude Eq. (C2), i.e. to prove that [32]

$$q_\mu \bar{u}(p') T_\alpha^\mu u(p) = 0, \quad (\text{C7})$$

we use Eq. (C1) and the fact that if a nucleon is on-shell with four-momentum p , then $\bar{u}(p) S^{-1}(p) = 0$ and $S^{-1}(p) u(p) = 0$ since the propagator has a pole at the nucleon mass. First, for $T_{1,\alpha}$ we have

$$q_\mu \bar{u}(p') T_{1,\alpha}^\mu u(p) = -\tau_\alpha \hat{e}_N \bar{u}(p') \Gamma^5(m, p' - k) u(p). \quad (\text{C8})$$

Next,

$$q_\mu \bar{u}(p') T_{2,\alpha}^\mu u(p) = \hat{e}_N \tau_\alpha \bar{u}(p') \Gamma^5(p' + q, m) u(p), \quad (\text{C9})$$

and

$$q_\mu \bar{u}(p') T_{3,\alpha}^\mu u(p) = (\hat{e}_\pi)_{\alpha\beta} \tau_\beta \bar{u}(p') \gamma^5 g u(p). \quad (\text{C10})$$

Finally, for the contact term,

$$\begin{aligned} q_\mu \bar{u}(p') T_{4,\alpha}^\mu u(p) &= \tau_\alpha \hat{e}_N \bar{u}(p') [\Gamma^5(m, p' - k) - \gamma^5 g] u(p) \\ &\quad - \hat{e}_N \tau_\alpha \bar{u}(p') [\Gamma^5(p' + q, m) - \gamma^5 g] u(p), \end{aligned} \quad (\text{C11})$$

where we have taken into account the normalization condition for the nucleon-pion vertex with both nucleons on-shell, $\bar{u}(p') \Gamma^5(m, m) u(p) = \bar{u}(p') \Gamma^5(m, m) u(p) = \bar{u}(p') \gamma^5 g u(p)$. At this point it may be noted that the terms in the second and the fourth lines in the contact term Eq. (C6) are orthogonal to the photon momentum q_μ , and therefore, although we keep these terms in $T_{4,\alpha}^\mu$, their presence is not necessary for the amplitude T_α^μ to be gauge invariant. Adding Eqs. (C8-C11) and using $[\hat{e}_N, \tau_\alpha] = -(\hat{e}_\pi)_{\alpha\beta} \tau_\beta$, we obtain the desired result,

$$q_\mu \bar{u}(p') T_\alpha^\mu u(p) = \bar{u}(p') \left((\hat{e}_\pi)_{\alpha\beta} \tau_\beta \gamma^5 g + \gamma^5 g [\hat{e}_N, \tau_\alpha] \right) u(p) = 0. \quad (\text{C12})$$

We are going to use the gauge invariance of the pion photoproduction amplitude to show that our solution of Eq. (9) obeys the Ward-Takahashi identity for the nucleon-photon

vertex. This can be done in a transparent way with the help of diagrammatic expressions. As explained, the pole contribution to the vertex is given by the sum of diagrams depicted in Fig. 2. (We assume here that the convergence of the procedure has been reached, and hence the superscript n can be erased in the γNN vertex in the loop of the second diagram.) This sum can be rewritten by adding and subtracting an additional diagram containing the pole contribution to the self-energy in the incoming nucleon leg, as shown in Fig. 4 (top). Index I on the left-hand side (*l.h.s.*) of this equation indicates that only the pole contribution to the vertex is considered. We remind the reader that, as part of our solution procedure, only real parts of the form factors and the functions parametrizing the nucleon self-energy enter in the diagrams on the right-hand side (*r.h.s.*). In other words, the imaginary part contribution to the vertex is solely due to the explicitly shown cut loops in Fig. 4 (top). Now let us consider the scalar product of the *r.h.s.* with the photon four-momentum q_μ . To find the result, it is convenient to rewrite the equation of Fig. 4 (top) as shown in Fig. 4 (bottom). Here, a common sub-diagram, which is a half-off-shell nucleon-pion vertex, has been extracted from some of the diagrams on the *r.h.s.* of Fig. 4 (top), and the asterisk indicates that an integration is tacitly understood over the phase space of the cut (on-shell) nucleon and pion lines. Such separation of a sub-diagram is consistent with the interpretation of Cutkosky rules as a unitarity condition [15]. Note also that we have erased the dash on the outgoing nucleon line, to stress that now the Dirac spinor $\bar{u}(p')$ is explicitly identified with this line. The sum of diagrams in the brackets is just the scattering amplitude T_α^μ for pion photoproduction. As has been shown, this amplitude is gauge invariant, i.e. $q_\mu T_\alpha^\mu = 0$. Therefore, the scalar product of q_μ with the *r.h.s.* equals the scalar product of q_μ with only the first diagram on the right-hand side of Fig. 4 (bottom),

$$q_\mu(r.h.s.)^\mu = -q_\mu \bar{u}(p') \Gamma^\mu(m, p) S(p) \Sigma_I(p), \quad (\text{C13})$$

where $\Sigma_I(p)$ stands for the pole contribution to the nucleon self-energy. Since we have assumed that the Ward-Takahashi identity holds for the vertices on the *r.h.s.*, we can contract q_μ with $\Gamma^\mu(m, p)$ in Eq. (C13) and obtain

$$q_\mu(r.h.s.)^\mu = -\hat{e}_N \bar{u}(p') \Sigma_I(p). \quad (\text{C14})$$

This is exactly what one obtains if one contracts q_μ with the pole contribution to the general half-off-shell γNN vertex. Indeed, it follows from Eq. (C1) that

$$q_\mu \bar{u}(p') \Gamma_I^\mu(m, p) = \hat{e}_N \bar{u}(p') S_I^{-1}(p), \quad (\text{C15})$$

where subscript I denotes the pole contribution of the relevant entity. Using the Schwinger-Dyson equation, $S^{-1}(p) = S_0^{-1}(p) - \Sigma(p)$, with $S_0(p) = (\not{p} - m)^{-1}$ being the free nucleon propagator, and taking into account that the pole contribution to $S_0^{-1}(p)$ is zero, we see that the right-hand sides of Eq. (C15) and Eq. (C14) are equal. Thus, we have shown that the procedure used in this model is consistent with the Ward-Takahashi identity.

REFERENCES

- [1] A. Bincer, Phys. Rev. **118**, 855 (1960).
- [2] S. D. Drell and H. R. Pagels, Phys. Rev. **140**, B397 (1965).
- [3] E. M. Nyman, Nucl. Phys. **A154**, 97 (1970).
- [4] M. G. Hare, Ann. Phys. (N.Y.) **74**, 595 (1972)
- [5] H. W. L. Naus and J. H. Koch, Phys. Rev. C **36**, 2459 (1987).
- [6] P. C. Tiemeijer and J. A. Tjon, Phys. Rev. C **42**, 599 (1990).
- [7] J. W. Bos, S. Scherer and J. H. Koch, Nucl. Phys. **A547**, 488 (1992).
- [8] J. W. Bos and J. H. Koch, Nucl. Phys. **A563**, 539 (1993).
- [9] H. C. Dönges, M. Schäfer and U. Mosel, Phys. Rev. C **51**, 950 (1995).
- [10] E. M. Nyman, Nucl. Phys. **A160**, 517 (1971).
- [11] S. Kondratyuk, G. Martinus and O. Scholten, Phys. Lett. B **418**, 20 (1998).
- [12] Yi Li, M. K. Liou and W. M. Schreiber, Phys. Rev. C **57**, 507 (1998).
- [13] A. Yu. Korchin, O. Scholten and F. de Jong, Phys. Lett. B **402**, 1 (1997).
- [14] S. Kondratyuk and O. Scholten, Phys. Rev. C **59**, 1070 (1999).
- [15] R. E. Cutkosky, J. Math. Phys. **1**, 429 (1960); G. 't Hooft and M. J. G. Veltman, Diagrammar, CERN Yellow Report 73-09.
- [16] Y. Takahashi, Nuovo Cimento **6**, 371 (1957).
- [17] K. Ohta, Phys. Rev. C **40**, 1335 (1989).
- [18] H. Haberzettl, Phys. Rev. C **56**, 2041 (1997).
- [19] S. I. Nagorny and A. E. L. Dieperink, nucl-th/9803007.
- [20] P. F. A. Goudsmit, H. J. Leisi, E. Matsinos, B. L. Birbrair, and A. B. Gridnev, Nucl. Phys. **A575**, 673 (1994).
- [21] O. Scholten, A. Yu. Korchin, V. Pascalutsa, and D. Van Neck, Phys. Lett. B **384**, 13 (1996).
- [22] A. Yu. Korchin, O. Scholten, and R. G. E. Timmermans, Phys. Lett. B **438**, 1 (1998).
- [23] M. Gell-Mann and M. L. Goldberger, Phys. Rev. **96**, 1433 (1954).
- [24] F. E. Low, Phys. Rev. **96**, 1428 (1954).
- [25] S. Kamefuchi, L. O'Raifeartaigh and A. Salam, Nucl. Phys. **28**, 529 (1961).
- [26] S. Scherer and H. W. Fearing, Phys. Rev. C **51**, 359 (1995).
- [27] R. M. Davidson and G. I. Poulis, Phys. Rev. D **54**, 2228 (1996).
- [28] E. Kazes, Nuovo Cimento **13**, 1226 (1959).
- [29] C. Itzykson and J.-B. Zuber, *Quantum Field Theory* (McGraw-Hill, Inc., 1986).
- [30] REDUCE user's manual, version 3.1, ed. A. C. Hearn, The Rand Corporation, Santa Monica, 1984.
- [31] A. Pais and G. E. Uhlenbeck, Phys. Rev. **79**, 145 (1950).
- [32] S. Weinberg, *The Quantum Theory of Fields* (Cambridge University Press, 1996), vol. 1, p. 448.
- [33] J. C. Bergstrom and E. L. Hallin, Phys. Rev. C **48**, 1508 (1993).
- [34] I. Guiasu, C. Pomponiu and E. E. Radescu, Ann. Phys. **114**, 296 (1978).
- [35] S. Scherer, A. Yu. Korchin and J. H. Koch, Phys. Rev. C **54**, 904 (1996).
- [36] S. Scherer, nucl-th/9901056.

FIGURES

FIG. 1. The graphical representation of Eq. (9). The solid, dashed and wavy lines are nucleons, pions and photons, respectively. The thick line is the dressed nucleon propagator. The empty circle (square) is the dressed πNN (γNN) vertex, and the shaded circle stands for the “contact” $\gamma\pi NN$ vertex. The dashed external lines are stripped away.

FIG. 2. The pole contributions of iteration $n + 1$ to the γNN vertex. The left upper, the right upper and the lower diagrams correspond to Eqs (15,27,39), respectively. In addition to the notation explained in Fig. 1, the crossed lines are on-shell particles. The vertices and the propagator bearing the subscript R contain only the real parts of the scalar functions that parametrize them.

FIG. 3. The skeleton diagrams for the pion photoproduction amplitude as given by Eqs. (C2-C6). The notation is as in Figs. 1 and 2, except all the external lines are on-shell and not stripped away.

FIG. 4. Top: The diagrammatic equation used in the first part of the proof of the consistency of the method with the Ward-Takahashi identity, as explained in Section III.B.6. The notation is as in Figs. 1 and 2. The pole contribution to the γNN vertex (indicated by the subscript I) is shown on the left-hand side. The right-hand side equals the sum of the diagrams in Fig. 2, where the convergence is assumed to have been reached. Bottom: The second part of the proof of the consistency of the method with the Ward-Takahashi identity, as explained in Section III.B.6. It is equivalent to applying both sides of the top equation to the positive-energy spinor of the outgoing nucleon. The asterisk denotes an integration over the phase space of the cut nucleon and pion lines.

FIG. 5. The imaginary (the upper panel) and real (the lower panel) parts of the form factors F_2^+ (the solid curves) and F_2^- (the dotted curves) as functions of the momentum squared of the off-shell proton, defined in Eq. (7). In this calculation, the contact $\gamma\pi NN$ term of Eq. (37) was used.

FIG. 6. The same as in Fig. 5, except the alternative contact $\gamma\pi NN$ term of Eq. (38) was used in this calculation.

FIG. 7. The same as in Fig. 5, but for the neutron-photon vertex.

FIG. 8. The same as in Fig. 6, but for the neutron-photon vertex

FIG. 9. The same as in Figs. 5 and 6, but for the form factors F_1^\pm .

FIG. 10. The skeleton diagrams for the Compton scattering amplitude as given by Eqs. (60-62) and (58). The notation is as in Figs. 1 and 2, except all the external lines are on-shell and not stripped away. The shaded square is the contact $\gamma\gamma NN$ term.

FIG. 11. The Feynman diagrams forming the K-matrix for Compton scattering up to second order in the “potential” $V_{c'c}$, according to Eq. (57). The notation is as in Fig. 1, and all the external lines are on-shell. The index Re shows that only the principal value part of the loop integrals are included. The structure of the loop diagrams in terms of the tree diagrams for pion photoproduction is denoted by ss , su , st etc., as explained in the text.

FIG. 12. The cross section for the Compton scattering in the forward direction as a function of the photon energy, obtained in the K-matrix formalism as described Section VI. The solid line represents the calculation where the dressed (irreducible) nucleon-photon and nucleon-pion vertices, as well as the dressed nucleon propagator, are included in the K-matrix. The dotted line is the calculation with the same K-matrix, but where the bare vertices and the free nucleon propagator are used. The dashed line is the cross section calculated using only the tree-level diagrams.

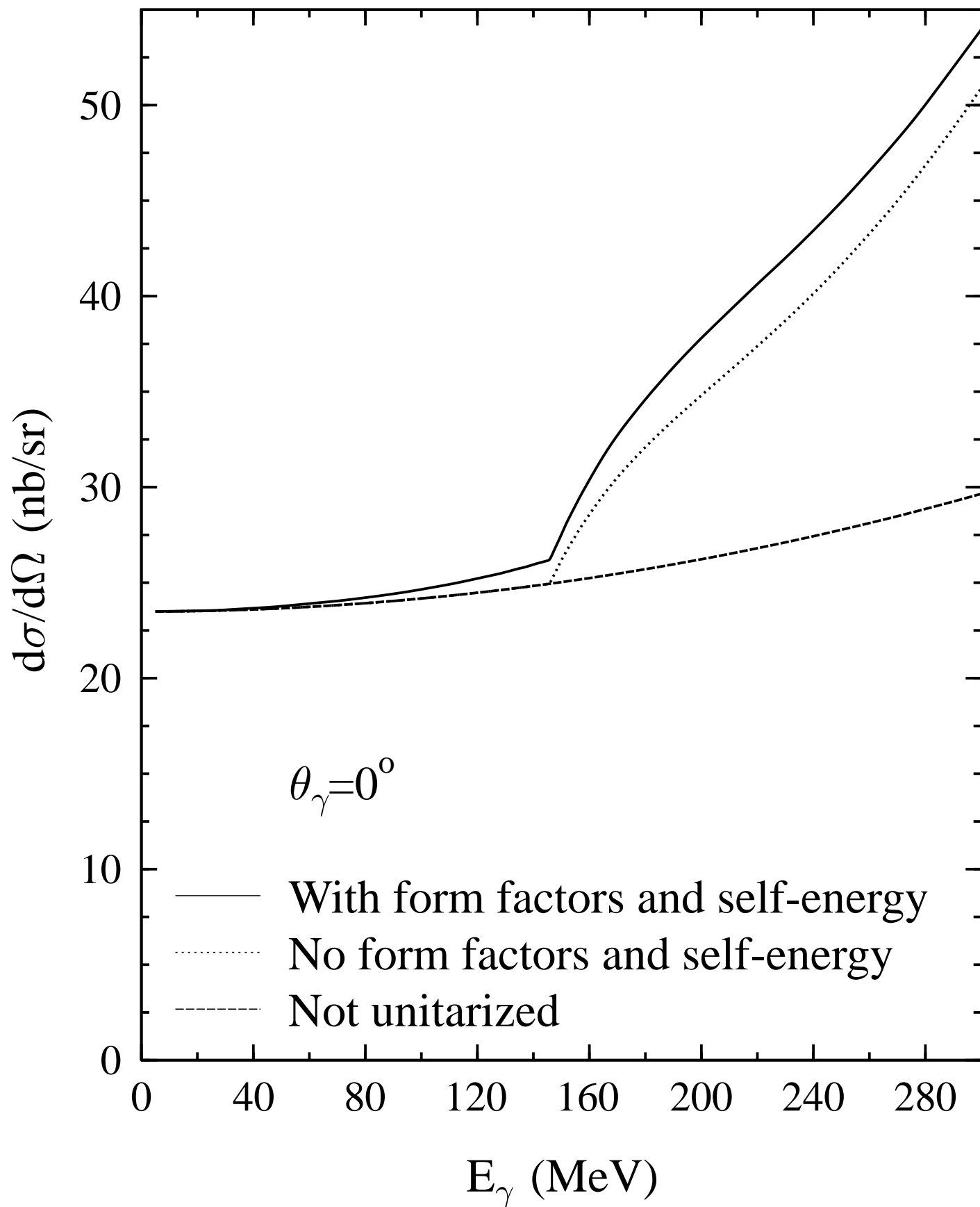

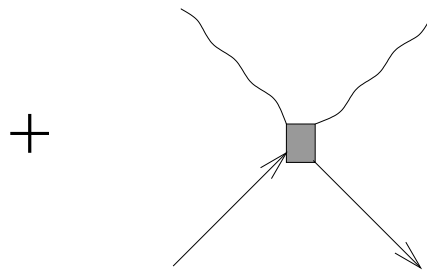
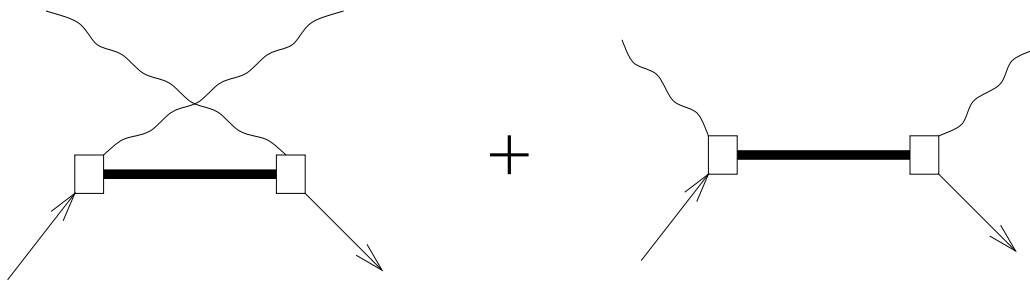

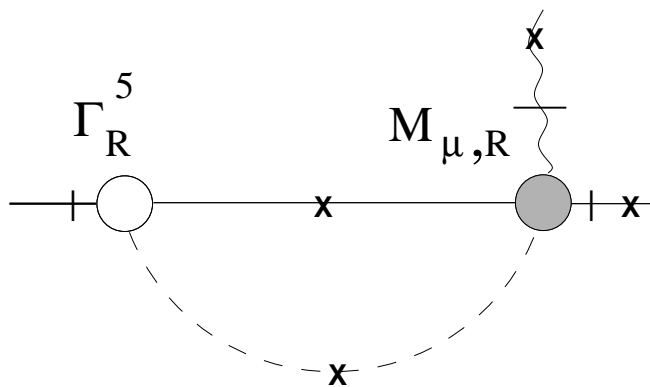
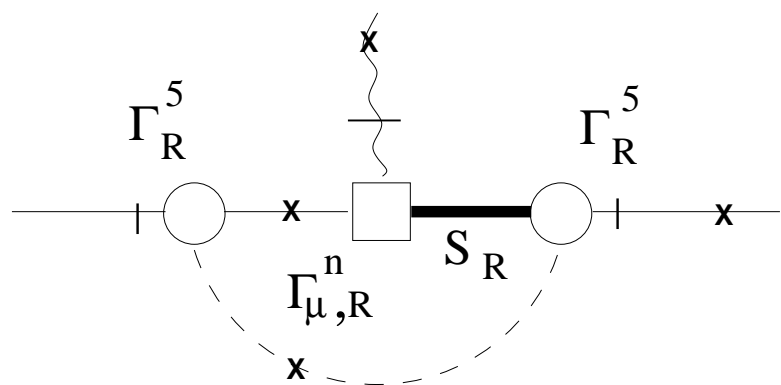
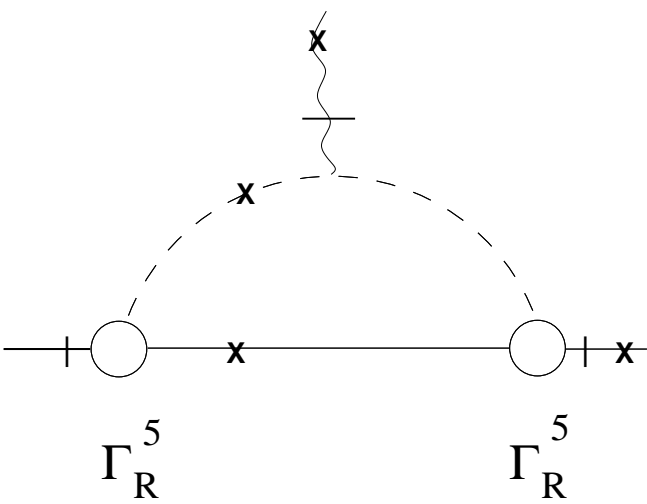

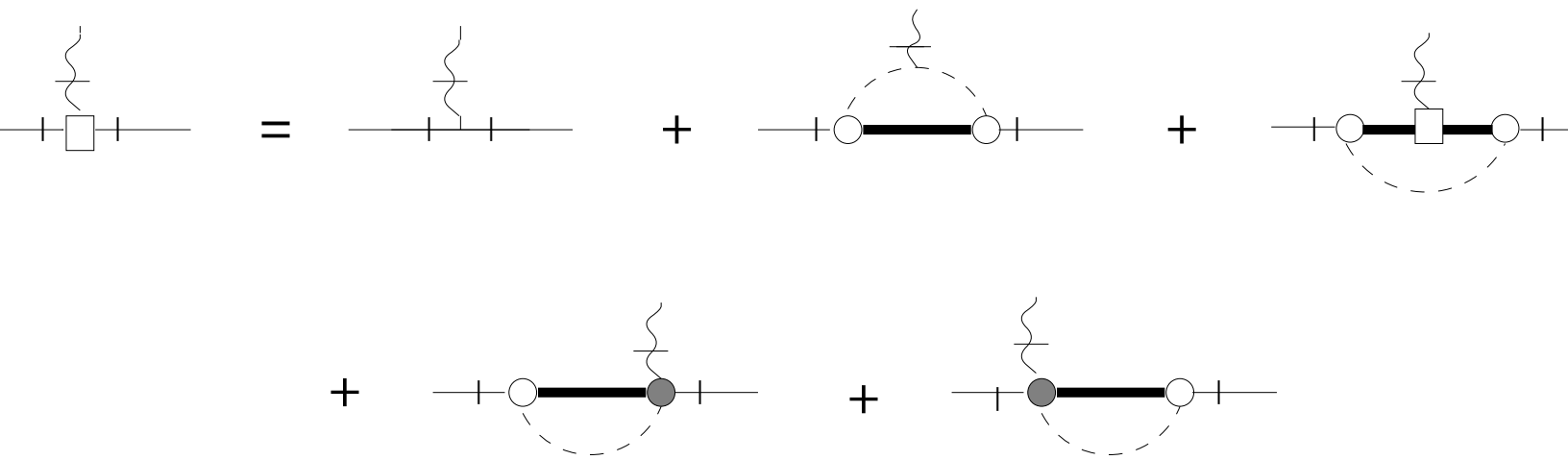

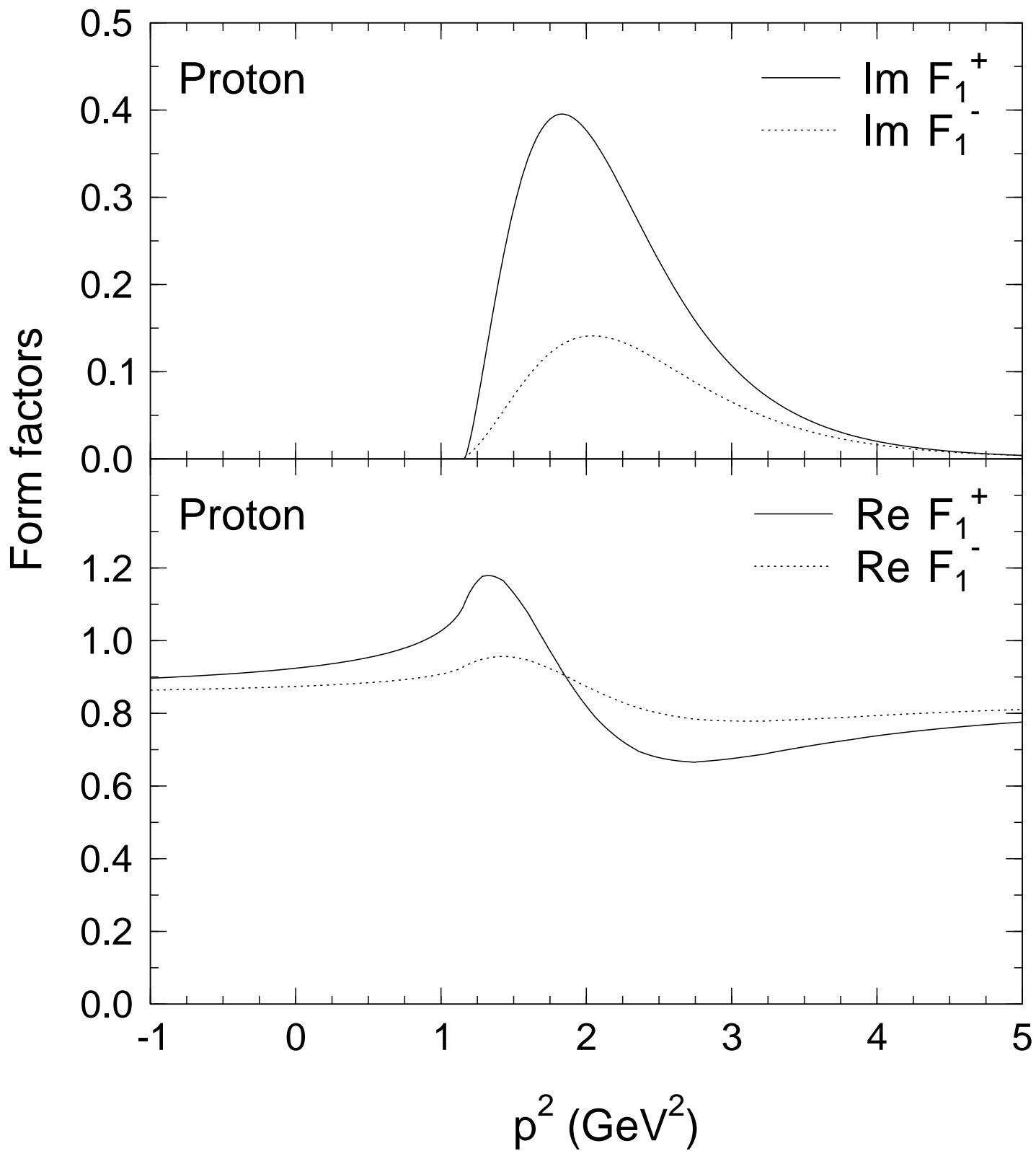

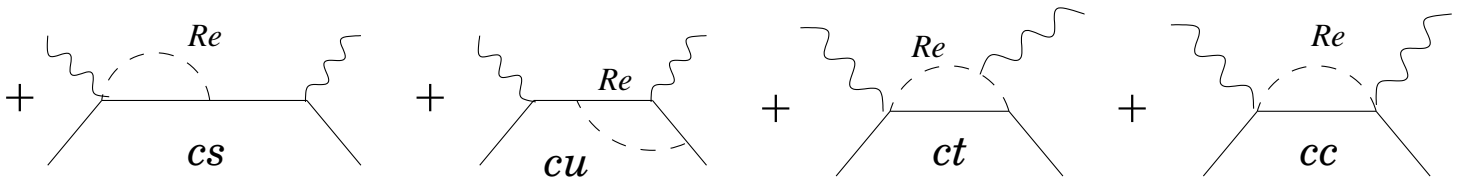
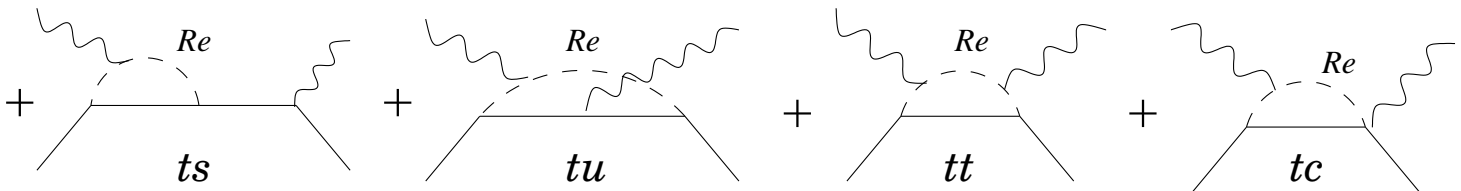
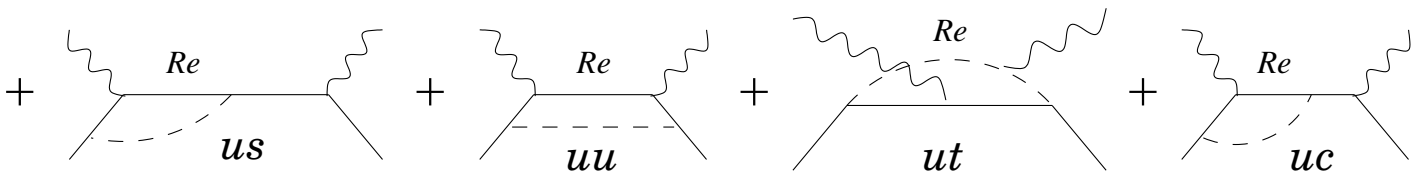
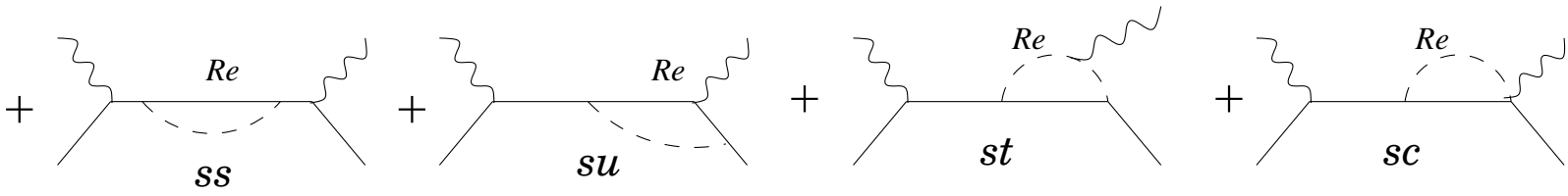
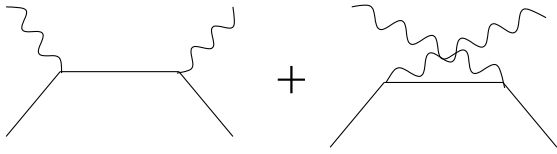

$$\left(\begin{array}{c} \text{wavy line} \\ \square \text{---} \mathbf{x} \end{array} \right) \mathbf{I} = \begin{array}{c} \text{wavy line} \\ \text{---} \bigcirc \text{---} \mathbf{x} \text{---} \bigcirc \text{---} \mathbf{x} \\ \text{---} \bigcirc \text{---} \mathbf{x} \text{---} \square \text{---} \bigcirc \text{---} \mathbf{x} \\ \text{---} \bigcirc \text{---} \mathbf{x} \text{---} \square \text{---} \mathbf{x} \\ \text{---} \bigcirc \text{---} \mathbf{x} \text{---} \bigcirc \text{---} \square \text{---} \mathbf{x} \\ \text{---} \bigcirc \text{---} \mathbf{x} \text{---} \bigcirc \text{---} \square \text{---} \mathbf{x} \end{array}$$

The diagram shows the expansion of a square vertex with an incoming wavy line into five terms. The terms are:

- 1. A triangle loop with a wavy line on the top edge, a dashed line with label \mathbf{x} on the left edge, and a solid line with label \mathbf{x} on the right edge.
- 2. A loop with a wavy line on the top edge, a dashed line with label \mathbf{x} on the bottom edge, a solid line with label \mathbf{x} on the left edge, and a thick solid line on the right edge.
- 3. A loop with a dashed line with label \mathbf{x} on the bottom edge, a solid line with label \mathbf{x} on the left edge, and a thick solid line on the right edge.
- 4. A loop with a dashed line with label \mathbf{x} on the bottom edge, a thick solid line on the left edge, and a solid line with label \mathbf{x} on the right edge.
- 5. A loop with a dashed line with label \mathbf{x} on the bottom edge, a thick solid line on the left edge, and a thick solid line on the right edge.

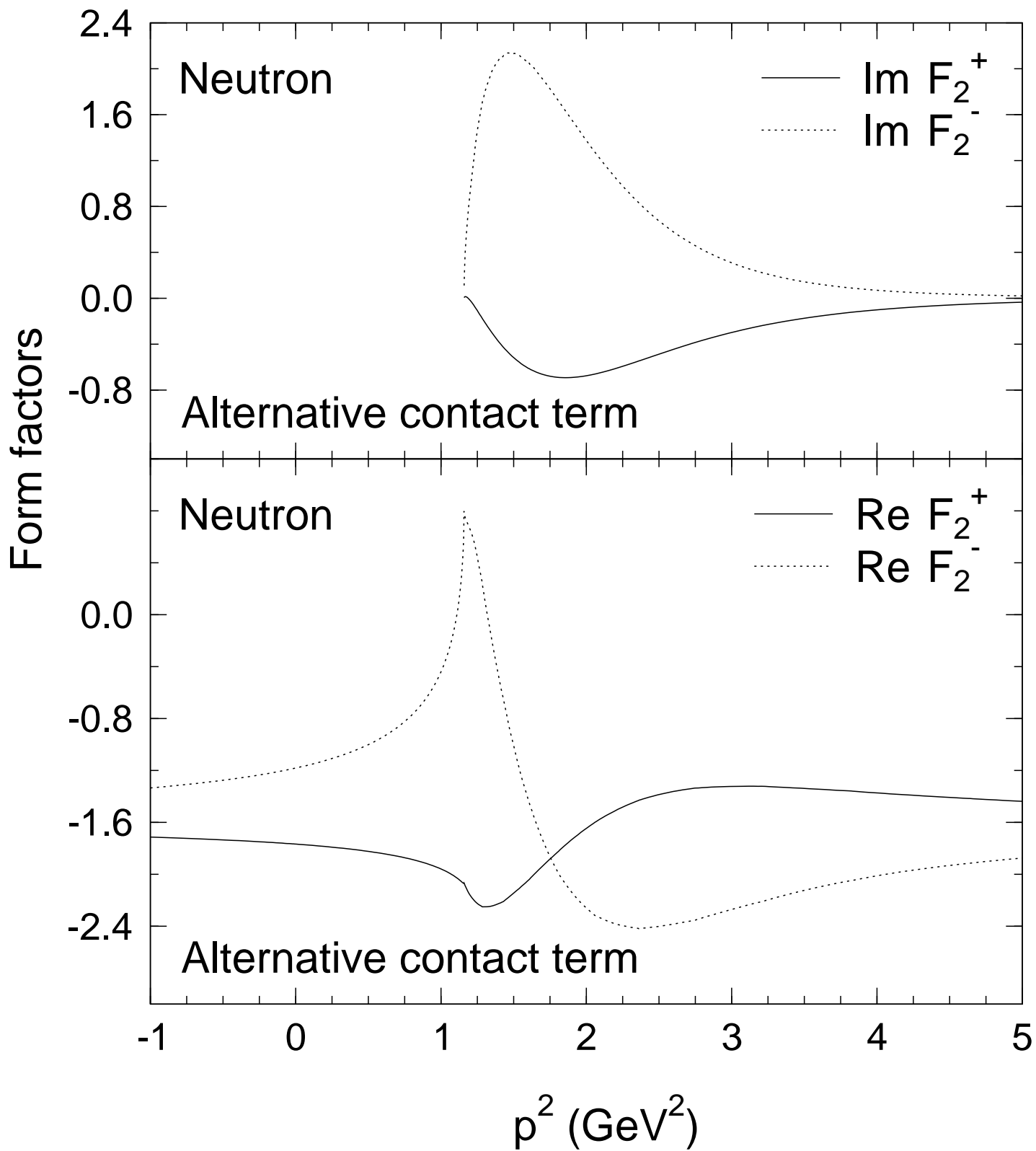

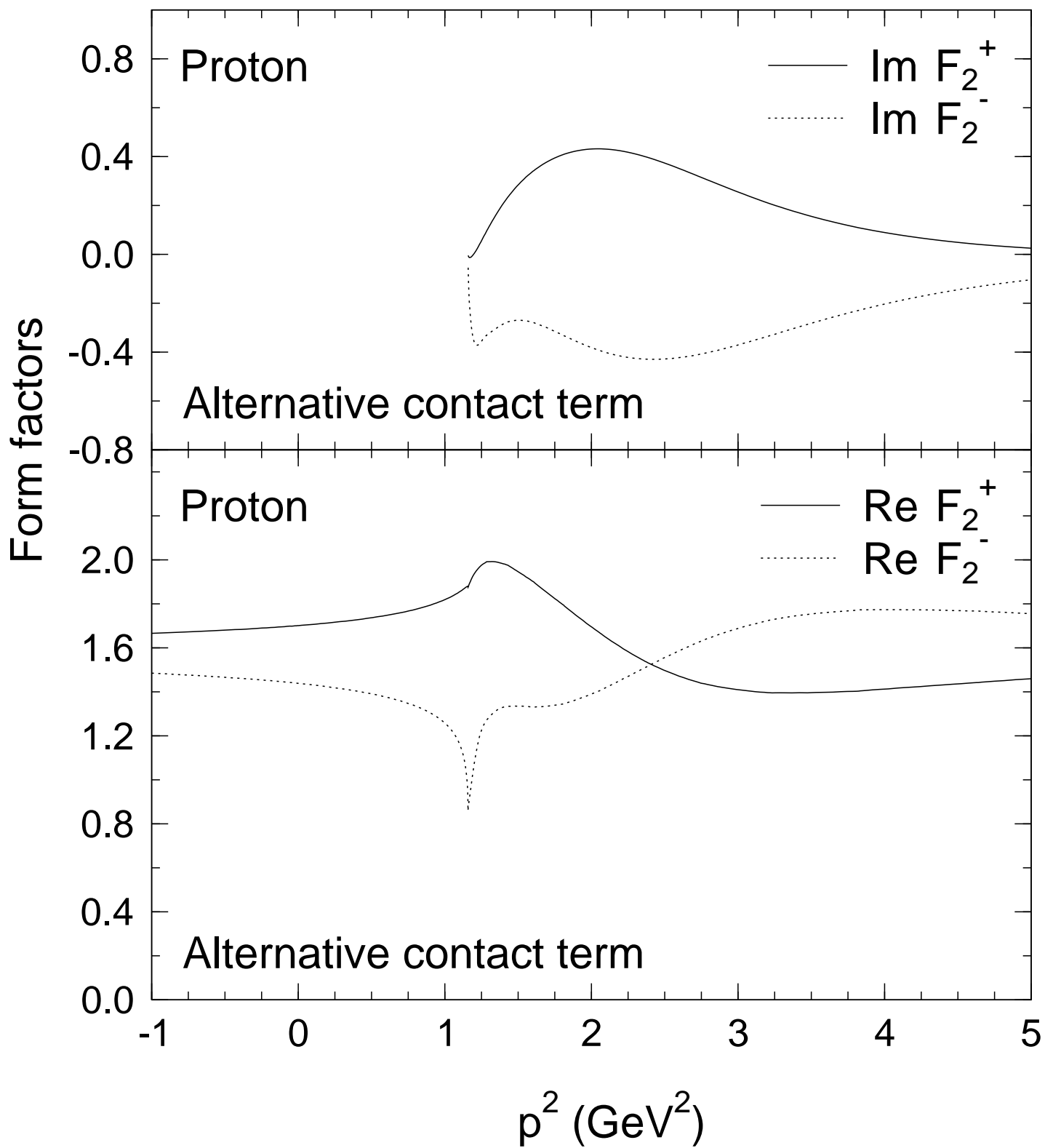

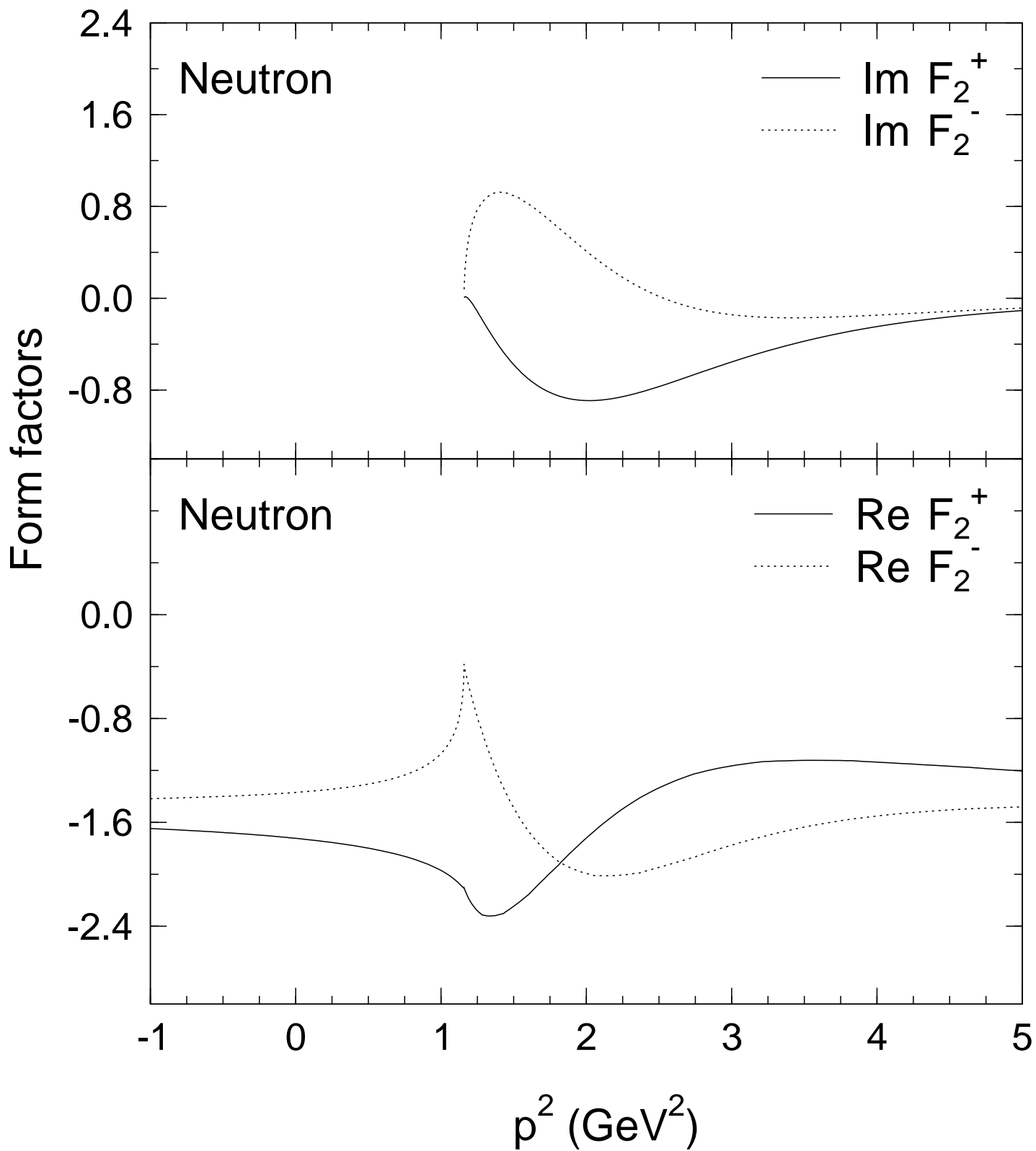

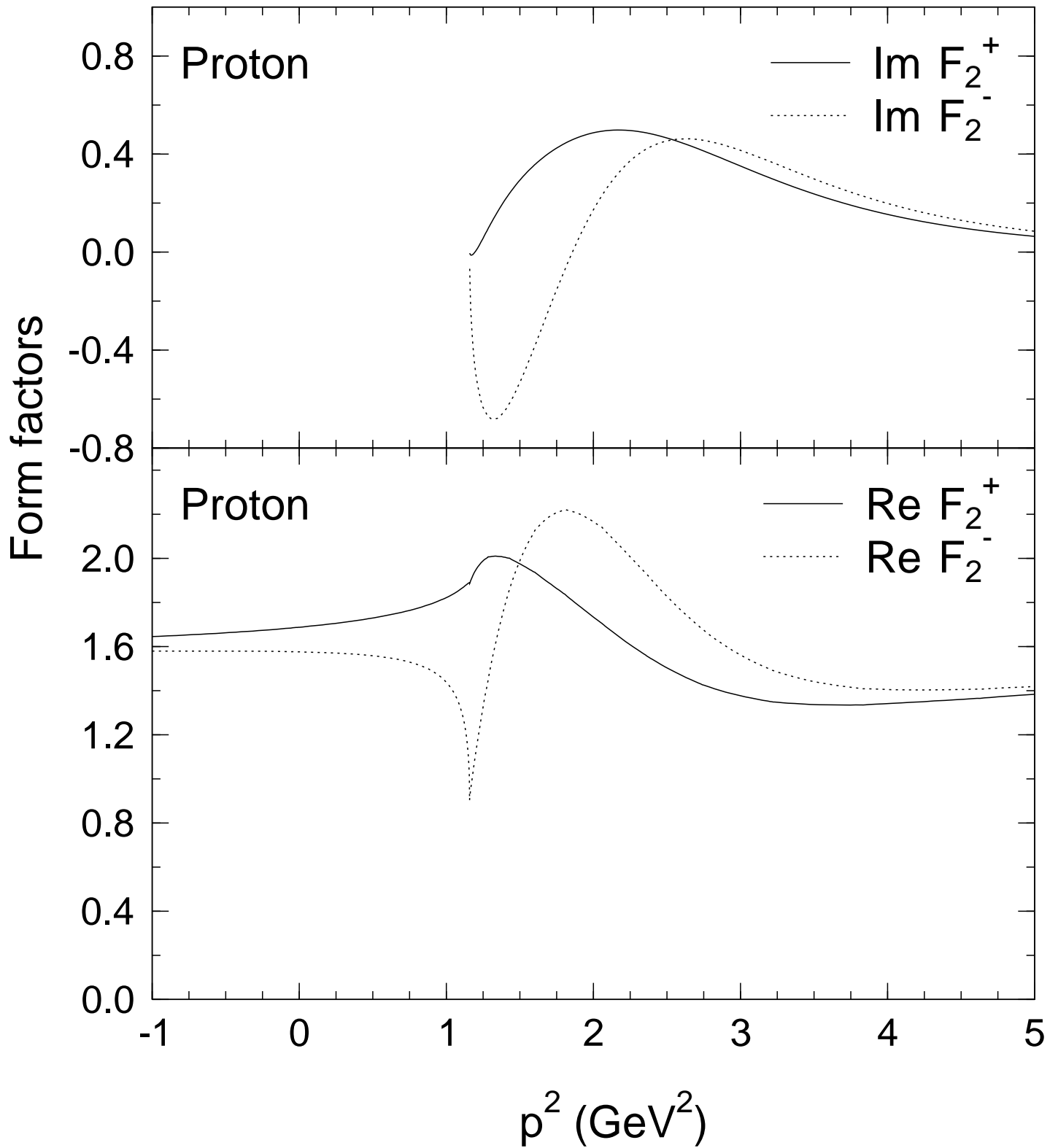

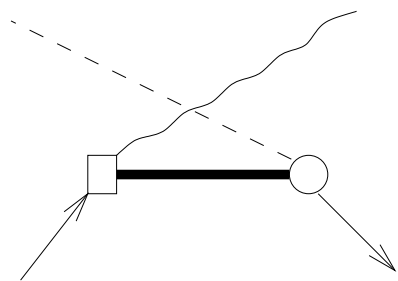

+

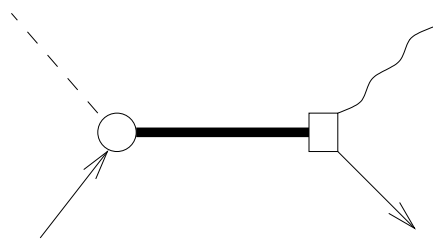

+

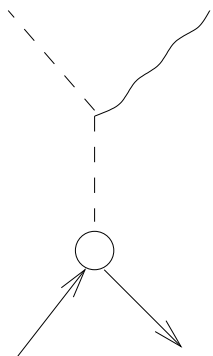

+

