

# The $\pi$ NNN–NNN problem. Connectedness, transition amplitudes and quasi–particle approximation

G. Cattapan and L. Canton

*Istituto Nazionale di Fisica Nucleare e Dipartimento di Fisica dell' Università  
via Marzolo 8, Padova I-35131, Italia*

## Abstract

In this paper we review the present status of the  $\pi$ NNN–NNN problem. In particular, we re–consider the chain–labelled approach recently proposed by us, and identify a class of graphs, previously overlooked, which prevents the kernel of the corresponding  $\pi$ NNN–NNN equations from being connected. We propose some approximate schemes, yielding connected–kernel equations. A generalization of the residue method allows to relate the transition amplitudes for the coupled  $\pi$ NNN–NNN system to the chain–labelled formalism. The quasi–particle approach is extended to the present situation, where emission/absorption of particles is allowed. The open problems for the  $\pi$ NNN–NNN system in the light of the present and of previous approaches are finally discussed.

PACS numbers: 21.45.+v, 11.80.Jy, 13.75.Gx, and 25.80.-e  
Preprint DFPD 97/TH/17

arXiv:nucl-th/9706011v1 3 Jun 1997

## I. INTRODUCTION

In two previous papers [1,2] we have outlined a new approach to the  $\pi$ NNN–NNN problem, which can be regarded as the natural extension of the Grassberger–Sandhas (GS)  $n$ –body method [3,4] to situations in which the number of particles is no longer conserved. As is well–known, the GS formalism represents a basic achievement in modern  $n$ –body scattering theory. It casts in a physically transparent form the connected–kernel Yakubovskii (Y) scheme [5], which enjoys the distinctive feature of being completely free from non–physical solutions. Indeed, not only it guarantees that the Fredholm alternative holds, so that non–physical solutions do not contaminate the physical one in the scattering region, but it satisfies also a constrained Fredholm alternative [6]; the non–trivial solutions of the associated homogeneous equations are in one–to–one correspondence with the bound states of the total system. Most of the connected–kernel  $n$ –body equations proposed in the literature satisfy the former condition, but fail in guaranteeing the latter.

The extension of the GS formalism considers scattering and pion production/absorption processes on equal footing, thus providing a coupled treatment of all the relevant processes in the same dynamically consistent framework. The  $\pi$  production introduces radical changes in the structure of the dynamical equations and gives rise to challenges and problems which were not possible in standard  $n$ –body theories.

On a fundamental level, there is the problem with nucleon renormalization, which is unavoidable in theories where the Fock space is truncated to states with at most one pion. This problem is well acknowledged in the literature [7–13], and herein is not discussed.

The first problem considered in this paper concerns the connectedness of the  $\pi$ NNN integral equations, and we arrive at the conclusion that, contrary to our previous belief [2], these equations are not connected. In this paper we identify a class of graphs, previously overlooked, which prevents the kernel from being connected. We show that the problem arises when the  $3+1$  ( $(\pi NN)N$ ) and  $2+2$  ( $((NN)(\pi N))$ ) partitions are treated on equal footing, and that connectedness can be restored with two iterations of the kernel if the coupling between the  $\pi$ NNN and NNN sectors is switched off in the  $2+2$  partitions, whereas it is treated exactly in the  $\pi$ NN sub–systems. As a matter of fact, connectedness is guaranteed also when production/absorption processes are allowed in  $2+2$  partitions, provided that the exact sub–system amplitudes are projected in the sole  $\pi$ NNN sector.

The second problem we analyze in detail is the problem with the identification of certain physical transition amplitudes which refer to the nucleon–deuteron channel. The ambiguities in the definition of these amplitudes are originated by the delicate interplay between the  $2+2$  and  $3+1$  partitions, and are closely related with the connectedness problem. Indeed, with the same approximation scheme we restore the connectedness in our equations and solve these amplitude ambiguities.

The extension of the GS approach to the  $\pi$ NNN system is briefly illustrated in Sect. II. Starting from the transition amplitudes for  $4 \rightarrow 4$  processes, one first extracts operators referring to three–cluster  $\rightarrow$  three–cluster transitions, which satisfy dynamical equations formally identical to the Afnan–Blankleider (AB) equations for the  $\pi$ NN–NN system [14–16]. By resorting to the powerful GS matrix technique, the two–cluster partitions are introduced into the theory, and one gets at the end dynamical equations quite similar in structure to the GS four–body equations. The presence of emission/absorption processes, however, implies

some noticeable differences, when these equations are analyzed in detail. The chain-of-partition labelling, characterizing the YGS approach, is now more complex, since one has to regard nucleon pairs both as three-cluster partitions in the  $\pi$ NNN sector, and as two-cluster partitions in the NNN space. As a consequence, one deals with a set of 24 coupled equations, in place of the 18 characterizing the standard YGS scheme.

In Sect. III we establish the relation between the employed operators, labelled by chains of partitions, and the physical amplitudes connecting the various partitions of the system. As is well-known in non-relativistic scattering theory, the physical transition amplitudes can be identified by exhibiting the momentum-space singular terms of the total Green function, in correspondence to the bound states of the various sub-systems [6,17,18]. This procedure, which has its relativistic counterpart in reduction formulae of Quantum Field Theory [19], is often referred to as the residue method [6,14]. Alternatively, one can work in the language of transition operators. For the standard n-body problem, by combining the residue rule with the GS matrix technique, it has been shown [2] that the two-cluster  $\rightarrow$  two-cluster transition amplitudes can be related to the solution of the n-body YGS equations, starting from the transition amplitudes for n  $\rightarrow$  n processes. Here, as anticipated in [1], we generalize this procedure to the  $\pi$ NNN-NNN case, where the coupling between spaces with different numbers of particles has to be taken into account. Starting from the relations expressing the 4  $\rightarrow$  4 transition amplitudes in terms of operators referring to less and less clusterized partitions, we systematically identify the poles associated to the bound-states or resonances in the various two- and three-body sub-systems. As the outcome of this procedure, we express both the rearrangement and the meson absorption/emission transition amplitudes in terms of the solution of our chain-labelled equations. Finally, in the same Section, we discuss also the ambiguities in the identification of the physical amplitudes, and the associated role played by the 3 + 1 and 2 + 2 partitions in this problem.

In Sect. IV we consider the Quasi-Particle-Approximation (QPA). In the four-body case, this amounts to a two-step procedure [3,4,6]. One first replaces the two-body t-matrices with finite-rank operators, thereby re-writing the YGS equations as effective Faddeev equations for two elementary particles and a composite object; as a second step, one approximates again the three-body and 2 + 2 sub-system amplitudes by finite-rank operators. One thus obtains multichannel Lippmann-Schwinger-type (LS) equations in one vector variable, coupling the elastic/rearrangement transition amplitudes. The physical transition amplitudes for break-up processes can be evaluated starting from the solution of the effective LS equations through simple quadratures. We show here that the QPA can be extended to the present situation. Here also the two-fragment  $\rightarrow$  two-fragment transition amplitudes satisfy LS equations, all the break-up and emission/absorption amplitudes being expressible in terms of them by quadratures. The QPA approach is particularly attractive because it shows the theory through diagrams which can be easily interpreted. It is then possible to view the diagrams which are at the origin of the disconnectedness problem. These disconnected graphs are self-energy-type contributions to the transition from a  $(\pi N)(NN)$  to a  $N(\pi NN)$  configuration with intermediate zero-pion state. If this term is disregarded, one gets connected-kernel equations, much as in the standard four-body problem. Needless to say, the same is true if emission/absorption processes are switched off in 2 + 2 sub-systems, or allowed only in the sub-system amplitudes referring to the four-body sector.

Given the present situation, we review in Sect. V the approaches available in literature

[15,20]. In [15] one applies the quasi-particle approximation to the basic AB equations, and removes the disconnected pieces occurring in the standard four-body problem first, by resorting to the usual GS method. All disconnected terms due to pion emission/absorption are then treated together, by use of a two-potential formula. Disconnected contributions are formally regarded as an auxiliary problem, whose solution gives the input for connected-kernel equations yielding the physical transition operators. As a consequence, the actual transition amplitudes can be evaluated only solving nested sets of integral equations. Finally, these rigorous FY-type approaches are compared to the effective, coupled-channel formalism of Ref. [20]. It turns out that this phenomenological method is at variance with present few-body scattering theory, since it assumes *ad hoc* couplings between configurations of the  $\pi$ NNN and NNN systems, which are excluded in more microscopic FY-type formulations.

## II. THE DYNAMICAL EQUATIONS

As in Refs. [1,2], we start from the unclusterized transition operators which are allowed in the NNN and  $\pi$ NNN sectors of the theory. Let  $T_{(0|0)}$  be the operator associated to the transition from a three-nucleon state  $|\chi_0\rangle$  to a three-nucleon state  $|\chi'_0\rangle$ , so that the corresponding transition amplitude is given by  $\langle \chi'_0|T_{(0|0)}|\chi_0\rangle$ . Similarly,  $T_{(1|1)}$  describes a transition from an initial  $\pi$ NNN state  $|\chi_1\rangle$  to a final one  $|\chi'_1\rangle$ . The two sectors communicate through the absorption and production operators  $T_{(0|1)}$  and  $T_{(1|0)}$ , respectively, the associated transition amplitudes being  $\langle \chi'_1|T_{(1|0)}|\chi_0\rangle$ , and  $\langle \chi'_0|T_{(0|1)}|\chi_1\rangle$ . The AB transition operators can be introduced through the relations [1,2]

$$T_{(0|0)} = U, \tag{2.1a}$$

$$T_{(1|0)} = \sum_a t_a G_0 U_a, \tag{2.1b}$$

$$T_{(0|1)} = \sum_b U_b^\dagger G_0 t_b, \tag{2.1c}$$

$$T_{(1|1)} = \sum_a t_a + \sum_{a,b} t_a G_0 U_{ab} G_0 t_b. \tag{2.1d}$$

Here,  $G_0$  represents the free  $\pi$ NNN propagator. As usual in few-body scattering theory, indices such as  $a$ ,  $b$ , and  $c$  denote generic three-cluster partitions of the four-body system, namely, interacting pairs in presence of two spectator particles. If necessary, to distinguish between NN and  $\pi$ N pairs, we shall denote the latter by  $i$ ,  $j$  or  $k$ , so that  $i$  represents the pair  $\pi N_i$  with nucleons  $N_j$  and  $N_k$  as spectators ( $i, j, k$  a cyclic permutation of 1, 2, 3). Finally, the operators  $t_a$  are the NN or  $\pi$ N  $t$ -matrices. To be consistent with the explicit allowance of the  $\pi$ NN vertices, only the non-polar part has to be retained in the  $\pi$ -nucleon  $t$ -matrices  $t_i$  in the  $P_{11}$  channel [14]. For the sake of simplicity, we have omitted the dependence upon the energy variable  $z$  in the resolvent and transition operators. It will be exhibited only when necessary. For the same reason, the outgoing boundary conditions assumed on-shell for the operators are not explicitly indicated. Note that the operators which are obtained through Hermitean conjugation are associated to ingoing boundary conditions, so that one has  $U_b^\dagger \equiv U_b(E - i0)^\dagger$ , with  $E$  the total energy.

The physical meaning of the operators introduced through eqs. (2.1a–2.1d) can be ascertained by studying the behaviour of the  $4 \rightarrow 4$  amplitudes in momentum-space, near

the poles corresponding to the two-body bound states or resonances. As is well-known, the dominant part of  $t_a$  at the bound-state (or resonance) energy  $z = E_a$  can be written [21]

$$t_a \simeq |a\rangle \frac{1}{z - E_a} \langle a|, \quad (2.2)$$

where  $|a\rangle$  is the form factor for the correlated pair  $a$ ,

$$|a\rangle = V_a |\phi_a\rangle. \quad (2.3)$$

Here,  $V_a$  represents the two-body interaction in pair  $a$ , and  $|\phi_a\rangle$  satisfies the homogeneous equation

$$G_0(E_a)V_a|\phi_a\rangle = |\phi_a\rangle. \quad (2.4)$$

For  $z \sim E_a$  the production amplitude can then be written, because of Eq. (2.1b)

$$\langle \chi'_1 | T_{(1|0)}(z) | \chi_0 \rangle \simeq \langle \chi'_1 | V_a | \phi_a \rangle \frac{1}{z - E_a} \langle \phi_a | U_a | \chi_0 \rangle. \quad (2.5)$$

The residue of the amplitude at this simple pole provides (apart from the form factor  $\langle \chi'_1 | V_a | \phi_a \rangle$ ) the transition amplitude  $\langle \phi_a | U_a | \chi_0 \rangle$  referring to three-cluster  $\rightarrow$  three-cluster transitions from the NNN space to the  $\pi$ NNN sector. Similarly, one can establish that  $U_b^\dagger$  and  $U_{ab}$  are absorption and reaction operators, respectively, for transitions between three-cluster configurations of the  $\pi$ NNN-NNN system.

The dynamical equations for the AB operators have been derived in Ref. [14] for the  $\pi$ NN system, by resorting to Taylor's diagrammatic method [22,23], and have been extended to the  $\pi$ NNN case in refs. [15,16]. For the  $\pi$ NNN case these equations do not have a connected kernel, so that they may have unphysical solutions in addition to the correct (physical) one. In our previous papers [1,2] we have shown that Faddeev-Yakubovskii-type (FY) equations, and explicit allowance for two-cluster partitions can be obtained through a non-trivial generalization of the GS approach to the four-body problem [3,4]. To this end one writes the four-body AB equations in the matrix form

$$\mathbf{T}^{(3)} = \mathbf{V}^{(3)} + \mathbf{V}^{(3)} \mathbf{G}_0^{(3)} \mathbf{T}^{(3)}, \quad (2.6)$$

where  $\mathbf{G}_0^{(3)}$ ,  $\mathbf{V}^{(3)}$  and  $\mathbf{T}^{(3)}$  are matrices in the three-cluster-partition indices defined according to

$$\mathbf{G}_0^{(3)} \equiv \begin{vmatrix} G_0^{(3)}{}_{(a|b)} & G_0^{(3)}{}_{(a|0)} \\ G_0^{(3)}{}_{(0|b)} & G_0^{(3)}{}_{(0|0)} \end{vmatrix} = \begin{vmatrix} G_0 t_a G_0 \delta_{ab} & 0 \\ 0 & g_0 \end{vmatrix}, \quad (2.7)$$

$$\mathbf{V}^{(3)} \equiv \begin{vmatrix} V_{(a|b)}^{(3)} & V_{(a|0)}^{(3)} \\ V_{(0|b)}^{(3)} & V_{(0|0)}^{(3)} \end{vmatrix} = \begin{vmatrix} G_0^{-1} \bar{\delta}_{ab} & F_a \\ F_b^\dagger & \mathcal{V} \end{vmatrix}, \quad (2.8)$$

$$\mathbf{T}^{(3)} \equiv \begin{vmatrix} T_{(a|b)}^{(3)} & T_{(a|0)}^{(3)} \\ T_{(0|b)}^{(3)} & T_{(0|0)}^{(3)} \end{vmatrix} = \begin{vmatrix} U_{ab} & U_a \\ U_b^\dagger & U \end{vmatrix}, \quad (2.9)$$

respectively. The notation exhibits the fact that the diagonal blocks of these matrices refer to the  $\pi$ NNN and NNN spaces, whereas the off-diagonal blocks contain the operators

connecting the two sectors. Here,  $g_0$  is the free three–nucleon propagator, and  $\mathcal{V}$  represents the total interaction in the NNN sector with the one–pion–exchange contributions explicitly included;  $F_a$  ( $F_b^\dagger$ ) is the sum of the elementary production (absorption) vertices external to the pair  $a$  (see Eq. (1) in Ref. [1]), and  $\bar{\delta}_{ab} \equiv 1 - \delta_{ab}$ .

As in the standard GS approach, a crucial step in obtaining equations with a FY coupling scheme is represented by a sum rule, by which the matrix interaction  $\mathbf{V}^{(3)}$  is written as the sum of contributions  $\mathbf{v}_{a'}^{(3)}$  referring to the two–cluster partitions  $a'$  of the total system. This can be accomplished through a more refined classification of the two–cluster partitions, with respect to the usual four–body theory. If  $a'$  is the partition  $\pi(\text{NNN})$ , with the pion a mere spectator (Type–III partition), one essentially has the GS form [3,4]

$$\mathbf{v}_{a'}^{(3)} \equiv \begin{vmatrix} v_{a'}^{(3)}(a|b) & v_{a'}^{(3)}(a|0) \\ v_{a'}^{(3)}(0|b) & v_{a'}^{(3)}(0|0) \end{vmatrix} = \begin{vmatrix} G_0^{-1} \bar{\delta}_{ab} \delta_{a,b \subset a'} & 0 \\ 0 & 0 \end{vmatrix}, \quad (2.10a)$$

with  $\delta_{a,b \subset a'}$  equal to one if both  $a$  and  $b$  are obtained by breaking a cluster in  $a'$ , and zero otherwise. If, on the other hand,  $a'$  contains an interacting  $\pi\text{NN}$  system plus a spectator nucleon (Type–I partition) or two pairs  $\pi\text{N}$  and  $\text{NN}$  with no mutual interaction (Type–II partition) one has

$$\mathbf{v}_{a'}^{(3)} \equiv \begin{vmatrix} v_{a'}^{(3)}(a|b) & v_{a'}^{(3)}(a|0) \\ v_{a'}^{(3)}(0|b) & v_{a'}^{(3)}(0|0) \end{vmatrix} = \begin{vmatrix} G_0^{-1} \bar{\delta}_{ab} \delta_{a,b \subset a'} & (f_{a'})_a \\ (f_{a'}^\dagger)_b & \mathcal{V}_{a_1} \end{vmatrix}, \quad (2.10b)$$

and

$$\mathbf{v}_{a'}^{(3)} \equiv \begin{vmatrix} v_{a'}^{(3)}(a|b) & v_{a'}^{(3)}(a|0) \\ v_{a'}^{(3)}(0|b) & v_{a'}^{(3)}(0|0) \end{vmatrix} = \begin{vmatrix} G_0^{-1} \bar{\delta}_{ab} \delta_{a,b \subset a'} & (f_{a'})_a \\ (f_{a'}^\dagger)_b & 0 \end{vmatrix}, \quad (2.10c)$$

respectively. Here,  $(f_{a'})_a$  and  $(f_{a'}^\dagger)_b$  are emission and absorption vertices internal to  $a'$ ; they can be written in terms of the elementary production and absorption vertices for the  $i$ –th nucleon  $f(i)$  and  $f(i)^\dagger$ , respectively, as follows

$$(f_{a'})_a = \sum_{i=1}^3 \bar{\delta}_{ia} \delta_{i,a \subset a'} f(i) \quad (f_{a'}^\dagger)_b = \sum_{i=1}^3 \bar{\delta}_{ib} \delta_{i,b \subset a'} f(i)^\dagger. \quad (2.11)$$

The operator  $\mathcal{V}_{a_1}$  represents the interaction internal to the NN pair  $a_1$  in the considered partition  $a'$ , with the one–pion–exchange tail included [1,2]. We observe that  $a_1$  represents at the same time a two–cluster partition in the three–nucleon sector and a three–cluster partition in the four–body space. It is uniquely defined for each I– or II–type  $a'$ . It is worth to note that, had we defined  $\mathbf{v}_{a'}^{(3)}$  in the same way for Type–I and Type–II partitions, we would have counted the NN potentials  $\mathcal{V}_{a_1}$  twice when summing  $\mathbf{v}_{a'}^{(3)}$  over  $a'$ , to get the total “interaction”  $\mathbf{V}^{(3)}$ .

The operators  $\mathbf{v}_{a'}^{(3)}$  represent the driving terms of the equations for the sub–system dynamics. These equations can be written in the compact Lippmann–Schwinger form [1,2]

$$\mathbf{t}_{a'}^{(3)} = \mathbf{v}_{a'}^{(3)} + \mathbf{v}_{a'}^{(3)} \mathbf{G}_0^{(3)} \mathbf{t}_{a'}^{(3)}, \quad (2.12)$$

where  $\mathbf{t}_{a'}^{(3)}$  are matrices in the three-cluster-partition indices, whose definition depends again upon the type of two-cluster partition  $a'$ . For a Type-I or Type-II  $a'$  they are defined according to

$$\mathbf{t}_{a'}^{(3)} \equiv \begin{vmatrix} t_{a'(a|b)}^{(3)} & t_{a'(a|0)}^{(3)} \\ t_{a'(0|b)}^{(3)} & t_{a'(0|0)}^{(3)} \end{vmatrix} = \begin{vmatrix} (u_{a'})_{ab} & (u_{a'})_a \\ (u_{a'}^\dagger)_b & u_{a'} \end{vmatrix}, \quad (2.13a)$$

where  $(u_{a'})_{ab}$ ,  $(u_{a'})_a$ ,  $(u_{a'}^\dagger)_b$  and  $u_{a'}$  are AB-type transition operators describing scattering and absorption/emission processes within the sub-systems defined by  $a'$ . If, on the other hand, one has the Type-III partition  $a' = \pi(\text{NNN})$  one has the usual Alt-Grassberger-Sandhas (AGS) operators for the three-nucleon sub-system, namely

$$\mathbf{t}_{a'}^{(3)} \equiv \begin{vmatrix} t_{a'(a|b)}^{(3)} & t_{a'(a|0)}^{(3)} \\ t_{a'(0|b)}^{(3)} & t_{a'(0|0)}^{(3)} \end{vmatrix} = \begin{vmatrix} (u_{a'})_{ab} & 0 \\ 0 & 0 \end{vmatrix}. \quad (2.13b)$$

The FY-type equations for the full  $\pi\text{NNN}$  system can be derived from the four-body AB equations (2.6) by resorting to the basic ansatz

$$\mathbf{T}^{(3)} = \sum_{a'} \mathbf{t}_{a'}^{(3)} + \sum_{a'b'} \mathbf{t}_{a'}^{(3)} \mathbf{G}_0^{(3)} \mathbf{U}_{a'b'}^{(3)} \mathbf{G}_0^{(3)} \mathbf{t}_{b'}^{(3)}. \quad (2.14)$$

Requiring that  $\mathbf{T}^{(3)}$ , as given by (2.14), satisfies Eqs. (2.6) one gets

$$\mathbf{U}_{a'b'}^{(3)} = \bar{\delta}_{a'b'} \mathbf{G}_0^{(3)-1} + \sum_{c'} \bar{\delta}_{a'c'} \mathbf{t}_{c'}^{(3)} \mathbf{G}_0^{(3)} \mathbf{U}_{c'b'}^{(3)}. \quad (2.15)$$

These equations, once explicitly written, couple operators labelled by chains of partitions. Differently from the standard four-body case, however, now the coupling between spaces with different numbers of particles is allowed; as a consequence, one has standard chain indices  $(a'a)$  (with  $a \subset a'$ ) in the  $\pi\text{NNN}$  sector, and hybrid-chain indices  $(a'a_1)$  (with  $a_1 \subset a'$ ) to account for the three-nucleon space. The explicit form of Eqs. (2.15) has been given and discussed elsewhere [2]. Here, we limit ourselves to observe that they couple the following operators: operators  $U_{a'ab'b}$  associated to scattering in the  $\pi\text{NNN}$  space; operators  $U_{a'a_1b'b_1}$  for collision processes in the  $\text{NNN}$  sector; production and absorption operators  $U_{a'ab'b_1}$  and  $U_{a'a_1b'b}^\dagger$ , respectively, which connect the two spaces to each other.

In two previous papers [1,2], we have analyzed the connectedness properties of Eqs. (2.15). For all the graphs considered therein, we found that their kernel  $\mathbf{K}$  is connected after three iterations. A closer inspection, however, reveals a further class of graphs, whose presence prevents the present formalism from achieving connectedness. These graphs are related to self-energy insertions in Type-II partitions, by which a nucleon line is dressed in presence of an interacting NN pair [see Fig. 1(a)]. Because of these contributions, disconnected graphs appear in any iteration of  $\mathbf{K}$ , a typical disconnected term in  $\mathbf{K}^4$  being exhibited in Fig. 1(b). As already observed in ref. [15], in a properly mass-renormalized theory these contributions to the NN interactions would never arise, since the spectator nucleon would have already acquired its physical mass. In this truncated formalism, however, the FY coupling scheme implies that 2 + 2 partitions have to be treated on equal footing as the Type-I ones, and one is forced to introduce the above dangerous graphs.

On the ground of the above considerations, one has to conclude that the present approach, in spite of its striking similarities with the GS method, which has been so successful in the standard four-body case, is not able to solve the disconnectedness problem for the  $\pi$ NNN–NNN system. A natural question is whether one can extract from (2.15) sensible approximations, leading to connected–kernel equations. A first possibility is suggested by the very nature of the disconnected terms, namely, one can switch off the coupling between the  $\pi$ NNN and NNN sectors for the Type–II partitions, thereby allowing only multiple rescattering in the two–body sub–systems, much as in standard four–body theory. This implies that the sub–system dynamics is described by Eqs. (2.12), (2.10a) and (2.13b) not only for Type–III but also for Type–II partitions. Since hybrid chains are now introduced only for Type–I partitions, in this approximation Eqs. (2.15) represent a set of 21 coupled equations. Proceeding as in Ref. [2], one can verify that their kernel is connected after two iterations. This approximation, therefore, gives an embedding of the AB treatment for the  $\pi$ NN–NN sub–systems, into a four–body approach, where the remaining part of the problem is handled through a conventional multiple–scattering treatment.

A less severe truncation of the theory is possible, in which pion emission and absorption can be allowed in  $2 + 2$  partitions. To see how this can be achieved, we write Eqs. (2.12) for the scattering and absorption operators  $(u_{a'})_{ab}$  and  $(u_{a'}^\dagger)_b$ , with  $a'$  a Type-II partition  $(\pi i)(jk)$ ,

$$(u_{a'})_{ab} = G_0^{-1}\bar{\delta}_{ab} + \sum_c \bar{\delta}_{ac}t_c G_0(u_{a'})_{cb} + (f_{a'})_a g_0(u_{a'}^\dagger)_b \quad (2.16a)$$

$$(u_{a'}^\dagger)_b = (f_{a'}^\dagger)_b + \sum_c (f_{a'}^\dagger)_c G_0 t_c G_0(u_{a'})_{cb}. \quad (2.16b)$$

Substituting for  $(u_{a'}^\dagger)_b$  in the former of these equations from the latter, one gets

$$\begin{aligned} (u_{a'})_{ab} &= G_0^{-1}\bar{\delta}_{ab} + (f_{a'})_a g_0(f_{a'}^\dagger)_b + \sum_c \bar{\delta}_{ac}t_c G_0(u_{a'})_{cb} \\ &\quad + (f_{a'})_a g_0 \sum_c (f_{a'}^\dagger)_c G_0 t_c G_0(u_{a'})_{cb}. \end{aligned} \quad (2.17)$$

One now assumes again Eq. (2.13b) for Type–II partitions. In this approximation, emission/absorption processes contribute to all orders to the  $2 + 2$  sub–amplitudes in the  $\pi$ NNN sector, while their components for direct pion emission/absorption are set to zero. As a consequence, the intertwining between  $3 + 1$  and  $2 + 2$  partitions with zero–pion intermediate states is forbidden, and connectedness can be achieved again.

### III. THE TRANSITION AMPLITUDES

The physical transition amplitudes for the various collision processes allowed in the considered state space ( $\mathcal{H}_{\text{NNN}} \oplus \mathcal{H}_{\pi\text{NNN}}$ ) can be extracted from Eqs. (2.1) and (2.14) through a suitable generalization of the residue method. To exhibit the singularities of the relevant operators in correspondence to the possible bound (or resonant) states of the sub–systems, we consider the homogeneous eigenvalue problem associated to Eqs. (2.12), namely

$$|\Gamma_{a'}^{(3)}(E_{a'}) \rangle = \mathbf{v}_{a'}^{(3)}(E_{a'}) \mathbf{G}_0^{(3)}(E_{a'}) |\Gamma_{a'}^{(3)}(E_{a'}) \rangle. \quad (3.1)$$



For Type-I or Type-II partitions,  $|\Gamma_{a'}^{(3)}(E_{a'})\rangle$  is a column vector in the space of the three-cluster partitions of both sectors of the model state space. In particular, in the  $\pi$ NNN sector,  $|\Gamma_{a'}^{(3)}\rangle$  has non-vanishing components  $|\Gamma_{a'a}\rangle$  in those three-cluster partitions obtained from a sequential break-up of the two-cluster partition  $a'$ . For the Type-III partition, the column vector has non-vanishing components  $|\Gamma_{a'a}\rangle$  only in the  $\pi$ NNN sub-space. For the sake of simplicity, we have assumed that there is a unique eigenvalue for a given  $a'$ , the generalization to many eigenvalues  $E_{a'r}$  implying only a more involved bookkeeping of indices. If the state-vectors

$$|\Phi_{a'}^{(3)}(E_{a'})\rangle \equiv G_0^{(3)}(E_{a'})|\Gamma_{a'}^{(3)}(E_{a'})\rangle \quad (3.2)$$

are introduced, Eq. (3.1) becomes

$$|\Phi_{a'}^{(3)}(E_{a'})\rangle = G_0^{(3)}(E_{a'})\mathbf{v}_{a'}^{(3)}(E_{a'})|\Phi_{a'}^{(3)}(E_{a'})\rangle. \quad (3.3)$$

To have a first insight into the physical meaning of these equations, it is instructive to write Eq. (3.3) explicitly. For the Type-III partition, taking the Eqs. (2.7) and (2.10a) into account, one gets

$$|\Phi_{a'a}\rangle = G_0 t_a \sum_{c(\subset a')} \bar{\delta}_{ac} |\Phi_{a'c}\rangle, \quad (3.4)$$

namely, the standard Faddeev equations for the wave-function components  $|\Phi_{a'a}\rangle$  of the three-nucleon bound state in presence of the spectator pion. As is well-known, the total wave function is given by  $\sum_a |\Phi_{a'a}\rangle$ .

For the Type-I partitions one has from Eqs. (2.7) and (2.10b)

$$\begin{aligned} |\Phi_{a'a}\rangle &= G_0 t_a \sum_{c(\subset a')} \bar{\delta}_{ac} |\Phi_{a'c}\rangle + G_0 t_a G_0 (f_{a'})_a |\Phi_{a'a_1}\rangle, \\ |\Phi_{a'a_1}\rangle &= \sum_{c(\subset a')} g_0 (f_{a'}^\dagger)_c |\Phi_{a'c}\rangle + g_0 \mathcal{V}_{a_1} |\Phi_{a'a_1}\rangle. \end{aligned} \quad (3.5)$$

Because of the coupling between the  $\pi$ NNN and NNN sectors the wave function  $|\Phi_{a'}^{(3)}\rangle$  acquires an extra component  $|\Phi_{a'a_1}\rangle$ . One immediately sees that, if the coupling between the two spaces is switched off ( $(f_{a'})_a = (f_{a'}^\dagger)_a \equiv 0$ ) these equations reduce themselves to a pair of uncoupled equations, the former having the same form as (3.4), and describing a deuteron (D) as a  $\pi$ NN bound state (plus a spectator nucleon), the latter referring to a pair of nucleons bound by the two-body potential  $\mathcal{V}_{a_1}$ , in presence of a spectator nucleon in the NNN space. In presence of the  $\pi$ NN vertices, the total wave function becomes the superposition of the two components, since the deuteron can be viewed both as an NN bound-state, and as an NN system with a pion in flight between the two fermions. The states  $|\Gamma_{a'}^{(3)}(E_{a'})\rangle$  are then the form factors for the composite system in partition  $a'$ .

For  $a'$  belonging to the Type-II class, one gets equations quite similar to (3.5). The second term in the equation for the  $|\Phi_{a'a_1}\rangle$  component, however, is now missing (see Eq. (2.10c)). In analogy to the standard four-body case, this set describes an off-shell situation, with a correlated NN pair in presence of an interacting  $\pi$ N system. Since the corresponding form factor  $|\Gamma_{a'}^{(3)}\rangle$  can be most clearly interpreted in the quasi-particle

scheme, we defer its discussion to the next Section. Here, we limit ourselves to observe that Eqs. (3.1) or (3.3) contain the contributions due to the dangerous self-energy graphs leading to the disconnectedness problems outlined in the previous Section.

From the formal solution of the dynamical Eqs. (2.12), it follows that in momentum-space representation  $\mathbf{t}_{a'}^{(3)}(z)$  has a pole for  $z \sim E_{a'}$ . In operator notation we simply write

$$\mathbf{t}_{a'}^{(3)}(z) \simeq \frac{|\mathbf{\Gamma}_{a'}^{(3)} \rangle \langle \mathbf{\Gamma}_{a'}^{(3)}|}{z - E_{a'}}, \quad (3.6)$$

where  $\langle \mathbf{\Gamma}_{a'}^{(3)}|$  is a row vector, defined as the solution of

$$\langle \mathbf{\Gamma}_{a'}^{(3)}(E_{a'})| = \langle \mathbf{\Gamma}_{a'}^{(3)}(E_{a'})| \mathbf{G}_0^{(3)}(E_{a'}) \mathbf{v}_{a'}^{(3)}(E_{a'}).$$

Eq. (3.6) can be given an interpretation quite similar to the pole approximation for the sub-system amplitudes in standard few-body theory [3]. For Type-I and Type-III partitions the form factor  $\langle \mathbf{\Gamma}_{a'}^{(3)}|$  describes the formation of a bound (or resonant) three-body subsystem in partition  $a'$ ; the factor  $(z - E_{a'})^{-1}$  describes the propagation of this subsystem in presence of the spectator particle, whereas the form factor  $|\mathbf{\Gamma}_{a'}^{(3)} \rangle$  is associated to the virtual decay of the composite object. For Type-II partitions, on the other hand, one has the (virtual) formation, propagation and subsequent decay of two correlated pairs with no mutual interaction. Differently from the usual four-body problem, however, here the coupling between the NNN and  $\pi$ NNN sectors introduces an extra component for the form factors for Type-I and Type-II partitions. As already remarked, this extra component is present because the absorption and emission of the pion implies that the deuteron has to be regarded as a superposition of pure NN configurations and three-body  $\pi$ NN components (Type-I partitions), and the nucleon is allowed to emit and absorb the pion in presence of a correlated NN pair (Type-II partitions).

Once the singular behaviour of the sub-amplitudes  $\mathbf{t}_{a'}^{(3)}$  has been exhibited, the physical transition amplitudes for two-fragment  $\rightarrow$  two-fragment processes can be extracted from Eq. (2.14), by looking for the singular components of the operator  $\mathbf{T}^{(3)}$ . To be definite, we suppose that the initial configuration is represented by a pion impinging on a three-nucleon system, so that the corresponding two-cluster partition is  $b' = \pi(\text{NNN})$ . We look for the transition amplitude to the final configuration where nucleons  $N_j$  and  $N_k$  are bound in the deuteron, and the third nucleon  $N_i$  is free ( $a' = N_i(\pi N_j N_k)$ ) [24]. Using Eq. (3.6) in Eq. (2.14) we can exhibit the corresponding singular part of  $\mathbf{T}^{(3)}$  as follows

$$\mathbf{T}^{(3)} = |\mathbf{\Gamma}_{a'}^{(3)} \rangle \frac{\mathcal{T}_{a'b'}}{(z - E_{a'})(z - E_{b'})} \langle \mathbf{\Gamma}_{b'}^{(3)}| + \mathbf{T}^{(3)(\text{NP})}. \quad (3.7)$$

Here,  $\mathbf{T}^{(3)(\text{NP})}$  is the non-singular part of  $\mathbf{T}^{(3)}$ ,  $a' = N_i(\pi N_j N_k)$ ,  $b' = \pi(\text{NNN})$ , the form factors  $|\mathbf{\Gamma}_{a'}^{(3)} \rangle$  and  $\langle \mathbf{\Gamma}_{b'}^{(3)}|$  satisfy the equations

$$\begin{aligned} |\mathbf{\Gamma}_{a'a} \rangle &= \sum_{c(\subset a')} \bar{\delta}_{ac} t_c G_0 |\mathbf{\Gamma}_{a'c} \rangle + (f_{a'})_a g_0 |\mathbf{\Gamma}_{a'a_1} \rangle \\ |\mathbf{\Gamma}_{a'a_1} \rangle &= \sum_{c(\subset a')} (f_{a'}^\dagger)_c G_0 t_c G_0 |\mathbf{\Gamma}_{a'c} \rangle + \mathcal{V}_{a_1} g_0 |\mathbf{\Gamma}_{a'a_1} \rangle, \end{aligned} \quad (3.8)$$

and

$$\langle \Gamma_{b'b} | = \sum_{c(\subset b')} \langle \Gamma_{b'c} | G_0 t_c \bar{\delta}_{cb}, \quad (3.9)$$

respectively, and  $\mathcal{T}_{a'b'}$  is defined according to

$$\mathcal{T}_{a'b'} \equiv \langle \Phi_{a'}^{(3)} | \mathbf{U}_{a'b'}^{(3)} | \Phi_{b'}^{(3)} \rangle. \quad (3.10)$$

In conclusion, the two-cluster  $\rightarrow$  two-cluster transition amplitudes  $\mathcal{T}_{a'b'}$  have been obtained as the residue at the double pole on-shell (*i.e.* at  $z = E_{a'} = E_{b'}$ ) of the three-cluster  $\rightarrow$  three-cluster amplitudes given in Eq. (2.9).

The above analysis can be easily modified so as to extract the transition amplitude for the  $\pi + \text{T} \rightarrow \text{N} + \text{N} + \text{N}$  process. Using Eqs. (3.6) and (3.3) in Eq. (2.14), and extracting the residue corresponding to the pole at  $z = E_{b'}$  ( $b' = \pi(\text{NNN})$ ) one gets from  $\langle \chi'_0 | U_b^\dagger | \phi_b \rangle$  the following expression for the transition amplitude  $\mathcal{T}_{\text{NNN} \leftarrow \pi \text{T}}$

$$\begin{aligned} \mathcal{T}_{\text{NNN} \leftarrow \pi \text{T}} &= \\ &= \sum_{a'(\in \text{I,II})} \sum_b \left\{ \sum_a \langle \chi'_0 | (u_{a'}^\dagger)_a G_0 t_a G_0 U_{a'ab'b} | \Phi_{b'b} \rangle + \langle \chi'_0 | u_{a'} g_0 U_{a'a_1b'b}^\dagger | \Phi_{b'b} \rangle \right\}, \end{aligned} \quad (3.11)$$

where the sum over  $a'$  is restricted to Type-I and Type-II partitions only, and we have implicitly assumed  $a \subset a'$ . Thus, in close analogy to what is done in ordinary scattering theory, by picking up the appropriate singular part of the three-cluster  $\rightarrow$  three-cluster transition operators, we have identified the contribution corresponding, in configuration space, to an incoming wave with a pion and a bound three-nucleon system, plus a scattered wave with three free nucleons in the asymptotic region.

We also report the expressions for the partial- and total-break-up transition amplitudes. With a self-explanatory notation one can write

$$\begin{aligned} \mathcal{T}_{\pi \text{ND} \leftarrow \pi \text{T}} &= \sum_{a'} \sum_{c(\subset a')} \sum_b \langle \phi_a | (u_{a'})_{ac} G_0 t_c G_0 U_{a'cb'b} | \Phi_{b'b} \rangle \\ &+ \sum_{a'(\in \text{I,II})} \sum_b \langle \phi_a | (u_{a'})_a g_0 U_{a'a_1b'b}^\dagger | \Phi_{b'b} \rangle, \end{aligned} \quad (3.12)$$

where  $\langle \phi_a |$  is the three-cluster asymptotic state with a deuteron plus spectators nucleon and pion (see Eq. (2.4)), and

$$\begin{aligned} \mathcal{T}_{\pi \text{NNN} \leftarrow \pi \text{T}} &= \sum_{a'} \sum_a \sum_{c(\subset a')} \sum_b \langle \chi'_1 | t_a G_0 (u_{a'})_{ac} G_0 t_c G_0 U_{a'cb'b} | \Phi_{b'b} \rangle \\ &+ \sum_{a'(\in \text{I,II})} \sum_a \sum_b \langle \chi'_1 | t_a G_0 (u_{a'})_a g_0 U_{a'a_1b'b}^\dagger | \Phi_{b'b} \rangle. \end{aligned} \quad (3.13)$$

Here, obviously,  $b' = \pi(\text{NNN})$ , and  $a$  in Eq. (3.12) identifies the partition  $\pi \text{N}_i(\text{N}_j \text{N}_k)$ .

For the process  $\pi + \text{T} \rightarrow \text{N} + \text{D}$ , the identification of  $\mathcal{T}_{a'b'}$ , as given by Eq. (3.10), with the required transition amplitude  $\mathcal{T}_{\text{ND} \leftarrow \pi \text{T}}$  deserves some more comments. In the first place, it is worth to note that, since only states with at most one pion are explicitly taken into account, the triton and the deuteron are treated in a different way in the respective channels. The

former is described as a three–nucleon system bound by static NN forces because of the presence of the real pion (see Eqs. (3.4) or (3.9)), the latter as a superposition of NN and  $\pi$ NN configurations (see Eqs. (3.5) or (3.8)).

It may be instructive to write Eq. (3.10) explicitly. Recalling that  $|\Phi_{b'}^{(3)}\rangle$  has no hybrid–chain component for  $b'$  of Type–III, one gets

$$\mathcal{T}_{\text{ND}\leftarrow\pi\text{T}} = \sum_{ab} \langle \Phi_{a'a} | U_{a'ab'b} | \Phi_{b'b} \rangle + \sum_b \langle \Phi_{a'a_1} | U_{a'a_1b'b}^\dagger | \Phi_{b'b} \rangle. \quad (3.14)$$

The first term in this expression has the same form as the corresponding transition amplitude in the standard GS formulation of the four–body problem [4,25], the channel states and the transition operators satisfying now equations allowing for the coupling between the NNN and the  $\pi$ NNN spaces. The latter term explicitly takes into account the possible transition between the two spaces, when the pion is absorbed.

It is worth to observe that  $2 + 2$  self–energy graphs imply non–trivial difficulties also for the transition amplitudes. Indeed, in the present framework one has to distinguish between  $\text{N}(\pi\text{NN})$  and  $(\pi\text{N})(\text{NN})$  partitions. As we shall see in the next Section, this is consistent with a quasi–particle scheme, where the physical transition amplitudes are evaluated in terms of two– and three–body quasiparticles. Under the point of view of a full, renormalized field–theory of interacting pions and nucleons, however, Type–I and Type–II partitions have to concur to describe the same physical situation, a dressed nucleon with its physical mass, which asymptotically propagates in presence of a deuteron, bound by the exchange of pions between the constituent nucleons. To meet these physical requirements the interactions should be constrained so as to guarantee that the sub–system operators  $\mathbf{t}_{a'}^{(3)}$  have a pole at the same energy  $E_{a'}$  for both Type–I and Type–II partitions. For  $\pi + \text{T} \rightarrow \text{N} + \text{D}$  scattering Eq. (3.10) would be then replaced by

$$\mathcal{T}_{\text{ND}\leftarrow\pi\text{T}} = \sum_{a'(\in\text{I,II})} \langle \Phi_{a'}^{(3)} | \mathbf{U}_{a'b'}^{(3)} | \Phi_{b'}^{(3)} \rangle, \quad (3.15)$$

where (apart from anti–symmetrization) one has  $a' = \text{N}_i(\pi\text{N}_j\text{N}_k)$  and  $a' = (\pi\text{N}_i)(\text{N}_j\text{N}_k)$ . That such a description cannot emerge in a natural way from the present theory is a consequence of the truncation to states with at most one pion, which lies at the heart of this type of approaches. This difficulty, which is somewhat hidden in the  $\pi\text{NN}$ – $\text{NN}$  case (apart from the renormalization problem), shows up here owing to the more complex boundary conditions. If the coupling between the  $\pi\text{NNN}$  and  $\text{NNN}$  sectors is switched off for Type–II partitions, on the other hand, this ambiguity is removed; Eqs. (3.3) reduce to the usual AGS Eqs. (3.4) for two pairs of correlated particles, and one can distinguish between the physical, spectator nucleon in Type–I partitions, and the correlated  $\pi\text{N}$  pair in the Type–II ones. As a consequence, Eq. (3.10) yields now the correct transition amplitude without ambiguities. Thus, the same truncation which leads to a connected–kernel scheme, allows one to unambiguously identify the physical transition amplitudes for two–cluster  $\rightarrow$  two–cluster processes.

#### IV. THE QUASI–PARTICLE SCHEME

The quasi–particle approximation (QPA) has played a major role in the development of conventional few–body scattering theory [3,6]. This approach relies on the property that

both the two-body  $t$ -matrices and the sub-system amplitudes can be approximated to an arbitrary degree of accuracy by a sum of separable terms. A first application of the QPA to the two-body  $t$ -operators allows one to re-write the original four-body YGS equations as Faddeev-type equations for two elementary particles and a composite object. A second application of the QPA to the sub-system amplitudes reduces the dynamical equations to a set of effective Lippmann-Schwinger equations coupling the two-cluster  $\rightarrow$  two-cluster transition amplitudes. These equations, after partial-wave projection, involve one integration variable only. The break-up amplitudes can be then obtained from the  $2 \rightarrow 2$  amplitudes by quadrature. The QPA allows for a better insight into the physical content of Yakubovskii-type formalisms, at the same time alleviating the difficulties implied by the solution of the four-body scattering problem by brute force.

Here, we show that the QPA can be naturally extended to the present situation, where emission/absorption processes are allowed. We shall assume a separable (rank one) form for the two-body  $t$ -operators as well as for the sub-system amplitudes, the extension to the general (finite-rank) case being straightforward. Thus, we write

$$t_a(z) = |a\rangle \tau_a^{(3)}(z) \langle a|, \quad (4.1)$$

with  $|a\rangle = V_a |\phi_a\rangle$  and  $\tau_a^{(3)}(z) \sim 1/(z - E_a)$  for  $z \simeq E_a$ . The actual form of  $\tau_a^{(3)}$  depends on the particular separable-expansion method employed. However, all the reasonable expansion methods must reproduce the bound-state pole behaviour of Eq. (2.2) [26]. Then, the dynamical equations (2.12) for the sub-system amplitudes can be re-written as

$$\mathbf{X}_{a'}^{(3)} = \mathbf{Z}_{a'}^{(3)} + \mathbf{Z}_{a'}^{(3)} \mathbf{D}^{(3)} \mathbf{X}_{a'}^{(3)}, \quad (4.2)$$

where  $\mathbf{D}^{(3)}$ ,  $\mathbf{Z}_{a'}^{(3)}$ , and  $\mathbf{X}_{a'}^{(3)}$  are again matrices in the three-cluster-partition indices, having a block structure quite similar to  $\mathbf{G}_0^{(3)}$ ,  $\mathbf{v}_{a'}^{(3)}$  and  $\mathbf{t}_{a'}^{(3)}$ . Thus, one has

$$\mathbf{D}^{(3)} \equiv \begin{vmatrix} D^{(3)}_{(a|b)} & D^{(3)}_{(a|0)} \\ D^{(3)}_{(0|b)} & D^{(3)}_{(0|0)} \end{vmatrix} = \begin{vmatrix} \tau_a^{(3)} \delta_{ab} & 0 \\ 0 & g_0 \end{vmatrix}. \quad (4.3a)$$

Similarly, for Type-I partitions,  $\mathbf{Z}_{a'}^{(3)}$  and  $\mathbf{X}_{a'}^{(3)}$  are defined according to

$$\mathbf{Z}_{a'}^{(3)} \equiv \begin{vmatrix} Z_{a'}^{(3)}_{(a|b)} & Z_{a'}^{(3)}_{(a|0)} \\ Z_{a'}^{(3)}_{(0|b)} & Z_{a'}^{(3)}_{(0|0)} \end{vmatrix} = \begin{vmatrix} \langle a|G_0|b\rangle \bar{\delta}_{ab} \delta_{a,b \subset a'} & \langle a|G_0(f_{a'})_a \\ (f_{a'}^\dagger)_b G_0|b\rangle & \mathcal{V}_{a_1} \end{vmatrix}, \quad (4.3b)$$

$$\mathbf{X}_{a'}^{(3)} \equiv \begin{vmatrix} X_{a'}^{(3)}_{(a|b)} & X_{a'}^{(3)}_{(a|0)} \\ X_{a'}^{(3)}_{(0|b)} & X_{a'}^{(3)}_{(0|0)} \end{vmatrix} = \begin{vmatrix} \langle a|G_0(u_{a'})_{ab} G_0|b\rangle & \langle a|G_0(u_{a'})_a \\ (u_{a'}^\dagger)_b G_0|b\rangle & u_{a'} \end{vmatrix}. \quad (4.3c)$$

For  $a'$  of Type-II one has similar definitions, with the element  $Z_{a'}^{(3)}_{(0|0)}$  missing, whereas, for the Type-III partition  $\pi(\text{NNN})$ , only the upper left blocks survive, thereby reproducing the definition of standard four-body theory.

The meaning of the present notation is worth of some comment. As in the four-body GS approach, in  $\langle a|G_0|b\rangle$  an integration has been performed over the relative momenta of the correlated pairs described by the form factors  $\langle a|$  and  $|b\rangle$ , so that this quantity is still an operator with respect to the remaining spectator momenta. In momentum-space

representation and for Type-I and Type-III partitions  $Z_{a'|b}^{(3)}$  describes the virtual decay of the correlated pair  $b$  and the formation of a correlated pair  $a$ , with the intermediate exchange of a particle between the two fragments. These  $Z$ -terms play therefore the role of intercluster interactions, originated from the exchange of a particle. For Type-II partitions one has the virtual decay of  $b$  and the subsequent formation of  $a$ , with intermediate four-body propagation.

Let's now consider  $\langle a|G_0(f_{a'})_a$ . In this case we integrate over the relative momentum of pair  $a$  in the  $\pi$ NNN sector only; such a quantity describes a transition from the NNN space to the  $\pi$ NNN space, with formation of a correlated pair  $a$ , describing either a bound deuteron or a resonant  $\pi$ N system. A graphical interpretation of  $\langle a|G_0(f_{a'})_a$  is given in Fig. 2. Similar considerations apply to  $\langle a|G_0(u_{a'})_a$  and  $(u_{a'}^\dagger)_b G_0|b\rangle$  ( $b \subset a'$ ). In summary, we are consistently applying the GS recipe in the four-body sector, the NNN space remaining untouched, so as to get operators in two vector variables in both sectors.

From the Eqs. (2.15) the set of equations

$$Y_{a'b'}^{(3)} = \bar{\delta}_{a'b'} D^{(3)-1} + \sum_{c'} \bar{\delta}_{a'c'} X_{c'}^{(3)} D^{(3)} Y_{c'b'}^{(3)}, \quad (4.4)$$

can be derived, where

$$Y_{a'b'}^{(3)} \equiv \begin{vmatrix} Y_{a'ab'b}^{(3)} & Y_{a'ab'b_1}^{(3)} \\ Y_{a'a_1b'b}^{(3)} & Y_{a'a_1b'b_1}^{(3)} \end{vmatrix} = \begin{vmatrix} \langle a|G_0 U_{a'ab'b} G_0|b\rangle & \langle a|G_0 U_{a'ab'b_1} \\ U_{a'a_1b'b}^\dagger G_0|b\rangle & U_{a'a_1b'b_1} \end{vmatrix}. \quad (4.5)$$

To introduce separable approximations for the sub-system amplitudes we observe that the homogeneous equations (3.3) become, when the two-body t-matrices are approximated by Eq. (4.1),

$$|\tilde{\Phi}_{a'}^{(3)}(E_{a'})\rangle = D^{(3)}(E_{a'}) Z_{a'}^{(3)}(E_{a'}) |\tilde{\Phi}_{a'}^{(3)}(E_{a'})\rangle, \quad (4.6)$$

with  $|\tilde{\Phi}_{a'}^{(3)}(E_{a'})\rangle$  a column vector, whose components are related to the components of  $|\Phi_{a'}^{(3)}(E_{a'})\rangle$  by the remarkable factorization relation

$$|\Phi_{a'a}\rangle = G_0|a\rangle |\tilde{\Phi}_{a'a}\rangle, \quad |\Phi_{a'a_1}\rangle \equiv |\tilde{\Phi}_{a'a_1}\rangle. \quad (4.7)$$

Needless to say, the NNN-components of these vectors are missing for the Type-III partition. The form-factors  $|\Gamma_{a'}^{(3)}\rangle$  are now replaced by the vectors  $|\tilde{\Gamma}_{a'}^{(3)}\rangle = Z_{a'}^{(3)} |\tilde{\Phi}_{a'}^{(3)}\rangle$  satisfying the analogue of Eqs. (3.1)

$$|\tilde{\Gamma}_{a'}^{(3)}(E_{a'})\rangle = Z_{a'}^{(3)}(E_{a'}) D^{(3)}(E_{a'}) |\tilde{\Gamma}_{a'}^{(3)}(E_{a'})\rangle. \quad (4.8)$$

The physical meaning of the ‘‘form factors’’  $|\tilde{\Gamma}_{a'}^{(3)}\rangle$  is the following. For  $a' = \pi$ (NNN),  $|\tilde{\Gamma}_{a'a}\rangle$  describes the virtual decay of the three-nucleon bound state into the correlated pair  $a$  plus a nucleon, in presence of the spectator pion. For the Type-III partition, therefore, the three components  $|\tilde{\Gamma}_{a'a}\rangle$  retain the same meaning as in the standard four-body problem [3], and satisfy the homogeneous Faddeev-type equations

$$|\tilde{\Gamma}_{a'a}\rangle = \sum_{c(\subset a')} \bar{\delta}_{ac} \langle a|G_0|c\rangle \tau_c^{(3)} |\tilde{\Gamma}_{a'c}\rangle. \quad (4.9)$$

For Type-I partitions, the form factors  $|\tilde{\Gamma}_{a'}^{(3)}\rangle$  acquire an extra component  $|\tilde{\Gamma}_{a'a_1}\rangle$  in the three-nucleon sector. Again this is due to the presence of the  $\pi$ NN vertex functions; whereas  $|\tilde{\Gamma}_{a'a}\rangle$  represent the virtual decay of the deuteron as a  $\pi$ NN bound state into a correlated (NN) or ( $\pi$ N) pair plus a free particle,  $|\tilde{\Gamma}_{a'a_1}\rangle$  describes the decay of the deuteron into a pair of nucleons, through internal absorption of the pion. The four components of  $|\tilde{\Gamma}_{a'}^{(3)}\rangle$  are coupled by the Eqs. (4.8), which explicitly written give

$$\begin{aligned} |\tilde{\Gamma}_{a'a}\rangle &= \sum_{c(\subset a')} \bar{\delta}_{ac} \langle a|G_0|c\rangle \tau_c^{(3)} |\tilde{\Gamma}_{a'c}\rangle + \langle a|G_0(f_{a'})_a g_0 |\tilde{\Gamma}_{a'a_1}\rangle \\ |\tilde{\Gamma}_{a'a_1}\rangle &= \sum_{c(\subset a')} (f_{a'}^\dagger)_c G_0 |c\rangle \tau_c^{(3)} |\tilde{\Gamma}_{a'c}\rangle + \mathcal{V}_{a_1} g_0 |\tilde{\Gamma}_{a'a_1}\rangle. \end{aligned} \quad (4.10)$$

These equations are graphically illustrated in Fig. 3. Finally, the form-factor components  $|\tilde{\Gamma}_{a'a}\rangle$  corresponding to Type-II partitions describe in the  $\pi$ NNN sector off-shell situations in which a deuteron or a correlated  $\pi$ N pair decays in presence of another correlated pair. The “absorption” component  $|\tilde{\Gamma}_{a'a_1}\rangle$ , on the other hand, is associated to a deuteron which decays while a ( $\pi$ N) quasi-particle undergoes an (off-shell) ( $\pi$ N)  $\rightarrow$ N transition. These form factors and their coupling through Eqs. (4.8) are graphically depicted in Fig. 4.

Consistently with the discussion of the residue method given in Section III, we finally assume for  $\mathbf{X}_{a'}^{(3)}$  the separable representation

$$\mathbf{X}_{a'}^{(3)} = |\tilde{\Gamma}_{a'}^{(3)}\rangle \tau_{a'}^{(2)} \langle \tilde{\Gamma}_{a'}^{(3)}|, \quad (4.11)$$

with  $\tau_{a'}^{(2)} \simeq 1/(z - E_{a'})$  for  $z \sim E_{a'}$ , and the row vector  $\langle \tilde{\Gamma}_{a'}^{(3)}|$  eigensolution of  $\langle \tilde{\Gamma}_{a'}^{(3)}| = \langle \tilde{\Gamma}_{a'}^{(3)}| \mathbf{D}^{(3)} \mathbf{Z}_{a'}^{(3)}$ .

Inserting (4.11) into the Eqs. (4.4), and evaluating the resulting equations between  $\langle \tilde{\Gamma}_{a'}^{(3)}| \mathbf{D}^{(3)}$  on the left and  $\mathbf{D}^{(3)} |\tilde{\Gamma}_{b'}^{(3)}\rangle$  on the right one gets

$$\mathcal{T}_{a'b'} = \bar{\delta}_{a'b'} \langle \tilde{\Gamma}_{a'}^{(3)}| \mathbf{D}^{(3)} |\tilde{\Gamma}_{b'}^{(3)}\rangle + \sum_{c'} \bar{\delta}_{a'c'} \langle \tilde{\Gamma}_{a'}^{(3)}| \mathbf{D}^{(3)} |\tilde{\Gamma}_{c'}^{(3)}\rangle \tau_{c'}^{(2)} \mathcal{T}_{c'b'}, \quad (4.12)$$

where use has been made of the relation between the form factors  $|\tilde{\Gamma}_{a'}^{(3)}\rangle$  and the “channel states”  $|\tilde{\Phi}_{a'}^{(3)}\rangle$ , and we have now defined  $\mathcal{T}_{a'b'}$  according to

$$\mathcal{T}_{a'b'} \equiv \langle \tilde{\Phi}_{a'}^{(3)}| \mathbf{Y}_{a'b'}^{(3)} |\tilde{\Phi}_{b'}^{(3)}\rangle. \quad (4.13)$$

That Eq. (4.13) actually gives (on shell) the 2-cluster  $\rightarrow$  2-cluster transition amplitudes in the separable approximation can be easily ascertained starting from Eq. (3.10), and using the factorization property (4.7) and Eq. (4.5). Much as in the standard four-body problem, we have been able to obtain one-vector-variable integral equations coupling all the 2  $\rightarrow$  2 transition amplitudes one has for a given initial configuration. By means of an obvious matrix notation in the two-cluster-partition indices Eq. (4.12) can be re-written as an effective multi-channel LS equation:

$$\mathbf{X}^{(2)} = \mathbf{Z}^{(2)} + \mathbf{Z}^{(2)} \mathbf{D}^{(2)} \mathbf{X}^{(2)}, \quad (4.14)$$

where

$$X_{a'b'}^{(2)} \equiv \mathcal{T}_{a'b'}, \quad (4.15a)$$

$$Z_{a'b'}^{(2)} \equiv \bar{\delta}_{a'b'} \langle \tilde{\Gamma}_{a'}^{(3)} | D^{(3)} | \tilde{\Gamma}_{b'}^{(3)} \rangle, \quad (4.15b)$$

$$D_{a'b'}^{(2)} \equiv \tau_{a'}^{(2)} \delta_{a'b'}. \quad (4.15c)$$

As is typical of the quasi-particle approach, the operator  $\tau_{a'}^{(2)}$  plays the role of an effective propagator; for Type-I partitions it describes a deuteron (regarded as a coupled NN- $\pi$ NN system) in presence of a spectator nucleon; for Type-II partitions it is associated to a deuteron (as a bound NN system) propagating in presence of a  $\pi$ NN correlated pair; for the Type-III partition it simply describes the NNN bound state and the non-interacting pion in the two-cluster intermediate state. The driving terms  $Z_{a'b'}^{(2)}$  represent exchange “potentials” associated to the simplest reaction mechanisms through which one can pass from the initial configuration  $b'$  to the final one  $a'$ . Owing to the  $\pi$ NN vertices, they contain further contributions with respect to standard four-body theory. This can be immediately seen by writing them explicitly as

$$Z_{a'b'}^{(2)} = \bar{\delta}_{a'b'} \left\{ \sum_{c(\subset a', b')} \langle \tilde{\Gamma}_{a'c} | \tau_c^{(3)} | \tilde{\Gamma}_{b'c} \rangle + \langle \tilde{\Gamma}_{a'a_1} | g_0 | \tilde{\Gamma}_{b'b_1} \rangle \right\}, \quad (4.16)$$

where it is assumed that the latter term on the right-hand-side is missing if either  $a'$  or  $b'$  is the Type-III partition. In particular, in standard four-body theory the driving term  $Z_{a'b'}^{(2)}$  is missing when both  $a'$  and  $b'$  are of Type II, since in such a case no three-cluster partition  $c$  can be simultaneously contained in both  $a'$  and  $b'$  (with  $a' \neq b'$ ). Here, this driving term survives, due to the presence of the latter term in Eq. (4.16). Some typical driving terms are graphically illustrated in Fig. 5.

Let us focus our attention on Fig. 5(d). It describes one of the lowest-order contributions to the transition  $(\pi N) + (NN) \rightarrow N + (NN\pi)$ , and consists of two graphs, corresponding to the former and the latter term on the right of Eq. (4.16), respectively. The graph associated to intermediate three-nucleon propagation is clearly disconnected. This is at variance with standard four-body theory, where all the driving terms are connected after the repeated application of the QPA, and reflects the presence of the disconnected terms in the kernel of the exact Eqs. (2.15) we have already pointed out in Section II. One can easily convince oneself that the disconnected contributions due to the graph of Fig. 5(d) survive after any number of iterations of the effective LS Eqs. (4.14). The above disconnected graph can be exhibited as self-energy insertions in Type-II partitions by substituting the Eq. (4.8) (or an iteration of the same equation) into the expression (4.15b) for the driving terms. Due to the employment of the QPA, all the disconnected terms in the present formalism appear now lumped together in a unique contribution, describing transitions from a Type-II to a Type-I partition, having an NN pair in common. Clearly, if this term is disregarded, one has the minimal truncation able to give connected-kernel equations for the  $2 \rightarrow 2$  transition amplitudes. If, on the other hand, one switches off completely the coupling between the  $\pi$ NNN and NNN sectors in Type-II partitions, the Eqs. (4.8) for the  $2 + 2$  quasi-particle form factors reduce to the usual AGS homogeneous equations (4.9). These are graphically



depicted in Fig. 4, where the boxes enclose the terms which are absent in this approximation. The effective LS equations (4.14) remain formally unchanged, but now in 2+2 intermediate states one has the propagation of a ( $\pi$ N) “cluster”, with no ( $\pi$ N) $\rightarrow$ N transition. Correspondingly, in the driving terms the contributions enclosed in boxes in Fig. 5 vanish; in particular, the 2 $\rightarrow$ 2 graph is now absent, much as in standard four-body theory.

Finally, let us briefly describe how the above considerations have to be modified, if  $\pi$  absorption/emission is taken into account in the scattering amplitudes for 2+2 sub-systems, as described by Eqs. (2.17). The quasi-particle representation for these equations still has an LS-type structure

$$\mathbf{X}_{a'}^{(3)} = \mathbf{Z}_{a'}^{(3)} + \mathbf{Z}_{a'}^{(3)} \mathbf{D}^{(3)} \mathbf{X}_{a'}^{(3)}, \quad (4.17)$$

where  $\mathbf{D}^{(3)}$  and  $\mathbf{X}_{a'}^{(3)}$  can be identified with  $D_{(a|b)}^{(3)} = \tau_a^{(3)} \delta_{ab}$  and  $X_{a' (a|b)}^{(3)} = \langle a | G_0(u_{a'})_{ab} G_0 | b \rangle$ , respectively, and the  $\mathbf{Z}$ -term  $\mathbf{Z}_{a'}^{(3)}$  contains two terms, the former being  $\langle a | G_0 | b \rangle \bar{\delta}_{ab} \delta_{a,b \subset a'}$ , the latter, given by  $\langle a | G_0(f_{a'})_a g_0(f_{a'}^\dagger)_b G_0 | b \rangle$ , containing the effects of  $\pi$  emission/absorption in the scattering channel. This contribution is graphically depicted in Fig. 6.

To conclude this Section, we give the physical transition amplitudes for absorption/emission and break-up processes in terms of the quasi-particle amplitudes  $\mathcal{T}_{a'b'}$ . Inserting (4.11) into Eq. (3.11) and using (4.13) one has for the  $\pi + T \rightarrow \text{NNN}$  process

$$\mathcal{T}_{\text{NNN} \leftarrow \pi T} = \sum_{a'} \langle \chi'_0 | \tilde{\Gamma}_{a'a_1} \rangle \tau_{a'}^{(2)} \mathcal{T}_{a'b'}, \quad (4.18)$$

with  $b' = \pi(\text{NNN})$ . This result is what one could reasonably expect in the framework of an isobar model; the absorption amplitude with three free outgoing nucleons is given as the sum over all possible transitions to two-body intermediate states, followed by the decay of the composite clusters or virtual ( $\pi$ N)  $\rightarrow$  N conversion. This is graphically shown in Fig. 7. Similarly, one has for the break-up transition amplitudes

$$\mathcal{T}_{\pi \text{ND} \leftarrow \pi T} = \sum_{a'(\supset a)} \langle \phi_a | \tilde{\Gamma}_{a'a} \rangle \tau_{a'}^{(2)} \mathcal{T}_{a'b'} \quad (a \equiv \pi ND), \quad (4.19)$$

$$\mathcal{T}_{\pi \text{NNN} \leftarrow \pi T} = \sum_{a'a} \langle \chi'_1 | a \rangle \tau_a^{(3)} \langle \phi_a | \tilde{\Gamma}_{a'a} \rangle \tau_{a'}^{(2)} \mathcal{T}_{a'b'}. \quad (4.20)$$

## V. CONCLUSIONS AND COMPARISON WITH PREVIOUS APPROACHES

In this paper we have revisited the approach to the  $\pi$ NNN–NNN problem presented in Refs. [1,2]. This formalism can be regarded as the most natural generalization of the GS method, to a situation with a variable number of particles. We have shown that the physical transition amplitudes can be related to the chain-of-partition labelled operators of the formalism *via* the residue method, and that the quasi-particle technique can be generalized, so as to get multichannel LS equations coupling all the relevant 2 $\rightarrow$ 2 transition amplitudes. We have seen, however, that, in spite of its attractive features, the present approach fails in producing connected-kernel equations. This is due to off-shell self-energy

graphs, where nucleon dressing occurs in presence of an interacting NN pair. These disconnected graphs contribute to one single term in the kernel of the effective LS equations for the transition amplitudes. If this term is neglected, one is left with well-behaved equations, at the price of sacrificing exact unitarity. A more severe truncation consists in switching off the absorption/emission vertices in 2+2 partitions, while keeping the effects of pion emission/absorption in the  $\pi$ NNN sub-system. At this point, a comparison with the treatment of the  $\pi$ NNN–NNN problem proposed in Ref. [15] is suitable. There, one assumes the separable approximation (4.1) for the two-body t-operators from the beginning, and applies the quasi-particle method directly to the AB Eqs. (2.6). By the same procedure which led us to Eqs. (4.2) one gets

$$\mathbf{X}^{(3)} = \mathbf{Z}^{(3)} + \mathbf{Z}^{(3)}\mathbf{D}^{(3)}\mathbf{X}^{(3)}, \quad (5.1)$$

with  $\mathbf{D}^{(3)}$  given by Eq. (4.3a), and

$$\mathbf{Z}^{(3)} \equiv \begin{vmatrix} \langle a|G_0|b \rangle & \bar{\delta}_{ab} & \langle a|G_0F_a \rangle \\ F_b^\dagger G_0|b \rangle & & \mathcal{V} \end{vmatrix} \equiv \begin{vmatrix} \mathbf{V} & \mathbf{q} \\ \mathbf{p} & \mathcal{V} \end{vmatrix}, \quad (5.2)$$

$$\mathbf{X}^{(3)} \equiv \begin{vmatrix} \langle a|G_0U_{ab}G_0|b \rangle & \langle a|G_0U_a \rangle \\ U_b^\dagger G_0|b \rangle & U \end{vmatrix}. \quad (5.3)$$

Here, according to the notation of Ref. [15],  $\mathbf{V}$ ,  $\mathbf{p}$ , and  $\mathbf{q}$  are a square matrix, a row- and a column-vector, respectively, in the three-cluster partition indices. Notice that, owing to the sum rules [1,2]

$$F_a = \sum_{a'(\in\text{I,II})} (f_{a'})_a \quad F_a^\dagger = \sum_{a'(\in\text{I,II})} (f_{a'}^\dagger)_a, \quad (5.4)$$

one can immediately decompose  $\mathbf{q}$  and  $\mathbf{p}$  into terms of well-defined clustering nature,

$$\mathbf{q} = \sum_{a'(\in\text{I,II})} \mathbf{q}_{a'} \quad \mathbf{p} = \sum_{a'(\in\text{I,II})} \mathbf{p}_{a'}. \quad (5.5)$$

The integral Eqs. (5.1) are transformed into a set of equivalent Schrödinger equations, coupling the  $\pi$ NNN and NNN sectors, and the usual GS approach is employed first, by decomposing  $\mathbf{V}$  into terms labelled by two-cluster partitions, so as to remove the disconnected terms one has in the standard four-body problem. The transition operators for the various channels of the  $\pi$ NNN–NNN system are then identified, and corresponding sets of integral equations are derived. The kernel of these equations still contains, through the coupling operators  $\mathbf{q}$  and  $\mathbf{p}$ , all the disconnected contributions due to emission/absorption processes. These disconnected pieces are identified, in virtue of the decompositions (5.5), and removed by formal use of the two-potential formula. As a consequence, the physical transition operators are given by the solution of rather complicate sets of nested integral equations. This procedure implies also that the transition operators for emission/absorption processes have to be defined with reference to incomplete NN interactions in the NNN space, taking account of the coupling to the  $\pi$ NNN sector only to low order (see Eqs. (4.16b), (4.16c) and

(4.17a) in Ref. [15]). Only the exact employment of the two-potential formula can introduce the missing part of the NN interactions, and provide at the end the physical transition amplitudes.

Coupled equations formally similar to the LS Eqs. (4.14) represent the starting point of the relativistic, coupled-channel approach of Ref. [20]. There, however, the four-body dynamics never comes explicitly into play; rather, the various three-cluster partitions for the  $\pi$ NNN-NNN system are regarded as different three-body problems, and the corresponding two-cluster partitions as different channels of the same effective, coupled-channel problem. Thus, regarding nucleons as distinguishable, one has nine different channels  $(N_i D_{jk})\pi$ ,  $(\pi D_{jk})N_i$ , and  $(\pi N_i)D_{jk}$  ( $i, j, k$  a cyclic permutation of 1, 2, 3). Similarly, one has nine channels for the  $\pi N\Delta$  systems, plus six possible channels in the NNN space. Overall, one has to deal with 24 different channels, which are coupled through driving terms  $Z_{\alpha\beta}$ , describing standard AGS exchange graphs. The various three-cluster systems are moreover coupled because the inter-cluster interactions are regarded as effective coupled-channel potentials; for instance, the  $\pi D_{23}-N_2\Delta-N_3\Delta-N_2N_3$  systems are described through a four-channel interaction. Assuming a finite-rank form for these potentials, one has effective two-body propagators in the assumed dynamical equations. Since the Blankenbecler-Sugar [27] and Aaron-Amado-Young [28] propagators are used for the two- and three-body sub-systems, unitarity is satisfied up to the three-body level. Clearly, owing to the above features, this formalism cannot be founded on rigorous, FY-type approaches; in particular, it implies a direct coupling between the (ND) $\pi$  configuration (*i. e.* the Type-III partition) in the  $\pi$ NNN space, and the ND system in the NNN sector, whereas, according to microscopic four-body approaches, absorption has to be excluded in the partition where the  $\pi$  has a passive role in the sub-system dynamics [1,2,15].

In conclusion, to the best of our knowledge, the coupled  $\pi$ NNN-NNN problem has not found up to now a fully satisfactory solution. The GS approach introduced in [1,2] can provide connected-kernel equations only when a class of disconnected graphs with self-energy insertions is excluded, thereby violating unitarity. These disconnected contributions can be removed through the two-potential formulation of Ref. [15]; the physical transition amplitudes, however, can be evaluated only through the solution of cumbersome sets of nested integral equations. The effective, coupled-channel method of Ref. [20], while allowing actual computations of  $\pi$ NNN-NNN processes, relies on several *ad hoc* assumptions, and cannot be directly connected to what is suggested by rigorous FY-type analyses.

## REFERENCES

- [1] L. Canton and G. Cattapan, *Phys. Rev. C* **50**, 2761 (1994)
- [2] G. Cattapan and L. Canton, *Few-Body Syst.* **17**, 163 (1994)
- [3] P. Grassberger and W. Sandhas, *Nucl. Phys. B* **2**, 181 (1967)
- [4] W. Sandhas, In *Few-Particle Problems in Nuclear Physics*, p. 151. Dubna:JINR 1980
- [5] O. A. Yakubovskii, *Sov. J. Nucl. Phys.* **5**, 937 (1967)
- [6] S.K. Adhikari and K.L. Kowalski, *Dynamical Collision Theory and Its Applications* (Academic Press, San Diego, 1991)
- [7] P.U. Sauer, M.Sawicki, and S. Furui, *Prog. Theor. Phys.* **74**, 1290 (1985)
- [8] B. Blankleider, *Nucl. Phys. A* **543**, 163c (1992)
- [9] A.N. Kvinikhidze and B. Blankleider, *Phys. Rev. C* **48**, 25 (1993); *Phys. Lett. B* **307**, 7 (1993)
- [10] B. Blankleider and A.N. Kvinikhidze, *Few-Body Sys. Suppl.* **7**, 294 (1994)
- [11] A.N. Kvinikhidze and B. Blankleider, *Nucl. Phys. A* **574**, 788 (1994)
- [12] D. R. Phillips and I.R. Afnan, *Ann. Phys. (NY)* **240**, 266 (1995)
- [13] D. R. Phillips and I.R. Afnan, *Ann. Phys. (NY)* **247**, 19 (1996)
- [14] I.R. Afnan and B. Blankleider, *Phys. Rev. C* **22**, 1638 (1980); **32**, 2006 (1985)
- [15] Y. Avishai and T. Mizutani, *Nucl. Phys. A* **393**, 429 (1983)
- [16] G. Cattapan, L. Canton, and J.P. Svenne, *Nuovo Cimento A* **106**, 1229 (1993)
- [17] L. D. Faddeev, *Mathematical Aspects of the Three-Body Problem in the Quantum Scattering Theory* (Israel Program for Scientific Translations, Jerusalem, 1965)
- [18] L. Rosenberg, *Phys. Rev.* **140**, B217 (1965)
- [19] C. Itzykson and J.B. Zuber, *Quantum Field Theory*, (McGraw-Hill, Singapore, 1985)
- [20] T. Ueda, *Nucl. Phys. A* **505**, 610 (1989)
- [21] To be rigorous, one ought to introduce integrations over the momenta of the spectator particles in eq. (2.2). Since these integrations are removed when considering the momentum-space matrix elements of the relevant transition operators, to save on notation here and in the following we shall live such integrations implicit.
- [22] J. G. Taylor, *Nuovo Cim. Suppl.* **1**, 857 (1963); *Phys. Rev.* **150**, 1321 (1966)
- [23] M. M. Broido, *Rep. Prog. Phys.* **32**, 493 (1969)
- [24] Strictly speaking, because of the identity of the nucleons, one has a unique transition amplitude for the process  $\pi + T \rightarrow N + D$ . As usual in scattering theory, for the moment we assume the nucleons as distinguishable, so that the configurations  $(\pi N_j N_k)$  and  $(\pi N_i N_k)$  are regarded as different from each other. The prescriptions due to particle identity can be taken into account at the end, through suitable linear combinations of the transition amplitudes. However, to save on notation, we shall simply write D in place of  $(N_i N_k)$  in the transition amplitudes.
- [25] G. Cattapan and V. Vanzani, *Nuovo Cimento A* **81**, 447 (1984)
- [26] L. Canton and G. H. Rawitscher, *J. Phys. G: Nucl. Part. Phys.* **17**, 429 (1991)
- [27] R. Blankenbecler and R. Sugar, *Phys. Rev.* **142**, 1051 (1966)
- [28] R. Aaron, R. D. Amado, and J. E. Young, *Phys. Rev.* **174**, 2022 (1968)

## FIGURES

FIG. 1. (a) Self-energy graphs occurring in Type-II partitions. The full and dashed lines represent nucleons and pions, respectively, while the full circles represent the  $\pi$ NN vertices, and the blob is the NN t-matrix; (b) a disconnected contribution to the third iteration of the kernel  $K$ . The wavy line represents the NN potential in the three-nucleon space.

FIG. 2. Graphical representation of  $\langle a|G_0(f_{a'})_a$  for (a)  $a' = (\pi N_j N_k) N_i$   $a = (\pi N_j)$ , and (b)  $a' = (\pi N_k)(N_i N_j)$   $a = (N_i N_j)$ . The double full line describes the (NN) quasi-particle, while the dashed-and-full double line is associated to the correlated ( $\pi$ N) pair. The half-circles represent the two-body form factors.

FIG. 3. The coupled equations (4.10) for Type-I partitions. The trapeziums represent the form factors  $|\tilde{\Gamma}_{a'a} \rangle$  and  $|\tilde{\Gamma}_{a'a_1} \rangle$  for the virtual dissociation of the correlated  $\pi$ NN sub-system into a particle and a correlated pair, or into two nucleons, respectively. In the last graph, the presence of the one-pion-exchange tail in the NN potential  $\mathcal{V}_{a_1}$  is shown. Only topologically different graphs are exhibited.

FIG. 4. Graphical representation of the coupled equations (4.8) for Type-II partitions. In this case the form factors  $|\tilde{\Gamma}_{a'}^{(3)} \rangle$  (empty circles) describe the virtual decay of a correlated pair in presence of the off-shell propagation of the other pair, or of a virtual  $(\pi N) \rightarrow N$  transition. The boxes enclose the terms which disappear when the coupling between the  $\pi$ NNN and NNN spaces is switched off in Type-II partitions.

FIG. 5. The driving terms  $Z_{a'b'}^{(2)}$  for the quasi-particle Eqs. (4.14), as given by Eq. (4.15b). The driving terms obtainable from those given here by interchanging the initial and final states are not given. The dashed box encloses the contribution which has to be disregarded to get connected-kernel equations. The full-line boxes exhibit the terms which disappear when emission/absorption is ignored in  $2 + 2$  partitions.

FIG. 6. The non-vanishing contribution  $\langle jk|G_0 f(i) g_0 f^\dagger(i) G_0 |jk \rangle$  to the operator  $\langle a|G_0(f_{a'})_a g_0(f_{a'}^\dagger)_b G_0 |b \rangle$ . It describes the virtual decay and subsequent formation of the NN cluster  $(jk)$ , while the pion is absorbed and re-emitted by nucleon  $N_j$ .

FIG. 7. The Eq. (4.18), expressing the  $\pi + T \rightarrow N + N + N$  absorption amplitude in terms of the  $2 \rightarrow 2$  transition amplitudes in the quasi-particle approximation.

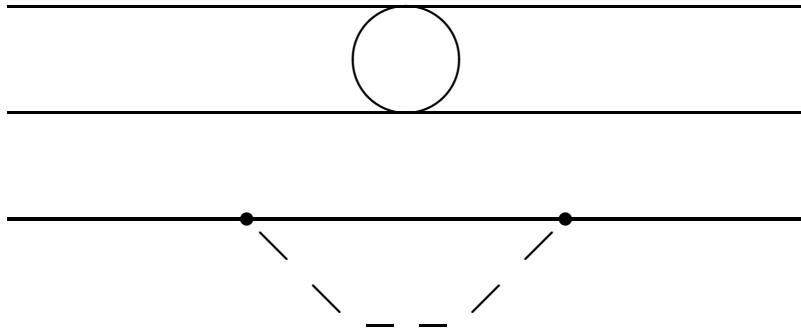

(a)

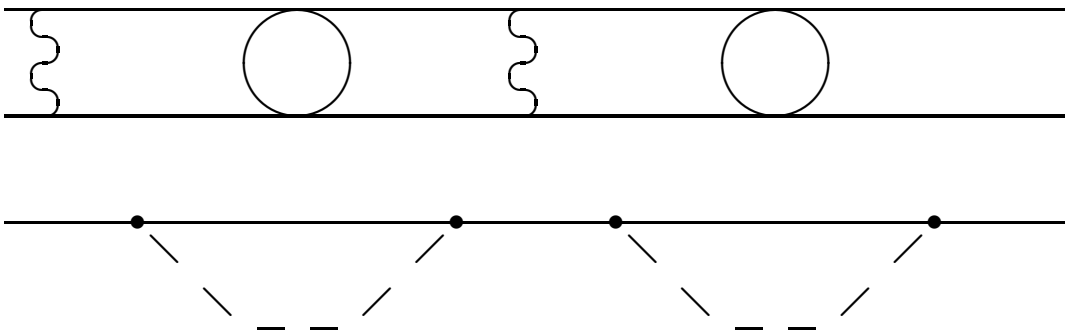

(b)

Fig. 1

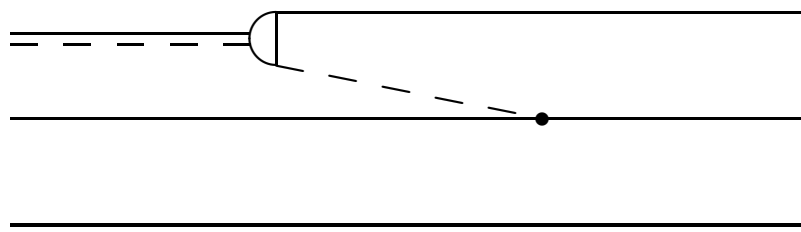

(a)

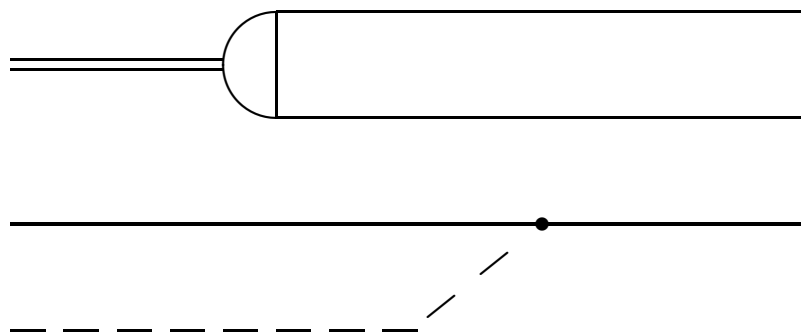

(b)

**Fig. 2**

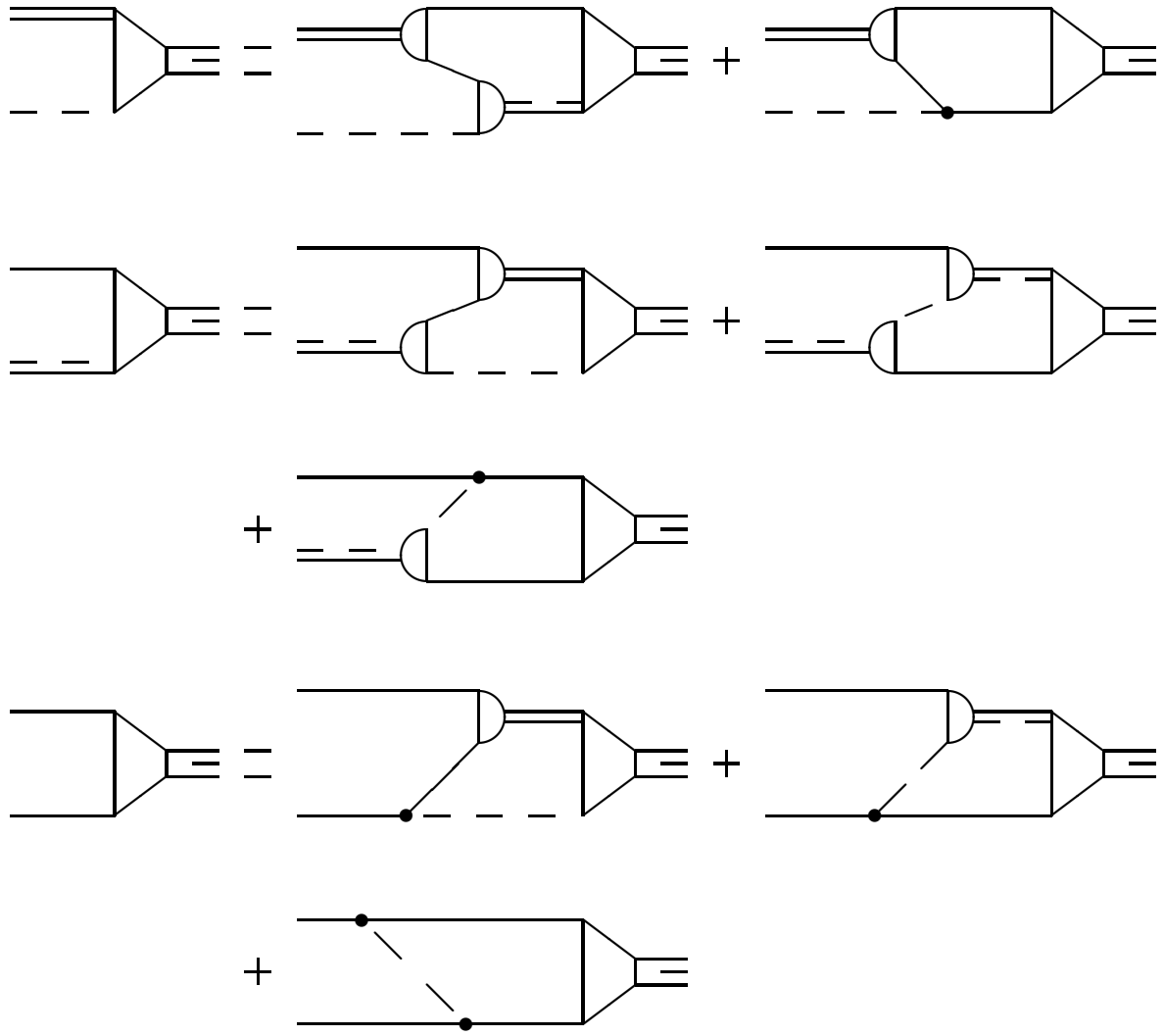

Fig. 3



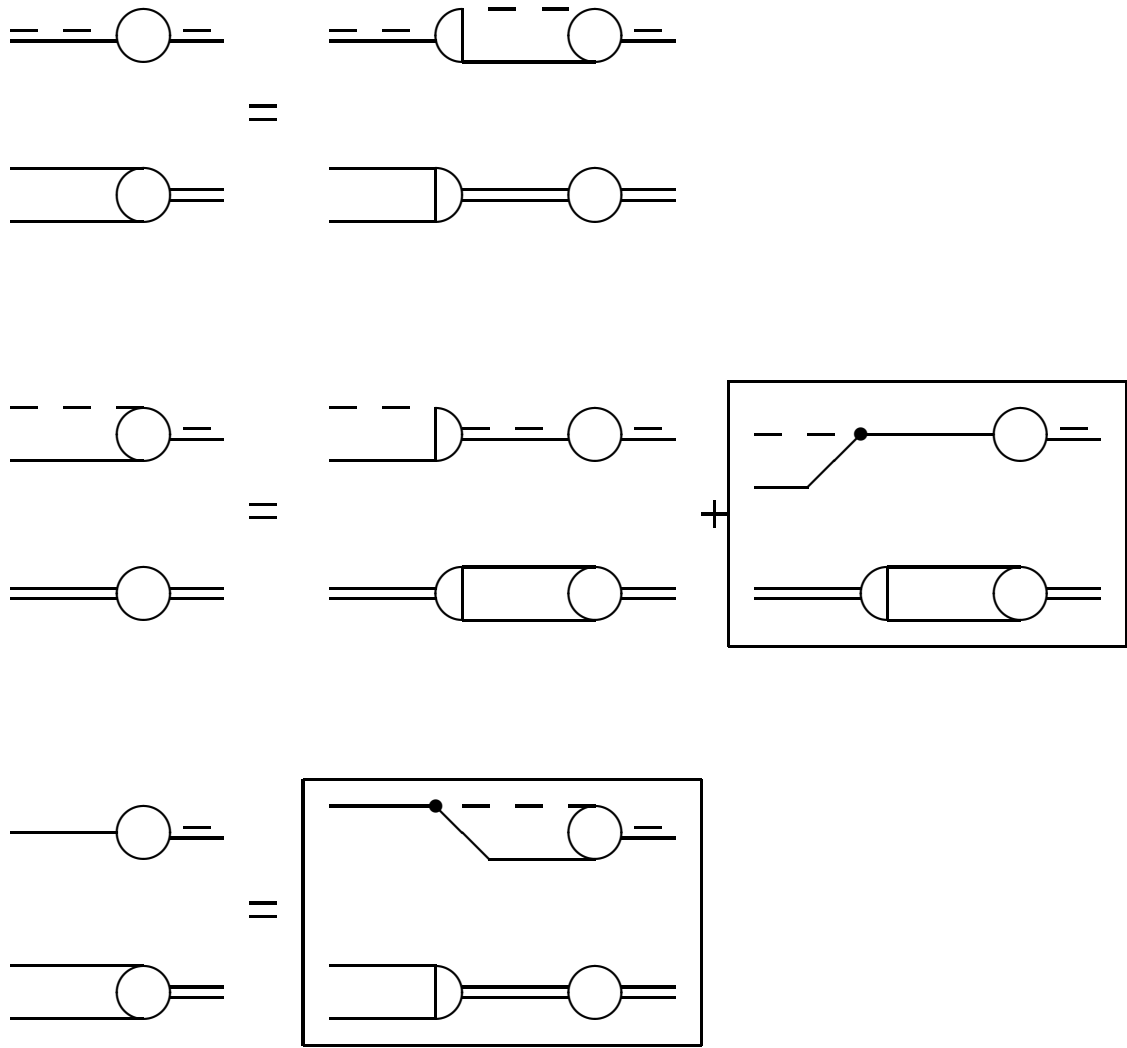
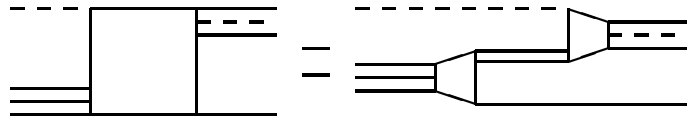
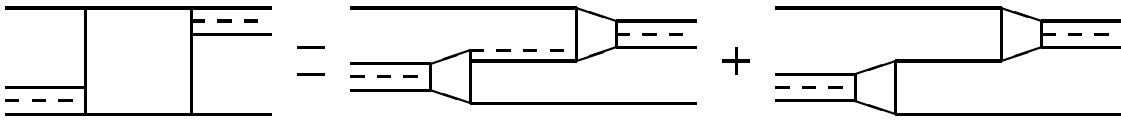

Fig. 4



(a)



(b)

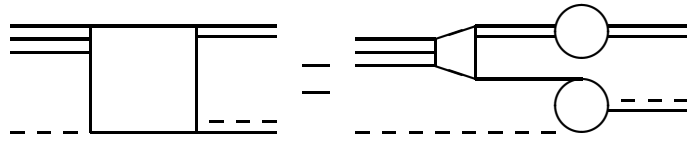

(c)

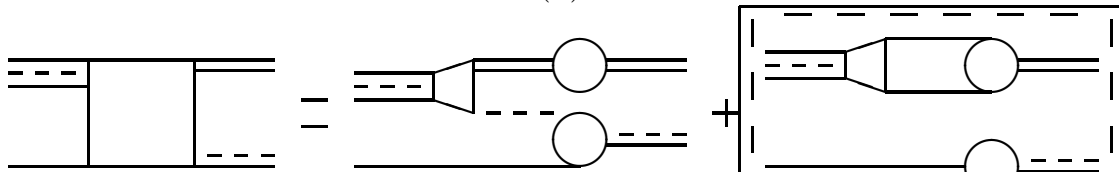

(d)

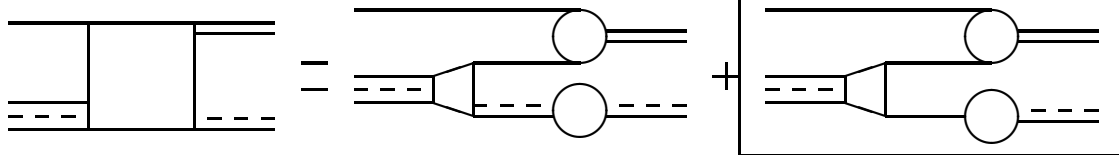

(e)

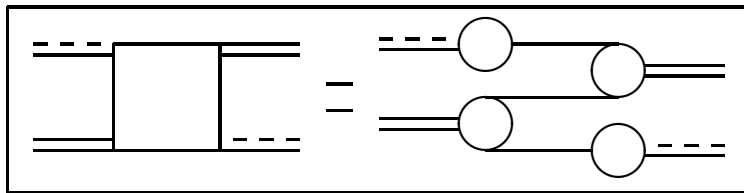

(f)

Fig. 5

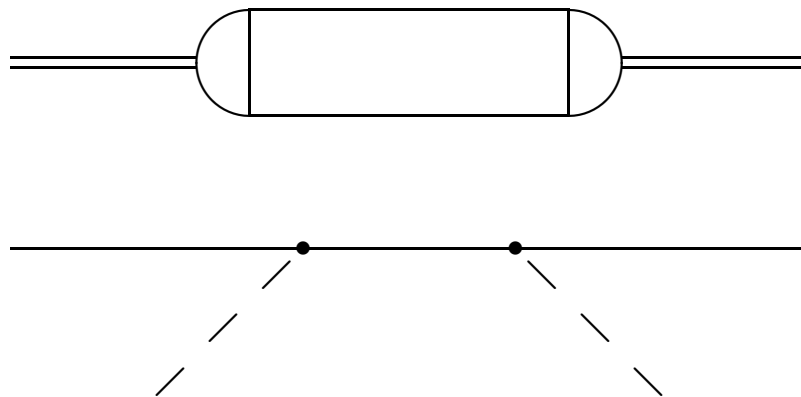

**Fig. 6**

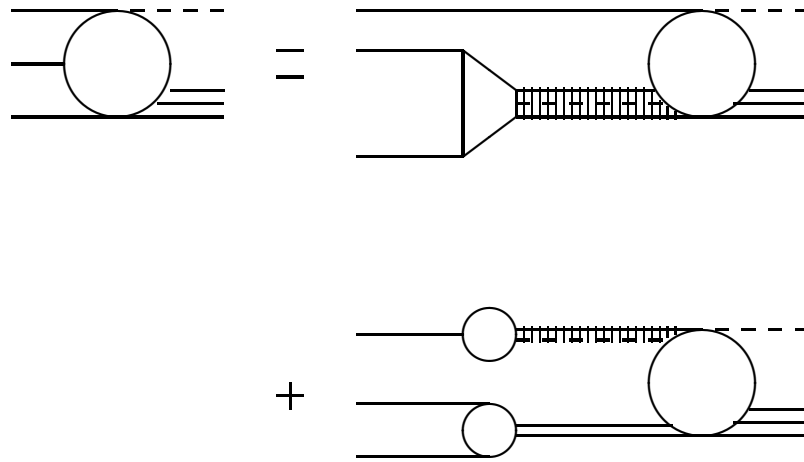

Fig. 7