

NIKHEF 96-028
 VUTH 96-07
 nucl-th/9611040

Prospects for spin physics in semi-inclusive processes*

P.J. Mulders

Department of Physics and Astronomy, Free University of Amsterdam
 and National Institute for Nuclear Physics and High-Energy Physics
 P.O. Box 41882, NL-1009 DB Amsterdam, the Netherlands

Abstract

I discuss inclusive and semi-inclusive lepton-hadron scattering emphasizing the importance of polarization in order to study various single or double spin asymmetries and the importance of particle identification and angular resolution in the detection of final state particles to study azimuthal asymmetries. The observables obtained in this way enable a detailed study of quark and gluon correlations in hadrons.

1 Introduction

The reason that spin has become a hot topic in deep inelastic scattering (DIS) is not only due to the progress in beam and target polarization enabling new experiments, but it is as important that there exists a clear view of what one actually measures. In particular this is the case for sum rules that measure a well-determined local matrix element of quark and gluon field operators. For instance the integral $\int dx g_1^N(x)$ measures an axial current matrix element. For $\int dx (g_1^p - g_1^n)(x)$ this is even a combination that gives up to a factor the nucleon axial charge, a number that can also be obtained from neutron β -decay, a relation known as the Bjorken sumrule.

The topic of this talk will be the relation of DIS observables to matrix elements of quark and gluon operators. In order to establish such a relation one needs to consider *hard* scattering processes in which a large scale Q – in lepton-hadron scattering the four momentum transfer squared $-q^2 \equiv Q^2$ – is present. The leading part of the cross section is related to matrix elements that have a simple interpretation as quark and gluon distributions. Subleading

*Talk presented at the second ELFE Workshop, St. Malo, 23-27 September 1996.

parts in an expansion in $1/Q$ involve matrix elements of combinations of quarks and gluon fields, i.e. quark-gluon correlation functions. These are known as *higher twist* contributions. A particular feature that I want to emphasize is the role of transverse momenta of quarks. To probe them one needs for example semi-inclusive processes such as 1-particle inclusive lepton production. The momentum of the produced hadron defines a direction orthogonal to the *fast* direction defined by the (spacelike) virtual photon and the target hadron. A similar role can be played by the spin vector if the target hadron is transversely polarized. Anyway as will become evident polarization plays an important role in this talk.

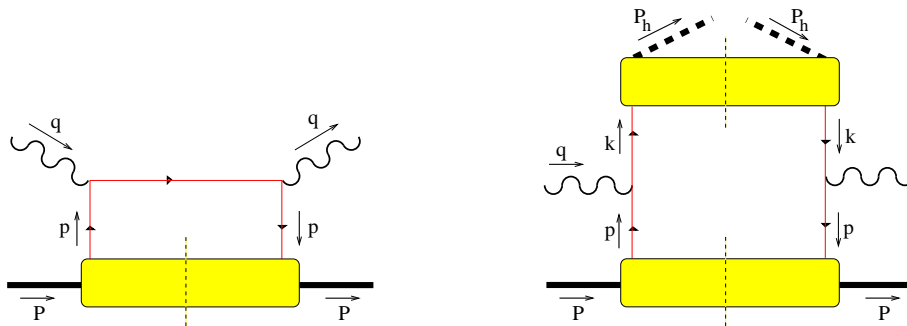
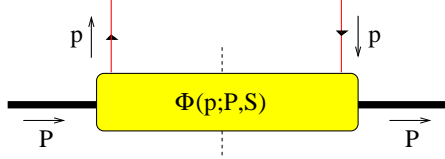

Figure 1: *The simplest (parton-level) diagrams representing the squared amplitude in lepton hadron inclusive scattering (left) en semi-inclusive scattering (right).*

One of the aims of deep inelastic lepton production is the study of the quark and gluon structure of the hadronic target using the known framework of Quantum chromodynamics (QCD). Thus, as a theorist the aim is to calculate the hadronic tensor $W_{\mu\nu}$ by making a diagrammatic expansion. Already at the simplest level (Fig. 1) a problem is encountered, namely there are hadrons involved for which QCD does not provide rules. Thus, *soft parts* are identified that allow inclusion of hadrons in the field theoretical framework. Furthermore it will turn out that for $Q^2 \rightarrow \infty$ only a limited number of diagrams is needed.

2 Soft parts

The soft parts can be written down in terms of quark and gluon fields as illustrated below. They are characterized by the fact that the momenta are *soft* with respect to each other. We have for the distribution part [1, 2]



$$\text{with } p^2 \sim p \cdot P \sim P^2 = M^2 \ll Q^2$$

represented by

$$\Phi_{ij}(p, P, S) = \frac{1}{(2\pi)^4} \int d^4x e^{ip \cdot x} \langle P, S | \bar{\psi}_j(0) \psi_i(x) | P, S \rangle, \quad (1)$$

and the fragmentation part [3]

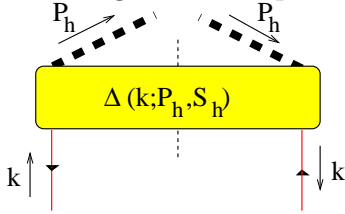

$$\text{with } k^2 \sim k \cdot P_h \sim P_h^2 = M_h^2 \ll Q^2$$

represented by

$$\Delta_{ij}(k, P_h, S_h) = \sum_X \frac{1}{(2\pi)^4} \int d^4x e^{ik \cdot x} \langle 0 | \psi_i(x) | P_h, S_h; X \rangle \langle P_h, S_h; X | \bar{\psi}_j(0) | 0 \rangle. \quad (2)$$

In order to find out which information in the soft parts Φ and Δ is important in a hard process one needs to realize that the hard scale Q leads in a natural way to the use of lightlike vectors n_+ and n_- satisfying $n_+^2 = n_-^2 = 0$ and $n_+ \cdot n_- = 1$. For inclusive deep inelastic scattering¹

$$\left. \begin{aligned} q^2 &= -Q^2 \\ P^2 &= M^2 \\ 2P \cdot q &= \frac{Q^2}{x_B} \end{aligned} \right\} \longleftrightarrow \left\{ \begin{aligned} P &= \frac{x_B M^2}{Q\sqrt{2}} n_- + \frac{Q}{x_B \sqrt{2}} n_+ \\ q &= \frac{Q}{\sqrt{2}} n_- - \frac{Q}{\sqrt{2}} n_+ \end{aligned} \right.$$

Comparing the power of Q with which the momenta in the soft and hard part appear one immediately is led to the fact that $\int dp^- \Phi(p, P, S)$ is the relevant quantity to investigate,

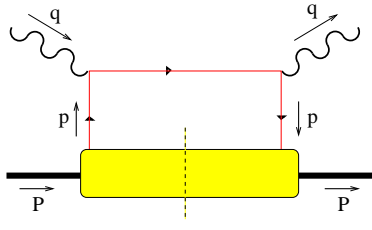

part	'components'		
	-	+	
HARD	$\sim Q$	$\sim Q$	
$H \rightarrow q$	$\sim 1/Q$	$\sim Q$	$\rightarrow \int dp^- \dots$

¹ the lightlike vectors may be rescaled into dimensionful vectors $\hat{p} = (Q/x_B \sqrt{2})n_+$ and $\hat{n} = (x_B \sqrt{2}/Q)n_-$, thus

$$P = \hat{p} + \frac{M^2}{2} \hat{n} \quad \text{and} \quad q = -x_B \hat{p} + \frac{Q^2}{2x_B} \hat{n}.$$

For 1-particle inclusive scattering one parametrizes the momenta as

$$\left. \begin{aligned} q^2 &= -Q^2 \\ P^2 &= M^2 \\ P_h^2 &= M_h^2 \\ 2P \cdot q &= \frac{Q^2}{x_B} \\ 2P_h \cdot q &= -z_h Q^2 \end{aligned} \right\} \longleftrightarrow \begin{cases} P_h = \frac{z_h Q}{\sqrt{2}} n_- + \frac{M_h^2}{z_h Q \sqrt{2}} n_+ \\ q = \frac{Q}{\sqrt{2}} n_- - \frac{Q}{\sqrt{2}} n_+ + q_T \\ P = \frac{x_B M^2}{Q \sqrt{2}} n_- + \frac{Q}{x_B \sqrt{2}} n_+ \end{cases}$$

and it follows that one needs besides the quantity $\int dp^- \Phi(p, P, S)$ the equivalent for the fragmentation part, $\int dk^+ \Delta(k, P_h, S_h)$.

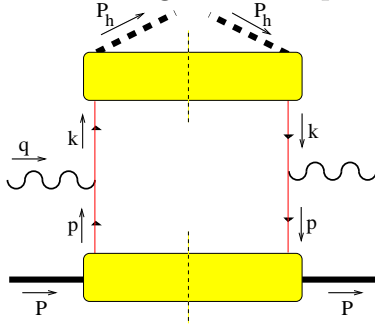

part	'components'		
	-	+	
$q \rightarrow h$	$\sim Q$	$\sim 1/Q$	$\rightarrow \int dk^+ \dots$
HARD	$\sim Q$	$\sim Q$	
$H \rightarrow q$	$\sim 1/Q$	$\sim Q$	$\rightarrow \int dp^- \dots$

3 Analysis of soft parts: distribution and fragmentation functions

Hermiticity, parity and time reversal invariance (T) constrain the quantity $\Phi(p, P, S)$. It must be of the form [4, 5]

$$\begin{aligned} \Phi(k, P, S) &= M A_1 + A_2 \not{P} + A_3 \not{k} + i A_4 \frac{[\not{P}, \not{k}]}{2M} + i A_5 (k \cdot S) \gamma_5 \\ &+ M A_6 \not{S} \gamma_5 + A_7 \frac{k \cdot S}{M} \not{P} \gamma_5 + A_8 \frac{k \cdot S}{M} \not{k} \gamma_5 + A_9 \frac{[\not{P}, \not{S}]}{2} \gamma_5 \\ &+ A_{10} \frac{[\not{k}, \not{S}]}{2} \gamma_5 + A_{11} \frac{k \cdot S}{M} \frac{[\not{P}, \not{k}]}{2M} \gamma_5 + A_{12} \frac{\epsilon_{\mu\nu\rho\sigma} \gamma^\mu P^\nu k^\rho S^\sigma}{M} \end{aligned} \quad (3)$$

with real $A_i = A_i(k^2, k \cdot P)$ and if T applies $A_4 = A_{11} = A_{12} = 0$.

This imposes constraints on the functions allowed in the Dirac projections $\Phi^{[\Gamma]}$ defined as

$$\begin{aligned} \Phi^{[\Gamma]}(x, \mathbf{p}_T) &= \int dp^- \frac{Tr[\Phi \Gamma]}{2} \\ &= \int \frac{d\xi^- d^2 \xi_T}{2 (2\pi)^3} e^{ip \cdot \xi} \langle P, S | \bar{\psi}(0) \Gamma \psi(\xi) | P, S \rangle \Big|_{\xi^+ = 0}, \end{aligned} \quad (4)$$

which is a lightfront ($\xi^+ = 0$) correlation function. The relevant projections in Φ that are important in leading order in $1/Q$ in hard processes are

$$\Phi^{[\gamma^+]}(x, \mathbf{p}_T) = f_1(x, \mathbf{p}_T^2) \quad (5)$$

$$\Phi^{[\gamma^+\gamma_5]}(x, \mathbf{p}_T) = \lambda g_{1L}(x, \mathbf{p}_T^2) + \frac{(\mathbf{p}_T \cdot \mathbf{S}_T)}{M} g_{1T}(x, \mathbf{p}_T^2) \quad (6)$$

$$\begin{aligned} \Phi^{[i\sigma^{i+}\gamma_5]}(x, \mathbf{p}_T) &= S_T^i h_1(x, \mathbf{p}_T^2) + \frac{\lambda p_T^i}{M} h_{1L}^\perp(x, \mathbf{p}_T^2) \\ &\quad - \frac{(p_T^i p_T^j + \frac{1}{2} \mathbf{p}_T^2 g_T^{ij}) S_{Tj}}{M^2} h_{1T}^\perp(x, \mathbf{p}_T^2) \end{aligned} \quad (7)$$

Here $x = p^+/P^+$ and the (lightcone) helicity λ and transverse spin S_T of the target hadron are defined as

$$\left. \begin{array}{l} P^2 = M^2 \\ S^2 = -1 \\ P \cdot S = 0 \end{array} \right\} \longleftrightarrow \left\{ \begin{array}{l} P = \frac{M^2}{2P^+} n_- + P^+ n_+ \\ S = -\lambda \frac{M}{2P^+} n_- + \lambda \frac{P^+}{M} n_+ + S_T \end{array} \right. \\ (\lambda^2 + \mathbf{S}_T^2 = 1)$$

All functions appearing above can be interpreted as momentum space densities, as illustrated in Fig. 2. The first, denoted f_{\dots} (in naming we follow ref. [6]) involve the operator structure

$$\Phi^{[\gamma^+]} \propto \bar{\psi} \gamma^+ \psi = \psi_+^\dagger \psi_+, \quad (8)$$

where $\psi_+ = P_+ \psi$ with $P_+ = \gamma^- \gamma^+ / 2$. This operator projects on the so-called good component of the Dirac field, which can be considered as a *free* dynamical degree of freedom in front form quantization. It is precisely in this sense that partons measured in hard processes are free. The functions g_{\dots} and h_{\dots} appearing above are differences of densities for opposite quark polarizations. In the case of g_{\dots} it is the difference of densities for quark chirality states $\psi_{R/L} = P_{R/L} \psi$ with $P_{R/L} = (1 \pm \gamma_5)/2$,

$$\Phi^{[\gamma^+\gamma_5]} \propto \bar{\psi} \gamma^+ \gamma_5 \psi = \psi_{+R}^\dagger \psi_{+R} - \psi_{+L}^\dagger \psi_{+L}, \quad (9)$$

while in the case of h_{\dots} it is the difference of densities for quark transverse spin states $\psi_{\uparrow/\downarrow} = P_{\uparrow/\downarrow} \psi$ with $P_{\uparrow/\downarrow} = (1 \pm \gamma^1 \gamma_5)/2$,

$$\Phi^{[\sigma^{1+}\gamma_5]} \propto \bar{\psi} \sigma^{1+} \gamma_5 \psi = \psi_{+\uparrow}^\dagger \psi_{+\uparrow} - \psi_{+\downarrow}^\dagger \psi_{+\downarrow}. \quad (10)$$

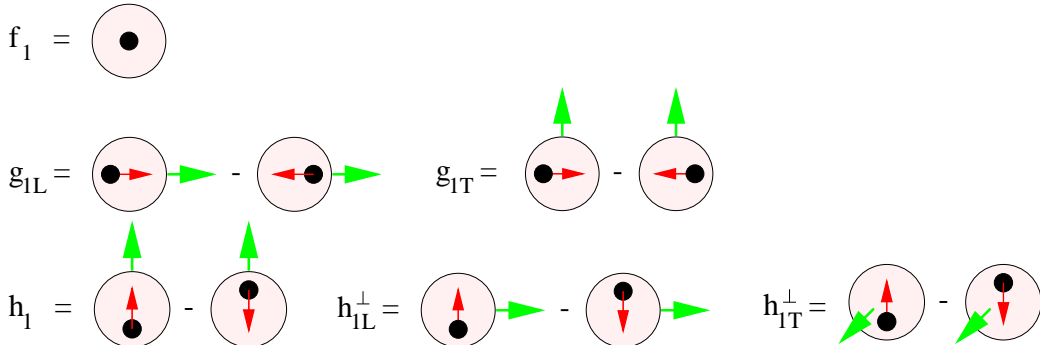

Figure 2: *The interpretation of the leading twist functions appearing in the Dirac projections of the soft part Φ .*

The projectors $P_{R/L}$ and $P_{\uparrow/\downarrow}$ commute with P_+ .

Theorists often are more happy with lightcone correlation functions, because they can employ and isolate lightcone singularities and proof factorization theorems. These appear in the \mathbf{p}_T -integrated quantities

$$\begin{aligned}\Phi^{[\Gamma]}(x) &= \int dp^- d^2\mathbf{p}_T \frac{Tr[\Phi\Gamma]}{2} \\ &= \int \frac{d\xi^-}{4\pi} e^{ip\cdot\xi} \langle P, S | \bar{\psi}(0) \Gamma \psi(\xi) | P, S \rangle \Big|_{\xi^+ = |\boldsymbol{\xi}_T| = 0}\end{aligned}\quad (11)$$

The above constraints on ξ imply $\xi^2 = 0$. The \mathbf{p}_T -averaged results which are relevant for inclusive lepton-hadron or \mathbf{q}_T -averaged Drell-Yan are

$$\Phi^{[\gamma^+]}(x) = f_1(x), \quad (12)$$

$$\Phi^{[\gamma^+\gamma_5]}(x) = \lambda g_1(x), \quad (13)$$

$$\Phi^{[i\sigma^{i+}\gamma_5]}(x) = S_T^i h_1(x). \quad (14)$$

It is useful to remark here that flavor indices have been omitted, i.e. one has f_1^u, f_1^d , etc. At this point it may also be good to mention other notations used frequently such as $f_1^u(x) = u(x)$, $g_1^u(x) = \Delta u(x)$, $h_1^u(x) = \Delta_T u(x)$, etc. We note that some of the \mathbf{p}_T -dependent functions have vanished. They do appear, however, in \mathbf{p}_T/M -weighted results relevant for azimuthal asymmetries in 1-particle inclusive ℓH or DY,

$$\begin{aligned}\Phi_{\partial}^{\alpha[\Gamma]}(x) &\equiv \int dp^- d^2\mathbf{p}_T p_T^\alpha \frac{Tr[\Phi\Gamma]}{2} \\ &= \int \frac{d\xi^-}{4\pi} e^{ip\cdot\xi} \langle P, S | \bar{\psi}(0) \Gamma i\partial^\alpha \psi(\xi) | P, ngl e \rangle \Big|_{\xi^+ = |\boldsymbol{\xi}_T| = 0}\end{aligned}\quad (15)$$

Two \mathbf{p}_T/M -weighted results (relevant for asymmetries in ℓH or DY) are

$$\frac{1}{M} \Phi_{\partial}^{\alpha[\gamma^+\gamma_5]}(x) = S_T^\alpha g_{1T}^{(1)}(x), \quad (16)$$

$$\frac{1}{M} \Phi_{\partial}^{\alpha[i\sigma^{i+}\gamma_5]}(x) = -g_T^{\alpha i} \lambda h_{1L}^{\perp(1)}(x), \quad (17)$$

where the functions with superscript (1) denote \mathbf{p}_T^2 -moments,

$$g_{1T}^{(1)}(x) \equiv \int d^2\mathbf{p}_T \frac{\mathbf{p}_T^2}{2M^2} g_{1T}(x, \mathbf{p}_T). \quad (18)$$

The analysis of the soft part Φ can be extended to other Dirac projections. Limiting ourselves to \mathbf{p}_T -averaged functions one finds the following possibilities,

$$\Phi^{[1]}(x) = \frac{M}{P^+} e(x), \quad (19)$$

$$\Phi^{[\gamma^i\gamma_5]}(x) = \frac{M S_T^i}{P^+} g_T(x), \quad (20)$$

$$\Phi^{[i\sigma^{i+}\gamma_5]}(x) = \frac{M}{P^+} \lambda h_L(x). \quad (21)$$

Lorentz covariance requires for these projections on the right hand side a factor M/P^+ , which as can be seen from the earlier given parametrization of momenta produces a suppression factor M/Q and thus these functions appear at subleading order in cross sections. Furthermore, these functions can not be written in the form of densities or difference of densities. However, interesting relations between these functions and the above \mathbf{p}_T/M -weighted functions can be obtained [7, 8] using the most general amplitude analysis for Φ , constrained by hermiticity, parity and time reversal invariance,

$$g_2 = g_T - g_1 = \frac{d}{dx} g_{1T}^{(1)}, \quad (22)$$

$$h_2 = 2(h_L - h_1) = -2 \frac{d}{dx} h_{1L}^{\perp(1)}. \quad (23)$$

Just as for the distribution functions one can perform an analysis of the soft part describing the quark fragmentation [8]. The Dirac projections in this case are

$$\begin{aligned} \Delta^{[\Gamma]}(z, \mathbf{k}_T) &= \int dk^+ \frac{Tr[\Delta\Gamma]}{4z} \\ &= \sum_X \int \frac{d\xi^+ d^2\xi_T}{4z (2\pi)^3} e^{ik \cdot \xi} Tr \langle 0 | \psi(x) | P_h, X \rangle \langle P_h, X | \bar{\psi}(0) \Gamma | 0 \rangle \Big|_{\xi^- = 0} \end{aligned} \quad (24)$$

The relevant projections in Δ that appear in leading order in $1/Q$ in hard processes are for the case of no final state polarization,

$$\Delta^{[\gamma^-]}(z, \mathbf{k}_T) = D_1(z, -z\mathbf{k}_T), \quad (25)$$

$$\Delta^{[i\sigma^{i-}\gamma_5]}(z, \mathbf{k}_T) = \frac{\epsilon_T^{ij} k_{Tj}}{M_h} H_1^\perp(z, -z\mathbf{k}_T). \quad [\text{T-odd}] \quad (26)$$

The arguments of the fragmentation functions D_1 and H_1^\perp are chosen to be $z = P_h^-/k^-$ and $\mathbf{P}_{h\perp} = -z\mathbf{k}_T$. The first is the (lightcone) momentum fraction of the produced hadron, the second is the transverse momentum of the produced hadron with respect to the quark. The fragmentation function D_1 is the equivalent of the distribution function f_1 . It can be interpreted as the probability of finding a hadron h in a quark. Adding quark flavor index (a) and kind of produced hadron the distribution functions are normalized as $\sum_h \int dz d^2P_{h\perp} z D_1(z, P_{h\perp}) = 1$. Noteworthy is the appearance of the function H_1^\perp , interpretable as the different production probability of unpolarized hadrons from a transversely polarized quark (see Fig. 3). This functions has no equivalent in the distribution functions and is allowed because of the non-applicability of time reversal invariance because of the appearance of out-states $|P_h, X\rangle$ in Δ , rather than the plane wave states in Φ .

After \mathbf{k}_T -averaging one is left with the function

$$\Delta^{[\gamma^-]}(z) = D_1(z), \quad (27)$$

$$D_1 = \textcircled{\bullet} \quad H_1^\perp = \textcircled{\uparrow} - \textcircled{\downarrow}$$

Figure 3: *The interpretation of the leading twist functions appearing in the Dirac projections of the soft part Δ for unpolarized hadrons.*

while the \mathbf{k}_T/M -weighted result is

$$\frac{1}{M} \Delta^{\alpha[i\sigma^{i-}\gamma_5]}(z) = -\epsilon_T^{\alpha i} H_1^{\perp(1)}(z), \quad (28)$$

with

$$H_1^{\perp(1)}(z) \equiv z^2 \int d^2\mathbf{k}_T \frac{\mathbf{k}_T^2}{2M_h^2} H_1(z, -z\mathbf{k}_T). \quad (29)$$

At subleading order in hard processes one finds after \mathbf{k}_T -averaging the following fragmentation functions

$$\Delta^{[1]}(z) = \frac{M_h}{P_h^-} E(z), \quad (30)$$

$$\Delta^{[i\sigma^{ij}\gamma_5]}(z) = \frac{M_h \epsilon_T^{ij}}{P_h^-} H(z). \quad (31)$$

Again a relation with the \mathbf{k}_T/M -weighted functions exist, namely

$$\frac{H(z)}{z} = z^2 \frac{d}{dz} \left[\frac{H_1^{\perp(1)}}{z} \right]. \quad (32)$$

We summarize the analysis of the soft part with a table of distribution and fragmentation functions for unpolarized (U), longitudinally polarized (L) and transversely polarized (T) targets, distinguishing leading (twist two) and subleading (twist three, appearing at order $1/Q$) functions and furthermore distinguishing the chirality. Chiral even functions are diagonal in the space of chiral quark states, which is the case for Dirac projections γ^μ or $\gamma^\mu\gamma_5$ (thus the functions f , g , D and G); chiral odd functions are nondiagonal in this basis, which is the case for Dirac projections 1 , $i\gamma_5$ or $i\sigma^{\mu\nu}\gamma_5$ (thus the functions e , h , E and H). The functions printed in boldface survive after integration over transverse momenta.

DISTRIBUTIONS				FRAGMENTATION			
$\Phi^{[\Gamma]}$		chirality		$\Delta^{[\Gamma]}$		chirality	
		even	odd			even	odd
twist 2	U	\mathbf{f}_1		twist 2	U	\mathbf{D}_1	H_1^\perp
	L	\mathbf{g}_{1L}	h_{1L}^\perp		L	\mathbf{G}_{1L}	H_{1L}^\perp
	T	g_{1T}	\mathbf{h}_1 h_{1T}^\perp		T	G_{1T} D_{1T}^\perp	\mathbf{H}_1 H_{1T}^\perp
twist 3	U	f^\perp	\mathbf{e}	twist 3	U	D^\perp	\mathbf{E} \mathbf{H}
	L	g_L^\perp	\mathbf{h}_L		L	G_L^\perp D_L^\perp \mathbf{E}_L	\mathbf{H}_L
	T	\mathbf{g}_T g_T^\perp	h_T h_T^\perp		T	\mathbf{G}_T G_T^\perp \mathbf{D}_T E_T	H_T H_T^\perp

(9 independent functions)

(12 independent functions)

Note that the number of independent functions is determined by the number of amplitudes A_i in the amplitude analysis, i.e. 9 and 12 for distribution and fragmentation functions respectively.

4 Cross sections for lepton-hadron scattering

Having completed the analysis of the soft parts, the next step is to find out how one obtains the information on the various correlation functions from experiments. We will limit ourselves here to lepton-hadron scattering via one-photon exchange. The relevant kinematic (scaling) variables are given in the figure.

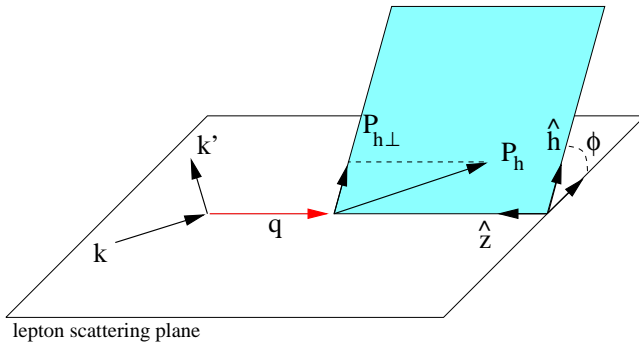

$$\ell H \longrightarrow \ell' h X$$

$$x_B = \frac{Q^2}{2P \cdot q}$$

$$y = \frac{P \cdot q}{P \cdot k}$$

$$z_h = \frac{P \cdot P_h}{P \cdot q}$$

To get the leading order result for semi-inclusive scattering it is sufficient to compute the diagram in Fig. 1 (plus the antiquark analogue) by using QCD and QED Feynman rules in the hard part and the matrix elements Φ and Δ for the soft parts, parametrized in terms of distribution and fragmentation functions. The results are:

Cross sections (leading in $1/Q$)

$$\frac{d\sigma_{OO}}{dx_B dy dz_h} = \frac{2\pi\alpha^2 s}{Q^4} \sum_{a,\bar{a}} e_a^2 \left(1 + (1-y)^2\right) x_B f_1^a(x_B) D_1^a(z_h) \quad (33)$$

$$\frac{d\sigma_{LL}}{dx_B dy dz_h} = \frac{2\pi\alpha^2 s}{Q^4} \lambda_e \lambda \sum_{a,\bar{a}} e_a^2 y(2-y) x_B g_1^a(x_B) D_1^a(z_h) \quad (34)$$

One recognizes in these well-known cross sections the characteristic structure of the 1-particle inclusive cross sections, namely the cross section $2\pi\alpha^2 s/Q^4$ multiplying a kinematic factor (depending on y) and a sum over flavors of a product of a distribution function depending on x_B and a fragmentation function depending on z_h .

Some general rules on where to find a specific correlation function are the following:

- Depending on the twist t of correlation functions, they appear in cross sections suppressed by a factor $\propto (1/Q)^{t-2}$.
- Cross sections are chirally even. This means e.g. that one finds combinations like $f_1 D_1$, $h_1 H_1$ or $e H_1^\perp$. However, quark mass terms are chirally

odd, i.e. one may encounter combinations like $m f_1 H_1^\perp$.

- The number of spin vectors is even in case of a T-even fragmentation function, i.e. there are only double spin asymmetries, such as $\lambda_e \lambda g_1 D_1$, $\lambda_e |\mathbf{S}_T| g_{1T}^{(1)} D_1$ or $|\mathbf{S}_T| |\mathbf{S}_{hT}| h_1 H_1$.
- The number of spin vectors is odd in case of a T-odd fragmentation function, i.e. there are only single spin asymmetries, such as $\lambda_e e H_1^\perp$, $\lambda h_{1L}^{\perp(1)} H_1^\perp$ or $|\mathbf{S}_{hT}| f_1 D_T$.

Two examples of subleading cross sections² are [8, 9]

Cross sections subleading in $1/Q$

$$\frac{2\pi d\sigma_{OT}}{dx_B dy dz_h d\phi_e} = \frac{2\pi\alpha^2 s}{Q^4} |\mathbf{S}_T| \sin(\phi_S) 2(2-y)\sqrt{1-y} \times \sum_{a,\bar{a}} e_a^2 \frac{2M}{Q} x_B h_1^a(x_B) \frac{\tilde{H}^a(z_h)}{z_h}, \quad (35)$$

$$\text{note: } \frac{\tilde{H}^a(z)}{z} = \frac{H^a(z)}{z} + 2 H_1^{\perp(1)a}(z) = \frac{d}{dz} [z H_1^{\perp(1)a}],$$

$$\frac{2\pi d\sigma_{LT}}{dx_B dy dz_h d\phi_e} = \frac{2\pi\alpha^2 s}{Q^4} \lambda_e |\mathbf{S}_T| \cos(\phi_S) 2y\sqrt{1-y} \times \sum_{a,\bar{a}} e_a^2 \left\{ \frac{2M}{Q} x_B^2 g_T^a(x_B) D_1^a(z_h) + \frac{2M_h}{Q} x_B h_1^a(x_B) \frac{\tilde{E}^a(z_h)}{z_h} \right\} \quad (36)$$

$$\text{note: } \frac{\tilde{E}^a(z)}{z} = \frac{E^a(z)}{z} - \frac{m_a}{M_h} D_1^a(z).$$

The tilde functions that appear in the cross sections are in fact precisely the so-called interaction dependent parts of the twist three functions. They would vanish in any naive parton model calculation in which cross sections are obtained by folding e-parton cross sections with parton densities. Considering the relation for \tilde{E} one can state it as $E(z)/z = (m/M_h) D_1(z)$ in the absence of quark-quark-gluon correlations. The inclusion of the latter also require diagrams dressed with gluons (see next section).

In 1-particle inclusive processes, one actually becomes sensitive to quark transverse momentum dependent structure functions already for unpolarized targets. Comparing with inclusive scattering one has four structure functions for unpolarized leptons instead of two (longitudinal W_L and transverse W_T). One of the additional (interference) structure functions (W_{LT}) has a azimuthal dependence $\propto \cos(\phi_h)$. This structure function is order $1/Q$ and involves the

² in all cases where we give polarized cross sections it should be realized that the full expression is $\sigma = \sigma_{OO} + \sigma_{OT} + \dots$, i.e. one needs to consider a difference of cross sections to isolate σ_{OT}

twist three distribution function f^\perp and the fragmentation function D^\perp , of the latter again only the interaction-dependent part. With polarized leptons (target still unpolarized) a fifth structure function can be measured proportional to $\sin(\phi_h)$, involving the distribution function e and the time-reversal odd fragmentation function H_1^\perp . Explicitly one has [10]

Azimuthal asymmetries for unpolarized targets (higher twist)

$$\int d^2\mathbf{P}_{h\perp} \frac{|\mathbf{P}_{h\perp}|}{M z_h} \cos(\phi_h) \frac{d\sigma_{OO}}{dx_B dy dz_h d^2\mathbf{P}_{h\perp}} = -\frac{2\pi\alpha^2 s}{Q^4} 2(2-y)\sqrt{1-y} \\ \times \sum_{a,\bar{a}} e_a^2 \left\{ \frac{2M}{Q} x_B^2 f_1^{\perp(1)a}(x_B) D_1^a(z_h) \right. \\ \left. + \frac{2M_h}{Q} x_B f_1^a(x_B) \frac{\tilde{D}^{\perp(1)a}(z_h)}{z_h} \right\} \quad (37)$$

note: $\tilde{D}^{\perp a}(z) = D^{\perp a}(z) - zD_1^a(z)$,

$$\int d^2\mathbf{P}_{h\perp} \frac{|\mathbf{P}_{h\perp}|}{M z_h} \sin(\phi_h) \frac{d\Delta\sigma_{LO}}{dx_B dy dz_h d^2\mathbf{P}_{h\perp}} = \frac{2\pi\alpha^2 s}{Q^4} \lambda_e 2y\sqrt{1-y} \\ \times \sum_{a,\bar{a}} e_a^2 \frac{2M}{Q} x_B^2 \tilde{e}^a(x_B) H_1^{\perp(1)a}(z_h) \quad (38)$$

note: $\tilde{e}^a(x) = e^a(x) - \frac{m_a}{M} \frac{f_1^a(x)}{x}$.

Leading order azimuthal asymmetries also exist. They require polarized targets and give access to the twist two functions $g_{1T}^{(1)}$ and $h_{1L}^{\perp(1)}$. These are particularly interesting in view of the relations with the twist three functions g_T and h_L . One can check this relation and/or use these cross sections as an alternate way to find these functions. One has [11, 12, 13]

Azimuthal asymmetries for polarized targets (leading twist)

$$\int d^2\mathbf{P}_{h\perp} \frac{|\mathbf{P}_{h\perp}|}{M z_h} \cos(\phi_h - \phi_S) \frac{d\sigma_{LT}}{dx_B dy dz_h d^2\mathbf{P}_{h\perp}} \\ = \frac{2\pi\alpha^2 s}{Q^4} \lambda_e |\mathbf{S}_T| y(2-y) \sum_{a,\bar{a}} e_a^2 x_B g_{1T}^{(1)a}(x_B) D_1^a(z_h) \quad (39)$$

$$\int d^2\mathbf{P}_{h\perp} \frac{|\mathbf{P}_{h\perp}|^2}{MM_h z_h^2} \sin(2\phi_h) \frac{d\Delta\sigma_{OL}}{dx_B dy dz_h d^2\mathbf{P}_{h\perp}} \\ = \frac{2\pi\alpha^2 s}{Q^4} \lambda 2(1-y) \sum_{a,\bar{a}} e_a^2 x_B h_{1L}^{\perp(1)a}(x_B) H_1^{\perp(1)a}(z_h) \quad (40)$$

$$\int d^2\mathbf{P}_{h\perp} d\phi_e \frac{|\mathbf{P}_{h\perp}|}{M_h z_h} \sin(\phi_h + \phi_S) \frac{d\Delta\sigma_{OT}}{dx_B dy dz_h d\phi_e d^2\mathbf{P}_{h\perp}} = \frac{2\pi\alpha^2 s}{Q^4} |\mathcal{S}_T| 2(1-y) \sum_{a,\bar{a}} e_a^2 x_B h_1^a(x_B) H_1^{\perp(1)a}(z_h). \quad (41)$$

Note that these are leading contributions in the cross section. At subleading order the same asymmetries may have higher harmonics, such as a $\sin(3\phi_h - \phi_S)$ asymmetry appearing in $\Delta\sigma_{OT} \sim h_{1T}^{\perp(2)} H_1^{\perp(1)}$.

I want to end this section with giving an indication of the magnitude of a \mathbf{k}_T -dependent distribution functions, in particular look at $g_{1T}^{(1)}(x)$. For this we use the relation of this function with g_2 , namely $g_{1T}^{(1)}(x) = -\int_x^1 dy g_2(y)$ and the SLAC E143 data on g_2 . The result is shown in Fig. 4 (left panel). Except for the data also the result obtained from the Wandzura-Wilczek part of g_2 , namely $g_2^{WW}(x) = -g_1(x) + \int_x^1 dy (g_1(y)/y)$ (omitting quark mass terms). This result is shown in Fig. 4 (left panel) as the solid line [14].

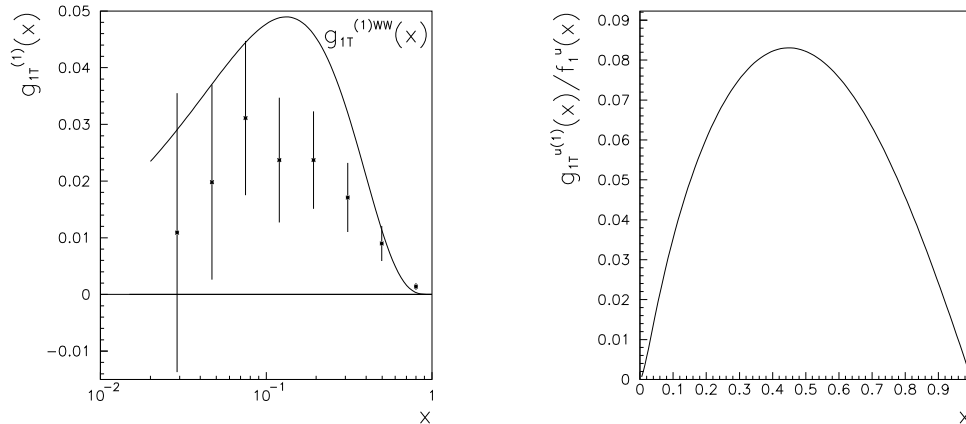

Figure 4: *Left panel: the function $g_{1T}^{(1)}$ estimated from the E143 data on g_2 (datapoints) and from the Wandzura-Wilczek part of g_2 (solid line); right panel: the resulting asymmetry in $ep \rightarrow e\pi^+ X$.*

The resulting asymmetry in σ_{LT} is except for kinematical factors depending on y proportional to the ratio $g_{1T}^{(1)}(x)/f_1(x)$. For the case of π^+ production in polarized lepton scattering off a transversely polarized proton, it is dominantly the u-quark that contributes. This ratio is shown in the right panel of Fig. 4.

5 The full calculation and concluding remarks

In the previous section the lowest order results of the calculations of 1-particle inclusive lepton-hadron scattering have been presented. What other effects are important in these cross sections. As emphasized before, QCD is believed to

provide a reliable framework to obtain the soft parts. Within this framework we can also indicate some theoretical and experimental caveats.

For this, let's write down the first few diagrams in the full calculation within the field theoretical approach

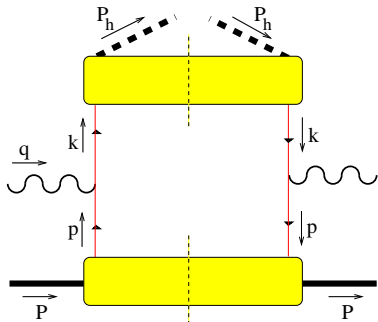

The first contribution is the parton model result, giving the expressions as derived in the previous section. It is important to realize that its validity requires $P \cdot P_h \gg M^2$, the *current fragmentation region* in which there is a sufficiently large rapidity gap between target remnant and produced particles.

The case that $P \cdot P_h \sim M^2$, the *target fragmentation region* involves by the definition of soft parts, those soft parts that contain both target and produced hadron (fracture functions) [15]. These parts need a separate theoretical treatment. The use of the results derived previously is limited to the current fragmentation region.

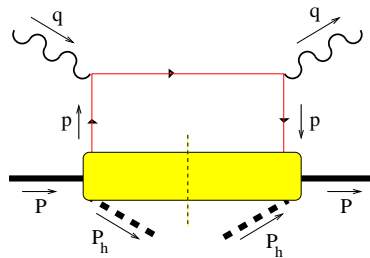

Diagrams containing gluons attached to the soft part (one example shown) need to be considered carefully. They are of two types:

- Longitudinal A^+ (A^-) gluons. They do contribute at leading order, but can be absorbed into the definition of the soft parts, creating the link operator that renders the definition of Φ (Δ) color gauge invariant.
- Transverse A_T^α gluons. They contribute at order $1/Q$. They do not lead to new independent distribution (fragmentation) functions, courtesy of the QCD equations of motion. They ensure electromagnetic gauge invariance of the full calculation at order $1/Q$.

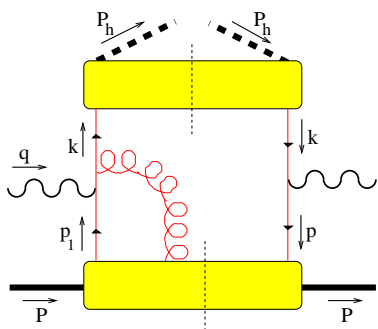

The next corrections that we want to consider are quark and gluon ladders. They give the asymptotic \mathbf{p}_T -dependence of the distribution functions, which turns out to be proportional to α_s/p_T^2 .

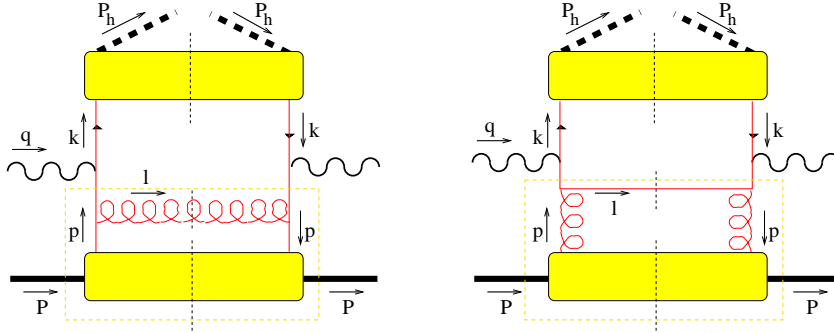

For the integrated distribution functions, this leads to $\alpha_s \log(Q^2/\mu^2)$ contributions. These can be incorporated into a scale dependence of the distribution functions, described with the GLAP equations.

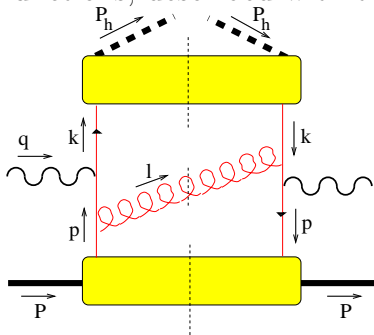

The final QCD corrections which we discuss are process dependent α_s corrections, for 1-particle inclusive scattering arising from a diagram as shown here. A characteristic example for inclusive DIS is the longitudinal part,

$$F_L = \frac{F_2}{x} - 2F_1 \sim \alpha_s(Q^2) \times \dots$$

In my talk I have tried to present results that show the prospects of spin physics in semi-inclusive, in particular 1-particle inclusive lepton-hadron scattering. The goal is the study of the quark and gluon structure of hadrons, emphasizing the spin structure and the dependence on quark transverse momenta. The reason why the prospect is promising is the existence of a field theoretical framework that allows a clean study involving well-defined hadronic matrix elements.

This work is part of the scientific program of the foundation for Fundamental Research on Matter (FOM), the Dutch Organization for Scientific Research (NWO) and the TMR program ERB FMRX-CT96-0008.

References

- [1] D.E. Soper, Phys. Rev. D 15 (1977) 1141; Phys. Rev. Lett. 43 (1979) 1847.
- [2] R.L. Jaffe, Nucl. Phys. B 229 (1983) 205.
- [3] J.C. Collins and D.E. Soper, Nucl. Phys. B 194 (1982) 445.
- [4] J.P. Ralston and D.E. Soper, Nucl.Phys. B 152 (1979) 109.
- [5] R.D. Tangerman and P.J. Mulders, Phys. Rev. D 51 (1995) 3357.
- [6] R.L. Jaffe and X. Ji, Nucl. Phys. B 375 (1992) 527.

- [7] A.P. Bukhvostov, E.A. Kuraev and L.N. Lipatov, *Sov. Phys. JETP* 60 (1984) 22.
- [8] R.D. Tangerman and P.J. Mulders, *Nucl. Phys. B* 461 (1996) 197.
- [9] R.L. Jaffe and X. Ji, *Phys. Rev. Lett.* 71 (1993) 2547.
- [10] J. Levelt and P.J. Mulders, *Phys. Rev. D* 49 (1994) 96; *Phys. Lett. B* 338 (1994) 357.
- [11] J. Collins, *Nucl. Phys. B* 396 (1993) 161.
- [12] A. Kotzinian, *Nucl. Phys. B* 441 (1995) 234.
- [13] R.D. Tangerman and P.J. Mulders, *Phys. Lett. B* 352 (1995) 129.
- [14] A. Kotzinian and P.J. Mulders, *Phys. Rev. D* 54 (1996) 1229.
- [15] L. Trentadue and G. Veneziano, *Phys. Lett. B* 323 (1994) 201.