

Λ - Σ conversion in ${}^4_{\Lambda}\text{He}$ and ${}^4_{\Lambda}\text{H}$ based on four-body calculation

E. Hiyama

*Institute of Particle and Nuclear Studies, High Energy Accelerator Research Organization (KEK),
Tsukuba, 305-0801, Japan*

M. Kamimura

Department of Physics, Kyushu University, Fukuoka 812-8581, Japan

T. Motoba

Laboratory of Physics, Osaka Electro-Comm. University, Neyagawa 572-8530, Japan

T. Yamada

Laboratory of Physics, Kanto Gakuin University, Yokohama 236-8501, Japan

Y. Yamamoto

Physics Section, Tsuru University, Tsuru, Yamanashi 402-8555, Japan

Abstract

Precise four-body calculations for ${}^4_{\Lambda}\text{He}$ and ${}^4_{\Lambda}\text{H}$ have been performed in the framework of the variational method with Jacobian-coordinate Gaussian-basis functions. All the rearrangement channels of both $NNN\Lambda$ and $NNN\Sigma$ are explicitly taken into account for the first time with the use of realistic NN and YN interactions. The role of Λ - Σ conversion and the amount of the virtual Σ -component in ${}^4_{\Lambda}\text{He}$ and ${}^4_{\Lambda}\text{H}$ are discussed.

21.80.+a,21.10.Dr,21.10.Gv,21.45.+v

Typeset using REVTeX

I. INTRODUCTION

It is one of the most fundamental problems in hypernuclear physics to extract novel information of YN interactions through precise calculations for a few-body systems such as ${}^3_{\Lambda}\text{H}$, ${}^4_{\Lambda}\text{He}$ and ${}^4_{\Lambda}\text{H}$. Although a number of studies for ${}^4_{\Lambda}\text{He}$ and ${}^4_{\Lambda}\text{H}$ have been performed with the use of various models so far, the relations to the underlying YN interactions are dependent on the adopted models [1,2,4]. In order to explore the features of the YN interactions, it is highly required to perform four-body calculation without any restriction in the configuration space. An especially interesting issue in this relation is to make clear the role of Λ - Σ conversion and to get a reliable estimate of the amount of the virtual Σ -component in Λ hypernuclei.

However, the ΛN - ΣN coupling terms of the YN one-boson-exchange (OBE) models proposed so far have a lot of ambiguity due to scarce information from the YN scattering experiments. Recently, a series of the realistic YN interaction models called NSC97a~f [5] have been proposed in which the spin-spin strengths are varied within the acceptable range in view of the limited YN scattering data. Correspondingly, by including the ΛN - ΣN coupling explicitly, Miyagawa *et al.* [6] performed the Faddeev calculations for ${}^3_{\Lambda}\text{H}$ extensively to test these OBE potential models in this lightest system. They found that the ΛN - ΣN coupling is crucial to get the bound state of ${}^3_{\Lambda}\text{H}$ and that only the version-f potential is acceptable among NSC97 models. For the further examination on the ΛN - ΣN coupling, ${}^4_{\Lambda}\text{He}$ and ${}^4_{\Lambda}\text{H}$ are much more useful because both of the spin-doublet states have been observed. Regarding the representative calculations done so far, Gibson *et al.* employed the coupled two-body model [1] of ${}^3\text{He}({}^3\text{H})+\Lambda/\Sigma$ which was adopted originally by Dalitz and Downs [7], and then carried out the four-body coupled-channel calculation with the separable potentials of central nature [2]. J. Carlson tried to perform four-body calculation of these hypernuclei with NSC89 model by using Variational Monte Carlo method [3] and calculated the binding energies with statistical errors of 100 keV. Akaishi *et al.* [4] recently analyzed the role of the ΛN - ΣN coupling for the 0^+-1^+ splitting also in the framework of the coupled two-body

model of ${}^3\text{He}+\Lambda/\Sigma$. Now our concern is to perform precise four-body calculations of $NNN\Lambda$ and $NNN\Sigma$ irrespectively of any model assumptions.

It should be noted that, when one goes from ${}^3_\Lambda\text{H}$ to the $A = 4$ strange systems by allowing the Λ - Σ conversion, the computational difficulty increases tremendously. Recently we have successfully performed the extensive four-body calculations without any restriction on the configuration space: Both the $NNN\Lambda$ and $NNN\Sigma$ channels have been incorporated explicitly and all the rearrangement channels of these baryons are taken into account. The variational method with the use of Jacobian-coordinate Gaussian-basis functions [8,9] is adopted here; it has been proved to provide us with precise computational results for few-body systems [8–12].

The main purpose of this work is, first, to solve four-body problem of ${}^4_\Lambda\text{He}$ and ${}^4_\Lambda\text{H}$ by taking into account the $NNN\Lambda(\Sigma)$ channels explicitly with the use of realistic NN and YN interactions and, secondly, to clarify the role of the ΛN - ΣN coupling in the $A = 4$ hypernuclei quantitatively.

In Sec. II, we describe our method to solve the four-body problem and YN and NN interactions adopted here. In Sec.III, we calculate the Λ binding energies, the Σ -mixing probabilities and the ΛN and ΣN correlation functions in ${}^4_\Lambda\text{He}$ and ${}^4_\Lambda\text{H}$. The role of the ΛN - ΣN coupling is investigated by dividing its whole contribution into the ΛN two-body and ΛNN three-body parts. A summary is given in Sec. IV.

II. METHOD AND INTERACTIONS

As the first step before going to the use of sophisticated OBE models, we employ here the ΛN - ΣN coupled YN potential with central, spin-orbit and tensor terms [13] which simulates the scattering phase shifts given by NSC97f. The potentials parameters for central, spin-orbit and tensor terms are listed in Table I.

The main reason of using this simulated version of NSC97f is to focus our attention clearly on the physical ingredients as well as for computational tractability. In this relation,

our most important criterion for selecting the YN interaction is that the observed binding energy of ${}^3_\Lambda\text{H}$ is reproduced reasonably: The interaction used here leads to the Λ -binding energy, $B_\Lambda({}^3_\Lambda\text{H})$, 0.19 MeV which agrees well with the observed data ($B_\Lambda({}^3_\Lambda\text{H}) = 0.13 \pm 0.05$ MeV). As for the NN interaction, we employ the AV8 potential [14]. We shall, however, examine how the choice of the NN potential affect the Λ binding energy; we additionally take the Bonn A potential [15] and the Minnesota potential (central force only) [16] and investigate the role of the tensor term of NN potential.

The total four-body wavefunction is described as a sum of the amplitudes of all the rearrangement channels ($c = 1 - 4$) of Fig. 1 in the LS coupling scheme:

$$\begin{aligned} \Psi_{JM}({}^4_\Lambda\text{He}, {}^4_\Lambda\text{H}) &= \sum_{Y=\Lambda,\Sigma} \sum_{c=1}^4 \sum_{\alpha I} \sum_{ss'St't'} C_{\alpha I ss'St't'}^{(c)} \\ &\times \mathcal{A} \left\{ \left[\Phi_{\alpha I}^{(Y,c)}(\mathbf{r}_c, \mathbf{R}_c, \boldsymbol{\rho}_c) \left[[\chi_{s'}(12)\chi_{\frac{1}{2}}(3)]_s \chi_{\frac{1}{2}}(Y) \right]_S \right]_{JM} \right. \\ &\quad \left. \times [[\eta_{t'}(12)\eta_{\frac{1}{2}}(3)]_t \eta_{t_Y}(Y)]_{T=\frac{1}{2}} \right\}, \end{aligned} \quad (1)$$

where the spatial part is expressed, with a set of quantum numbers $\alpha = \{nl, NL, K, \nu\lambda\}$, by

$$\Phi_{\alpha IM}(\mathbf{r}, \mathbf{R}, \boldsymbol{\rho}) = \left[[\phi_{nl}(\mathbf{r})\psi_{NL}(\mathbf{R})]_K \xi_{\nu\lambda}(\boldsymbol{\rho}) \right]_{IM}.$$

Here, \mathcal{A} is the three-nucleon antisymmetrization operator and χ 's and η 's are the spin and isospin functions, respectively, with the isospin $t_Y = 0$ (1) for $Y = \Lambda$ (Σ). Functional form of $\phi_{nlm}(\mathbf{r})$ is taken as $\phi_{nlm}(\mathbf{r}) = r^l e^{-(r/r_n)^2} Y_{lm}(\hat{\mathbf{r}})$ where the Gaussian range parameters are chosen to lie in a geometrical progression ($r_n = r_1 a^{n-1}$; $n = 1 \sim n_{\max}$), and similarly for $\psi_{NL}(\mathbf{R})$ and $\xi_{\nu\lambda}(\boldsymbol{\rho})$. These basis functions were verified to be suited for describing both the short-range correlations and the long-range tail behaviour of few-body systems [8–11]. Eigenenergies of the Hamiltonian and coefficients C 's are determined by the Rayleigh-Ritz variational method. The angular momentum space of $l, L, \lambda \leq 2$ is found to be enough to get sufficient convergence of the calculated results mentioned below.

III. RESULTS AND DISCUSSION

All the calculations have been performed both for ${}^4_{\Lambda}\text{He}$ and ${}^4_{\Lambda}\text{H}$. Calculated B_{Λ} of the 0^+ ground state and the 1^+ excited state of ${}^4_{\Lambda}\text{He}$ and ${}^4_{\Lambda}\text{H}$ are illustrated in Fig.2 together with the observed values (also see Table I). In the case of taking only the $NN\Lambda$ channel, both of the two states are unbound. Here, the $NNN\Sigma$ sector is divided into the $(NNN)_{\frac{1}{2}}\Sigma$ and $(NNN)_{\frac{3}{2}}\Sigma$ channels in which the three nucleons are coupled to isospin $t = 1/2$ and $3/2$, respectively. When the $(NNN)_{\frac{1}{2}}\Sigma$ channel is included, the 0^+ state becomes bound, but the 1^+ state is still unbound. Then we found that the 1^+ state becomes bound only when the $(NNN)_{\frac{3}{2}}\Sigma$ channel is switched on. It is noted that the binding energy of the 0^+ state increases only slightly with this $t = 3/2$ channel. The Σ -channel components turn out to play an essential role in the binding mechanism of the $A = 4$ hypernuclei, the $(NNN)_{\frac{3}{2}}\Sigma$ channel being specially important in the 1^+ state. The calculated binding energy of the 0^+ state almost reproduces the observed binding energy, while the 1^+ state is less bound by 0.6 (0.4) MeV for ${}^4_{\Lambda}\text{H}$ (${}^4_{\Lambda}\text{H}$), and hence the 0^+-1^+ splitting is larger than the observed splitting. The calculated value of $B_{\Lambda}({}^4_{\Lambda}\text{He}(0^+)) - B_{\Lambda}({}^4_{\Lambda}\text{H}(0^+)) = -0.05$ MeV is different from the experimental one, $+0.35$ MeV, although the Coulomb potentials between charged particles (p, Σ^{\pm}) are included. This difference should be attributed to the charge-symmetry-breaking component which is not included in our adopted YN interaction.

Here, we examine how the calculated Λ binding energies depend on the properties of adopted NN potentials. Bandō *et al.* once pointed out that the rearrangement effect originated from the NN tensor force plays an important role for the mass dependence of Λ binding energies of $A = 3 \sim 5$ hypernuclei. Now let us focus our concern on the NN tensor forces: The three NN potentials compared here are the AV8 potential with a stronger tensor force, the Bonn A potential with a weaker tensor force and the Minnesota potential with a central force only. The binding energy of the ${}^3_{\Lambda}\text{H}$ is reproduced reasonably when these NN potentials are used together with our YN potential. In Fig. 3 the calculated Λ binding energies of the 0^+ and 1^+ states in ${}^4_{\Lambda}\text{He}$ are shown in the cases of using these NN

potentials. It should be noted here that the larger ratio of the NN tensor component turns out to bring about the less binding of Λ . In the cases of using AV8 and Bonn A, in which the tensor components are included more or less realistically, the observed Λ binding energy is reproduced well. However, the use of the effective model with no tensor force such as the Minnesota potential gives rise to the overbinding of Λ by 0.4 MeV. Hereafter, we report only the results for the AV8 potential, because there is no meaningful difference between the results for the AV8 and Bonn A potentials.

As listed in Table III, the calculated probabilities of the $NNN\Sigma$ -channel admixture are 2.08% and 1.03% for the 0^+ and 1^+ states in ${}^4_{\Lambda}\text{He}$, respectively. In the 0^+ state, the probability of the $(NNN)_{\frac{1}{2}}\Sigma$ channel is much larger than that of the $(NNN)_{\frac{3}{2}}\Sigma$ channel, while in the 1^+ state they are nearly the same. We therefore confirm that the $(NNN)_{\frac{3}{2}}\Sigma$ channel is especially important in the 1^+ state. The S -, P - and D -state probabilities of the channels are also listed in Table III. It is remarkable that, in the $NNN\Sigma$ channel, the D -state component is dominant both in the 0^+ and 1^+ states, since the ΛN - ΣN coupling part of the present interaction is dominated by the tensor component. These properties are almost similar in the case of ${}^4_{\Lambda}\text{H}$.

It is of interest to see spatial locations of N , Λ and Σ particles in the $A = 4$ hypernuclei and the correlations between each pairs. For the 0^+ state of ${}^4_{\Lambda}\text{He}$, we illustrated the correlation functions (two-body densities) of the NN , ΛN and ΣN pairs (Fig. 4) and the (one-body) densities of single nucleon and Λ and Σ hyperons (Fig. 5). Also, we calculated the r.m.s. distances between the pair particles ($\bar{r}_{NN}, \bar{r}_{\Lambda N}, \bar{r}_{\Sigma N}$) as well as the r.m.s. radii ($\bar{r}_N, \bar{r}_{\Lambda}, \bar{r}_{\Sigma}$) of N , Λ and Σ measured from the c.m. of $3N$ (Table II). In Fig. 4, the NN correlation function in ${}^4_{\Lambda}\text{He}$ exhibits almost the same shape as that in the ${}^3\text{He}$ nucleus, indicating that the dynamical change of the nuclear size due to the Λ participation is small. The ΛN correlation function is of larger range and flatter than the NN one, because the strength of the ΛN interaction is significantly smaller than the NN case. The ΣN correlation function is much shorter-ranged than the ΛN one due to the large virtual excitation energy (80 MeV) of $\Lambda \rightarrow \Sigma$. These features are verified by the r.m.s. distances ($\bar{r}_{NN}, \bar{r}_{\Lambda N}, \bar{r}_{\Sigma N}$) listed in Table

I.

Furthermore, we notice that the Λ particle is located much outside the core nucleons (see $\bar{r}_\Lambda > \bar{r}_N$ and Fig. 5) and therefore the dynamical change of the core nucleus due to the Λ -particle partition is small: The nucleon r.m.s. radius is $\bar{r}_N = 1.65$ fm which is shrunk by 8 % from the corresponding one, $\bar{r}_N = 1.79$ fm in ${}^3\text{He}$. On the other hand, the Σ hyperon comes close to the nucleons (see $\bar{r}_{\Sigma N} < \bar{r}_{\Lambda N}$ and Fig. 4) and therefore generates a large dynamical contraction of the core nucleus in the $NNN\Sigma$ -channel space; $\bar{r}_N = 1.49$ fm is obtained with the Σ -channel amplitude only and the reduction rate amounts to 17 %. Furthermore, it is interesting to see in Fig. 4 the following feature of the Σ -admixture effect: In spite of the totally small probability of the Σ -mixing (2 %), the ΣN components at short distances are not so small in comparison with the ΛN ones. This enhanced short-ranged component of the Σ -mixing is expected to be reflected in the non-mesic decay of $\Sigma N \rightarrow NN$.

In order to show the physical effect of Σ -mixing in more detail, let us separate the whole contribution of the ΛN - ΣN coupling interaction into the following two processes illustrated in Fig. 6: The first one is the process (i) which can be renormalized into the effective ΛN two-body force and the second one is the process (ii) which can be represented by the effective ΛNN three-body force acting in the $NNN\Lambda$ space. We solve the Schrödinger equation by excluding the three-body process (ii) so as to evaluate the contribution of the process (i) only. As shown in Fig. 6, the process (i) is large enough to make both the 0^+ and 1^+ states bound. We found that the three-body process(ii) is substantial: This process results in attraction by 0.62 MeV in the 0^+ state, while repulsion by 0.09 MeV in the 1^+ state of ${}^4_\Lambda\text{He}$ and similarly for ${}^4_\Lambda\text{H}$.

In order to investigate the respective role of the central and the tensor terms of the ΛN - ΣN coupling interaction in the process (ii), let us make additional calculations with artificial modification as follows: We replace the ΛN - ΣN coupling part of our original interaction by the purely central interaction and by the purely tensor one without changing the other interaction terms, where the calculated ΛN phase shifts are kept almost unchanged. It is found that the effect of the process(ii) is quite different between the two cases. Namely, in

the case of the purely central-force coupling, the contribution is -1.54 MeV (attractive) in the 0^+ state and $+0.43$ MeV (repulsive) in the 1^+ state. On the other hand, in the case of the purely tensor-force coupling, it becomes much reduced values, -0.35 MeV for the 0^+ state and -0.06 MeV for the 1^+ states. Thus, the resulting energies of 0^+ and 1^+ states turn out to be controlled substantially by the ratio of the central and the tensor components in the ΛN - ΣN coupling potential. Characteristic feature of our result of the process (ii) in the 0^+ state is similar to that given by Akaishi *et al* [4]. In the 1^+ state, however, the effect of the process (ii) is much different from the result of Ref. [4]: In our treatment the process (ii) works repulsively or attractively depending on the ratio of the central and the tensor components in the ΛN - ΣN coupling potential, while the contribution of the process (ii) is negligible in Ref. [4] independently of it. This difference may come from the fact that in the 1^+ state of ${}^4_\Lambda\text{He}$, the probability of the $(NNN)_{\frac{3}{2}}\Sigma$ is as large as that of the $(NNN)_{\frac{1}{2}}\Sigma$ in our result, but the $(NNN)_{\frac{3}{2}}\Sigma$ channel cannot be explicitly included in the coupled two-body model of ${}^3\text{He} + \Lambda/\Sigma$ of Ref. [4].

IV. SUMMARY

We have developed the calculational method of four-body bound-state problems so that it becomes possible to make precise four-body calculations of ${}^4_\Lambda\text{H}$ and ${}^4_\Lambda\text{He}$ taking both the $NNNA$ and $NNN\Sigma$ channels explicitly into account using realistic NN and YN interactions. As a result, we succeeded in making clear the role of Λ - Σ conversion and deriving the amount of the Σ -mixing in $A = 4$ hypernuclei quantitatively. However, our YN interaction employed here is not sufficient to reproduce the binding energy of the excited state of 1^+ , although those of ground states of ${}^3_\Lambda\text{H}$, ${}^4_\Lambda\text{He}$ and ${}^4_\Lambda\text{H}$ are in good agreement with the experimental values. It is a future problem to explore the feature of Λ - Σ conversion in Λ hypernuclei with the use of more refined YN interactions through systematic study of structure of the heavier hypernuclear systems.

ACKNOWLEDGMENTS

The authors thank Professor Y. Akaishi, Professor B. F. Gibson and Professor T. A. Rijken for helpful discussions and Mr. Nogga for discussion on numerical results. This work was supported by the Grant-in-Aid for Scientific Research in Priority Areas.

REFERENCES

- [1] B. F. Gibson, A. Goldberg, and M. S. Weiss, Phys. Rev. **C 6**, 741 (1972).
- [2] B. F. Gibson, and D. R. Lehman, Phys. Rev. **C37**, 679 (1988).
- [3] J. Carlson, in LAMPF Workshop on (π, K) Physics, edited by B. F. Gibson, W. R. Gibbs, and M. B. Johnson, AIP Conf. Proc. No. 224 (AIP, New York, 1991), p.198.
- [4] Y. Akaishi, T. Harada, S. Shinmura, and Khin Swe Myint, Phys. Rev. Lett. **84**, 3539 (2000).
- [5] T. A. Rijken, V. G. J. Stoks, and Y. Yamamoto, Phys. Rev. **C59**, 21 (1999).
- [6] K. Miyagawa, H. Kamada, W. Glöckle, H. Yamamura, T. Mart, and C. Bennhold, Few-Body Systems Suppl. **12**, 324 (2000).
- [7] R. H. Dalitz and B. W. Downs, Phys. Rev. **111**, 967 (1958).
- [8] M. Kamimura, Phys. Rev. **A38**, 621 (1988).
- [9] H. Kameyama, M. Kamimura, and Y. Fukushima, Phys. Rev. **C40**, 974 (1989).
- [10] E. Hiyama, and M. Kamimura, Nucl. Phys. **A588**, 35c (1995).
- [11] E. Hiyama, M. Kamimura, T. Motoba, T. Yamada, and Y. Yamamoto, Phys. Rev. **C53**, 2075 (1996).
- [12] E. Hiyama, M. Kamimura, T. Motoba, T. Yamada, and Y. Yamamoto, Phys. Rev. Letters **85**, 270 (2000).
- [13] S. Shinmura (private communications).
- [14] R. B. Wiringa, R. A. Smith, and T. L. Ainsworth, Phys. Rev. **C29**, 1207 (1984).
- [15] R. Machleidt, Adv. Nucl. Phys. **19**, 189 (1989).
- [16] D. R. Thompson, M. Lemere and Y. C. Tang, Nucl. Phys. **A286**,57 (1997)

[17] H. Bandō and I. Shimodaya, Prog. Theor. Phys., **63**, 1812 (1980).

Table I. Parameters of the central (C), spin-orbit (LS) and tensor (T) terms of the NSC97f-simulated YN interaction. Radial form of each term is given by two-range Gaussians. Range (β) is in units of fm and strength (V) in units of MeV.

	β	$V_C(^1E)$	$V_C(^3E)$	V_{LS}	V_T
$N\Lambda$ - $N\Lambda$	0.5	732.08	1068.8	1023.8	-243.31
	1.2	-99.494	-45.490	-17.195	-10.413
$N\Lambda$ - $N\Sigma$	0.5	61.223	-770.21	-19.930	287.54
	1.2	-15.977	68.274	22.299	62.438
$N\Sigma$ - $N\Sigma$ ($t = 1/2$)	0.5	1708.0	863.76	544.56	21.778
	1.2	80.763	28.284	-19.944	-53.542
$N\Sigma$ - $N\Sigma$ ($t = 3/2$)	0.5	695.39	-181.08	-462.31	333.05
	1.2	-109.37	23.282	0.0023	22.234

Table II. Calculated energies of the 0^+ and 1^+ states of ${}^4_{\Lambda}\text{He}$ and ${}^4_{\Lambda}\text{H}$. The energies E are measured from the $NN\Lambda$ four-body breakup threshold. \bar{r}_{A-B} denotes the r.m.s. distances between particles A and B , while \bar{r}_A stands for the r.m.s. radius of particle A measured from the c.m. of $3N$. As for the ${}^3\text{He}$ (${}^3\text{H}$) nucleus, the calculated binding energy is -7.12 (-7.77) MeV and $\bar{r}_{N-N} = 3.10$ (3.03) fm and $\bar{r}_N = 1.79$ (1.75) fm.

J	${}^4_{\Lambda}\text{He}$		${}^4_{\Lambda}\text{H}$	
	0^+	1^+	0^+	1^+
E (MeV)	-9.40	-7.66	-10.10	-8.36
E^{exp} (MeV)	-10.11	-8.87	-10.52	-9.53
B_{Λ} (MeV)	2.28	0.54	2.33	0.59
B_{Λ}^{exp} (MeV)	2.39	1.15	2.04	1.05
\bar{r}_{N-N} (fm)	2.86	3.03	2.83	2.99
$\bar{r}_{\Lambda-N}$ (fm)	3.77	5.74	3.75	5.70
$\bar{r}_{\Sigma-N}$ (fm)	2.24	2.48	2.23	2.46
\bar{r}_N (fm)	1.65	1.75	1.64	1.73
\bar{r}_{Λ} (fm)	3.39	5.47	3.37	5.43
\bar{r}_{Σ} (fm)	1.67	1.81	1.66	1.80

Table III. The S -, P - and D -state and total probabilities of the $(NNN)_{\frac{1}{2}}\Lambda$, $(NNN)_{\frac{1}{2}}\Sigma$ and $(NNN)_{\frac{3}{2}}\Sigma$ channels in the 0^+ and 1^+ states of (a) ${}^4_{\Lambda}\text{He}$ and ${}^4_{\Lambda}\text{H}$. $(NNN)_t$ denotes three nucleons whose isospins are coupled to t .

(a) ${}^4_{\Lambda}\text{He}$

	S (%)	P (%)	D (%)	Total (%)
0^+				
$(NNN)_{\frac{1}{2}}\Lambda$	89.32	0.08	8.52	97.92
$(NNN)_{\frac{1}{2}}\Sigma$	0.84	0.04	1.16	2.04
$(NNN)_{\frac{3}{2}}\Sigma$	0.01	0.01	0.02	0.04
1^+				
$(NNN)_{\frac{1}{2}}\Lambda$	90.38	0.07	8.52	98.97
$(NNN)_{\frac{1}{2}}\Sigma$	0.10	0.01	0.40	0.51
$(NNN)_{\frac{3}{2}}\Sigma$	0.09	0.00	0.43	0.52

(b) ${}^4_{\Lambda}\text{H}$

	S (%)	P (%)	D (%)	Total (%)
0^+				
$(NNN)_{\frac{1}{2}}\Lambda$	89.27	0.08	8.54	97.88
$(NNN)_{\frac{1}{2}}\Sigma$	0.86	0.04	1.19	2.08
$(NNN)_{\frac{3}{2}}\Sigma$	0.01	0.01	0.02	0.04
1^+				
$(NNN)_{\frac{1}{2}}\Lambda$	90.34	0.07	8.54	98.95
$(NNN)_{\frac{1}{2}}\Sigma$	0.10	0.01	0.41	0.52
$(NNN)_{\frac{3}{2}}\Sigma$	0.09	0.00	0.44	0.53

Figure caption

Fig. 1 Jacobian coordinates for all the rearrangement channels of $NNN\Lambda(\Sigma)$ system.

Three nucleons are to be antisymmetrized.

Fig. 2 Calculated energy levels of (a) ${}^4_{\Lambda}\text{He}$ and (b) ${}^4_{\Lambda}\text{H}$. The channels successively included are (i) $(NNN)_{\frac{1}{2}}\Lambda$, (ii) $(NNN)_{\frac{1}{2}}\Sigma$ and (iii) $(NNN)_{\frac{3}{2}}\Sigma$ where the isospin of the three nucleons is coupled to $t = 1/2$ or $3/2$. Energy is measured from the ${}^3\text{He} + \Lambda$ (${}^3\text{H} + \Lambda$) threshold.

Fig. 3 Calculated energy levels of ${}^4_{\Lambda}\text{He}$ with the AV8, Bonn A and Minnesota potentials.

Fig. 4 Correlation functions (two-body densities) of the NN , ΛN and ΣN pairs in the 0^+ state of ${}^4_{\Lambda}\text{He}$ together with that for the NN pair in ${}^3\text{He}$. Here, the correlation function of ΣN pair has been multiplied by factor 2 so as to see the behavior of this function clearly.

Fig. 5 Calculated one-body densities of N , Λ and Σ particles in the 0^+ state of ${}^4_{\Lambda}\text{He}$. Volume integrals of the densities are 1.0, 0.98 and 0.02 for N , Λ and Σ particles, respectively.

Fig. 6 Calculated energy levels of ${}^4_{\Lambda}\text{He}$ for case (i) and case (i)+(ii); here, (i) denotes the two-body process and (ii) denotes the three-body process.

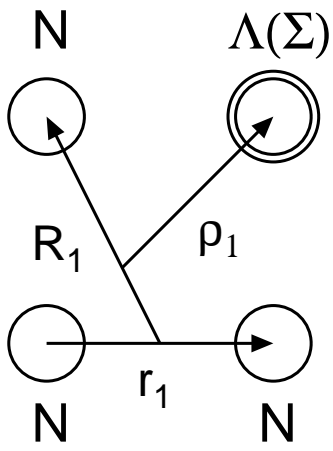

c=1

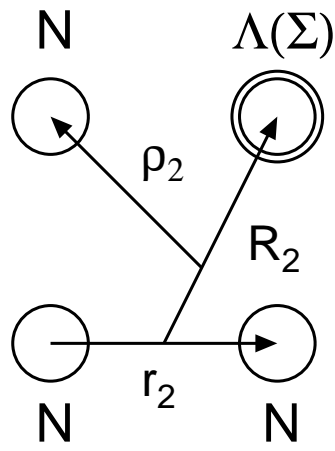

c=2

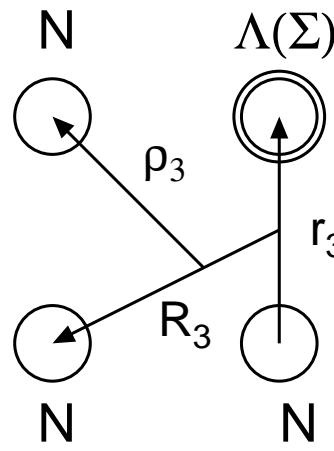

c=3

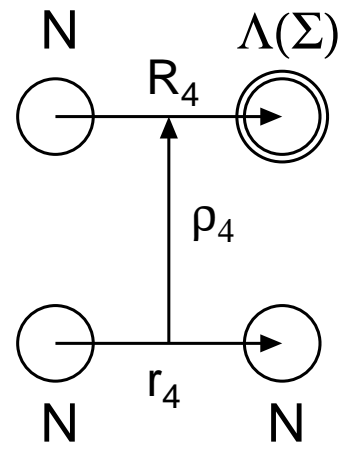

c=4

(a)

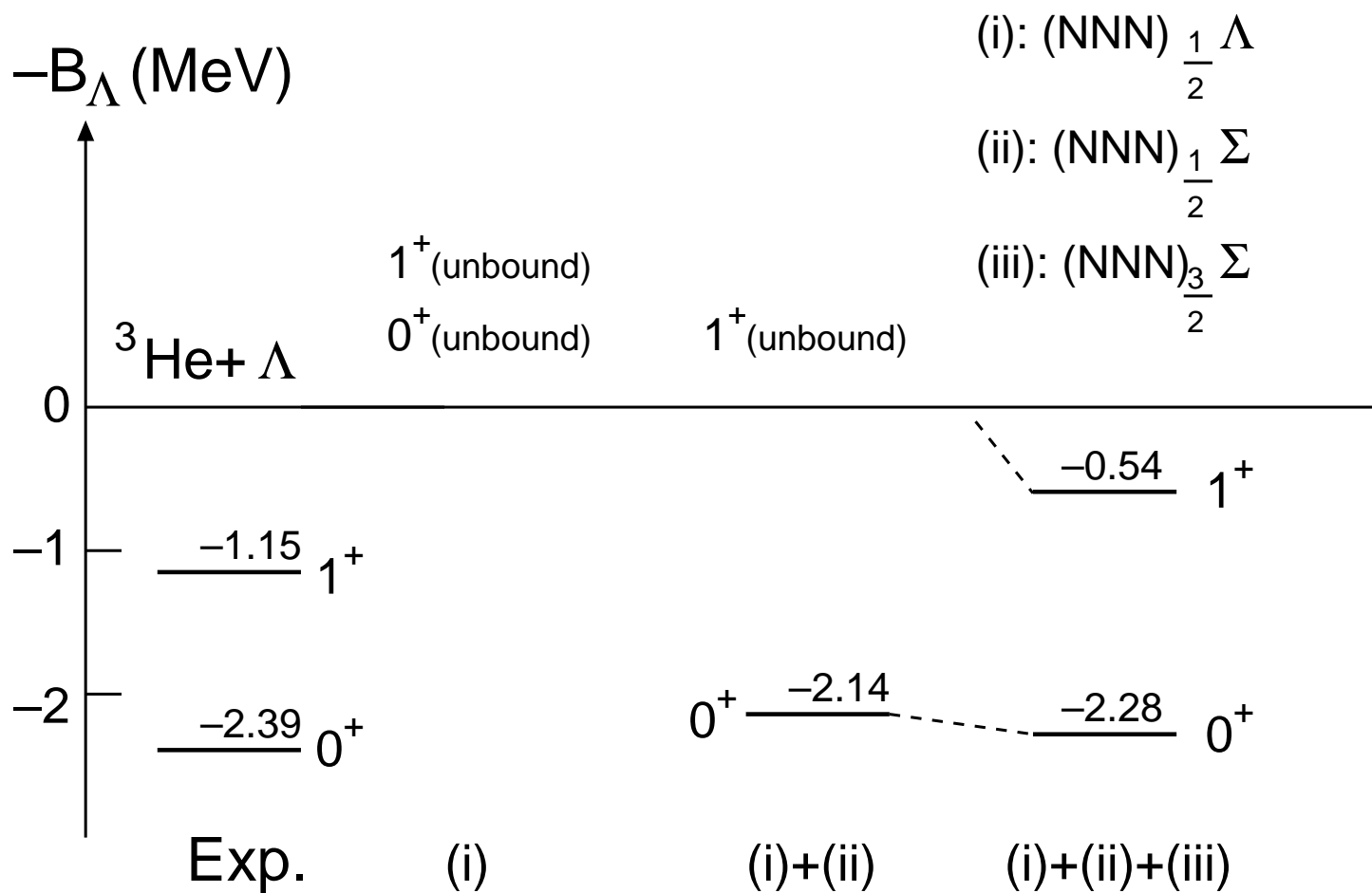

${}^4_{\Lambda}\text{He}$

(b)

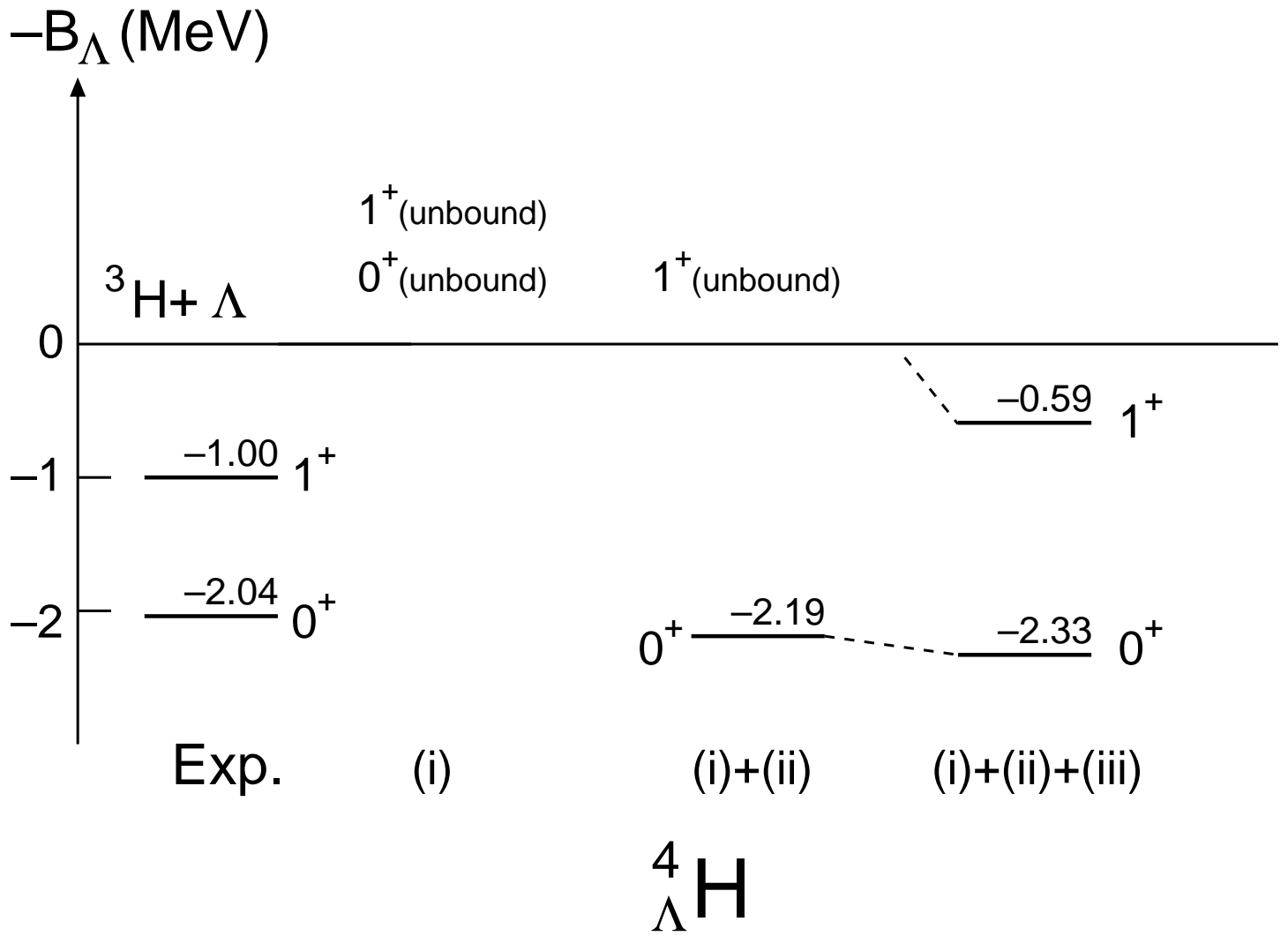

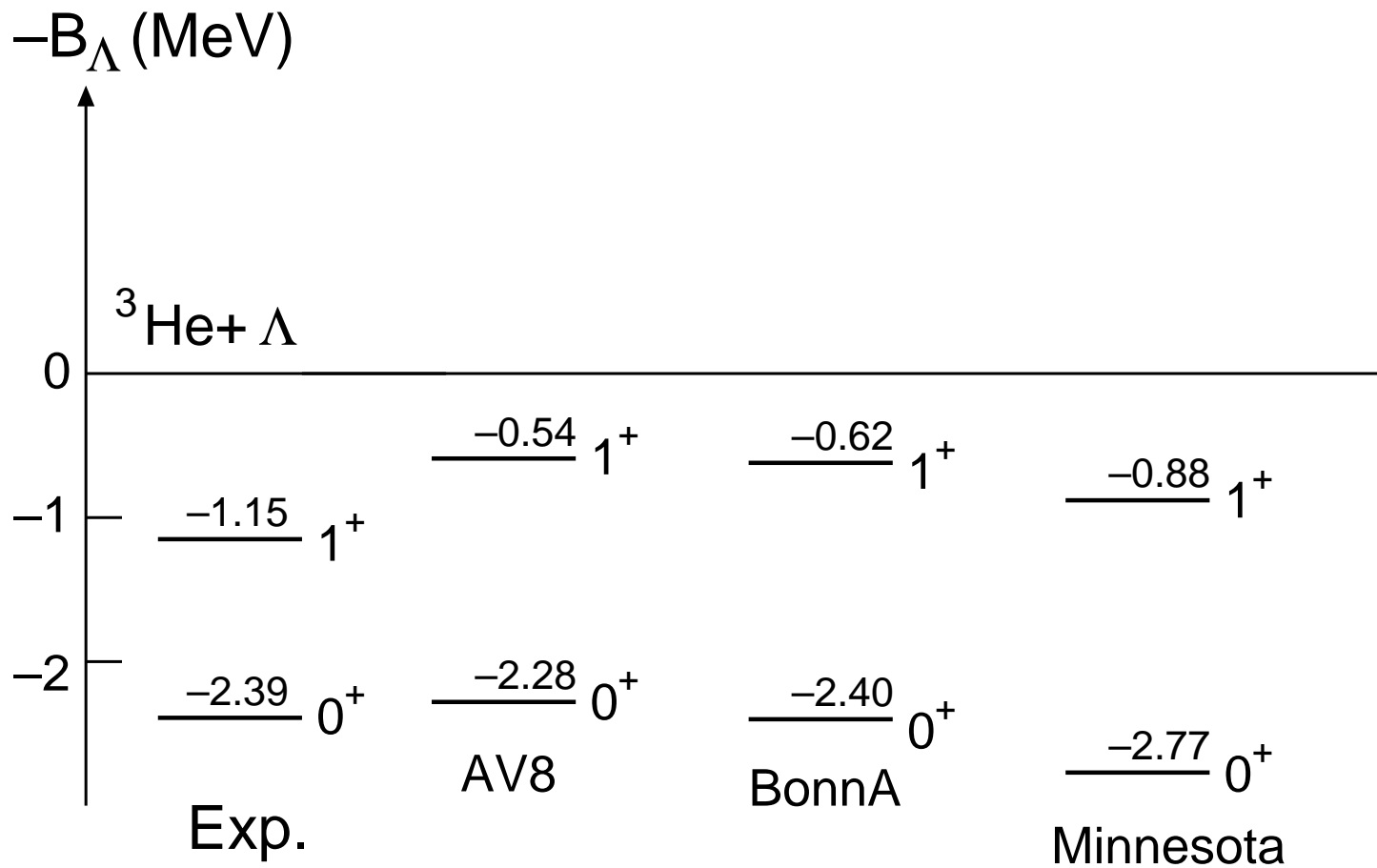

${}^4_{\Lambda}\text{He}$

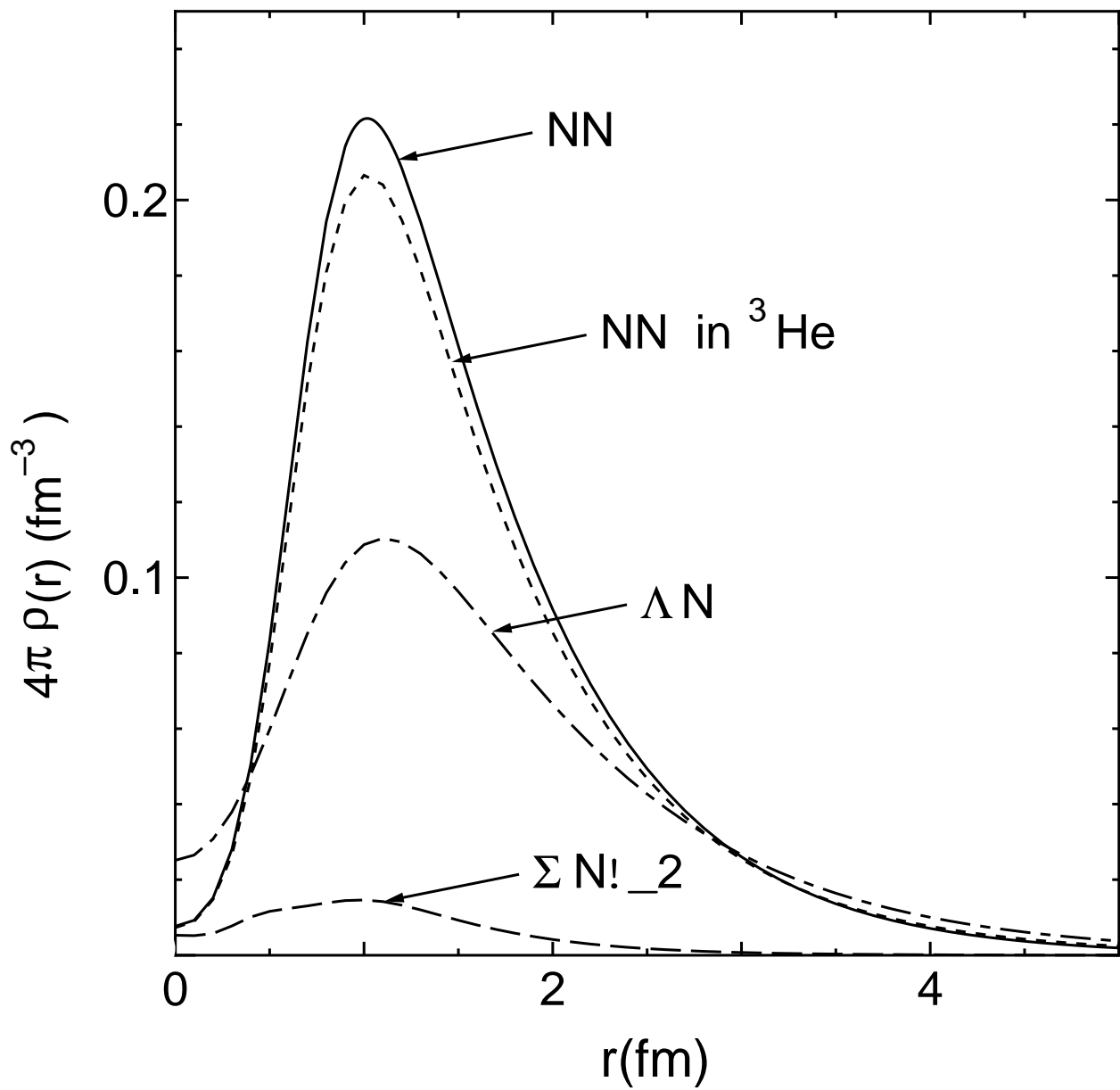

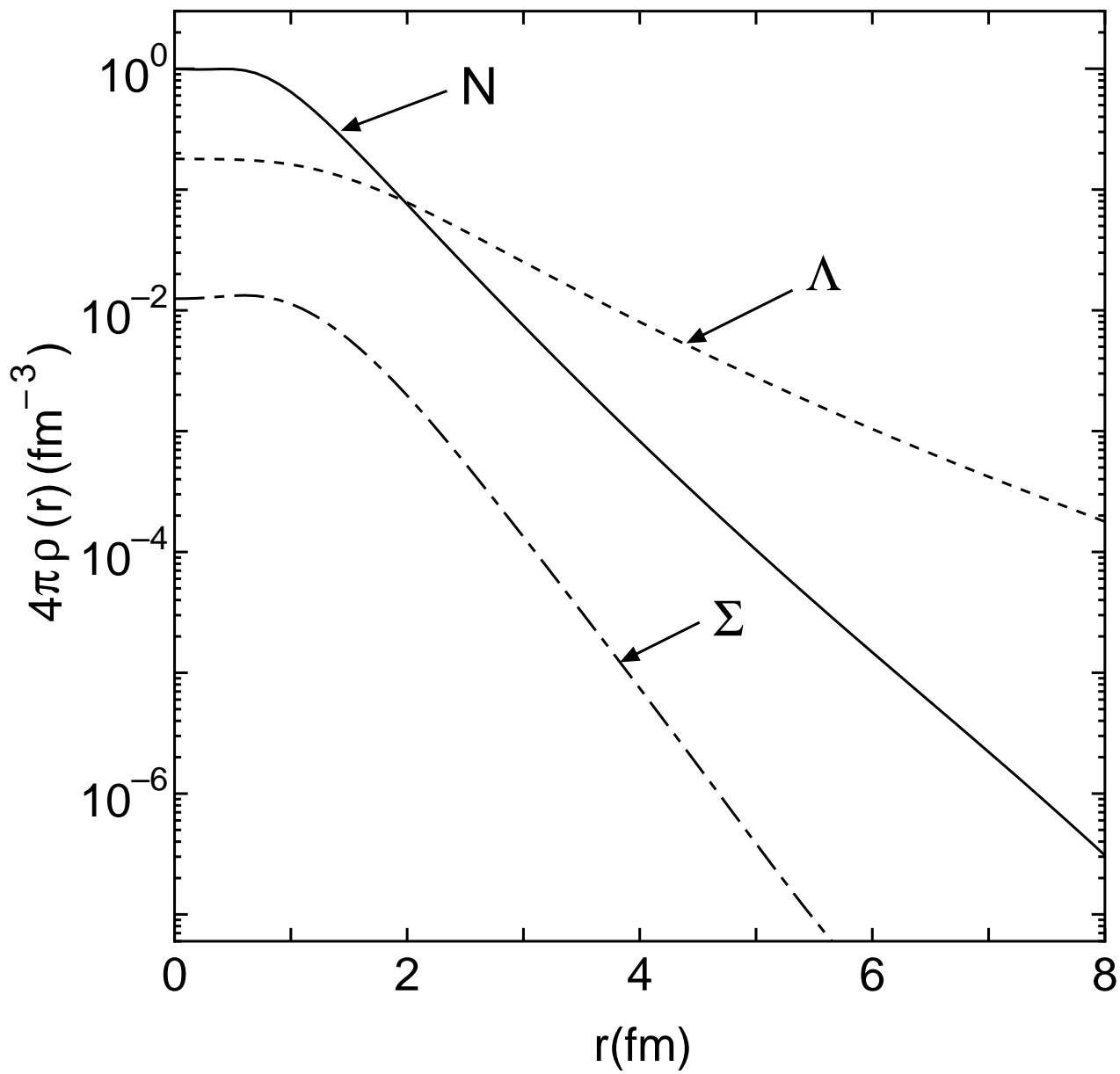

(a)

(i)

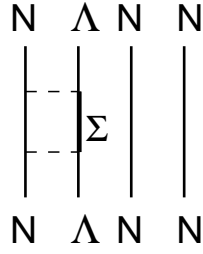

(ii)

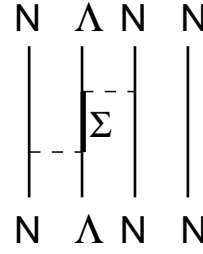

$-B_{\Lambda}$ (MeV)

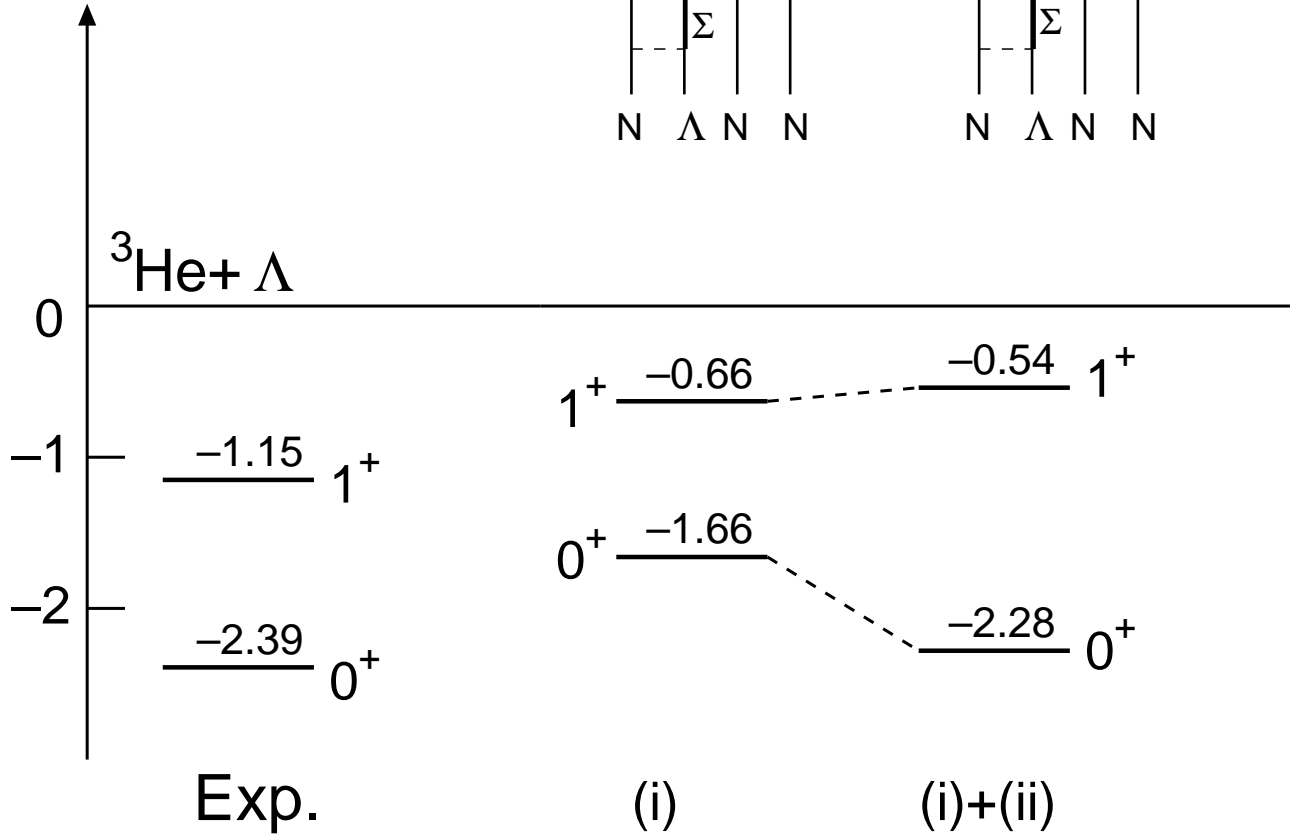

${}^4_{\Lambda}\text{He}$

(b)

