

Polarization Phenomena in Hadronic and Nuclear Processes in Threshold Regime

Egle Tomasi-Gustafsson and Michail P. Rekalo

October 24, 2018

Contents

1	Introduction	3
2	General Properties of Polarization Phenomena for Hadronic and Nuclear Physics at Threshold	4
2.1	Description of polarization properties of fermions, bosons and photons	4
2.2	Parametrization of the spin structure of the matrix elements . . .	8
2.3	Polarization observables	11
3	Application to Hadronic Interaction	16
3.1	The η -meson production in NN-Collisions	16
3.1.1	Polarization phenomena for the S-state η -production in the reactions $N + N \rightarrow N + N + \eta$	16
3.1.2	P -wave contributions to $N + N \rightarrow N + N + \eta$	19
3.2	Production of vector mesons in NN-Collisions	22
3.3	Production of isoscalar vector mesons: $n + p \rightarrow n + p + \phi(\omega)$. . .	25
3.4	Production of strange particles in NN-collisions	27
3.4.1	Threshold theorems	27
3.4.2	Spin structure of threshold amplitudes for $p + p \rightarrow Y + K + N$ processes	29
3.4.3	Polarization phenomena in the reactions $p + p \rightarrow Y + K + N$	30
3.4.4	Hyperon production in np - collisions	32
3.5	Processes $n + p \rightarrow d + \eta$ (π^0) and $n + p \rightarrow d + V^0$ and test of isotopic invariance of strong interaction	33
3.5.1	The reactions $n + p \rightarrow d + \eta$ and $n + p \rightarrow d + \pi^0$	33
3.5.2	The processes $n + p \rightarrow d + V^0$ and $p + p \rightarrow d + \rho^+$	34
3.5.3	Threshold amplitudes for $n + p \rightarrow d + \omega(\phi)$	35
3.5.4	Polarization effects in $n + p \rightarrow d + \omega(\phi)$	36
3.5.5	The process $N + N \rightarrow d + \rho$	37
3.5.6	Test of isotopic invariance through polarization observables in $n + p \rightarrow d + V$ -processes	39

4	Application to Nuclear Interaction	42
4.1	Processes $d + {}^3\text{He} \rightarrow {}^4\text{He} + p$, $d + d \rightarrow {}^3\text{He} + n$ and thermonuclear fusion	42
4.2	The complete experiment for the reaction $d + {}^3\text{H}({}^3\text{He}) \rightarrow n(p) + {}^4\text{He}$	43
4.2.1	Introductory remarks	43
4.2.2	Spin structure of the matrix element	44
4.2.3	Helicity amplitudes	46
4.2.4	Collision of polarized particles	47
4.2.5	Polarization of neutrons in $\vec{d} + {}^3\vec{\text{H}}$ collisions	52
4.3	Processes $d + d \rightarrow n + {}^3\text{He}$ and $d + d \rightarrow p + {}^3\text{H}$	55
4.3.1	Partial amplitudes	57
4.3.2	Helicity amplitudes	58
4.3.3	Angular dependence for collisions of polarized deuterons	59
4.3.4	Complete experiment for $d + d \rightarrow n + {}^3\text{He}$	61
5	Polarization phenomena in astrophysical processes	65
5.1	Low energy polarized collisions and astrophysics	65
5.2	The reaction $p + p \rightarrow d + e^+ + \nu_e$	67
5.3	The big-bang and the reaction $n + p \rightarrow d + \gamma$	67
5.4	Radiative capture of nucleons by deuterons	69
5.5	Magnetic field and Polarization	70
6	Conclusions	76
5	Bibliography	78

Chapter 1

Introduction

The threshold region for processes of hadronic and nuclear interactions is very interesting from a theoretical as well as an experimental point of view.

In this region one can apply different physical approaches, starting from classical current algebra methods for processes involving soft pions, through effective Lagrangian considerations or perturbative chiral symmetry theory (ChPT). In particular ChPT has been very successful in explaining the last exciting results about pion photo and electroproduction on nucleons near threshold [1].

The essential simplification of the spin structure of matrix elements for threshold regime results in better understanding of the underlying mechanisms and allows a transparent analysis of polarization phenomena. The reason of this simplification is the presence, in threshold conditions, of a single independent physical direction, related to the initial momentum. Therefore the analysis of polarization effects near threshold, with evident axial symmetry, cannot be considered as a limiting case of a general formalism, which applies to binary collisions, where the scattering plane is well defined, but a dedicated formalism has to be especially derived.

Such formalism is developed here for a wide class of processes including non-binary processes as the production of pseudoscalar and vector mesons in nucleon-nucleon collisions. The study of these processes allows to afford many interesting physical problems: hidden strangeness of nucleons and OZI-violation, ηN - and ωN - interactions in S-state, determination of P-parity of strange particles, identification of reaction mechanisms etc.

Special attention we devote here to the analysis of the spin structure and polarization phenomena for nuclear processes with light nuclei which have important applications in fundamental astrophysics and in nuclear fusion.

Chapter 2

General Properties of Polarization Phenomena for Hadronic and Nuclear Physics at Threshold

2.1 Description of polarization properties of fermions, bosons and photons

The most prominent feature of the threshold physics is the production of final particles in S -state with zero three-momentum in the center of mass (CMS)¹. The notion of angular momentum, orbital and total, can be exactly defined only in CMS. Therefore the following analysis will be derived in the CMS of all considered processes.

The description of the polarization properties of the different particles (with spin) involved in reactions at threshold is essentially simplified. The exact description of all the observables can be done nonrelativistically, all particles having zero (or relatively) small velocity. Therefore the complex relativistic description of spin is equivalent, here, to the nonrelativistic one.

This holds for spin $1/2$, 1 and $3/2$, as we show in the following lines.

Spin $1/2$. The relativistic description of the polarization properties of fermions with spin $1/2$ is based on the formalism of four-component Dirac spinors, $u(p)$, where p is the particle four-momentum. Using the Dirac equation in the standard form:

$$(\hat{p} - M)u(p) = 0, \quad \hat{p} = p_\mu \gamma_\mu,$$

¹ Let us note that there are a few examples where the S-state production at threshold is forbidden, for example the process $\gamma + \pi \rightarrow \pi + \pi$ or $\gamma + {}^4\text{He} \rightarrow {}^4\text{He} + \pi^0$. Due to angular momentum and P-parity conservation, only P-wave meson production is allowed.

where M is the fermion mass and γ_μ are the Dirac matrixes, one can find the following representation for the Dirac spinors $u(p)$ in terms of the two-component spinor ϕ :

$$u(p) = \sqrt{E + M} \begin{pmatrix} \phi \\ \frac{\vec{\sigma} \cdot \vec{p}}{E + M} \phi \end{pmatrix}$$

with the relativistic normalization: $u^\dagger u = 2E$, and $\phi^\dagger \phi = 1$; $p = (E, \vec{p})$, so E is the energy of the particle, \vec{p} is the three-momentum $E^2 - \vec{p}^2 = M^2$ (for a free particle).

At threshold, $\vec{p} = 0$, $u(p) \rightarrow \phi$, i.e. the two-component spinor ϕ fully describes a spin 1/2 particle.

The density matrix, corresponding to the two-spinor ϕ has the following form:

$$\phi_i \phi_j^\dagger = \frac{1}{2} (\mathcal{I} + \vec{\sigma} \cdot \vec{P})_{ij}, \quad i, j = 1, 2,$$

where \vec{P} is the vector (more exactly the axial vector or pseudovector) of the fermion polarization, $\sigma_a = \sigma_x, \sigma_y, \sigma_z$ are the standard Pauli matrixes:

$$\sigma_x = \begin{pmatrix} 0 & 1 \\ 1 & 0 \end{pmatrix}, \quad \sigma_y = \begin{pmatrix} 0 & -i \\ i & 0 \end{pmatrix}, \quad \sigma_z = \begin{pmatrix} 1 & 0 \\ 0 & -1 \end{pmatrix},$$

with the following useful properties:

$$\sigma_a \sigma_b = \delta_{ab} + i \epsilon_{abc} \sigma_c, \quad \sigma_a^\dagger = \sigma_a, \quad (a, b, c = x, y, z)$$

and ϵ_{abc} is the absolute antisymmetric unit tensor, so that $\epsilon_{xyz} = 1$.

Note that the \vec{P} -vector is odd under time-inversion (T-transformation) and even under space-inversion (P-transformation).

Spin 1. The relativistic description of particles with spin 1 (i.e. the vector particles) involves the four -polarization vector, U_α , $\alpha = x, y, z$ and 0, with the additional relation:

$$U \cdot p = 0.$$

At threshold this relation can be written:

$$U_0 M = 0, \quad \text{i.e. } U_0 = 0,$$

$$U_\alpha \rightarrow U_a, \quad a = x, y, z.$$

Here the complete physical information is contained in the three-vector \vec{U} .

The density matrix for any vector particle, ρ_{ab} can be defined as:

$$\rho_{ab} = U_a^* U_b.$$

This expression holds for stable particles, like the deuteron, as well as for unstable particles like vector mesons (ρ , ω or ϕ). However in case of deuteron, with positive

parity, the corresponding three-vector, \vec{U} , has to be considered as an axial vector, whereas for vector mesons, (which have negative parity), \vec{U} is an usual (polar) vector.

The density matrix ρ_{ab} can be parametrized in different and equivalent ways. For stable particles, it is expressed in terms of the vector (S_a) and the tensor (Q_{ab}) polarizations as follows:

$$\rho_{ab} = \frac{1}{3} \left(\delta_{ab} - \frac{i}{2} \epsilon_{abc} S_c - Q_{ab} \right), \quad Q_{ab} = Q_{ba}, \quad Q_{aa} = 0, \quad (2.1)$$

therefore $\rho_{aa} = 1$.

Different experimental methods exist, to measure the components of the vector and tensor deuteron polarization [2], according to the energy of the scattered deuteron.

The expression (2.1) can be applied, in principle, to unstable vector particles, also, but the vector and tensor polarizations, for these particles, are directly measured through the analysis of the angular distribution of their decay products. One can show that this angular distribution is related to the different elements of the density matrix, ρ_{ab} :

$$S_a = i \epsilon_{abc} \rho_{bc}, \quad (2.2)$$

$$Q_{ab} = -\frac{1}{2} [\rho_{ab} + \rho_{ba} - 2\delta_{ab}]. \quad (2.3)$$

These two descriptions (one in terms of ρ_{ab} and the other in terms of S_a and Q_{ab}) are equivalent, but for unstable particles one derives directly the elements of the density matrix.

As an example let us consider a binary process for vector particle production, $1 + 2 \rightarrow 3 + V$, where 1, 2 and 3 are particles (nucleons etc..) and V a vector meson: $V = \rho, \omega, \phi, J/\psi$.. The density matrix can be parametrized in the following general form which is valid (in case of unpolarized particles) for any reaction and reaction mechanism (for P-invariant interactions):

$$\begin{aligned} \rho_{ab} &= \rho_1 \hat{m}_a \hat{m}_b + \rho_2 \hat{n}_a \hat{n}_b + \rho_3 \hat{k}_a \hat{k}_b \\ &\quad + \rho_4 (\hat{n}_a \hat{k}_b + \hat{m}_b \hat{k}_a) + i \rho_5 (\hat{m}_a \hat{k}_b - \hat{m}_b \hat{k}_a), \\ \hat{n} &= \vec{k} \times \vec{q} / |\vec{k} \times \vec{q}|, \quad \hat{k} = \vec{k} / |\vec{k}|, \quad \hat{m} = \hat{n} \times \hat{k}, \end{aligned}$$

where \vec{k} and \vec{q} are the three-momenta of particles 1 and 3 in the CMS of the considered reaction, $\rho_i = \rho_i(s, t)$, $i = 1 - 5$, are the real structure functions, depending on the two Mandelstam variables s and t . These structure functions determine the angular distribution of the decay products of the vector meson. As an example for the decays $\rho \rightarrow \pi\pi$ and $\phi \rightarrow K\bar{K}$ one finds:

$$\begin{aligned} W(\theta, \phi) &= \frac{1 - \cos^2 \theta}{2} - \rho_3 \left(\frac{1 - 3 \cos^2 \theta}{2} \right) \\ &\quad + \frac{1}{2} (\rho_1 - \rho_2) \sin^2 \theta \cos 2\phi + \rho_4 \sin 2\theta \cos \phi, \quad (2.4) \end{aligned}$$

where θ and ϕ the polar and azimuthal angles of the pseudoscalar meson P_1 in the decay $V \rightarrow P_1 + P_2$ (in the rest frame of the decaying V-meson). We use here the normalization condition:

$$\rho_{aa} = \rho_{11} + \rho_{22} + \rho_{33} = 1, \quad \text{i.e } \rho_1 + \rho_2 + \rho_3 = 1. \quad (2.5)$$

Eq. (2.4) shows that the measurement of θ - and ϕ -dependences of the decay products in $V \rightarrow P_1 + P_2$ allows to determine, in the general case, the SFs $\rho_1, \rho_2, \rho_3,$ and ρ_4 , which characterize the symmetric part of the density matrix for the vector mesons.

However the SF ρ_5 , which is related to the antisymmetric part of the density matrix, can not be determined in this way. This is an important point for the analysis of the polarization properties of vector mesons through their decays. The main decays of the vector mesons, such as:

$$V \rightarrow P + P, P + \gamma, \ell^+ + \ell^-, PPP, V_1 + P, \dots \quad (2.6)$$

are driven by strong and electromagnetic interactions with conservation of P -parity². As a result, an analysis of the spin structure of the matrix elements of the processes (2.6) shows that the presence of a single interaction constant for each of such decays, can not induce T-odd correlations, which play an essential role in the measurement of the vector polarization of V -mesons. Therefore, none of the decays (2.6) can give access to the antisymmetric part of the corresponding density matrix.

Spin 3/2 The relativistic description of particles with spin 3/2, (for example the Δ isobar), in terms of a four-component Dirac spinor with vector index $U_\mu(p)$ can be reduced, in near threshold conditions, into a two-component spinor, with three vector indexes:

$$U_\mu(p) \rightarrow \chi_a, \quad a = x, y, z$$

with the important constrain: $\vec{\sigma} \cdot \vec{\chi} = 0$. Summing over the polarization states gives for the density matrix:

$$\rho_{ab}(3/2) = \overline{\chi_a^\dagger} \chi_b = \frac{2}{3} \left(\delta_{ab} - \frac{i}{2} \epsilon_{abc} \sigma_c \right).$$

Photon Real photons are vector particles, with zero mass, therefore their polarization properties are described in a particular way. The polarization can be characterized by the three-vector \vec{e} , which satisfies the Lorentz condition: $\vec{e} \cdot \vec{k} = 0$, where \hat{k} is the unit vector along the photon three-momentum. The sum over the photon polarizations is given by:

$$\sum_{i=1,2} e_a^{(i)*} e_b^{(i)} = \delta_{ab} - \hat{k}_a \hat{k}_b,$$

²This differs, for example, from the decay $\Lambda \rightarrow p\pi^-$ which is driven by the weak interaction with strong violation of P -invariance. The Λ -hyperon (spin 1/2 particle) is a self-analyzing particle: its vector polarization can be determined from the decay angular distribution.

where the upper index i numerates the two possible independent polarization vectors of the photon.

The proton states with definite value of the total angular momentum j are classified in two groups: electric (Ej) and magnetic (Mj) types - with different values of P -parity: $(-1)^j$ for the electric type and $(-1)^{j+1}$ for the magnetic type.

In threshold conditions, for photoproduction processes, $\gamma + a \rightarrow b + c$, or radiative capture, $a + b \rightarrow c + \gamma$, the photon can be characterized by the smallest value of j . In this case we can easily write the corresponding combinations of polarization \vec{e} and unit vector \hat{k} for the photon states with low multipolarity:

$$\begin{aligned}
 \vec{e} &\rightarrow E1 \text{ (electric dipole),} \\
 \vec{e} \times \hat{k} &\rightarrow M1 \text{ (magnetic dipole),} \\
 e_a \hat{k}_b + e_b \hat{k}_a \equiv E_{ab} &\rightarrow E2 \text{ (electric quadrupole),} \\
 (\vec{e} \times \hat{k})_a \hat{k}_b + (\vec{e} \times \hat{k})_b \hat{k}_a \equiv M_{ab} &\rightarrow M2 \text{ (magnetic quadrupole).}
 \end{aligned}$$

These are the basic formulas for the construction of the matrix elements for electromagnetic processes (in near threshold conditions).

2.2 Parametrization of the spin structure of the matrix elements

Using the formalism presented in the previous section, we can write in a direct way the matrix element for any threshold process, in a general form, using only the symmetry properties of the strong and the electromagnetic interactions. This problem can be exactly solved without any dependence of reaction mechanism.

Let us recall the most important symmetry principles of fundamental interactions which allow us to establish the spin structure of the matrix element:

- Isotropy of space (conservation of total angular momentum).
- Invariance of relative inversion of the space coordinates (P-transformation and P-invariance).
- The gauge invariance (in case of photoproduction processes, or radiative capture reactions).
- The Pauli principle for identical fermions.
- Isotopic invariance of the strong interaction and generalized Pauli principle (for non-identical fermions like n and p).

- Invariance under charge conjugation (C-invariance)

The first step in the determination of the spin structure of the matrix element for threshold processes, is the analysis of the possible multipole (for processes involving photons) or partial transitions, which are allowed for the considered process by the above mentioned symmetry properties.

From our previous discussion it follows that, at threshold, the most general form of the matrix element can contain only one three-momentum \vec{k} (in necessary combinations with the polarization vectors of V -mesons, photons, two-component spinors and σ -matrixes), which is the momentum of the initial state, in case of nonzero threshold energy, or the momentum in the final state for the capture or the annihilation processes at rest.

The degree of this three-vector \vec{k} is directly related to the value of the orbital angular momentum of colliding particles or the multiplicity of the photon : the zero degree in \vec{k} describes the interaction of the initial particles in S -state, the first degree in P -state, the second degree in D -state etc..

We illustrate this procedure on few typical examples: $p + d \rightarrow {}^3He + \pi^0$ and $\pi + N \rightarrow N + V$ (strong interaction) and $\gamma + N \rightarrow N + V$ (vector meson photoproduction on the nucleon in the threshold region).

For $p + d \rightarrow {}^3He + \pi^0$ the spin and parity of the particles are $1/2^+ + 1^+ \rightarrow 1/2^+ + 0^-$. Therefore at threshold (π^0 is produced in S -state) only one value of total angular momentum and P-parity is allowed, $\mathcal{J}^P = 1/2^-$ for the final state. Due to the conservation of the total angular momentum and P-parity (P-invariance of the strong interaction) the spin and parity of the initial state has also to be $\mathcal{J}^P = 1/2^-$. Therefore the orbital angular momentum of the colliding $p + d$ -system must be equal to 1: $\ell_i = 1$, and the following partial transitions are allowed:

$$S_i = 1/2, \quad \ell_i = 1 \rightarrow \mathcal{J}^P = 1/2^-; \quad S_i = 3/2, \quad \ell_i = 1 \rightarrow \mathcal{J}^P = 1/2^-,$$

where S_i is the total spin of the $p + d$ -system.

The resulting threshold matrix element can be written as:

$$\mathcal{M}(d + p \rightarrow {}^3He + \pi^0) = \chi_2^\dagger \left(i f_1 \hat{k} \cdot \vec{D} + f_2 \vec{\sigma} \cdot \hat{k} \times \vec{D} \right) \chi_1, \quad (2.7)$$

where χ_1 and χ_2 are the two-component spinors of the initial proton and the produced nucleus 3He , \vec{D} is the polarization vector of the deuteron, f_1 and f_2 are the partial amplitudes of the considered process, which are complex functions of the excitation energy.

Their linear combinations give origine to the partial amplitudes with a definite value of the initial total spin S_i . Let's build the two possible initial states with $S_i = 1/2$ and $S_i = 3/2$:

$$\vec{\psi}_{3/2} = (-2i\vec{D} + \vec{\sigma} \times \vec{D})\chi_1, \quad \vec{\psi}_{1/2} = (i\vec{D} + \vec{\sigma} \times \vec{D})\chi_1, \quad (2.8)$$

with the following properties:

- $\vec{\sigma} \cdot \vec{\psi}_{3/2} = 0$: necessary condition for spin 3/2;
 - $\vec{\psi}_{1/2}^\dagger \cdot \vec{\psi}_{3/2} = 0$: orthogonality of states with different values of S_i .
- Comparing Eqs. (2.7) and (2.8) one can find:

$$\begin{aligned} f_1 &= f_{1/2} - 2f_{3/2}, \\ f_2 &= f_{1/2} + 2f_{3/2}, \end{aligned}$$

where $f_{1/2}$ and $f_{3/2}$ are the partial amplitudes corresponding to $S_i = 1/2$ and $S_i = 3/2$.

The parametrization (2.7) of the spin structure of the threshold matrix element for the process $p + d \rightarrow {}^3\text{He} + \pi^0$ holds for any reaction mechanism and for any theoretical model which can be used to describe the amplitudes.

The process of threshold vector production in πN -collisions, $\pi + N \rightarrow N + V$, has the same combination of spins of interacting particles, but different P-parities: $0^- + 1/2^+ \rightarrow 1/2^+ + 1^-$, which induce a different matrix element. The S-state production implies: $\mathcal{J}^P = 1/2^-$ and $\mathcal{J}^P = 3/2^-$, with the two following partial transitions:

$$S_i = 1/2, \quad \ell_i = 0 \rightarrow \mathcal{J}^P = 1/2^-; \quad S_i = 1/2, \quad \ell_i = 2 \rightarrow \mathcal{J}^P = 3/2^-,$$

i.e. due to P-parity conservation, two different values of initial orbital momentum, $\ell_i = 0$ and $\ell_i = 2$ contribute. So the resulting matrix element can be written as follows:

$$\mathcal{M}_{th}(\pi N \rightarrow NV) = \chi_2^\dagger \left(\vec{\sigma} \cdot \vec{U}^* g_1 + \vec{\sigma} \cdot \hat{k} \hat{k} \cdot \vec{U}^* g_2 \right) \chi_1,$$

where χ_1 and χ_2 are the two-component spinors of the initial and final nucleons, \vec{U} is the three-vector polarization of the V -meson, g_1 and g_2 are the partial amplitudes for the considered process.

As a state with orbital momentum $\ell = 2$ can be described by a traceless and symmetrical tensor: $\ell_{ab} = \hat{k}_a \hat{k}_b - 1/3 \delta_{ab}$, the partial amplitudes corresponding to $\ell = 0$ and $\ell = 2$, $g^{(0)}$ and $g^{(2)}$, are defined as follows:

$$g^{(0)} = g_1 + \frac{1}{3}g_2, \quad g^{(2)} = g_2.$$

This procedure can be applied to the spin structure of any process of strong interaction.

Let us consider, now, as an example, an electromagnetic process: the threshold photoproduction of vector mesons on the nucleons, $\gamma + N \rightarrow N + V$. There are two possible final states, corresponding to $\mathcal{J}^P = 1/2^-$ and $\mathcal{J}^P = 3/2^-$. The conservation of angular momentum and P-parity allows the following multipole transitions:

$$\begin{aligned} E1 &\rightarrow \mathcal{J}^P = 1/2^-, \\ &\rightarrow \mathcal{J}^P = 3/2^-, \\ M2 &\rightarrow \mathcal{J}^P = 3/2^-, \end{aligned} \tag{2.9}$$

i.e. the threshold matrix element has to contain three different combinations of polarization vectors \vec{e} and \vec{U} :

$$\mathcal{M} = \chi_2^\dagger \left[i\vec{e} \cdot \vec{U}^* f_1 + \vec{\sigma} \cdot \vec{e} \times \vec{U}^* f_2 + \left(\vec{\sigma} \cdot \hat{k} \vec{U}^* \cdot \vec{e} \times \hat{k} + \vec{\sigma} \cdot \vec{e} \times \hat{k} \vec{U}^* \cdot \hat{k} \right) f_3 \right] \chi_1,$$

where the complex conjugation of \vec{U} means that we are describing the production of the V -meson. The amplitudes f_1 and f_2 , being in zero degree in \hat{k} describe the absorption of electric dipole γ , and correspond respectively to the $\mathcal{J}^P = 1/2^-$ and to the $\mathcal{J}^P = 3/2^-$ transitions. The amplitude f_3 , characterizing a spin structure which is quadratic in \hat{k} , describes the $M2$ absorption.

With the help of formulas (2.8), one can find the following relations between the amplitudes f_i and the multipole amplitudes e_1 , e_3 and m_3 , corresponding to the transitions (2.9): $m_3 = f_3$, $3e_1 = 2f_2 - f_1$, $3e_3 = f_1 + f_2$. The two sets of amplitudes $f_1 - f_3$ from one side and the multipole amplitudes e_1 , e_3 and m_3 from another side, give equivalent descriptions of the spin structure of the threshold matrix element. But from the physical point of view, the multipole amplitudes description seems preferable: the T-invariance of hadron electrodynamics can be expressed in a convenient way namely in terms of these amplitudes, in the form of the rigorous theorem of Christ and Lee [3]. Following this theorem the relative phase of the amplitudes e_3 and m_3 , corresponding to different multiplicities and to the same value of $\mathcal{J}^P = 3/2^-$, must be equal to 0 (or π). We can write:

$$e_1 = |e_1|e^{i\delta_1}, \quad e_3 = |e_3|e^{i\delta_3}, \quad m_3 = |m_3|e^{i\delta_3},$$

where δ_1 and δ_3 are the phases for $\mathcal{J}^P = 1/2^-$ and $\mathcal{J}^P = 3/2^-$.

Therefore all threshold observables for any process $\gamma + N \rightarrow N + V$ are characterized by three moduli of multipole amplitudes and by one relative phase, $\delta_3 - \delta_1$, only. The complete experiment, for the full reconstruction of the spin structure of the matrix element, has to contain three different polarization measurements, in addition to the differential cross section (with unpolarized particles).

2.3 Polarization observables

The main feature of polarization phenomena in the near threshold region is an essential simplification due to the presence of a single physical direction: the three-momentum of the colliding particles. A similar situation occurs for the capture or annihilation processes, in case of two-body reaction, like $\bar{p} + p \rightarrow P + P$, $P + V$, $V + V$ -annihilation (P (V) is a pseudoscalar (vector) meson), or $K^- + p \rightarrow \Lambda + \pi^-$ capture, for example, where the direction of the three-momenta of the final particles is the unique physical vector.

The consequence of such axial symmetry of threshold kinematics is that the standard formalism for the analysis of polarization phenomena [4], which is cur-

rently used for binary processes, in case of general kinematics, has to be fully revised.

The main ingredients of the threshold polarization analysis are the following symmetry properties:

- the axial symmetry of kinematics (i.e. the presence of a single three-momentum results in the absence of a scattering plane);
- the P-invariance of the strong and electromagnetic interactions of hadrons;
- definite transformation properties of vector and tensor polarizations with respect to T- and P-transformations.

Therefore, at threshold, there are rigorous general properties of polarization observables, which can be formulated as follows:

- All T-odd one-spin polarization observables (such as the vector analyzing powers for polarized beam or polarized target and the vector polarization of the final particles) are identically zero for any process and any reaction mechanism.
- The tensor analyzing power \mathcal{T} (for reactions with polarized deuteron beam or polarized deuteron target) is nonzero, and is related to the cross section σ by:

$$\sigma = \sigma_0(1 + \mathcal{T}Q_{ab}\hat{k}_a\hat{k}_b),$$

where σ_0 is the cross section for non-polarized particles.

- The tensor polarization of deuterons, produced in the collisions of unpolarized particles, can be parametrized as follows:

$$Q_{ab} = (\hat{k}_a\hat{k}_b - \frac{1}{3}\delta_{ab})Q,$$

i.e. the tensor Q_{ab} is characterized by a single real quantity, Q , which is function of excitation energy, only.

- The density matrix ρ_{ab} for the vector mesons produced in the collisions of unpolarized particles has the following form:

$$\rho_{ab} = \hat{k}_a\hat{k}_b + \rho(\delta_{ab} - 3\hat{k}_a\hat{k}_b), \quad \rho_{aa} = 1$$

where ρ is a real dynamical parameter, characterizing the angular dependence of the decay products. For $V \rightarrow P + P$ one can find:

$$W(\theta) \simeq 1 + a \cos^2 \theta, \quad a = -3 + \frac{1}{\rho},$$

where θ is the angle between \hat{k} and the three-momentum of the pseudoscalar meson in the rest frame of the V -meson.

- The dependence of the cross section on the vector polarizations \vec{P}_1 and \vec{P}_2 of the colliding particles can be written as:

$$\sigma(P_1, P_2) = \sigma_0 \left(1 + \mathcal{A}_1 \vec{P}_1 \cdot \vec{P}_2 + \mathcal{A}_2 \hat{k} \cdot \vec{P}_1 \hat{k} \cdot \vec{P}_2 \right), \quad (2.10)$$

where the real quantities \mathcal{A}_1 and \mathcal{A}_2 characterize the spin correlation coefficients:

$$C_{zz} = \mathcal{A}_1 + \mathcal{A}_2, \quad C_{xx} = C_{yy} = \mathcal{A}_1,$$

if the z -axis is along the \hat{k} direction.

- The values σ_0 , $\sigma_0 \mathcal{A}_1$, and $\sigma_0 \mathcal{A}_2$, in the case of NN-collisions are related to the cross sections of the NN-interaction in the singlet state (σ_s) and in the triplet state - with two different possible projections of total spin: $\sigma_{t,0}$ ($\lambda = 0$) and $\sigma_{t,1}$ ($\lambda = \pm 1$).

In order to give relations between these two sets of polarization observables, we introduce the following projective operators:

$$\begin{aligned} \Pi_s &= \frac{1 - \vec{P}_1 \cdot \vec{P}_2}{4}, \\ \Pi_{t,1} &= \frac{1 + \hat{k} \cdot \vec{P}_1 \hat{k} \cdot \vec{P}_2}{2}, \\ \Pi_{t,0} &= \frac{1 + \vec{P}_1 \cdot \vec{P}_2 - 2\hat{k} \cdot \vec{P}_1 \hat{k} \cdot \vec{P}_2}{4}. \end{aligned}$$

As a result, the cross section $\sigma(\vec{P}_1, \vec{P}_2)$ can be expressed in terms of σ_s , $\sigma_{t,0}$ and $\sigma_{t,1}$ as:

$$\begin{aligned} \sigma(P_1, P_2) &= \sigma_s \frac{1 - \vec{P}_1 \cdot \vec{P}_2}{4} + \sigma_{t,1} \frac{1 + \hat{k} \cdot \vec{P}_1 \hat{k} \cdot \vec{P}_2}{2} + \\ &\quad \sigma_{t,0} \frac{1 + \vec{P}_1 \cdot \vec{P}_2 - 2\hat{k} \cdot \vec{P}_1 \hat{k} \cdot \vec{P}_2}{4}; \end{aligned}$$

with the relations: $\sigma_0 \mathcal{A}_1 = (-\sigma_s + \sigma_{t,0})/4$; $\sigma_0 \mathcal{A}_2 = (-2\sigma_{t,0} + 2\sigma_{t,1})/4$, and $\sigma_0 = (\sigma_s + \sigma_{t,0} + 2\sigma_{t,1})/4$.

- The collisions of polarized deuteron with polarized nucleon is characterized by the following formula:

$$\sigma(\vec{d} + \vec{p}) = \sigma_0 \left(1 + Q_{ab} \hat{k}_a \hat{k}_b \mathcal{A} + \mathcal{A}_1 \vec{S} \cdot \vec{P} + \mathcal{A}_2 \hat{k} \cdot \vec{S} \hat{k} \cdot \vec{P} + \mathcal{A}_3 \hat{k} \times \vec{P} \cdot \vec{Q} \right),$$

where $Q_a = Q_{ab} \hat{k}_b$ and \vec{S} is the vector deuteron polarization. Note that the \mathcal{A}_3 -contribution is the simplest possible T-odd polarization observable for $\vec{d} + \vec{p}$ -threshold collisions.

- The dependence of the V -meson density matrix on the vector polarization of the beam (or target) can be parametrized as:

$$\rho_{ab}(p) = \rho_{ab}^{(0)} + \rho_{ab}^{(1)},$$

$$\rho_{ab}(1) = i\epsilon_{abc}P_c\rho_1 + i\epsilon_{abc}\hat{k}_c\vec{P}\cdot\hat{k}\rho_2 + \left[\hat{k}_a(\hat{k}\times\vec{P})_b + \hat{k}_b(\hat{k}\times\vec{P})_a \right] \rho_3.$$

The real coefficients ρ_1 and ρ_2 , depending on the reaction mechanism, characterize T-even effects and the coefficient ρ_3 T-odd effects. Note also that only the T-odd contribution to $\rho_{ab}^{(1)}$ (i.e. the SF ρ_3) can be measured through the decays (2.6): the decay $V \rightarrow P + P$ has the following angular dependence: $W(\theta, \phi) \simeq P_x \sin 2\theta \sin \phi$, where θ and ϕ are the polar and azimuthal angles for the decay products, relative to the plane defined by the vectors \hat{k} and \vec{P} , and \vec{P} is in the xz -plane).

- The dependence of the V -meson density matrix on the tensor polarization (beam or target) can be parametrized in the following form:

$$\rho_{ab}(Q) = q_1 Q_{ab} + q_2 \hat{k}_a \hat{k}_b \vec{Q}\cdot\hat{k} + q_3 \delta_{ab} \vec{Q}\cdot\hat{k} + q_4 (Q_a \hat{k}_b + Q_b \hat{k}_a) + iq_5 (Q_a \hat{k}_b - Q_b \hat{k}_a),$$

where $q_1 - q_5$ are real coefficients.

- The dependence of the vector polarization of the final particles on the vector and tensor polarizations of the beam (or target) can be described by the following formula:

$$\vec{P}_f = t_1 \vec{P} + t_2 \hat{k}(\hat{k}\cdot\vec{P}) + t_3 \hat{k}\times\vec{Q},$$

where t_3 is the T-odd correlation of the initial quadrupole polarization and the final vector polarization.

- The dependence of the tensor polarization $Q_{ab}^{(f)}$ of the emitted deuteron on the vector and tensor polarizations of the initial deuteron can be parametrized in the following way:

$$\begin{aligned} Q_{ab}^{(s)} &= i\epsilon_{abc}S_c c_1 + i\epsilon_{abc}\hat{k}_c\hat{k}\cdot\vec{S}c_2 + \\ &+ \left[\hat{k}_a(\hat{k}\times\vec{S})_b + \hat{k}_b(\hat{k}\times\vec{S})_a \right] c_3 + \delta_{ab}\vec{Q}\cdot\hat{k}c_4 + \\ &\hat{k}_a\hat{k}_b\vec{Q}\cdot\hat{k}c_5 + (Q_a\hat{k}_b + Q_b\hat{k}_a)c_6 + (Q_a\hat{k}_b - Q_b\hat{k}_a)c_7 \end{aligned}$$

where the real coefficients c_i determine the corresponding coefficients of polarization transfer from the initial to the final deuteron.

- The polarization of the initial photon in any threshold process $\gamma + a \rightarrow b + c$ can not induce any observable effect. The collisions of linearly polarized photons with any vector polarized target is characterized by the same cross section as collisions of unpolarized particles. Only the collisions of circularly polarized photons with vector polarized target can induce a non-trivial asymmetry: $\sigma(\vec{\gamma}\vec{a}) = \sigma_0(1 + \lambda P_z \mathcal{A})$, where $\lambda = \pm 1$ is the photon helicity, and P_z is the component of the target polarization along the photon three-momentum, and \mathcal{A} is the corresponding asymmetry.

The linear photon polarization manifests itself only in collisions with a tensorially polarized target: $\sigma(\vec{\gamma}\vec{d}) = \sigma_0(1 + Q_{ab}e_a e_b^* \mathcal{A}_q)$.

Finally we can mention that it is possible to describe, in the same formalism, all other more complicated polarization observables, which are present in threshold conditions. The expressions, however, are always simpler in comparison with the case of general kinematics.

Having a definite parametrization of the spin structure of the matrix element of any concrete process, it is possible to find the expressions for all these polarization observables, in terms of the corresponding partial (or multipole) amplitudes.

Chapter 3

Application to Hadronic Interaction

3.1 The η -meson production in NN-Collisions

3.1.1 Polarization phenomena for the S-state η -production in the reactions $N + N \rightarrow N + N + \eta$.

We discuss here the polarization effects in processes of η -production in NN -collisions near threshold:

$$\begin{aligned} p + p &\rightarrow p + p + \eta, \\ n + p &\rightarrow n + p + \eta. \end{aligned} \tag{3.1}$$

There are few experimental data about $\vec{p}\vec{p}$ -collisions [5]. Data exist on the differential and total cross sections with unpolarized particles in the initial and final states, in particular on the energy dependence of the total cross section for $p + p \rightarrow p + p + \eta$ [6, 7, 8].

The cross section of η -production in np -collisions is much larger than in the case of pp -production [9], namely

$$R_\eta = \frac{\sigma(n + p \rightarrow n + p + \eta)}{\sigma(n + p \rightarrow p + p + \eta)} = 10 \pm 2 \quad (5 \pm 1) \text{ at } E_{kin} = 1.3 \text{ (1.5) GeV} \tag{3.2}$$

The standard assumptions [10, 11, 12] about the mechanism of η - production in NN -interactions are based on different models of one-boson exchanges (π , ρ , ω , or η), including the effects of strong final state interaction. In particular, near threshold, the excitation of the $S_{11}(1535)$ -resonance is dominant. The values of R_η in (3.2) can be explained as the result of special interference effects of different contributions to the amplitudes of the corresponding processes: π - and ρ -contributions must interfere constructively in the case of np -collisions and destructively for pp -collisions.

The precise definition of the threshold energy region for the process $N + N \rightarrow N + N + \eta$ is $\ell_1 = \ell_2 = 0$, where ℓ_1 is the orbital angular momentum of the relative motion of the two produced nucleons and ℓ_2 is the orbital momentum of the η -meson relative to the CMS of these two nucleons. As the isotopic structure of the amplitudes for $p + p \rightarrow p + p + \eta$ and $n + p \rightarrow n + p + \eta$ is different, we analyze separately these two processes.

$p + p \rightarrow p + p + \eta$

Taking into account the Pauli principle for the pp -system in the initial and final states, the conservation of the total angular momentum and the conservation of the P -parity, only one partial transition is allowed at threshold:

$$L = 1, S_i(pp) = 1 \rightarrow \mathcal{J}^P = 0^- \rightarrow S_f(pp) = 1, \ell_1 = \ell_2 = 0,$$

where $S_{i,f}(pp)$ is the total spin of both protons in the initial and final states and L is the orbital momentum of the colliding protons. The matrix element corresponding to this transition can be written in the following form (in the CMS of the considered reaction):

$$\mathcal{M}(pp \rightarrow pp\eta) = f_1(\tilde{\chi}_2 \sigma_y \vec{\sigma} \cdot \vec{k} \chi_1) (\chi_4^\dagger \sigma_y \tilde{\chi}_3^\dagger), \quad (3.3)$$

where χ_1 and χ_2 (χ_3 and χ_4) are the two-component spinors of the two incoming (outgoing) protons; \vec{k} is the unit vector along the 3-momentum of the initial proton; f_1 is the S-wave partial amplitude corresponding to the total isotopic spin of the channel equal to 1. In the general case the amplitude f_1 is a complex function depending on three kinematical variables, namely \sqrt{s} , E_p and E_η , where E_p (E_η) is the energy of the produced nucleon (η -meson). A dynamical model is needed to describe this function, but any polarization observable can be calculated without any model, using only the expression (3.3) for the matrix element. It is important to stress that all polarization observables do not depend on these kinematical variables and have an universal character. In particular all polarization observables have the same value for η , η' and for any possible radial excitation of the η -meson.

From Eq. (3.3) it appears that all one-spin polarization observables in the near-threshold region must be zero. as well as the coefficients of polarization transfer. On the other hand the collision of polarized protons (with polarizations \vec{P}_1 and \vec{P}_2) can produce nonzero asymmetries:

$$\frac{d\sigma}{d\omega}(\vec{P}_1, \vec{P}_2) = \left(\frac{d\sigma}{d\omega} \right)_0 (1 + \vec{P}_1 \cdot \vec{P}_2 - 2 \hat{k} \cdot \vec{P}_1 \hat{k} \cdot \vec{P}_2), \quad (3.4)$$

where $\left(\frac{d\sigma}{d\omega} \right)_0$ is the differential cross section with unpolarized particles, $d\omega$ is the

phase space volume of the produced particles, i.e.: $C_{xx} = C_{yy} = 1$, $C_{zz} = -1$, where the z -axis is along \vec{k} .

$$\underline{n + p \rightarrow n + p + \eta}$$

The total isotopic spin of the $n + p$ -system can take two values, $I = 0$ and $I = 1$. The derivation for the case of $I = 1$ is similar to $p + p \rightarrow p + p + \eta$. From the isotopic invariance of the strong interaction it follows that: $f_1^{np} = \frac{1}{2}f_1^{pp} = \frac{1}{2}f_1$. In the case of $I = 0$, the generalized Pauli principle requires the np -system in the final S-state to be in a triplet spin state. The total angular momentum \mathcal{J} and parity P in this channel must be equal to $\mathcal{J}^P = 1^-$. Therefore an additional transition is allowed:

$$L = 1, S_i(np) = 1 \rightarrow \mathcal{J}^P = 1^- \rightarrow S_f(np) = 1, \ell_1 = \ell_2 = 0,$$

with the following matrix element:

$$\mathcal{M}(n + p \rightarrow n + p + \eta) = \frac{1}{2}f_0(\tilde{\chi}_2 \sigma_y \chi_1) (\chi_4^\dagger \vec{\sigma} \cdot \vec{k} \sigma_y \tilde{\chi}_3^\dagger),$$

where f_0 is the amplitude of the singlet interaction of the colliding particles. This amplitude is responsible for the difference in the polarization effects in the two reactions $p + p \rightarrow p + p + \eta$ and $n + p \rightarrow n + p + \eta$.

The parameters \mathcal{A}_1 and \mathcal{A}_2 (for polarized nucleon collisions) depend only on $|f_0|^2$ and $|f_1|^2$:

$$\mathcal{A}_1 = \frac{-|f_0|^2 + |f_1|^2}{|f_0|^2 + |f_1|^2}; \quad \mathcal{A}_2 = \frac{-2|f_1|^2}{|f_0|^2 + |f_1|^2};$$

i.e.

$$-1 \leq \mathcal{A}_1 \leq 1, \quad -2 \leq \mathcal{A}_2 \leq 0.$$

It is important to note that the amplitudes f_0 and f_1 do not interfere in the unpolarized differential cross section:

$$\left(\frac{d\sigma}{d\omega}\right)_0 \simeq |f_0|^2 + |f_1|^2,$$

i.e.

$$R_\eta = \frac{\sigma(n + p \rightarrow p + p + \eta)}{\sigma(p + p \rightarrow p + p + \eta)} = \frac{1}{4} + \frac{1}{4} \frac{|f_0|^2}{|f_1|^2} \geq \frac{1}{4}.$$

Therefore both asymmetries \mathcal{A}_1 and \mathcal{A}_2 can be related to the ratio R of the cross sections for the production processes with unpolarized particles:

$$\mathcal{A}_1 = -1 + \frac{1}{2R_\eta}, \quad \mathcal{A}_2 = -\frac{1}{2R_\eta}.$$

These relations are independent of any models for the description of the $N + N \rightarrow N + N + \eta$ processes and they are valid on the level of the isotopic invariance

of the strong interaction. Using the experimental values of R_η [9], one can predict the following numerical values the asymmetries \mathcal{A}_1 and \mathcal{A}_2 (at two proton kinetic energies):

$$\begin{aligned}\mathcal{A}_1 &= -0.95 \pm 0.01, & \mathcal{A}_2 &= -0.05 \pm 0.01, & E_k &= 1.3 \text{ GeV}, \\ \mathcal{A}_1 &= -0.90 \pm 0.02, & \mathcal{A}_2 &= -0.10 \pm 0.02, & E_k &= 1.5 \text{ GeV}.\end{aligned}$$

From the values of R_η , the singlet amplitude f_0 is much larger than the triplet amplitude f_1 , and shows an evident decrease away from threshold:

$$\frac{|f_0|^2}{|f_1|^2} = 4R_\eta - 1 = 39 \pm 8(19 \pm 8) \text{ at } E_k = 1.3(1.5) \text{ GeV}.$$

Data from CELSIUS [8] confirm this behavior over an energy range extending from 25 up to 115 MeV above threshold.

We can try to interpret this large ratio in terms of the presence of $s\bar{s}$ -quarks in nucleons: the singlet pp -state (with the $s\bar{s}$ -component in a singlet state also) is the most suitable for the production of the pseudoscalar η -meson by analogy with the ϕ -meson production from the triplet state of NN (or $\bar{N}N$)-collisions.

The decrease of the ratio $|f_0|^2/|f_1|^2$ when the energy of the colliding particles increases can be explained as a "dilution" effect [13]. The opening of different channels when the energy increases, in particular the triplet states for np -collisions which does not favor the η -production (or the singlet state in pp -collisions which favors the η -production) leads to a decreasing of the ratio R_η in agreement with the experiment. We do not have at the moment any model to predict quantitatively these effects.

As final remark on polarization effects in the reaction $n + p \rightarrow n + p + \eta$, we note that the relative phase δ of the complex amplitudes f_0 and f_1 can be deduced from the coefficients of polarization transfer from the initial to the final nucleon: $K_z^{z'} \simeq \mathcal{R}e f_0 f_1^* = |f_0||f_1| \cos\delta$. The $\mathcal{I}m f_0 f_1^*$ combination appears only in the T-odd polarization observables for $N + N \rightarrow N + N + \eta$, which, in the near threshold region are at least triple correlations, such as $\vec{S}_1 \times \vec{S}_2 \cdot \vec{S}_3$, or $\vec{S}_1 \times \vec{S}_2 \cdot \hat{k} \vec{S}_3 \cdot \hat{k}$.

3.1.2 P -wave contributions to $N + N \rightarrow N + N + \eta$.

There are two possible combinations of angular momenta, in case of final P -wave production:

$$\begin{aligned}a) & \ell_1 = 1, \quad \ell_2 = 0, \\ b) & \ell_1 = 0, \quad \ell_2 = 1,\end{aligned}$$

whose relative contribution is a function of the energy of the produced particles.

In the reaction $p + p \rightarrow p + p + \eta$, for $\ell_1 = 1, \ell_2 = 0$, the produced pp -system must be in a triplet state, therefore we obtain: $\mathcal{J}^P = 0^+, 1^+$ and 2^+ . The

conservation of \mathcal{J} , P and the Pauli principle allow two transitions:

$$\begin{aligned} S_i(pp) = 0, \quad L = 0 &\rightarrow \mathcal{J}^P = 0^+, \\ S_i(pp) = 0, \quad L = 2 &\rightarrow \mathcal{J}^P = 2^+. \end{aligned}$$

The corresponding matrix elements can be written as:

$$\begin{aligned} p_0 (\tilde{\chi}_2 \sigma_y \chi_1) (\chi_4^\dagger \vec{\sigma} \cdot \vec{m} \sigma_y \tilde{\chi}_3^\dagger), \\ p_2 (\tilde{\chi}_2 \sigma_y \chi_1) \chi_4^\dagger (\sigma_i m_j + \sigma_j m_i - \frac{2}{3} \delta_{ij} \vec{\sigma} \cdot \vec{m}) (k_i k_j - \frac{1}{3} \delta_{ij}) \sigma_y \tilde{\chi}_3^\dagger, \end{aligned} \quad (3.5)$$

where \vec{m} is the unit vector along the 3-momentum of a produced nucleon in the CMS , p_0 and p_2 are the two P -wave amplitudes, which describe the singlet np -interactions in S ($L = 0$)- and D ($L = 2$)-states.

These new amplitudes produce an anisotropy in the angular distribution of the final protons with respect to the angle ψ , where $\cos \psi = \vec{k} \cdot \vec{m}$:

$$\begin{aligned} |p_0|^2 &\rightarrow \text{isotropic angular dependence,} \\ |p_2|^2 &\rightarrow (1 + 3\cos^2\psi) \text{ angular dependence,} \\ \mathcal{Re} p_0 p_2^* &\rightarrow (1 - 3\cos^2\psi) \text{ angular dependence;} \end{aligned}$$

Therefore the presence of a $\cos^2\psi$ -term in $(d\sigma/d\omega)_0$ shows that the amplitude p_2 is different from zero. Nevertheless, for $p + p \rightarrow p + p + \eta$, the knowledge of the polarization observables is necessary for the full reconstruction of the spin structure of the amplitude in the $S + P$ -waves approximation. From Eq. (3.3) and (3.5) we can do the following remarks:

- As the amplitudes of the $S(P)$ -wave production correspond to singlet (triplet) \rightarrow triplet (singlet) transition in the pp -system, no polarization correlation coefficient in the reaction $\vec{p} + \vec{p} \rightarrow p + p + \eta$ contains $S + P$ -interference contributions.
- The analyzing powers in the reaction $p + \vec{p} \rightarrow p + p + \eta$ and the polarizations of any final proton produced in collisions of unpolarized protons must be equal to zero, for any values of the amplitudes f_1 , p_0 , and p_2 .
- To study the $S + P$ -interference, it is necessary to measure the polarization transfer coefficients.

We stress again that these remarks are model-independent as they are based on the most general symmetry properties of the strong interaction.

The P -wave in $p + p \rightarrow p + p + \eta$ corresponds to the singlet pp -interaction of the colliding particles. It would then be responsible for the steep increasing of the cross section observed for this reaction near threshold, if we assume a singlet state preference for η -production.

The other possibility for a P -wave contribution in $p + p \rightarrow p + p + \eta$, i. e. $\ell_1 = 0$, $\ell_2 = 1$ can be analyzed in a similar way. In this case the final pp -system

must be in a singlet state, therefore $\mathcal{J}^P = 1^+$. The P-parity conservation allows only even values of the orbital momentum L for the colliding protons, so from the Pauli principle the initial pp -system must be spin singlet. But for these quantum numbers the state $\mathcal{J}^P = 1^+$ can not be obtained: P -wave η -production is then forbidden in this process.

The situation is different for the process $n + p \rightarrow n + p + \eta$, where the P -wave η -production is possible, for $I = 0$. Then the produced np -system with $\ell_1 = 0$ has to be in a triplet state with $\mathcal{J}^P = 0^+, 1^+$ and 2^+ . Therefore the initial np -system must be also in a triplet state, with $L = 0$ and $L = 2$, i.e. the following transitions are allowed:

$$\begin{aligned} S_i(np) = 1, L = 0 &\rightarrow \mathcal{J}^P = 1^+, \\ S_i(np) = 1, L = 2 &\rightarrow \mathcal{J}^P = 1^+, \\ S_i(np) = 1, L = 2 &\rightarrow \mathcal{J}^P = 2^+. \end{aligned} \tag{3.6}$$

From our analysis (and in agreement with the experimental data) it is shown that the enhancement of the cross section for the η -meson production is directly linked to the presence of a **singlet** state in the initial state of the NN system. When the initial NN state is selected in a triplet state such enhancement is absent.

The main results obtained above can be summarized as follows:

- At threshold the spin structure of the amplitudes for the processes $p + p \rightarrow p + p + \eta$ and $n + p \rightarrow p + p + \eta$ is different: only one amplitude (*triplet*) is present in the first reaction, while in the second reaction two complex amplitudes contribute: f_0 (*singlet*) and f_1 (*triplet*). These amplitudes do not interfere in the differential cross section if the particles in the initial and final state are unpolarized.
- Using the experimental values of the ratio: $R_\eta = \frac{\sigma(n + p \rightarrow n + p + \eta)}{\sigma(p + p \rightarrow p + p + \eta)}$, we found in a model independent way the ratio of singlet and triplet amplitudes for the processes $NN \rightarrow NN\eta$, in the threshold region.
- From the ratio R_η it is possible to predict the values of the spin correlation coefficients \mathcal{A} for the process $\vec{n} + \vec{p} \rightarrow p + p + \eta$ where both the nucleons are polarized: $\mathcal{A}_1 = -0.95 \pm 0.01$ and $\mathcal{A}_2 = -0.05 \pm 0.01$ (at E=1.3 GeV).
- The abnormally large value for the ratio $\frac{|f_0|^2}{|f_1|^2}$ (near the threshold of $NN \rightarrow NN\eta$) is a clear indication that η production is increased in the presence of a singlet state of the NN system. This can be related to the presence of a polarized $s\bar{s}$ -component inside a polarized nucleon.

We would like to stress that the high level of symmetry of the NN state in the threshold η -production induces well defined polarization properties of the colliding nucleons, similarly to the case of $\bar{p}p \rightarrow \phi\pi$ annihilation.

- The decrease of the ratio R_η when the energy of the interacting particles is increasing may be connected to some 'dilution' of the *pure* singlet states in np -collisions and with the appearance of such states in pp -collisions, due to the $P - wave$ production of the η -meson. This behavior could explain the observed steep rising of the cross section for the $p + p \rightarrow p + p + \eta$ reaction near threshold. We predict that the increasing of the cross section for the $n + p \rightarrow n + p + \eta$ reaction has to be slower.

3.2 Production of vector mesons in NN-Collisions

According to the naive quark model, the nucleon (and anti-nucleon) wave function contain only u - and d -quarks (antiquarks) contributions. On the other hand the ϕ -meson is almost a pure $s\bar{s}$ -state. Therefore ϕ -meson production through the disconnected diagram of Fig. 1a is forbidden, contrary to the production of ω -meson whose wave function has essentially no strange component. This is the basis of the so-called OZI rule [14, 15, 16].

Slight violation of the OZI rule, as measured by the ratio $R = \phi X / \omega X$ for production of ω - and ϕ -mesons, have been observed in various reactions ($R \simeq (10 \div 20) \cdot 10^{-3}$), but they may be explained partly by the fact that the mixing angle between the ω - and ϕ -meson is not exactly equal to the ideal one [17], partly due to rescattering effects or multi-step processes [18, 19, 20]; see also discussion in [21]. More recently, much larger violations of the OZI rule have been reported in vector meson production through $\bar{p}p$ -annihilation at rest [22, 23, 24, 25, 26], allowing to formulate the interesting hypothesis of the presence of a large $s\bar{s}$ -component in the nucleon wave function at relatively small momentum transfers [20, 27] (see diagram of Fig. 1b). In particular the abnormal yields of ϕ -meson, ($R \simeq (100 \div 250) \cdot 10^{-3}$) which was observed in the annihilation channels: $\bar{p} + p \rightarrow \phi + \pi^0$, $\bar{p} + p \rightarrow \phi + \gamma$ in liquid targets [23] and $\bar{p} + p \rightarrow \phi + \pi^+ + \pi^-$ [26], are related to the S-wave channel, with no large deviation from the naive OZI prediction in the P-wave annihilation channel. In this case parity conservation and charge conjugation selection rules allow only a spin triplet $p\bar{p}$ -initial state leading to the suggestion [13, 28] that polarization measurements in nucleon and anti-nucleon induced reactions, with polarized colliding particles, could lead to decisive information on the polarization of the possible $s\bar{s}$ -component in the nucleon, which has tentatively been observed in deep inelastic lepton scattering [29].

So it appears very interesting to study polarization effects in different processes of ϕ -meson production, in order to get further evidence of the possible link between the violation of the OZI rule and the polarization states of the interacting particles.

The simplest of such processes is the collision of a polarized proton beam with a polarized proton target: $\vec{p} + \vec{p} \rightarrow p + p + \phi$.

If the spin-triplet mechanism is dominating at threshold, then the ϕ -meson yield should be much larger when the spins of the colliding protons are parallel than when they are antiparallel.

A rather large violation of the OZI rule has also been observed in the ω - and ϕ - production induced by the reaction $d + p \rightarrow {}^3He + \phi(\omega)$. The ratio R of the cross sections for these processes has been found to be [30]:

$$R = \frac{\sigma(d + p \rightarrow {}^3He + \phi)}{\sigma(d + p \rightarrow {}^3He + \omega)} = (11.6 \pm 2.9)\%.$$

Therefore it has been proposed to study ϕ and ω production in the same reaction with polarized beam and target [31]: $\vec{d} + \vec{p} \rightarrow {}^3He + X$, in order to enhance the OZI violation effects since it is supposed that here again the ratio R should be much larger for parallel spin states than for anti-parallel ones.

At the reaction threshold the number of partial waves is greatly reduced, resulting in a simplification of the spin structure of the amplitudes, therefore making the theoretical analysis more transparent. In most cases a general analysis of polarization effects can be carried on, based only on the symmetry properties of strong interaction, such as the P-invariance, the C-invariance and the isotopic invariance, without the need to introduce any additional hypothesis about the reaction mechanism.

On the other hand, the threshold region has some specific problems, connected mainly to the effects of the final state interaction (FSI) of the produced particles, which can modify the simple initial picture of the production mechanism. Corrections to ϕ - and ω -production ratio due to FSI effects can reach one order of magnitude [32]. In spite of these difficulties, data on polarization effects in the near-threshold region can reveal very interesting features, as these effects are usually less sensitive to FSI.

Experiments aiming at measuring ϕ -production reactions induced by polarized protons have been proposed [33] or are being discussed at existing accelerators like the Dubna Accelerator Complex.

We discuss here polarization effects in the reactions: $p(n) + p \rightarrow p(n) + p + V^0$, where V^0 is any neutral vector meson (ω , ϕ or ρ^0), on the basis of the simplifications which appear naturally in the threshold region. In particular we would like to stress that in the case of pp -collisions, the spin structure of the threshold amplitude is so simplified that it can be compared to the $\bar{p}p$ -annihilation (with stopped antiprotons) through the channel $\bar{p} + p \rightarrow \phi + \pi^0$, which shows such a large yield for the triplet state.

In principle the threshold region can be broad: for example, in the reaction $\pi^- + p \rightarrow n + \omega$ the angular distribution of the produced ω -meson is isotropic up to $p_\omega^* = 200 \text{ MeV}/c$, where p_ω^* is the *CMS* momentum of the ω -meson [34, 35].

In the final state of the processes $p + p \rightarrow p + p + V^0$, taking into account the identity of the two produced protons (Pauli principle), the pp -system can be produced only in the singlet state, therefore there is only one possible configuration

for the total angular momentum \mathcal{J} and the parity P , that is $\mathcal{J}^P = 1^-$. In the initial state, due to P -parity conservation, only odd values for the orbital angular momentum L are allowed. As the total wave function has to be antisymmetric, the two colliding protons have to be in a triplet state, $S_i = 1$. Therefore only one possible transition can take place at threshold in the reaction $p + p \rightarrow p + p + V^0$, $L = 1$, $S_i(pp) = 1 \rightarrow \mathcal{J}^P = 1^-$ with matrix element:

$$\mathcal{M} = g_1(\tilde{\chi}_2 \sigma_y \vec{\sigma} \cdot \vec{k} \times \vec{U}^* \chi_1) (\chi_4^\dagger \sigma_y \tilde{\chi}_3^\dagger), \quad (3.7)$$

where \vec{U} is the 3-vector polarization of the produced vector meson and g_1 is the complex amplitude corresponding to the triplet interaction of the colliding particles. The formula (3.7) is universal in the sense that it is valid for any reaction mechanism which conserves the P -parity and does not contradict the Pauli principle.

The most important consequence that follows from (3.7) is that the matrix element of such a complicated process as $p + p \rightarrow p + p + V^0$ is defined by a single amplitude g_1 . All the dynamics of the process is contained in this amplitude and can be calculated in a framework of a definite model. But the spin structure of the total amplitude is established exactly by Eq. (3.7) in terms of the 2-component spinors and the vector polarization \vec{U} . Therefore the polarization effects for any reaction $p + p \rightarrow p + p + V^0$ can be predicted exactly since they do not depend on the specific form of the single amplitude g_1 . Of course, g_1 depends on the nature of the produced meson and in general $g_1^p \neq g_1^\omega \neq g_1^\phi$, so that the differential cross section for the different $p + p \rightarrow p + p + V^0$ processes may be different, but the polarization observables *must be same, independently of the type of vector meson produced*.

Let us illustrate this in the calculation of the spin correlation coefficients in the reaction $\vec{p} + \vec{p} \rightarrow p + p + V^0$, where both protons in the entrance channel are polarized:

$$\sigma(\vec{P}_1, \vec{P}_2) = \sigma_0(1 + \hat{k} \cdot \vec{P}_1 \hat{k} \cdot \vec{P}_2). \quad (3.8)$$

It is easy to see that the corresponding correlation parameter is maximal and equal to +1. This correlation parameter does not contain any information about the dynamics of the considered processes, because Eq. (3.8) is directly derived from the P -invariance of the strong interaction and from the Pauli principle.

From (3.7), it follows that the V^0 -meson can be polarized even in the collision of unpolarized protons: $\rho_{xx} = \rho_{yy} = \frac{1}{2}$, $\rho_{zz} = 0$, when the z -axis is along the initial momentum direction. Moreover the decay $V^0 \rightarrow \ell^+ \ell^-$ (due to the standard one-photon mechanism) follows the angular distribution:

$$W(\theta) \approx 1 + \cos^2\theta, \quad (3.9)$$

where θ is the angle between \vec{k} and the direction of the momentum of one of the leptons (in the system where the V^0 -meson is at rest).

Here we should emphasize that, at threshold, the distribution (3.9) is universal and does not depend on assumptions of any definite mechanism of the process $p + p \rightarrow p + p + V^0$, as it was predicted in [13], where a similar distribution was obtained through the vector current $\bar{s}\gamma_\mu s$ acting between of $s\bar{s}$ -pairs in the proton.

Similarly, for the decays $\phi \rightarrow K + \bar{K}$ and $\rho^0 \rightarrow \pi^+ + \pi^-$, the angular distribution of the produced meson follows a $\sin^2\phi$ -dependence, where ϕ is the angle between the 3-momentum of the pseudoscalar meson (in the system where the V^0 is at rest) and the direction of the momentum of the colliding particles.

3.3 Production of isoscalar vector mesons: $n + p \rightarrow n + p + \phi(\omega)$

The study of polarization effects in $n + p \rightarrow n + p + V^0$ is more complicated in comparison with the reaction $p + p \rightarrow p + p + V^0$. Moreover, for np -collisions it is necessary to treat separately the production of isoscalar (ω and ϕ) and isovector (ρ^0) mesons. This is due to the different isotopic structure of the amplitudes of the processes $n + p \rightarrow n + p + \omega(\phi)$ and $p + p \rightarrow p + p + \omega(\phi)$.

Due to the isotopic invariance in the strong interactions, the spin structure of the amplitudes of the process $n + p \rightarrow n + p + V^0$ with $I = 1$ is described by Eq. (3.7). For $I = 0$, if the final np -state is produced in the S -state, then the usual total spin of this system must be equal to 1 (to satisfy the so-called generalized Pauli principle). This means that the produced $n + p + V^0$ -system can have three values of \mathcal{J}^P : $\mathcal{J}^P = 0^-, 1^-$ and 2^- .

From P -invariance, only odd values of the angular momentum L are allowed for the initial np -system: $L = 1, 3, \dots$. One can then conclude that this system must be in the singlet state, $S_i(np) = 0$. And, finally, the conservation of the total angular momentum results in a single possibility, namely: $S_i(np) = 0, L = 1 \rightarrow \mathcal{J}^P = 1^-$. with the following matrix element \mathcal{M}_0 :

$$\mathcal{M}_0 = \frac{1}{2}g_0(\tilde{\chi}_2 \sigma_y \chi_1)(\chi_4^\dagger \vec{\sigma} \times \vec{U}^* \cdot \vec{k} \sigma_y \tilde{\chi}_3^\dagger), \quad (3.10)$$

where g_0 is the amplitude of the process $n + p \rightarrow n + p + V^0$, which corresponds to np -interaction in the initial singlet state.

So, the process $n + p \rightarrow n + p + \omega(\phi)$ is characterized by two amplitudes, namely g_0 and g_1 . One can see easily that these amplitudes do not interfere in the differential cross-section of the process $n + p \rightarrow n + p + V^0$ (with all unpolarized particles in the initial and final states). Therefore we can obtain the following simple formula for the ratio of the total cross sections:

$$\mathcal{R} = \frac{\sigma(p + p \rightarrow p + p + V^0)}{\sigma(n + p \rightarrow n + p + V^0)} = \frac{4|g_1|^2}{|g_1|^2 + |g_0|^2}. \quad (3.11)$$

In the threshold (or near-threshold) region, this ratio is limited by: $0 \leq \mathcal{R} \leq 4$.

We will see now that the ratio \mathcal{R} (of unpolarized cross sections) contains interesting information on a set of polarization observables for the reaction $n + p \rightarrow n + p + V^0$. For example, \mathcal{A}_1 and \mathcal{A}_2 are two independent spin correlation coefficients, defined only by the moduli square of the amplitudes g_0 and g_1 :

$$\mathcal{A}_1 = -\frac{|g_0|^2}{|g_0|^2 + |g_1|^2}, \quad \mathcal{A}_2 = \frac{|g_1|^2}{|g_0|^2 + |g_1|^2}, \quad (3.12)$$

i.e.

$$\begin{aligned} 0 (g_0 = 0) &\leq -\mathcal{A}_1 \leq 1 (g_1 = 0), \\ 0 (g_1 = 0) &\leq \mathcal{A}_2 \leq 1 (g_0 = 0). \end{aligned} \quad (3.13)$$

One can easily see that these coefficients are related to the ratio \mathcal{R} of the cross sections of pp - and np -processes with unpolarized particles (in the initial and final states) through: $\mathcal{A}_1 = -1 + \mathcal{R}/4$, $\mathcal{A}_2 = \mathcal{R}/4$. But the elements of the density matrix of the V^0 -mesons, produced in $n + p \rightarrow n + p + V^0$, are independent from the relative values of the amplitudes g_0 and g_1 : $\rho_{xx} = \rho_{yy} = \frac{1}{2}$, $\rho_{zz} = 0$.

The interference of the amplitudes g_0 and g_1 appears only in the polarization transfer from the initial to the final nucleons:

$$K_x^{x'} = K_y^{y'} = \frac{-2\mathcal{R}eg_0g_1^*}{|g_0|^2 + |g_1|^2}.$$

Returning now to the process $n+p \rightarrow n+p+\phi$ in connection with the problem of the $s\bar{s}$ -component in the nucleon one can mention that a measurement of the ratio of cross sections for $p + p \rightarrow p + p + \phi$ and $n + p \rightarrow n + p + \phi$, which are directly related to the relative value of the singlet and triplet amplitudes would allow to measure the ratio $\frac{|g_0|^2}{|g_1|^2}$ and confirm the predicted ϕ -production enhancement from the triplet state of the NN -system. Additional information can be obtained from the measurement of spin transfer between the initial and final nucleons.

Starting from a very general analysis, based on the symmetry properties of the strong interaction, namely the validity of the Pauli principle, the P -invariance and the isotopic invariance, we can summarize our results as follows.

- The spin structure of the threshold amplitude of the processes $p + p \rightarrow p + p + V^0$ is defined by a single spin configuration, corresponding to the triplet state of the initial protons. This allows very simple and rigorous predictions for the values of all the polarization observables in these reactions, independently of the role of a $s\bar{s}$ -component in the nucleon.
- The spin structure of the threshold matrix element of the process $n + p \rightarrow n + p + \omega(\phi)$ is defined by two amplitudes, the triplet one, g_1 , (which coincides with the triplet amplitude for the process $p + p \rightarrow p + p + \omega(\phi)$) and the singlet one, g_0 , which is not present in the reaction $p + p \rightarrow p + p + \omega(\phi)$.

- The vector meson density matrix elements are independent from the mechanism of the processes $p+p \rightarrow p+p+V^0$ and $n+p \rightarrow n+p+V^0$, so one can obtain for the collision of unpolarized particles: $\rho_{xx} = \rho_{yy} = \frac{1}{2}$, $\rho_{zz} = 0$. Therefore the $(1 + \cos^2\theta)$ -distribution of the decay products for the $V^0 \rightarrow \ell^+\ell^-$ is a direct consequence of the P-invariance of the strong interaction.

3.4 Production of strange particles in NN-collisions

3.4.1 Threshold theorems

Strange particle production in NN -collisions may also bring interesting information on the possible presence of a polarized $\bar{s}s$ -component in the nucleon, even at relatively small momentum transfer, and on the reaction mechanism. Selection rules applied to the $p+p \rightarrow \Lambda(\Sigma) + K + N$ reactions in the near-threshold energy region, allow only a spin-triplet pp -interaction. In this sense such reactions are similar to $\bar{p}p$ annihilation into a ϕ and a π^0 , where a large yield of ϕ -mesons has been observed which violates strongly the OZI-rule [14, 15, 16].

For hadron interactions as well as for γN - or eN -interactions, many important low-energy theorems (LET) apply in the threshold region. Let us mention some of them:

- the Thomson limit for the amplitudes of low energy Compton scattering by targets with nonzero electric charges. In these processes electromagnetic properties of hadrons such as their electric and magnetic polarizabilities can be measured [36].
- the Kroll-Ruderman theorem [37] predicts the threshold behavior of pion photoproduction amplitudes. This problem became very actual [38] following the experimental results on the $\gamma+p \rightarrow p+\pi^0$ cross section near threshold [39, 40]. New data [41, 42] with tagged photons rise many questions about the limit of validity of the low energy theorems for π^0 -photoproduction.
- predictions of current algebras for the threshold pion production in electron and neutrino scattering by nucleons [43]: $e^- + N \rightarrow e^- + N + \pi$, $e^- + N \rightarrow e^- + \pi + \Delta$, $\nu_e + N \rightarrow e^- + N + \pi$. It is interesting to note that the electroproduction amplitude contains contributions which are proportional to the axial form factors of weak transitions: $W^*+p \rightarrow n$ and $W^*+p \rightarrow \Delta^0$, where W^* is the virtual W^- -boson.
- the value of the σ - term which defines the threshold amplitude for elastic πN scattering can be calculated within LET's. Some discrepancies have been found between the theoretical and experimental values which can be explained by the presence of a $\bar{s}s$ -component in the nucleon.

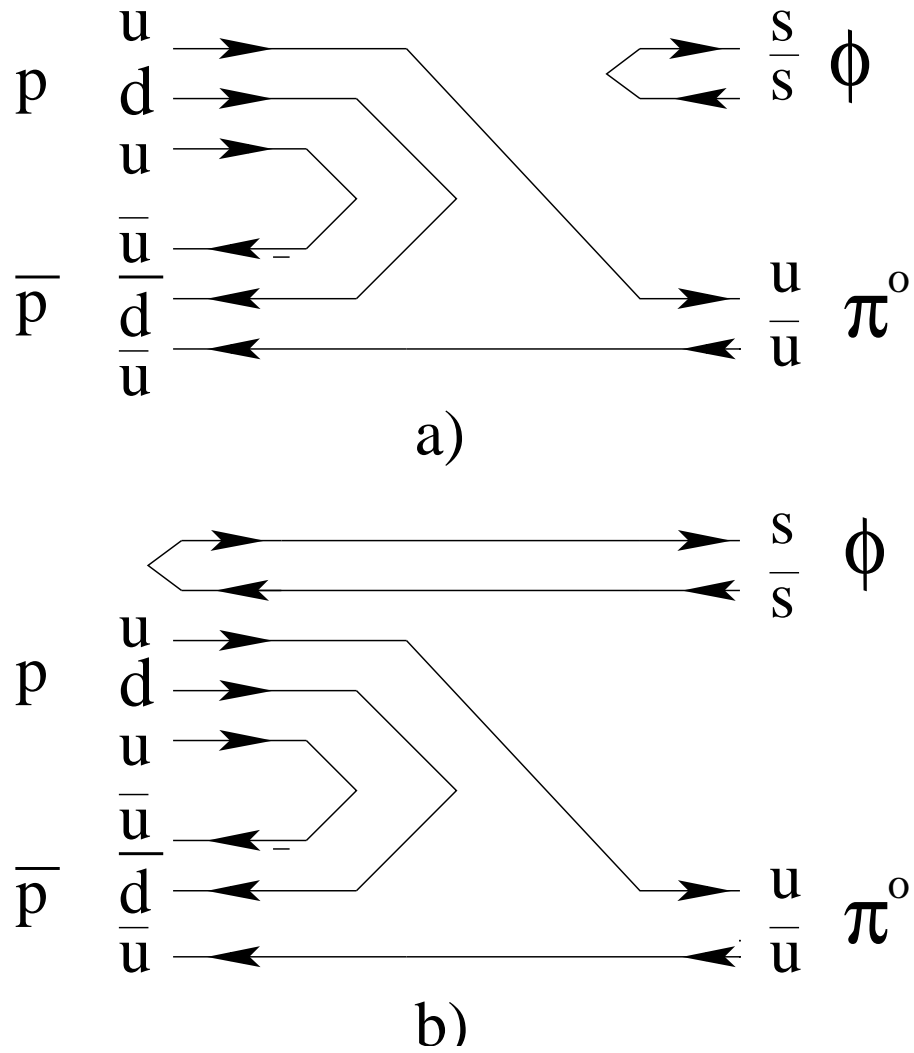

Figure 3.1: a) ϕ -meson production through the disconnected diagram. b) ϕ -meson production by the OZI-allowed process from the $|uuds\bar{s}\rangle$ components of the proton wave function.

- Fundamental characteristics of hadron interactions, such as scattering lengths may be measured in the threshold region. Information [45, 46] about the low energy ΣN - and ΛN - interaction (from near-threshold $p + p \rightarrow K + Y + N$ processes) is important for the reconstruction of the corresponding baryon-baryon potential.

We consider here the polarization effects in threshold production of hyperons in nucleon-nucleon collisions. High intensity polarized proton beams and the detection of the produced hyperons will allow to measure different polarization observables, such as the analyzing powers A (for $\vec{p} + p \rightarrow K + Y + p$), the polarization P_Y of the hyperons produced in the collision of unpolarized protons and the depolarization parameters D_{ab} , which give the dependence of the Y -polarization from the beam polarization [33, 44]. Of course, the numerical values of all these polarization observables can only be predicted in the framework of dynamical models [47, 48, 49, 50, 51, 52], but in the threshold region it is possible to find general expressions for the polarization observables, independently of the reaction mechanism.

Let us mention the recent experimental data about the $p+p \rightarrow \Lambda(\Sigma^0)+K^++p$, in the threshold region, at COSY [53].

3.4.2 Spin structure of threshold amplitudes for $p + p \rightarrow Y + K + N$ processes

The threshold region is again defined as $\ell_1 = \ell_2 = 0$, where ℓ_1 is the orbital momentum of the YN -system and ℓ_2 is the orbital momentum of the K -meson relative to the CMS of the YN system.

Since the P -parity of the kaon is negative (relative to the parity of the NA system), the total angular momentum \mathcal{J} and the parity P of the produced YNK -system at threshold are equal to: $\mathcal{J}^P = 0^-$ and 1^- . From parity conservation it follows that the orbital momentum of the colliding protons, L , must be odd. Then the Pauli principle requires that the initial pp -system must be in a triplet state, $S_i = 1$.

Taking into account the conservation of the total angular momentum, one finds that only two transitions are allowed:

$$S_i = 1, L = 1 \rightarrow \mathcal{J}^P = 0^-,$$

$$S_i = 1, L = 1 \rightarrow \mathcal{J}^P = 1^-.$$

Therefore the spin structure of the matrix element for any process $p + p \rightarrow Y + K + N$ can be written in the following form (in the CMS):

$$\mathcal{M} = f_0(\chi_4^\dagger \sigma_y \tilde{\chi}_3^\dagger)(\tilde{\chi}_2 \sigma_y \vec{\sigma} \cdot \vec{k} \chi_1) + i f_1(\chi_4^\dagger \sigma_a \sigma_y \tilde{\chi}_3^\dagger)(\tilde{\chi}_2 \sigma_y (\vec{\sigma} \times \vec{k})_a \chi_1), \quad (3.14)$$

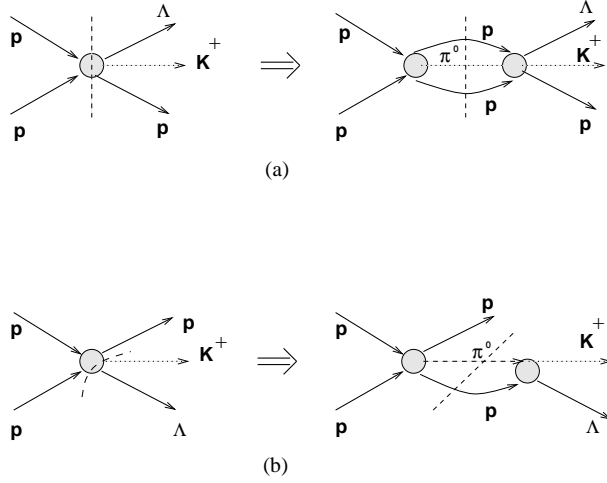

Figure 3.2: Diagrams contributing to the unitarity conditions for $p + p \rightarrow K + N + p$: (a) unitarity condition in s-channel of the process $p + p \rightarrow K + Y + N$; (b) unitarity condition in ΛK^+ -channel.

where χ_1 and χ_2 are the two-component spinors of the colliding protons, χ_3 and χ_4 are the two-component spinors of the final nucleon and the produced hyperon, and f_0 (f_1) is the YN production amplitude in the singlet (triplet) state. In general, the amplitudes f_0 and f_1 are complex functions of three independent variables: the total energy \sqrt{s} of the colliding particles and two energies of the produced particles. Such a complexity results from the unitarity conditions in both channels (Fig. 3.2).

The amplitudes f_0 and f_1 have to be calculated using a dynamical model [47, 48], but polarization effects near threshold can be analyzed without knowing these amplitudes.

3.4.3 Polarization phenomena in the reactions $p + p \rightarrow Y + K + N$

From the spin structure of the matrix element (3.14) we can derive rigorous results for the polarization observables, which are valid for any model of the processes $p + p \rightarrow Y + K + N$.

- The polarization \vec{P}_Y of the hyperons produced in collisions of unpolarized nucleons is zero for any value of the amplitudes f_0 and f_1 . This follows from the S-state nature of threshold YKN -production.
- Due to the orthogonality of singlet and triplet states of the produced YN -system, the analyzing powers in $\vec{p} + p \rightarrow Y + K + N$ and $p + \vec{p} \rightarrow Y + K + N$, must also be zero.

- The spin correlation coefficients \mathcal{A}_1 and \mathcal{A}_2 for collisions where both particles are polarized in the initial state are different from zero:

$$\mathcal{A}_1 = \frac{|f_0|^2}{|f_0|^2 + 2|f_1|^2}, \quad \mathcal{A}_2 = \frac{2(-|f_0|^2 + |f_1|^2)}{|f_0|^2 + 2|f_1|^2}, \quad (3.15)$$

from which one deduces:

$$\begin{aligned} \mathcal{A}_1 &\geq 0, \\ 0(f_0 = 0) &\leq \mathcal{A}_1 \leq 1(f_1 = 0), \\ -1(f_1 = 0) &\leq \mathcal{A}_2 \leq 1(f_0 = 0), \\ 3\mathcal{A}_1 + \mathcal{A}_2 &= 1, \end{aligned} \quad (3.16)$$

One notes that these coefficients are correlated, which results from the pure triplet nature of the initial pp -system. Threshold amplitudes do not interfere in collisions of polarized protons.

The measurement of the differential cross section $(d\sigma/d\omega)_0$ (with unpolarized particles) and of one spin correlation coefficient only (\mathcal{A}_1 or \mathcal{A}_2) allows to determine the moduli of both scalar amplitudes.

The relative phase of the amplitudes f_0 and f_1 can be deduced through a measurement of polarization transfer coefficients from one initial proton to the final hyperon. Starting from the P-invariance of the strong interaction, one can write the following general formula:

$$\begin{aligned} \vec{P}_Y &= \rho_1 \vec{P} + \rho_2 \vec{k} \vec{P} \cdot \vec{k}, \quad (3.17) \\ \rho_1 &= -\frac{2\mathcal{R}e f_0 f_1^*}{|f_0|^2 + 2|f_1|^2}, \quad \rho_2 = 2\frac{|f_1|^2 + \mathcal{R}e f_0 f_1^*}{|f_0|^2 + 2|f_1|^2}. \end{aligned}$$

The complete experiment for any $p + p \rightarrow K + Y + N$ reaction at threshold must then include the following set of measurements:

- the differential cross section $\left(\frac{d\sigma}{d\omega}\right)_0$;
- a spin correlation coefficient \mathcal{A}_1 or \mathcal{A}_2 in the collision of polarized protons;
- a polarization transfer coefficients from the initial proton to the produced hyperon, $K_y^{y'}$ or $K_x^{x'}$.

3.4.4 Hyperon production in np - collisions

In the collision of non-identical particles, the isotopic invariance of strong interaction allows to apply the generalized Pauli principle. Therefore the following analysis is valid up to electromagnetic corrections and other isotopic invariance violation effects. The spin structure for np -collisions corresponding to a total isospin $I = 1$, is the same as for pp -collisions. This part of the amplitude is described in terms of the above mentioned amplitudes f_0 and f_1 , after introducing appropriate Clebsch-Gordan coefficients.

For $I(np) = 0$, the generalized Pauli principle requires the initial np state to be singlet. Therefore a single additional transition is allowed: $S_i = 0$, $L = 1 \rightarrow \mathcal{J}^P = 1^-$, with the corresponding matrix element:

$$\mathcal{M}_0 = g_0(\chi_4^\dagger \vec{\sigma} \cdot \vec{k} \sigma_y \tilde{\chi}_3^\dagger)(\tilde{\chi}_2 \sigma_y \chi_1), \quad (3.18)$$

where g_0 is the S-wave amplitude.

Let us compare the reactions:

$$p + p \rightarrow p + K^+ + \Lambda, \quad n + p \rightarrow p + K^0 + \Lambda.$$

From equations (3.14) and (3.18) one obtains:

$$\frac{\sigma(pp \rightarrow pK^+\Lambda)}{\sigma(np \rightarrow pK^0\Lambda)} = 4 \frac{|f_0|^2 + 2|f_1|^2}{|f_0|^2 + 2|f_1|^2 + |g_0|^2} = \frac{4}{1+r},$$

where σ is the total cross section. The ratio $r = \frac{|g_0|^2}{|f_0|^2 + 2|f_1|^2}$ characterizes the relative strength of the np -interaction in the singlet and triplet states.

The SF's $\mathcal{A}_1^{(np)}$ and $\mathcal{A}_2^{(np)}$ for polarized $\vec{n} + \vec{p}$ collisions are given by:

$$\mathcal{A}_1^{(np)} = \frac{|f_0|^2 - |g_0|^2}{|f_0|^2 + 2|f_1|^2 + |g_0|^2}, \quad \mathcal{A}_2^{(np)} = \frac{2(|f_0|^2 + |f_1|^2)}{|f_0|^2 + 2|f_1|^2 + |g_0|^2},$$

where

$$3\mathcal{A}_1^{(np)} + \mathcal{A}_2^{(np)} - 1 = -\frac{4r}{1+r},$$

which holds for any value of the amplitudes f_0 , f_1 and g_0 . By using two ratios, namely: $\frac{\sigma(pp \rightarrow pK^+\Lambda)}{\sigma(np \rightarrow pK^0\Lambda)}$ (with unpolarized particles), and $\frac{|f_0|^2}{|f_1|^2}$ (from $\vec{p} + \vec{p} \rightarrow K^+ + \Lambda + p$), it is possible to predict $\mathcal{A}_1^{(np)}$ and $\mathcal{A}_2^{(np)}$, for $\vec{n} + \vec{p} \rightarrow n + K^+ + \Lambda$:

$$\mathcal{A}_1^{(np)} = (\mathcal{A}_1 - r)/(1+r), \quad \mathcal{A}_2^{(np)} = \mathcal{A}_2/(1+r).$$

The general formula for the polarization transfer in $\vec{n} + p \rightarrow \vec{Y} + K + N$ is similar to equation (3.17), but with different expressions for the SF's ρ_1 and ρ_2 :

$$\rho_1 = \frac{2\mathcal{R}e(f_0 - g_0)f_1^*}{|f_0|^2 + 2|f_1|^2 + |g_0|^2},$$

$$\rho_2 = -2 \frac{[|f_1|^2 + \text{Re}f_0(f_1 - g_0)^* - \text{Re}g_0f_1^*]}{(|f_0|^2 + 2|f_1|^2 + |g_0|^2)}.$$

So, for S-wave production, each $p + p \rightarrow Y + K + N$ process is described by two independent complex amplitudes which are functions of the energies of the colliding and produced particles. To reconstruct experimentally the complete spin structure of the amplitude it is necessary to measure at least three observables, namely the differential cross section $(d\sigma/d\omega)_0$ (with unpolarized particles), the spin correlation coefficients (i.e. the asymmetry induced by the collision of two polarized protons, $\vec{p} + \vec{p} \rightarrow Y + K + N$), and the polarization transfer from the initial proton to the produced hyperon Y. But for a unique determination of the relative phase of the two complex amplitudes it is necessary to measure at least one T-odd polarization observable. The simplest one is a triple polarization correlation of baryons.

P-wave production results generally in non-zero T-odd polarization effects. They include one-spin polarization observables such as the polarization \vec{P}_Y of the hyperons produced in the collision of unpolarized particles: $p + p \rightarrow K + Y + N$ and the analyzing powers for $\vec{p} + p \rightarrow K + Y + N$ and $p + \vec{p} \rightarrow K + Y + N$. A non-zero value of these observables would be an evidence for a contribution of P- (or higher order-) waves to the production amplitudes.

3.5 Processes $n + p \rightarrow d + \eta$ (π^0) and $n + p \rightarrow d + V^0$ and test of isotopic invariance of strong interaction

3.5.1 The reactions $n + p \rightarrow d + \eta$ and $n + p \rightarrow d + \pi^0$.

The process $n + p \rightarrow d + \eta$ is characterized by a relatively large cross section near threshold [54], which favors the experimental study of the polarization observables. Following the analysis based on the isotopic invariance (and the validity of the generalized Pauli principle), the parity and angular momentum conservation, one can show that the S-wave η -production near threshold for $n + p \rightarrow d + \eta$ is characterized by the single transition: $L = 1$, $S_i(np) = 0 \rightarrow \mathcal{J}^P = 1^-$, with a simple structure of the threshold matrix element:

$$\mathcal{M}(np \rightarrow d\eta) = ig_\eta \vec{D}^* \cdot \vec{k} (\tilde{\chi}_2 \sigma_y \chi_1),$$

where \vec{D} is the spin wave function of the deuteron, g_η is the corresponding production amplitude. The initial np -system is in the singlet state. This might explain the large $n + p \rightarrow d + \eta$ cross-section. Let us mention that the equivalent process for π^0 -production, $n + p \rightarrow d + \pi^0$, is characterized by the np -interaction in the triplet state with another matrix element:

$$\mathcal{M}(np \rightarrow d\pi^0) = g_\pi \tilde{\chi}_2 \sigma_y \vec{\sigma} \times \vec{k} \cdot \vec{D}^* \chi_1.$$

The differential cross section of π^0 production near threshold being lower than the cross section of η -production, one finds again a correlation between the singlet or triplet nature of the colliding np -particles and the probabilities of π^0 - and η -production.

Moreover the polarization observables are different for π^0 - and η -production:

- The dependence of the differential cross section on the polarizations of the colliding nucleons is described by the following formulas:

$$\begin{aligned}\frac{d\sigma}{d\omega}(\vec{P}_1, \vec{P}_2) &= \left(\frac{d\sigma}{d\omega}\right)_0 (1 - \vec{P}_1 \cdot \vec{P}_2), \quad n + p \rightarrow d + \eta, \\ \frac{d\sigma}{d\omega}(\vec{P}_1, \vec{P}_2) &= \left(\frac{d\sigma}{d\omega}\right)_0 (1 + \vec{k} \cdot \vec{P}_1 \vec{k} \cdot \vec{P}_2), \quad n + p \rightarrow d + \pi^0,\end{aligned}$$

i.e. only the longitudinal components of \vec{P}_1 and \vec{P}_2 can contribute to the polarized cross section in the reaction $n + p \rightarrow d + \pi^0$.

- The final deuterons are produced with nonzero tensor polarization even for collisions induced by unpolarized nucleons: longitudinal polarization ($P_{zz} = 1$, where the z -axis is along the vector \vec{k}) in the process $n + p \rightarrow d + \eta$ and transversal polarization in the process $n + p \rightarrow d + \pi^0$. In a similar way it is possible to make predictions for other polarization observables in the processes $n + p \rightarrow d + \pi^0(\eta)$.
- In principle, the experimental large value of the cross section for the process $np \rightarrow d\eta$ near threshold may be directly related to the singlet nature of the initial np system.
- The polarization phenomena for the threshold η -production in NN -collisions can be qualitatively predicted in a model independent form. Polarization phenomena are important to test the validity of $S + P$ approximation and to reconstruct the spin structure of the threshold amplitudes.

3.5.2 The processes $n + p \rightarrow d + V^0$ and $p + p \rightarrow d + \rho^+$

The processes $p + p \rightarrow d + \rho^+$, and $n + p \rightarrow d + V^0$, with $V = \rho, \omega$ or ϕ , are the simplest two-particle reactions of vector meson production in nucleon-nucleon collisions. Near threshold large momentum transfers are associated to these processes, therefore the behavior of the deuteron wave function at small distances is important for its description. As a result the spin structure of the deuteron wave function can be investigated, in principle, at high energies through the study of the process $p + p \rightarrow d + \rho^+$, where the deuteron is produced at zero degrees. Similarly to the backward elastic scattering $d + p \rightarrow p + d$ [55, 56], it is possible to suggest polarization experiments with polarized proton beam and

target and with the measure of the vector and tensor polarizations of the outgoing deuterons. It is possible to measure elements of the density matrix of the vector mesons, also.

The two-particle nature of the $N + N \rightarrow d + V$ processes simplifies the experimental detection and the theoretical interpretation.

3.5.3 Threshold amplitudes for $n + p \rightarrow d + \omega(\phi)$.

The S-wave production of the V^0 -meson induces three possible values of total angular momentum J and P -parity in the channel $n + p \rightarrow d + \omega(\phi)$: $\mathcal{J}^P = 0^-, 1^-$ and 2^- .

Due to the P -parity conservation, the orbital angular momentum L of the colliding n and p must be odd. According to the generalized Pauli principle for the np -system (which is correct at the level of the isotopic invariance of strong interactions) it is easy to show that the $n + p$ -system must be in the singlet spin state only, so only one possible value for L is allowed, namely $L = 1$.

So at threshold only one transition is possible: $S_i(np) = 0, L = 1 \rightarrow \mathcal{J}^P = 1^-$. with matrix element:

$$\mathcal{M} = g(\tilde{\chi}_2 \sigma_y \chi_1) \vec{k} \times \vec{D}^* \cdot \vec{V}^*, \quad (3.19)$$

where χ_1 (χ_2) is the 2-component spinor of neutron (proton), $\vec{D}(\vec{V})$ is the spin wave function of d (V^0), \vec{D} is an axial vector (as the P -parity of the deuteron is positive), \vec{V} is a polar vector; \vec{k} is the unit vector along the initial momentum and g is a partial amplitude corresponding to the S-production of the V^0 -meson.

In order to predict the s -dependence of g , a definite model for the processes $n + p \rightarrow d + V^0$ is necessary, but the analysis of the polarization effects can be easily done without any model for g . This is a consequence of the definite spin structure of the matrix element of this reaction, with a single amplitude g . This amplitude is different for different processes, but the polarization phenomena are universal for any process of V^0 -meson production. Such universality applies also to the processes of ω - and ϕ -radial excitation : $\omega', \omega'', \phi', \phi''...$ Moreover all polarization observables do not depend on the energy of the colliding particles (in the threshold region).

The presence of a single amplitude in (3.19) gives very definite predictions for numerical values of polarization observables: all non-zero polarization observables have their maximum values. Therefore the polarization effects near threshold for $n + p \rightarrow d + \omega(\phi)$ do not contain any special information on the dynamics of the reaction : the measurement of the differential cross section with unpolarized particles represents the complete experiment.

3.5.4 Polarization effects in $n + p \rightarrow d + \omega(\phi)$.

We discuss here the properties of polarization observables in the processes $n+p \rightarrow d + V^0$, $V^0 = \omega$ or ϕ starting from the matrix element (3.19).

- The analyzing powers in $\vec{n} + p \rightarrow d + V^0$ and $n + \vec{p} \rightarrow d + V^0$ vanish.
- The vector polarization of deuterons produced in unpolarized particle collision must be zero, but the tensor polarization is different from zero:

$$T_{20} = 1/3,$$

which is correct for any reaction $n + p \rightarrow d + V^0$ and does not depend on the energy of the colliding particles.

- The dependence of the cross section from the polarizations \vec{P}_1 and \vec{P}_2 of the initial nucleons in $\vec{n} + \vec{p} \rightarrow d + V^0$ is written as:

$$\frac{d\sigma}{d\Omega}(\vec{P}_1, \vec{P}_2) = \left(\frac{d\sigma}{d\Omega}\right)_0 (1 - \vec{P}_1 \cdot \vec{P}_2).$$

- V^0 -mesons, produced in collisions of unpolarized nucleons, are polarized with the following nonzero elements of the density matrix (in cartesian coordinates): $\rho_{xx} = \rho_{yy} = \frac{1}{2}$, if the z -axis is along \vec{k} .
- the dependence of the V^0 -meson density matrix from the vector polarization \vec{P} of any initial nucleon can be parametrized at the reaction threshold by the following general form:

$$\rho_{ab} = i\epsilon_{abc}P_c\rho_1 + i\epsilon_{abc}k_c\vec{P} \cdot \vec{k}\rho_2 + (k_a\epsilon_{bcd}k_cP_d + k_b\epsilon_{acd}k_cP_d)\rho_3, \quad (3.20)$$

where ρ_i , $i=1,2,3$ are the corresponding *Structure Functions* (SF), depending only from the energy of the colliding particles.

The SF's ρ_1 and ρ_2 are responsible for the T-even polarization characteristics of the V^0 mesons, and the SF ρ_3 for the T-odd ones. But the antisymmetric part of ρ_{ab} , which characterizes the vector polarization of the produced V^0 - mesons, cannot be measured through the most probable decays of V^0 mesons (see Section 1).

All the previous statements about polarization phenomena in $n + p \rightarrow d + \omega(\phi)$ have a general character and are not related to any hypothesis about $s\bar{s}$ -component in the nucleon. It is possible to deduce the following consequences of this hypothesis to the threshold V^0 -meson production:

- The ϕ -production is suppressed, due to the fact that the S-wave production of the ϕ -meson is possible here from a singlet state only. This means that the $n + p \rightarrow d + \phi$ reaction will not show a large violation of the OZI-rule:

$$\mathcal{R} = \frac{\sigma(n + p \rightarrow d + \phi)}{\sigma(n + p \rightarrow d + \omega)} \simeq \frac{\sigma_p(\bar{p} + p \rightarrow \phi + \pi)}{\sigma_p(\bar{p} + p \rightarrow \omega + \pi)} \simeq 10^{-3}.$$

where $\sigma_p(\bar{p} + p \rightarrow V^0 + \pi^0)$ is the cross section of $\bar{p} + p$ -annihilation from the P-state, i.e. from the singlet state.

- The fact that the S-wave production is negligible may enhance the P-wave contributions near threshold, which are triplet ones for $n + p \rightarrow d + \omega(\phi)$. Such effect can be experimentally evidenced by different methods: observing the angular dependence of the differential cross section, or measuring a nonzero vector polarization of deuterons with unpolarized particles, or nonzero values of analyzing powers for $\bar{n} + p \rightarrow d + V^0$ and $n + \bar{p} \rightarrow d + V^0$.
- Such effects must appear in the process $n + p \rightarrow d + \phi$ earlier than in $n + p \rightarrow d + \omega$. As the thresholds of these processes are different, it is necessary to compare the production at the same value of the invariant energy Q , $Q = \sqrt{s} - m_d - m_V$.

3.5.5 The process $N + N \rightarrow d + \rho$.

The total isotopic spin of the entrance channel is equal to 1. Therefore the generalized Pauli principle (for $n + p \rightarrow d + \rho^0$) or the usual Pauli principle (for $p + p \rightarrow d + \rho^+$) allows triplet initial states in case of S-wave ρ -meson production. As a result we have the following transitions:

$$\begin{aligned} S_i = 1, L = 1 &\rightarrow \mathcal{J}^P = 0^- \quad , \quad S_f = 0, \\ S_i = 1, L = 1 &\rightarrow \mathcal{J}^P = 1^- \quad , \quad S_f = 1, \\ S_i = 1, L = 1 &\rightarrow \mathcal{J}^P = 2^- \quad , \quad S_f = 2, \end{aligned}$$

where $S_i(S_f)$ is the total spin of the initial (final) particles.

The corresponding expressions for the spin structures of these transitions are the following:

$$\begin{aligned} f_0 &: \tilde{\chi}_2 \sigma_y \vec{\sigma} \cdot \vec{k} \chi_1 \vec{D}^* \cdot \vec{V}^*, \\ f_1 &: \tilde{\chi}_2 \sigma_y \vec{\sigma} \times \vec{k} \cdot \vec{D}^* \times \vec{V}^* \chi_1, \\ f_2 &: \tilde{\chi}_2 \sigma_y (\sigma_i k_j + \sigma_j k_i - \frac{2}{3} \delta_{ij} \vec{\sigma} \cdot \vec{k}) \chi_1 (D_i^* V_j^* + D_j^* V_i^* - \frac{2}{3} \delta_{ij} \vec{D}^* \cdot \vec{V}^*), \end{aligned}$$

where f_0, f_1, f_2 are the partial amplitudes corresponding to the $J = 0, 1$ and 2 transitions, respectively. For the calculation of polarization effects we will use an equivalent but more simplified form of the matrix element:

$$\mathcal{M} = \tilde{\chi}_2 \sigma_y [g_0 \vec{\sigma} \cdot \vec{k} \vec{D}^* \cdot \vec{V}^* + g_1 \vec{\sigma} \cdot \vec{D}^* \vec{k} \cdot \vec{V}^* + g_2 \vec{\sigma} \cdot \vec{V}^* \vec{k} \cdot \vec{D}^*] \chi_1,$$

where g_i are the following combinations of f_i :

$$g_0 = f_0 - \frac{4}{3}f_2, \quad g_1 = f_1 + 2f_2, \quad g_2 = -f_1 + 2f_2.$$

More complicated spin structure of \mathcal{M} results in changing polarization effects in the process $N + N \rightarrow d + \rho$. Of course, all one spin T-odd effects in $N + N \rightarrow d + \rho$ must be zero for any values of amplitudes g_i . This is an usual property of the S-wave production. The dependence of the differential cross section on the polarizations \vec{P}_1 and \vec{P}_2 of the colliding nucleons has the standard form, Eq. (2.10), where the coefficients \mathcal{A}_1 and \mathcal{A}_2 are defined by:

$$\mathcal{A}_1 = -\frac{2|g_0|^2 + |g_0 + g_1 + g_2|^2}{2(|g_0|^2 + |g_1|^2 + |g_2|^2) + |g_0 + g_1 + g_2|^2},$$

$$\mathcal{A}_2 = 2\frac{2|g_0|^2 - |g_1|^2 - |g_2|^2 + |g_0 + g_1 + g_2|^2}{2(|g_0|^2 + |g_1|^2 + |g_2|^2) + |g_0 + g_1 + g_2|^2}.$$

However the measurement of the spin correlation coefficients:

$$C_{xx} = C_{yy} = \mathcal{A}_1, \quad C_{zz} = \mathcal{A}_1 + \mathcal{A}_2,$$

does not represent a complete experiment for this reaction. Additional observables are necessary. One of them is T_{20} , the tensor deuteron polarization:

$$T_{20} = -\frac{F_2}{3F_1 + F_2}.$$

with

$$F_1 = |g_0|^2 + |g_1|^2, \quad F_2 = -|g_0|^2 - |g_1|^2 + 2|g_2|^2 + |g_0 + g_1 + g_2|^2.$$

The unpolarized cross section is related to F_1 and F_2 by $(d\sigma/d\Omega)_0 \simeq 3F_1 + F_2$.

The general expression for the density matrix of V^0 , produced in the collision of unpolarized particles, can be written as:

$$\rho_{ab} = \delta_{ab}q_1 + k_a k_b q_2, \quad 3q_1 + q_2 = 1,$$

with

$$q_1 = \frac{|g_0|^2 + |g_2|^2}{2(|g_0|^2 + |g_1|^2 + |g_2|^2) + |g_0 + g_1 + g_2|^2}.$$

The presence of 3 complex amplitudes near threshold of any process $N+N \rightarrow d+\rho$ results in T-odd correlations of the ρ -meson polarization properties with neutron polarization $\vec{n} + p \rightarrow d + \rho^0$, the nonzero SF ρ_3 :

$$\rho_3 \simeq \mathcal{I}m(g_0 g_1^* + g_0 g_2^* + g_1 g_2^*).$$

So, the one and two-spin polarization observables near threshold of the $N + N \rightarrow d + \rho$ give enough independent combinations of g_i amplitudes to realize the complete experiment.

3.5.6 Test of isotopic invariance through polarization observables in $n + p \rightarrow d + V$ -processes

The process $n + p \rightarrow d + V$ is one of those binary reactions, where the colliding particles belong to the same isotopic multiplet and only one value of the total isotopic spin is allowed in the reaction channel. For such reactions the isotopic invariance induces definite properties of symmetry of all the polarization observables relative to the exchange $\cos\theta \rightarrow -\cos\theta$ [57], where θ is the V^0 -meson production angle in the CMS. This means that polarization observables must be odd or even functions of $\cos\theta$. The theorem of Barshay-Temmer [58] about the symmetry of the differential cross-sections relative to $\theta = 90^\circ$ is the simplest example of the above mentioned result. An illustration in nuclear physics is given by the reaction ${}^3\text{He}({}^3\text{H}, d)\alpha$ [59]. The isotopic invariance allows to interchange the ${}^3\text{He}$ and ${}^3\text{H}$, leaving the deuteron and the α -particle unaffected. As a result the charge symmetry implies a symmetry about $\theta = 90^\circ$ of the tensor analyzing powers A_{yy} and A_{xx} and the antisymmetry of the tensor A_{xz} and the vector A_y analyzing powers. Such behavior of the polarization observables is an interesting example of the connection [60] of the polarization effects with the properties of internal symmetries which do not affect the magnitude of a spin vector of any interacting particle. The isotopic invariance of the strong interaction belongs to such symmetries.

The experimental study of polarization effects in the reaction $n + p \rightarrow d + V$ could be important for the search of violations of this invariance. The interpretation of these effects has essentially changed. If earlier it was assumed that only the electromagnetic corrections are responsible for the violation of the isotopic invariance, in the framework of QCD the main mechanism is connected with the difference of u - and d - quark masses, $\Delta = m_d - m_u \neq 0$. Namely the case of $\Delta \geq 0$ explains the signs of the mass difference of particles for all the known isotopic multiplets of hadrons and nuclei. The scale of such effects of the isotopic invariance violation is characterized by the ratios:

$$\frac{m_d - m_u}{\Lambda_{QCD}} \simeq \frac{m_d - m_u}{4\pi f_\pi} \simeq \frac{m_d - m_u}{300 \text{ MeV}},$$

where f_π is a constant of $\pi \rightarrow \mu\nu$ decay. The typical scale of $\simeq 300$ MeV can be thought as arising from a constituent quark mass, bag model energy or quark condensate. Thus the effects of $\Delta \neq 0$ are small, compared to the electromagnetic effects. Therefore the charge symmetry is not perfect and gives a unique opportunity to find the mass difference of u - and d -quarks. The violation of the charge independence of the strong interaction is connected with the explanation of the masses of the fundamental leptons and quarks which is one of the most important problems of the Standard Model.

The most evident observation of charge independence breaking effects occurs in the $\rho^0\omega$ - mixing through a nonzero value of the matrix element $\langle \rho^0 | H | \omega \rangle$,

where H is the QCD Hamiltonian. The difference $m_d - m_u \neq 0$ is the main contribution to $\langle \rho^0 | H | \omega \rangle$. The effects of this matrix element are observed in the process $e^+ + e^- \rightarrow \pi^+ + \pi^-$ through the specific behavior of the pion electromagnetic form factor with the result:

$$\langle \rho^0 | H | \omega \rangle \simeq -4500 \text{ MeV}^2.$$

It is natural to use the exchange of a mixed $\rho\omega$ -meson as mechanism for the charge symmetry breaking nucleon-nucleon forces. But there is a problem of a significant extrapolation of this matrix element which is determined at $q^2 = m_\rho^2$ (q is the momentum transfer) to the region of NN-forces, where the relevant $q^2 (\leq 0)$ are space-like. Some models [61, 62, 63, 64, 65] predict a strong q^2 -dependence of this matrix element, the situation is not clear now and further experiments are needed.

The study of polarization effects in such processes as $n + p \rightarrow d + V^0$ could be important in the search of isotopic invariance violations. It is necessary to mention also that the large momentum transfers realized at the threshold of $n + p \rightarrow d + V^0$ could be interesting in connection with the possible dependence of the difference $\Delta = m_d - m_u$ on the nuclear density and on the momentum transfer. The $\rho\omega$ -mixing can be studied for different regions of momentum transfer: for the space-like momentum through the NN-potentials and for $q^2 = m_\rho^2$ through the link between the $n + p \rightarrow d + \omega$ and $n + p \rightarrow d + \rho^0$ reactions.

The relation between the polarization effects in $n + p \rightarrow d + V$ reactions and the symmetry properties of the strong interaction as the charge independence and in particular with symmetry violations looks as a very attractive and unusual application of polarization physics.

Let us summarize the main results obtained in this section:

- The matrix element of the process $n + p \rightarrow d + \omega(\phi)$ is defined at the threshold, by a single amplitude which correspond to the singlet interaction of the colliding nucleons.
- The dependence of the differential cross section for $\vec{n} + \vec{p} \rightarrow d + \omega(\phi)$ on the polarizations \vec{P}_1 and \vec{P}_2 of the initial nucleons has the following form:

$$\frac{d\sigma}{d\Omega}(\vec{P}_1, \vec{P}_2) = \left(\frac{d\sigma}{d\Omega} \right)_0 (1 - \vec{P}_1 \cdot \vec{P}_2).$$

- The produced particles in $n + p \rightarrow d + \omega(\phi)$ must be polarized (even in the collision of unpolarized nucleons): the deuteron must have a tensor polarization with $T_{20} = 1/3$, the nonzero elements of the V^0 -meson density matrix are $\rho_{xx} = \rho_{yy} = 1/2$. These predictions are universal as they are independent on the type of V^0 -meson and on the energy of the colliding particles in the near-threshold region.

- As the processes $n + p \rightarrow d + V^0$ at the threshold are induced by the singlet np-interaction, there is no large violation of the OZI-rule:

$$\frac{\sigma(n + p \rightarrow d + \phi)}{\sigma(n + p \rightarrow d + \omega)} \simeq 10^{-3}.$$

- The matrix element of ρ production, $n + p \rightarrow d + \rho^0$ and $p + p \rightarrow d + \rho^+$, is described by three independent threshold amplitudes.

Chapter 4

Application to Nuclear Interaction

4.1 Processes $d + {}^3\text{He} \rightarrow {}^4\text{He} + p$, $d + d \rightarrow {}^3\text{He} + n$ and thermonuclear fusion

Nuclear fusion reactions, like $d + d \rightarrow n + {}^3\text{He}$, or $d + {}^3\text{H} \rightarrow n + {}^4\text{He}$, are characterized by a large dependence on the spins of the colliding particles. It has been suggested [66] to use this property in magnetic fusion reactors with polarized nuclear fuel. A magnetic field of about 1 kG can keep the necessary direction of the polarization of the interacting nuclei, during a time which is longer in comparison with the reaction time. Different technical solutions might be used: injection of polarized frozen pellets, or polarized targets for inertial fusion.

The strong dependence of the fusion reaction rates on the polarization states results in an increasing or a decreasing of the cross section (with respect to the unpolarized case), depending on the colliding nuclei polarization directions. These characteristics can be used to optimize a fusion reactor in different ways:

- The possible enhancement of the fusion rates for $\vec{d} + {}^3\vec{H}e$ and the suppression of $\vec{d} + \vec{d}$ -collisions would make this fuel competitive with $d + {}^3H$, as it would, in particular, result in a *clean* reactor.
- The strong anisotropy of the neutron angular dependence in $\vec{d} + {}^3\vec{H}$ -collision helps in optimizing the reactor shielding and the blanket design.
- $\vec{d} + {}^3\vec{H}$ -collisions can be source of intensive monochromatic polarized neutrons, with the choice of the polarization direction.

A precise knowledge of the spin structure of the threshold matrix elements for the processes induced by: $d + {}^3\text{He}$, $d + {}^3\text{H}$, ${}^3\text{He} + {}^3\text{He}$, ${}^3\text{H} + {}^3\text{He}$ -collisions is required. At energies up to 10 keV, which are typical for fusion reactors, the

S-state interaction of the colliding particles dominates and the general analysis of polarization phenomena is essentially simplified.

Our aim is to analyze here in the most general and complete form the reactions relevant to magnetic fusion reactors, with polarized fuel.

The reaction $d + {}^3\text{He} \rightarrow p + {}^4\text{He}$ was considered in detail in [67]. Following that methodology, we will give here the general parametrization of the threshold amplitudes for $d + {}^3\text{He}$, and $d + d$ -collisions, with special attention to the angular distribution of the reaction products for different possible polarization states of the colliding particles, without any particular assumption about the reaction mechanism.

In a fusion reactor the reaction rates and the angular distributions depend on the direction of the magnetic field. We use in this analysis a particular set of helicity amplitudes, with quantization axis along the direction of the magnetic field. We derive the angular dependence of the differential cross sections for different polarization states of the colliding particles, and the angular dependence of the polarization of the produced neutrons (protons).

4.2 The complete experiment for the reaction

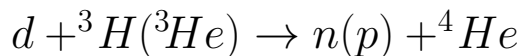

4.2.1 Introductory remarks

The reaction $d + {}^3\text{H} \rightarrow n + {}^4\text{He}$ in the near threshold region is very interesting for the production of thermonuclear energy and plays an important role in primordial nucleosynthesis. The lowest $\frac{3^+}{2}$ level of ${}^5\text{He}$ has excitation energy $E_x = 16.75$ MeV (only 50 keV above $d + {}^3\text{H}$ -threshold) and has a width of 76 keV.

The microscopic explanation of the nature and the properties of this resonance is very complicated and still under debate in the physics of light nuclei. The interpretation [68] of this resonance as a shadow pole [69] introduces a new concept in nuclear physics, after atomic and particle physics. The possibility that the corresponding shadow poles for the two charge symmetric systems $d + {}^3\text{He}$ and $d + {}^3\text{H}$ (or $p + {}^4\text{He}$ and $n + {}^4\text{He}$) occupy different Riemann sheets, due to the difference in electric charges of the participating particles, can not be presently ruled out. Such phenomena can be considered as a new mechanism of violation of isotopic invariance of the strong interaction [70].

Due to the close connection of the three processes $d + {}^3\text{He} \rightarrow d + {}^3\text{He}$, $n + {}^4\text{He} \rightarrow n + {}^4\text{He}$ and $d + {}^3\text{H} \rightarrow n + {}^4\text{He}$ through the unitarity condition, the partial wave analysis [71, 72] can not be performed independently for each reaction. The corresponding amplitudes are complex functions of the excitation energy. The multilevel \mathcal{R} -matrix approach allows to parametrize this dependence in terms of few parameters as shift, penetration factors and hard-sphere phase shift

[73]. All characteristics of the $\mathcal{J}^P = \frac{3^+}{2}$ -resonance, like the position, the width and particularly the Riemann sheet, can be found using an S -matrix approach [68, 74, 75, 76].

The polarization phenomena are very important in the near threshold region, even for the S-state interaction. In this respect the reaction $d + {}^3H \rightarrow n + {}^4He$ plays a special role, because the presence of a D-wave in the final state results in nonzero one-spin polarization observables, such as, for example, the tensor analyzing power. In order to fully determine the two possible threshold (complex) amplitudes, two-spin polarization observables have to be measured, for example in collisions of polarized deuteron with polarized 3He -target. Here we will generalize our previous analysis [67], taking into account the presence of a magnetic field, which is necessary in order to conserve the polarization of the fuel constituents in a magnetic fusion reactor [66].

For thermal colliding energies the analysis of polarization phenomena for the reaction $d + {}^3H \rightarrow n + {}^4He$ can be carried out in a general form. In the framework of a formalism, based on the polarized structure functions, we will point out the observables which have to be measured in order to have a full reconstruction of the spin structure of the threshold amplitudes. Data on cross section and tensor analyzing power exist, at threshold [77] (for a review see [78]). Among the two-spin observables, the measurement of a spin correlation coefficient, together with the cross section and the tensor analyzing power, allows to realize the complete experiment.

4.2.2 Spin structure of the matrix element

Let us first establish the spin structure of the matrix element. From the P-invariance of the strong interaction and the conservation of the total angular momentum, two partial transitions, for $d + {}^3He \rightarrow p + {}^4He$ (as well as for $d + {}^3H \rightarrow n + {}^4He$) are allowed:

$$S_i = \frac{1}{2} \rightarrow \mathcal{J}^P = \frac{1^+}{2} \rightarrow \ell_f = 0, \quad S_i = \frac{3}{2} \rightarrow \mathcal{J}^P = \frac{3^+}{2} \rightarrow \ell_f = 2, \quad (4.1)$$

where S_i is the total spin of the $d + {}^3He$ -system and ℓ_f is the orbital angular momentum of the final proton. The spin structure of the threshold matrix element can be parametrized in the form:

$$\begin{aligned} \mathcal{M} &= \chi_2^\dagger \mathcal{F}_{th} \chi_1, \\ \mathcal{F}_{th} &= g_s \vec{\sigma} \cdot \vec{D} + g_d (3\vec{k} \cdot \vec{D} \vec{\sigma} \cdot \vec{k} - \vec{\sigma} \cdot \vec{D}), \end{aligned} \quad (4.2)$$

where χ_1 and χ_2 are the two component spinors of the initial 3He and final p , \vec{D} is the 3-vector of the deuteron polarization (more exactly, \vec{D} is the axial vector due to the positive parity of the deuteron), \vec{k} is the unit vector along the 3-momenta

of the proton (in the CMS of the considered reaction). The amplitudes of the S - and D - production of the final particles, g_s and g_d , are complex functions of the excitation energy. Note that, in the general case, the spin structure of the matrix element, for the considered processes, contains six different contributions and the corresponding amplitudes are functions of two variables.

The general parametrization of the differential cross section in terms of the polarizations of the colliding particles (in S-state) is given by:

$$\begin{aligned} \frac{d\sigma}{d\Omega}(\vec{d} + {}^3\vec{H}e) = \left(\frac{d\sigma}{d\Omega}\right)_0 [& 1 + \mathcal{A}_1(Q_{ab}k_a k_b) + \mathcal{A}_2\vec{S} \cdot \vec{P} \\ & + \mathcal{A}_3\vec{k} \cdot \vec{P} \vec{k} \cdot \vec{S} + \mathcal{A}_4\vec{k} \cdot \vec{P} \times \vec{Q}], \quad Q_a = Q_{ab}k_b \end{aligned} \quad (4.3)$$

where $(d\sigma/d\Omega)_0$ is the differential cross section with unpolarized particles, \vec{P} is the axial vector of the target (3He) polarization, \vec{S} and Q_{ab} are the vector and tensor deuteron polarizations. The density matrix of the deuteron can be written as:

$$\overline{D_a D_b^*} = \frac{1}{3}(\delta_{ab} - \frac{3}{2}i\epsilon_{abc}S_c - Q_{ab}), \quad Q_{aa} = 0, \quad Q_{ab} = Q_{ba}. \quad (4.4)$$

After summing over the final proton polarizations one can find the following expressions:

$$\begin{aligned} \mathcal{A}_1 \left(\frac{d\sigma}{d\Omega}\right)_0 &= -2\mathcal{R}e g_s g_d^* - |g_d|^2, & \mathcal{A}_2 \left(\frac{d\sigma}{d\Omega}\right)_0 &= -|g_s|^2 - \mathcal{R}e g_s g_d^* + 2|g_d|^2, \\ \mathcal{A}_3 \left(\frac{d\sigma}{d\Omega}\right)_0 &= 3\mathcal{R}e g_s g_d^* - 3|g_d|^2, & \mathcal{A}_4 \left(\frac{d\sigma}{d\Omega}\right)_0 &= -2\mathcal{I}m g_s g_d^*. \end{aligned} \quad (4.5)$$

The coefficients \mathcal{A}_i are related by the following linear relation: $\mathcal{A}_1 + \mathcal{A}_2 + \mathcal{A}_3 = -1$ for any choice of amplitudes g_s and g_d . The integration of the differential cross section over the \vec{k} -directions gives:

$$\sigma(\vec{d} + {}^3\vec{H}) = \sigma_0(1 + \mathcal{A}\vec{S} \cdot \vec{P}), \quad \mathcal{A} = \mathcal{A}_2 + \frac{1}{3}\mathcal{A}_3 = \frac{-|g_s|^2 + |g_d|^2}{|g_s|^2 + 2|g_d|^2},$$

and it is independent from the tensor deuteron polarization.

The presence of S-wave contribution (the amplitude g_s), decreases the value of the integral coefficient \mathcal{A} whereas, in the fusion resonance region, where the D-wave dominates, the maximum value, $\mathcal{A} = 1/2$, is reached. In the complete experiment (which gives $|g_s|^2$, $|g_d|^2$ and $\mathcal{R}e g_s g_d^*$), the amplitudes $|g_s|$ and $|g_d|$ can be found in a model independent way, with the help of the following formulas:

$$\begin{aligned} 9|g_s|^2 &= (5 + 2\mathcal{A}_1 - 4\mathcal{A}_2) \left(\frac{d\sigma}{d\Omega}\right)_0, \\ 9|g_d|^2 &= (2 - \mathcal{A}_1 + 2\mathcal{A}_2) \left(\frac{d\sigma}{d\Omega}\right)_0, \end{aligned} \quad (4.6)$$

$$-9\text{Re}g_s g_d^* = (1 + 4\mathcal{A}_1 + \mathcal{A}_2) \left(\frac{d\sigma}{d\Omega} \right)_0.$$

One can see that the *integral* coefficient \mathcal{A} can be determined from polarized nuclei collisions by measuring:

- the tensor analyzing power \mathcal{A}_1 in $\vec{d} + {}^3\text{He} \rightarrow p + {}^4\text{He}$,
- the spin correlation coefficient $C_{xx} = C_{yy} = \mathcal{A}_2$ (if the z -axis is along \vec{k} -direction.)

Let us study now the polarization properties of the outgoing nucleons. We will show that it can be predicted only from the tensor analyzing power, \mathcal{A}_1 . The polarization \vec{P}_f of the produced nucleon depends on the polarization \vec{P} of the initial ${}^3\text{He}$ (or ${}^3\text{H}$) as follows: $\vec{P}_f = p_1 \vec{P} + p_2 \vec{k} \vec{k} \cdot \vec{P}$, where the real coefficients p_i , $i = 1, 2$, characterize the spin transfer coefficients (from the initial ${}^3\text{He}$ or ${}^3\text{H}$ to the final nucleon): $K_x^{x'} = p_1 + p_2 \cos^2 \theta$, $K_x^{z'} = p_2 \sin \theta \cos \theta$, where θ is the angle between \vec{k} and \vec{P} . Averaging over the polarizations of the initial deuteron, we can find:

$$\begin{aligned} p_1 \left(\frac{d\sigma}{d\Omega} \right)_0 &= -\frac{1}{3} (|g_s|^2 + 4\text{Re} g_s g_d^* + 4|g_d|^2), \\ p_2 \frac{d\sigma}{d\Omega}_0 &= 4\text{Re} g_s g_d^* + 2|g_d|^2, \\ 3p_1 &= -1 + 2\mathcal{A}_1, \quad p_2 = -2\mathcal{A}_1, \quad 3p_1 + p_2 = -1. \end{aligned}$$

This analysis holds in the presence of S-state only, in the entrance channel. The validity of this assumption can be experimentally verified with the measurement of T-odd one-spin polarization observables, as the analyzing powers in $\vec{d} + {}^3\text{He} \rightarrow p + {}^4\text{He}$ induced by vector deuteron polarization or $d + {}^3\text{He} \rightarrow p + {}^4\text{He}$. These observables are very sensitive to the presence of even a small P-wave contribution, due to its interference with the main S-wave amplitude.

4.2.3 Helicity amplitudes

We calculate here the helicity amplitudes $F_{\lambda_1 \lambda_2, \lambda_3}$, with $\lambda_1 = \lambda_d$, $\lambda_2 = \lambda_{{}^3\text{He}}$, $\lambda_3 = \lambda_p$ (or λ_n), in terms of the partial amplitudes g_s and g_d . This formalism is very well adapted for the analysis of angular distributions of the reaction products, in conditions of fusion reactors (with polarized fuel) and to the description of polarization phenomena. The direction of magnetic field \vec{B} can be chosen as the most preferable quantization axis (z -axis). The formalism of the helicity amplitudes allows to study the angular dependence of the polarization observables, relative to \vec{B} . For example, the polarization properties of the neutron in $\vec{d} + {}^3\text{H} \rightarrow n + {}^4\text{He}$ can be easily calculated in terms of these amplitudes.

The peculiar strong angular dependence of all observables is due to the presence (in conditions of fusion polarized reactor) of two independent physical directions, \vec{k} and \vec{B} . So even for the S-state interaction, a non trivial angular dependence of the reaction products appears, i.e. some angular anisotropy, related to the initial polarizations. As all the polarizations of both colliding particles depend on the same magnetic field \vec{B} , the results for these observables depend only on the angle θ , between \vec{k} and \vec{B} . The case of the collision of polarized beam with polarized target, where the beam and the target may have different directions of polarization is more complicated, but it can also be treated in the framework of the helicity formalism.

The deuteron polarization vector $\vec{D}^{(\lambda)}$ (with a definite helicity λ), can be chosen as: $\vec{D}^{(0)} = (0, 0, 1)$ and $\vec{D}^{(\pm)} = 1/\sqrt{2}(\pm 1, i, 0)$. So the following expressions for the six possible helicity amplitudes can be found:

$$\begin{aligned} F_{0+,+} &= g_s - (1 - 3 \cos^2 \theta)g_d, & F_{++,-} &= \frac{3}{\sqrt{2}} \sin^2 \theta g_d, \\ F_{0+,-} &= \frac{3}{2} \sin 2\theta g_d, & F_{-+,+} &= \frac{3}{2\sqrt{2}} \sin 2\theta g_d, \\ F_{++,+} &= -\frac{3}{2\sqrt{2}} \sin 2\theta g_d, & F_{-+,-} &= -\frac{1}{\sqrt{2}} [2g_s + (1 - 3 \cos^2 \theta)g_d], \end{aligned} \quad (4.7)$$

where θ is the nucleon production angle, relative to the \vec{B} direction. Other possible helicity amplitudes, with reversed helicities of all particles, can be obtained from (4.7), by parity reversion.

4.2.4 Collision of polarized particles

The angular dependence of the reaction products in $d + {}^3H \rightarrow n + {}^4He$ for different polarization states of the colliding particles can be derived from (4.7).

- Collisions of longitudinally polarized deuterons ($\lambda_d = 0$), with polarized 3H or 3He :

$$\sigma_{0+}(\theta) = |F_{0+,+}|^2 + |F_{0+,-}|^2 = |g_s|^2 + 2Re g_s g_d^* (-1 + 3 \cos^2 \theta) + |g_d|^2 (1 + 3 \cos^2 \theta). \quad (4.8)$$

- $\vec{d} + {}^3\vec{H}e$ collisions with parallel polarizations (relative to \vec{B}):

$$\sigma_{++}(\theta) = |F_{++,+}|^2 + |F_{++,,-}|^2 = \frac{9}{2} |g_d|^2 \sin^2 \theta. \quad (4.9)$$

- $\vec{d} + {}^3\vec{H}e$ collisions with antiparallel polarizations:

$$\sigma_{+-}(\theta) = |F_{+,-,+}|^2 + |F_{+,-,-}|^2 = 2|g_s|^2 + 2Re g_s g_d^* (1 - 3 \cos^2 \theta) + \frac{1}{2} (1 + 3 \cos^2 \theta) |g_d|^2. \quad (4.10)$$

The sum of all these polarized cross sections is independent from polar angle θ : the unpolarized cross section is isotropic, as expected for S -state interaction.

For the pure fusion resonance (with $g_s = 0$), the angular distribution of the reaction products depends specifically on the direction of the polarizations of the colliding particles: the $\sin^2 \theta$ -dependence for parallel ($++$) collisions, becomes a dependence in $(1 + 3 \cos^2 \theta)$ for ($+ -$) and ($0 +$) collisions, to be compared with the isotropic behavior of the unpolarized collisions. Such definite and strong anisotropy can play a very important role in the design of the neutron shield of a reactor and of the blanket, where energetic neutrons (from $d + {}^3H \rightarrow n + {}^4He$) can produce 3H through the reaction $n + {}^6Li \rightarrow {}^3H + {}^4He$. Once a $d + {}^3H$ -reactor is beginning to operate, 3H -fuel can be produced in 6Li -blanket. In principle, this blanket can contain polarized ${}^6\vec{Li}$, for a more efficient 3H -production in $\vec{n} + {}^6\vec{Li}$ -collisions.

From Figs. 4.1 and 4.2, one can see that the angular dependence of the cross sections for polarized collisions, is essentially influenced by the presence of the S-wave amplitude and its relative phase.

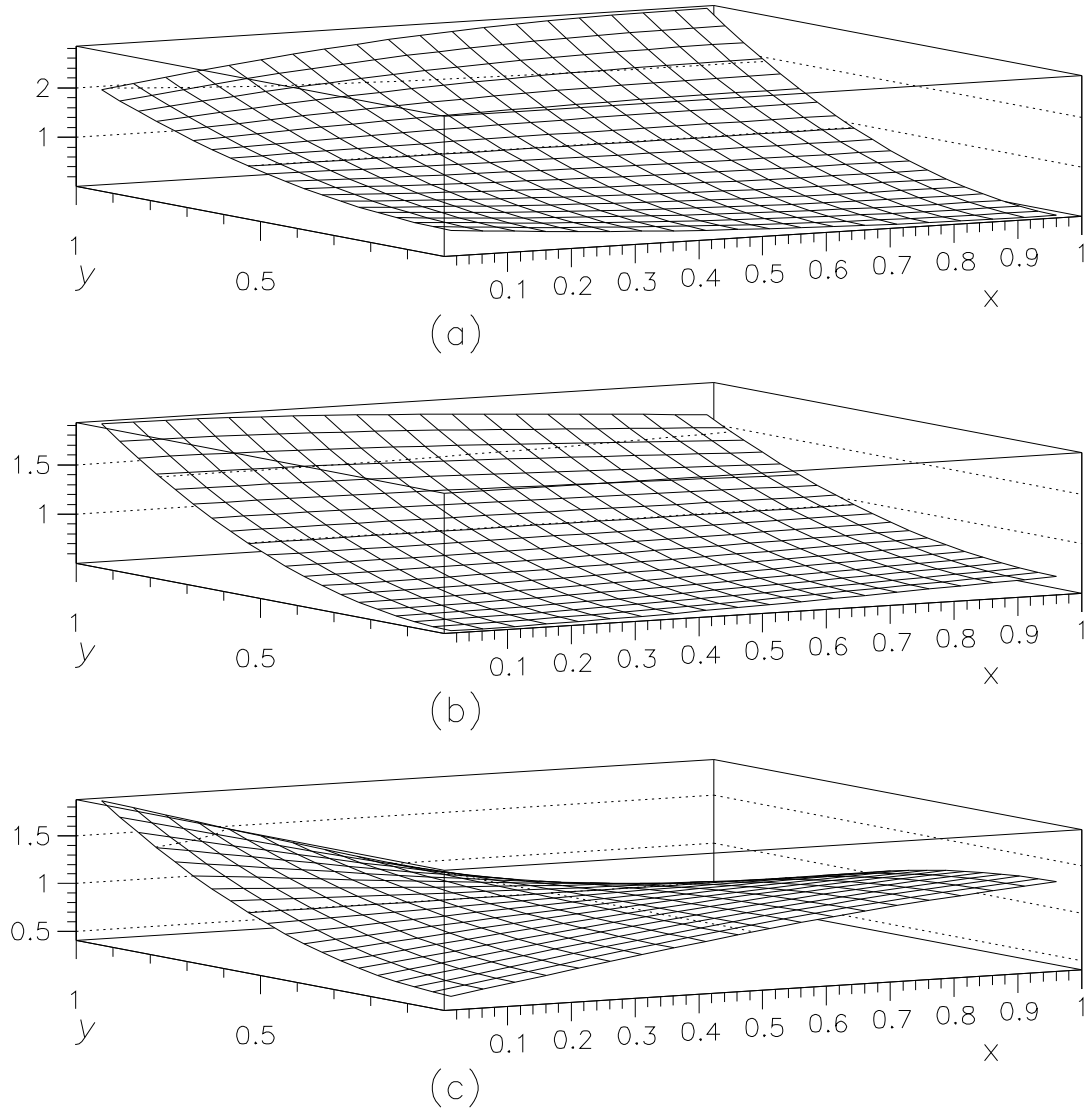

Figure 4.1: Ratio σ_{0+}/σ_{00} , as a function of $x = |g_s|/|g_d|$ and $y = \cos\theta$ for the reaction $\vec{d} + {}^3\text{He} \rightarrow \vec{n} + {}^4\text{He}$, for different values of the phase δ : (a) $\delta = 0$, (b) $\delta = \frac{\pi}{2}$ and (c) $\delta = \pi$, from Eq. (8).

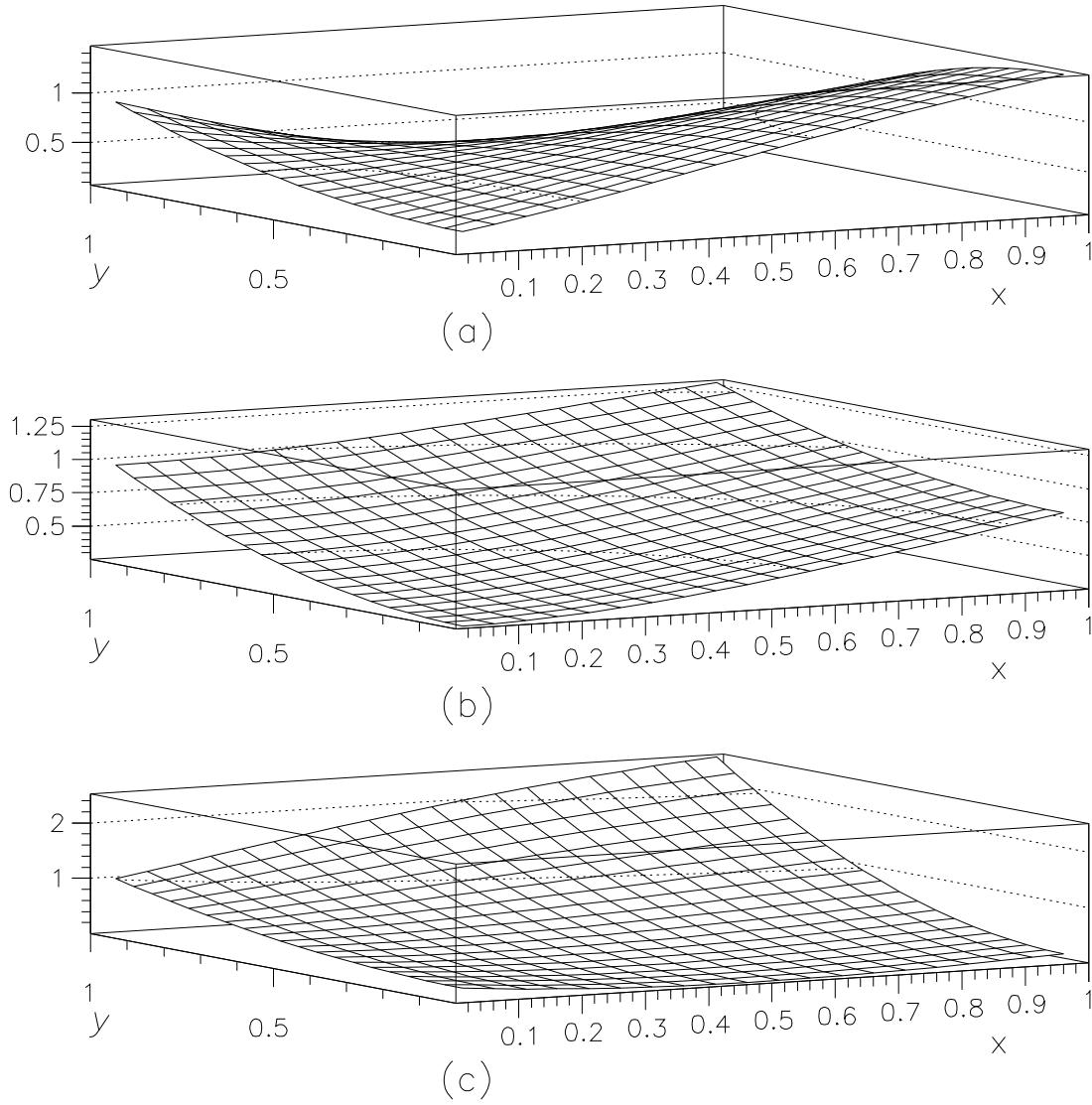

Figure 4.2: Ratio σ_{+-}/σ_{00} as a function of $x = |g_s|/|g_d|$ and $y = \cos\theta$ for the reaction $\vec{d} + {}^3\text{He} \rightarrow \vec{n} + {}^4\text{He}$, for different values of the phase δ : (a) $\delta = 0$, (b) $\delta = \frac{\pi}{2}$ and (c) $\delta = \pi$, from Eq. (4.10).

Let us calculate now the following ratios:

$$R_{\lambda_1\lambda_2} = \frac{\int_{-1}^{+1} \sigma_{\lambda_1\lambda_2}(\theta) d \cos \theta}{\int_{-1}^{+1} d \cos \theta (d\sigma/d\Omega)_0},$$

from Eqs. (4.8,4.9,4.10) for $\sigma_{\lambda_1\lambda_2}(\theta)$:

$$R_{0+} = 1, \quad R_{++} = \frac{3}{2}f, \quad R_{+-} = \frac{1}{2}(4 - 3f). \quad (4.11)$$

So we can write the following limits:

$$0 \leq R_{++} \leq 3/2 \quad (g_s = 0), \quad 1/2 \leq R_{+-} \leq 2 \quad (g_d = 0).$$

In the fusion resonance region, $(f=1)$ ¹, the $(++)$ -collisions increase the reaction yield (in comparison with collisions of unpolarized particles) with a maximum coefficient $\leq 3/2$, for pure D-wave fusion resonance. Using the notations of [66] one can obtain the following general formula for the differential cross section of $\vec{d} + \vec{^3H}$ (or $\vec{d} + \vec{^3He}$)-collisions:

$$\begin{aligned} \frac{d\sigma}{d\Omega}(\vec{d} + \vec{^3H}) = 6|g_d|^2 \left\{ \frac{3}{4}a \sin^2 \theta + \frac{b}{6} \left[\frac{2}{f} - (1 - 3 \cos^2 \theta) \left(1 + \frac{2 \operatorname{Re} g_s g_d^*}{|g_d|^2} \right) \right] + \right. \\ \left. + \frac{c}{12} \left[\frac{8}{f} - 6 - (1 - 3 \cos^2 \theta) \left(1 - \frac{4 \operatorname{Re} g_s g_d^*}{|g_d|^2} \right) \right] \right\}. \quad (4.12) \end{aligned}$$

Here $a = d_+ t_+ + d_- t_-$, $b = d_0$, $c = d_+ t_+ + d_- t_-$ and d_+ , d_0 , d_- are the fractions of deuterons with polarization respectively parallel, transverse, antiparallel to \vec{B} , while t_+ and t_- are the corresponding fractions for 3H . The relations $d_+ + d_0 + d_- = 1$ and $t_+ + t_- = 1$ hold. The case $a = b = c = 1/3$ corresponds to unpolarized collisions.

Note that the predicted angular dependence for b and c contributions, Eq. (4.12), differs essentially from the corresponding expression of [66]. It coincides only for the special case $f = 1$, $g_s = 0$. The denominator for Eq. (2) in ref. [66] must be also different.

From (4.12) one can find the following expression for the differential cross section of collisions of polarized deuterons with unpolarized 3H :

$$\frac{d\sigma}{d\Omega}(\vec{d} + \vec{^3H}) = 2|g_d|^2 \left[\frac{1}{f} + P_{zz} \frac{1 - 3 \cos^2 \theta}{4} \left(1 + \frac{2 \operatorname{Re} g_s g_d^*}{|g_d|^2} \right) \right],$$

i.e. it depends on the tensor deuteron polarization only. We used above the standard definition: $P_{zz} = d_+ - 2d_0 + d_-$. Due to the $(1 - 3 \cos^2 \theta)$ dependence, after integration over θ , the cross section, again, does not depend on the deuteron polarization.

¹In particular the ratio of amplitudes $f = 2|g_d|^2/(|g_s|^2 + 2|g_d|^2)$ was firstly defined in [66].

4.2.5 Polarization of neutrons in $\vec{d} + {}^3\vec{H}$ collisions

Using the helicity amplitudes (4.7) it is possible to predict also the angular dependence of the neutron polarization in $\vec{d} + {}^3\vec{H} \rightarrow n + {}^4He$, in the general case of polarized particle collisions:

$$\begin{aligned} (n_+ - n_-) \frac{d\sigma}{d\Omega}(\vec{d} + {}^3\vec{H}) &= \frac{9}{2}(d_-t_- - d_+t_+) \sin^2 \theta (1 - 2 \cos^2 \theta) |g_d|^2 + \\ &+ d_0(t_+ - t_-) \left[|g_s|^2 - 2(1 - 3 \cos^2 \theta) \text{Re } g_s g_d^* + (1 - 15 \cos^2 \theta + 18 \cos^4 \theta) |g_d|^2 \right] + \\ &+ (d_+t_- - d_-t_+) \frac{1}{2} \left[4|g_s|^2 + 4(1 - 3 \cos^2 \theta) \text{Re } g_s g_d^* + (1 - 15 \cos^2 \theta + 18 \cos^4 \theta) |g_d|^2 \right], \end{aligned}$$

where n_{\pm} is the fraction of neutrons, polarized parallel and antiparallel to the direction of the magnetic field.

Let us write some limiting cases of this general formula:

(a) Collisions of polarized deuterons with unpolarized 3H -nuclei:

$$\begin{aligned} (n_+ - n_-) \frac{d\sigma}{d\Omega}(\vec{d} + {}^3H) &= (d_+ - t_-) \left[|g_s|^2 + (1 - 3 \cos^2 \theta) \text{Re } g_s g_d^* - \right. \\ &\left. (2 - 3 \cos^2 \theta) |g_d|^2 \right]. \end{aligned} \quad (4.13)$$

(b) Collisions of unpolarized deuterons with polarized 3H -nuclei:

$$\begin{aligned} (n_+ - n_-) \frac{d\sigma}{d\Omega}(d + {}^3\vec{H}) &= \frac{t_- - t_+}{3} \left[|g_s|^2 + 4(1 - 3 \cos^2 \theta) \text{Re } g_s g_d^* \right. \\ &\left. + 2(2 - 3 \cos^2 \theta) |g_d|^2 \right]. \end{aligned} \quad (4.14)$$

In the case of fusion resonance ($g_s = 0$), these formulas reduce to:

$$\begin{aligned} (n_+ - n_-) \frac{d\sigma}{d\Omega}(\vec{d} + {}^3\vec{H}) &= \frac{9}{4} \sin^2 \theta (1 - 2 \cos^2 \theta) (d_+t_- - d_+t_+) + \\ &\frac{1}{2} \left[d_0(t_+ - t_-) + \frac{1}{2}(d_+t_- - d_-t_+) (1 - 15 \cos^2 \theta + 18 \cos^4 \theta) \right]. \end{aligned} \quad (4.15)$$

Averaging over the polarizations of d (or 3H) one can find particular expressions:

$$(n_+ - n_-) \frac{d\sigma}{d\Omega}(d + {}^3\vec{H}) = \frac{1}{2}(t_- - t_+)(2 - 3 \cos^2 \theta)$$

and

$$(n_+ - n_-) \frac{d\sigma}{d\Omega}(\vec{d} + {}^3H) = -\frac{1}{3}(d_- - d_+)(2 - 3 \cos^2 \theta).$$

The angular dependence of most of these polarization observables is sensitive to the relative value of the g_s and g_d amplitudes, due to the $g_s g_d^*$ -interference

contributions. Of course, in the region of the fusion resonance the g_d amplitude is dominant. However the temperature conditions, typical for a fusion reactor, correspond to collision energies lower than the energy of the fusion resonance. Even a small g_s/g_d ratio can change the angular behavior of the polarization observables. In Figs. 4.3 and 4.4 we show, in a 3-dimensional plot, the dependence of the neutron polarization on the ratio $x = |g_s|/|g_d|$ and on the production angle θ for three values of the relative phase δ , $\delta = 0, \pi/2, \pi$, for $\vec{d} + {}^3H$ and $d + \vec{{}^3H}$ -collisions.

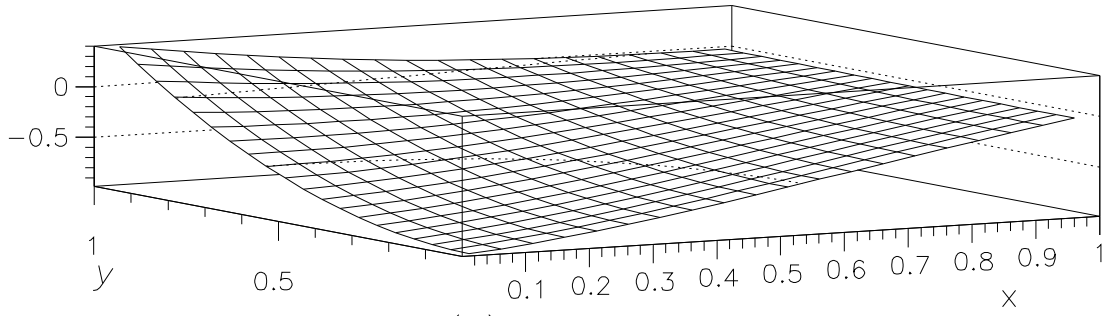

(a)

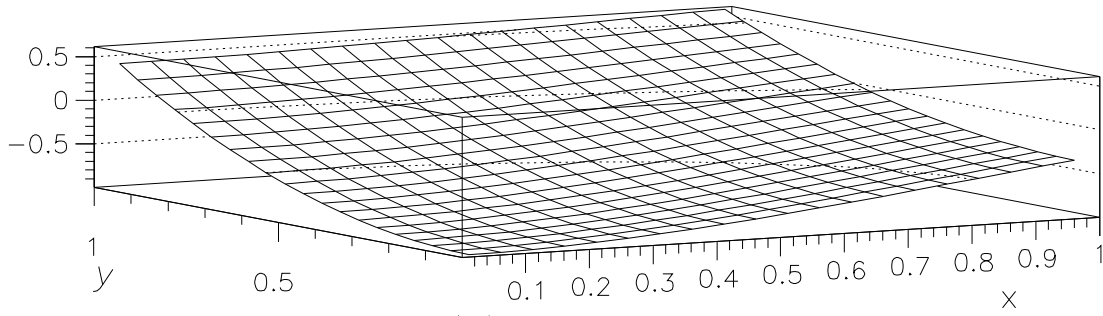

(b)

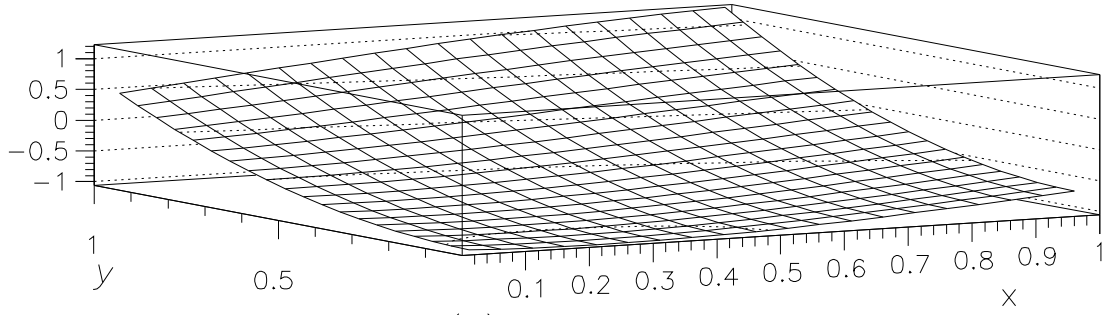

(c)

Figure 4.3: Neutron polarization $P_n = \frac{[-2+3y^2+x\cos\delta(1-3y^2)+x^2]}{(2+x^2)}$, as a function of $x = |g_s|/|g_d|$ and $y = \cos\theta$ in $\vec{d}+{}^3He$ -collisions, for different values of the phase δ : (a) $\delta = 0$, (b) $\delta = \frac{\pi}{2}$ and (c) $\delta = \pi$.

The exact determination of the parameters x and δ , is crucial for thermonuclear processes. This is a reason to perform a complete experiment for this reaction as discussed earlier [67]. The important point is that even at very low energies, where the spin structure is simplified, a complete experiment must include the scattering of polarized beam on polarized target. The full reconstruction of the threshold matrix elements requires this type of experiment.

4.3 Processes $d + d \rightarrow n + {}^3He$ and $d + d \rightarrow p + {}^3H$

The $d + d \rightarrow n + {}^3He$ and $d + d \rightarrow p + {}^3H$ reactions at low energy have a very wide spectrum of fundamental and practical applications, from the discovery of tritium and helium isotopes [79], to the important role for primordial nucleosynthesis in the early Universe and fusion energy production with polarized and unpolarized fuel [66, 80]. These processes are of large interest in nuclear theory: for example, in a four nucleon system, contrary to three nucleon system, broad resonant states can be excited [83]. The angular dependence of the differential cross sections [84, 85] and the polarization observables [75, 76, 77, 78] for these charge symmetric reactions constitutes a good test of the isotopic invariance for the low energy nuclear interaction. The dd -interaction is also connected to muon catalyzed processes $(\mu dd) \rightarrow \mu + p + {}^3H$ or $(\mu dd) \rightarrow \mu + n + {}^3He$ [90], where only the P-state of the dd -system is present, at low energy.

In the general case the spin structure of the matrix element for $d + d \rightarrow n + {}^3He$ ($p + {}^3H$) is quite complicated, with 18 independent spin combinations, and therefore with 18 complex scalar amplitudes, which are functions of the excitation energy and the scattering angle. However, at thermal collision energies, where the S -state deuteron interaction has to dominate, this structure is largely simplified. The identity of the colliding deuterons, which are bosons, is an important guide for the partial amplitude analysis in order to determine the spin structure of the reaction amplitude. The determination of the polarization observables is indispensable, for this purpose. The four possible analyzing powers for $\vec{d} + d$ -collisions, A_y , A_{zz} , A_{xz} and $A_{xx} - A_{yy}$ were measured at $E_d \leq 100$ keV, as well as the angular dependence of the differential cross section [84, 85, 89].

The knowledge of the relative role of different orbital angular momenta (and the corresponding partial amplitudes) is essential for the solution of different fundamental problems concerning these processes, like the possibility to build a thermonuclear "clean" reactor with polarized $d + {}^3He$ -fuel. The main reaction $d + {}^3He \rightarrow p + {}^4He$ does not produce radioactive nuclei, and the possibility to decrease the cross section of $\vec{d} + \vec{d}$ -collisions (which produces $n + {}^3He$ or $p + {}^3H$) with parallel polarizations, will decrease the production of neutrons and the tritium. Direct experimental data about $\vec{d} + \vec{d}$ -low energy collisions are absent, so the dependence of the cross section on the polarization states of the colliding particles can be calculated only from theoretical predictions or from different multipole

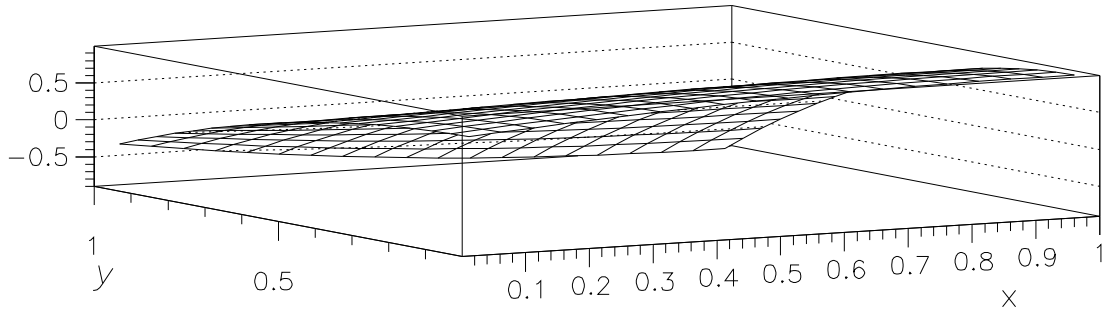

(a)

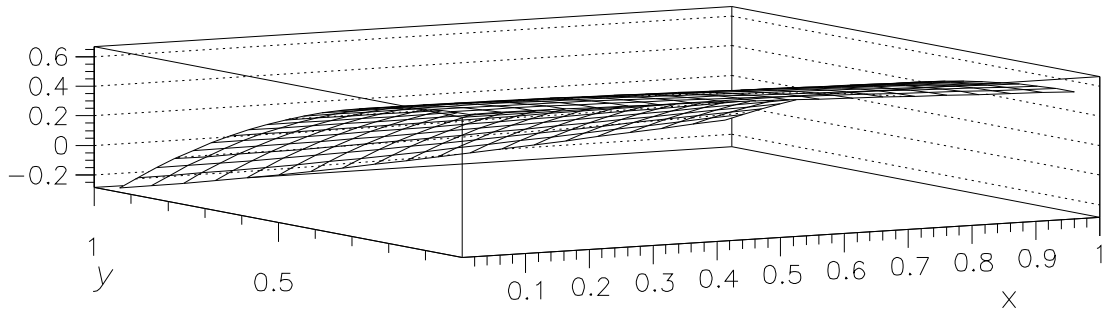

(b)

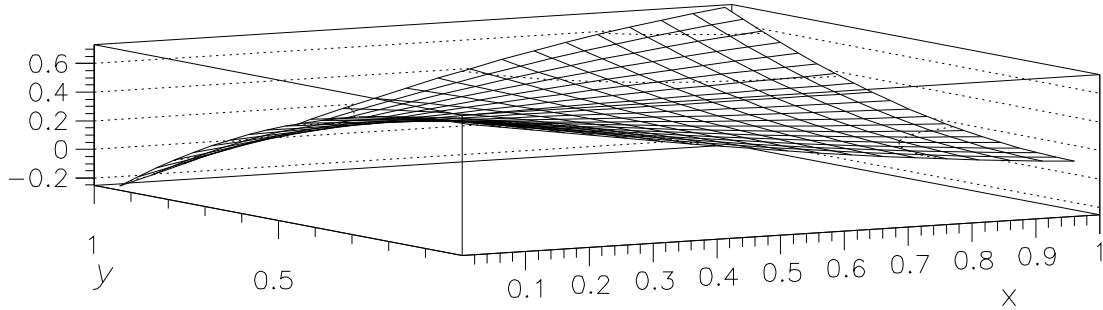

(c)

Figure 4.4: Neutron polarization $P_n = \frac{1}{3} \frac{[2(2-3y^2)+4x\cos\delta(1-3y^2)+x^2]}{(2+x^2)}$, as a function of $x = |g_s|/|g_d|$ and $y = \cos\theta$ in unpolarized $d + {}^3\text{He}$ -collisions, for different values of the phase δ : (a) $\delta = 0$, (b) $\delta = \frac{\pi}{2}$ and (c) $\delta = \pi$.

analysis.

The theoretical predictions and the results of multipole analysis seem very controversial now, even at very low energy. In the first partial wave analysis [91, 92] it was found that the S-state dd -interaction in the quintet state (i.e. with total spin $S_i = 2$) is smaller in comparison with the $S_i = 0$ interaction. This was consistent with the conclusion of ref. [66], that in a polarized reactor it is possible to suppress $\vec{d} + \vec{d}$ -collisions. Later [93], it was pointed out that strong central forces with D -state in 3He can induce a large dd - interaction in the quintet state and resonating-group calculations [93] found that polarized collisions are not suppressed. On the other hand, DWBA calculations give a large suppression for the ratio of polarized on unpolarized cross section, $\sigma_{++}/\sigma_0 \simeq 0.08$ in the range $E_d = 20 - 150$ keV, even after inclusion of the 3He D-state. A more recent analysis [95, 96] based on R -matrix approach, concludes that this ratio does not decrease with energy. Note that in principle, it can be energy dependent [97].

Again, a direct measurement of polarized dd -collisions would greatly help in solving these problems and the complete experiment will allow to reconstruct the spin structure of the reaction amplitude. Therefore, the considerations based on S -wave only, have to be considered as the first necessary step which can illustrate the possible strategy of the complete experiment for this case.

4.3.1 Partial amplitudes

We establish here the spin structure of the threshold matrix element for the $d + d \rightarrow n + {}^3He$ ($p + {}^3H$) process. For S-state dd -interaction the following partial transitions are allowed:

$$\begin{aligned} S_i = 0 &\rightarrow \mathcal{J}^P = 0^+ \rightarrow S_f = 0, \ell_f = 2, \\ S_i = 2 &\rightarrow \mathcal{J}^P = 2^+ \rightarrow S_f = 0, \ell_f = 2, \\ S_i = 2 &\rightarrow \mathcal{J}^P = 2^+ \rightarrow S_f = 1, \ell_f = 2, \end{aligned}$$

where S_i is the total spin of the colliding deuterons, ℓ_f is the orbital angular momentum of the final nucleon. Note that the Bose statistics for identical deuterons allows only even values of initial spin, that is $S_i = 0$ and $S_i = 2$ for the S-state. The resulting spin structure of the threshold matrix element can be written as:

$$\mathcal{M} = i(\chi_3^\dagger \sigma_2 \widetilde{\chi}_1^\dagger) \left[g_1 \vec{D}_1 \cdot \vec{D}_2 + g_2 (3\vec{k} \cdot \vec{D}_1 \vec{k} \cdot \vec{D}_2 - \vec{D}_1 \cdot \vec{D}_2) + g_3 (\vec{\sigma} \cdot \vec{k} \times \vec{D}_1 \vec{k} \cdot \vec{D}_2 + \vec{\sigma} \cdot \vec{k} \times \vec{D}_2 \vec{k} \cdot \vec{D}_1) \right], \quad (4.16)$$

where χ_1 and χ_3 are the 2-component spinors of the produced nucleon and 3He (or 3H), \vec{D}_1 and \vec{D}_2 are the 3-vectors of the deuteron polarization, \vec{k} is the unit vector along the 3-momenta of the nucleon (in the CMS of the considered reaction). The amplitudes g_1 and g_2 describe the production of the singlet $n + {}^3He$ -state, and

the amplitude g_3 - the triplet state. The complete experiment in S -state dd -interaction implies the measurement of 5 different observables, to determine 3 moduli and two relative phases of partial amplitudes.

The validity of the S-state approximation in the near threshold region can be checked by measuring any T-odd polarization observable, the simplest of which are the one-spin observables as the vector analyzing power in the reaction $\vec{d}+d \rightarrow n+{}^3He$ [89]. Note that Eq. (4.16) is correct also for the threshold matrix elements of the inverse process: $n+{}^3He \rightarrow d+d$ (or $p+{}^3H \rightarrow d+d$).

4.3.2 Helicity amplitudes

In order to establish the angular dependence of the reaction products, for collisions of polarized particles, in the presence of magnetic field, let us derive the helicity amplitudes. The spin structure of the $d+d$ reactions is more complex in comparison to $d+{}^3He$. The analysis of polarization phenomena is also more complicated. It was mentioned in [66], that an enhancement factor, equal to 2 can be obtained in a polarized plasma ², for the reaction $d+d \rightarrow n+{}^3He$, if the deuterons are polarized transversally to the direction of the magnetic field, i.e. for (00)-collisions, in an ordinary thermal ion distribution. Alternatively, if colliding beams or beam and target methods are used (inertial fusion), the two ions should be polarized in opposite direction, relatively to the field. In case of collisions of deuterons with parallel polarizations i.e (++) or (--), a large suppression of the reaction rate is expected.

It is then interesting to analyze all possible configurations of the polarization of the colliding deuterons. We can classify the helicity amplitudes according to the following scheme:

- I) 00 collisions: the polarization is transverse to the magnetic field \rightarrow 2 independent amplitudes;
- II) ++ collisions: the polarization parallel to the magnetic field \rightarrow 4 independent amplitudes;
- III) +− collisions: collisions with deuterons with antiparallel polarization, in the same direction as the magnetic field \rightarrow 4 independent amplitudes;
- IV) 0+ collisions: collisions of one deuteron with polarization transverse to the magnetic field with the other deuteron polarized along the magnetic field \rightarrow 4 independent amplitudes;

The corresponding helicity amplitudes $\mathcal{F}_{\lambda_1\lambda_2,\lambda_3\lambda_4}$, (with $\lambda_1 \equiv \lambda_{d_1}$, $\lambda_2 \equiv \lambda_{d_2}$, $\lambda_3 \equiv \lambda_{{}^3He}$, $\lambda_4 \equiv \lambda_N$) are given in terms of partial amplitudes:

²Note that this holds only for the partial wave analysis [91, 92].

$$\begin{aligned}
(I) \quad & \mathcal{F}_{00,++} = -\sin 2\theta g_3, \quad \mathcal{F}_{00,+ -} = g_1 - (1 - 3 \cos^2 \theta)g_2, \\
(II) \quad & \mathcal{F}_{++,++} = \sin 2\theta g_3, \quad \mathcal{F}_{++,+ -} = \sin^2 \theta \left(\frac{3}{2}g_2 + g_3\right), \\
& \mathcal{F}_{++,--} = 0, \quad \mathcal{F}_{++, - +} = \sin^2 \theta \left(-\frac{3}{2}g_2 + g_3\right), \\
(III) \quad & \mathcal{F}_{+ -, ++} = \mathcal{F}_{+ -, --} = -\frac{1}{2} \sin 2\theta g_3, \\
& \mathcal{F}_{+ -, + -} = -\mathcal{F}_{+ -, - +} = -g_1 - \frac{1}{2}(1 - 3 \cos^2 \theta)g_2, \\
(IV) \quad & \mathcal{F}_{0+, ++} = \frac{1}{\sqrt{2}}(-1 + 3 \cos^2 \theta)g_3, \quad \mathcal{F}_{0+, + -} = \frac{1}{2\sqrt{2}} \sin 2\theta(3g_2 + g_3), \\
& \mathcal{F}_{0+, --} = -\frac{1}{\sqrt{2}} \sin^2 \theta g_3, \quad \mathcal{F}_{0+, - +} = \frac{1}{2\sqrt{2}} \sin 2\theta(-3g_2 + g_3).
\end{aligned} \tag{4.17}$$

where θ is the nucleon production angle relative to \vec{B} direction.

4.3.3 Angular dependence for collisions of polarized deuterons

After summing over the polarization states of the produced particles, the cross section of the process $\vec{d} + \vec{d} \rightarrow n + {}^3He$, for definite deuteron polarizations, can be written as:

$$\begin{aligned}
\sigma_{00}(\theta) &= 2 \left(|\mathcal{F}_{00,++}|^2 + |\mathcal{F}_{00,+ -}|^2 \right) = 2|g_1 - g_2(1 - 3 \cos^2 \theta)|^2 + 8 \sin^2 \theta \cos^2 \theta |g_3|^2, \\
\sigma_{++}(\theta) &= \sum_{\lambda_3, \lambda_4} |\mathcal{F}_{++, \lambda_3 \lambda_4}|^2 = \sin^2 \theta \left[\frac{9}{2} \sin^2 \theta |g_2|^2 + 2(1 + \cos^2 \theta) |g_3|^2 \right], \\
\sigma_{+-}(\theta) &= \sum_{\lambda_3, \lambda_4} |\mathcal{F}_{+ -, \lambda_3 \lambda_4}|^2 = 2|g_1|^2 + 2Re g_1 g_2^*(1 - 3 \cos^2 \theta + \frac{1}{2}(1 - 3 \cos^2 \theta)^2 |g_2|^2 + 2 \sin^2 \theta \cos^2 \theta |g_3|^2, \\
\sigma_{0+}(\theta) &= \sum_{\lambda_3, \lambda_4} |\mathcal{F}_{0+, \lambda_3 \lambda_4}|^2 = 9 \sin^2 \theta \cos^2 \theta |g_2|^2 + (1 - 3 \cos^2 \theta + 4 \cos^4 \theta) |g_3|^2.
\end{aligned} \tag{4.18}$$

With the help of these formulas we can estimate the corresponding integral ratios:

$$R_{\lambda_1 \lambda_2} = \frac{\int_{-1}^{+1} \sigma_{\lambda_1 \lambda_2}(\theta) d \cos \theta}{\int_{-1}^{+1} d \cos \theta (d\sigma/d \cos \theta)_0},$$

which characterize the relative role of polarized collisions with respect to unpolarized ones:

$$R_{00} = \frac{3}{5} \frac{15 + 4r}{3 + 2r}, \quad R_{++} = \frac{36}{5} \frac{r}{3 + 2r}, \quad R_{+-} = \frac{12}{5} \frac{15 + r}{3 + 2r}, \quad R_{0+} = \frac{9}{5} \frac{r}{3 + 2r}, \tag{4.19}$$

where $r = (3|g_2|^2 + 2|g_3|^2)/|g_1|^2$. It is interesting that all these ratios depend on a single contribution of the moduli of the partial amplitudes, the ratio $r \geq 0$. The ratios $R_{\lambda_1 \lambda_2}$ are limited by:

$$1.2 \leq R_{00} \leq 3, \quad 0 \leq R_{++} \leq 3.6, \quad 1.2 \leq R_{+-} \leq 12, \quad 0 \leq R_{0+} \leq 0.9,$$

where the upper limits correspond to $g_2 = g_3 = 0$, (when only the g_1 amplitude is present), and the lower limits correspond to $g_1 = 0$ (for any amplitudes g_2 and g_3). But the exact values of $R_{\lambda_1\lambda_2}$ depend on the relative value of the partial amplitudes, through one parameter, r .

The general dependence of the differential cross section for $\vec{d} + \vec{d}$ -collisions, can be written in terms of partial cross sections $\sigma_{\lambda_1\lambda_2}$ as follows:

$$\frac{d\sigma}{d\Omega}(\vec{d} + \vec{d}) = (d_+^2 + d_-^2)\sigma_{++}(\theta) + d_0^2\sigma_{00}(\theta) + 2d_+d_-\sigma_{+-}(\theta) + 2d_0(d_+ + d_-)\sigma_{0+}(\theta), \quad (4.20)$$

where we used the evident relations between $\sigma_{\lambda_1\lambda_2}$: $\sigma_{++}(\theta) = \sigma_{--}(\theta)$, $\sigma_{0+}(\theta) = \sigma_{0-}(\theta)$, $\sigma_{+-}(\theta) = \sigma_{-+}(\theta)$, due to the P-invariance of the strong interaction, and the standard notation: d_+ , d_0 and d_- for different deuteron fractions in polarized plasma.

Using Eq. (4.20) one can find some interesting limiting cases. Setting for example, $d_+ = d_-$ (deuterons with tensor polarization only: $P_{zz} = 1 - 3d_0$, $P_z = 0$), one can obtain the following dependence of the differential cross section on P_{zz} :

$$\frac{d\sigma}{d\Omega}(\vec{d} + \vec{d}) = a_0(\theta) + 2P_{zz}a_1(\theta) + \frac{1}{2}P_{zz}^2a_2(\theta), \quad (4.21)$$

where the coefficients $a_i(\theta)$, $i = 0 - 2$, are linear combinations of the helicity cross sections $\sigma_{\lambda_1\lambda_2}$:

$$\begin{aligned} 9a_0(\theta) &= 2[\sigma_{++}(\theta) + \sigma_{+-}(\theta)] + \sigma_{00}(\theta) + 4\sigma_{+0}(\theta), \\ 9a_1(\theta) &= \sigma_{++}(\theta) + \sigma_{+-}(\theta) - \sigma_{00}(\theta) - \sigma_{+0}(\theta), \\ 9a_2(\theta) &= \sigma_{++}(\theta) + \sigma_{+-}(\theta) + 2\sigma_{00}(\theta) - 4\sigma_{+0}(\theta). \end{aligned} \quad (4.22)$$

So, measuring the P_{zz} -dependence of the cross section for $\vec{d} + \vec{d}$ collisions, one can determine all 3 coefficients $a_i(\theta)$ (at each angle θ). This allows to determine the individual helicity partial cross sections $\sigma_{\lambda_1\lambda_2}(\theta)$:

$$\begin{aligned} \sigma_{00}(\theta) &= a_0(\theta) - 4a_1(\theta) + 2a_2(\theta), \\ \sigma_{0+}(\theta) &= a_0(\theta) - a_1(\theta) - a_2(\theta), \\ \sigma_{++}(\theta) + \sigma_{+-}(\theta) &= 2a_0(\theta) + 4a_1(\theta) + a_2(\theta). \end{aligned} \quad (4.23)$$

In order to disentangle the $\sigma_{++}(\theta)$ and $\sigma_{+-}(\theta)$ contributions, an additional polarization observable has to be measured, from the collisions of vector polarized deuterons ($d_{\pm} = \frac{1}{3} \pm \frac{1}{2}P_z$, $d_0 = \frac{1}{3}$):

$$\frac{d\sigma}{d\Omega}(\vec{d} + \vec{d}) = a_0(\theta) + \frac{P_z^2}{2}(\sigma_{++}(\theta) - \sigma_{+-}(\theta)). \quad (4.24)$$

The linear P_z contribution is forbidden by the P-invariance of the strong interaction. Only the measurement of the P_z^2 contribution allows to separate the cross sections $\sigma_{++}(\theta)$ and $\sigma_{+-}(\theta)$.

This analysis is equivalent to the discussion of the complete experiment (in terms of helicity cross sections $\sigma_{\lambda_1\lambda_2}(\theta)$).

Finally let us derive the polarization properties of the neutrons in the process $\vec{d} + \vec{d} \rightarrow n + {}^3He$. Using Eqs. (4.17) for the helicity amplitudes, one can find for the θ dependence of the neutron polarization (for the different spin configurations of the colliding deuterons):

$$\begin{aligned} (n_+ - n_-)\sigma_{++}(\theta) &= 2 \sin^2 \theta d_+^2 \left[3 \text{Re} g_2 g_3^* + 2 \cos^2 \theta |g_3|^2 \right], \\ (n_+ - n_-)\sigma_{0+}(\theta) &= 2 d_0 d_+ \cos^2 \theta \left[-(1 - 2 \cos^2 \theta) |g_3|^2 + 3 \sin^2 \theta \text{Re} g_2 g_3^* \right], \\ (n_+ - n_-)\sigma_{00}(\theta) &= (n_+ - n_-)\sigma_{+-}(\theta) = 0, \end{aligned} \quad (4.25)$$

where n_+ and n_- are the fractions of polarized neutrons with spin parallel and antiparallel relative to the \vec{B} direction.

The production of unpolarized neutrons for 00-collisions of deuterons results from P-invariance, and for $-+$ collisions results from the identity of colliding deuterons and from the P-invariance.

4.3.4 Complete experiment for $d + d \rightarrow n + {}^3He$

Due to three complex partial amplitudes for the S-wave dd -interaction for the process $d + d \rightarrow n + {}^3He$, the measurement of a large number of observables is necessary, in order to perform the complete experiment. This study will be based on the formalism of the polarized structure functions, previously used in [67] for the process $d + {}^3H \rightarrow n + {}^4He$.

Let us consider the collisions of polarized deuterons $\vec{d} + \vec{d} \rightarrow n + {}^3He$. The differential cross section can be parametrized in the following general form:

$$\begin{aligned} \frac{d\sigma}{d\Omega} &= \left(\frac{d\sigma}{d\Omega} \right)_0 \left[1 + \mathcal{A}_1(\vec{k} \cdot \vec{Q}_1 + \vec{k} \cdot \vec{Q}_2) + \mathcal{A}_2 \vec{S}_1 \cdot \vec{S}_2 + \mathcal{A}_3 \vec{k} \cdot \vec{S}_1 \vec{k} \cdot \vec{S}_2 \right. \\ &\quad + \mathcal{A}_4 \vec{k} \cdot \vec{Q}_1 \vec{k} \cdot \vec{Q}_2 + \mathcal{A}_5 \vec{Q}_1 \cdot \vec{Q}_2 + \mathcal{A}_6 Q_{1ab} Q_{2ab} \\ &\quad \left. + \mathcal{A}_7(\vec{k} \cdot \vec{S}_1 \times \vec{Q}_2 + \vec{k} \cdot \vec{S}_2 \times \vec{Q}_1) \right], \quad Q_{1a} = Q_{1ab} k_b, \quad Q_{2a} = Q_{2ab} k_b, \end{aligned} \quad (4.26)$$

where \vec{S}_1 and \vec{S}_2 (Q_{1ab} and Q_{2ab}) are the vector (tensor) polarizations of the colliding deuterons. The real coefficient \mathcal{A}_1 describes the tensor analyzing power in $\vec{d} + \vec{d} \rightarrow n + {}^3He$, $\mathcal{A}_2 - \mathcal{A}_7$ are the spin correlation coefficients in $\vec{d} + \vec{d} \rightarrow n + {}^3He$. The coefficients $\mathcal{A}_1 - \mathcal{A}_6$ are T-even polarization observables and \mathcal{A}_7 is the T-odd one (due to the specific correlation of the vector polarization of one deuteron and the tensor polarization of the other deuteron). Note that these coefficients \mathcal{A}_i can not fix the relative phases of the singlet amplitudes g_1 and g_2 (from one side)

and the triplet amplitude g_3 (from the other side). The complete experiment has to be more complex than the determination of the polarization observables \mathcal{A}_i . The polarization transfer coefficients from the initial deuteron to the produced fermion (n or 3H) have to be measured, too.

After summing over the polarizations of the produced particles in $\vec{d} + \vec{d} \rightarrow n + {}^3He$, the following expressions can be found, for the coefficients \mathcal{A}_i , $i = 1 - 7$, in terms of the partial amplitudes g_k , $k = 1 - 3$:

$$\begin{aligned}
-\frac{9}{2}\mathcal{A}_1 \left(\frac{d\sigma}{d\Omega} \right)_0 &= 3|g_2|^2 + |g_3|^2 + 6Re\ g_1g_2^*, \\
\mathcal{A}_2 \left(\frac{d\sigma}{d\Omega} \right)_0 &= -|g_1|^2 + 2|g_2|^2 + |g_3|^2 - Re\ g_1g_2^*, \\
\mathcal{A}_3 \left(\frac{d\sigma}{d\Omega} \right)_0 &= -3|g_2|^2 - |g_3|^2 + 3Re\ g_1g_2^*, \\
\frac{9}{4}\mathcal{A}_4 \left(\frac{d\sigma}{d\Omega} \right)_0 &= 9|g_2|^2 - 4|g_3|^2 \tag{4.27} \\
\frac{9}{2}\mathcal{A}_5 \left(\frac{d\sigma}{d\Omega} \right)_0 &= -6|g_2|^2 + 6Re\ g_1g_2^* + 2|g_3|^2, \\
\frac{9}{2}\mathcal{A}_6 \left(\frac{d\sigma}{d\Omega} \right)_0 &= |g_1|^2 + |g_2|^2 - 2Re\ g_1g_2^*, \\
\mathcal{A}_7 \left(\frac{d\sigma}{d\Omega} \right)_0 &= -2\ Im\ g_1g_2^*,
\end{aligned}$$

where $(d\sigma/d\Omega)_0$ is the differential cross section with unpolarized particles:

$$\left(\frac{d\sigma}{d\Omega} \right)_0 = \frac{2}{9} [3|g_1|^2 + 6|g_2|^2 + 4|g_3|^2] = \frac{2}{9}|g_1|^2(3 + 2r).$$

Using these expressions, the following relations can be found between the coefficients \mathcal{A}_i :

(a) linear: between T-even polarization observables,

$$\mathcal{A}_2 + \mathcal{A}_3 + \frac{9}{2}\mathcal{A}_6 = \mathcal{A}_1 + \mathcal{A}_4 - \frac{1}{3}\mathcal{A}_3 + \frac{7}{4}\mathcal{A}_5 = 0$$

(b) quadratic, relating the T-odd asymmetry \mathcal{A}_7 with the T-even coefficients \mathcal{A}_i , $i = 1 - 6$;

$$\frac{9}{4}(1 + \mathcal{A}_1^2 - \mathcal{A}_7^2) = \mathcal{A}_2^2 + (\mathcal{A}_2 + \mathcal{A}_3)^2 + 6(\mathcal{A}_1\mathcal{A}_2 + \mathcal{A}_1\mathcal{A}_3 + \mathcal{A}_2\mathcal{A}_3)$$

Therefore, the measurements of $(d\sigma/d\Omega)_0$ and 3 coefficients \mathcal{A}_i , $i = 1 - 3$, allow to find the moduli of all S-wave partial amplitudes g_k , $k = 1 - 3$, and the relative phase of the singlet amplitudes g_1 and g_2 :

$$\begin{aligned} 18|g_1|^2 &= (9 - 12\mathcal{A}_2 - 4\mathcal{A}_3) \left(\frac{d\sigma}{d\Omega} \right)_0, \\ -18|g_2|^2 &= (9 + 18\mathcal{A}_1 + 6\mathcal{A}_2 + 10\mathcal{A}_3) \left(\frac{d\sigma}{d\Omega} \right)_0, \\ 2|g_3|^2 &= (3 + 3\mathcal{A}_1 + 2\mathcal{A}_2 + 2\mathcal{A}_3) \left(\frac{d\sigma}{d\Omega} \right)_0, \\ 18Re\ g_1g_2^* &= (-9\mathcal{A}_1 + 2\mathcal{A}_3) \left(\frac{d\sigma}{d\Omega} \right)_0. \end{aligned}$$

So these measurements can be considered as the first step of the complete experiment for the process $d + d \rightarrow n + {}^3He$ in the near threshold conditions.

Using these expressions, one can find the following expression for the ratio r :

$$r = 3\frac{1+a}{1-2a}, \quad a = \frac{2}{9}(3\mathcal{A}_2 + \mathcal{A}_3).$$

The results obtained here on the angular dependence and the reaction rate dependence on the nuclei polarizations, can be used as a guideline in the conception of magnetic fusion reactors. The polarization of the produced particles is also important, as it can help the fusion process in a working reactor. For example, in a reactor based on $d + {}^3H$ -fuel, the intensive flux of 14 MeV neutrons can be used in the Li -blanket, not only for its heating, with consequent production of electric power, but also to produce extra 3H -fuel, through the processes: $n + {}^6Li \rightarrow {}^3H + {}^4He$ and $n + {}^7Li \rightarrow n + {}^3H + {}^4He$. Due to the definite polarization properties of these reactions, one can increase, in principle, the yield of 3H .

We showed that the polarization and the angular distribution of the neutrons, produced in the process $d + {}^3H \rightarrow n + {}^4He$ depends strongly on the relative value of the two possible partial amplitudes. The presence of a contribution (even relatively small) of the $\mathcal{J}^P = 1/2^+$ amplitude is very important for polarization phenomena.

For the reaction $d + d \rightarrow n + {}^3He$ (with three independent threshold partial amplitudes) the situation is more complicated. The $d + d$ -reactions produce energetic neutrons and tritium, and should be suppressed in a $d + {}^3He$ reactor.

The detailed information about partial amplitudes of different reactions can be obtained, in a model independent way, through the realization of the complete experiment. Even at low energy, where the spin structure of all matrix elements is

highly simplified, the complete experiment includes the scattering of a polarized beam on a polarized target. These experiments, which are absent up to now, allow the full reconstruction of the spin structure of the threshold matrix elements.

The main results derived above can be summarized as follows:

- We give a model independent parametrization of the spin structure of the threshold matrix elements for the reactions: $d + d \rightarrow n + {}^3He$ and $d + {}^3H \rightarrow n + {}^4He$.
- The angular distributions of the reaction products for $\vec{d} + \vec{d}$ and $\vec{d} + {}^3\vec{H}e$ -collision shows a strong dependence on the polarizations of the colliding particles, and it can be very important to optimize the blanket and the shielding of a reactor.
- The polarization properties of neutrons, produced in the processes $d + {}^3H \rightarrow n + {}^4He$ and $d + d \rightarrow n + {}^3He$ are derived for collisions of polarized particles.

Chapter 5

Polarization phenomena in astrophysical processes

5.1 Low energy polarized collisions and astrophysics

The experimental and theoretical study of the collisions of light nuclei (p , d , ${}^3\text{H}$, ${}^3\text{He}$, ${}^4\text{He}$..) at very low energies has always been motivated by questions in fundamental physics and by interesting possible applications in particular in the astrophysics domain [98]. Many works in the past have been devoted to the experimental study of these reactions, in particular cross section measurements, but only recently some polarization observables such as, for example, analyzing powers have become available [99]. Polarization phenomena are important also in order to understand the mechanisms of the electromagnetic processes such as $n+p \rightarrow n+\gamma$, $p+d \rightarrow {}^3\text{He}+\gamma$, $n+d \rightarrow {}^3\text{H}+\gamma$, $d+d \rightarrow {}^4\text{He}+\gamma$, $d+{}^3\text{He} \rightarrow {}^5\text{Li}+\gamma$ etc., [99] which are at the basis of models of primordial nucleosynthesis in early Universe.

The strong magnetic field ($B \simeq 10^{12-14} \text{ G}$) on the surface of neutron stars [100] must induce large degree of polarization for heavy particles like protons, neutrons, deuterons, etc. The reaction rates for all the above mentioned reactions at low energy depend strongly on the polarization properties of the colliding nuclei. The astrophysical S-factors, determining the threshold behavior of cross sections, are very important parameters in models of big-bang nuclear synthesis, stellar hydrogen burning, solution of the Sun-neutrino puzzle etc. Moreover possible large magnetic fields in the early Universe [101, 102, 103, 104, 105], $B \simeq 10^{20} \text{ G}$, may have influenced the process of nucleosynthesis of light elements. The most evident effect of a strong magnetic field concerning the "deformation" of electrons in atoms and in specific Landau quantization of the electron behavior has been extensively studied for different electromagnetic conversion processes such as magnetic bremsstrahlung (synchrotron radiation), magnetic e^+e^- -pair

production, magnetic Cherenkov radiation, photon splitting, etc. This deformation is especially important in calculations of reaction rates for the weak processes involving an electron:

$$e^- + p \rightleftharpoons n + \nu_e, \bar{\nu}_e + p \rightleftharpoons n + e^+, n \rightarrow p + e^- + \bar{\nu}_e, \quad (5.1)$$

which play an essential role in the big-bang nucleosynthesis and neutron star cooling [106, 107].

Of course, magnetic deformation is not so important for heavier particles: protons, neutrons, deuterons..., due to the small value of magnetic moment in comparison with electrons, but a strong magnetic field *can polarize these particles*. So, due to the strong dependence of the corresponding reaction rates on the polarization states of colliding particles, this effect must have important consequences on nucleosynthesis. For example, it would change the standard predictions of abundances of light elements in Universe, such as d , ${}^3\text{He}$, ${}^4\text{He}$, ${}^7\text{Li}$ and ${}^9\text{Be}$, because all these elements are produced in processes with an essential spin dependence of the corresponding matrix elements. Note, that the relative abundances of these elements provide now a reliable method to determine such important characteristics of the Universe as the baryon mass density parameter Ω_B [108]. This parameter is very important to discriminate between different models. The precise determination of d and ${}^3\text{He}$ abundances will definitely constrain the upper bound of Ω_B -values, whereas ${}^7\text{Li}$ and ${}^9\text{Be}$ abundances lead to a constraint on the lower bound of the Ω_B -values .

Reaction rates for processes as $n+p \rightarrow d+\gamma$, $n+d \rightarrow {}^3\text{H}+\gamma$, $p+d \rightarrow {}^3\text{He}+\gamma\dots$, which are the most important in nucleosynthesis in early Universe and in hydrogen burning in stars and in the cooling process of neutron stars, essentially are changed in case of collision of polarized particles. As far as we know, spin degrees of freedom have not been taken into account in the analysis of possible nuclear processes in nucleosynthesis and neutron stars. Polarization phenomena in collisions of light nuclei may represent an additional effect in any estimation of the abundances of the light elements in the Universe. Discussions about the relative role of various effects as anisotropy and baryon inhomogeneities, about the special neutrino properties (oscillations, degeneracy, electromagnetic characteristics, massive neutrinos), cosmic strings etc. [108]) must consider polarization phenomena, also.

Our main goal here is to predict the dependence of the cross sections on the polarization of colliding particles in some cases, where this problem can be treated in model independent way: this can be done at threshold, in the framework of our well adapted formalism.

5.2 The reaction $p + p \rightarrow d + e^+ + \nu_e$

Let us consider the process $p + p \rightarrow d + e^+ + \nu_e$. At the keV energy scale for the colliding protons, we can consider that the S-wave approximation for colliding protons is correct. This allows to establish the spin structure of the corresponding matrix element in a model independent way. Due to Pauli principle, we have in this case only one initial state, $\mathcal{J}^P = 0^+$, that produces the following transitions (taking into account the strong violation of P-invariance in this weak process) $0^+ \rightarrow M1, E1_t, E1_\ell, E1_s$, where we describe the intermediate W^* -boson in the process $p + p \rightarrow d + W^*$ as a virtual photon, using a formalism of multipole decomposition; the indexes ℓ and t correspond to transversal and longitudinal components of the W -boson polarizations, the index s corresponds to the $4 - th$ component of the axial hadron current (due to the non-conservation of this current). The dynamics of the considered process is contained in the k^2 -dependence of the corresponding form factors, which describe the above mentioned multipole transitions, making the matrix element quite complicated, even at threshold.

However some of the polarization observables can be calculated without knowing this dynamics. For example, the dependence of the cross section on the polarizations \vec{P}_1 and \vec{P}_2 which of the colliding protons can be predicted exactly, using only the singlet nature of the initial pp -state for collisions in S-state:

$$\sigma(\vec{P}_1, \vec{P}_2) = \sigma_0(1 - \vec{P}_1 \cdot \vec{P}_2). \quad (5.2)$$

This simple dependence has a model independent nature and shows the strong effects of colliding particle polarizations. It results in a decrease of cross section in collision of particles with parallel polarizations. This condition can typically be realized on the surface of neutron stars, where protons can be polarized by the strong magnetic field. Note that the deuterons, produced in such pp -collisions, must be polarized, with respect to the direction of the magnetic field, so this polarization must be taken into account in the following reactions which take place in the proton-proton chain of hydrogen burning: $d + p \rightarrow {}^3He + \gamma$, ${}^3He + {}^3He \rightarrow {}^4He + 2p$ etc., which are also characterized by a strong spin dependence of the corresponding matrix element.

5.3 The big-bang and the reaction $n + p \rightarrow d + \gamma$.

In the standard big-bang model the ratio of the proton to neutron numbers was determined through the reactions (5.1) mediated by the weak interaction. Deuterons are produced through the process $n + p \rightarrow d + \gamma$, but at large temperature the probability that they undergo photo-dissociation is very high, due to the large number of energetic photons (the ratio of photons to baryons is $\simeq 10^9$). So a significant concentration of deuterons can not be found until the temperature has dropped below the deuteron binding energy. At $T \simeq 10^9 K$ deuterons begin to

be formed and then the following reactions of primordial nucleosynthesis proceed rapidly: $p + d \rightarrow {}^3\text{He} + \gamma$, $n + d \rightarrow {}^3\text{H} + \gamma$, $d + d \rightarrow {}^3\text{H} + p$, $d + d \rightarrow {}^3\text{He} + n$, ${}^3\text{H} + d \rightarrow {}^4\text{He} + n$, ${}^3\text{He} + d \rightarrow {}^4\text{He} + p$ and ${}^3\text{He} + {}^3\text{He} \rightarrow {}^4\text{He} + 2p$. With the production of ${}^4\text{He}$, the primordial nucleosynthesis comes to the end. It is the reaction $n + p \rightarrow d + \gamma$ which essentially starts this chain.

In presence of strong magnetic field in the early Universe, polarization effects for all these processes may become important. The capture of thermal neutrons in $n + p \rightarrow d + \gamma$ is characterized by the following transitions:

$$S_i = 0 \rightarrow M1, \quad S_i = 1 \rightarrow M1 \text{ and } E2,$$

where S_i is the total spin of the system $n + p$. From the classical deuteron electrodynamics, one can find that singlet $M1$ transition dominates at low energy, with the following structure of the corresponding matrix element (Fermi radiation)[109]:

$$\mathcal{M}(M1) = g_M \left(\vec{e}^* \times \vec{k} \cdot D^* \right) (\tilde{\chi}_2 \sigma_y \chi_1), \quad (5.3)$$

where \vec{e} is the 3-vector polarization of the produced photon and \vec{k} is the unit vector along the 3-momentum of the photons. Due to the singlet nature of the considered transition, the cross section has a definite dependence on the polarizations \vec{P}_1 and \vec{P}_2 of the colliding nucleons (after summing over the polarizations of the produced γ and d):

$$\frac{d\sigma}{d\Omega}(\vec{n}\vec{p} \rightarrow d\gamma) = \left(\frac{d\sigma}{d\Omega} \right)_0 (1 - \vec{P}_1 \cdot \vec{P}_2). \quad (5.4)$$

The presence of a single dynamical constant g_M in the matrix element (5.3) allows to predict numerical values for all polarization observables of the considered process in a model independent form. For example, the polarization properties of the produced deuterons are: $\vec{S} = 0$ and $Q_{zz} = 1/2$ (see Eq.(2.1), for any polarization of colliding nucleons. Such specific polarization properties strongly affect the production rates of the deuteron induced reactions in the primordial nucleosynthesis.

In the considered reaction, $n + p \rightarrow d + \gamma$, the range of the $M1$ -radiation is limited by the thermal energy of neutrons, and at higher temperatures the $E1$ -radiation must be more important. In the general case the $E1$ -radiation is characterized by a large number of independent multipole transitions, corresponding to different values of \mathcal{J} and S_i . But the situation is essentially simplified, due to the Bethe-Peierls [110] Ansatz on the spin independence of the $E1$ -radiation. The resulting matrix element can be written as:

$$\mathcal{M}(E1) = g_E (\vec{e} \cdot \vec{q}) (\tilde{\chi}_2 \sigma_y \vec{\sigma} \cdot D^* \chi_1),$$

where \vec{q} is the unit vector along the 3-momentum of the colliding nucleons and g_E is the amplitude of the $E1$ -transition. After summing over the polarization

states of the produced γ and d one can find the following dependence of the cross section on the polarization of the colliding particles:

$$\sigma_E(\vec{n}\vec{p} \rightarrow d\gamma) = \sigma_0 \left(1 + \vec{P}_1 \cdot \vec{P}_2\right). \quad (5.5)$$

Neglecting the possible interference of $M1$ - and $E1$ - transitions, one can predict the resulting dependence:

$$\sigma(\vec{n}\vec{p} \rightarrow d\gamma) = \sigma_0 \left(1 + \mathcal{A}\vec{P}_1 \cdot \vec{P}_2\right), \quad \mathcal{A} = (|g_E|^2 - |g_M|^2)/(|g_E|^2 + |g_M|^2), \quad (5.6)$$

where the asymmetry coefficient \mathcal{A} strongly depends on the temperature.

5.4 Radiative capture of nucleons by deuterons

In the keV energy region, the processes $n + d \rightarrow {}^3H + \gamma$ and $p + d \rightarrow {}^3He + \gamma$ play an important role in nuclear astrophysics and in nuclear physics. In the standard big-bang nucleosynthesis theory the corresponding reaction rates are necessary to estimate the 3He -yield as well as the abundances of other light elements. In nuclear physics these reactions are also very interesting since one can expect large contributions of meson exchange currents.

The spin structure of the matrix elements for $N + d$ radiative capture is complicate also for the low energy interaction, as we have here 3 independent multipole transitions (allowed by the P -parity and the total angular momentum conservation): $\mathcal{J}^P = \frac{1}{2}^+ \rightarrow M1$ and $\mathcal{J}^P = \frac{3}{2}^+ \rightarrow M1$ and $E2$, with the following parametrization of the corresponding contributions to the matrix element:

$$\begin{aligned} & i(\chi_3^\dagger \chi_1)(\vec{D} \cdot \vec{e}^* \times \vec{k}), \\ & (\chi_3^\dagger \sigma_a \chi_1)(\vec{D} \times [\vec{e}^* \times \vec{k}]_a), \\ & \chi_3^\dagger (\vec{\sigma} \cdot \vec{e}^* \vec{D} \cdot \vec{k} + \vec{\sigma} \cdot \vec{k} \vec{D} \cdot \vec{e}^*) \chi_1, \end{aligned} \quad (5.7)$$

where χ_1 and χ_3 are the 2-component spinors of initial nucleon and final 3He (or 3H).

The first two structures in (5.7) correspond to the $M1$ radiation. To obtain the spin structure, which corresponds to a definite value of \mathcal{J} for the entrance channel, it is necessary to build special linear combinations of products $\vec{D}\chi_1$ and $\vec{\sigma} \times \vec{D}\chi_1$, with $\mathcal{J}^P = \frac{1}{2}^+$ or $\mathcal{J}^P = \frac{3}{2}^+$:

$$\vec{\phi}_{1/2} = (i\vec{D} + \vec{\sigma} \times \vec{D})\chi_1 \quad \text{and} \quad (2i\vec{D} - \vec{\sigma} \times \vec{D})\chi_1.$$

For both possible magnetic dipole transitions with $\mathcal{J}^P = \frac{1}{2}^+$ (amplitude g_1) and $\mathcal{J}^P = \frac{3}{2}^+$ (amplitude g_3) we can write:

$$g_1 : \quad \chi_3^\dagger (i\vec{D} \cdot \vec{e}^* \times \vec{k} + \vec{\sigma} \times \vec{D} \cdot \vec{e}^* \times \vec{k}) \chi_1,$$

$$g_3 : \chi_3^\dagger(i\vec{D} \cdot \vec{e}^* \times \vec{k} + \vec{\sigma} \times \vec{D} \cdot \vec{e}^* \times \vec{k})\chi_1. \quad (5.8)$$

The general dependence for the cross section of S-wave particle collisions (with spins 1/2 and 1) can be parametrized by the following formula:

$$\begin{aligned} \frac{d\sigma}{d\Omega}(\vec{N}\vec{d} \rightarrow {}^3He\gamma) = & \left(\frac{d\sigma}{d\Omega}\right)_0 [1 + a_1(Q_{ab}k_a k_b) + a_2\vec{S} \cdot \vec{P} + a_3\vec{k} \cdot \vec{P} \vec{k} \cdot \vec{S} \\ & + a_4\vec{k} \cdot \vec{Q} \times \vec{P}], \quad Q_a \equiv Q_{ab}k_b, \end{aligned} \quad (5.9)$$

where \vec{P} is the pseudovector of proton polarization, \vec{S} and Q_{ab} are the vector and tensor deuteron polarizations, defined above. The real coefficients $a_2 - a_4$ in (5.9) characterize the spin correlation coefficients and the coefficient a_1 is the tensor analyzing power for the collisions of unpolarized protons with polarized deuterons.

After integration in Eq. (5.9) over the \vec{k} -direction, one can find for the total cross section:

$$\sigma(\vec{N}\vec{d}) = \sigma_0(1 + a\vec{P} \cdot \vec{S}), \quad a = a_2 + a_3/3,$$

i.e. the dependence from the tensor deuteron polarization disappears.

Using expressions (5.8), one can obtain the following formulas for the corresponding differential cross-sections of radiative capture of polarized nucleons by polarized deuterons:

$$\begin{aligned} \frac{d\sigma}{d\Omega}(\vec{N}\vec{d}) = & \left(\frac{d\sigma}{d\Omega}\right)_0 (1 - \vec{S} \cdot \vec{P}), \quad \text{if } g_1 \neq 0, \\ \frac{d\sigma}{d\Omega}(\vec{N}\vec{d}) = & \left(\frac{d\sigma}{d\Omega}\right)_0 \left(1 - \frac{1}{4}\vec{S} \cdot \vec{P} + \frac{3}{4}\vec{k} \cdot \vec{P} \vec{k} \cdot \vec{S} + Q_{ab}k_a k_b\right), \quad \text{if } g_3 \neq 0. \end{aligned} \quad (5.10)$$

So, after \vec{k} -integration one can find for the total cross sections:

$$\sigma(\vec{N}\vec{d}) = \sigma_0 (1 - \vec{S} \cdot \vec{P}), \quad \text{if } g_1 \neq 0,$$

$$\sigma(\vec{N}\vec{d}) = \sigma_0, \quad \text{if only } g_3 \neq 0,$$

i.e. the amplitude g_3 cannot produce polarization dependence in the total cross section of $N + d$ -interactions.

5.5 Magnetic field and Polarization

For the reactions discussed above, namely $p + p \rightarrow d + e^+ + \nu_e$ and $n + p \rightarrow d + \gamma$, we have derived a simple dependence of the cross section on the polarizations of the colliding particles, which does not depend on the model chosen to describe the dynamics of the reaction and the structure of the particles involved. For

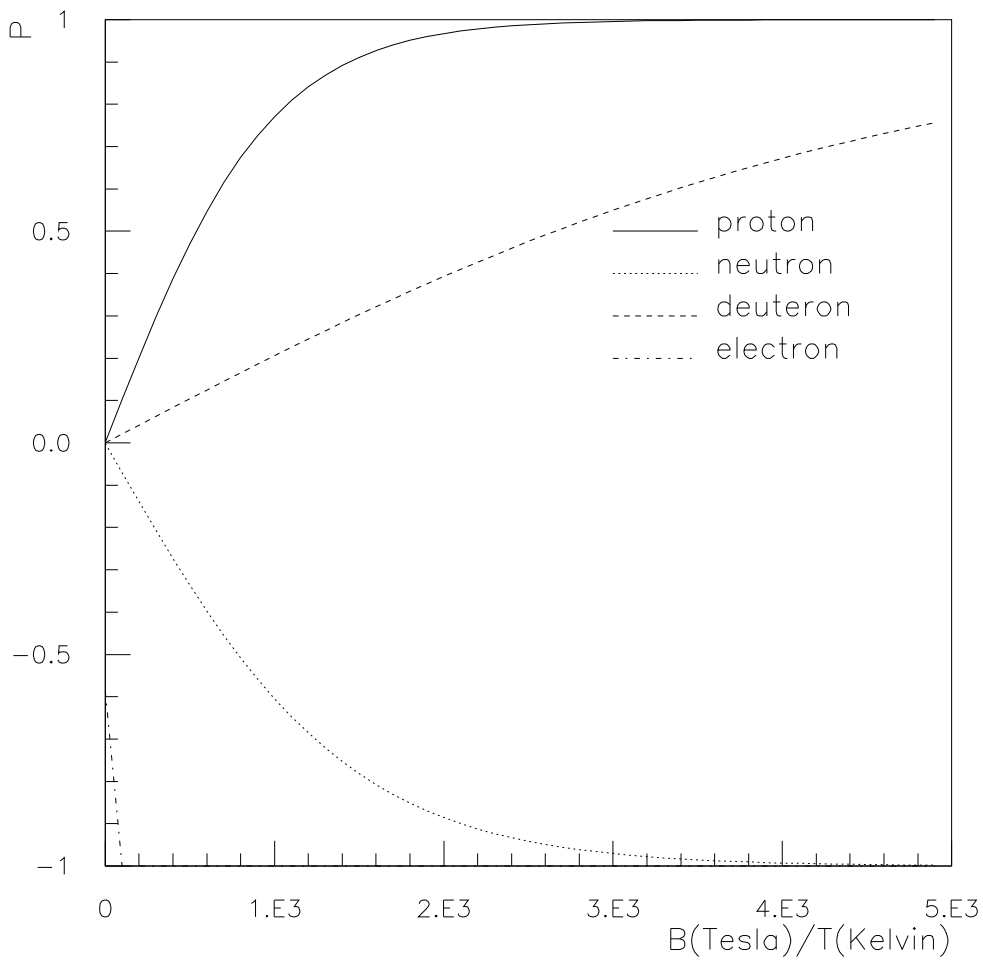

Figure 5.1: Dependence of polarization on the ratio of the magnetic field [Tesla] over the temperature [K], for different particles: proton (full line), neutron (dotted line), deuteron (dashed line) and electron (dashed-dotted line)

these cases, it is then possible to find a simple relation between the ratio of polarized/unpolarized cross section and the ratio of magnetic field/temperature.

The polarization P , of I -spin particles, induced by a magnetic field B , at thermal equilibrium with temperature T , is given by the Brillouin function:

$$P_I(x) = \frac{2I+1}{2I} \cot\left(\frac{2I+1}{2I}x\right) - \frac{1}{2I} \cot\left(\frac{1}{2I}x\right),$$

with $x = \hbar\gamma IB/kT$, γ the gyromagnetic ratio and k the Boltzmann constant. For spin $I = 1/2$ we find at thermal equilibrium: $P = th\frac{\gamma\hbar B}{2kT}$. For a given kind of particles, the polarization depends only on the ratio B/T (Fig. 5.1). As an example, it is possible to apply the previous formalism, to evaluate the changing of the cross section due to the magnetic field for the reactions $p+p \rightarrow d+e^+\nu_e$ and for the $E1$ -radiation in $n+p \rightarrow d+\gamma$. Typically for these cases, we have shown that a model independent expression of the cross section as a function of the polarizations of the colliding particles can be found: Eqs. (5.2) and (5.5). We illustrate this dependence in Fig. 5.2, for $T = 10^7$ K, which is a typical value for the temperature in the center of the Sun. In these two cases the polarized cross section (for collisions of particles with parallel polarizations) is lower than the unpolarized one. Recently a limit on possible deviations of the cross section for the reaction $p+p \rightarrow d+e^+\nu_e$ from SSM based on heliosystemology constraints, has been given: $0.94 \leq S/S_{SSM} \leq 1.18$ [111]. Assuming the existence of a magnetic field in the Sun (which has the effect to polarize protons), its upper limit, allowed by this constraint, would be 2.5×10^9 T. Such small sensitivity is a result of a quadratic dependence of the cross section on proton polarization.

The limit given here is some order of magnitude larger than the current estimations. However, here, it is not necessary to assume that the magnetic field in the Sun is the uniform and constant in time. Our estimate is correct also in case of a magnetic field, resulting from some local fluctuations in plasma, with eventually different directions in different regions. Therefore the possibility [112], that the strong magnetic field in the core of the Sun, present at its creation, would have been raised to surface during a short time, would not affect the considered analysis. It must also be noticed that in the SSM predictions no magnetic field is included.

In Fig. 5.3 we report, for the same reactions as in Fig. 5.2, the dependence of the ratio of polarized on unpolarized cross section on the temperature, for a magnetic field of $B = 10^9$ T which is the value usually quoted for the magnetic field at the surface of neutron stars. This ratio varies rapidly from 0 to 1 for about one order of magnitude of variation in the temperature (in the range 2×10^9 K to 5×10^{10} K).

In this chapter, we showed the importance of polarization phenomena for collisions of light nuclei at thermonuclear energies. The results of our analysis can be summarized in the following way:

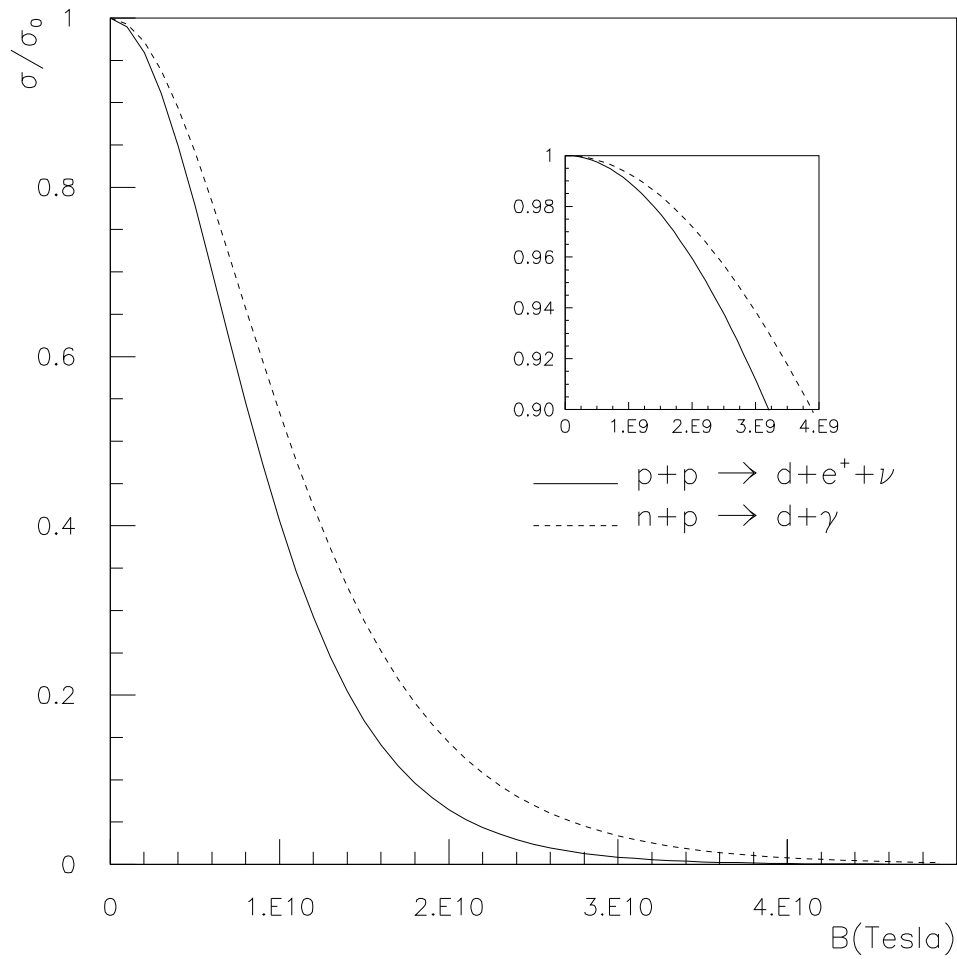

Figure 5.2: Dependence of the polarized on unpolarized cross section ratio on the magnetic field expressed in Tesla for a temperature of 10^7 K, for two reactions: $p + p \rightarrow d + e^+ + \nu_e$ (full line) and $n + p \rightarrow d + \gamma$ (dashed line).

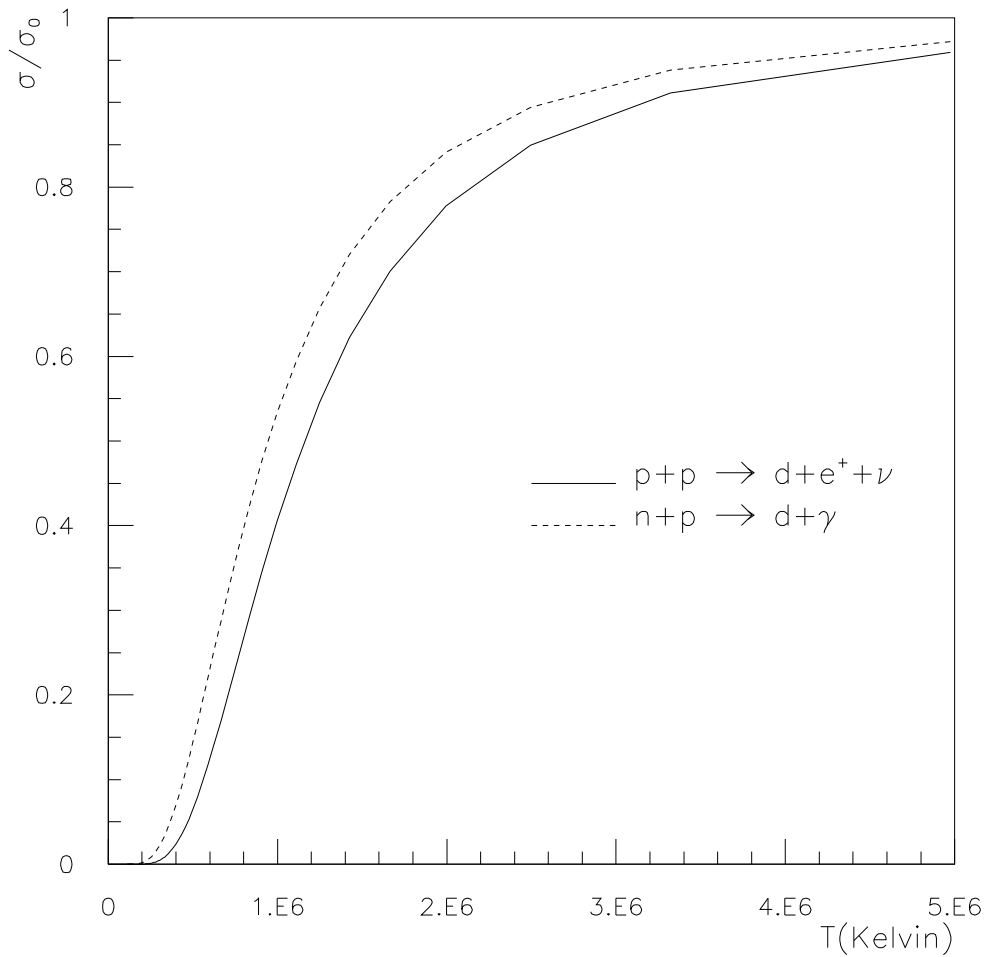

Figure 5.3: Dependence of the polarized on unpolarized cross section ratio on the temperature expressed in Kelvin, for a magnetic field of 10^9 T, typical of neutron stars, for two reactions: $p + p \rightarrow d + e^+ + \nu_e$ (full line) and $n + p \rightarrow d + \gamma$ (dashed line)

- In general case the polarization effects are large, in absolute value, for all reactions, which are responsible for the primordial nucleosynthesis in the Universe, and for the nuclear processes in usual stars, like Sun, and in neutron stars.
- A strong magnetic field, which is present in neutron stars and in the early Universe, can polarize protons, neutrons, deuterons.. This polarization changes the reaction rates for fundamental processes, participating in primordial nucleosynthesis.
- The ejectiles of the considered reactions are also polarized, if at least one of the colliding particles is polarized. This induced polarization has to change the relative role of different reactions in the chain of primordial nucleosynthesis.
- The model-independent result on the dependence of the cross section for the process $p+p \rightarrow d+e^++\nu_e$ on the polarizations of the colliding protons, namely, $\sigma(\vec{P}_1, \vec{P}_2) = \sigma_0(1 - \vec{P}_1 \cdot \vec{P}_2)$, has to be taken into account for the analysis of processes in hydrogen burning stars, like Sun.
- In the presence of magnetic field, the cross section of radiative capture of neutrons by protons, $n+p \rightarrow d+\gamma$, has to show a large dependence on temperature, as a result of the contributions of magnetic and electric dipole radiations.
- The polarization observables for $n+{}^3\text{He} \rightarrow {}^4\text{He}+\gamma$ and $p+{}^3\text{H} \rightarrow {}^4\text{He}+\gamma$ can be predicted exactly. On the other hand, for the calculation of polarization effects in the processes $n+d \rightarrow {}^3\text{H}+\gamma$ and $p+d \rightarrow {}^3\text{He}+\gamma$ it is necessary to have dynamical information relative to multipole amplitudes.
- The limitations on the deviations of the cross section for the reaction $p+p \rightarrow d+e^++\nu_e$ from the SSM value, given by helioseismology constraints, can give a *model independent* estimation of the maximum possible value of the magnetic field in Sun core, $B < 2 \cdot 10^9$ T.

Chapter 6

Conclusions

We showed above that the threshold region for different hadronic and nuclear reactions (induced by all known interactions, weak, electromagnetic and strong) has some universal properties, concerning the analysis of the spin structure of the corresponding matrix elements and the polarization phenomena. It is important that this universal behavior, being essentially model independent, is dictated by the most general symmetry of fundamental interactions, such as the Pauli principle, the conservation of total angular momentum, the C- and P- invariance and the isotopic invariance.

The above developed polarization formalism allows to express definite and transparent statements about polarization phenomena in different reactions. Even complicated processes, such as $p + p \rightarrow p + p + V^0$, of vector meson production, where all five particles are with non zero spin, can be exactly described at threshold in terms of a single amplitude.

Note that such symmetry analysis of the spin structure of different threshold matrix elements must be considered as the first necessary step, which allows to separate strong kinematical predictions from dynamical, model-dependent assumptions. Note also, that, as a rule, the threshold polarization phenomena in hadronic and nuclear collisions, which are non-zero, due to symmetry properties, take their maximal value.

We proved above that in some cases the polarization phenomena are nonuseful for testing the dynamics of the considered reaction, because such polarizations are often model independent.

We showed the connection of polarization phenomena in different reactions of NN -collisions with isotopic invariance of the strong interaction, therefore namely polarization observables in np -collisions can be used as an independent and original method of testing the isotopic invariance.

We stressed the importance of polarization phenomena in some non standard applications to the thermonuclear fusion reaction with polarized fuel. In this way it is possible to solve such principal problems, as the essential decreasing of production of radioactive 3He and intensive neutron beams as well as the effective

arrangement of the reaction shielding and blanket. Nontrivial application of polarization phenomena can be found in astrophysics, where the strong magnetic field can change essentially the reaction rates, due to non-zero polarization of heavy particles, such as protons, neutrons, deuterons, etc..

So, finally, we can conclude that the analysis of polarization phenomena in threshold region, for hadron and nuclear interactions, can be done in a general form, with many interesting applications.

Bibliography

- [1] V. Bernard, N. Kaiser, Ulf-G. Meissner, Phys. Lett. B **378**, 337 (1996).
- [2] E. Tomasi-Gustafsson *et al.*, Nucl. Instr. and Meth. **A420** 90 (1999).
- [3] N. Christ and T. D. Lee. Phys. Rev. **143**, 1310 (1966).
- [4] P. W. Keaton Jr., J. L. Gammel and G. G. Ohlsen, Ann. Phys., **85**, 152 (1974).
- [5] B. Tatischeff *et al.*, Phys. Rev. C **62**, 054001 (2000).
- [6] A. M. Bergdolt et al. Phys. Rev. **D48**, R2969 (1993).
- [7] E. Chiavassa *et al.*, Phys. Lett. **B322**, 270 (1994).
- [8] H. Calen *et al.*, Phys. Lett. **B36**, 39 (1996).
- [9] E. Chiavassa *et al.*, Phys. Lett. **B337**, 192 (1994).
- [10] J. F. Germond and C. Wilkin, Nucl. Phys. **A518**, 308 (1990).
- [11] J. M. Laget, F. Wellers and J.F. Lecomte, Phys. Lett. **B257**, 254 (1991) .
- [12] T. Vetter et. al. Phys. Lett. **B263**, 153 (1991).
- [13] J. Ellis, M. Karliner, D. E. Kharzeev, and M. G. Sapozhnikov, Phys. Lett. **B353** (1995) 319.
- [14] S. Okubo, Phys. Lett. **5**, 165 (1963).
- [15] G. Zweig, CERN Reports TH401 and TH412 (1964).
- [16] J. Iizuka, K. Okada, and O. Shito, Prog. Theor. Phys. Suppl. **37**, 38 (1966).
- [17] H. J. Lipkin, Phys. Lett. **60**, 371 (1976).
- [18] C. B. Dover and P. M. Fishbane, Phys. Rev. Lett. **62**, 2917 (1989) .
- [19] M. P. Locher, Y. Lu and B. S. Zou, Z. Phys. **A347**, 281 (1994).

- [20] D. Buzatu and F. Lev, Phys. Lett **B329**, 143 (1994).
- [21] J. Ellis, E. Gabathaler and M. Karliner, Phys. Lett. **B217**, 173 (1989).
- [22] The Asterix Collaboration, J. Reifenrother *et al.* Phys. Lett. **B267**, 299 (1991).
- [23] The Crystal Barrel Collaboration, C. Amsler *et al.* Phys. Lett. **B346**, 363 (1995).
- [24] The Crystal Barrel Collaboration, M. A. Faessler *et al.* Proc. NAN-93 Conference, Moscow, 1993.
- [25] The Obelix Collaboration, V. G. Ableev *et al.* Phys. Lett. **B334**, 237 (1994).
- [26] The Obelix Collaboration, V. G. Ableev *et al.* Nucl. Phys. **A585**, 577 (1995).
- [27] S. J. Brodsky, J. Ellis and M. Karliner, Phys. Lett. **B206**, 309 (1988).
- [28] M. Alberg, J. Ellis and D. Kharzeev, Phys. Lett. **B356**, 113 (1995).
- [29] J. Ellis and M. Karliner, Phys. Lett. **B341** (1988) 397 and ref. therein.
- [30] The SPES4 Collaboration, M. Al Jaghoub *et al.* FEW-BODY PROBLEMS IN PHYSICS: proceedings. Edited by Franz Gross. N.Y., AIP Conference Proceedings, 334 (1995).
- [31] M. C. Sapozhnikov, talk given at the Int. symposium MESON 94, May 1994, Dubna.
- [32] R. Wurzinger, preprint LNS/Ph/94-21.
- [33] R. Bertini, Nucl. Phys. **A585**, 265c (1995).
- [34] D. M. Binnie *et al.* Phys. Rev. **D8**, 2789 (1973).
- [35] J. Keyne *et al.* Phys. Rev. **D14**, 28 (1976)
H. Karami *et al.* Nucl. Phys. **B154**, 503 (1979).
- [36] A. I. L'vov, Int. J. Mod. Phys. **A8**, 5267 (1993).
- [37] N. M. Kroll and M. A. Ruderman, Phys. Rev. **93**, 233 (1954).
- [38] D. Drechsel and L. Tiator, Journ. of Phys. **G18**, 449 (1992).
- [39] E. Mazzucato *et al.*, Phys. Rev. Lett. **57**, 3144 (1986).
- [40] R. Beck *et al.*, Phys. Rev. Lett. **65**, 1841 (1990).
- [41] J. C. Bergstrom *et al.* Phys. Rev. Lett. **53**, R1052 (1996).

- [42] M. Fuchs *et al.* Phys. Lett. **B368**, 20 (1996).
- [43] E. Amaldi, S. Fubini and G. Furlan. Pion electroproduction, Springer Tracts in Modern Physics **83**, 1 (1979).
- [44] A. Maggiora Nucl. Phys. News **5**, 23 (1996).
- [45] R. Siebert *et al.* Nucl. Phys. **A567**, 819 (1994).
- [46] S. Vigdor, A.I.P. Conference Proceedings 343, *High energy Spin Physics, 12-th International Symposium*, Bloomington, Sept. 1994, Eds. K. J. Heller and S. L. Smith (University of Minnesota) p. 57.
- [47] B. Anderson *et al.*, Phys. Rep. **97**, 31 (1983).
- [48] T. de Grand *et al.*, Phys. Rev. **D32**, 2445 (1985).
- [49] B. E. Bonner *et al.*, Phys. Rev. **D38**, 729 (1988).
- [50] P. Cea *et al.*, Phys. Lett. **B193**, 24 (1991).
- [51] J. Soffer and N. A. Törnqvist, Phys. Rev. Lett. **68**, 907 (1992).
- [52] J. M. Laget, Phys. Lett. **B259**, 907 (1991).
- [53] The COSY-11 Collaboration, S. Sewerin *et al.*, Nucl. Phys. **A663**, 473c, (2000).
- [54] F. Plouin, P. Fleury, and C. Wilkin, Phys. Rev. Lett. **65**, 690 (1990).
- [55] V. Punjabi *et al.* Phys. Lett. **B350** (1995) 178.
- [56] V. Punjabi *et al.* Abstracts of the 14th Int. IUPAP Conf. on few Body Problems in Physics; Williamsburg, USA, May 26-31, 1994, pp 161-164.
- [57] S. M. Bilenkii *et al.* Sov. J. Nucl. Phys. **4**, 763 (1967).
- [58] S. Barshay and G. Temmer, Phys. Rev. Lett. **12**, 728 (1964).
- [59] R. F. Haglund *et al.* Phys. Rev. **C16**, 2789 (1977).
- [60] B. M. K. Nefkens, A.I.P. Conference Proceedings 339, *Eight International Symposium*, Bloomington, Sept. 1994, Eds. E. J. Stephenson and S. E. Vigdor, (University of Indiana) p. 197.
- [61] T. Goldman, J. A. Henderson and A. W. Thomas, Few Body Systems **12**, 193 (1992).
- [62] J. Piekarewicz and A. G. Williams, Phys. Rev. **C47**, R2462 (1993).

- [63] G. Krein, A. Thomas and a. G. Williams Phys. Lett. **B317**, 293 (1993).
- [64] T. Hatsuda, E. M. Henley, T.H. Meissner and C. Krein, Phys. Rev. **C49**, 452 (1994).
- [65] K. L. Mitchell, P. C. Tandy, C. D. Roberts and R. T. Cahill, Phys. Lett. **B335**, 282 (1994).
- [66] R. M. Kulsrud, H.P. Furth, E, J, Valeo and M. Goldhaber, Phys. Rev. Lett. **49**, 1248 (1982).
- [67] M. P. Rekaló and E. Tomasi-Gustafsson, Phys. Rev. C **57**, 2870 (1998).
- [68] R. E. Brown, N. Jarmie and G. M. Hale, Phys. Rev. C **35**, 1999 (1987);
G. M. Hale, R. E. Brown, and N. Jarmie, Phys. Rev. Lett 59 763 (1987); 59
2819 (1987).
- [69] R. J. Eden and J. R. Taylor, Phys. Rev. 1333, B1575 (1964)
- [70] A. Csoto, R.G. Lovas and A. T. Kruppa, Phys. Rev. Lett. 70, 1389 (1993).
- [71] B. Hoop and H. Barshall, Nucl. Phys. 83, 65 (1966).
- [72] B. Jenny, W Gruebler, P. A. Schmelzbach, V. Konig, and H. R. Burgi, Nucl.
Phys. A337, 77 (1980).
- [73] A. M. Lane and R. G. Thomas, Rev. Mod. Phys. 30, 257 (1958).
- [74] B. C. Pearce and B. F. Gibson, Phys. Rev. C **40**, 902 (1989).
- [75] A. Csoto and G. M. Hale, Phys. Rev. C **55**, 536 (1997).
- [76] F. C. Barker, Phys. Rev. C **56**, 2646 (1997).
- [77] L. J. Dries, H. W. Clark, R. Detoma Jr, J. L. Regner and T. R. Donoghue,
Phys. Rev. C **21**, 475 (1980).
- [78] D. R. Tilley, C. M. Cheves, G. M. Hale, C. M. Laymon and H.R. Weller to
be published.
- [79] M. L. E. Oliphant, P. Harteck, L. Rutherford, Proc. Roy. Soc. A141, 259
(1933).
- [80] R. M. Kulsrud, E. J. Valeo, S. C. Cowley, Nucl. Phys. **26**, 1443 (1986).
- [81] S. Tamor, G. W. Shay and Liu, Bull. Am. Phys. Soc. 27, 922 (1982).
- [82] G. W. Shay, A. E. Dabiri and H. Garad, Fusion Technology 9, 459 (1986).

- [83] D. R. Tilley, H. R. Weller and G. M. Hale, Nucl Phys **A 541**, 1 (1992).
- [84] R.E. Brown and N. Jarmie, Phys. Rev. **C41**, 1391 (1990).
- [85] A. Kraus, H. W. Becker, H. P. Trautvetter, C. Rolfs and K. Brand, Nucl. Phys **A465**, 150 (1987).
- [86] E. Pfaff, A. Hofmann, E. Huttel, N. Kniest, M. Nau, G. Reiter, S. Thar-rakette and Clausnitzer, J. Phys. Soc. Jpn. Suppl. 55, 894 (1986).
- [87] B. Becker, R. Randermann, B. Polke, S. Lemaitre, R. Reckenfelderbäumer, P. Niessen, G. Raupich, L. Sydow, and H. Paetz gen Schieck, Few Body Syst. 13, 19 (1992).
- [88] T. Tagishi, N. Nakamoto, K. Katoh, J. Togawa, T. Hisamane and T. Yoshida, Phys. Rev. **C46**, R1155 (1992).
- [89] K. A. Fletcher, Z. Ayer, T. C. Black, R. K. Das, H. J. Karkowski, E. J. Ludwig, G. M. Hale, Phys. Rev. **C 49**, 2305 (1994).
- [90] W. H. Breunlich, P. Hammel, J. S. Cohen, M. Lear, Ann. Rev. Nucl. Part. Phys. **39**, 311 (1989).
- [91] B. P. Ad'yasevich and D.E. Fomenko, Yad. Fiz. 9, 283 (1969) and Sov. J. Nucl. Phys. 9, 167 (1969).
- [92] B. P. Ad'yasevich, V. G. Antonenko and D.E. Fomenko, Yad. Fiz. 33, 601 (1981) and Sov. J. Nucl. Phys. 33, 313 (1981).
- [93] H. M. Hofmann and D. Fick, Phys. rev. Lett. **52**, 2038 (1984).
- [94] J. S. Zhang, K. F. Liu and G. W. Shug, Phys. Rev. Lett. **57**, 1410 (1986); ibid **55**, 1649 (1985).
- [95] S. Lemaitre and H. Paetz gen. Schieck, Few Body Syst. 9, 155 (1990).
- [96] H. Paetz gen. Schieck, B. Becker, R. Randermann, S. Lemaitre, P. Niessen, R. Reckenfelderbäumer, and L. Sydow, Phys. Lett. B **276**, 290 (1992).
- [97] J. S. Zhang, K. F. Liu, and G. W. Shay, preprint of Univ. of Kentucky, UK/95-05, 1995.
- [98] K. Langanke, Adv. in Nucl. Phys. **21**, 173 (1996).
- [99] M. J. Balbès, J.C. Riley, G. Feldman, H. R. Weller and D. R. Tilley, Phys. Rev. **C49**, 912 (1994).
- [100] R. E. Taam, Ann. Rev. Nucl. Part. Sci. **35**, 1 (1985)

- [101] C. J. Hogan, Phys. Rev. Lett.**51**, 1488 (1983).
- [102] M. S. Turner and L. M. Widrow, Phys. Rev. **D37**, 2743 (1988).
- [103] J. M. Quashnock, A. Loeb and D. H. Spergel, Astroph. J. **L49**, 344 (1989).
- [104] T. Vachaspati, Phys. Lett.**B265**, 258 (1991).
- [105] B. Cheng and A. Olinto, Phys. Rev. **D50**, 2421 (1994).
- [106] B. Cheng, D. N. Schramm and J. W. Truran, Phys. Lett **B316**, 521 (1993) and Phys. Rev. **D49**, 5006 (1994).
- [107] D. Grasso and H.R. Rubinstein, Nucl. Phys. B **43**, 303 (1995).
- [108] Proceedings of the 4th Int. Symposium on Nuclei in the Cosmos, Notre Dame, Indiana, USA, 20-27 June 1996, Nucl. Phys. **A621**, n.1,2, (1997).
- [109] E. Fermi, Phys. Rev 48, 570 (1935).
- [110] H. Bethe and R. Peierls, Proc. R. Soc. 1448, 146 (1935).
- [111] S. Degl’Innocenti, G. Fiorentini, B. Ricci, Phys. Lett. **B416**, 365 (1998).
- [112] E. Parker, Astr. Space Science, **31**, 261 (1974).