

# Results of a search for $2\beta$ -decay of $^{136}\text{Xe}$ with high-pressure copper proportional counters in Baksan Neutrino Observatory

Ju.M. Gavriljuk<sup>a</sup>, A.M. Gangapshev<sup>a,1</sup>, V.V. Kuzminov<sup>a</sup>,  
S.I. Panasenko<sup>b</sup>, S.S. Ratkevich<sup>b</sup>

<sup>a</sup> *Baksan Neutrino Observatory, INR RAS, Russia*

<sup>b</sup> *Karazin Kharkiv National University, Ukraine*

## Abstract

The experiment for the  $2\beta$ -decay of  $^{136}\text{Xe}$  search with two high-pressure copper proportional counters has been held in Baksan neutrino observatory. The search for the process is based on comparison of spectra measured with natural and enriched xenon. No evidence has been found for  $2\beta(2\nu)$ - and  $2\beta(0\nu)$ -decay. The decay half lifetime limit based on data measured during 8000 h is  $T_{1/2} \geq 8.5 \cdot 10^{21} \text{yr}$  for  $2\nu$ -mode and  $T_{1/2} \geq 3.1 \cdot 10^{23} \text{yr}$  for  $0\nu$ -mode (90% C.L.).

## Introduction

The experimental investigation of the  $2\beta$ -decay of  $^{136}\text{Xe}$  has been started more than 20 years ago. But till now both two neutrino and neutrinoless modes of this process are not observed yet. The results of last experiments are presented in tab.1. The theoretical estimations of half lifetime for  $2\beta(2\nu)$ -decay are presented in tab.2. It is necessary to mention that in [4] only one spectrum (measured with enriched  $^{136}\text{Xe}$ ) was obtained. To calculate their limit it was assumed that at any effect/background ratio in the energy range under investigation the effect did not exceed the actually measured background increased by a systematic error given in  $\sigma$  units ( $\sigma$  is a standard deviation). Actually, in the case of search of  $2\beta(2\nu)$ -decay, this method does not allow one to find the effect and could be used only to find a limit. To discover such an effect it is necessary either to measure directly the background of the installation under the same conditions or to simulate the background. In DAMA/LXe experiment such work has not been done. In our work the measurements were performed with enriched xenon (93% of  $^{136}\text{Xe}$ ) and natural xenon simultaneously.

## Experimental setup

The measurement was carried out with two copper proportional counters (CPC N1 and CPC N2). When one of them was filled with enriched xenon, the other one was filled with natural xenon with extracted light isotopes (9.2% of  $^{136}\text{Xe}$ ). Both CPC-s are surrounded by passive shield consisting of 20 cm of copper, 8 cm of borated polyethylene and 15 cm of lead (see fig.1). The installation is located in the deep underground laboratory of the BNO INR RAS at the depth 4900 m w.e, where the flux of muons is decreased by factor  $10^7$  and evaluated as  $2.23 \cdot 10^{-9} \text{cm}^{-2}\text{s}^{-1}$  [9]. The parameters of the CPC-s are: working pressure - 14.8 at, fiducial volume - 9.16 l, applied voltage - 3800 V. Signals PC1 and

---

<sup>1</sup>Talk at 5th International Conference on Non-Accelerator New Physics (NANP'05), Dubna, Russia, 20-25 June 2005.

PC2 were read out from both ends of the anode wire through preamplifiers. Then they were supplied to the digital oscilloscope through amplifiers. (see fig.2). Such a scheme of read out system allowed us to determine a relative coordinate ( $\beta$ ) of the events along the anode wire by the following equation  $\beta = A1/(A1 + A2)$ , where A1 and A2 amplitudes of pulses PC1 and PC2. Parameter  $\beta$  is used to reject both events of microdischarges in the outward high voltage circuits and those on the anode insulator surfaces. To exclude the influence of capacity charge decay on the pulse amplitude each pulse is reconstructed by software taking into account this decay. The value of reconstructed pulse at the point of initial pulse maximum was used as a amplitude to construct the energy spectrum. For detailed analysis the following pulse shape parameters was used: the pulse rise time ( $\tau$ ) and parameter  $\delta$  defined as

$$\delta = 100 \cdot \left(1 - \frac{\sum (y_i - g_i)^2}{\sum (y_i - \bar{y})^2}\right).$$

Where the  $y_i$  is value of differential of reconstructed pulse at the point  $i$ ,  $g_i$  - value of gaussian at the same point,  $\bar{y}$  - mean value of the differential of pulse in fitting region. The region of fitting by gaussian of the differential of pulse is restricted by point of pulse beginning and point where the initial pulse has a value  $0.9 \cdot A$ . In fig.3 samples of the pulses are shown.

## Results

From previous experiment [3] it was seen that significant part of the counters background is due to  $\alpha$ -particles produced in gas volume. To define parameters of  $\alpha$ -particle events the measurement of background of one CPC-s filled with xenon with admixtures of  $^{222}\text{Rn}$  ( $\alpha$ -particles with energy of 5.49 MeV, 6.02 Mev and 7.69 Mev) was done. The results of this measurement are presented in [10]. To define parameters of events from  $\gamma$ -rays the measurement with  $^{232}\text{Th}$ -source was carried out. Before measurements with  $^{222}\text{Rn}$  and  $^{232}\text{Th}$  and during main measurements the calibration of both CPC-s by  $^{22}\text{Na}$ -source was done. The energy resolution was determined as 13.5%, 9.5% and 8.1% for 511 keV, 1275 keV and 1592 keV, respectively.

Main measurements consist of 5 runs. In the first run CPC *N1* was filled with enriched xenon and CPC *N2* with natural xenon. Duration of the run was  $\sim 3000$  h. Then first CPC was refilled with natural xenon, second one with enriched xenon, after each run the refilling procedure was repeated. Such a procedure allows elimination of systematic error from possible differences between counters. For analysis the even number of runs was used. To exclude the contribution of  $^{222}\text{Rn}$  (which goes from gas cleaning system) to the CPC-s background the data of the first 500 h of measurements were not used for analysis. During this time radon decays almost completely. The calibration of the counters was carried out every 2 weeks ( 300 h).

Distribution of the background (2000 h of measurements),  $^{22}\text{Na}$ ,  $^{232}\text{Th}$  and  $^{222}\text{Rn}$  events versus energy,  $\tau$  and  $\delta$  are presented in fig.4, 5 and 6. It is seen that distribution of the  $^{232}\text{Th}$  events differ from  $^{222}\text{Rn}$  events significantly. This difference is clearly seen in distribution of events versus energy and  $\delta$  for energy greater then 800keV (see fig.6.). It was used to separate  $\alpha$ -particle events and electron events (pulses from  $\alpha$ -particles have  $\delta=100$ , pulses from electron have  $\delta \leq 100$ ). By rejecting of events with  $\delta=100$  we

exclude  $\alpha$ -particle events (produced in  $^{222}\text{Rn}$  decay chain in gas volume and coming from internal surface of CPC) from background spectra. The transformation of the background spectrum after such rejection is seen in fig.7. For total analysis the runs 1,2,4 and 5 were used. The effect value caused by  $2\beta(2\nu)$ -decay of  $^{136}\text{Xe}$  is determined with comparison of total spectra measured with enriched and natural xenon (see fig.8). Number of events in the energy region  $0.8\div 2.48$  MeV registered by CPC *N1* and CPC *N2* in each run during 2000 h of measurements are presented in tab.3. The evaluated effect is  $-64 \pm 99(stat) \pm 23(syst)$ . The total deviation is  $\sigma_{tot} = \sqrt{\sigma_{stat}^2 + \sigma_{syst}^2} = 102$ . So effect is  $-0.63\sigma_{tot}$ . Taking into account efficiencies and the different percentages of  $^{136}\text{Xe}$  in two gases and the recommendation given in [11], we obtain for the lifetime of  $2\beta(2\nu)$ -decay a lower limit:

$$T_{1/2}(2\beta, 2\nu) \geq \frac{\ln(2) \cdot N_{^{136}\text{Xe}} \cdot \epsilon_1 \cdot \epsilon_2}{1.08 \cdot \sigma_{tot}} = 8.5 \cdot 10^{21} yr(90\%C.L.)$$

Where:  $t=8000$  h= $0.913$  yr - measurements time,  $N_{^{136}\text{Xe}} = 3.21 \cdot 10^{23}$  - difference in  $^{136}\text{Xe}$ ,  $\epsilon_1 = 0.993$  - efficiency after rejection of events with  $\delta = 100$  and  $\epsilon_2 = 0.467$  - efficiency of  $2\beta(2\nu)$ -events registration.

To evaluate the  $2\beta(0\nu)$ -effect the energy spectra in region  $2317 \div 2641$  keV were analyzed. This energy region is determined from recalculated energy resolution for 2479 keV ( $R = 7.0\%$  or 174 keV) electrons and systematic error in definition of peak position ( $\pm 41$ keV). Number of events in the energy region  $2317\div 2641$  keV registered by CPC *N1* and CPC *N2* in each run during 2000 h of measurements are presented in tab.4. The evaluated effect is  $5 - 7 = -2(\pm 4.8)$ . Using recommendation given in [11] and assuming that mean background is 7 events and measured one is 5 events, we obtain:

$$T_{1/2}(2\beta, 0\nu) \geq \frac{\ln(2) \cdot N_{^{136}\text{Xe}} \cdot \epsilon_1 \cdot \epsilon_2}{3.28} = 3.1 \cdot 10^{23} yr(90\%C.L.)$$

where  $\epsilon_1 = 1.0$ ,  $\epsilon_2 = 0.5$

The work was supported by RFBR (grants: 01-02-16069 and 02-02-06136mas).

## References

- [1] R. Bernabei, P. Belli, F. Cappella et al., Phys. Lett. **B546**, 23 (2002).
- [2] R. Luescher, J. Farine, F. Boehm et al. Phys. Lett. **B434**, 407 (1998).
- [3] Ju. M. Gavriljuk, V.V. Kuzminov, N. Ya. Osetrova, S.S. Ratkevich, Phys. Rev. **C61**, 035501 (2000).
- [4] R. Bernabei, P. Belli, F. Cappella et al., Phys. Lett. **B546**, 23 (2002).
- [5] E. Caurier, F. Nowacki, A. Poves, J. Retamosa, Nucl. Phys. **A654**, 973 (1999).
- [6] O.A. Rumyantsev, M.G. Urin, JETP Lett **61**, 361 (1995).
- [7] A. Staudt, K. Muto, H. Klapdor-Kleingrothaus, Europhys. Lett. **13**, 31 (1990).
- [8] P. Vogel and M.R. Zirnbauer, Phys. Rev. Lett. **57**, 3148 (1986)

- [9] V.N. Gavrin, V.I. Gurentsov, V.N. Kornoukhov et al, *Intensivnost muonov kosmicheskikh luchei v laboratorii glubokogo zalozheniya GGNT*, Preprint INR RAS, P-698 (1991) Moskva.
- [10] Yu. M. Gavriljuk, V.V. Kuzminov, N. Ya. Osetrova, S.S. Ratkevich, *Yad. Phys.* **67**, 11, 2039 (2004).
- [11] G.J.Feldman, R.D.Causins, *Phys. Rev. D***57**, 3873 (1998).

Table 1: The results of some experiments for the search of  $2\beta$ -decay of  $^{136}\text{Xe}$

Experiment	$T_{1/2}(2\beta(2\nu))$	$T_{1/2}(2\beta(0\nu))$
Gran Sasso [1]	$\geq 1.6 \cdot 10^{20} \text{yr}$ (95% C.L.)	$\geq 1.2 \cdot 10^{22} \text{yr}$ (95% C.L.)
GOTTHARD [2]	$\geq 3.6 \cdot 10^{20} \text{yr}$ (90% C.L.)	$\geq 4.4 \cdot 10^{23} \text{yr}$ (90% C.L.)
BNO INR RAS [3]	$\geq 8.1 \cdot 10^{20} \text{yr}$ (90% C.L.)	...
DAMA/LXe [4]	$\geq 1.0 \cdot 10^{22} \text{yr}$ (90% C.L.)	$\geq 1.2 \cdot 10^{24} \text{yr}$ (90% C.L.)

Table 2: The theoretical estimations for  $2\beta(2\nu)$ -decay of  $^{136}\text{Xe}$

Authors	$T_{1/2}(2\beta(0\nu))$
E. Caurier et al. [5]	$2.1 \cdot 10^{21} \text{yr}$
O.A. Rumyantsev, M.G. Urin [6]	$1.0 \cdot 10^{21} \text{yr}$
A. Staudt et al. [7]	$1.5 \cdot 10^{19} - 2.1 \cdot 10^{22} \text{yr}$
P. Vogel and M.R. Zirnbauer [8]	$1.5 \cdot 10^{20} - 1.5 \cdot 10^{21} \text{yr}$

Table 3: The number of events with energy  $0.8 \div 2.48 \text{MeV}$ , registered in CPC  $N1$  and CPC  $N2$  during 2000h of measurements for each run.

run	CPC $N1$	CPC $N2$
1	1681 ( $^{136}\text{Xe}$ )	1108 ( $^{nat}\text{Xe}$ )
2	1734 ( $^{nat}\text{Xe}$ )	1182 ( $^{136}\text{Xe}$ )
4	1316 ( $^{nat}\text{Xe}$ )	783 ( $^{136}\text{Xe}$ )
5	1204 ( $^{136}\text{Xe}$ )	756 ( $^{nat}\text{Xe}$ )

Table 4: The number of events with energy  $2317 \div 2641 \text{keV}$ , registered in CPC  $N1$  and CPC  $N2$  during 2000h of measurements for each run.

run	CPC $N1$	CPC $N2$
1	3 ( $^{136}\text{Xe}$ )	3 ( $^{nat}\text{Xe}$ )
2	3 ( $^{nat}\text{Xe}$ )	1 ( $^{136}\text{Xe}$ )
4	1 ( $^{nat}\text{Xe}$ )	0 ( $^{136}\text{Xe}$ )
5	1 ( $^{136}\text{Xe}$ )	0 ( $^{nat}\text{Xe}$ )

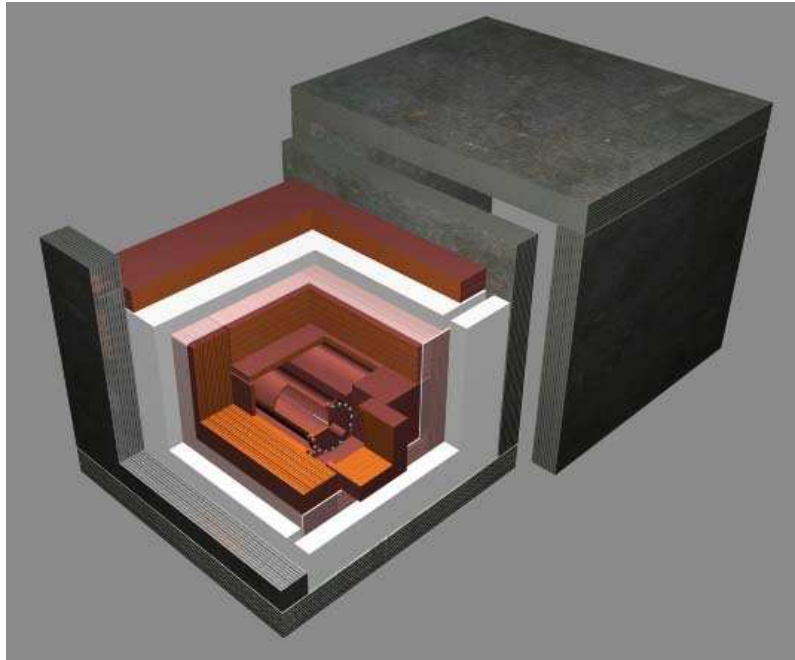

Figure 1: The view of the installation.

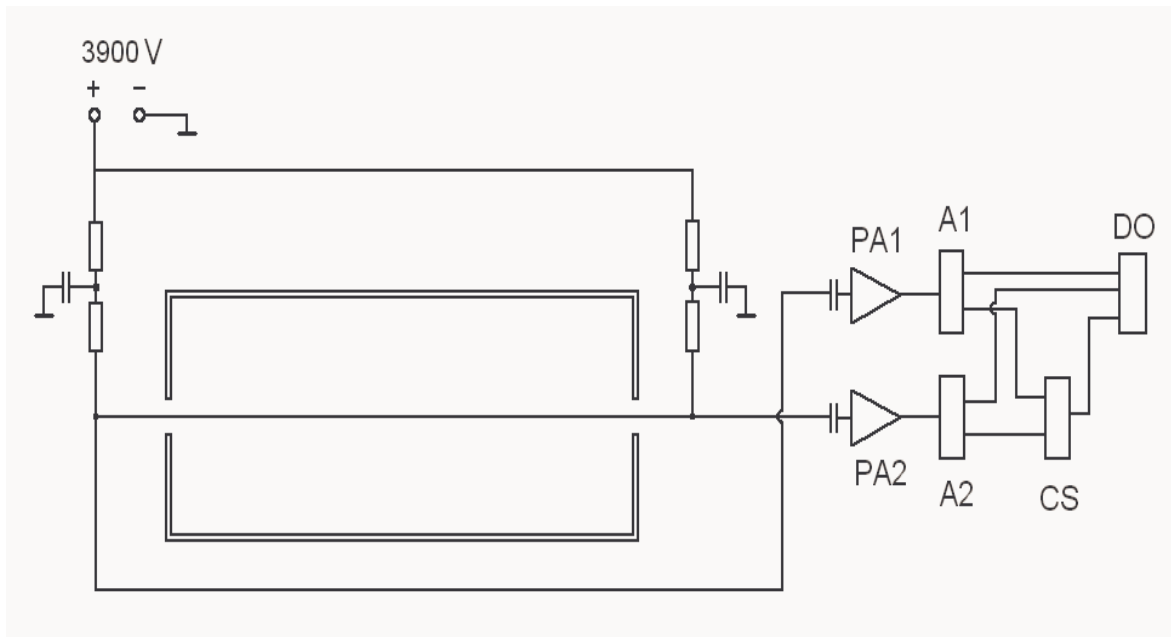

Figure 2: The electric scheme of installation. PA1 and PA2 - preamplifiers, A1 and A2 - amplifiers, CS - coincidence scheme, DO - digital oscilloscope.

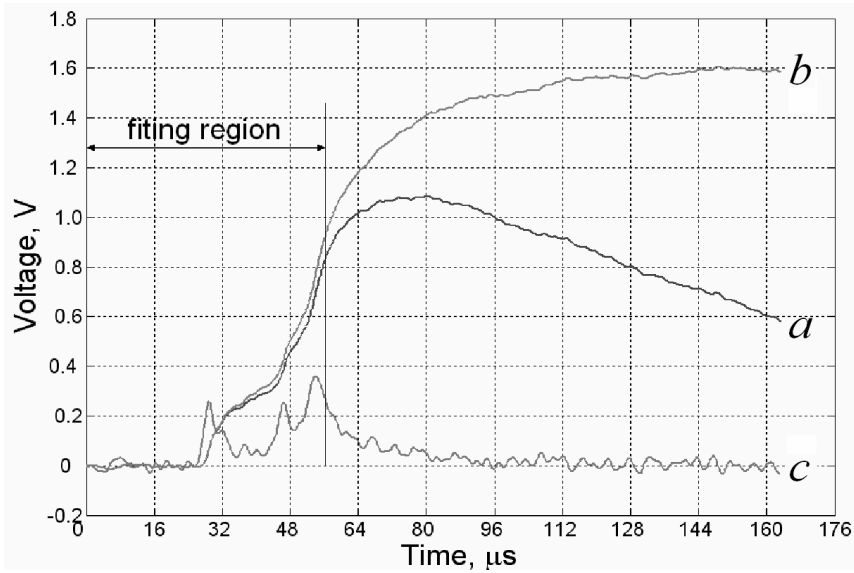

Figure 3: The samples of the pulses (*a*-initial pulse, *b*-reconstructed pulse, *c*-differential of reconstructed pulse).

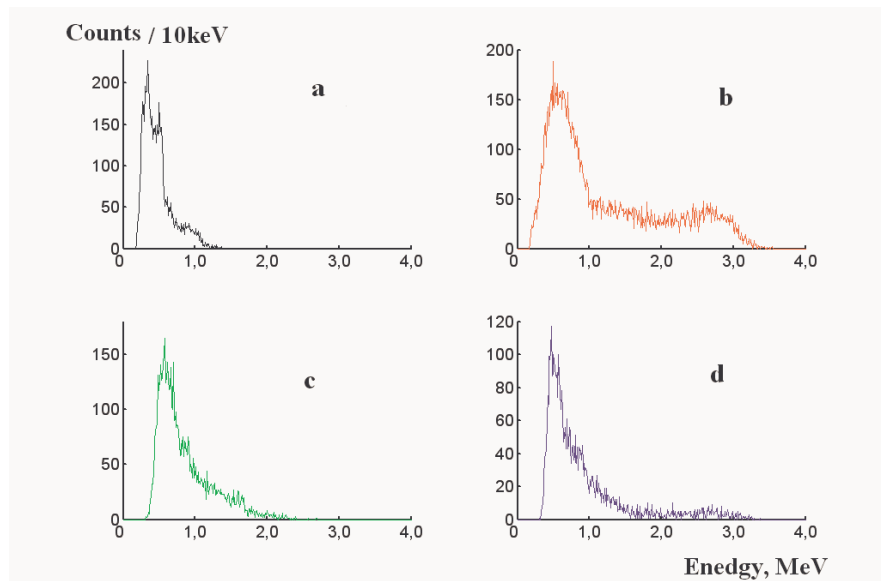

Figure 4: The energy spectra: **a** -  $^{22}\text{Na}$ , **b** -  $^{222}\text{Rn}$ , **c** -  $^{232}\text{Th}$  and **d** - background (2000 h).

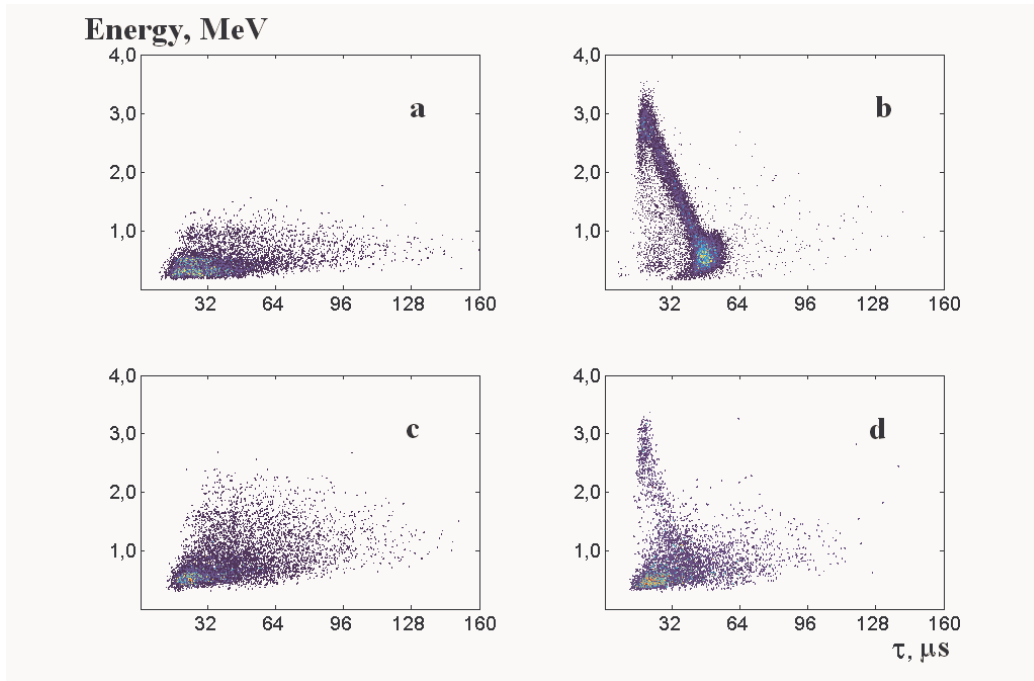

Figure 5: Distribution of events versus energy and  $\tau$ , **a** -  $^{22}\text{Na}$ , **b** -  $^{222}\text{Rn}$ , **c** -  $^{232}\text{Th}$  and **d** - background (2000 h).

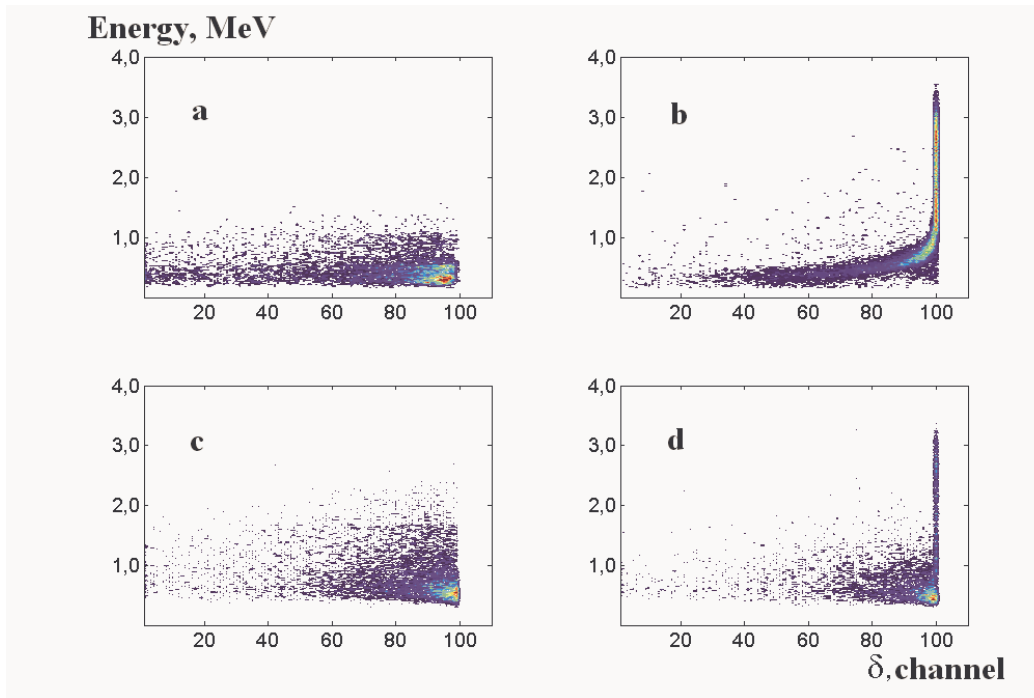

Figure 6: Distribution of events versus energy and  $\delta$ : **a** -  $^{22}\text{Na}$ , **b** -  $^{222}\text{Rn}$ , **c** -  $^{232}\text{Th}$  and **d** - background (2000 h).



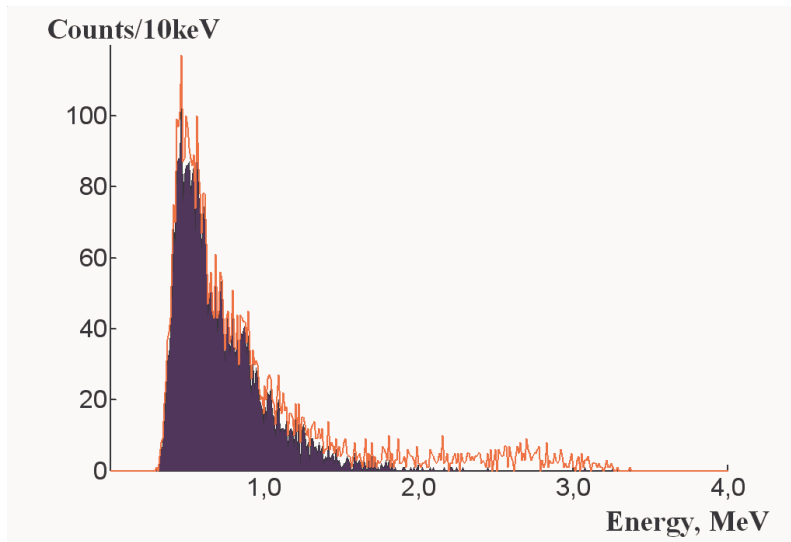

Figure 7: The energy spectra measured during 2000 h, line - before rejection of pulses with  $\delta=100$ , gray colour area - after rejection.

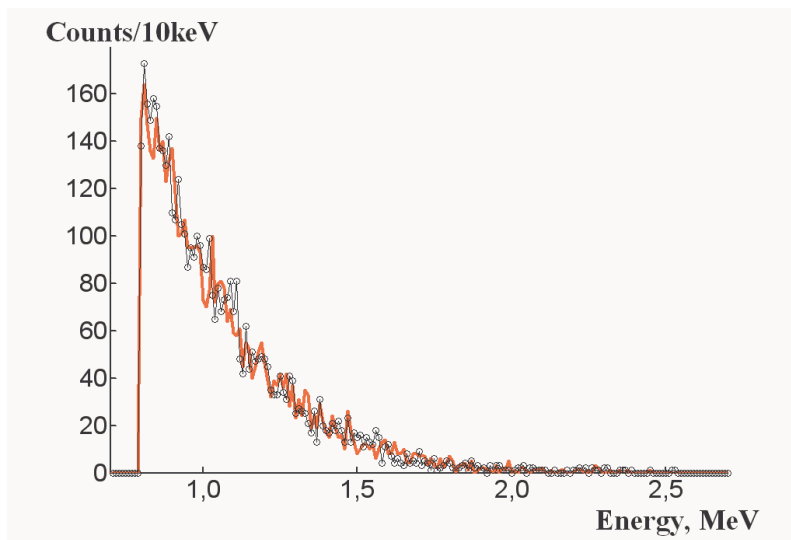

Figure 8: The energy spectra measured during 8000 h, solid line - enriched xenon, open circles - natural xenon.