

Rational blow-downs and smoothings of surface singularities

ANDRÁS I. STIPSICZ
 ZOLTÁN SZABÓ
 JONATHAN WAHL

*Rényi Institute of Mathematics
 Hungarian Academy of Sciences
 H-1053 Budapest
 Reáltanoda utca 13–15, Hungary*

*Department of Mathematics,
 Princeton University,
 Princeton, NJ, 08544*

*Department of Mathematics,
 The University of North Carolina,
 Chapel Hill, NC 27599–3250*

Email: `stipsicz@math-inst.hu`, `szabo@math.princeton.edu`, `jmwahl@email.unc.edu`

Abstract A necessary combinatorial condition is given for a negative-definite plumbing tree to be suitable for rational blow-down, or for giving a complex surface singularity admitting a rational homology disk smoothing. New examples of surface singularities with rational homology disk smoothings are also presented; these include singularities with resolution graph having valency four nodes.

AMS Classification

Keywords generalized rational blow-down, smoothing of surface singularities, Seiberg–Witten invariants, exotic 4-manifolds

1 Introduction

One of the basic operations in algebraic geometry is the blow-up process, which in complex dimension 2 (and for a point) is simply the replacement of a point with a rational curve of homological square -1 . From the differential topological point of view this operation corresponds to replacing a closed tubular neighbourhood of a point (which is simply the closed 4-disk) by the tubular neighbourhood of a sphere with self-intersection -1 . The inverse operation (i.e., the replacement of the tubular neighbourhood of a (-1) -sphere with the 4-disk) is called the blow-down process. It is well-known how these operations

affect topological and complex analytic invariants; and the effect on Seiberg–Witten invariants is the blow-up formula of [4].

This operation has been generalized by Fintushel and Stern [5]: in the *rational blow-down operation* the (closed) tubular neighbourhood of certain chains of 2–spheres (whose self–intersections are the negatives of the continued fraction coefficients of $p^2/(p-1)$, $p \geq 2$ an integer) have been replaced by 4–manifolds with boundary, with rational homology equal to the rational homology of the 4–disk. This idea was extended by J. Park [22], using the linear chains of spheres arising from the continued fraction coefficients of $p^2/(pq-1)$, for $p > q > 0$ relatively prime. (We will denote such a plumbing chain by $\Gamma_{p/q}$.) The usefulness of this operation stems from the fact that the Seiberg–Witten invariants of the 4–manifold we get by rationally blowing down these chains of 2–spheres can be computed using a fairly simple formula from the Seiberg–Witten invariants of the original manifold [5, 22]. This scheme admits many applications in finding 4–manifolds with various properties, for example in the search for exotic smooth structures on 4–manifolds with small Euler characteristic [6, 23, 24, 28].

The boundary of a tubular neighbourhood of such a chain of spheres is a lens space, and it had already been known that a lens space $L(p^2, pq-1)$ bounds a rational homology disk, by constructions of Casson and Harer [1]. Even more, it had been known that the two-dimensional cyclic quotient singularity determined by $p^2/(pq-1)$ (whose resolution graph is $\Gamma_{p/q}$) admitted a smoothing with vanishing Milnor number, hence its link bounds a rational homology disk (the ”Milnor fiber”) admitting a Stein structure (see [32, Example (5.9.1)] and Sections 7 and 8 below). Of course, one cannot expect to be able to do complex-analytic surgery, and replace one compact complex surface by another, cf. [14] for related discussion.

The simplicity of the formula relating the Seiberg–Witten invariants of the 4–manifolds before and after rational blow-down follows from three facts:

- (1) if the given configuration of spheres is tautly embedded for a given spin^c structure \mathfrak{s} (see Subsection 2.1), then the restriction of the spin^c structure extends from the complement of the configuration of spheres to the rational homology disk;
- (2) this extended spin^c structure gives rise to a Seiberg–Witten moduli space with the same expected dimension as \mathfrak{s} ; and finally
- (3) the 3–manifold along which we cut and glue admits the simplest possible Seiberg–Witten Floer homology (since it is a lens space, possessing a metric of positive scalar curvature).

It has been shown by Symington [29, 30] that a configuration $\Gamma_{p/q}$ of *symplectic* spheres in a symplectic 4–manifold can be blown down symplectically; that is, the symplectic form, when restricted to the complement of (an appropriate regular neighbourhood of) the spheres, extends to the rational homology disk. This observation explains the appearance of properties (1) and (2) above. The existence of the appropriate symplectic structure on the rational homology disk is a consequence of the fact that it is the Milnor fiber of a smoothing of the corresponding quotient singularity, hence admits a Stein structure. It is known that a surface singularity admitting a rational homology disk smoothing is necessarily rational (see also Subsection 2.3), and the link of a rational singularity is an L –space [16] (i.e., has the simplest possible Heegaard Floer homology, which is conjectured to be equivalent to the link admitting simple Seiberg–Witten Floer homology). This observation explains (3) above.

After the success of the rational blow–down process in constructing new and interesting smooth and symplectic 4–manifolds (and more recently complex surfaces [14]), it was natural to ask which other plumbing trees possess similar properties. Casson and Harer [1] provided many examples of 3–manifolds which bound rational homology disks; but when performing the rational blow–down process along them, the lack of (some of) the properties (1–3) listed above implied that the resulting 4–manifolds were usually uninteresting (i.e., had trivial Seiberg–Witten invariants). Correspondingly, it has been known for some time that the only cyclic quotient singularities admitting smoothings with Milnor number 0 (i.e., rational homology disk smoothings) are those with graph $\Gamma_{p/q}$, see [15, Remark (5.10)]. On the other hand, a triply-infinite family of singularities admitting Milnor number 0 smoothings appeared already in 1980 [32, (5.9.2)].

We will see that minimal negative–definite plumbing graphs Γ of interest in these problems satisfy very strong combinatorial restrictions. Properties (1) and (2) above lead to the following

Definition 1.1 The plumbing tree Γ on n vertices is a *symplectic plumbing tree* if Γ admits an embedding φ into the negative–definite diagonal lattice $(\mathbb{Z}^n, Q_n) = n\langle -1 \rangle$ such that

- for vertices $v_1 \neq v_2 \in \Gamma$ we have $Q_n(\varphi(v_1), \varphi(v_2)) = 1$ or 0 depending on whether v_1 and v_2 are connected in Γ ,
- $Q_n(\varphi(v), \varphi(v))$ is equal to the decoration of v for all $v \in \Gamma$, and
- with the basis $\{E_1, \dots, E_n\}$ of Q_n satisfying $Q_n(E_i, E_j) = -\delta_{ij}$ and with

the notation $K = \sum_{i=1}^n E_i$ we have the adjunction equation

$$Q_n(v, K) + Q_n(v, v) = -2 \tag{1.1}$$

for every vertex v of Γ .

A graph Γ is called *minimal* if there is no vertex in Γ with decoration (-1) . We denote the set of minimal, connected symplectic plumbing trees by \mathcal{S} .

Remark 1.2 The name for the set \mathcal{S} comes from the fact that the adjunction equality is naturally satisfied by a tree of *symplectically* embedded spheres in a symplectic 4-manifold. Notice also that if a resolution of a complex surface singularity has dual graph given by Γ , then K , the restriction of the first Chern class of the complex structure, satisfies (1.1) — as a result of the adjunction formula.

Remark 1.3 From the point of view of [15], consider the negative-definite lattice

$$L = \bigoplus_{v \in \Gamma} \mathbb{Z} \cdot v$$

generated by the vertices of Γ , using intersections $v \cdot v'$ as given by the graph. Then Definition 1.1 requires that L is contained in a diagonal unimodular overlattice of the same rank, with a special role played by the characteristic element $K \in L^*$. This may be stated in terms of the existence of self-isotropic subspaces of the discriminant quadratic group $(L^*/L, q)$, as in [15]. See also Section 2.3.

Our main goal is to determine a necessary combinatorial property of a plumbing tree Γ which gives rise to M_Γ such that a rational homology disk B_Γ (with $\partial M_\Gamma \cong \partial B_\Gamma$) exists and either (a) for tautly embedded $M_\Gamma \subset (X, \mathbf{s})$ into a spin^c 4-manifold with $SW_X(\mathbf{s}) \neq 0$, the new manifold $(X - M_\Gamma) \cup B_\Gamma$ has nontrivial Seiberg–Witten invariants, or (b) a symplectically embedded M_Γ can be blown down in the symplectic category, or (c) there is a singularity with resolution graph Γ admitting a rational homology disk smoothing. As will be explained in the next section, the graphs in \mathcal{S} are the only candidates for our three problems. (We will also explain the relation among the three problems mentioned above.)

Proposition 1.4 (Corollaries 2.2, 2.3, 2.5) *Let Γ be a negative-definite minimal plumbing tree of spheres which can be tautly embedded and rationally blown down, or can be symplectically blown down, or gives rise to a complex surface singularity admitting a rational homology disk smoothing. Then $\Gamma \in \mathcal{S}$.*

The main theorem of the present paper (Theorem 1.8) gives a combinatorial description of the set \mathcal{S} . Aside from the $\Gamma_{p/q}$, the graphs consist of 3 triply-infinite families $\mathcal{W}, \mathcal{N}, \mathcal{M}$, built on the 3 basic examples shown by Figure 1. There are 3 more classes $\mathcal{A}, \mathcal{B}, \mathcal{C}$ built out of variations of these basic examples,

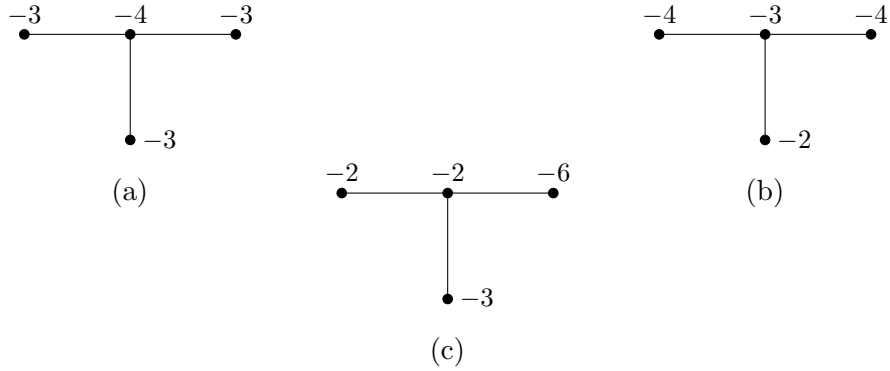

Figure 1: Graphs of the basic examples, giving the families $\mathcal{W}, \mathcal{N}, \mathcal{M}$

cf. Definition 1.5 below.

The other key results of the paper (e.g., Theorems 1.9, 1.10) show that many of the graphs in \mathcal{S} actually do occur in one of our situations (see also the preprint [7]). But, not all $\Gamma \in \mathcal{S}$ occur; further constraints and a better understanding of the geometric picture will be addressed in a subsequent project, see also Subsection 2.4. In order to state the main result of the paper, we need a definition.

Definition 1.5 • For integers $p > q > 0$ relatively prime, consider the continued fraction expansion of $p^2/(pq - 1)$, i.e.,

$$p^2/(pq - 1) = a_1 - \frac{1}{a_2 - \frac{1}{\ddots - \frac{1}{a_k}}},$$

where $a_i \in \mathbb{N}$, $a_i \geq 2$. Figure 2 shows the corresponding negative-definite plumbing tree.

- The plumbing tree given by Figure 3 will be denoted by $\Gamma_{p,q,r}$ ($p, q, r \geq 0$). We denote the set of these plumbing trees by \mathcal{W} .

$$\Gamma_{p/q} = \begin{array}{c} -a_1 \quad -a_2 \quad \dots \quad -a_{k-1} \quad -a_k \\ \bullet \text{---} \bullet \text{---} \dots \text{---} \bullet \text{---} \bullet \end{array}$$

Figure 2: The graph $\Gamma_{p/q}$ in \mathcal{G}_{rat}

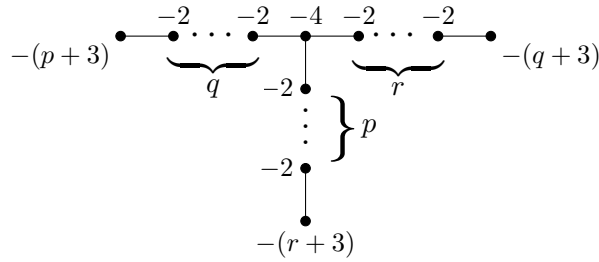

Figure 3: The graph $\Gamma_{p,q,r}$ in \mathcal{W}

- The plumbing tree of Figure 4 will be denoted by $\Delta_{p,q,r}$ ($p \geq 1$ and $q, r \geq 0$). The slight modification of the graph $\Delta_{p,q,r}$ when $p = 0$ is

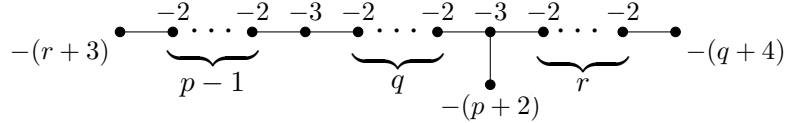

Figure 4: The graph $\Delta_{p,q,r}$ in for $p \geq 1$ and $q, r \geq 0$

shown in Figure 5. The set of graphs $\Delta_{p,q,r}$ with $p, q, r \geq 0$ will be denoted by \mathcal{N} .

- The plumbing graph of Figure 6 is $\Lambda_{p,q,r}$ with $p, r \geq 1$ and $q \geq 0$. Modifications of these graphs for $p = 0, r \geq 1$ and $p \geq 1, r = 0$ are shown by Figures 7 and 8. (The last degeneration, when $p = r = 0$ (as shown by Figure 9) will appear in the family \mathcal{C} defined below.) The set of graphs $\{\Lambda_{p,q,r} \mid p, q, r \geq 0, (p, r) \neq (0, 0)\}$ will be denoted by \mathcal{M} .
- Let us define \mathcal{A} as the family of graphs we get in the following way: start with the graph of Figure 10(a), blow up its (-1) -vertex or any edge

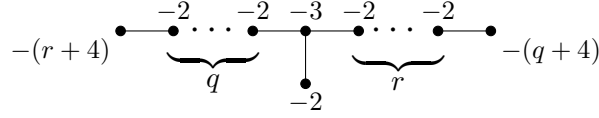

Figure 5: The graph $\Delta_{0,q,r}$

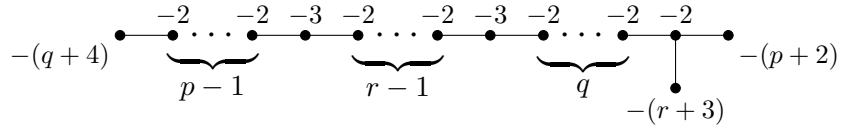

Figure 6: The graph $\Lambda_{p,q,r}$ in for $p, r \geq 1$ and $q \geq 0$

emanating from the (-1) -vertex and repeat this procedure of blowing up (either the new (-1) -vertex or an edge emanating from it) finitely many times, and finally modify the single (-1) -decoration to (-4) . Depending on the number and configuration of the chosen blow-ups, this procedure defines an infinite family of graphs. Define \mathcal{B} similarly, when starting with Figure 10(b) and substituting (-1) in the last step with (-3) , and finally define \mathcal{C} in the same vein by starting with Figure 10(c) and putting (-2) instead of (-1) in the final step.

Remark 1.6 Figure 11 gives a pictorial description of what we mean by blowing up a (-1) -vertex (Figure 11(a)) and an edge emanating from a (-1) -vertex (Figure 11(b)). Notice that in the plumbing 4-manifold both operations correspond to blowing up the (-1) -sphere defined by the vertex, either in a generic point or in an intersection with another sphere of the plumbing configuration. The reverse of the blow-up operation will be called *blowing down*; notice that only a vertex of valency 1 or 2 can be blown down in the category of plumbing trees.

Remark 1.7 In classes \mathcal{N} and \mathcal{M} , the need to make special graphs when some of p, q, r are 0 disappears if we look instead at the "dual graphs", which arise in smoothings of negative weight (see Subsection 8.1).

After these preparations we are ready to state the main theorems of the paper:

Theorem 1.8 *The set \mathcal{S} is equal to the union $\mathcal{G}_{rat} \cup \mathcal{W} \cup \mathcal{N} \cup \mathcal{M} \cup \mathcal{A} \cup \mathcal{B} \cup \mathcal{C}$.*

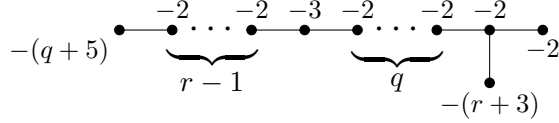

Figure 7: The graph $\Lambda_{0,q,r}$ for $r \geq 1$ and $q \geq 0$

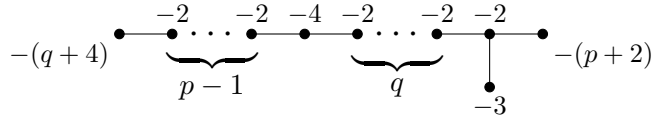

Figure 8: The graph $\Lambda_{p,q,0}$ for $p \geq 1$ and $q \geq 0$

One can show that these 7 types of graphs are in \mathcal{S} by exhibiting explicit embeddings in $n\langle -1 \rangle$: for \mathcal{G}_{rat} , use Proposition 4.4; $\mathcal{W}, \mathcal{N}, \mathcal{M}$ are done in the Appendix; for $\mathcal{A}, \mathcal{B}, \mathcal{C}$, proceed by induction as in Proposition 5.7. (One can give an abstract proof for the first four classes by combining the Examples in Section 8 with Corollary 2.5). That \mathcal{S} consists only of these types is the heart of this paper.

The next question is which $\Gamma \in \mathcal{S}$ are suitable for rational blow-down, or which can be the graph of a normal surface singularity admitting a rational homology disk smoothing. On the positive side, in many cases there are several constructions for the appropriate rational homology disks. Using Kirby calculus, one can prove (Section 7):

Theorem 1.9 *A plumbing graph $\Gamma \in \mathcal{G}_{rat} \cup \mathcal{W} \cup \mathcal{N} \cup \mathcal{M}$ defines the plumbing 4-manifold M_Γ with the property that ∂M_Γ bounds a rational homology disk.*

In fact, a stronger result is true; two methods for constructing smoothings of normal surface singularities (Section 8) lead to:

Theorem 1.10 *Any graph $\Gamma \in \mathcal{G}_{rat} \cup \mathcal{W} \cup \mathcal{N} \cup \mathcal{M}$ gives rise to a normal surface singularity which admits a smoothing with vanishing Milnor number. Some infinite families of graphs in each of \mathcal{A} , \mathcal{B} , and \mathcal{C} , including some with a node of valency 4, admit the same property.*

(Concerning the valency 4 Examples 8.7, 8.12 and 8.14, see [11] for a related discussion.) While Theorem 1.8 excludes graphs with a node of valency ≥ 5 or two nodes of valency 4, it allows graphs with two nodes of valency ≥ 3 ; but at present none of these examples are known to admit a smoothing with vanishing

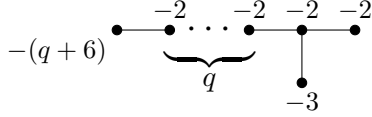

Figure 9: The graph $\Lambda_{0,q,0}$ for $q \geq 0$

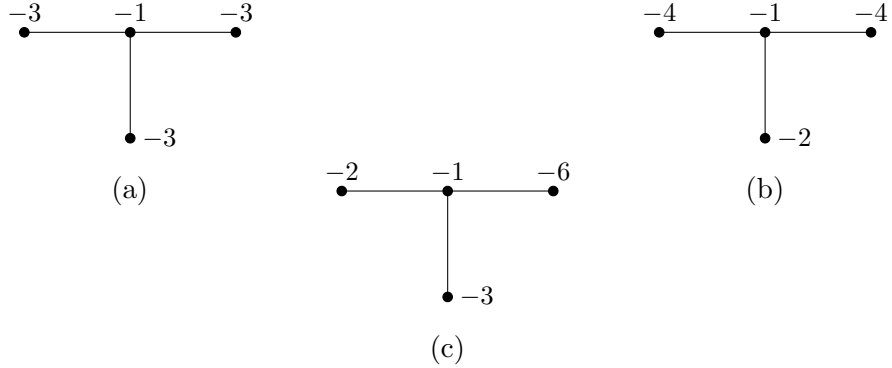

Figure 10: Nonminimal plumbing trees giving rise to the families \mathcal{A} , \mathcal{B} and \mathcal{C}

Milnor number. Finally, it is worth noting that any $\Gamma \in \mathcal{S}$ which is star-shaped with a node of valency 3 is *taut* in the sense of Laufer [12]: there is a *unique* singularity (necessarily rational and weighted homogeneous) with graph Γ . On the other hand, any singularity with star-shaped $\Gamma \in \mathcal{S}$ with a node of valency 4 is weighted homogeneous, while its analytic type is uniquely determined by the cross-ratio of the 4 points on the central curve [12, Theorem 4.1]. But, for instance in Example 8.12 there exists a homology disk smoothing for *only one* of these analytic types (the singularity has a "smoothing component" of dimension 1, cf. [32, Theorem 3.13(c)]).

On the other hand, certain classes in \mathcal{A} , \mathcal{B} and \mathcal{C} give 3-manifolds which do not even bound rational homology disks (because of their μ -invariant). For this and other obstructions, see Subsection 2.4.

The paper is organized as follows: In Section 2 we motivate our definition of \mathcal{S} through a more detailed discussion of the rational blow-down operation in the smooth and symplectic category, and briefly review some basic facts about normal surface singularities. In Section 3, we consider a $\Gamma \in \mathcal{S}$, and write

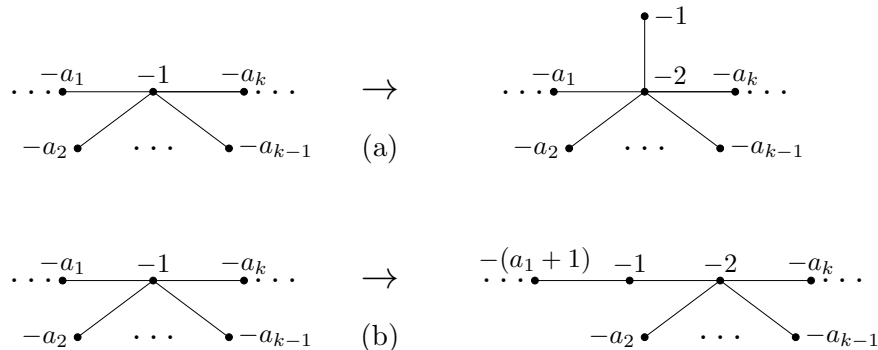

Figure 11: The blow-up of (a) a (-1) -vertex and (b) an edge emanating from a (-1) -vertex

each vertex $v \in \Gamma$ as an integral combination of the basis vectors E_i , deducing quickly strong conditions on the coefficients, hence on the graphs. The hard technical work in Sections 4, 5 and 6 provides the proof of Theorem 1.8 (with the addendum of describing the actual embeddings of graphs in $\mathcal{W} \cup \mathcal{M} \cup \mathcal{N}$, which is deferred to the Appendix given in Section 9). Section 7 is devoted to the proof of the existence of rational homology disks for plumbing graphs in $\mathcal{G}_{rat} \cup \mathcal{W} \cup \mathcal{M} \cup \mathcal{N}$; here we use techniques of smooth 4-manifold topology. Finally, in Section 8 two algebro-geometric methods are described and applied to verify the existence of rational homology disk smoothings for large families of singularities given by plumbing graphs of \mathcal{S} .

Acknowledgements: The first author would like to thank the Institute for Advanced Study in Princeton for their hospitality while some part of this work has been carried out. AS was partially supported by OTKA T49449; ZSz was supported by NSF grant number DMS 0406155; and JW was partially supported by NSA grant number FA9550-06-1-0063. The first and second authors were also supported by EU Marie Curie TOK project BudAlgGeo.

2 Plumbing trees

The main purpose of this section is to justify Definition 1.1. We show that if the plumbing 4-manifold M_Γ can be (Seiberg-Witten or symplectically) blown down then $\Gamma \in \mathcal{S}$; similarly, if Γ is the resolution graph of a normal surface singularity with a smoothing with vanishing Milnor number, then $\Gamma \in \mathcal{S}$.

2.1 Tautly embedded plumbing trees

Suppose that Γ is a given negative-definite plumbing tree of spheres and M_Γ is the corresponding plumbed 4-manifold with boundary. Let $\Sigma_v \subset M_\Gamma$ denote the 2-sphere corresponding to the vertex $v \in \Gamma$. We say that M_Γ is *tautly embedded* in a closed, oriented spin^c 4-manifold (X, \mathbf{s}) if

$$\langle c_1(\mathbf{s}), [\Sigma_v] \rangle + [\Sigma_v]^2 = -2 \quad (2.1)$$

for all $v \in \Gamma$. With a slight abuse of terminology, sometimes we say that the graph Γ is tautly embedded.

Definition 2.1 The 4-manifold M_Γ (or the plumbing graph Γ) can be (Seiberg–Witten) blown down if there is a 4-manifold B_Γ , with the same rational homology as the disk D^4 and with $\partial B_\Gamma \cong \partial M_\Gamma$, with the following property: for every taut embedding $M_\Gamma \subset (X, \mathbf{s})$ for which $SW_X(\mathbf{s}) \neq 0$,

- the spin^c structure $\mathbf{s}|_{X-M_\Gamma}$ extends to $\mathbf{s}' \in \text{Spin}^c(X')$, where $X' = (X - M_\Gamma) \cup B_\Gamma$,
- the Seiberg–Witten moduli spaces $\mathcal{M}_{X'}(\mathbf{s}')$ and $\mathcal{M}_X(\mathbf{s})$ have the same expected dimensions, and
- $SW_X(\mathbf{s}) = \pm SW_{X'}(\mathbf{s}')$.

Since the expected dimension of the Seiberg–Witten moduli space is given by the formula

$$\dim \mathcal{M}_X(\mathbf{s}) = \frac{1}{4}(c_1^2(\mathbf{s}) - 3\sigma(X) - 2e(X))$$

(where, as usual, $\sigma(X)$ and $e(X)$ denote the signature and Euler characteristic of the 4-manifold X), the assumption $\dim \mathcal{M}_X(\mathbf{s}) = \dim \mathcal{M}_{X'}(\mathbf{s}')$ together with the facts

$$\sigma(X') = \sigma(X) + |\Gamma| \text{ and } e(X') = e(X) - |\Gamma|$$

(following from the negative-definiteness of Γ) imply

$$c_1^2(\mathbf{s}) - c_1^2(\mathbf{s}') = -|\Gamma|.$$

The symbol $|\Gamma|$ denotes the rank of Γ , that is, the cardinality of its vertex set. Let $X_\Gamma = M_\Gamma \cup \overline{B_\Gamma}$, where $\overline{B_\Gamma}$ denotes the 4-manifold B_Γ with opposite orientation. Since Γ is a negative-definite graph and B_Γ is a rational homology disk, it follows that X_Γ is a negative-definite closed, oriented 4-manifold, and $\text{rk } H_2(X_\Gamma; \mathbb{Z}) = |\Gamma|$. According to Donaldson's famous diagonalizability theorem [2, 3] we have that the intersection form Q on $H_2(X_\Gamma; \mathbb{Z})/\text{Torsion}$ is

diagonalizable, providing an embedding of Γ on n vertices into the diagonal form $(\mathbb{Z}^n, Q_n) = n\langle -1 \rangle$. (For a Heegaard Floer theoretic proof of Donaldson's result, see [21, Theorem 9.1].) By gluing the spin^c structure $\mathfrak{s}|_{M_\Gamma}$ to the extension of $\mathfrak{s}|_{\partial M_\Gamma}$ over $\overline{B_\Gamma}$ we get a spin^c structure $\mathfrak{s}_X \in \text{Spin}^c(X_\Gamma)$. The assumption on the expected dimensions of the Seiberg–Witten moduli spaces and the fact that $H_2(B_\Gamma; \mathbb{Q}) = 0$ readily implies that

$$c_1^2(\mathfrak{s}_X) = c_1^2(\mathfrak{s}) - c_1^2(\mathfrak{s}') = -|\Gamma| = -n.$$

Since in the negative-definite diagonal lattice of rank n there is essentially a unique characteristic element of square $-n$ (which is $\sum_{i=1}^n E_i$ for an orthonormal basis $\{E_1, \dots, E_n\}$), the assumption on M_Γ being tautly embedded implies

Corollary 2.2 *If the minimal, negative-definite plumbing tree Γ gives rise to M_Γ which can be (Seiberg–Witten) blown down, then $\Gamma \in \mathcal{S}$. \square*

2.2 Trees which can be symplectically blown down

Next we deal with a necessary condition for a negative-definite plumbing tree Γ to be blown down symplectically. Suppose that $M_\Gamma \subset (X, \omega)$ is a symplectic embedding into the closed 4-manifold X with symplectic form ω , that is, the spheres Σ_v are symplectic submanifolds in (X, ω) for all $v \in \Gamma$ and they intersect each other ω -perpendicularly. Suppose that the 3-manifold ∂M_Γ bounds a rational homology disk B_Γ . We say that Γ can be *blown down symplectically* if $\omega|_{X-M_\Gamma}$ can be extended over the glued-up rational homology disk B_Γ to produce a symplectic structure ω' on $X' = (X - M_\Gamma) \cup B_\Gamma$, cf. [29, Definition 1.1]. If $\mathfrak{s}_\omega \in \text{Spin}^c(X)$ denotes the spin^c structure induced by ω then this property implies that

- M_Γ is tautly embedded in (X, \mathfrak{s}_ω) (since the spheres Σ_v are symplectic submanifolds),
- $SW_X(\mathfrak{s}_\omega) = \pm 1$ and the expected dimension of the Seiberg–Witten moduli space $\mathcal{M}_X(\mathfrak{s}_\omega)$ is equal to zero, and finally
- if ω' induces the spin^c structure $\mathfrak{s}'_{\omega'} \in \text{Spin}^c(X')$ then $SW_{X'}(\mathfrak{s}'_{\omega'}) = \pm 1$ and the expected dimension of the Seiberg–Witten moduli space $\mathcal{M}_{X'}(\mathfrak{s}'_{\omega'})$ is zero.

Therefore Γ fits in the category of the previous subsection, hence if Γ can be symplectically blown down then (at least for the spin^c structure induced by the symplectic structure) it can be Seiberg–Witten blown down. This observation immediately yields

Corollary 2.3 *If the minimal, negative-definite plumbing tree Γ can be symplectically blown down, then $\Gamma \in \mathcal{S}$.* \square

2.3 Normal surface singularities

For more details about the following, see e.g. [15]. Let $\rho: (\tilde{Y}, E) \rightarrow (Y, o)$ be the minimal good resolution of a germ of a normal surface singularity with rational homology sphere link Σ (i.e., $H_1(\Sigma; \mathbb{Q}) = 0$). Then the exceptional divisor $E = \cup_v E_v = \rho^{-1}(0)$ decomposes into smooth rational curves, giving a dual resolution graph Γ , whose vertices are indexed by the v 's; Γ is a negative-definite tree which (except for lens spaces) determines and is determined by the homotopy type of the 3-manifold Σ . Consider the lattice $\mathbb{E} = \oplus \mathbb{Z}[E_v] \subset H_2(\tilde{Y}; \mathbb{Z})$ (called L in Remark 1.3). The intersection pairing gives the discriminant group $D(\Gamma) \cong \mathbb{E}^*/\mathbb{E}$ and

$$D(\Gamma) \cong H_1(\Sigma; \mathbb{Z}).$$

The complex structure on \tilde{Y} gives rise to a relative cohomology class $K_{\tilde{Y}}$, and a rational invariant $K_{\tilde{Y}} \cdot K_{\tilde{Y}} \in \mathbb{Q}$ computable from Γ . The analytic invariant $p_g(Y) = \dim R^1 \rho_* \mathcal{O}_{\tilde{Y}}$ (the *geometric genus*) is generally not computable from Γ . We say that Y has a *rational singularity* if $p_g(Y) = 0$, and this is determined by the graph condition $Z \cdot (Z + K_{\tilde{Y}}) = -2$, where Z (the *fundamental cycle*) is the smallest effective cycle for which $Z \cdot E_v \leq 0$, all v . For example, any negative-definite tree Γ for which the valency of every vertex is at most the negative of the self-intersection is automatically rational.

Consider a smoothing $f: (\mathcal{Y}, o) \rightarrow (\Delta, o)$ of (Y, o) , where (Δ, o) is the germ of an open disk in \mathbb{C} . With appropriate attention to the boundaries of representatives of these germs, one can define a “general fiber” of the smoothing, the Milnor fiber M . M is a compact oriented 4-manifold with boundary Σ , and its first Betti number is 0; it also has a rational invariant $K_M \cdot K_M \in \mathbb{Q}$. The Milnor number μ of the smoothing is the rank of $H_2(M; \mathbb{Q})$, and in general depends on which smoothing of Y one considers. Denoting the Sylvester invariants of the intersection pairing on $H_2(M; \mathbb{Q})$ by (μ_0, μ_+, μ_-) , one has the general formulae

$$\mu_0 + \mu_+ = 2p_g(Y)$$

$$K_M \cdot K_M + \chi(M) = K_{\tilde{Y}} \cdot K_{\tilde{Y}} + \chi(\tilde{Y}) + 12p_g(Y).$$

These formulae and the previous discussion imply that to have a singularity and a smoothing whose Milnor fiber is a rational homology disk (i.e., $\mu = 0$),

one must have that Y has a rational singularity and (if n denotes the number of exceptional curves)

$$n + K_{\tilde{Y}} \cdot K_{\tilde{Y}} = 0.$$

For cyclic quotient singularities \mathbb{C}^2/G , Γ is a string, and the condition above is valid only for the type $p^2/(pq-1)$ (see [15, Theorem (5.10)]).

The finite group $H_1(\Sigma; \mathbb{Z})$ has a natural non-degenerate linking pairing into \mathbb{Q}/\mathbb{Z} , which is the same as the one on $D(\Gamma)$; but this is induced via a finer object, a *quadratic function* $q: H_1(\Sigma; \mathbb{Z}) \rightarrow \mathbb{Q}/\mathbb{Z}$, coming from the function on \mathbb{E} given by $e \mapsto (1/2)(e \cdot e + e \cdot K_{\tilde{Y}})$. [15, Theorem 4.5] implies that if a Milnor fiber M has $H_2(M; \mathbb{Q}) = 0$, then the kernel I of the natural surjection $H_1(\Sigma; \mathbb{Z}) \rightarrow H_1(M; \mathbb{Z})$ is q -isotropic; in particular, $I = I^\perp$, so the order of $D(\Gamma)$ is a square, and the class of $K_{\tilde{Y}}$ is in I . In addition, by gluing the Milnor fiber M with $\mu = 0$ (with opposite orientation) to \tilde{Y} along Σ we get a negative-definite 4-manifold; hence, by Donaldson's Theorem we conclude that Γ embeds into the negative-definite diagonal lattice of rank $|\Gamma| = n$. We collect these results in

Proposition 2.4 *Suppose a normal surface singularity (Y, o) with resolution graph Γ admits a smoothing whose Milnor fiber M is a rational homology disk. Then*

- (1) Y has a rational singularity,
- (2) on the minimal good resolution $|\Gamma| + K_{\tilde{Y}} \cdot K_{\tilde{Y}} = 0$,
- (3) there is a self-isotropic $I \subset H_1(\Sigma; \mathbb{Z})$, and $H_1(M; \mathbb{Z}) \cong H_1(\Sigma; \mathbb{Z})/I$ (hence is $\cong I$) and
- (4) Γ admits an embedding into the diagonal lattice (\mathbb{Z}^n, Q_n) of the same rank, and the class of $K_{\tilde{Y}}$ is a characteristic element of the lattice. \square

In conclusion

Corollary 2.5 *If the minimal plumbing tree Γ gives rise to a complex surface singularity which admits a rational homology disk smoothing, then $\Gamma \in \mathcal{S}$. \square*

Since the only rational singularities with trivial $D(\Gamma)$ are a smooth point and rational double point of type E_8 , it follows that every Milnor fiber M with $\mu = 0$ has non-trivial $H_1(M; \mathbb{Z})$. Examples with $\pi_1(M)$ finite and non-abelian will be shown in Section 8, e.g. Example 8.12. On the other hand, recall that Milnor fibers of hypersurface and complete intersection singularities are always simply connected.

Remark 2.6 As is shown in [30], graphs in \mathcal{G}_{rat} can be symplectically blown down. This result has been extended in [7] to graphs in $\mathcal{W} \cup \mathcal{N} \cup \mathcal{M}$. The general case of symplectic blowing down has been recently treated in [8].

2.4 Further considerations

Notice that graphs in \mathcal{S} only capture some aspects of the combinatorics for a configuration to admit a rational homology disk smoothing or to be one which can be rationally blown down. We make some short remarks concerning the question of which elements of \mathcal{S} actually arise in one of our three situations. Further discussion is postponed to a future paper.

If Σ is a compact rational homology 3–sphere with no 2–torsion in its first homology, then there is a well–known topological obstruction for Σ to bound (smoothly) a rational homology disk. The μ -invariant of Σ is an integer mod 16 computed from the signature of a spin 4-manifold bounding Σ (e.g., [10, p. 46]); it must be 0 if Σ bounds a rational homology disk. Neumann and Raymond [17] show how to compute μ for a plumbed 3-manifold. One easily finds that the class \mathcal{C} example

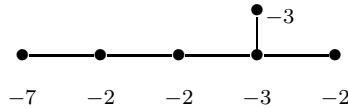

has $\mu = 8$, hence its boundary cannot bound a rational homology disk. Similar examples exist for types \mathcal{A} and \mathcal{B} .

There are further exclusions when considering smoothability of surface singularities; as already mentioned, any such must have the graph of a rational surface singularity. For example the graph of Figure 12 is of class \mathcal{B} , but represents a minimally elliptic singularity (of geometric genus 1 [13]), so could not give a rational homology disk smoothing.

3 Symplectic plumbing trees

The next four sections are devoted to the proof of Theorem 1.8. The arguments in these sections are purely combinatorial. We start with some generalities regarding plumbing trees in \mathcal{S} . From now on, we will identify the vertex v of Γ with its image $\varphi(v)$ (a linear combination of the E_i 's) in the diagonal lattice $\langle E_1, \dots, E_n \rangle = n\langle -1 \rangle$. We will say that E_i is in v (or E_i contributes to v) if

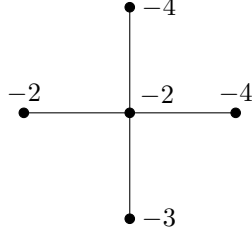

Figure 12: Graph in $\mathcal{B} \subset \mathcal{S}$ with no rational homology disk smoothing

$Q(E_i, v) \neq 0$. In this case the *multiplicity* of E_i in v is equal to $-Q(E_i, v)$. With a slight abuse of notation, the product $Q(v, w)$ sometimes will be written as $v \cdot w$ or even as vw . In the rest of the paper we will always assume that $\Gamma \in \mathcal{S}$.

Lemma 3.1 *For a vertex $v \in \Gamma$ we have either*

$$v = E_{i_v} - \sum_{j \in J_v} E_j$$

or

$$v = -2E_{i_v} - \sum_{j \in J_v} E_j$$

with i_v not being in the index set $J_v \subset \{1, \dots, n\}$.

Proof Suppose that $v = \sum_k \alpha_k E_k$ with $\alpha_k \in \mathbb{Z}$. From the fact that

$$\left(\sum_{i=1}^n E_i \right) \cdot v + v \cdot v = -2, \tag{3.1}$$

we conclude that

$$-\sum_k \alpha_k (\alpha_k + 1) = -2,$$

implying that either exactly one α_k is equal to 1 and all the others are 0 or -1 , or exactly one is equal to -2 and all the others are 0 or -1 . This observation clearly implies the result. \square

It is easy to see that (in some sense) the converse of this statement also holds: if the minimal plumbing tree Γ is embedded into the diagonal lattice $n\langle -1 \rangle$

with $n = |\Gamma|$ and for all $v \in \Gamma$ we have that v (in the orthogonal basis of the diagonal lattice) has one of the forms listed in the statement of the lemma above, then v satisfies (3.1) and so Γ is, in fact, in \mathcal{S} .

Corollary 3.2 *Suppose that $\{v_{i_1}, \dots, v_{i_k}\}$ are vertices of Γ determining a connected subtree. Then*

$$\sum_{j=1}^k v_{i_j}$$

is of the form given by Lemma 3.1.

Proof Notice that if v_1 and v_2 both satisfy (3.1) and v_1, v_2 are connected in Γ (that is, $v_1 \cdot v_2 = 1$) then

$$\left(\sum_{i=1}^n E_i\right) \cdot (v_1 + v_2) + (v_1 + v_2)^2 = -2,$$

hence the sum of the classes v_1 and v_2 also satisfies (3.1). Then Lemma 3.1 together with a simple inductive argument implies the corollary. \square

Applying the above idea for Γ itself we get the following (cf. also the three basic examples of Figure 1 in the Introduction):

Corollary 3.3 *If $\Gamma \in \mathcal{S}$ is defined on n vertices $\{v_1, \dots, v_n\}$ then*

$$\left|\sum_{i=1}^n v_i^2\right| \leq 3n + 1.$$

Proof Notice that $(\sum_{i=1}^n v_i)^2 = 2\sum_{i<j} v_i v_j + \sum_{i=1}^n v_i^2$, and since Γ is a tree, we have $\sum_{i<j} v_i v_j = n - 1$. Now the fact $\sum_{i=1}^n v_i = -2E_i - \sum_{j \in J} E_j$ or $\sum_{i=1}^n v_i = E_i - \sum_{j \in J} E_j$ (with $J \subset \{1, \dots, n\} - \{i\}$) implies that $(\sum_{i=1}^n v_i)^2$ is either $-4 - |J| \geq -3 - n$ or $-1 - |J| \geq -n$. This observation implies the statement. \square

Proposition 3.4 *Suppose that for Γ as above there is a vertex v of the form $-2E_{i_v} - \sum_{j \in J_v} E_j$. Then for all other vertices $w \in \Gamma$ we have*

$$w = E_{i_w} - \sum_{j \in J_w} E_j.$$

Proof Suppose that there are two vertices v_1, v_2 in Γ such that

$$v_k = -2E_{i_{v_k}} - \sum_{j \in J_{v_k}} E_j \quad (k = 1, 2).$$

Consider the path $\{w_l \mid l = 1, \dots, m\}$ of vertices connecting v_1 and v_2 in Γ , that is, a set of vertices defining a chain in Γ connecting v_1 and v_2 . Assume furthermore that the elements w_l for l different from 1 and m are of the form $E_{i_{w_l}} - \sum_{j \in J_{w_l}} E_j$. (Otherwise we could choose a shorter chain with endpoints admitting the same properties as v_1, v_2 and satisfying this additional requirement.) It is easy to see that if $m > 2$ then $w_1 + w_2$, and so by induction $w_1 + \dots + w_{m-1}$ is of the form $-2E_i - \sum_{j \in J} E_j$ for some i and index set J . (Here we use the assumption that $Q(w_i, w_{i+1}) = 1$.) Then the sum $w_1 + \dots + w_m$ would violate (3.1), since it contains at least two E_k 's with multiplicity -2 , contradicting Corollary 3.2. \square

In short, by Proposition 3.4 in $\Gamma \in \mathcal{S}$ there is at most one vertex v which is of the form $-2E_{i_v} - \sum_{j \in J_v} E_j$ and all other vertices are of the shape $E_k - \sum_{j \in J} E_j$. A slight generalization of the above proposition follows from the same principle:

Corollary 3.5 *Suppose that $\Gamma \in \mathcal{S}$ and $\Gamma_1, \Gamma_2 \subset \Gamma$ are disjoint connected subtrees. Then at least one of the vectors $w_k = \sum_{v \in \Gamma_k} v$ ($k = 1, 2$) is of the form $E_{i_{w_k}} - \sum_{j \in J_{w_k}} E_j$. \square*

Lemma 3.6 *Suppose that for two vertices $v_1 \neq v_2$ we have*

$$v_k = E_{i_{v_k}} - \sum_{j \in J_{v_k}} E_j \quad (k = 1, 2).$$

Then $i_{v_1} \neq i_{v_2}$.

Proof Recall that the pairing $Q(v_1, v_2)$ is either 1 or 0 (depending on whether v_1 and v_2 are connected in Γ or not). If $i_{v_1} = i_{v_2}$ then

$$Q(v_1, v_2) = (E_{i_{v_1}} - \sum_{j \in J_{v_1}} E_j) \cdot (E_{i_{v_2}} - \sum_{j \in J_{v_2}} E_j) = -1 + \sum_{j \in J_{v_1} \cap J_{v_2}} (-1) \leq -1,$$

providing the desired contradiction. \square

Consequently, each E_i appears in at most one $v_j \in \Gamma$ with positive coefficient. By Corollary 3.2, the sum $w = \sum_{v \in \Gamma} v$ is either of the form $E_i - \sum_{j \in J} E_j$ or of the form $-2E_k - \sum_{j \in J} E_j$; so, summing all the coefficients of E_i gives 1, 0, -1 , or -2 . Hence, for an index i there are ten possibilities for E_i to be contained by vectors of Γ :

Lemma 3.7 *If i is an index between 1 and n then for the basis vector E_i of the diagonal lattice Q_n one of the following ten possibilities can occur:*

- (1) E_i appears in a single vector of Γ with multiplicity 1;
- (2) E_i appears in a single vector of Γ with multiplicity -1 ;
- (3) E_i appears in a single vector of Γ with multiplicity -2 ;
- (4) E_i appears in two vectors of Γ , once with multiplicity 1 and in another with multiplicity -1 ;
- (5) E_i is in two vectors of Γ , with multiplicities 1 and -2 ;
- (6) E_i is in two vectors of Γ , with both multiplicities -1 ;
- (7) E_i is in three vectors of Γ , with multiplicities 1, -1 , -1 ;
- (8) E_i is in three vectors of Γ , with multiplicities 1, -1 and -2 ;
- (9) E_i is in four vectors of Γ , once with multiplicity 1, and in three with multiplicity -1 ;
- (10) E_i does not appear in any vector of Γ at all. □

We start with a few observations regarding the types of indices occurring in an embedding $\Gamma \subset n\langle -1 \rangle$. First, it is easy to see that (8) cannot occur, since if v_1 contains $-E_i$ and v_2 contains $-2E_i$ then $Q(v_1, v_2) \leq -1$, contradicting our assumptions. If i is an index of type (10), then adding $-E_i$ to a single (but otherwise arbitrary) $v \in \Gamma$ we change Γ and φ (through the decoration of the vertex to which we added $-E_i$) in a way that the resulting Γ' is still in \mathcal{S} but eliminated the index of type (10) — on the price of introducing one of type (2). (Later we will see that if i is an index of type (2) then $-E_i$ can appear only in a vector of square -2 , hence we cannot change an index of type (2) to one of type (10) within the category of minimal plumbing trees.) In the following we will always assume that Γ admits no index of type (10).

If $\Gamma \subset n\langle -1 \rangle$ involves an index of type (1) then by changing both Γ and the embedding φ we get a new embedding $\varphi': \Gamma' \rightarrow n\langle -1 \rangle$ where no index of type (1) exists: if $v = E_{i_v} - \sum_{j \in J_v} E_j$ and E_{i_v} does not appear in any other vector (that is, i_v is of type (1)) then by changing v to $v' = -2E_{i_v} - \sum_{j \in J_v} E_j$ we get another $\Gamma' \in \mathcal{S}$ which only differs from Γ by the decoration of v (which has been reduced by 3). Therefore a type (1) index can be changed to be of type (3). The next theorem shows that, in fact, a type (3) index can never appear in a graph of \mathcal{S} defined on more than one vertex:

Theorem 3.8 *There is no minimal symplectic plumbing tree $\Gamma \in \mathcal{S}$ on $n > 1$ vertices involving an index of type (3).*

Proof A simple check shows that the theorem holds for $n = 2$. Suppose that Γ is a plumbing tree on n vertices ($n \geq 3$) and it involves an embedding into $n\langle -1 \rangle$ with an index i of type (3). Consider such a Γ with the smallest possible n . Let $v = E_{i_v} - \sum_{j \in J_v} E_j$ be a *leaf* of the graph Γ (i.e., an "end" of the tree). The existence of such v follows from our assumption $n > 1$. It also follows from its form that E_i does not appear in v . If i_v is of type (5), (7) or (9) then the sum

$$u = \sum_{v_j \neq v} v_j$$

of all the other vertices (which form a connected subgraph, since v is a leaf) will contain $-E_{i_v}$ with multiplicity at least 2, but u also contains $-2E_i$ (recall that i is the index of type (3)) contradicting Corollary 3.2. If i_v is of type (4) (the only remaining possibility), then consider the unique vertex $v' \in \Gamma$ with $Q(v, v') = 1$, and distinguish two cases according to whether $-E_{i_v}$ does or does not appear in v' . Suppose first that the unique $-E_{i_v}$ is in v' . By changing Γ to Γ' via replacing the edge $\overline{vv'}$ (and its two vertices) by one vertex $v + v'$, we eliminate the index i_v from the embedding; but $\Gamma' \in \mathcal{S}$ is now a minimal symplectic plumbing tree on $(n - 1)$ vertices (with an embedding into $(n - 1)\langle -1 \rangle$) which still has i as an index of type (3), contradicting our choice of Γ . (Notice that since $(v + v')^2 = v^2 + (v')^2 + 2 \leq v^2$, minimality of Γ' obviously follows.) Finally, if $-E_{i_v}$ appears in a vertex v'' different from v' then change Γ by deleting v and replacing the vector v'' by $v'' + E_{i_v}$. Once again, the resulting Γ'' will be contained by $(n - 1)\langle -1 \rangle$ (since the index i_v has been eliminated) and i is still an index of type (3) in Γ'' , hence if it is minimal, then it contradicts our choice for Γ . The plumbing graph Γ'' can contain only a unique vector with square -1 : this is $v'' + E_{i_v}$, implying that $v'' = E_{i_{v''}} - E_{i_v}$. In this case, however

$$0 = Q(v, v'') = 1 + Q(E_{i_v} - \sum_{j \in J_v} E_j, E_{i_{v''}}) \geq 1,$$

which is a contradiction. \square

Remark 3.9 Notice that for $n = 1$ the plumbing graph (-4) on one vertex (with the embedding $-2E_1$) does admit an index of type (3), hence our assumption $n > 1$ is essential. In fact, the above theorem can be rephrased as follows: $\Gamma \in \mathcal{S}$ contains an index of type (3) if and only if $|\Gamma| = 1$. This form of the previous result will be very helpful in our later arguments, cf. Lemma 5.6.

Remark 3.10 We also note that the line of argument above (considering a leaf $v = E_{i_v} - \sum_{j \in J_v} E_j$, distinguishing two cases according to whether i_v is of

types (5),(7), (9), or of type (4), and in this latter case examining where $-E_{i_v}$ is) will be repeatedly applied throughout the proof of Theorem 1.8.

From the result above we conclude that an index of type (1) in $\Gamma \in \mathcal{S}$ is also impossible once $|\Gamma| > 1$, which we always assume. (For a graph Γ with $|\Gamma| = 1$ the presence of an index of type (1) contradicts the minimality of Γ .) It follows then that the sum $w = \sum_{v \in \Gamma} v$ is of the form

$$-2E_w - \sum_{j \in J_w} E_j.$$

In order to analyze more systematically which types of indices can actually occur, let $\{v_1, \dots, v_n\}$ denote the vertices of Γ and notice that the sum

$$\sum_{i < j} Q(v_i, v_j) \tag{3.2}$$

is equal to the number of edges in Γ , and since Γ is assumed to be a connected tree, it is equal to $n - 1$. The sum (3.2) can be expanded according to the expansions of the vectors v_i in the basis $\{E_1, \dots, E_n\}$, and since $Q(E_i, E_j) = 0$ once $i \neq j$, the sum $n - 1 = \sum_{i < j} Q(v_i, v_j)$ decomposes as the sum of contributions of individual indices through the multiplicity of $Q(E_i, E_i)$ appearing in the expansion of (3.2). It is easy to see that for indices of types (4) and (7) this contribution is 1, for type (5) indices it is 2, if i is of type (6) then this contribution is -1 and finally for type (2) and (9) indices it is 0.

Now we can have a better picture about the possible types of indices Γ can have. Since $w = \sum_{i=1}^n v_i$ is of the form $-2E_i - \sum_{j \in J_i} E_j$, there is exactly one index i of type (6) or (9). A simple analysis shows that

- **(A)** If this index i is of type (6), then the remaining $n - 1$ indices contribute n to the sum (3.2), therefore one of them must be of type (5). By Proposition 3.4 at most one index of type (5) can exist, so the rest of the indices are either of type (4) or of type (7).
- **(B)** If i is of type (9) and there is an index of type (5) among the remaining ones (and then it is necessarily unique), then there exists a unique index of type (2), and the rest of the indices are of types (4) or (7).
- **(C)** If i is of type (9) and there is no index of type (5) then all others are of types (4) or (7).

In the next three sections we will analyze these three possibilities separately. More precisely, we will verify the following three statements, the combination of which (together with Propositions 4.4, 5.7 and 6.9) prove Theorem 1.8.

Theorem 3.11 *If $\Gamma \in \mathcal{S}$ with rank $|\Gamma| = n$ embeds into $n\langle -1 \rangle$ with indices as described in Case (A) above then $\Gamma \in \mathcal{G}_{rat}$.*

Theorem 3.12 *If $\Gamma \in \mathcal{S}$ with rank $|\Gamma| = n$ embeds into $n\langle -1 \rangle$ with indices as described in Case (B) above then $\Gamma \in \mathcal{C}$.*

Theorem 3.13 *If $\Gamma \in \mathcal{S}$ with rank $|\Gamma| = n$ embeds into $n\langle -1 \rangle$ with indices as described in Case (C) above then $\Gamma \in \mathcal{W} \cup \mathcal{N} \cup \mathcal{M} \cup \mathcal{A} \cup \mathcal{B}$.*

Before starting the proofs, however, we make some preparatory definitions and observations.

Definition 3.14 A vector $v = E_{i_v} - \sum_{j \in J_v} E_j$ is *full* if i_v is of type (5), (7) or (9). The plumbing graph Γ is *full* if it has an embedding with no index of type (4).

Lemma 3.15 *The connected tree $\Gamma \in \mathcal{S}$ on n vertices is full if and only if (after possibly reordering the indices)*

$$\sum_{i=1}^n v_i = -E_1 - E_2 - \dots - E_{n-1} - 2E_n.$$

Proof By the exclusion of indices of types (1), (3), (4), (8) and (10), in the sum $w = \sum_{v \in \Gamma} v$ each E_i comes with multiplicity -1 or -2 , and there is a single one with multiplicity -2 , verifying the lemma. \square

Lemma 3.16 *The symplectic plumbing tree $\Gamma \in \mathcal{S}$ is full if and only if*

$$\sum_{i=1}^n v_i^2 = -3n - 1.$$

Proof Consider the vector $w = \sum_{i=1}^n v_i$. It is easy to see that $w^2 = \sum_{i=1}^n v_i^2 + 2\sum_{i < j} v_i v_j$. Since $\sum_{i < j} v_i v_j$ counts the number of edges in Γ , and it is a connected tree, we get that

$$w^2 = \sum_{i=1}^n v_i^2 + 2(n-1).$$

Since by the previous observation Γ is full if and only if $w^2 = -n - 3$, the result follows. \square

Remark 3.17 Notice that according to Corollary 3.3 the graph is full if and only if $|\sum_{i=1}^n v_i^2|$ is maximal.

Proposition 3.18 *The plumbing tree $\Gamma_{p,q,r} \in \mathcal{W}$ is full for all $p, q, r \geq 0$.*

Proof A simple direct check provides the proof:

$$\sum v_i^2 = -2(p + q + r) - p - 3 - q - 3 - r - 3 - 4 = -3(p + q + r + 4) - 1.$$

□

Similarly, a somewhat more tedious, but straightforward computation shows that

Proposition 3.19 *The plumbing trees in $\mathcal{M} \cup \mathcal{N}$ are all full.*

□

It is not hard to see that the graphs of Figure 10 become full after adding $-1, -2, -3$ appropriately to the (-1) -vertex. However, the graphs in the families $\mathcal{A}, \mathcal{B}, \mathcal{C}$ are full only in the cases when during the blow-up process we only blow up edges of the configuration. That is, during the blow-up process we never created a leaf of square (-1) , as in Figure 11(a); the resulting graphs are all star-shaped, with one node of valency 3.

4 The classification of graphs of Case (A)

Before starting the proof of Theorem 3.11 we need a little preparation, showing in particular that the graphs in \mathcal{G}_{rat} are all full.

4.1 Continued fraction computations

In this subsection we flesh out Remark (2.8.2) of [31]. Define the class of plumbing trees \mathcal{G} as the minimal set of plumbing trees which **(a)** contains $\Gamma = (-4)$ and **(b)** if the linear chain $\Gamma = (-a_1, \dots, -a_k)$ is in \mathcal{G} ($a_i \in \mathbb{N}, a_i \geq 2$) then so are $\Gamma_1 = (-2, -a_1, \dots, -a_n - 1)$ and $\Gamma_2 = (-a_1 - 1, -a_2, \dots, -a_n, -2)$. Notice that for all $\Gamma \in \mathcal{G}$ we have that the tree is, in fact, a chain. Let $[a_1, \dots, a_k]$ denote the value of the continued fraction expansion

$$a_1 - \frac{1}{a_2 - \frac{1}{\ddots - \frac{1}{a_k}}}$$

Proposition 4.1 *The plumbing tree $\Gamma = (-a_1, \dots, -a_k)$ (with $a_i \geq 2$ integers) is in \mathcal{G} if and only if there are relatively prime $p > q > 0$ such that*

$$[a_1, \dots, a_k] = \frac{p^2}{pq - 1}.$$

Proof The proof will follow from a simple induction. For (-4) we choose $p = 2$ and $q = 1$. Suppose that $[a_1, \dots, a_k] = \frac{p^2}{pq-1}$ and try to determine the value of $[a_1 + 1, \dots, a_k, 2]$. In the computation we will use the fact [19, Appendix] that if $[b_1, \dots, b_n] = \frac{u}{v}$ then $[b_n, \dots, b_1] = \frac{u}{v'}$, where $vv' \equiv 1 \pmod{u}$. According to this principle and the definition, by the inductive hypothesis we get that

$$[a_1 + 1, \dots, a_k] = \frac{p^2}{pq - 1} + 1 = \frac{p^2 + pq - 1}{pq - 1},$$

hence

$$[a_k, \dots, a_1 + 1] = \frac{p^2 + pq - 1}{p^2 - q^2 - 2},$$

consequently

$$[2, a_k, \dots, a_1 + 1] = \frac{(p + q)^2}{p^2 + pq - 1},$$

implying that

$$[a_1 + 1, \dots, a_k, 2] = \frac{(p + q)^2}{q(p + q) - 1}.$$

Now simple induction verifies the result. For the graph defined by the array $(-2, -a_1, \dots, -a_n - 1)$ we proceed similarly. \square

Notice that, as a consequence of the above result, elements of \mathcal{G} are exactly the plumbing chains considered in [22] as *generalized rational blow-downs*. In particular, $\mathcal{G} = \mathcal{G}_{rat}$ (and from now on we will denote \mathcal{G}_{rat} by \mathcal{G}).

Proposition 4.2 *For any $p > q > 0$ relative prime, the symplectic plumbing tree $\Gamma_{\frac{p}{q}}$ is full.*

Proof Since for $|\Gamma| = 1$ the graph (-4) is full, and the inductive step constructing elements of \mathcal{G} decreases $\sum v_i^2$ by 3 when increasing the number of vertices by 1, it is obvious that elements of \mathcal{G} are full. Now the above identification of \mathcal{G} with \mathcal{G}_{rat} concludes the proof. \square

4.2 The proof of Theorem 3.11

After these preliminary results we are ready to prove Theorem 3.11. It turns out to be more convenient to prove a slightly stronger statement than Theorem 3.11, which obviously implies the result.

Proposition 4.3 *Suppose that $\Gamma \in \mathcal{S}$ involves an index t of type (6), that is, Γ is listed in Case (A). Then $\Gamma \in \mathcal{G}$ with the additional property that the two vectors containing $-E_t$ are the two endpoints of the plumbing chain.*

Proof The statement is easy to check for $n = 2$. Consider the graph Γ on n vertices such that for all $k < n$ the symplectic plumbing trees of Case (A) defined on k vertices satisfy the conclusion of the proposition. Suppose that $n \geq 3$.

First, using induction, we show that if the two vectors v_1, v_2 containing $-E_t$ are leaves of Γ then $\Gamma \in \mathcal{G}$. Add E_t to v_1, v_2 and delete the one (call it v) which has smaller decoration in absolute value. The resulting plumbing tree $\Gamma' \in \mathcal{S}$ (which is now defined on $(n - 1)$ vertices) is still connected (since we deleted a leaf), and it is embedded in $(n - 1)\langle -1 \rangle = \oplus_{i \neq t} \langle E_i \rangle$. It follows from the above construction that Γ' still has no index of type (9), therefore it is still of Case (A). We claim that Γ' is also minimal. If it contains a vertex of the form E_i , then the two leaves v_1, v_2 of Γ containing $-E_t$ had the shape $v_1 = E_{v_1} - E_t$ and $v_2 = E_{v_2} - E_t$. This implies $Q(v_1, v_2) = -1$, a contradiction. Therefore Γ' is minimal, and so by our inductive hypothesis we have that $\Gamma' \in \mathcal{G}$ and the index t' of type (6) appears in the two leaves of Γ' . Since a graph in \mathcal{G} is full, the deleted vector v can only have the shape $v = E_{t'} - E_t$, hence this observation implies that Γ can be built from Γ' by adding $-E_t$ to the vector on one of its ends, and concatenating Γ' with a new vector v having $v^2 = -2$ on the other end. Since $\Gamma' \in \mathcal{G}$, this shows that $\Gamma \in \mathcal{G}$. We also see that in Γ the vectors involving type (6) indices are on the two ends of the plumbing chain.

Suppose now that (at least) one of the vectors v_1, v_2 containing $-E_t$ is not a leaf, say it is v_1 . Our goal is to derive a contradiction from this assumption. Since $|\Gamma| \geq 3$, it has at least two leaves, therefore we have a leaf v with $Q(v, E_t) = 0$. The vector v cannot be full, since then $\sum_{u \neq v} u$ would contain both E_{i_v} and E_t with multiplicity -2 . Similarly, by Corollary 3.5 the vector v cannot be of the form $-2E_{i_v} - \sum_{j \in J_v} E_j$ either. So we can assume that $v = E_{i_v} - \sum_{j \in J_v} E_j$ and i_v is of type (4), that is, there is a single further $-E_{i_v}$ in one of the vectors of Γ . Let v' denote the single vector connected to

v in Γ . If $-E_{i_v}$ is not in v' , then we can erase v from Γ and $-E_{i_v}$ from the vector w containing it, and the resulting graph Γ' (now on $(n-1)$ vertices, with an embedding into $(n-1)\langle -1 \rangle = \oplus_{i \neq i_v} \langle E_i \rangle$) is still minimal. Indeed, we changed only w , hence Γ' is nonminimal only if w was of the form $E_{i_w} - E_{i_v}$, in which case $Q(v, w) \geq 1$, giving a contradiction, since $w \neq v'$ and v' is the only vector having nontrivial pairing with v . Therefore $\Gamma' \in \mathcal{S}$, it still does not have any index of type (9), hence by induction $\Gamma' \in \mathcal{G}$ and so Γ' is full. Therefore a simple count on the indices shows that the only possibility for v is $v = E_{i_v}$ (since no vector E_j with other index can follow E_{i_v}), contradicting the minimality of Γ . In the last case to consider, when $-E_{i_v}$ is in v' , we need to refine the above argument in order to prove minimality for Γ' . Modify Γ first by adding v to v' ; notice that with this move we eliminated the index i_v , hence the resulting Γ'' embeds into $(n-1)\langle -1 \rangle$. Since $(v + v')^2 \leq v^2 \leq -2$, it follows that Γ'' is in \mathcal{S} involving no index of type (9), hence by induction $\Gamma'' \in \mathcal{G}$ and v_1, v_2 (by containing $-E_t$) are both leaves in Γ'' , although v_1 was not a leaf in Γ . This shows that $v' = v_1$, hence by deleting v from Γ and $-E_{i_v}$ from $v' = v_1$ we get a minimal graph Γ' (since $v_1 = v'$ still contains $-E_t$). Therefore the argument given for the case above applies and provides the desired contradiction, completing the proof. \square

For the proof of Theorem 1.8 we also need

Proposition 4.4 *If $\Gamma \in \mathcal{G}$ then $\Gamma \in \mathcal{S}$.*

Proof For the graph $\Gamma \in \mathcal{G}$ with $|\Gamma| = 1$ the statement is obvious: since Γ is full, it is (-4) and so the embedding $v \mapsto -2E$ is suitable. If $\Gamma \subset (n-1)\langle -1 \rangle = \oplus_{i=1}^n \langle E_i \rangle$ with $-E_t$ in v_1, v_2 on the two ends of the plumbing chain (recall that t is of type (6)), then the new vector $E_t - E_n$ and the modification $v_2 - E_n$ provides an appropriate embedding of the next element $\Gamma_{next} \in \mathcal{G}$ into $n\langle -1 \rangle$. (See also the arguments in Sections 7 and 8.) \square

5 Classification of graphs of Case (B)

Before examining the graphs listed under Case (B), we need a little preparation.

5.1 Generalities for embeddings of Cases (B) and (C)

Notice first that a simple case-by-case check shows that on 4 vertices there are exactly three graphs in \mathcal{S} with embeddings into $4\langle -1 \rangle$ of Cases (B) and (C);

these configurations are shown by Figure 1. Notice that these graphs are all full and the graph of Figure 1(a) is both in \mathcal{W} and in \mathcal{A} ; similarly Figure 1(b) belongs to both the families \mathcal{N} and \mathcal{B} , and Figure 1(c) to both \mathcal{M} and \mathcal{C} .

Definition 5.1 A vector $v = E_{i_v} - \sum_{j \in J_v} E_j$ in the minimal plumbing tree Γ is called *reducible* if the terms $-E_{i_v}$ are exactly contained by the neighbours of v . That is, $Q(v, w) = 1$ if and only if $Q(E_{i_v}, w) = 1$.

Note that for a reducible vector $v = E_{i_v} - \sum_{j \in J_v} E_j$ we have that $Q(-\sum_{j \in J_v} E_j, w) = 0$ for all $w \neq v$ in Γ . For, if $Q(v, w) = 0$ then w contains no $-E_{i_v}$ by the reducibility of v , hence $Q(-\sum_{j \in J_v} E_j, w) = Q(v, w) = 0$. If $Q(v, w) = 1$ then

$$1 = Q(v, w) = Q(E_{i_v}, w) + Q(-\sum_{j \in J_v} E_j, w) = 1 + Q(-\sum_{j \in J_v} E_j, w),$$

which implies the statement. For example the central (that is, of valency three) vertices of the graphs of Figure 1 under the "obvious" embeddings are all reducible, see also Propositions 5.7 and 6.9. Notice that the valency of a reducible vector v is 1, 2 or 3, and in the last case $v = E_1 - \sum_{j \in J_1} E_j$ where 1 is the index of type (9). The presence of a reducible vector will be convenient when applying inductive proofs.

Proposition 5.2 Consider the graph $\Gamma \in \mathcal{S}$ with indices either of Case (B) or of Case (C). Suppose that in Γ all leaves are full. Then Γ is full.

Proof We start with the observation that such a graph admits a unique vertex of valency three and all others are of valency ≤ 2 . This follows from the fact that if 1 denotes the index of type (9) then every leaf $v \in \Gamma$ must contain $-E_1$; otherwise, the sum $\sum_{u \neq v} u$ would have both $-2E_{i_v}$ and $-2E_1$. (The case $i_v = 1$ is easily excluded.) Therefore there are at most three leaves and if there are only two, then the sums of the two sides of $v_1 = E_1 - \sum_{j \in J_1} E_j$ are $-2E_1 - \sum_{j \in J'} E_j$ and $E_i - E_1 - \sum_{j \in J''} E_j$, and these two vectors would pair negatively. In addition, if $v = E_{i_v} - \sum_{j \in J_v} E_j$ is a full leaf, then one $-E_{i_v}$ is in another leaf: by considering the sum u of all vectors which are not leaves we see that u contains E_1 with multiplicity +1 and so it cannot contain $-2E_{i_v}$.

Suppose first that there is a reducible vector $v = E_{i_v} - \sum_{j \in J_v} E_j$ in Γ . Since all leaves are full, no reducible vector of valency 1 exists in Γ . If v is of valency two, then change v to E_{i_v} , blow down E_{i_v} and add $v - E_{i_v} = -\sum_{j \in J_v} E_j$ to the potential (-1) -vertex. (If there is no (-1) -vertex in the blown down graph then add it to any vector of the graph.) In this way we get a minimal

tree in \mathcal{S} , still of Case **(B)** or **(C)**, with full leaves, therefore induction applies and so the blown down graph is full. Since we changed the sum of the squares by 3, it shows that Γ was full. If the reducible vector is of valency three, then it is equal to $v_1 = E_1 - \sum_{j \in J_1} E_j$ (where 1 is the index of type (9)), and since the leaves are full, we have $n = 4$: any leaf must contain $-E_1$ but since v_1 is reducible, all vectors containing $-E_1$ are connected to v_1 . The graphs in \mathcal{S} on 4 vertices (given by Figure 1) are known to be full.

In the case when there is no reducible vector we need a lemma:

Lemma 5.3 *Let $w \in \Gamma$ be a vector different from the central vector v_1 (of valency three) and let the vector next to w in the path connecting w to the central vector v_1 be denoted by w' . Suppose that there is no reducible vector on the path between w and v_1 . Then $-E_{i_w}$ is in w' .*

Proof If $w_1 = w, w_2 = w', w_3, \dots, w_k = v_1$ denote the vectors on the path connecting w with v_1 then w_{k-1} does not admit $E_{i_{v_1}} = E_1$ (since besides v_1 this basis vector is in leaf only), so $w_k = v_1$ must contain $-E_{w_{k-1}}$ in order $Q(w_{k-1}, w_k) = 1$ to hold. Since w_{k-1} is not reducible, the potential other $-E_{w_{k-1}}$ cannot be in w_{k-2} , implying that w_{k-1} must contain $-E_{w_{k-2}}$. Applying the same principle we arrive to the fact that $w' = w_2$ contains $-E_{i_w}$. \square

Returning to the proof of Proposition 5.2, suppose now that Γ contains no reducible vector. Take a leaf u on a leg of length > 1 and denote the vertex connected to u by u' (which, by the length assumption, is different from v_1). Since there is no reducible vector on the leg of u , according to Lemma 5.3 we get that $-E_{i_u}$ is in u' . Therefore by replacing the edge $\overline{uu'}$ with $u + u'$ and deleting $-E_{i_u}$ from another leaf we get a graph Γ' , and since Γ' embeds into $(n-1)\langle -1 \rangle = \oplus_{i \neq i_u} \langle E_i \rangle$ and it is obviously minimal (since leaves contain $-E_1$), we get that $\Gamma' \in \mathcal{S}$. Since it still has an index of type (9), it is of Case **(B)** or **(C)**. In order to apply induction, we only need to show that Γ' has full leaves, and since we changed only one leaf, it boils down to showing that $u + u'$ is full. In other words, we have to find two $-E_{i_{u'}}$ in Γ . The first one is easy to find, since the lack of reducible vectors (by Lemma 5.3) implies that $-E_{i_{u'}}$ is in the vector $u_3 \neq u$ connected to u' . To find the second one, we need a longer argument. Let $v_l \in \Gamma$ denote the leaf containing $-E_{i_u}$. If the leg of v_l is of length > 1 , then (again by the above principle) one $-E_{i_{v_l}}$ must be in the (unique) vector connected to v_l , and the other one (which exists, since v_l is full) in a leaf, hence there is none in u' , although $Q(u', v_l) = 0$. Since both

vectors contain $-E_{i_u}$, this implies that $-E_{i_{u'}}$ is in v_l , finishing the argument. We still have to deal with the case when the leg of v_l is of length 1, that is, v_l is connected to the central vertex v_1 . If the third leg of Γ (i.e. the one with leaf w distinct from u and v_l) is of length > 1 , then using this w as the starting vector instead of u the inductive argument proceeds. Therefore we only need to consider the last case when two legs of Γ are of length one. Suppose that the leaves of these short legs are v_l and w as above. Then, as above, we can assume that $-E_{i_u}$ is in v_l , and if $-E_{i_{u'}}$ is not in v_l then $-E_{i_{v_l}}$ must be in u' . This implies that $-E_{i_{v_l}}$ cannot be in u , hence it must be in w , and so either $-E_{i_{u'}}$ is in w (finishing our search) or $-E_{i_w}$ is in u' , which contradicts the fact that $Q(u, u') = 1$ since $-E_{i_w}$ also contributes to u . This final (long) observation concludes the proof that $u + u'$ is full, hence by induction we can assume that Γ' is full, and since when forming Γ' from Γ we increased the sum of squares by 3, this implies that Γ is full. \square

A useful consequence of the above result provides an easy characterization of full graphs in \mathcal{S} :

Corollary 5.4 *The plumbing graph $\Gamma \in \mathcal{S}$ of Cases (B) or (C) is full if and only if Γ has three leaves.*

Proof The first paragraph of the proof of Proposition 5.2 shows that if Γ is full (hence admits only full leaves) then Γ has three leaves. Conversely, if Γ has three leaves and all leaves are full, then by Proposition 5.2 the plumbing graph Γ is full. Consider now the case when Γ has three leaves and v is a nonfull leaf. By denoting the unique vector connected to v by v' we distinguish two cases: If $-E_{i_v}$ is not in v' then by erasing v and adding E_{i_v} to the vector w ($\neq v'$) containing $-E_{i_v}$ we get a minimal graph with three leaves on less vertices, hence induction and the fact $v^2 \leq -2$ implies that Γ is full. If $-E_{i_v}$ is in v' , then the above argument breaks down only if $v' = E_{i_{v'}} - E_{i_v}$, i.e., after deleting v and $-E_{i_v}$ the resulting plumbing graph is not minimal. Now adding v to v' (and applying induction) we get that the resulting graph Γ' is full. This, however, means that the other two leaves w, u of Γ are full and (by denoting the type (9) index by 1) the basis element $-E_1$ is in v (since it is in $v + v'$ but $v' = E_{i_{v'}} - E_{i_v}$). Since u and w are full, a copy of $-E_1$ is in both u and w . Now $Q(v, u) = Q(v, w) = 0$ implies that $-E_{i_u}$ and $-E_{i_w}$ are in v , and so are in $v + v'$. In this case $Q(v', u) = Q(v', w) = 0$ shows that both u and w contain $-E_{i_{v'}}$. In this point we reached the desired contradiction, since a vector other than v can connect to v' only through $-E_{i_{v'}}$. This final contradiction shows that a graph with three leaves is full. \square

5.2 Embeddings with indices of Case (B)

We are now ready to consider graphs $\Gamma \in \mathcal{S}$ with indices of Case (B). Recall that we denoted the type (9) index by 1, while the type (2) index will be denoted by 2. Let v denote the vector containing $-E_2$. In the classification we follow the strategy of first proving that a graph Γ of Case (B) always admits a reducible vector v ; this vector always contains $-E_2$; and, either v is of valency three (in which case we show that $|\Gamma| = 4$ and the graph is given by Figure 1(c)), or we can contract it and apply induction. These three steps will be treated separately in the three proofs of the rest of this section.

Proposition 5.5 *Suppose that Γ is of Case (B) and v contains $-E_2$ (where 2 is the index of type (2)). Then for v we have $v^2 = -2$; in particular, $v = E_{i_v} - E_2$ is reducible.*

Proof We proceed by induction on $|\Gamma|$. For $n = 4$ a case-by-case check verifies the result. Suppose that the statement is verified for all graphs on less than n vertices, and Γ is of Case (B) defined on $n \geq 5$ vertices.

Suppose first that Γ has a nonfull leaf $u = E_{i_u} - \sum_{j \in J_u} E_j$, which is connected to u' . Assume first that $-E_{i_u}$ is not in u' . If u contains $-E_2$ then either $u^2 = -2$, verifying the result, or we can move $-E_2$ to any other vector and keep the resulting graph minimal. Therefore in the following we can assume that $-E_2$ is not in u . Delete u from Γ and the single $-E_{i_u}$ from the vector $w \in \Gamma$ ($w \neq u'$) and get Γ' embedded in $(n-1)\langle -1 \rangle$. The usual argument shows that Γ' is minimal: if $w = E_{i_w} - E_{i_u}$ then $Q(u, w) \neq 0$. Also, since $-E_2$ is in $\Gamma' \in \mathcal{S}$, it is obviously of Case (B). Therefore by induction $-E_2$ is in a vector of square -2 in Γ' . The basis element $-E_2$ cannot be in $w \in \Gamma$, since then by induction $(w + E_{i_u})^2 = -2$ and so $Q(u, E_{i_w} - E_{i_u} - E_2) = Q(u, w) \neq 0$. This shows that the vector containing $-E_2$ was not changed when creating Γ' from Γ hence the statement of the proposition follows by induction on Γ . We have to examine the case when u' contains $-E_{i_u}$. Then adding u to u' we can apply induction again. If $-E_2$ is in $u + u'$ then by induction $(u + u')^2 = -2$, implying $u^2 = (u')^2 = -2$. If $-E_2$ is not in $u + u'$ then $-E_2$ is in a vector not altered by adding u to u' , implying the result.

Suppose next that all leaves are full. Then by the proof of Proposition 5.2 the graph Γ has exactly three leaves and (again by Proposition 5.2) Γ is full. Assume that $n > 4$ and let u be a leaf on the longest leg (of length > 1), connected to u' . Assume first that on this leg all vectors are of the form $w = E_{i_w} - \sum_{j \in J_w} E_j$. By Lemma 5.3 if u' does not contain $-E_{i_u}$, then on the

leg there is a reducible vector $v = E_{i_v} - \sum_{j \in J_v} E_j$ of valency two. Modifying v to E_{i_v} we can blow it down, and in the blown-down graph there is at most one (-1) -vertex, to which we can add $v - E_{i_v}$, hence forming a minimal graph. Note that the blown down graph Γ' has also three leaves, and since before adding $v - E_{i_v}$ it cannot be full, by Corollary 5.4 the graph Γ' must contain a vector of square (-1) ; we added $v - E_{i_v}$ to this vector. Induction now shows that in this graph $-E_2$ is in a vector of square -2 . This vector was either intact by our operation, or it is one of the two affected by the blow down. In the first case the proof is obviously complete, in the second case we see that the two vectors (after the blow-down) cannot have the shape $E_a - E_2$ and $E_b + v - E_{i_v}$ since these two vectors give zero pairing with each other. This shows that $v - E_{i_v} = -E_2$, verifying the statement. If u' contains $-E_{i_u}$, then the other $-E_{i_u}$ must be in one of the leaves of the graph, cf. the proof of Proposition 5.2. Consider the Γ' we get by adding u to u' and deleting $-E_{i_u}$ from the other leaf. Since Γ was full, the graph Γ' is also full, and so has full leaves. Then $-E_2$ is in a vector of square -2 in Γ' , which cannot be the leaf we modified, since $-E_1$ is there, hence it would have square -3 in Γ' . Therefore $-E_2$ is either in a vector not changed by our reduction or in $u + u'$, both cases implying the result.

Finally we have to consider the case when on the longest leg we chose there is a vector w of the form $-2E_3 - \sum_{j \in J_w} E_j$. In this case $-E_1$ must be in w , since otherwise the sum of vectors between w and the central vector v_1 (including both) would contain $+E_1$ and $-2E_j$ for some j . (There is no $-E_1$ between w and v_1 since $-E_1$ must be in leaf.) Therefore w is a leaf. If w' is the unique vector connected to w then $-E_{i_{w'}}$ is in w , hence the argument given in Lemma 5.3 shows the existence of a reducible vector on the leg of w . From that fact the proof given above applies. Notice that if there is no vector between w and v_1 then (since we chose the longest leg of Γ) we get that $|\Gamma| = 4$, which case has been already discussed. \square

As a final preparatory result, we need to examine the case when Γ has a reducible vector of valency three.

Lemma 5.6 *Suppose that Γ is of Case (B) and it has a reducible vector of valency three. Then $|\Gamma| = 4$ and Γ is isomorphic to the graph given by Figure 1(c).*

Proof Obviously $v_1 = E_1 - \sum_{j \in J_1} E_j$ can be the only reducible vector of valency three. Suppose that it is connected to u_1, u_2, u_3 . Then by Corollary 3.5

we have that one of the vectors, say u_1 must be of the form $u_1 = -2E_3 - \sum_{j \in J_{u_1}} E_j$ and the shape of $v_1 + u_1 + u_2 + u_3$ implies that $u_2 = E_3 - \sum_{j \in J_{u_2}} E_j$. If $u_3 = E_4 - \sum_{j \in J_{u_3}} E_j$ then a straightforward argument (based on the fact that $Q(u_i, u_j) = 0$ for $1 \leq i \neq j \leq 3$) shows that $-E_4$ must be in u_1 and u_2 (since u_1, u_2, u_3 all contain $-E_1$ by the reducibility assumption). Let $w = v_1 - E_1$; by the reducibility of v_1 we have that $Q(w, u) = 0$ for all u distinct from v_1 . Suppose that $u \in \Gamma$ contains $-E_2$. If u is among $\{v_1, u_1, u_2, u_3\}$ then delete $-E_2$ from it, otherwise modify u to $u + E_2 + w$. Finally contract the subgraph $\{v_1, u_1, u_2, u_3\}$ to the single vertex $E_1 + u_1 + u_2 + u_3 + E_3 + E_4$. In this way we get a new minimal graph $\Gamma' \in \mathcal{S}$ on $n - 3$ vertices, embedded into $(n - 3)\langle -1 \rangle$, since the indices 2, 3, and 4 have been eliminated. Notice that Γ' contains an index of type (3) (the index 1 which was of type (9) in Γ), hence by Theorem 3.8 (cf. Remark 3.9) we get that $|\Gamma'| = n - 3 = 1$. The classification of graphs on 4 vertices then concludes the proof. \square

Now we are ready to prove the classification result for this case:

Proof of Theorem 3.12 Let $v \in \Gamma$ be the vector containing $-E_2$. By Proposition 5.5 we know that $v + E_2 = E_{i_v}$ is of square -1 and therefore it is reducible. If v is of valency 1 or 2 then we can blow it down and in the resulting graph Γ' there is no E_{i_v} , and in addition there is at most one vector of square -1 . By adding $-E_2$ to this potential (-1) -vector (resulting Γ''), by induction we have $\Gamma'' \in \mathcal{C}$; moreover the vector we added $-E_2$ to has square -2 , hence before adding $-E_2$ it was of square -1 , implying that $\Gamma \in \mathcal{C}$. If the valency of v is three then the application of Lemma 5.6 concludes the proof. \square

As in Proposition 4.4, we also need that elements of \mathcal{C} actually satisfy the conditions defining \mathcal{S} .

Proposition 5.7 *If $\Gamma \in \mathcal{C}$ then $\Gamma \in \mathcal{S}$.*

Proof The vectors $-2E_3 - E_1 - E_4, E_1, E_3 - E_4 - E_1, E_4 - E_1$ provide an appropriate embedding of the graph of Figure 10(c) into $3\langle -1 \rangle$. After n blow-ups the resulting graph on $(n + 4)$ vertices embeds into $(n + 3)\langle -1 \rangle$, and by adding $-E_2$ to the unique (-1) -vertex, the proof is complete. Notice, for example, that the graph of Figure 1(c) embeds into $4\langle -1 \rangle$ as $-2E_3 - E_1 - E_4, E_1 - E_2, E_3 - E_4 - E_1, E_4 - E_1$, cf. Figure 13. \square

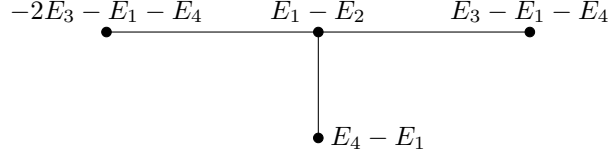

Figure 13: The embedding of the first element of \mathcal{C} into $4\langle -1 \rangle$

6 Classification of graphs of Case (C)

Suppose now that Γ embeds into $n\langle -1 \rangle$ with indices listed under Case (C). Notice first that in this case for every index i there is a unique vector v_i such that

$$v_i = E_i - \sum_{j \in J_i} E_j.$$

In the following we will distinguish two cases, according to whether the leaves of Γ are full or not.

6.1 Graphs with full leaves

We start with the case when all leaves of the plumbing tree are full. Recall that $i = 1$ denotes the unique index of type (9). As before, we have that there are exactly three leaves, each containing $-E_1$, and if $v = E_{i_v} - \sum_{j \in J_v} E_j$ is a leaf then one $-E_{i_v}$ is contained by another leaf, cf. the proof of Proposition 5.2. Recall also that Γ contains the unique vector $v_1 = E_1 - \sum_{j \in J_1} E_j$ of valency three and all other vectors have $\deg v \leq 2$.

Graphs with reducible vectors

First we will examine the case when the leaves are full, and the graph contains reducible vectors.

Theorem 6.1 *Suppose that Γ is a graph with indices of Case (C), all leaves are full and there is a vector which is reducible. Then $\Gamma \in \mathcal{A} \cup \mathcal{B}$.*

Proof We will proceed by induction. Consider the reducible vector $v = E_{i_v} - \sum_{j \in J_v} E_j$. Since the leaves are full, a leaf cannot be reducible. If v is of valency two, then change it to E_{i_v} , blow it down and consider the resulting

graph Γ' . Since Γ' with three leaves cannot be full (we erased v and two further $-E_{i_v}$), by Corollary 5.4 it is not minimal. Add $v - E_{i_v} = -\sum_{j \in J_v} E_j$ to the (-1) -vector and get Γ'' . This is a minimal graph, the leaves are still full, by construction it has a reducible vector (the (-1) -vector to which we added $-\sum_{j \in J_v} E_j$), hence induction applies, showing that $\Gamma'' \in \mathcal{A} \cup \mathcal{B}$. Now Γ is gotten from Γ'' by considering the reducible vector $w = E_{i_w} - \sum_{j \in J_w} E_j \in \Gamma''$, adding $\sum_{j \in J_w} E_j$ to it, blowing it up and then subtracting $\sum_{j \in J_w} E_j$ from the resulting new vertex with decoration (-1) .

The blowing down procedure will stop only when $\deg v = 3$ for the reducible vector v . Since the leaves are full, in this case we have $n = 4$, and we get that the resulting graph is one of Figures 1(a) or (b). Since in that case the square of the correction term $-\sum_{j \in J_w} E_j$ we added to the (-1) -vertex is -2 or -3 , it must have been the case throughout the whole process, since the two (or three) basis vectors cannot be grouped in two groups such that they give zero pairing with every other vector. This last observation completes the proof. \square

Graphs with no reducible vectors

The next case to consider is when the graph Γ has full leaves and it contains no reducible vector. It turns out that this is the longest case to discuss, and we will divide our classification into further subcases. To do that, recall that since the graph has full leaves, it is full, and has exactly three leaves w_1, w_2 and w_3 . From now on in this subsection we always assume that Γ is full and admits no reducible vectors.

- Definition 6.2**
- The leaves of the graph Γ as above are of type \mathbb{Z}_3 if (after possibly renaming the leaves) $-E_{i_{w_1}}$ is in w_2 , $-E_{i_{w_2}}$ is in w_3 and $-E_{i_{w_3}}$ is in w_1 .
 - The leaves of the graph Γ as above are of type \mathbb{Z}_2 if (again, after possibly renaming the leaves) $-E_{i_{w_1}}$ is in w_2 , another $-E_{i_{w_1}}$ is in w_3 and then it follows that $-E_{i_{w_3}}$ is in w_2 and $-E_{i_{w_2}}$ is in w_3 .
 - The leaf $w = E_{i_w} - \sum_{j \in J_w} E_j$ of a graph Γ with full leaves and no reducible vectors is called *free* if the single vector w' with $Q(w, w') = 1$ does not contain $-E_{i_w}$.

It is easy to see that if a leaf w is free, then (since Γ contains no reducible vector) it is connected to the central vertex v_1 (of valency three), that is $Q(w, v_1) = 1$. It is worth mentioning that $Q(w, v_1) = 1$ might hold without w being free. In

the graph Γ there are three leaves, and if all are free then the graph is defined on four vertices and is nonminimal (admitting the shape given by Figure 14, with vectors $E_2 - E_1 - E_3 - E_4, E_1, E_3 - E_1 - E_2 - E_4$ and $E_4 - E_1 - E_2 - E_3$). In the following therefore we restrict our attention to the cases when there are

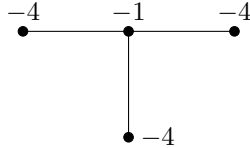

Figure 14: (Nonminimal) graph with three free leaves

zero, one or two free leaves in Γ . In fact, by definition if the leaves $\{w_1, w_2, w_3\}$ are of type \mathbb{Z}_2 then w_1 is automatically free, hence in this case we have only two cases to examine. Notice first that

Lemma 6.3 *Any graph with full leaves is either of type \mathbb{Z}_3 or of type \mathbb{Z}_2 .*

Proof Let $w_1 = E_{i_{w_1}} - \sum_{j \in J_{w_1}} E_j$ be a leaf. We already know that one $-E_{i_{w_1}}$ is in another leaf, say in w_2 . If the third leaf w_3 also contains $-E_{i_{w_1}}$ then in order to have $Q(w_2, w_3) = 0$ (since both vectors contain $-E_1$ and $-E_{i_{w_1}}$) we have that

$$w_2 = E_{i_{w_2}} - E_1 - E_{i_{w_1}} - E_{i_{w_3}} - \dots \text{ and } w_3 = E_{i_{w_3}} - E_1 - E_{i_{w_1}} - E_{i_{w_2}} - \dots,$$

showing that the leaves $\{w_1, w_2, w_3\}$ are of type \mathbb{Z}_2 .

If the third leaf w_3 does not contain $-E_{i_{w_1}}$ then (in order to achieve $Q(w_1, w_3) = 0$) we have that $-E_{i_{w_3}}$ is in w_1 . To get $Q(w_2, w_3) = 0$, we either have that $-E_{i_{w_3}}$ is in w_2 , which provides a set of leaves $\{w_1, w_2, w_3\}$ of type \mathbb{Z}_2 (with the indices permuted), or $-E_{i_{w_2}}$ is in w_3 , showing that the leaves are of type \mathbb{Z}_3 . Since we have examined all possibilities, the proof is complete. \square

The following two statements now classify graphs with full leaves and no reducible vectors: The graphs of Figures 22–27 (where the homology classes of the vertices are also indicated) might be helpful in following the proofs.

Proposition 6.4 *Suppose that $\Gamma \in \mathcal{S}$ of Case (C) has full leaves, no reducible vectors and its leaves are of type \mathbb{Z}_3 .*

- *If Γ has no free leaf then $\Gamma \in \mathcal{W}$.*

- If it has one free leaf then Γ is isomorphic to $\Delta_{p,q,r}$ with $p \geq 1$ and $q, r \geq 0$ (and so $\Gamma \in \mathcal{N}$).
- If Γ has two free leaves then it is isomorphic to $\Lambda_{p,q,r}$ with $p \geq 1$ and $q, r \geq 0$ (and so $\Gamma \in \mathcal{M}$).

Proof Suppose first that Γ admits no free leaf. Let us fix a leaf w_1 and assume that $-E_{i_{w_1}}$ is in w_2 . If w'_1 is the unique vector connected to w_1 , then according to Lemma 5.3 the other $-E_{i_{w_1}}$ is in w'_1 . The same principle also shows that if w''_1 is the next vector on this leg then it contains $-E_{i_{w'_1}}$; and so on throughout the leg. At the same time, since $Q(w_2, w'_1) = 0$, the fact that $-E_{i_{w_1}}$ is in w'_1 implies that $-E_{i_{w'_1}}$ must be in w_2 as well: recall that since there are no free leaves, $-E_{i_{w_2}}$ cannot be in w'_1 . Suppose that there are p vectors u_1, \dots, u_p on the leg of w_1 (not counting w_1 and the central vector v_1). Then the above argument shows that in w_2 we have all the basis vectors $-E_{i_{u_j}}$, next to $-E_{i_{w_1}}$, $-E_1$ and $E_{i_{w_2}}$. This shows that $w_2^2 \leq -p - 3$. The same argument now applies to all the three legs of Γ . The central element $v_1 = E_1 - \sum_{j \in J_1} E_j$ must connect to the three legs, and since all three E_1 's are in leaves and the leaves are not free, it follows that $v_1^2 \leq -4$. A simple count on the possible value of $\sum v_i^2$ shows that the estimates sum up to $-3|\Gamma| - 1$ (its smallest possible value) therefore the above inequalities must be equalities, and the shape of Γ is given by Figure 3 for some appropriate $p, q, r \geq 0$. This concludes the proof of the first case.

Suppose now that Γ admits one free leaf, say w_1 . This condition means that one $-E_{i_{w_1}}$ is in a leaf, the other is not (since the graph is not of \mathbb{Z}_2 -type), and it is also not in the central vector. Suppose that it is in u on one of the legs. The leg is determined in the following way: if $-E_{i_{w_1}}$ is in w_2 then the vector u must be on the leg of w_3 otherwise the absence of reducible vectors would imply $Q(w_1, v_1) = 0$, a contradiction. The vector u divides this leg into two pieces, having $p - 1$ vector on the side towards the leaf, and q towards the central element (not counting the leaf and the central vector) for some $p \geq 1$ and $q \geq 0$. The same estimates as before can be used to estimate the squares of the leaves, resulting $w_1^2 \leq -p - 2$, $w_2^2 \leq -q - 4$ and $w_3^2 \leq -r - 3$ (where r denotes the number of vertices on the leg not containing u). The central vector must satisfy only $v_1^2 \leq -3$ since there is only one free leaf (which can connect to v_1 by sharing $-E_1$). On the other hand, since u contains $-E_{i_{w_1}}$ we get that $u^2 \leq -3$. Again, the sum of the estimates already sums up to $-3|\Gamma| - 1$, showing that all inequalities must be equalities and so Γ is of the form $\Delta_{p,q,r}$. Since the graph is of type \mathbb{Z}_3 , the basis element $-E_{i_{w_1}}$ cannot be in the leaf w_2 , therefore we need $p \geq 1$. (The degeneration $p = 0$ will lead to a graph of

type \mathbb{Z}_2 , cf. Proposition 6.5.)

Finally, the presence of two free leaves w_1, w_2 means that two legs are degenerated to a single leaf, hence the second copies of $-E_{i_{w_1}}$ and $-E_{i_{w_2}}$ are on the same (nontrivial) leg. An argument similar to the previous one shows that if $-E_{i_{w_2}}$ is in the leaf of the long leg, then the basis vector $-E_{i_{w_1}}$ is then one closer to the leaf from the two “free” basis elements $-E_{i_{w_1}}$ and $-E_{i_{w_2}}$. The exact same analysis as above now shows that if these two basis vectors are in different vertices, then Γ is of the form $\Lambda_{p,q,r}$ with $p, r \geq 1$; and finally Γ is isomorphic to $\Lambda_{p,q,0}$ if both $-E_{i_{w_1}}$ and $-E_{i_{w_2}}$ are in the same vector. Notice that since Γ is of type \mathbb{Z}_3 , this vector cannot be a leaf. (The degeneration when both these basis elements are in a leaf is exactly $\Lambda_{0,q,0}$, which case (according to our point of view) falls in the category of Case **(B)** rather than Case **(C)**.) Now this vector u containing both $-E_{i_{w_1}}$ and $-E_{i_{w_2}}$ will satisfy $u^2 \leq -4$, hence the usual argument of summing the squares provides the result. \square

Proposition 6.5 *Suppose that $\Gamma \in \mathcal{S}$ of Case **(C)** has full leaves, no reducible vectors and its leaves are of type \mathbb{Z}_2 .*

- *If it has one free leaf then Γ is isomorphic to $\Delta_{0,q,r}$ with $q, r \geq 0$, in particular $\Gamma \in \mathcal{N}$.*
- *if Γ has two free leaves then it is isomorphic to $\Lambda_{0,p,r}$ ($q \geq 0$ and $r \geq 1$), so $\Gamma \in \mathcal{M}$.*

Proof Notice that (as we already remarked) the fact that Γ is of type \mathbb{Z}_2 implies that there is a free leaf w_1 , and both $-E_{i_{w_1}}$ are in the two other leaves. The same idea and the estimate on the sum of squares shows that such a graph is isomorphic to $\Delta_{0,q,r}$ for some $q, r \geq 0$.

If there are two free leaves w_1, w_2 (and Γ is still of type \mathbb{Z}_2) then for w_1 both $-E_{i_{w_1}}$ are in leaves (as is dictated by the fact that Γ is of type \mathbb{Z}_2), but the second $-E_{i_{w_2}}$ is on the single nontrivial leg. It gives rise to a vector u with $u^2 \leq -3$, and so the usual estimate on the sum of squares identifies Γ with a graph $\Lambda_{0,q,r}$ for $r \geq 1$ and $q \geq 0$. Again, by degenerating $-E_{i_{w_2}}$ to the same leaf (i.e., considering $r = 0$) we get a graph $\Lambda_{0,q,0}$ of Case **(B)**. \square

6.2 The case of nonfull leaves

The final case to be considered is when the graph $\Gamma \in \mathcal{S}$ has indices of Case **(C)** and it also admits nonfull leaves.

Lemma 6.6 *If Γ has a nonfull leaf then it has a reducible vector.*

Proof As usual, we use induction on $|\Gamma|$. Suppose that v is a nonfull leaf connected to v' . If v' contains $-E_{i_v}$ then v is reducible, and we are done. If v' does not contain $-E_{i_v}$, then delete v and $-E_{i_v}$ from the graph. (The term $-E_{i_v}$ was contained by w , and since $Q(v, w) = 0$, it is easy to see that $(w + E_{i_v})^2 \leq -2$, hence the resulting graph is minimal on less vertices.) Now if the resulting graph $\Gamma' \in \mathcal{S}$ admits a nonfull leaf, then induction shows that Γ' admits a reducible vector. It is obviously reducible in Γ as well, unless it is the (potential) new leaf v' , in which case (since $-E_{i_v}$ was not in v') we get that v' was reducible in Γ . In case in Γ' all leaves are full, then we argue as follows: in this case there are exactly three leaves in Γ' , and by Proposition 5.2 Γ' is full, showing that $\sum_{v_i \in \Gamma'} v_i^2 = -3|\Gamma'| - 1$. Since Γ is nonfull, we have that $\sum_{v_i \in \Gamma} v_i^2 > -3|\Gamma| - 1 = -3(|\Gamma'| + 1) - 1$, and since we have dropped v and $-E_{i_v}$ from a vertex of Γ , it means that $v^2 > -2$, contradicting the minimality of Γ . \square

Before the final argument, we need to study the case when the reducible vector is of valency three, providing the analogue of Lemma 5.6.

Lemma 6.7 *If $\Gamma \in \mathcal{S}$ is of Case (C) and it admits a reducible vector of valency three then $|\Gamma| = 4$ and Γ is isomorphic to one of the graphs of Figure 1(a) or (b).*

Proof The proof will proceed by induction on $|\Gamma|$. First, a simple case-by-case check shows that such graph does not exist if $|\Gamma| = 5$. Suppose now that $\Gamma \in \mathcal{S}$ admits a reducible vector v_1 of valency three. Let $v \in \Gamma$ be a leaf with $Q(v, v_1) = 0$. If $|\Gamma| > 5$ then such leaf exists (since v_1 is reducible), and it is necessarily nonfull. Following the usual line of reasoning, either delete v and the unique further $-E_{i_v}$ (if $-E_{i_v}$ is not in the unique vector v' connected to v) or add v to v' . In this way we get $\Gamma' \in \mathcal{S}$ on $|\Gamma| - 1$ vertices, still admitting a reducible vector of valency three, hence induction yields that Γ must be equal to 4. The rest of the statement is an easy exercise. \square

Theorem 6.8 *If Γ is of Case (C) and has a nonfull leaf then $\Gamma \in \mathcal{A} \cup \mathcal{B}$.*

Proof By Lemma 6.6 the assumption implies that there is a reducible vector $v \in \Gamma$. If $\deg v = 3$ then by Lemma 6.7 the theorem is proved. If v is of valency 1 or 2, then we can modify v to E_{i_v} , blow down E_{i_v} and add $v - E_{i_v}$ to the potential (-1) -vector of the resulting graph Γ' . We want to argue that

Γ' also admits a reducible vector. If Γ' has a nonfull leaf then this fact follows from Lemma 6.6. In case all leaves of Γ' are full, then Γ' has three leaves and Γ' is full, hence before adding $v - E_{i_v}$ it must have contained a (-1) -vector, which is automatically reducible. By induction on $|\Gamma|$ we get that $\Gamma' \in \mathcal{A} \cup \mathcal{B}$, therefore in order to prove the theorem we only need to understand how Γ can be rebuilt from the blown down graph Γ' .

Suppose that $v = E_{i_v} - \sum_{j \in J_v} E_j$ is the reducible vector in Γ , and w is the reducible vector after the blow-down. We add $-\sum_{j \in J_v} E_j$ to w , and repeat the above procedure. This procedure will terminate only when the reducible vector has valency three, in which case $n = 4$, hence the sum of the tails of the reducibles add up to one, two or three basis vectors. If it is one, then it is under Case **(B)**, since it means that that basis vector does not appear anywhere else, hence is of type (2). If it is two or three, then these come from the first reducible vector, since a single $-E_i$ cannot be disjoint from all the vectors (since all indices appear in some vector with positive multiplicity). This shows that there are two cases, when $(-\sum_{j \in J_v} E_j)^2$ is -2 or -3 , corresponding to the two cases growing from the two basic examples of Figure 10 which are of Case **(C)**. \square

In order to complete the equivalence of \mathcal{S} with the set $\mathcal{G} \cup \mathcal{W} \cup \mathcal{N} \cup \mathcal{M} \cup \mathcal{A} \cup \mathcal{B} \cup \mathcal{C}$ we also need

Proposition 6.9 *If $\Gamma \in \mathcal{W} \cup \mathcal{N} \cup \mathcal{M} \cup \mathcal{A} \cup \mathcal{B}$ then $\Gamma \in \mathcal{S}$.*

Proof The proof of $\mathcal{A} \subset \mathcal{S}$ follows the same idea as the proof of Proposition 5.7: the vectors $E_2 - E_1 - E_3, E_1, E_3 - E_1 - E_4, E_4 - E_1 - E_2$ embed Figure 10(a) into $4\langle -1 \rangle$ such that the vector $-E_2 - E_3 - E_4$ gives zero pairing with all these vectors above. After n blow-ups, the addition of $-E_2 - E_3 - E_4$ to the unique (-1) -vertex provides the embedding. The proof of the inclusion $\mathcal{B} \subset \mathcal{S}$ proceeds in the same way: notice that $E_1 - E_2 - E_3 - E_4, E_1, E_3 - E_1 - E_2 - E_4, E_4 - E_1$ gives an embedding of Figure 10(b) into $4\langle -1 \rangle$ and $-E_2 - E_3$ gives zero pairing with all the vectors listed above. Finally, for proving the inclusions $\mathcal{W} \subset \mathcal{S}$, $\mathcal{M} \subset \mathcal{S}$ and $\mathcal{N} \subset \mathcal{S}$ we give the explicit embeddings by Figures 22 through 27 of the Appendix. \square

With this final argument the proof of Theorem 1.8 is now complete.

7 Constructions of rational homology disks through Kirby calculus

In this section we prove Theorem 1.9 through embedding the plumbing 4-manifold M_Γ corresponding to certain $\Gamma \in \mathcal{S}$ into $\#_{|\Gamma|} \overline{\mathbb{C}\mathbb{P}^2}$. Then the complement of M_Γ (with the reversed orientation) will be an appropriate rational homology disk. The embedding of M_Γ into $\#_{|\Gamma|} \overline{\mathbb{C}\mathbb{P}^2}$ will be given by Kirby calculus. We start by showing that a graph $\Gamma \in \mathcal{G}_{rat}$ gives rise to a 4-manifold which embeds into the connected sum of $|\Gamma|$ copies of $\overline{\mathbb{C}\mathbb{P}^2}$. (This statement has been already proved in many places, eg. [1, 5].) The proof uses induction: For the starting case $\Gamma = (-4)$ the diagram of Figure 15 shows that by attaching a 2-handle, a 3-handle and a 4-handle to M_Γ (which in this case can be represented by the (-4) -framed unknot) we get $\overline{\mathbb{C}\mathbb{P}^2}$, hence the claim follows.

Remark 7.1 This picture is simply the manifestation of the fact that twice the generator of $H_2(\overline{\mathbb{C}\mathbb{P}^2}; \mathbb{Z})$ can be represented by a sphere of self-intersection (-4) . Another way to see this diagram is to regard the (-4) -sphere as the representative of twice the generator (with orientation reversed) and the (-1) -sphere as the representative of the generator; then by blowing up one of the two (positive) intersections repeatedly we can build any graph in \mathcal{G} and in the meantime also verify the embedding we are looking for.

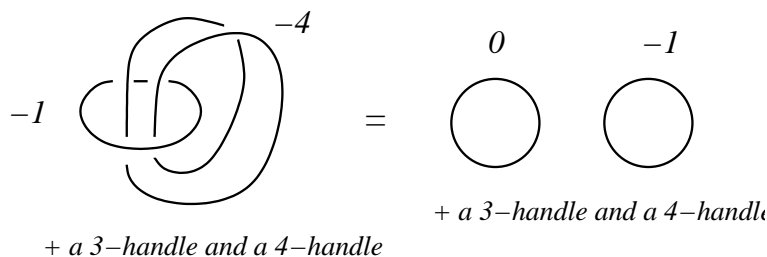

Figure 15: The embedding of (-4) into $\overline{\mathbb{C}\mathbb{P}^2}$

Now suppose that $\Gamma = (-2, -a_1, \dots, -a_n - 1)$ is constructed from $\Gamma' = (-a_1, \dots, -a_n)$ by the inductive step we used to construct \mathcal{G} (cf. Subsection 4.1). We claim that by attaching a 2-handle (symbolized by the (-1) -vertex) to M_Γ as shown by Figure 16 we get a 4-manifold which embeds into $\#_{|\Gamma|} \overline{\mathbb{C}\mathbb{P}^2}$. To see this embedding we proceed by induction again; suppose that it is true for Γ' , and use the diffeomorphism we get by blowing down the (-1) -sphere of Figure 16, cf. Figure 17.

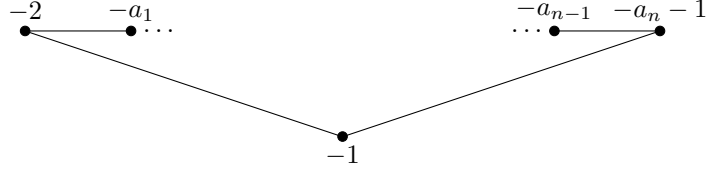

Figure 16: Attachment of a 2-handle to M_Γ

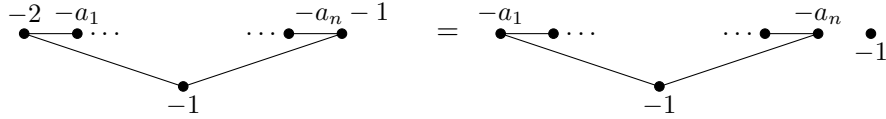

Figure 17: The inductive step

In order to show the necessary embedding for elements in $\mathcal{M} \cup \mathcal{N} \cup \mathcal{W}$, notice first that Figure 18 provides three Kirby diagrams for $\overline{\mathbb{C}\mathbb{P}^2}$: in (a) the 0-framed circles cancel the 3-handles, while (b) can be reduced to (a) by sliding one of the (-1) -circles off the others; and finally (c) differs from (b) by a simple isotopy. Now repeatedly blowing up the linkings of the three circles K_1, K_2 and K_3 ($p+1, q+1$ and $r+1$ times, respectively) we get a configuration of spheres in $(p+q+4)\overline{\mathbb{C}\mathbb{P}^2}$, cf. Figure 19. Sliding the 2-handles corresponding to the circles A_i over the central circle K we get $M_{\Gamma_{p,q,r}} \subset (p+q+r+4)\overline{\mathbb{C}\mathbb{P}^2}$, showing that $\partial M_{\Gamma_{p,q,r}}$ bounds a rational homology disk. Sliding A_1 over B_1 and A_2, A_3 over K we get the corresponding result for the 4-manifolds given by the graphs $\Delta_{p,q,r}$. Finally, sliding A_1 and A_2 over B_1, B_2 respectively, and A_3 over K we get the desired results for $\Lambda_{p,q,r}$. Notice that by not applying blow-ups at some linkings of K_1, K_2, K_3 we get the degeneration of $\Delta_{p,q,r}$ for $p=0$ and of $\Lambda_{p,q,r}$ for $p=0$ and/or $r=0$. The simple details are left to the reader. Notice that this approach provides a unified treatment of all graphs in $\mathcal{W} \cup \mathcal{N} \cup \mathcal{M}$.

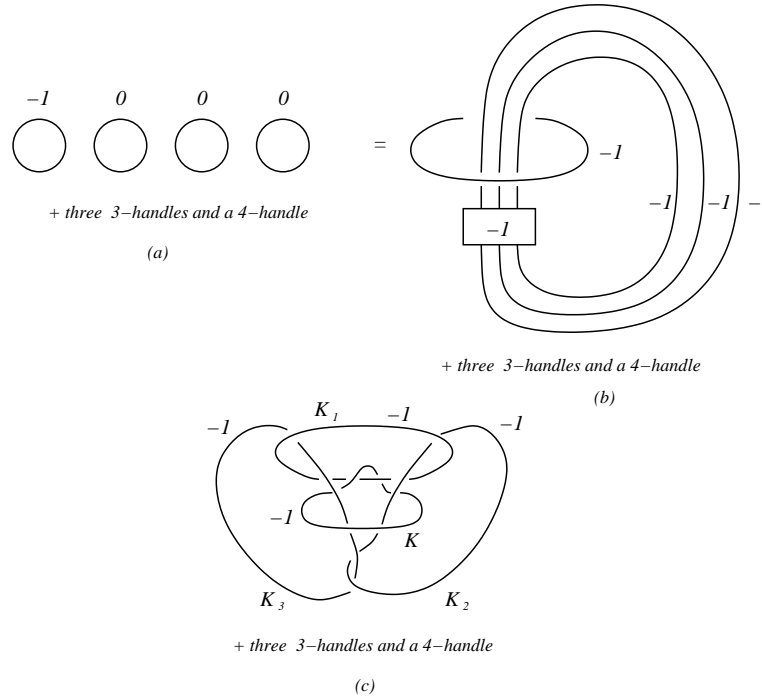

Figure 18: Surgery diagrams for $\overline{\mathbb{C}\mathbb{P}^2}$

8 Smoothings of normal surface singularities with vanishing Milnor number

Next we will show two methods for constructing smoothings of normal surface singularities which are rational homology disks. Notice that even for those cases treated in the previous section, we will get stronger results: in this section the rational homology disks are smoothings of singularities, hence are equipped with natural Stein structures; in fact, they will be affine varieties, with computable fundamental group (and sometimes explicitly given universal covering spaces). In addition, the algebro-geometric method to be presented below applies to cases which are not covered in Section 7. The constructions in this section will verify Theorem 1.10.

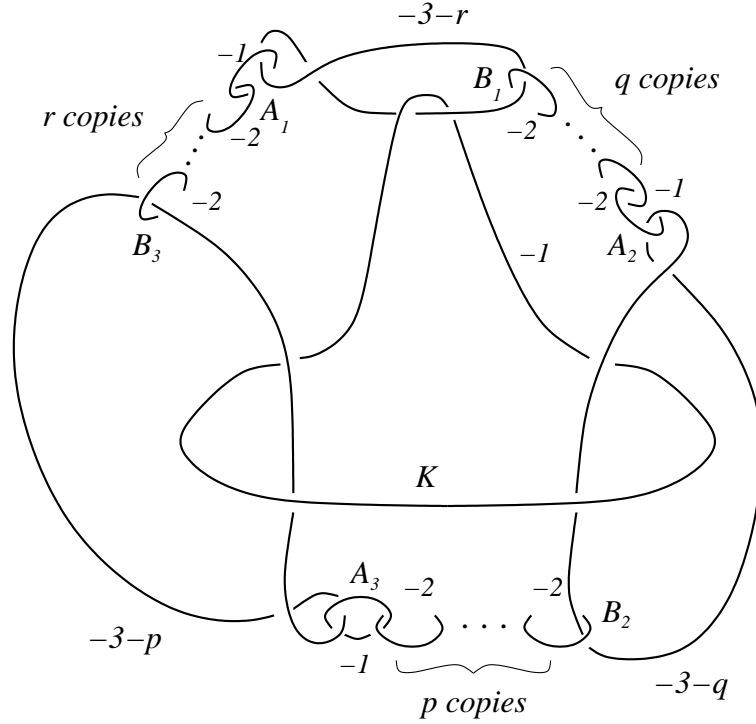

Figure 19: The diagram of Figure 18(c) after $(p + q + r + 3)$ blow-ups

8.1 Smoothings of negative weights

The first method is similar in spirit to the strategy we used in Section 7. This method, however, has the limitation of being applicable only for star-shaped graphs. Suppose therefore that Γ is a star-shaped graph and define its *dual* Γ' by reversing the sign of all the decorations on Γ and applying 'handle-calculus' along the legs to turn the positive numbers into negative again (except for the central vertex, which might have positive decoration), cf. the diagrams below. While in Section 7 we embedded the manifold M_Γ into $\#_{|\Gamma|}\overline{\mathbb{C}\mathbb{P}^2}$, this time we will find an embedding of $M_{\Gamma'}$ corresponding to the dual graph Γ' into $\mathbb{C}\mathbb{P}^2 \# (|\Gamma'| - 1)\overline{\mathbb{C}\mathbb{P}^2}$, the $(|\Gamma'| - 1)$ -fold blow-up of $\mathbb{C}\mathbb{P}^2$. As it will be discussed, a holomorphic embedding of $M_{\Gamma'}$ with the above numerical condition will provide the desired smoothing. This strategy will be applied for proving Theorem 1.10.

Suppose $X = \text{Spec}(A)$ is a weighted homogeneous normal surface singularity; thus, A is positively graded, or X has a good \mathbb{C}^* -action, or A is the quotient

of a positively graded polynomial ring by weighted homogeneous equations (see e.g. [20] for details as to what follows). Assume also that the link is a rational homology sphere. On the minimal good resolution $\tilde{Y} \rightarrow X$, the graph Γ is given by the diagram

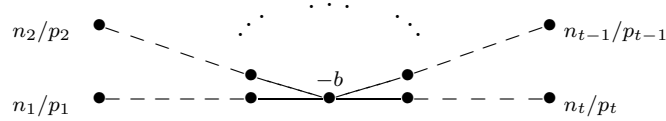

The strings of Γ are described uniquely by the continued fractions shown, starting from the node.

A natural \mathbb{C}^* -compactification of X is given by $\bar{X} = Proj A[u]$, where u has weight 1; what has been added is a curve with t cyclic quotient singularities. Resolving these singularities means one has added a “dual” curve configuration Γ' , given by

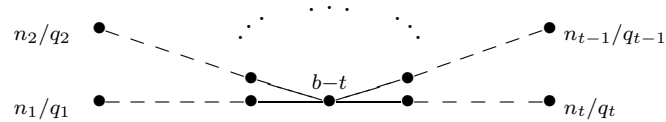

where now $q_i = n_i - p_i$. The intersection matrix of this configuration is no longer negative-definite, but has type $(1, r)$. The boundary of a tubular neighbourhood is still diffeomorphic (through an orientation reversing diffeomorphism) to the original link Σ .

A *smoothing of negative weight* of X (or of \bar{X} , or its desingularization at ∞) is a smoothing obtained by adding terms of lower weight to the defining equations, and gives rise to deformations of both compactifications which are topologically locally trivial at ∞ (see [27] for details). In particular, such a smoothing gives a smooth projective surface Z with a curve D of type Γ' , and one has that the Milnor fiber of the smoothing is diffeomorphic to $Z - D$ (e.g., [32, Theorem 2.2]). But under suitable cohomological conditions, there is a converse [27, Theorem 6.7] due to Pinkham: an appropriate pair (Z, D) gives rise to a smoothing of negative weight. We give a special case of Pinkham’s result:

Theorem 8.1 *Let Z be a smooth projective rational surface, and $D \subset Z$ a union of smooth rational curves whose intersection dual graph is of type Γ' . Assume*

$$rk H_2(D; \mathbb{Z}) = rk H_2(Z; \mathbb{Z}).$$

If Γ is the graph of a rational singularity, then one has a $\mu = 0$ smoothing of a rational weighted homogeneous singularity with resolution dual graph Γ , and the Milnor fiber is diffeomorphic to $Z - D$.

Proof By [27, Theorem 6.7] one must check the vanishing of $H^1(Z, \mathcal{O}(E^{(k)}))$ for all $k \geq 0$, where the $E^{(k)}$ are effective divisors supported on what we have called D , and $E = E^{(1)}$ is the central curve. The case $k = 0$ is just the vanishing of the first cohomology of Z . We follow Pinkham's notation and arguments closely. The key point is that the traces $D^{(k)}$ of the divisors $E^{(k)}$ on E are the familiar divisors used to write down the graded pieces of a weighted homogeneous singularity whose resolution dual graph is Γ ; the vanishing of their first cohomology on E is equivalent to the rationality of the singularity [26, Theorem 5.7]. Thus, by the exact sequences

$$0 \rightarrow \mathcal{O}(E^{(k)} - E) \rightarrow \mathcal{O}(E^{(k)}) \rightarrow \mathcal{O}_E(D^{(k)}) \rightarrow 0,$$

one needs only the vanishing of $H^1(Z, \mathcal{O}(E^{(k)} - E))$ for all $k \geq 1$. Write $F_k = E^{(k)} - E^{(k-1)} - E$, for $k \geq 1$; these are reduced but reducible effective divisors, supported on the chains of rational curves emanating from E . Via the exact sequences

$$0 \rightarrow \mathcal{O}(E^{(k-1)}) \rightarrow \mathcal{O}(E^{(k)} - E) \rightarrow \mathcal{O}_{F_k}(E^{(k)} - E) \rightarrow 0,$$

one can proceed inductively from the case $k = 1$, reducing the claimed vanishing to showing that $H^1(F_k, \mathcal{O}_{F_k}(E^{(k)} - E)) = 0$ for all $k \geq 1$. A proof is indicated in [27, Lemma 6.9]; or, one can argue directly with the resolutions of the cyclic quotient singularities whose resolution graphs contain the support of the F_k . \square

Remark 8.2 Note that the hypothesis $\text{rk } H_2(D; \mathbb{Z}) = \text{rk } H_2(Z; \mathbb{Z})$, without the assumption on the rationality of the graph Γ , gives directly that $Z - D$ is a rational homology disk whose boundary is the link associated to Γ ; one does not need anything about singularities.

We will describe pairs (Z, D) by blowing up appropriately certain curves $C \subset \mathbb{C}\mathbb{P}^2$, then taking D a subset of the total transform of C . Infinite families will come from systematically continuing the blow-up procedure.

Example 8.3 [Graphs in the family \mathcal{M}] Let $C = C_1 \cup C_2 \cup L_1 \cup L_2$ be a plane curve of degree 6, where

- (1) C_1 and C_2 are smooth conics with a triple tangency at one point

(2) L_1 is the line joining the two intersection points.

(3) L_2 is the tangent line to C_1 at the simple intersection point with C_2 .

Blowing-up appropriately 8 times yields a smooth surface Z , so that the total transform of C has the dual configuration:

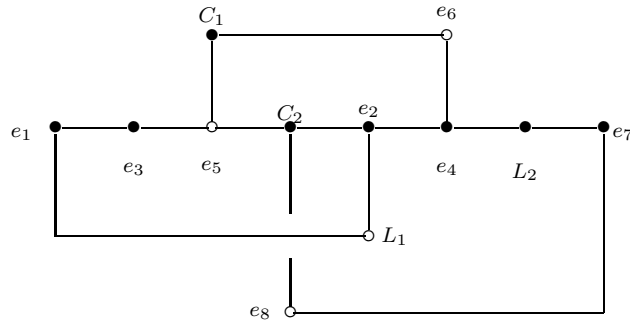

Here, solid unweighted vertices \bullet denote (-2) -curves, while circle vertices are (-1) 's. Proper transforms of the components of C are labeled as before. One recovers the blow-up procedure by blowing down sequentially first e_8 , then e_7 , etc. Let Γ' be the configuration obtained by deleting the vertices e_6, L_1 , and e_8 ; it has rank 9 ($= \text{rk } H_2(Z; \mathbb{Z})$), and is dual to the basic configuration

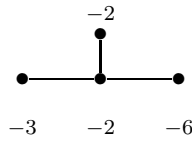

Thus, this construction gives a rational homology disk bounding the corresponding Σ . But one can repeatedly blow-up further, between e_2 and L_1 , and then between the transform of e_2 and its new neighbour. The same idea works between e_4 and e_6 (and again between the transform of e_4 and the new exceptional curves), as well as between C_2 and e_8 . Doing this respectively p, q ,

and r times, the new exceptional diagram is

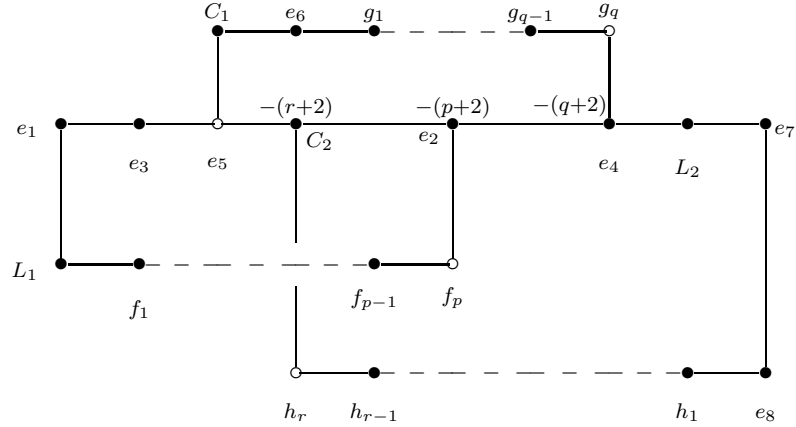

To reverse the process, blow down sequentially the f_i, g_i, h_i starting from the largest subscript (and define $f_0 = L_1, g_0 = e_6, h_0 = e_8$). The graph Γ' obtained by deleting the -1 curves f_p, g_q , and h_r is

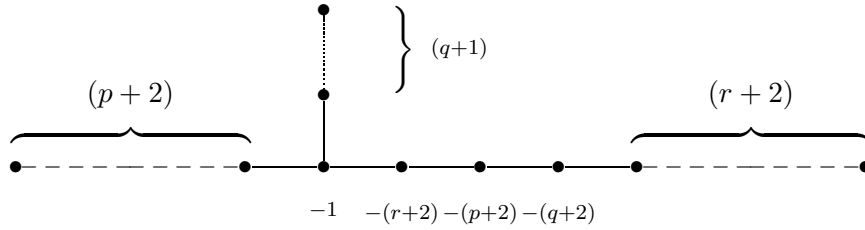

It is easy to calculate that the dual graph Γ is of type $\Lambda_{q,r,p}$. (We leave it to the reader to check the special cases when some of the p, q, r are 0.) This gives the desired boundaries for all graphs of type \mathcal{M} .

Example 8.4 [Graphs in the families \mathcal{W} and \mathcal{N}] A similar construction, starting with C the union of 4 lines L_1, L_2, L_3, L_4 in general position in $\mathbb{C}\mathbb{P}^2$, yields also rational homology ball smoothings for the triply-infinite families of type \mathcal{W} and \mathcal{N} . For the (3,3,3) type \mathcal{W} , blow-up 6 times, yielding

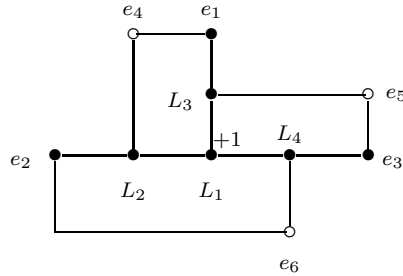

Blowing up p additional times between L_4 and e_6 and successor (-1) -curves, q times between L_3 and e_5 , and r times between L_2 and e_4 , and then removing the three (-1) -curves, gives a Γ' which is easily checked to be dual to $\Gamma_{p,q,r}$.

For the $(2,4,4)$ type \mathcal{N} , blow up 7 times, yielding

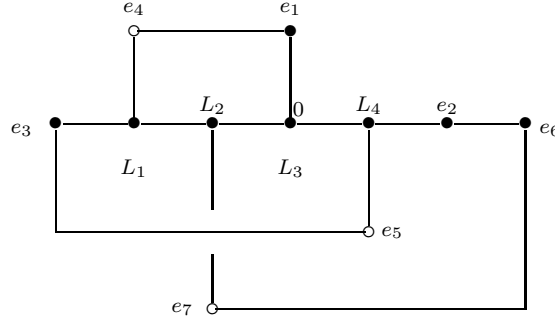

(The self-intersection of L_3 is 0.) Blowing up p additional times between L_1 and e_4 and successor (-1) -curves, q times between L_2 and e_7 , and r times between L_4 and e_5 , and then removing the three (-1) -curves, gives Γ' which is easily checked to be dual to $\Delta_{p,q,r}$.

Remark 8.5 How would one come up with such a configuration, obtainable by blowing up curves in $\mathbb{C}\mathbb{P}^2$, given a star-shaped candidate Γ ? One first forms Γ' as above. The lattice generated by the vertices is supposed to have a finite overlattice which is the second homology of a surface Z ; this must be the unimodular odd lattice with signature $(1, n - 1)$, where n is the number of curves in Γ' . In particular, generators of the overlattice are certain rational combinations of the vertices in Γ' , and the class K of a canonical divisor is also such a combination. To find suitable rational (-1) -curves on the putative Z , one looks for elements e of the overlattice for which $e \cdot e = -1, K \cdot e = -1$, and which intersect exactly two curves in Γ' (or intersects one curve twice). One might be able to use some of these to produce a configuration which blows down. This approach has succeeded in a number of cases, including all the ones in the above examples. We present two more, of type \mathcal{C} , though there are quite a few others.

Example 8.6 [A family in \mathcal{C}] We give next an infinite family of graphs in \mathcal{C} which arise from normal surface singularities which admit rational homology disk smoothings. Let $C = C_1 \cup C_2$ be a plane curve of degree 5, where C_1 is an irreducible nodal cubic, and C_2 is a smooth quadric intersecting C_1 in only

one point (hence, with intersection multiplicity 6). An affine version of such a curve is

$$(y^2 - x(1-x)^2)(y^2 - x(1-2x)) = 0.$$

Blowing up appropriately 8 times yields a smooth surface for which the total transform of C has dual configuration

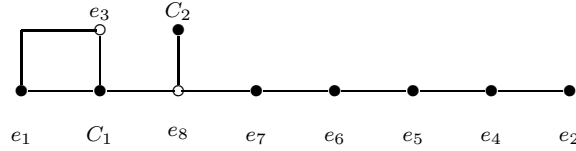

Blowing up p additional times between C_1 and e_3 and its successor (-1) 's, and then removing the last (-1) -curve, gives Γ'

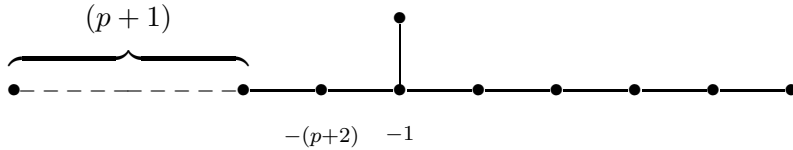

The dual graph Γ in this case is of type \mathcal{C} , and is

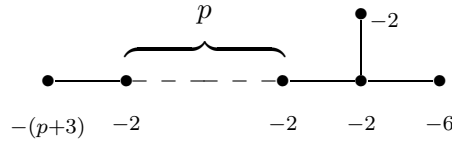

Thus, this graph corresponds to a singularity with a $\mu = 0$ smoothing.

Example 8.7 [A family in \mathcal{C} with a 4-valent node] We finish this subsection by constructing an infinite family of graphs of type \mathcal{C} with one node of valency 4, which arise from a rational homology disk smoothing of negative weight. We thank E. Shustin for assistance with this example.

We consider four conics in the plane, all contained in the real unit circle:

$$\begin{aligned} F &= \{x^2 + y^2 - 1 = 0\} \\ G &= \{x^2 + y^2 - 1 + (1/2)(x+1)(y+1) = 0\} \\ H &= \{x^2 + y^2 - 1 - (3/4)(x^2 - 1) = 0\} \\ J &= \{x^2 + y^2 - 1 - (1/2)(x-1)(y+1) = 0\}. \end{aligned}$$

Relevant intersection points are $(1, 0)$, where F, H, J are pairwise tangent; $(-1, 0)$, where F, G, H are pairwise tangent; $(0, 1/2)$, through which G, H, J pass transversally; and $(0, -1)$, where G and J have a triple tangency, and F has a simple tangency with each of them. Let L be the common tangent line $y = -1$. There are two further important points: H and J also meet transversally at $(-3/5, -2/5)$, which lies on the straight line M through $(-1, 0)$ and $(0, -1)$; and finally H and G meet transversally at $(3/5, -2/5)$, which lies on the straight line N through $(1, 0)$ and $(0, -1)$.

We now consider the (complex) plane curve which is the union of the 4 conics F, G, H, J and three lines L, M, N , and blow up minimally so that the reduced total transform has only normal crossings. We finally blow up either of the two intersection points of the line L and the conic H (which are in the imaginary complex plane). We reach the diagram of Figure 20, where the proper transforms of the seven curves in the plane are given the same name.

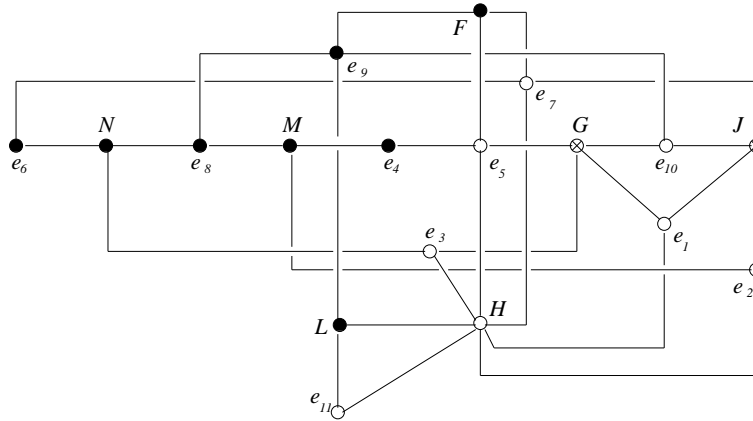

Figure 20: The configuration of curves after 11 blow-ups (solid circles represent (-2) -curves, the empty ones (-1) -curves, the ones with a cross correspond to (-3) -curves, while $H \cdot H = -4$)

Again, blowing down the curves e_i starting from the largest subscript will show how to reverse the procedure. Now, removing the vertices e_1, e_2, e_3, e_7 and e_9 from the diagram, and then blowing down the (-1) -curve e_{10} , yields the simpler diagram of Figure 21.

It is clear that removing e_{11} gives a curve configuration whose components span the second rational homology group of the blown-up plane (recall that e_{10} has been blown down, so after deleting e_{11} , the remaining eleven curves are in

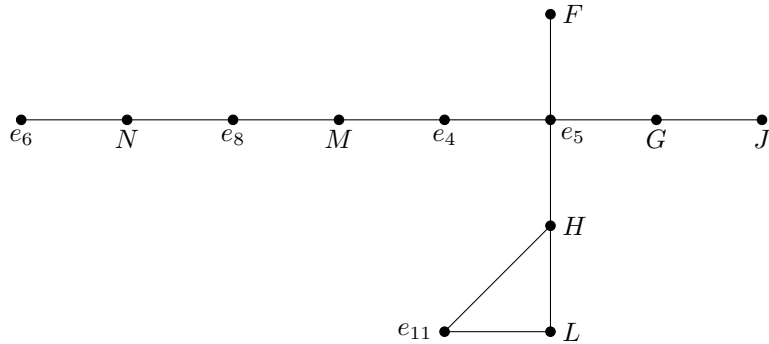
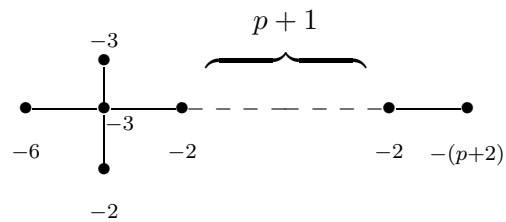

Figure 21: The configuration of Figure 20 after blow-ups (e_5 and e_{11} are (-1) -curves while H is a (-4) -curve)

$(\mathbb{CP}^2 \# 10\overline{\mathbb{CP}^2})$. Furthermore, the resulting Γ' is dual to the graph of a rational singularity, hence one can apply Theorem 8.1. Blowing up further between H and e_{11} , and then removing the exceptional curve yield rational homology disk smoothings of negative weight of singularities with resolution graph



(In the case $p = 0$ one has to blow down e_{11} and remove the curve L .)

8.2 Examples of $\mu = 0$ smoothings via quotients

Finally we show a second algebro-geometric way for constructing smoothings with $\mu = 0$. Besides discussing the (already familiar) cases we have dealt with in the previous subsection, there will be some families of singularities (with resolution graphs in $\mathcal{A} \cup \mathcal{B}$) which can be treated in this way. We will show further examples of graphs involving nodes with valency 4 giving rise to singularities with rational homology disk smoothing. Let us start by describing the general strategy first.

Suppose (\mathcal{Y}, o) is the germ of an isolated 3-dimensional normal singularity, G a finite group of automorphisms acting freely off o , and $f \in \mathcal{O}_{\mathcal{Y}, o}$ a G -invariant function whose zero locus (Y, o) has an isolated normal singularity. (This implies that \mathcal{Y} is Cohen–Macaulay.) Then f defines a smoothing of (Y, o) , with Milnor fiber M_Y ; but it also defines a smoothing of $X = Y/G$, whose Milnor fiber M_X is the quotient of the free action of G on M_Y . In particular

$$\chi(M_Y) = |G| \cdot \chi(M_X).$$

Consequently, if $|G| = \chi(M_Y) = 1 + \mu_Y$, then $\chi(M_X) = 1$ and so we have constructed a smoothing of X with Milnor number $\mu_X = 0$.

In the following, we will denote by $(1/m)[a_1, \dots, a_n]$ the transformation of \mathbb{C}^n which is multiplication of the j th coordinate by $\exp(2\pi i a_j/m)$ (where $a_j \in \mathbb{Z}$). All examples below are weighted homogeneous, simplifying calculations. It is easy to check that a given group action is free on $\mathcal{Y} - \{o\}$. Describing the resolution graph of X is achieved by lifting the action of G to the weighted blow-up of Y , then dividing and resolving the quotient, cf. [18, Section 8]. One needs to compute the Milnor number μ_Y for Y in order to show that it satisfies $1 + \mu_Y = |G|$. But, in our examples Y is a complete intersection defined by one or two weighted homogeneous equations, so one can easily apply [9, Korollar 3.10(a) or (c)].

Example 8.8 [Graphs in \mathcal{G}] Let us start with the case of the standard rational blow-down along $L(p^2, pq - 1)$ (cf. also [32, (5.9.1)]). Suppose $0 < q < p$, $(q, p) = 1$. Let $(\mathcal{Y}, o) = (\mathbb{C}^3, o)$, G the cyclic group generated by $(1/p)[1, q, -1]$, and $f = xz - y^p$. Then one gets $\mu = 0$ smoothings of X , the cyclic quotient singularity of type $p^2/(pq - 1)$, whose resolution graph is a chain as in Definition 1.3. The Milnor fiber is a free quotient of the (simply connected) Milnor fiber of the A_{p-1} -singularity $xz - y^p = 0$.

The three basic graphs of Figure 1 (Section 5), corresponding to the spherical triples $(3, 3, 3)$, $(2, 4, 4)$, $(2, 3, 6)$, are resolution graphs of certain *log-canonical* surface singularities; each is the quotient of a *simple elliptic* singularity (i.e., cone over an elliptic curve) by a cyclic group acting freely off the singular point. As mentioned in the Introduction, each gives rise to a triply-infinite family of singularities having a smoothing with Milnor number 0, and these examples fill out the classes \mathcal{W}, \mathcal{N} , and \mathcal{M} .

Example 8.9 [Graphs in \mathcal{W}] We apply the above principle to graphs of type \mathcal{W} ; the following is exactly [32, Example (5.9.2)]. Suppose $p, q, r \geq 0$, and let

$N = (p+2)(q+2)(r+2)+1$. Let $(\mathcal{Y}, o) = (\mathbb{C}^3, o)$, G the cyclic group generated by $(1/N)[1, (q+2)(r+2), -(r+2)]$, and $f = xy^{p+2} + yz^{q+2} + zx^{r+2}$. Then one gets $\mu = 0$ smoothings of rational singularities whose resolution graphs we claim are the $\Gamma_{p,q,r}$ as in Figure 3. The Milnor fiber has fundamental group G .

We indicate how to find the quotient graph Γ . Give the variables x, y, z weights a, b, c , respectively, where $a = (p+2)(q+1)+1, b = (q+2)(r+1)+1, c = (r+2)(p+1)+1$; this makes f weighted homogeneous, of weight N . Since G preserves weights, the quotient is still weighted homogeneous; and it is rational, with discriminant group of order N^2 (by Proposition 2.4). We show that the graph Γ of the quotient has three chains of rational curves, corresponding to the continued fractions (from the outside to the center) $a/(q+1), b/(r+1), c/(p+1)$. This will give $\Gamma_{p,q,r}$, except that the central self-intersection of -4 is deduced at the end from the calculation of the discriminant order.

Use the weights a, b, c to do a weighted blow-up of \mathbb{C}^3 , as in [18, Section 4]. This space is covered by three open sets. The first is the quotient of a copy of \mathbb{C}^3 , with coordinates u, v, w , modulo the cyclic action of $S = (1/a)[-1, b, c]$, and the coordinates are related by $x = u^a, y = u^b v, z = u^c w$. The proper transform of $f = 0$ is checked to be the smooth surface given by $v^{p+2} + vw^{q+2} + w = 0$. A lifting of the the generator of G to this \mathbb{C}^3 is $T = (1/aN)[1, q+1, -1]$; one divides the smooth surface by the group generated by T and S . But T^N is computed to be the inverse of S , so one only needs to divide by T . Further, $T^a = (1/N)[1, 0, 0]$ is a pseudo-reflection; so one divides out first by this transformation, replacing the variable u by $u' = u^N$. Thus, in the u', v, w space, one has the smooth surface $v^{p+2} + vw^{q+2} + w = 0$, and a cyclic group action generated by $(1/a)[1, q+1, -1]$. The only fixed point occurs at $u' = v = w = 0$; at such a point, u' and v are local analytic coordinates, and one divides out by the group $(1/a)[1, q+1]$. The image of $u' = 0$ is the central rational curve, so the continued fraction expansion of $a/(q+1)$ goes from the outer curve into the central curve. This is the cyclic quotient singularity claimed above.

Example 8.10 [Graphs in \mathcal{N}] Suppose now that $p, q, r \geq 0$, and let us define $N = (p+1)(q+3)(r+2) + q + 2$. Let $(\mathcal{Y}, o) \subset (\mathbb{C}^4, o)$ be the hypersurface singularity given by the equation $(x^{q+2} + z^{r+2} - yw = 0)$, G the cyclic group generated by $(1/N)[1, (q+3), -(p+1)(q+3), -1]$, and $f = xw - y^{p+1}z$. Then one gets $\mu = 0$ smoothings of rational singularities with resolution graph $\Delta_{p,q,r}$ as in Figures 4 and 5. The Milnor fiber has fundamental group G .

Example 8.11 Embed the plane cubic curve $A^3 + B^3 - AC^2 = 0$ into $\mathbb{C}\mathbb{P}^5$

via the Veronese embedding

$$[A, B, C] \mapsto [x_0, x_1, x_2, y_0, y_1, y_2] \equiv [A^2, B^2, C^2, BC, AC, AB],$$

and let $Y \subset \mathbb{C}^6$ be the affine cone. Let \mathcal{Y} be the total space of the one-parameter smoothing (with parameter T) of Y , given Y is defined by 9 equations, as in [25, (9.6)], and a 1-parameter smoothing (with parameter T) is given by the vanishing of the nine expressions

$$\begin{aligned} &x_0x_1 - y_2^2 + Ty_1 \\ &x_1x_2 - y_0^2 + Ty_1 \\ &x_0x_2 - y_1^2 + Ty_0 \\ &x_0y_0 - y_1y_2 + Tx_1 \\ &x_1y_1 - y_0y_2 + Tx_0 \\ &x_2y_2 - y_0y_1 + T^2 \\ &x_0^2 + x_1y_2 - y_1^2 \\ &x_1^2 + x_0y_2 - y_0y_1 \\ &x_1y_0 + x_0y_1 - x_2y_1 - Ty_2. \end{aligned}$$

(This requires some checking, but easily follows as in [25, (9.6)].) The cyclic group G of order 6, acting on the X_i, Y_j, T via $(1/6)[1, 3, 1, 2, 4, 5, 0]$, acts freely off the origin of \mathcal{Y} . T is G -invariant, and $Y \bmod G$ is the by-now-familiar singularity with resolution graph

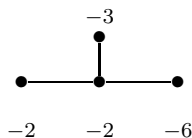

The Milnor fiber of Y is simply connected, with Euler characteristic 6; so, one has a $\mu = 0$ smoothing of X , whose Milnor fiber has fundamental group G .

Example 8.12 [A family of graphs in \mathcal{A}] Let $p \geq 0$, and for convenience write $m = 3p^2 + 9p + 7$, $r = 3p^2 + 6p + 2 = m - (3p + 5)$, $n = 9(p + 2)$ and $a = 3p + 5$. Consider the *metacyclic group* $G \subset GL(3, \mathbb{C})$, acting freely on $\mathbb{C}^3 - \{0\}$, generated by $S = (1/m)[1, r, r^2]$ and T defined by $T(x, y, z) = (y, z, \omega x)$, where $\omega = \exp(2\pi i/(a + 1))$. One easily finds that $S^m = T^n = I$, $TST^{-1} = S^r$, and T^3 is multiplication by ω . Further, $G/[G, G]$ is cyclic of order n , generated by the image of T , and $|G| = mn$. Let $\mathcal{Y} = \mathbb{C}^3$, and $f = x^a y + y^a z + \omega x z^a$. Then

f is G -invariant, and defines a hypersurface singularity Y whose Milnor fiber has Euler characteristic $1 + a^3 = mn = |G|$. Thus, one gets a $\mu = 0$ smoothing of a rational singularity whose resolution graph has valency 4:

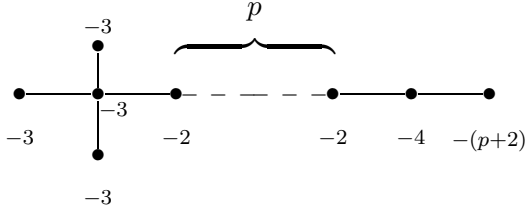

To find the resolution graph, let \bar{G} be the image of G in $PGL(3, \mathbb{C})$ (modding out by T^3), and locate the orbits in the projective plane curve defined by f on which \bar{G} acts with non-trivial isotropy. Then, resolve the hypersurface singularity via one blow-up, divide out by T^3 , and find and describe the fixed points of \bar{G} on this smooth surface. One finds three orbits on which every point has isotropy of order 3; and 3 points where the isotropy is generated by S , and the image of T puts them into one \bar{G} -orbit. Dividing out then gives all the information on the resolution, except for the weight of the central curve; this can be computed by noting that the discriminant group has order n^2 .

Since the Milnor fiber of Y is simply connected, the fundamental group of the $\mu = 0$ Milnor fiber is the non-abelian group G . (This perhaps explains why this example, originally discovered in 1983, was surprising — a Seifert manifold with 4 branches which bounds a rational homology ball.) Note that this example is of type \mathcal{A} .

Remark 8.13 There are very few “interesting” subgroups of $GL(3, \mathbb{C})$ which act freely off the origin, see [33].

Example 8.14 [A family in \mathcal{B}] Let $p \geq 2$, and for convenience write $m = 2p^2 - 2p - 1$, $r = 2(p - 1)^2$, $n = 8p$, $a = 2p - 1$. Consider the group $G \subset GL(4, \mathbb{C})$, generated by $S = (1/m)[1, r, -1, -r]$ and T defined by $T(x, y, z, w) = (\eta^4 w, x, y, z)$, where $\eta = \exp(2\pi i/4n)$. One easily finds that $S^m = T^n = I$, $T^{-1}ST = S^r$, and T^4 is multiplication by η^4 . Again, $G/[G, G]$ is cyclic of order n , generated by the image of T , and $|G| = mn$. Let $\mathcal{Y} = \{xz + \eta^2 yw = 0\} \subset \mathbb{C}^4$, on which G can be checked to act freely off the origin. Then $f = x^a y + y^a z + z^a w + \eta^{4a} w^a x$ is G -invariant, and defines a complete intersection singularity Y whose Milnor fiber has Euler characteristic

$mn = |G|$. Thus, one gets a $\mu = 0$ smoothing of a rational surface singularity. The same approach as above (first finding fixed points of some \tilde{G} on the projective curve) yields that the resolution graph of the singularity is

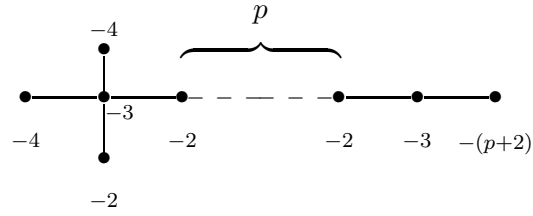

9 Appendix: Embeddings of graphs in $\mathcal{W} \cup \mathcal{M} \cup \mathcal{N}$ into diagonal lattices

In this final section we explicitly describe embeddings of the graphs in $\mathcal{W} \cup \mathcal{M} \cup \mathcal{N}$ into diagonal lattices of equal rank. Formally, these embeddings verify one direction of the equivalence in Theorem 1.8 — although this is the ‘less interesting’ direction of the theorem.

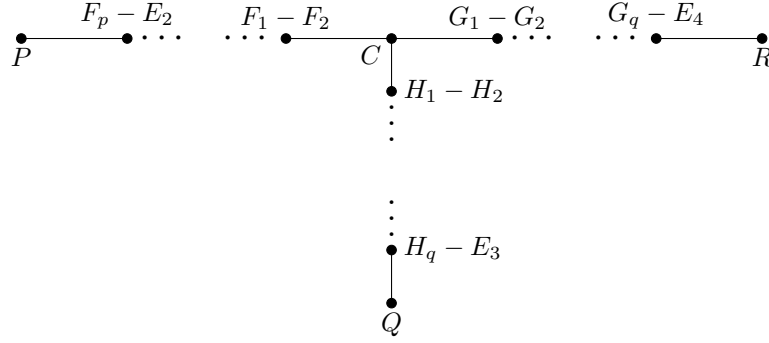

Figure 22: The embedding of the graph $\Gamma_{p,q,r} \in \mathcal{W}$ into the diagonal lattice; here $C = E_1 - F_1 - G_1 - H_1$, $P = E_2 - E_1 - E_3 - H_p - \dots - H_1$, $Q = E_3 - E_1 - E_4 - G_q - \dots - G_1$, $R = E_4 - E_1 - E_2 - F_r - \dots - F_1$ (where the basis of the diagonal lattice is given by $\{E_1, \dots, E_4, F_1, \dots, F_r, G_1, \dots, G_q, H_1, \dots, H_p\}$)

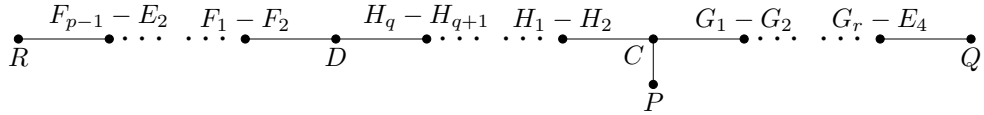

Figure 23: The embedding of the graph $\Delta_{p,q,r}$ in for $p \geq 1$ and $q, r \geq 0$; here $C = E_1 - G_1 - H_1$, $D = H_{q+1} - E_3 - F_1$, $P = E_3 - E_1 - E_2 - F_{p-1} - \dots - F_1$, $Q = E_4 - E_1 - E_3 - H_{q+1} - \dots - H_1$ and $R = E_2 - E_1 - E_4 - G_r - \dots - G_1$. The basis in the diagonal lattice is now $\{E_1, \dots, E_4, F_1, \dots, F_{p-1}, G_1, \dots, G_r, H_1, \dots, H_{q+1}\}$

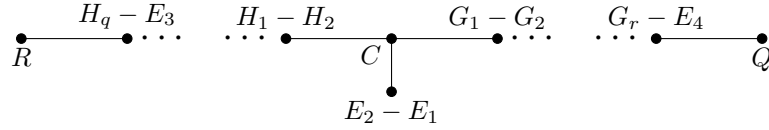

Figure 24: The embedding of the graph $\Delta_{0,q,r}$; $C = E_1 - G_1 - H_1$, $Q = E_4 - E_1 - E_2 - E_4 - H_q - \dots - H_1$, $R = E_3 - E_1 - E_2 - E_4 - G_r - \dots - G_1$ (the basis in $(q + r + 4)\langle -1 \rangle$ is now $\{E_1, \dots, E_4, G_1, \dots, G_r, H_1, \dots, H_q\}$)

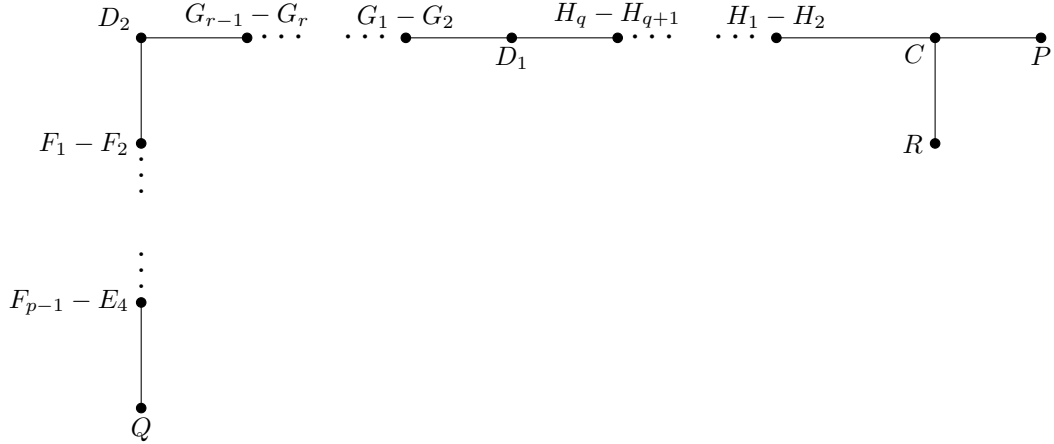

Figure 25: The embedding of the graph $\Lambda_{p,q,r}$ for $p, r \geq 1$ and $q \geq 0$; here $C = E_1 - H_1$, $D_1 = H_{q+1} - G_1 - E_3$, $D_2 = G_r - F_1 - E_2$, $P = E_2 - E_1 - E_4 - F_{p-1} - \dots - F_1$, $Q = E_4 - E_1 - E_3 - H_{q+1} - \dots - H_1$, $R = E_3 - E_1 - E_2 - G_r - \dots - G_1$

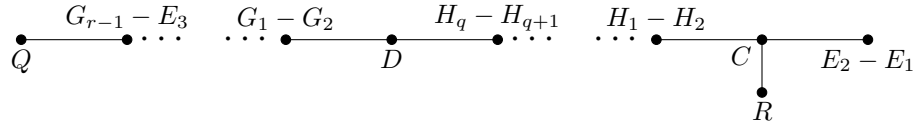

Figure 26: The embedding of the graph $\Lambda_{0,q,r}$ for $r \geq 1$ and $q \geq 0$; $C = E_1 - H_1$, $D = H_{q+1} - E_3 - G_1$, $Q = E_3 - E_1 - E_4 - E_2 - H_{q+1} - \dots - H_1$, $R = E_4 - E_1 - E_3 - E_2 - G_{r-1} - \dots - G_1$

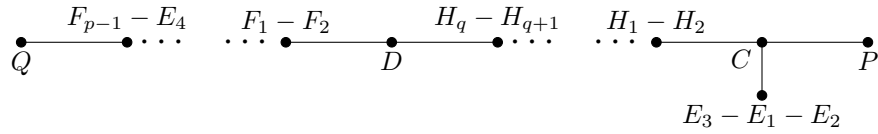

Figure 27: The embedding of the graph $\Lambda_{p,q,0}$ for $p \geq 1$ and $q \geq 0$; $C = E_1 - H_1$, $D = H_{q+1} - E_2 - E_3 - F_1$, $P = E_2 - E_1 - E_4 - F_{p-1} - \dots - F_1$, $Q = E_4 - E_1 - E_3 - H_{q+1} - \dots - H_1$

References

- [1] A. Casson and J. Harer, *Some homology lens spaces which bound rational homology balls*, Pacific J. Math. **96** (1981), 23–36.
- [2] S. Donaldson, *Irrationality and the h -cobordism conjecture*, J. Diff. Geom. **26** (1987), 141–168.
- [3] S. Donaldson, *The orientation of Yang–Mills moduli spaces and 4-manifold topology*, J. Differential Geometry **26** (1987), 397–428.
- [4] R. Fintushel and R. Stern, *Immersed spheres in 4-manifolds and the immersed Thom Conjecture*, Turkish J. Math. **19** (1995), 145–157.
- [5] R. Fintushel and R. Stern, *Rational blowdowns of smooth 4-manifolds*, J. Diff. Geom. **46** (1997), 181–235.
- [6] R. Fintushel and R. Stern, *Double node neighborhoods and families of simply connected 4-manifolds with $b_2^+ = 1$* , J. Amer. Math. Soc. **19** (2006), 171–180.
- [7] D. Gay and A. Stipsicz, *Symplectic rational blow-down along Seifert fibered 3-manifolds*, to appear in IMRN.
- [8] D. Gay and A. Stipsicz, *Symplectic surgeries and normal surface singularities*, in preparation.
- [9] G.–M. Greuel and H. Hamm, *Invarianten quasihomogener vollständiger Durchschnitte*, Invent. Math. **49** (1978), 67–86.
- [10] F. Hirzebruch, W. Neumann, and S. Koh, *Differentiable Manifolds and Quadratic Forms*, Lecture Notes in Pure and Applied Math. **4**, Marcel Dekker, New York, 1971.
- [11] J. Kollár, *Is there a topological Bogomolov–Miyaoka–Yau inequality?* arXiv:math.AG/0602562.
- [12] H. Laufer, *Taut two-dimensional singularities*, Math. Ann. **205** (1973), 131–164.
- [13] H. Laufer, *On minimally elliptic singularities*, Amer. J. Math. **99** (1977), 1257–1295.
- [14] Y. Lee and J. Park, *Simply connected surfaces of general type with $p_g = 0$ and $K^2 = 2$* , arXiv:math.AG/0609072.
- [15] E. Looijenga and J. Wahl, *Quadratic functions and smoothing surface singularities*, Topology **25** (1986), 261–291.
- [16] A. Némethi, *On the Ozsváth–Szabó invariant of negative definite plumbed 3-manifolds*, Geom. Topol. **9** (2005), 991–1042.
- [17] W. Neumann and F. Raymond, *Seifert manifolds, plumbing, μ -invariant and orientation reversing maps*, Alg. and Geom. Topology, Proc. Santa Barbara 1977, Lecture Notes in Math. **664** (Springer, Berlin, 1978), 163–196.
- [18] W. Neumann and J. Wahl, *Complete intersection singularities of splice type as universal abelian covers*, Geom. Topol. **9** (2005), 699–755.

- [19] P. Orlik and P. Wagreich, *Algebraic surfaces with k^* -action*, Acta Math. **138** (1977), 43–81.
- [20] P. Orlik and P. Wagreich, *Isolated singularities of algebraic surfaces with \mathbb{C}^* action*, Ann. of Math. **93** (1971), 205–228.
- [21] P. Ozsváth and Z. Szabó, *Absolutely graded Floer homologies and intersection forms for four-manifolds with boundary*, Adv. Math. **173** (2003), 179–261.
- [22] J. Park, *Seiberg–Witten invariants of generalized rational blow-downs*, Bull. Austral. Math. Soc. **56** (1997), 363–384.
- [23] J. Park, *Simply connected symplectic 4-manifolds with $b_2^+ = 1$ and $c_1^2 = 2$* , Invent. Math. **159** (2005), 657–667.
- [24] J. Park, A. Stipsicz and Z. Szabó, *Exotic smooth structures on $\mathbb{C}P^2 \# 5\overline{\mathbb{C}P^2}$* , Math. Res. Lett. **12** (2005), 701–712.
- [25] H. Pinkham, *Deformations of algebraic varieties with \mathbb{G}_m action*, Astérisque **20** (1974), 1–131.
- [26] H. Pinkham, *Normal surface singularities with \mathbb{C}^* action*, Math. Ann. **227** (1977), 183–193.
- [27] H. Pinkham, *Deformations of normal surface singularities with \mathbb{C}^* -action*, Math. Ann. **232** (1978), 65–84.
- [28] A. Stipsicz and Z. Szabó, *An exotic smooth structure on $\mathbb{C}P^2 \# 6\overline{\mathbb{C}P^2}$* , Geom. Topol. **9** (2005), 813–832.
- [29] M. Symington, *Symplectic rational blowdowns*, J. Diff. Geom. **50** (1998), 505–518.
- [30] M. Symington, *Generalized symplectic rational blowdowns*, Algebr. Geom. Topol. **1** (2001), 503–518.
- [31] J. Wahl, *Elliptic deformations of minimally elliptic singularities*, Math. Ann. **253** (1980), 241–262.
- [32] J. Wahl, *Smoothings of normal surface singularities*, Topology **20** (1981), 219–246.
- [33] J. Wolf, *Spaces of constant curvature*, McGraw-Hill, New York-London-Sydney (1967).