

# DAVID MAPS AND HAUSDORFF DIMENSION

SAEED ZAKERI

ABSTRACT. David maps are generalizations of classical planar quasiconformal maps for which the dilatation is allowed to tend to infinity in a controlled fashion. In this note we examine how these maps distort Hausdorff dimension. We show

- Given  $\alpha$  and  $\beta$  in  $[0, 2]$ , there exists a David map  $\varphi : \mathbb{C} \rightarrow \mathbb{C}$  and a compact set  $\Lambda$  such that  $\dim_{\mathbb{H}} \Lambda = \alpha$  and  $\dim_{\mathbb{H}} \varphi(\Lambda) = \beta$ .
- There exists a David map  $\varphi : \mathbb{C} \rightarrow \mathbb{C}$  such that the Jordan curve  $\Gamma = \varphi(\mathbb{S}^1)$  satisfies  $\dim_{\mathbb{H}} \Gamma = 2$ .

One should contrast the first statement with the fact that quasiconformal maps preserve sets of Hausdorff dimension 0 and 2. The second statement provides an example of a Jordan curve with Hausdorff dimension 2 which is (quasi)conformally removable.

## 1. INTRODUCTION

An orientation-preserving homeomorphism  $\varphi : U \rightarrow V$  between planar domains is called *quasiconformal* if it belongs to the Sobolev class  $W_{\text{loc}}^{1,1}(U)$  (i.e., has locally integrable distributional partial derivatives in  $U$ ) and its complex dilatation  $\mu_{\varphi} := \bar{\partial}\varphi/\partial\varphi$  satisfies

$$\|\mu_{\varphi}\|_{\infty} < 1.$$

In terms of the real dilatation defined by

$$K_{\varphi} := \frac{1 + |\mu_{\varphi}|}{1 - |\mu_{\varphi}|} = \frac{|\partial\varphi| + |\bar{\partial}\varphi|}{|\partial\varphi| - |\bar{\partial}\varphi|},$$

the latter condition can be expressed as

$$\|K_{\varphi}\|_{\infty} < +\infty.$$

The quantity  $\|K_{\varphi}\|_{\infty}$  is called the *maximal dilatation* of  $\varphi$ . We say that  $\varphi$  is  $K$ -quasiconformal if its maximal dilatation does not exceed  $K$ .

For later comparison with the properties of David maps defined below, we recall some basic properties of quasiconformal maps (see [A] or [LV]):

- If  $\varphi$  is  $K$ -quasiconformal for some  $K \geq 1$ , so is the inverse map  $\varphi^{-1}$ .
- A  $K$ -quasiconformal map  $\varphi : U \rightarrow V$  is locally Hölder continuous of exponent  $1/K$ . In other words, for every compact set  $E \subset U$  and every  $z, w \in E$ ,

$$|\varphi(z) - \varphi(w)| \leq C |z - w|^{\frac{1}{K}}$$

where  $C > 0$  only depends on  $E$  and  $K$ .

---

Date: November 19, 2002.

- A quasiconformal map  $\varphi : U \rightarrow V$  is absolutely continuous; in fact, the Jacobian  $J_\varphi = |\partial\varphi|^2 - |\bar{\partial}\varphi|^2$  is locally integrable in  $U$  and

$$(1.1) \quad \text{area } \varphi(E) = \int_E J_\varphi \, dx \, dy,$$

for every measurable  $E \subset U$ .

- More precisely, the Jacobian  $J_\varphi$  of a quasiconformal map  $\varphi : U \rightarrow V$  is in  $L^p_{\text{loc}}(U)$  for some  $p > 1$ . If we define

$$(1.2) \quad p(K) := \sup\{p : J_\varphi \in L^p_{\text{loc}}(U) \text{ for every } K\text{-quasiconformal map } \varphi \text{ in } U\},$$

then  $p(K)$  is independent of the domain  $U$  and

$$(1.3) \quad p(K) = \frac{K}{K-1}.$$

This was conjectured by Gehring and Väisälä in 1971 [**GV**] and was proved by Astala in 1994 [**As**].

- Let  $\{\varphi_n\}$  be a sequence of  $K$ -quasiconformal maps in a planar domain  $U$  which fix two given points of  $U$ . Then  $\{\varphi_n\}$  has a subsequence which converges locally uniformly to a  $K$ -quasiconformal map in  $U$ .

The measurable Riemann mapping theorem of Morrey-Ahlfors-Bers [**AB**] asserts that any measurable function  $\mu$  in a domain  $U$  which satisfies  $\|\mu\|_\infty < 1$  is the complex dilatation of some quasiconformal map  $\varphi$  in  $U$ , which means  $\varphi$  satisfies the *Beltrami equation*  $\bar{\partial}\varphi = \mu \cdot \partial\varphi$  almost everywhere in  $U$ . Recent progress in conformal geometry and holomorphic dynamics has made it abundantly clear that one must also study this equation in the case  $\|\mu\|_\infty = 1$ . With some restrictions on the asymptotic growth of  $|\mu|$ , the solvability of the Beltrami equation can still be guaranteed. One such condition is given by David in [**D**]. Let  $\sigma$  denote the spherical area in  $\widehat{\mathbb{C}}$  and  $\mu$  be a measurable function in  $U$  which satisfies

$$(1.4) \quad \sigma\{z \in U : |\mu(z)| > 1 - \varepsilon\} \leq C \exp\left(-\frac{\alpha}{\varepsilon}\right) \quad \text{for all } \varepsilon < \varepsilon_0$$

for some positive constants  $C, \alpha, \varepsilon_0$ . Then David showed that the Beltrami equation  $\bar{\partial}\varphi = \mu \cdot \partial\varphi$  has a homeomorphic solution  $\varphi \in W_{\text{loc}}^{1,1}(U)$  which is unique up to postcomposition with a conformal map. Motivated by this result, we call a homeomorphism  $\varphi : U \rightarrow V$  a *David map* if  $\varphi \in W_{\text{loc}}^{1,1}(U)$  and the complex dilatation  $\mu_\varphi$  satisfies a condition of the form (1.4). Equivalently,  $\varphi$  is a David map if there are positive constants  $C, \alpha, K_0$  such that its real dilatation satisfies

$$(1.5) \quad \sigma\{z \in U : K_\varphi(z) > K\} \leq C e^{-\alpha K} \quad \text{for all } K > K_0.$$

To emphasize the values of these constants, sometimes we say that  $\varphi$  is a  $(C, \alpha, K_0)$ -David map. Note that when  $U$  is a bounded domain in  $\mathbb{C}$ , the spherical metric in (1.4) or (1.5) can be replaced with the Euclidean area.

David maps enjoy some of the useful properties of quasiconformal maps, but the two classes differ in many respects. As indications of their similarity, let us mention the following two facts:

- Every David map is absolutely continuous; the Jacobian formula (1.1) still holds.

- *Tukia's Theorem [T]*. “Let  $C, \alpha, K_0$  be positive and suppose  $\{\varphi_n\}$  is a sequence of  $(C, \alpha, K_0)$ -David maps in a domain  $U$  which fix two given points of  $U$ . Then  $\{\varphi_n\}$  has a subsequence which converges locally uniformly to a David map in  $U$ .” It is rather easy to show that some subsequence of  $\{\varphi_n\}$  converges locally uniformly to a homeomorphism, but that this homeomorphism must be David is quite non-trivial. We remark that the parameters of the limit map may a priori be different from  $C, \alpha, K_0$ .

Here are further properties of David maps which indicate their difference with quasiconformal maps:

- The inverse of a David map may not be David.
- A David map may not be locally Hölder.
- The Jacobian of a David map may not be in  $L^p_{\text{loc}}(U)$  for any  $p > 1$ .

As an example, the homeomorphism  $\varphi : \mathbb{D}(0, e^{-1}) \rightarrow \mathbb{D}$  defined by

$$\varphi(re^{i\theta}) := -\frac{1}{\log r} e^{i\theta}$$

is a David map but  $\varphi^{-1}$  is not. Moreover,  $\varphi$  is not Hölder in any neighborhood of 0, and  $J_\varphi \notin L^p_{\text{loc}}$  for  $p > 1$ .

The main goal of this note is to show how David maps differ from quasiconformal maps in the way they change Hausdorff dimension of sets. Recall that the *Hausdorff  $s$ -measure* of  $E \subset \mathbb{C}$  is defined by

$$H^s(E) := \liminf_{\varepsilon \rightarrow 0} \sum_i (\text{diam } U_i)^s,$$

where the infimum is taken over all countable covers  $\mathcal{U} = \{U_i\}$  of  $E$  by sets of Euclidean diameter at most  $\varepsilon$ . The *Hausdorff dimension* of  $E$  is defined by

$$\dim_{\text{H}} E := \inf\{s : H^s(E) = 0\}.$$

Quasiconformal maps can change Hausdorff dimension of sets only by a bounded factor depending on their maximal dilatation. This was first proved by Gehring and Väisälä [GV] who showed that if  $\varphi : U \rightarrow V$  is  $K$ -quasiconformal,  $E \subset U$ ,  $\dim_{\text{H}} E = \alpha$  and  $\dim_{\text{H}} \varphi(E) = \beta$ , then

$$\frac{2(p(K) - 1)\alpha}{2p(K) - \alpha} \leq \beta \leq \frac{2p(K)\alpha}{2(p(K) - 1) + \alpha}.$$

Here  $p(K) > 1$  is the constant defined in (1.2). By Astala's result (1.3), one obtains

$$\frac{2\alpha}{2K - (K - 1)\alpha} \leq \beta \leq \frac{2K\alpha}{2 + (K - 1)\alpha}$$

which can be put in the symmetric form

$$(1.6) \quad \frac{1}{K} \left( \frac{1}{\alpha} - \frac{1}{2} \right) \leq \frac{1}{\beta} - \frac{1}{2} \leq K \left( \frac{1}{\alpha} - \frac{1}{2} \right).$$

It follows in particular that quasiconformal maps preserve sets of Hausdorff dimension 0 and 2.

By contrast, we prove

**Theorem A.** *Given any two numbers  $\alpha$  and  $\beta$  in  $[0, 2]$ , there exists a David map  $\varphi : \mathbb{C} \rightarrow \mathbb{C}$*

and a compact set  $\Lambda \subset \mathbb{C}$  such that  $\dim_{\text{H}} \Lambda = \alpha$  and  $\dim_{\text{H}} \varphi(\Lambda) = \beta$ .

The proof shows that the parameters of  $\varphi$  can be taken independent of  $\alpha$  and  $\beta$ .

In the special case of a  $K$ -quasicircle, i.e., the image  $\Gamma$  of the round circle under a  $K$ -quasiconformal map, the estimate (1.6) gives

$$1 \leq \dim_{\text{H}} \Gamma \leq \frac{2K}{K+1}$$

(the lower bound comes from topological considerations). It is well-known that  $\dim_{\text{H}} \Gamma$  can in fact take all values in  $[1, 2)$ . We show that the upper bound 2 is attained by a David image of the round circle. Let us call a Jordan curve  $\Gamma \subset \mathbb{C}$  a *David circle* if there exists a David map  $\varphi : \mathbb{C} \rightarrow \mathbb{C}$  such that  $\Gamma = \varphi(\mathbb{S}^1)$ , where  $\mathbb{S}^1$  is the unit circle  $\{z \in \mathbb{C} : |z| = 1\}$ .

**Theorem B.** *There exist David circles of Hausdorff dimension 2.*

One corollary of this result is that there are Jordan curves of Hausdorff dimension 2 that are (quasi)conformally removable (see §4).

Both results are bad (or exciting?) news for applications in holomorphic dynamics, where one often wants to estimate the Hausdorff dimension of invariant sets by computing the dimension in a conjugate dynamical system. The dichotomy of having dimension  $< 2$  or  $= 2$  for such invariant sets, which is respected by quasiconformal conjugacies, is no longer preserved by David conjugacies. For example, by performing quasiconformal surgery on a Blaschke product, Petersen proved that the Julia set of the quadratic polynomial  $Q_\theta : z \mapsto e^{2\pi i \theta} z + z^2$  is locally-connected and has measure zero whenever  $\theta$  is an irrational of bounded type [P]. In this case, the boundary of the Siegel disk of  $Q_\theta$  is a quasicircle whose Hausdorff dimension is strictly between 1 and 2 (compare [GJ]). On the other hand, by performing a *trans-quasiconformal* surgery and using David's theorem, Petersen and the author extended the above result to almost every  $\theta$  [PZ]. It follows that there exists a full-measure set of rotation numbers  $\theta$  for which the boundary of the Siegel disk of  $Q_\theta$  is a David circle but not a quasicircle. Thus, Theorem B opens the possibility that this boundary alone might have dimension 2, which would be a rather curious phenomenon.

## 2. PRELIMINARY CONSTRUCTIONS

For two positive numbers  $a$  and  $b$ , we write

$$a \preccurlyeq b$$

if there is a universal constant  $C > 0$  such that  $a \leq Cb$ . We write

$$a \asymp b$$

if  $a \preccurlyeq b$  and  $b \preccurlyeq a$ , i.e., if there is a universal constant  $C > 0$  such that  $C^{-1}b \leq a \leq Cb$ . In this case, we say that  $a$  and  $b$  are *comparable*.

**A family of Cantor sets.** Given a strictly decreasing sequence  $\mathbf{d} = \{d_n\}_{n \geq 0}$  of positive numbers with  $d_0 = 1$ , we construct a Cantor set  $\Lambda(\mathbf{d})$  as the intersection of a nested sequence  $\{\Lambda_n\}_{n \geq 0}$  of compact sets in the unit square  $\Lambda_0 := [-\frac{1}{2}, \frac{1}{2}] \times [-\frac{1}{2}, \frac{1}{2}]$  defined inductively as follows. Set  $a_1 := 2^{-2}(d_0 - d_1)$  and define  $\Lambda_1$  as the disjoint union of the four closed squares of side-length  $2^{-1}d_1$  in  $\Lambda_0$  which have distance  $a_1$  to the boundary of  $\Lambda_0$  (see Fig. 1). Suppose

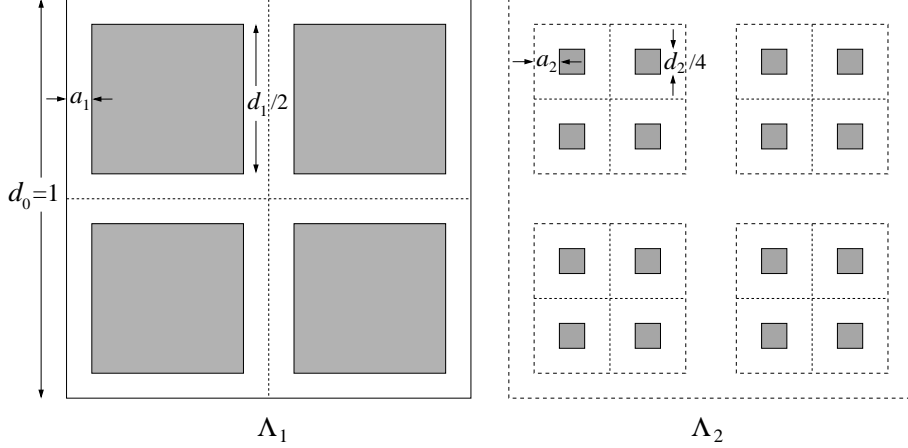
 FIGURE 1. First two steps in the construction of  $\Lambda(\mathbf{d})$ .

$\Lambda_{n-1}$  is constructed for some  $n \geq 2$  so that it is the disjoint union of  $4^{n-1}$  closed squares of side-length  $2^{-(n-1)}d_{n-1}$ . Define

$$(2.1) \quad a_n := 2^{-(n+1)}(d_{n-1} - d_n).$$

For any square  $S$  in  $\Lambda_{n-1}$ , consider the disjoint union of the four closed squares in  $S$  of side-length  $2^{-n}d_n$  which have distance  $a_n$  to the boundary of  $S$ . The union of all these squares for all such  $S$  will then be called  $\Lambda_n$ . Clearly  $\Lambda_n$  is the disjoint union of  $4^n$  closed squares of side-length  $2^{-n}d_n$ , and the inductive definition is complete.

The Cantor set  $\Lambda(\mathbf{d})$  is defined as  $\bigcap_{n \geq 0} \Lambda_n$ . We have

$$\text{area } \Lambda(\mathbf{d}) = \lim_{n \rightarrow \infty} \text{area } \Lambda_n = \lim_{n \rightarrow \infty} d_n^2.$$

**Lemma 2.1.** *The Hausdorff dimension of the Cantor set  $\Lambda = \Lambda(\mathbf{d})$  satisfies*

$$(2.2) \quad 2 - \limsup_{n \rightarrow \infty} \frac{-2 \log d_{n+1}}{-\log d_n + n \log 2} \leq \dim_{\text{H}} \Lambda \leq 2 - \liminf_{n \rightarrow \infty} \frac{-2 \log d_n}{-\log d_n + n \log 2}.$$

*Proof.* For each  $n \geq 0$ , there are  $4^n$  squares of diameter  $2^{\frac{1}{2}-n}d_n$  covering  $\Lambda$ . Hence the Hausdorff  $s$ -measure of  $\Lambda$  is bounded above by

$$\liminf_{n \rightarrow \infty} 4^n (2^{\frac{1}{2}-n}d_n)^s = 2^{\frac{s}{2}} \liminf_{n \rightarrow \infty} 2^{n(2-s)} d_n^s,$$

which is zero if  $s > 2 - \liminf_{n \rightarrow \infty} (-2 \log d_n) / (-\log d_n + n \log 2)$ . This proves the upper bound in (2.2).

The lower bound follows from a standard mass distribution argument: Construct a probability measure  $\mu$  on  $\Lambda$  which gives equal mass  $4^{-n}$  to each square in  $\Lambda_n$ , so that

$$\mu(S) = \frac{\text{area}(S)}{d_n^2} \quad \text{if } S \text{ is a square in } \Lambda_n.$$

Let  $x \in \Lambda$  and  $\varepsilon > 0$ , and choose  $n$  so that  $2^{-n}d_n < \varepsilon \leq 2^{-(n-1)}d_{n-1}$ . The disk  $\mathbb{D}(x, \varepsilon)$  intersects at most  $\pi \varepsilon^2 / (4^{-n}d_n^2)$  squares in  $\Lambda_n$  each having  $\mu$ -mass of  $4^{-n}$ . It follows that

$$\mu(\mathbb{D}(x, \varepsilon)) \leq \frac{\varepsilon^2}{d_n^2} = \varepsilon^s \frac{\varepsilon^{2-s}}{d_n^2} \leq \varepsilon^s \frac{2^{-n(2-s)} d_{n-1}^{2-s}}{d_n^2}.$$

If  $s < 2 - \limsup_{n \rightarrow \infty} (-2 \log d_{n+1}) / (-\log d_n + n \log 2)$ , the term  $2^{-n(2-s)} d_{n-1}^{2-s} / d_n^2$  will tend to zero as  $n \rightarrow \infty$ , so that

$$\mu(\mathbb{D}(x, \varepsilon)) \asymp \varepsilon^s.$$

It follows from Frostman's Lemma (see for example [M]) that  $\dim_{\mathbb{H}} \Lambda \geq s$ . This gives the lower bound in (2.2).  $\square$

**Standard homeomorphisms between Cantor sets.** We construct standard homeomorphisms with controlled dilatation between Cantor sets of the form  $\Lambda(\mathbf{d})$  defined above. The construction will depend on the following lemma:

**Lemma 2.2.** *Fix  $0 < a \leq b < \frac{1}{2}$ . Let  $A_a$  be the closed annulus bounded by the squares*

$$\left\{ (x, y) \in \mathbb{R}^2 : \max\{|x|, |y|\} = \frac{1}{2} \right\} \quad \text{and} \quad \left\{ (x, y) \in \mathbb{R}^2 : \max\{|x|, |y|\} = \frac{1}{2} - a \right\},$$

and similarly define  $A_b$ . Let  $\varphi : \partial A_a \rightarrow \partial A_b$  be a homeomorphism which is the identity on the outer boundary component and acts affinely on the inner boundary component, mapping  $\frac{1}{2} - a$  to  $\frac{1}{2} - b$ . Then  $\varphi$  can be extended to a  $K$ -quasiconformal homeomorphism  $A_a \rightarrow A_b$ , with

$$(2.3) \quad K \asymp \frac{b(1-2a)}{a(1-2b)}.$$

*Proof.* Let us first make a simple observation: If  $z$  and  $w$  are points in the upper half-plane and  $L : \mathbb{R}^2 \rightarrow \mathbb{R}^2$  is the affine map such that  $L(0) = 0$ ,  $L(1) = 1$  and  $L(z) = w$  (see Fig. 2), then the real dilatation of  $L$  is given by

$$(2.4) \quad K_L = \frac{|z - \bar{w}| + |z - w|}{|z - \bar{w}| - |z - w|}.$$

To prove the lemma, take the triangulations of  $A_a$  and  $A_b$  shown in Fig. 2 and extend  $\varphi$  affinely to each triangle. After appropriate rescaling, it follows from (2.4) that on a triangle of type I in the figure, the dilatation of  $\varphi$  is comparable to  $b/a$ , while on a triangle of type II, the dilatation of  $\varphi$  is comparable to  $b(1-2a)/(a(1-2b))$ . Since  $b(1-2a)/(a(1-2b)) \geq b/a$ , we obtain (2.3).  $\square$

Now take a decreasing sequence  $\mathbf{d} = \{d_n\}$  of positive numbers with  $d_0 = 1$ , let  $\{a_n\}$  be defined as in (2.1), and consider the Cantor set  $\Lambda(\mathbf{d}) = \bigcap \Lambda_n$ . Take another such sequence  $\mathbf{d}' = \{d'_n\}$  and let  $a'_n, \Lambda'_n, \Lambda(\mathbf{d}')$  denote the corresponding data. We construct a homeomorphism  $\varphi : \mathbb{C} \rightarrow \mathbb{C}$  which maps the Cantor set  $\Lambda = \Lambda(\mathbf{d})$  to  $\Lambda' = \Lambda(\mathbf{d}')$ . This  $\varphi$  is the uniform limit of a sequence of quasiconformal maps  $\varphi_n : \mathbb{C} \rightarrow \mathbb{C}$  with  $\varphi_n(\Lambda_n) = \Lambda'_n$ , defined inductively as follows. Let  $\varphi_0$  be the identity map on  $\mathbb{C}$ . Suppose  $\varphi_{n-1}$  is constructed for some  $n \geq 1$  and that it maps each square in  $\Lambda_{n-1}$  affinely to the corresponding square in  $\Lambda'_{n-1}$ . Define  $\varphi_n = \varphi_{n-1}$  on  $\mathbb{C} \setminus \Lambda_{n-1}$  and let  $\varphi_n$  map each square in  $\Lambda_n$  affinely to the corresponding square in  $\Lambda'_n$ . The remaining set  $\Lambda_{n-1} \setminus \Lambda_n$  is the union of  $4^n$  annuli on the boundary of which  $\varphi_n$  can be defined affinely. By rescaling each annulus in  $\Lambda_{n-1} \setminus \Lambda_n$  and the corresponding annulus in  $\Lambda'_{n-1} \setminus \Lambda'_n$ , we are in the situation of Lemma 2.2, so we can extend  $\varphi_n$  in a piecewise affine fashion to each such annulus. This defines  $\varphi_n$  everywhere, and the inductive definition is complete.

To estimate the maximal dilatation of  $\varphi_n$ , note that by the above construction  $\varphi_n$  is conformal in  $\Lambda_n$  and has the same dilatation as  $\varphi_{n-1}$  on  $\mathbb{C} \setminus \Lambda_{n-1}$ . On each of the  $4^n$  annuli

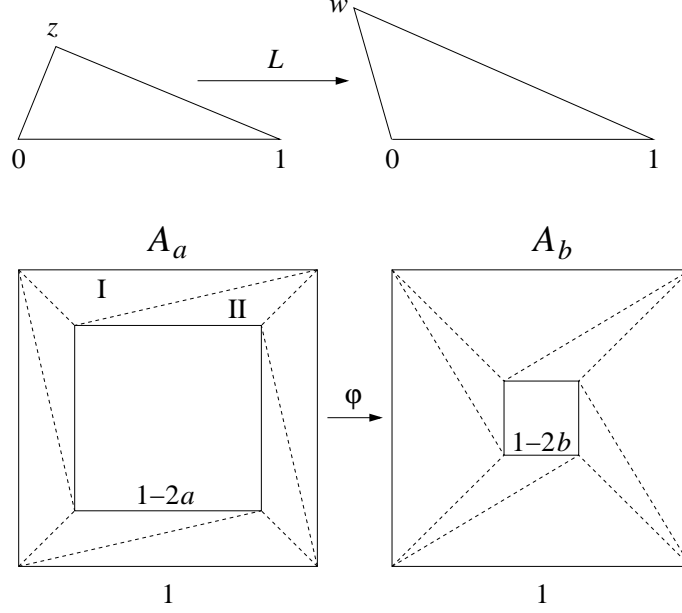

FIGURE 2.

in  $\Lambda_{n-1} \setminus \Lambda_n$ , the dilatation of  $\varphi_n$  can be estimated using (2.3) in Lemma 2.2. In fact, rescaling each such annulus by a factor  $2^n/d_{n-1}$  and the corresponding annulus in  $\Lambda'_{n-1} \setminus \Lambda'_n$  by a factor  $2^n/d'_{n-1}$ , it follows from (2.3) that the dilatation of  $\varphi_n$  on each such annulus is comparable to

$$\begin{aligned} & \max \left\{ \frac{\frac{a'_n}{2^{-n}d'_{n-1}}(1 - 2\frac{a_n}{2^{-n}d_{n-1}})}{\frac{a_n}{2^{-n}d_{n-1}}(1 - 2\frac{a'_n}{2^{-n}d'_{n-1}})}, \frac{\frac{a_n}{2^{-n}d_{n-1}}(1 - 2\frac{a'_n}{2^{-n}d'_{n-1}})}{\frac{a'_n}{2^{-n}d'_{n-1}}(1 - 2\frac{a_n}{2^{-n}d_{n-1}})} \right\} \\ &= \max \left\{ \frac{a'_n(d_{n-1} - 2^{n+1}a_n)}{a_n(d'_{n-1} - 2^{n+1}a'_n)}, \frac{a_n(d'_{n-1} - 2^{n+1}a'_n)}{a'_n(d_{n-1} - 2^{n+1}a_n)} \right\} \\ &= \max \left\{ \frac{a'_n d_n}{a_n d'_n}, \frac{a_n d'_n}{a'_n d_n} \right\}. \end{aligned}$$

To sum up, the construction gives a sequence  $\{\varphi_n\}$  with the following properties:

- (i)  $\varphi_n = \varphi_{n-1}$  on  $\mathbb{C} \setminus \Lambda_{n-1}$ .
- (ii)  $\varphi_n$  maps each square in  $\Lambda_n$  affinely to the corresponding square in  $\Lambda'_n$ .
- (iii)  $\varphi_n$  is  $K_n$ -quasiconformal, where

$$(2.5) \quad K_n \asymp \max \left\{ K_{n-1}, \frac{a'_n d_n}{a_n d'_n}, \frac{a_n d'_n}{a'_n d_n} \right\}$$

and  $K_0 = 1$ .

Evidently,  $\varphi := \lim_{n \rightarrow \infty} \varphi_n$  is a homeomorphism which agrees with  $\varphi_n$  on  $\mathbb{C} \setminus \Lambda_n$  for every  $n$  and satisfies  $\varphi(\Lambda) = \Lambda'$ . We call this  $\varphi$  the *standard homeomorphism from  $\Lambda$  to  $\Lambda'$* . Observe that by the construction, the inverse map  $\varphi^{-1}$  is the standard homeomorphism from  $\Lambda'$  to  $\Lambda$ .

## 3. PROOF OF THEOREM A

We are now ready to prove Theorem A cited in §1.

*Proof of Theorem A.* If  $0 < \alpha, \beta < 2$ , it is well-known that there is a  $K$ -quasiconformal map  $\varphi : \mathbb{C} \rightarrow \mathbb{C}$  mapping a set of dimension  $\alpha$  to a set of dimension  $\beta$  (see for example [GV]). Moreover, by (1.6), the minimum  $K$  this would require is

$$\max \left\{ \frac{\frac{1}{\beta} - \frac{1}{2}}{\frac{1}{\alpha} - \frac{1}{2}}, \frac{\frac{1}{\alpha} - \frac{1}{2}}{\frac{1}{\beta} - \frac{1}{2}} \right\}.$$

In what follows we consider the remaining cases where  $\alpha$  and  $\beta$  are distinct and at least one of them is 0 or 2.

Consider the sequences  $\mathbf{d} = \{d_n\}$ ,  $\mathbf{d}' = \{d'_n\}$  and  $\mathbf{d}'' = \{d''_n\}$  defined by

$$d_n := 2^{-\frac{n}{\log n}}, \quad d'_n := 2^{-\nu n}, \quad d''_n := 2^{-n \log n},$$

where  $\nu > 0$ , and construct the Cantor sets  $\Lambda = \Lambda(\mathbf{d})$ ,  $\Lambda' = \Lambda(\mathbf{d}')$  and  $\Lambda'' = \Lambda(\mathbf{d}'')$  as in §2. By Lemma 2.1,

$$\dim_{\text{H}}(\Lambda) = 2, \quad \dim_{\text{H}}(\Lambda') = \frac{2}{\nu + 1}, \quad \dim_{\text{H}}(\Lambda'') = 0.$$

We prove that the standard homeomorphisms between these three Cantor sets *and* their inverses are all David maps; this will prove the theorem. In view of Tukia's Theorem quoted in §1, it suffices to check that the sequence of approximating homeomorphisms are David maps with uniform parameters  $(C, \alpha, K_0)$ . In fact, the estimates below show that we can always take  $C = \alpha = 1$ .

• *Case 1. Mapping  $\Lambda$  to  $\Lambda'$ .* Suppose  $\{\varphi_n\}$  is the sequence of quasiconformal maps which approximates the standard homeomorphism  $\varphi$  from  $\Lambda$  to  $\Lambda'$ . To estimate the dilatation of  $\varphi_n$ , note that

$$(3.1) \quad a_n = 2^{-(n+1)}(d_{n-1} - d_n) \asymp 2^{-n}(2^{-\frac{n-1}{\log(n-1)}} - 2^{-\frac{n}{\log n}}) \asymp \frac{2^{-n - \frac{n}{\log n}}}{\log n}$$

and

$$(3.2) \quad a'_n = 2^{-(n+1)}(d'_{n-1} - d'_n) \asymp 2^{-n}(2^{-\nu(n-1)} - 2^{-\nu n}) \asymp 2^{-(\nu+1)n}.$$

Hence

$$\frac{a'_n d_n}{a_n d'_n} \asymp \frac{2^{-(\nu+1)n} \cdot 2^{-\frac{n}{\log n}}}{\frac{2^{-n - \frac{n}{\log n}}}{\log n} \cdot 2^{-\nu n}} \asymp \log n.$$

It follows from (2.5) that there is a sequence  $1 < K_1 < K_2 < \dots < K_n < \dots$  with  $K_n \asymp \log n$  such that  $\varphi_n$  is  $K_n$ -quasiconformal. Fix the index  $n$  and a number  $K > 1$ . Choose  $j$  so that  $K_j \leq K < K_{j+1}$ . Then

$$\begin{aligned} \text{area}\{z : K_{\varphi_n}(z) > K\} &\leq \text{area}\{z : K_{\varphi_n}(z) > K_j\} \\ &\leq \text{area}(\Lambda_j) = d_j^2 = 4^{-\frac{j}{\log j}}. \end{aligned}$$

Since  $K \asymp K_j \asymp \log j$ , we obtain

$$\text{area}\{z : K_{\varphi_n}(z) > K\} \leq e^{-K},$$



provided that  $K$  is bigger than some  $K_0$  independent of  $n$ . It follows that the  $\varphi_n$  are all  $(1, 1, K_0)$ -David maps.

The inverse maps  $\psi_n := \varphi_n^{-1}$  are also  $K_n$ -quasiconformal with the same dilatation  $K_n \asymp \log n$  and they converge uniformly to  $\psi := \varphi^{-1}$ . Moreover, if  $K_j \leq K < K_{j+1}$ , then

$$\begin{aligned} \text{area}\{z : K_{\psi_n}(z) > K\} &\leq \text{area}\{z : K_{\psi_n}(z) > K_j\} \\ &\leq \text{area}(\Lambda'_j) = (d'_j)^2 = 4^{-\nu j} \\ &\leq e^{-K}, \end{aligned}$$

provided that  $K$  is bigger than some  $K_0$  independent of  $n$ . It follows that the  $\psi_n$  are all  $(1, 1, K_0)$ -David maps.

• *Case 2. Mapping  $\Lambda'$  to  $\Lambda''$ .* The argument here is quite similar to the previous case. We have

$$(3.3) \quad a''_n = 2^{-(n+1)}(d''_{n-1} - d''_n) \asymp 2^{-n}(2^{-(n-1)\log(n-1)} - 2^{-n\log n}) \asymp 2^{-n-n\log n+\log n}$$

Hence, using (3.2) and (3.3), we obtain

$$\frac{a''_n d'_n}{a'_n d''_n} \asymp \frac{2^{-n-n\log n+\log n} \cdot 2^{-\nu n}}{2^{-(\nu+1)n} \cdot 2^{-n\log n}} \asymp 2^{\log n}.$$

Let  $\{\varphi_n\}$  be the sequence of quasiconformal maps which approximates the standard homeomorphism  $\varphi$  from  $\Lambda'$  to  $\Lambda''$ . It follows from (2.5) that there is a sequence  $1 < K_1 < K_2 < \dots < K_n < \dots$  with  $K_n \asymp 2^{\log n}$  such that  $\varphi_n$  is  $K_n$ -quasiconformal. Fix the index  $n$  and a number  $K > 1$ , and choose  $j$  so that  $K_j \leq K < K_{j+1}$ . Then  $K \asymp K_j \asymp 2^{\log j}$  and

$$\begin{aligned} \text{area}\{z : K_{\varphi_n}(z) > K\} &\leq \text{area}\{z : K_{\varphi_n}(z) > K_j\} \\ &\leq \text{area}(\Lambda'_j) = (d'_j)^2 = 4^{-\nu j} \\ &\leq e^{-K}, \end{aligned}$$

provided that  $K$  is bigger than some  $K_0$  independent of  $n$ .

The inverse maps  $\psi_n := \varphi_n^{-1}$  are  $K_n$ -quasiconformal with  $K_n \asymp 2^{\log n}$  and they converge uniformly to  $\psi := \varphi^{-1}$ . Moreover, if  $K_j \leq K < K_{j+1}$ , then

$$\begin{aligned} \text{area}\{z : K_{\psi_n}(z) > K\} &\leq \text{area}\{z : K_{\psi_n}(z) > K_j\} \\ &\leq \text{area}(\Lambda''_j) = (d''_j)^2 = 4^{-j\log j} \\ &\leq e^{-K}, \end{aligned}$$

provided that  $K$  is bigger than some  $K_0$  independent of  $n$ .

• *Case 3. Mapping  $\Lambda$  to  $\Lambda''$ .* Using (3.1) and (3.3), we obtain

$$\frac{a''_n d_n}{a_n d''_n} \asymp \frac{2^{-n-n\log n+\log n} \cdot 2^{-\frac{n}{\log n}}}{\frac{2^{-n-\frac{n}{\log n}}}{\log n} \cdot 2^{-n\log n}} \asymp 2^{\log n} \log n = n^{\log 2} \log n.$$

Let  $\{\varphi_n\}$  be the sequence of quasiconformal maps which approximates the standard homeomorphism  $\varphi$  from  $\Lambda$  to  $\Lambda''$ . It follows then from (2.5) that there is a sequence  $1 < K_1 <$

$K_2 < \dots < K_n < \dots$  with  $K_n \asymp n^{\log 2} \log n$  such that  $\varphi_n$  is  $K_n$ -quasiconformal. Fix  $n$ , let  $K$  be sufficiently large, and choose  $j$  so that  $K_j \leq K < K_{j+1}$ . Then

$$\begin{aligned} \text{area}\{z : K_{\varphi_n}(z) > K\} &\leq \text{area}\{z : K_{\varphi_n}(z) > K_j\} \\ &\leq \text{area}(\Lambda_j) = (d_j)^2 = 4^{-\frac{j}{\log j}}. \end{aligned}$$

But  $K \asymp K_j \asymp j^{\log 2} \log j$ , so

$$\text{area}\{z : K_{\varphi_n}(z) > K\} \leq e^{-K},$$

provided that  $K$  is bigger than some  $K_0$  independent of  $n$ .

The inverse maps  $\psi_n := \varphi_n^{-1}$  are  $K_n$ -quasiconformal with  $K_n \asymp n^{\log 2} \log n$  and they converge uniformly to  $\psi := \varphi^{-1}$ . Moreover, if  $K_j \leq K < K_{j+1}$ , then

$$\begin{aligned} \text{area}\{z : K_{\psi_n}(z) > K\} &\leq \text{area}\{z : K_{\psi_n}(z) > K_j\} \\ &\leq \text{area}(\Lambda''_j) = (d''_j)^2 = 4^{-j \log j} \\ &\leq e^{-K}, \end{aligned}$$

provided that  $K$  is bigger than some  $K_0$  independent of  $n$ . □

#### 4. PROOF OF THEOREM B

The idea of the proof of Theorem B is to construct a David map  $\varphi : \mathbb{C} \rightarrow \mathbb{C}$  which sends a *linear* Cantor set  $\Sigma \subset [-\frac{1}{2}, \frac{1}{2}]$  to a Cantor set of the form  $\Lambda(\mathbf{d})$  with dimension 2. The image  $\varphi([-\frac{1}{2}, \frac{1}{2}])$  will then be an embedded arc of dimension 2. Since the construction allows  $\varphi = \text{id}$  outside the square  $[-\frac{1}{2}, \frac{1}{2}] \times [-\frac{1}{2}, \frac{1}{2}]$ , we can easily complete this arc to a David circle.

**A linear Cantor set.** Consider the closed unit square  $\Sigma_0 := [-\frac{1}{2}, \frac{1}{2}] \times [-\frac{1}{2}, \frac{1}{2}]$  in the plane. We construct a nested sequence  $\{\Sigma_n\}_{n \geq 0}$  of compact sets whose intersection is a linear Cantor set. For  $1 \leq j \leq 4$ , let  $f_j : \mathbb{C} \rightarrow \mathbb{C}$  be the affine contraction defined by

$$f_j(z) = \frac{1}{8}z + \frac{2j-5}{8},$$

and set

$$\Sigma_n := \bigcup_{j_1, \dots, j_n} f_{j_1} \circ \dots \circ f_{j_n}(\Sigma_0),$$

where the union is taken over all unordered  $n$ -tuples  $j_1, \dots, j_n$  chosen from  $\{1, 2, 3, 4\}$ . It is easy to see that  $\Sigma_n$  is the disjoint union of  $4^n$  closed squares of side-length  $8^{-n}$  with centers on  $[-\frac{1}{2}, \frac{1}{2}]$  and sides parallel to the coordinate axes (compare Fig. 5 left). We define the Cantor set  $\Sigma$  as the intersection  $\bigcap_{n=0}^{\infty} \Sigma_n$ . Evidently,  $\Sigma$  is a subset of  $[-\frac{1}{2}, \frac{1}{2}]$  which has linear measure zero and Hausdorff dimension  $2/3$ .

**A quasiconformal twist.** The proof of Theorem B depends on the following lemma which is a triply-connected version of Lemma 2.2. For simplicity we denote by  $S(p, r)$  the open square centered at  $p$  whose side-length is  $r$ .

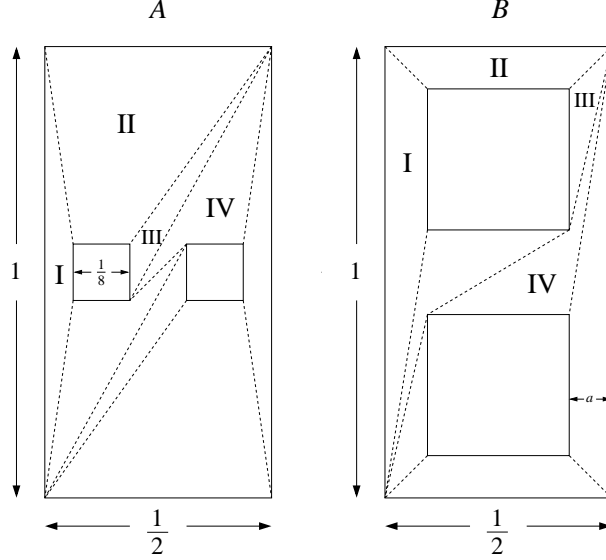
 FIGURE 3. Cell decompositions of  $A$  and  $B$ .

**Lemma 4.1.** Fix  $0 < a < 1/5$  and let  $A$  and  $B$  be the closed triply-connected sets defined by

$$A := \left( \left[ 0, \frac{1}{2} \right] \times \left[ -\frac{1}{2}, \frac{1}{2} \right] \right) \setminus \left( S \left( \frac{1}{8}, \frac{1}{8} \right) \cup S \left( \frac{3}{8}, \frac{1}{8} \right) \right)$$

$$B := \left( \left[ 0, \frac{1}{2} \right] \times \left[ -\frac{1}{2}, \frac{1}{2} \right] \right) \setminus \left( S \left( \frac{1+i}{4}, \frac{1}{2} - 2a \right) \cup S \left( \frac{1-i}{4}, \frac{1}{2} - 2a \right) \right)$$

(see Fig. 3). Let  $\varphi : \partial A \rightarrow \partial B$  be a homeomorphism which is the identity on the outer boundary component and acts affinely on the inner boundary components, mapping  $\partial S(\frac{1}{8}, \frac{1}{8})$  to  $\partial S(\frac{1+i}{4}, \frac{1}{2} - 2a)$  and  $\partial S(\frac{3}{8}, \frac{1}{8})$  to  $\partial S(\frac{1-i}{4}, \frac{1}{2} - 2a)$ , respecting the horizontal and vertical sides. Then  $\varphi$  can be extended to a  $K$ -quasiconformal map  $\varphi : A \rightarrow B$ , with

$$K \asymp \frac{1}{a}.$$

*Proof.* We consider the affine cell decompositions of  $A$  and  $B$  shown in Fig. 3 and require  $\varphi$  to map each cell in  $A$  to its corresponding cell in  $B$  in a piecewise affine fashion. By symmetry, it suffices to define  $\varphi$  piecewise affinely between the cells labeled I, II, III, and IV. We let  $\varphi$  be affine between the triangular cells III. On the cells I and II we subdivide the trapezoids into two triangular cells and define  $\varphi$  to be affine on each of them. An easy computation based on (2.4) then shows that the dilatation of  $\varphi$  on I, II, and III is comparable to  $1/a$ .

It remains to define  $\varphi$  between the cells IV and estimate its dilatation. Note that the cell IV in  $A$  has bounded geometry, so there is a  $K_1 \asymp 1$  and a piecewise affine  $K_1$ -quasiconformal map  $f_1$  from this cell to the square with vertices  $0, 1, (1+i)/2, (1-i)/2$  which maps the horizontal edge of this cell to the segment from  $(1-i)/2$  to  $1$  (see Fig. 4). The cell IV in  $B$ , after a conformal change of coordinates  $T$ , becomes the 4-gon with vertices

$$0, 1, z := -\frac{1-2a}{4a} + \frac{i}{2}, z' := 1 - \frac{(1-4a)i}{4a}.$$

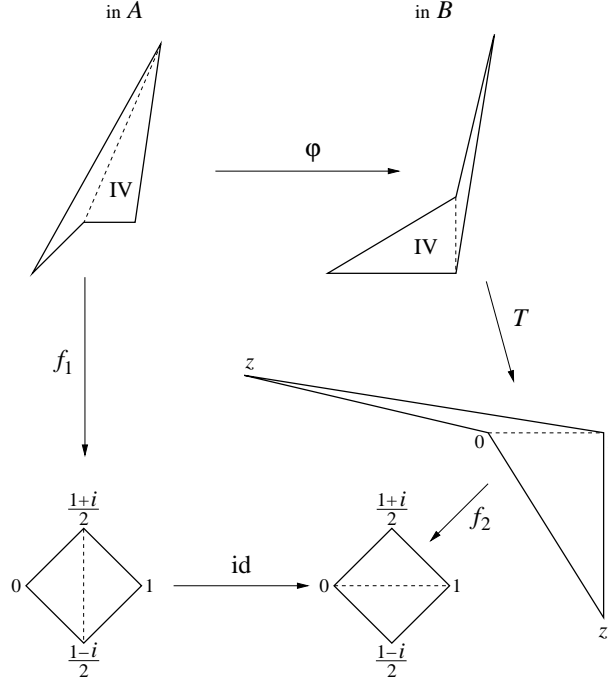
FIGURE 4. Extending  $\varphi$  between cells of type IV.

Let  $f_2$  be the piecewise affine map on this 4-gon which maps the triangle  $\Delta(0, 1, z)$  to  $\Delta(0, 1, (1+i)/2)$  and the triangle  $\Delta(0, 1, z')$  to  $\Delta(0, 1, (1-i)/2)$  (see Fig. 4). Then a brief calculation based on (2.4) shows that  $f_2$  is  $K_2$ -quasiconformal, with  $K_2 \asymp 1/a$ . The map  $\varphi$  can then be defined by  $T^{-1} \circ f_2^{-1} \circ f_1$ , whose dilatation  $K_1 K_2$  is clearly comparable to  $1/a$ .  $\square$

We are now ready to prove Theorem B cited in §1.

*Proof of Theorem B.* Consider the Cantor set  $\Sigma = \bigcap_{n=0}^{\infty} \Sigma_n$  constructed above and the Cantor set  $\Lambda = \Lambda(\mathbf{d}) = \bigcap_{n=0}^{\infty} \Lambda_n$  constructed in §2, where  $\mathbf{d} = \{d_n\}$  is defined by  $d_n := 2^{-\sqrt{n}}$ . It follows from Lemma 2.1 that  $\dim_{\text{H}}(\Lambda) = 2$ .

We construct a David map  $\varphi : \mathbb{C} \rightarrow \mathbb{C}$ , identity outside the square  $[-\frac{1}{2}, \frac{1}{2}] \times [-\frac{1}{2}, \frac{1}{2}]$ , with the property  $\varphi(\Sigma) = \Lambda$ . Then the embedded arc  $\varphi([-\frac{1}{2}, \frac{1}{2}])$  contains  $\Lambda$  and hence has dimension 2. By pre-composing  $\varphi$  with an appropriate quasiconformal map, we obtain a David map sending the round circle to a Jordan curve of dimension 2.

The map  $\varphi$  will be the uniform limit of a sequence of quasiconformal maps  $\varphi_n : \mathbb{C} \rightarrow \mathbb{C}$  with  $\varphi_n(\Sigma_n) = \Lambda_n$ , defined inductively as follows. Let  $\varphi_0$  be the identity map on  $\mathbb{C}$ . To define  $\varphi_1$ , set  $\varphi_1 = \varphi_0$  on  $\mathbb{C} \setminus \Sigma_0$  and map each of the four squares in  $\Sigma_1$  affinely to the “corresponding” square in  $\Lambda_1$ . Here “corresponding” means that the squares in  $\Sigma_0$ , from left to right, map respectively to the north west, south west, north east and south east squares in  $\Lambda_1$  (compare Fig. 5). The remaining set  $\Sigma_0 \setminus \Sigma_1$  is the union of two triply-connected regions, on the boundary of which  $\varphi_1$  can be defined affinely, so we can extend  $\varphi_1$  to each such region as in Lemma 4.1.

In general, suppose  $\varphi_{n-1}$  is constructed for some  $n \geq 2$  and that it maps each square in  $\Sigma_{n-1}$  affinely to a square in  $\Lambda_{n-1}$ . Define  $\varphi_n = \varphi_{n-1}$  on  $\mathbb{C} \setminus \Sigma_{n-1}$  and let  $\varphi_n$  map each

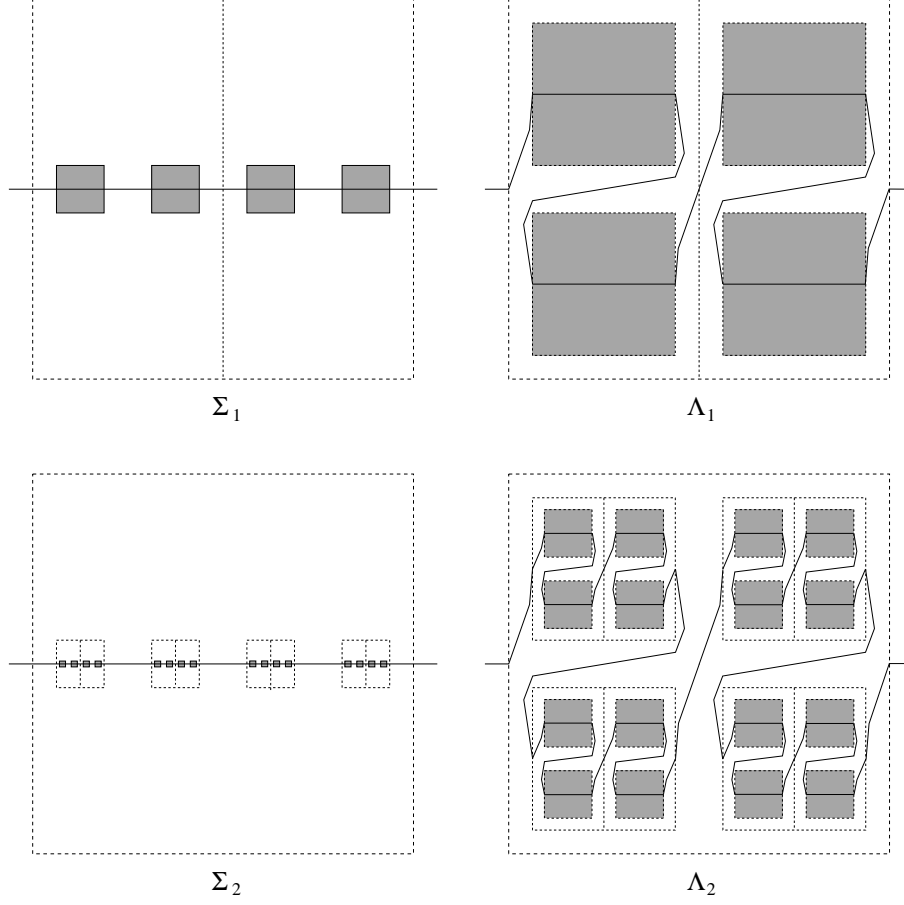

FIGURE 5. First two steps in the construction of the map  $\varphi$ . The solid arcs on the right are  $\varphi_n(\mathbb{R})$  for  $n = 1, 2$ .

square in  $\Sigma_n$  affinely to the “corresponding” square in  $\Lambda_n$  in the above sense. The remaining set  $\Sigma_{n-1} \setminus \Sigma_n$  is the union of  $2^{2n-1}$  triply-connected regions on the boundary of which  $\varphi_n$  can be defined affinely. By rescaling each such region in  $\Sigma_{n-1} \setminus \Sigma_n$  by a factor  $8^{n-1}$  and the corresponding region in  $\Lambda_{n-1} \setminus \Lambda_n$  by a factor  $2^{n-1}/d_{n-1}$ , we are in the situation of Lemma 4.1, so we can extend  $\varphi_n$  in a piecewise affine fashion as in that lemma, and the dilatation of the resulting extension will be comparable to

$$\begin{aligned} \frac{d_{n-1}}{2^{n-1}a_n} &= \frac{d_{n-1}}{2^{n-1} \cdot 2^{-(n+1)}(d_{n-1} - d_n)} \\ &= \frac{2^{-\sqrt{n-1}}}{2^{n-1} \cdot 2^{-(n+1)}(2^{-\sqrt{n-1}} - 2^{-\sqrt{n}})} \\ &\asymp \sqrt{n}. \end{aligned}$$

The sequence  $\{\varphi_n\}$  obtained this way has the following properties:

- (i)  $\varphi_n = \varphi_{n-1}$  on  $\mathbb{C} \setminus \Sigma_{n-1}$ .
- (ii)  $\varphi_n$  maps each square in  $\Sigma_n$  affinely to the corresponding square in  $\Lambda_n$ .
- (iii)  $\varphi_n$  is  $K_n$ -quasiconformal, with  $K_n \asymp \sqrt{n}$ .

Evidently,  $\varphi := \lim_{n \rightarrow \infty} \varphi_n$  is a homeomorphism which agrees with  $\varphi_n$  on  $\mathbb{C} \setminus \Sigma_n$  for every  $n$  and satisfies  $\varphi(\Sigma) = \Lambda$ .

To check that  $\varphi$  is a David map, choose a sequence  $1 < K_1 < K_2 < \dots < K_n < \dots$  with  $K_n \asymp \sqrt{n}$  such that  $\varphi_n$  is  $K_n$ -quasiconformal. Fix some  $n$ , let  $K > 1$ , and choose  $j$  such that  $K_j \leq K < K_{j+1}$ . Then

$$\begin{aligned} \text{area}\{z : K_{\varphi_n}(z) > K\} &\leq \text{area}\{z : K_{\varphi_n}(z) > K_j\} \\ &\leq \text{area}(\Sigma_j) = 2^{-4j}. \end{aligned}$$

Since  $K \asymp K_j \asymp \sqrt{j}$ , we have

$$\text{area}\{z : K_{\varphi_n}(z) > K\} \leq e^{-K},$$

provided that  $K$  is bigger than some  $K_0$  independent of  $n$ . It follows that the  $\varphi_n$  are all  $(1, 1, K_0)$ -David maps. By Tukia's Theorem in §1, we conclude that  $\varphi = \lim_{n \rightarrow \infty} \varphi_n$  is a David map.  $\square$

**Removability of David circles.** A compact set  $\Gamma \subset \mathbb{C}$  is called *(quasi)conformally removable* if every homeomorphism  $\varphi : \mathbb{C} \rightarrow \mathbb{C}$  which is (quasi)conformal off  $\Gamma$  is (quasi)conformal in  $\mathbb{C}$ . It is well-known that conformal and quasiconformal removability are identical notions.

Every set of  $\sigma$ -finite 1-dimensional Hausdorff measure, such as a rectifiable curve, is removable. Quasiarcs and quasicircles provide examples of removable sets which can have any dimension in the interval  $[1, 2)$ . One can even construct removable sets of dimension 2: the Cartesian product of two linear Cantor sets with zero length and dimension 1 is such a set.

At the other extreme, sets of positive area are never removable, as can be seen by an easy application of the measurable Riemann mapping theorem. Also, there exist non-removable sets of Hausdorff dimension 1 (see for example [K]).

To add an item to the above list of examples, we show that David circles are removable, which, combined with Theorem B, proves that *there exist removable Jordan curves of Hausdorff dimension 2*. First we need the following simple lemma on David maps (compare [PZ]) whose analogue in the quasiconformal case is standard.

**Lemma 4.2.** *Suppose  $\varphi : \mathbb{C} \rightarrow \mathbb{C}$  is a homeomorphism whose restrictions to  $\mathbb{D}$  and  $\mathbb{C} \setminus \overline{\mathbb{D}}$  are David. Then  $\varphi$  itself is a David map.*

*Proof.* The complex dilatation  $\mu = \mu_\varphi$  is defined almost everywhere in  $\mathbb{C}$  and satisfies an exponential condition of the form (1.4) in  $\mathbb{D}$  and in  $\mathbb{C} \setminus \overline{\mathbb{D}}$  (by making  $C$  bigger and  $t$  and  $\varepsilon_0$  smaller if necessary, we can assume that the same constants  $(C, t, \varepsilon_0)$  work for both  $\mathbb{D}$  and  $\mathbb{C} \setminus \overline{\mathbb{D}}$ ). So to prove the lemma, we need only show that  $\varphi \in W_{\text{loc}}^{1,1}(\mathbb{C})$ .

On every compact subset of  $\mathbb{C} \setminus \mathbb{S}^1$ , the ordinary partial derivatives  $\partial\varphi$  and  $\bar{\partial}\varphi$  exist almost everywhere, are integrable, and coincide with the distributional partial derivatives of  $\varphi$ . We check that  $\partial\varphi$ , and hence  $\bar{\partial}\varphi = \mu \cdot \partial\varphi$ , is locally integrable near the unit circle  $\mathbb{S}^1$ .

Let  $D$  be any small disk centered on  $\mathbb{S}^1$ . We have

$$|\partial\varphi|^2 = \frac{J_\varphi}{1 - |\mu|^2} \leq \frac{J_\varphi}{1 - |\mu|},$$

so that

$$(4.1) \quad |\partial\varphi| \leq (J_\varphi)^{\frac{1}{2}} \cdot (1 - |\mu|)^{-\frac{1}{2}}.$$

Now  $J_\varphi \in L^1(D)$  since  $\int_D J_\varphi \leq \text{area}(\varphi(D)) < +\infty$ , and  $(1 - |\mu|)^{-1} \in L^1(D)$  because of the exponential condition (1.4). It follows from Hölder inequality applied to (4.1) that  $\partial\varphi \in L^1(D)$ .  $\square$

**Theorem 4.3.** *David circles are (quasi)conformally removable.*

*Proof.* Let  $\varphi : \mathbb{C} \rightarrow \mathbb{C}$  be a David map and  $\Gamma = \varphi(\mathbb{S}^1)$ . Let  $f : \mathbb{C} \rightarrow \mathbb{C}$  be a homeomorphism which is conformal in  $\mathbb{C} \setminus \Gamma$ . Then the homeomorphism  $f \circ \varphi$  is David in  $\mathbb{D}$  and in  $\mathbb{C} \setminus \overline{\mathbb{D}}$ . By Lemma 4.2,  $f \circ \varphi : \mathbb{C} \rightarrow \mathbb{C}$  is a David map. Since  $\mu_{f \circ \varphi} = \mu_\varphi$  almost everywhere, it follows from the uniqueness part of David's theorem [D] that  $f$  must be conformal in  $\mathbb{C}$ .  $\square$

## REFERENCES

- [A] L. Ahlfors, *Lectures on quasiconformal mappings*, Van Nostrand, 1966.
- [AB] L. Ahlfors and L. Bers, *Riemann mapping's theorem for variable metrics*, Annals of Math. **72** (1960) 385-404.
- [As] K. Astala, *Area distortion of quasiconformal mappings*, Acta Math. **173** (1994) 37-60.
- [D] G. David, *Solutions de l'equation de Beltrami avec  $\|\mu\|_\infty = 1$* , Ann. Acad. Sci. Fenn. Ser. A I Math. **13** (1988) 25-70.
- [GV] F. Gehring, J. Väisälä, *Hausdorff dimension and quasiconformal mappings*, J. London Math. Soc. **6** (1973) 504-512.
- [GJ] J. Graczyk and P. Jones, *Dimension of the boundary of quasiconformal Siegel disks*, Invent. Math. **148** (2002), 465-493.
- [K] R. Kaufman, *Fourier-Stieltjes coefficients and continuation of functions*, Ann. Acad. Sci. Fenn. Ser. A I Math. **9** (1984) 27-31.
- [LV] O. Lehto, K. Virtanen, *Quasiconformal mappings in the plane*, Springer-Verlag, 1973.
- [M] P. Mattila, *Geometry of Sets and Measures in Euclidean spaces*, Cambridge University Press, 1995.
- [P] C. L. Petersen, *Local connectivity of some Julia sets containing a circle with an irrational rotation*, Acta Math. **177** (1996) 163-224.
- [PZ] C. L. Petersen, S. Zakeri, *On the Julia set of a typical quadratic polynomial with a Siegel disk*, Stony Brook IMS preprint 2000/6, to appear in Annals of Math.
- [T] P. Tukia, *Compactness properties of  $\mu$ -homeomorphisms*, Ann. Acad. Sci. Fenn. Ser. A I Math. **16** (1991) 47-69.

S. ZAKERI, INSTITUTE FOR MATHEMATICAL SCIENCES, STONY BROOK UNIVERSITY, STONY BROOK, NY 11794-3651

*E-mail address:* zakeri@math.sunysb.edu

# DAVID HOMEOMORPHISMS AND HAUSDORFF DIMENSION

SAEED ZAKERI

ABSTRACT. David homeomorphisms are generalizations of classical planar quasiconformal maps whose dilatation is allowed to tend to infinity in a controlled fashion. In this note we examine how these homeomorphisms distort Hausdorff dimension. We show

- For any given  $\alpha$  and  $\beta$  in  $[0, 2]$ , there exists a David homeomorphism  $\varphi : \mathbb{C} \rightarrow \mathbb{C}$  and a compact set  $\Lambda$  such that  $\dim_{\mathbb{H}} \Lambda = \alpha$  and  $\dim_{\mathbb{H}} \varphi(\Lambda) = \beta$ .
- There exists a David homeomorphism  $\varphi : \mathbb{C} \rightarrow \mathbb{C}$  such that the Jordan curve  $\Gamma = \varphi(\mathbb{T})$  satisfies  $\dim_{\mathbb{H}} \Gamma = 2$ .

One should contrast the first statement with the fact that quasiconformal maps preserve sets of Hausdorff dimension 0 and 2. The second statement provides an example of a Jordan curve with Hausdorff dimension 2 which is (quasi) conformally removable.

## 1. INTRODUCTION

An orientation-preserving homeomorphism  $\varphi : U \rightarrow V$  between planar domains is called *quasiconformal* if it belongs to the Sobolev class  $W_{\text{loc}}^{1,1}(U)$  (i.e., has locally integrable distributional partial derivatives in  $U$ ) and its *complex dilatation*  $\mu_{\varphi} := \overline{\partial}\varphi/\partial\varphi$  satisfies

$$\|\mu_{\varphi}\|_{\infty} < 1.$$

In terms of the *real dilatation* defined by

$$K_{\varphi} := \frac{1 + |\mu_{\varphi}|}{1 - |\mu_{\varphi}|} = \frac{|\partial\varphi| + |\overline{\partial}\varphi|}{|\partial\varphi| - |\overline{\partial}\varphi|},$$

the latter condition can be expressed as

$$\|K_{\varphi}\|_{\infty} < +\infty.$$

The quantity  $\|K_{\varphi}\|_{\infty}$  is called the *maximal dilatation* of  $\varphi$ . We say that the map  $\varphi$  is *K-quasiconformal* if its maximal dilatation does not exceed  $K$ .

For later comparison with the properties of David homeomorphisms defined below, we recall some basic properties of quasiconformal maps (see [A] or [LV]):

- If  $\varphi$  is  $K$ -quasiconformal for some  $K \geq 1$ , so is the inverse map  $\varphi^{-1}$ .

---

*Date:* April 29, 2002.



- A  $K$ -quasiconformal map  $\varphi : U \rightarrow V$  is locally Hölder continuous of exponent  $1/K$ . In other words, for every compact set  $E \subset U$  and every  $z, w \in E$ ,

$$|\varphi(z) - \varphi(w)| \leq C |z - w|^{\frac{1}{K}}$$

where  $C > 0$  only depends on  $E$  and  $K$ .

- A quasiconformal map  $\varphi : U \rightarrow V$  is absolutely continuous; in fact, the Jacobian  $J_\varphi = |\partial\varphi|^2 - |\bar{\partial}\varphi|^2$  is locally integrable in  $U$  and

$$(1.1) \quad \text{area } \varphi(E) = \int_E J_\varphi dx dy,$$

for every measurable  $E \subset U$ .

- More precisely, the Jacobian  $J_\varphi$  of a quasiconformal map  $\varphi : U \rightarrow V$  is in  $L_{\text{loc}}^p(U)$  for some  $p > 1$ . If we define

$$(1.2) \quad p(K) := \sup\{p : J_\varphi \in L_{\text{loc}}^p(U) \text{ for every } K\text{-quasiconformal map } \varphi \text{ in } U\},$$

then

$$(1.3) \quad p(K) = \frac{K}{K-1}.$$

This was conjectured by Gehring and Väisälä in 1971 [**GV**] and was proved by Astala in 1994 [**As**].

- Let  $\{\varphi_n\}$  be a sequence of  $K$ -quasiconformal maps in a planar domain  $U$  which fix two given points of  $U$ . Then  $\{\varphi_n\}$  has a subsequence which converges locally uniformly to a  $K$ -quasiconformal map in  $U$ .

The measurable Riemann mapping theorem of Morrey-Ahlfors-Bers [**AB**] asserts that any measurable function  $\mu$  in a domain  $U$  which satisfies  $\|\mu\|_\infty < 1$  is the complex dilatation of some quasiconformal map  $\varphi$  on  $U$ , which means  $\varphi$  satisfies the *Beltrami equation*  $\bar{\partial}\varphi = \mu \cdot \partial\varphi$  almost everywhere in  $U$ . Recent progress in conformal geometry and holomorphic dynamics has made it abundantly clear that one must also study this equation in the case  $\|\mu\|_\infty = 1$ . With some restrictions on the asymptotic growth of  $|\mu|$ , the solvability of the Beltrami equation can still be guaranteed. One such condition is given by David in [**D**]: Let  $\sigma$  denote the spherical area in  $\widehat{\mathbb{C}}$  and  $\mu$  be a measurable function in  $U$  which satisfies

$$(1.4) \quad \sigma\{z \in U : |\mu(z)| > 1 - \varepsilon\} \leq C \exp\left(-\frac{t}{\varepsilon}\right) \quad \text{for all } \varepsilon < \varepsilon_0$$

for some positive constants  $C, t, \varepsilon_0$ . Then David showed that the Beltrami equation  $\bar{\partial}\varphi = \mu \cdot \partial\varphi$  has a homeomorphic solution  $\varphi \in W_{\text{loc}}^{1,1}(U)$ . Moreover,  $\varphi$  is unique up to postcomposition with a conformal map. Accordingly, any homeomorphism  $\varphi : U \rightarrow V$  in  $W_{\text{loc}}^{1,1}(U)$  whose complex dilatation satisfies a condition of the form (1.4) is called a

*David homeomorphism.* Equivalently, there must be positive constants  $C, t, K_0$  such that

$$(1.5) \quad \sigma\{z \in U : K_\varphi(z) > K\} \leq Ce^{-tK} \quad \text{for all } K > K_0.$$

When we want to emphasize the value of these constants, we say that  $\varphi$  is a David  $(C, t, K_0)$ -homeomorphism. Note that when  $U$  is a bounded domain in  $\mathbb{C}$ , the spherical metric can be replaced by the Euclidean area in David's condition (1.5).

David homeomorphisms enjoy some of the useful properties of quasiconformal maps, but the two categories differ in many respects. As an indication of their similarity, let us mention the following two facts:

- Every David homeomorphism is absolutely continuous; the Jacobian formula (1.1) still holds.
- *Tukia's Theorem* [T]. “Let  $C, t, K_0$  be positive and suppose  $\{\varphi_n\}$  is a sequence of David  $(C, t, K_0)$ -homeomorphisms in a domain  $U$  which fix two given points of  $U$ . Then  $\{\varphi_n\}$  has a subsequence which converges locally uniformly to a David homeomorphism in  $U$ .” It is rather easy to show that some subsequence of  $\{\varphi_n\}$  converges locally uniformly to a homeomorphism. What is highly non-trivial is the fact that this homeomorphism must be David. We remark that the parameters of the limit map may in fact be different from  $C, t, K_0$ .

Here are further properties of David homeomorphisms which indicate their difference with quasiconformal maps:

- The inverse of a David homeomorphism may *not* be David.
- A David homeomorphism may *not* be locally Hölder.
- The Jacobian of a David homeomorphism may *not* be in  $L^p_{\text{loc}}(U)$  for any  $p > 1$ .

As an example, the homeomorphism  $\varphi : \mathbb{D}(0, 1/e) \rightarrow \mathbb{D}$  defined by

$$\varphi(re^{i\theta}) := -\frac{1}{\log r} e^{i\theta}$$

is David, but it is not Hölder in any neighborhood of 0, and the inverse map  $\varphi^{-1}$  is not David.

The main goal of this note is to show how David homeomorphisms differ from quasiconformal maps in the way they change Hausdorff dimension of sets. Recall that the *Hausdorff  $s$ -measure* of a set  $E \subset \mathbb{C}$  is defined by

$$H^s(E) := \liminf_{\varepsilon \rightarrow 0} \inf_{\mathcal{U}} \sum_i (\text{diam } U_i)^s,$$

where the infimum is taken over all countable covers  $\mathcal{U} = \{U_i\}$  of  $E$  by sets of Euclidean diameter at most  $\varepsilon$ . The *Hausdorff dimension* of  $E$  is defined by

$$\dim_{\text{H}} E := \inf\{s : H^s(E) = 0\}.$$

Quasiconformal maps can change Hausdorff dimension of sets only by a bounded factor depending on their maximal dilatation. This was first proved by Gehring and Väisälä [GV] who showed that if  $\varphi : U \rightarrow V$  is  $K$ -quasiconformal,  $E \subset U$ ,  $\dim_{\mathbb{H}} E = \alpha$  and  $\dim_{\mathbb{H}} \varphi(E) = \beta$ , then

$$\frac{2(p(K) - 1)\alpha}{2p(K) - \alpha} \leq \beta \leq \frac{2p(K)\alpha}{2(p(K) - 1) + \alpha}.$$

Here  $p(K) > 1$  is the constant defined in (1.2). By Astala's result (1.3), one obtains

$$\frac{2\alpha}{2K - (K - 1)\alpha} \leq \beta \leq \frac{2K\alpha}{2 + (K - 1)\alpha}$$

which can be put in the symmetric form

$$(1.6) \quad \frac{1}{K} \left( \frac{1}{\alpha} - \frac{1}{2} \right) \leq \frac{1}{\beta} - \frac{1}{2} \leq K \left( \frac{1}{\alpha} - \frac{1}{2} \right).$$

It follows in particular that quasiconformal maps preserve sets of Hausdorff dimension 0 and 2.

In contrast, we prove the following:

**Theorem A.** *Given any two numbers  $\alpha$  and  $\beta$  in  $[0, 2]$ , there exists a David homeomorphism  $\varphi : \mathbb{C} \rightarrow \mathbb{C}$  and a compact set  $\Lambda \subset \mathbb{C}$  such that  $\dim_{\mathbb{H}} \Lambda = \alpha$  and  $\dim_{\mathbb{H}} \varphi(\Lambda) = \beta$ .*

Perhaps the least expected case of this theorem is that the David image of a set of dimension 2 can have dimension 0. The proof shows that  $\varphi$  can be taken to be a David  $(C, 1, 1)$ -homeomorphism for a universal  $C > 0$ .

In the special case of a  $K$ -quasicircle, i.e., the image  $\Gamma$  of a round circle under a  $K$ -quasiconformal map, the estimate (1.6) gives

$$1 \leq \dim_{\mathbb{H}} \Gamma \leq \frac{2K}{K + 1}$$

(the lower bound comes from topological considerations). It is well-known that  $\dim_{\mathbb{H}} \Gamma$  can in fact take all values in  $[1, 2[$ . We show that the upper bound 2 can be attained by the David image of a round circle. Let us say a Jordan curve  $\Gamma \subset \mathbb{C}$  is a *David circle* if there exists a David homeomorphism  $\varphi : \mathbb{C} \rightarrow \mathbb{C}$  such that  $\Gamma = \varphi(\mathbb{T})$ , where  $\mathbb{T} = \{z : |z| = 1\}$ .

**Theorem B.** *There exists a David circle of Hausdorff dimension 2.*

One interesting feature of this result is the fact that David circles are (quasi-) conformally removable (see §4).

Both results are bad news for applications in holomorphic dynamics, where one often wants to estimate the Hausdorff dimension of invariant sets by computing the dimension in a conjugate dynamical system. For example, having dimension less than two for such invariant sets is preserved under a quasiconformal conjugacy, but this is

no longer the case when the conjugacy is a David homeomorphism. In [PZ], using David's theory and a surgery on a Blaschke product we showed that for almost every  $0 < \theta < 1$  the Julia set of the quadratic map  $z \mapsto e^{2\pi i\theta}z + z^2$  is locally-connected and has measure zero. These quadratics have an invariant Siegel disk centered at 0 which are images of the unit disk under a David homeomorphism. Theorems A and B suggest the possibility that these Julia sets, or even the boundary of their Siegel disk might have dimension 2.

## 2. MAIN CONSTRUCTION

In what follows we use the following notation: For two positive numbers  $a$  and  $b$ , we write

$$a \preceq b$$

if there is a universal constant  $C > 0$  such that  $a \leq Cb$ . We write

$$a \asymp b$$

if  $a \preceq b$  and  $b \preceq a$ , i.e., if there is a universal constant  $C > 0$  such that  $C^{-1}b \leq a \leq Cb$ . In this case, we say that  $a$  and  $b$  are *comparable*.

**A family of Cantor sets.** Given a strictly decreasing sequence  $\mathbf{d} = \{d_n\}_{n \geq 0}$  of positive numbers with  $d_0 = 1$ , we construct a Cantor set  $\Lambda(\mathbf{d})$  as the intersection of a nested sequence  $\{\Lambda_n\}_{n \geq 0}$  of compact sets in the unit square  $[0, 1]^2 \subset \mathbb{R}$ . Set  $\Lambda_0 := [0, 1]^2$  and  $a_1 := 2^{-2}(d_0 - d_1)$ . Define  $\Lambda_1$  as the disjoint union of the four closed squares of size  $2^{-1}d_1$  in  $\Lambda_0$  which have distance  $a_1$  to the boundary of  $\Lambda_0$  (see Fig. 1). Suppose  $\Lambda_{n-1}$  is constructed for some  $n \geq 2$ , and that it is the disjoint union of  $4^{n-1}$  closed squares of size  $2^{-(n-1)}d_{n-1}$ . Define

$$(2.1) \quad a_n := 2^{-(n+1)}(d_{n-1} - d_n).$$

For any square  $S$  in  $\Lambda_{n-1}$ , consider the disjoint union of the four closed squares in  $S$  of size  $2^{-n}d_n$  which have distance  $a_n$  to the boundary of  $S$ . The union of all these squares for all such  $S$  will then be called  $\Lambda_n$ .

The Cantor set  $\Lambda(\mathbf{d})$  is defined as  $\bigcap_{n \geq 0} \Lambda_n$ . Evidently

$$\text{area } \Lambda(\mathbf{d}) = \lim_{n \rightarrow \infty} \text{area } \Lambda_n = \lim_{n \rightarrow \infty} d_n^2.$$

**Lemma 2.1.** *The Hausdorff dimension of the Cantor set  $\Lambda = \Lambda(\mathbf{d})$  satisfies*

$$(2.2) \quad 2 - \limsup_{n \rightarrow \infty} \frac{-2 \log d_{n+1}}{-\log d_n + n \log 2} \leq \dim_{\text{H}} \Lambda \leq 2 - \liminf_{n \rightarrow \infty} \frac{-2 \log d_n}{-\log d_n + n \log 2}.$$

*Proof.* For each  $n \geq 0$ , there are  $4^n$  squares of diameter  $2^{\frac{1}{2}-n}d_n$  covering  $\Lambda$ . Hence the Hausdorff  $s$ -measure of  $\Lambda$  is bounded above by

$$\lim_{n \rightarrow \infty} 4^n (2^{\frac{1}{2}-n}d_n)^s = 2^{\frac{s}{2}} \lim_{n \rightarrow \infty} 2^{n(2-s)} d_n^s,$$

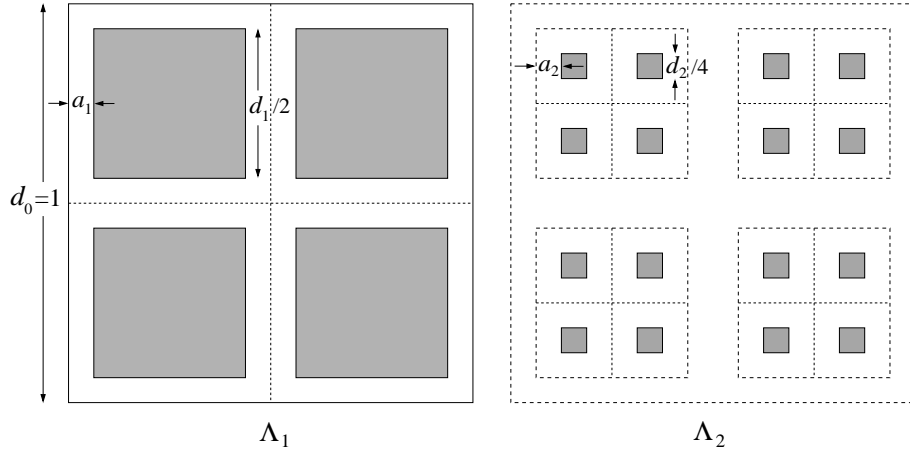

FIGURE 1. *First two steps in the construction of  $\Lambda(\mathbf{d})$ .*

which is zero if  $s > 2 - \liminf_{n \rightarrow \infty} (-2 \log d_n) / (-\log d_n + n \log 2)$ . This proves the upper bound in (2.2).

The lower bound follows from a standard mass distribution argument: Construct a natural probability measure  $\mu$  on  $\Lambda$  which gives equal mass  $4^{-n}$  to each square in  $\Lambda_n$ , so that

$$\mu(S) = \frac{\text{area}(S)}{d_n^2} \quad \text{if } S \text{ is a square in } \Lambda_n.$$

If  $x \in \Lambda$ ,  $\varepsilon > 0$  and  $n$  is chosen so that  $2^{-n}d_n < \varepsilon \leq 2^{-(n-1)}d_{n-1}$ , it follows that

$$\mu(\mathbb{D}(x, \varepsilon)) \preccurlyeq \frac{\varepsilon^2}{d_n^2} = \varepsilon^s \frac{\varepsilon^{2-s}}{d_n^2} \preccurlyeq \varepsilon^s \frac{2^{-n(2-s)}d_{n-1}^{2-s}}{d_n^2}.$$

If  $s < 2 - \limsup_{n \rightarrow \infty} (-2 \log d_{n+1}) / (-\log d_n + n \log 2)$ , the term  $2^{-n(2-s)}d_{n-1}^{2-s}/d_n^2$  will tend to zero as  $n \rightarrow \infty$ , so that

$$\mu(\mathbb{D}(x, \varepsilon)) \preccurlyeq \varepsilon^s$$

for all  $x \in \Lambda$  and all  $\varepsilon > 0$ . It follows then from Frostmann's Lemma (see for example [M]) that  $\dim_{\text{H}} \Lambda \geq s$ . This gives the lower bound in (2.2).  $\square$

**Standard homeomorphisms between Cantor sets.** We construct standard homeomorphisms with controlled dilatation between Cantor sets of the form  $\Lambda(\mathbf{d})$  defined above. The construction will depend on the following simple lemma:

**Lemma 2.2.** *Fix  $0 < a \leq b < 1/2$ . Let  $A_a$  be the closed annulus bounded by the squares*

$$\left\{ (x, y) \in \mathbb{R}^2 : \max\{|x|, |y|\} = \frac{1}{2} \right\} \quad \text{and} \quad \left\{ (x, y) \in \mathbb{R}^2 : \max\{|x|, |y|\} = \frac{1}{2} - a \right\},$$

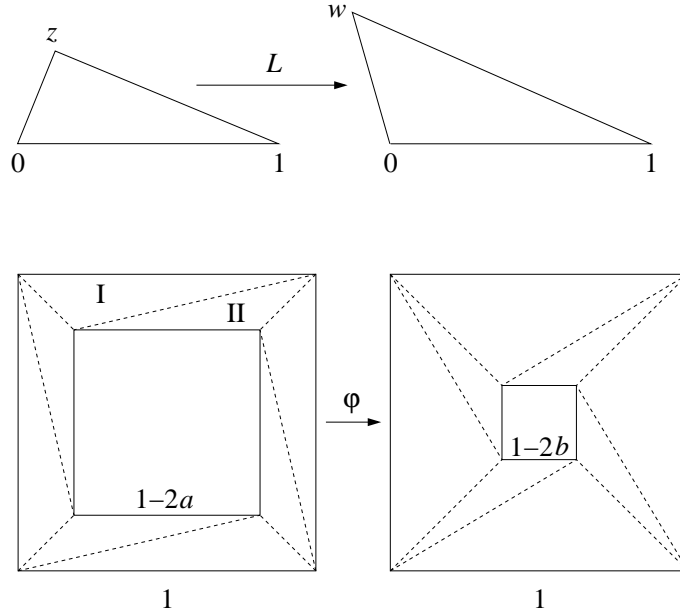

FIGURE 2

and similarly define  $A_b$ . Let  $\varphi : \partial A_a \rightarrow \partial A_b$  be a homeomorphism which acts as the identity on the outer boundary component and affinely on the inner boundary component, mapping  $1/2-a$  to  $1/2-b$ . Then  $\varphi$  can be extended to a  $K$ -quasiconformal homeomorphism  $A_a \rightarrow A_b$ , with

$$(2.3) \quad K \asymp \frac{b(1-2a)}{a(1-2b)}.$$

*Proof.* Let us first make a simple observation: If  $z$  and  $w$  are points in the upper half-plane and  $L : \mathbb{R}^2 \rightarrow \mathbb{R}^2$  is the affine map such that  $L(0) = 0$ ,  $L(1) = 1$  and  $L(z) = w$  (see Fig. 2), then the real dilatation of  $L$  is given by

$$(2.4) \quad K_L = \frac{|z - \bar{w}| + |z - w|}{|z - \bar{w}| - |z - w|}.$$

To prove the lemma, take the triangulations of  $A_a$  and  $A_b$  shown in Fig. 2 and extend  $\varphi$  affinely to each triangle. After appropriate rescaling, it follows from (2.4) that on a triangle of type I in the figure, the dilatation of  $\varphi$  is comparable to  $b/a$ , while on a triangle of type II, it is comparable to  $b(1-2a)/(a(1-2b))$ . Since  $b(1-2a)/(a(1-2b)) \geq b/a$ , we obtain (2.3).  $\square$

Now take a decreasing sequence  $\mathbf{d} = \{d_n\}$  of positive numbers with  $d_0 = 1$ , let  $\{a_n\}$  be defined as in (2.1), and consider the Cantor set  $\Lambda(\mathbf{d}) = \bigcap \Lambda_n$ . Take another such sequence  $\mathbf{d}' = \{d'_n\}$  and let  $a'_n, \Lambda'_n, \Lambda(\mathbf{d}')$  denote the corresponding data. We construct a homeomorphism  $\varphi : \mathbb{C} \rightarrow \mathbb{C}$  which maps the Cantor set  $\Lambda = \Lambda(\mathbf{d})$

to  $\Lambda' = \Lambda(\mathbf{d}')$ . This  $\varphi$  is the uniform limit of a sequence of quasiconformal maps  $\varphi_n : \mathbb{C} \rightarrow \mathbb{C}$  with  $\varphi_n(\Lambda_n) = \Lambda'_n$ , defined inductively as follows. Let  $\varphi_0$  be the identity map on  $\mathbb{C}$ . Suppose  $\varphi_{n-1}$  is constructed for some  $n \geq 1$  and that it maps each square in  $\Lambda_{n-1}$  affinely to the corresponding square in  $\Lambda'_{n-1}$ . Define  $\varphi_n = \varphi_{n-1}$  on  $\mathbb{C} \setminus \Lambda_{n-1}$  and let  $\varphi_n$  map each square in  $\Lambda_n$  affinely to the corresponding square in  $\Lambda'_n$ . The remaining set  $\Lambda_{n-1} \setminus \Lambda_n$  is the union of  $4^n$  annuli on the boundary of which  $\varphi_n$  can be defined affinely. By rescaling each annulus in  $\Lambda_{n-1} \setminus \Lambda_n$  and the corresponding annulus in  $\Lambda'_{n-1} \setminus \Lambda'_n$ , we are in the situation of Lemma 2.2, so we can extend  $\varphi_n$  in a piecewise affine fashion as in that lemma. This defines  $\varphi_n$  everywhere, and the inductive definition is complete.

To estimate the maximal dilatation of  $\varphi_n$ , note that by the above construction  $\varphi_n$  is conformal in  $\Lambda_n$  and has the same dilatation as  $\varphi_{n-1}$  on  $\mathbb{C} \setminus \Lambda_{n-1}$ . On each of the  $4^n$  annuli in  $\Lambda_{n-1} \setminus \Lambda_n$ , the dilatation of  $\varphi_n$  can be estimated using (2.3) in Lemma 2.2. In fact, rescaling each such annulus by a factor  $2^{-n}d_{n-1}$  and the corresponding annulus in  $\Lambda'_{n-1} \setminus \Lambda'_n$  by a factor  $2^{-n}d'_{n-1}$ , it follows from (2.3) that the dilatation of  $\varphi_n$  on each such annulus is comparable to

$$\begin{aligned} & \max \left\{ \frac{\frac{a'_n}{2^{-n}d'_{n-1}}(1 - 2\frac{a_n}{2^{-n}d_{n-1}})}{\frac{a_n}{2^{-n}d_{n-1}}(1 - 2\frac{a'_n}{2^{-n}d'_{n-1}})}, \frac{\frac{a_n}{2^{-n}d_{n-1}}(1 - 2\frac{a'_n}{2^{-n}d'_{n-1}})}{\frac{a'_n}{2^{-n}d'_{n-1}}(1 - 2\frac{a_n}{2^{-n}d_{n-1}})} \right\} \\ &= \max \left\{ \frac{a'_n(d_{n-1} - 2^{n+1}a_n)}{a_n(d'_{n-1} - 2^{n+1}a'_n)}, \frac{a_n(d'_{n-1} - 2^{n+1}a'_n)}{a'_n(d_{n-1} - 2^{n+1}a_n)} \right\} \\ &= \max \left\{ \frac{a'_n d_n}{a_n d'_n}, \frac{a_n d'_n}{a'_n d_n} \right\}. \end{aligned}$$

Summing up, we see that the sequence  $\{\varphi_n\}$  has the following properties:

- (i)  $\varphi_n = \varphi_{n-1}$  on  $\mathbb{C} \setminus \Lambda_{n-1}$ .
- (ii)  $\varphi_n$  maps each square in  $\Lambda_n$  affinely to the corresponding square in  $\Lambda'_n$ .
- (iii)  $\varphi_n$  is  $K_n$ -quasiconformal, where

$$(2.5) \quad K_n \asymp \max \left\{ K_{n-1}, \frac{a'_n d_n}{a_n d'_n}, \frac{a_n d'_n}{a'_n d_n} \right\}$$

and  $K_0 = 1$ .

Evidently,  $\varphi := \lim_{n \rightarrow \infty} \varphi_n$  is a homeomorphism which agrees with  $\varphi_n$  on  $\mathbb{C} \setminus \Lambda_n$  and satisfies  $\varphi(\Lambda) = \Lambda'$ . We call this  $\varphi$  the *standard homeomorphism from  $\Lambda$  to  $\Lambda'$* . Note that by the construction,  $\varphi^{-1}$  is the standard homeomorphism from  $\Lambda'$  to  $\Lambda$ .

### 3. PROOF OF THEOREM A

Now we are ready to prove Theorem A cited in §1.

*Proof of Theorem A.* If  $\alpha = \beta$ , there is nothing to prove. If  $\alpha \neq \beta$  and  $0 < \alpha, \beta < 2$ , it

is well known that there is a  $K$ -quasiconformal homeomorphism  $\varphi : \mathbb{C} \rightarrow \mathbb{C}$  mapping a set of dimension  $\alpha$  to a set of dimension  $\beta$  (see for example [GV]). Moreover, by (1.6), the minimum  $K$  this would require is

$$\max \left\{ \frac{\frac{1}{\beta} - \frac{1}{2}}{\frac{1}{\alpha} - \frac{1}{2}}, \frac{\frac{1}{\alpha} - \frac{1}{2}}{\frac{1}{\beta} - \frac{1}{2}} \right\}.$$

In what follows we only consider the cases where  $\alpha$  and  $\beta$  are distinct and at least one of them belongs to  $\{0, 2\}$ .

Consider the sequences  $\mathbf{d} = \{d_n\}$ ,  $\mathbf{d}' = \{d'_n\}$  and  $\mathbf{d}'' = \{d''_n\}$  defined by

$$d_n := 2^{-\frac{n}{\log n}}, \quad d'_n := 2^{-\nu n}, \quad d''_n := 2^{-n \log n},$$

where  $\nu > 0$ , and construct the Cantor sets  $\Lambda = \Lambda(\mathbf{d})$ ,  $\Lambda' = \Lambda(\mathbf{d}')$  and  $\Lambda'' = \Lambda(\mathbf{d}'')$  as in §2. By Lemma 2.1,

$$\dim_{\text{H}}(\Lambda) = 2, \quad \dim_{\text{H}}(\Lambda') = \frac{2}{\nu + 1}, \quad \dim_{\text{H}}(\Lambda'') = 0.$$

We prove that the standard homeomorphisms between these three Cantor sets *and* their inverses are all David homeomorphisms; this will prove the theorem.

• *Case 1. Mapping between  $\Lambda$  and  $\Lambda'$ .* Suppose  $\{\varphi_n\}$  is the sequence of quasiconformal maps which approximates the standard homeomorphism  $\varphi$  from  $\Lambda$  to  $\Lambda'$ . To estimate the dilatation of  $\varphi_n$ , note that

$$(3.1) \quad a_n = 2^{-(n+1)}(d_{n-1} - d_n) \asymp 2^{-n} \left( 2^{-\frac{n-1}{\log(n-1)}} - 2^{-\frac{n}{\log n}} \right) \asymp \frac{2^{-n - \frac{n}{\log n}}}{\log n}$$

and

$$(3.2) \quad a'_n = 2^{-(n+1)}(d'_{n-1} - d'_n) \asymp 2^{-n} (2^{-\nu(n-1)} - 2^{-\nu n}) \asymp 2^{-(\nu+1)n}.$$

Hence

$$\frac{a'_n d_n}{a_n d'_n} \asymp \frac{2^{-(\nu+1)n} \cdot 2^{-\frac{n}{\log n}}}{\frac{2^{-n - \frac{n}{\log n}}}{\log n} \cdot 2^{-\nu(n-1)}} \asymp \log n.$$

It follows from (2.5) that there is a sequence  $K_0 = 1 < K_1 < K_2 < \dots < K_n < \dots$  with  $K_n \asymp \log n$  such that  $\varphi_n$  is  $K_n$ -quasiconformal. Fix the index  $n$  and let  $K \geq 1$ . Choose  $j$  so that  $K_j \leq K < K_{j+1}$ . Then

$$\begin{aligned} \text{area}\{z : K_{\varphi_n}(z) > K\} &\leq \text{area}\{z : K_{\varphi_n}(z) > K_j\} \\ &\leq \text{area}(\Lambda_j) = d_j^2 = 4^{-\frac{j}{\log j}}. \end{aligned}$$

Since  $K \asymp K_j \asymp \log j$ , we have

$$\text{area}\{z : K_{\varphi_n}(z) > K\} \leq C e^{-K}$$



for some universal  $C > 0$ . It follows that  $\varphi_n$  is a David  $(C, 1, 1)$ -homeomorphism, with  $C$  independent of  $n$ . By Tukia's Theorem quoted in §1, we conclude that  $\varphi = \lim_{n \rightarrow \infty} \varphi_n$  is a David homeomorphism.

The inverse maps  $\psi_n := \varphi_n^{-1}$  are also  $K_n$ -quasiconformal with the same dilatation  $K_n \asymp \log n$  and they converge uniformly to  $\psi := \varphi^{-1}$ . Moreover, if  $K_j \leq K < K_{j+1}$ , then

$$\begin{aligned} \text{area}\{z : K_{\psi_n}(z) > K\} &\leq \text{area}\{z : K_{\psi_n}(z) > K_j\} \\ &\leq \text{area}(\Lambda'_j) = (d'_j)^2 = 4^{-\nu j} \\ &\leq C e^{-K} \end{aligned}$$

for some constant  $C > 0$  independent of  $n, K$ . This means the  $\psi_n$  are David  $(C, 1, 1)$ -homeomorphisms, so by Tukia's Theorem  $\psi$  must also be David.

• *Case 2. Mapping between  $\Lambda'$  and  $\Lambda''$ .* The argument here is quite similar to the previous case. We have

$$(3.3) \quad a''_n = 2^{-(n+1)}(d''_{n-1} - d''_n) \asymp 2^{-n}(2^{-(n-1)\log(n-1)} - 2^{-n\log n}) \asymp 2^{-n-n\log n+\log n}$$

Hence, using (3.2) and (3.3), we obtain

$$\frac{a''_n d'_n}{a'_n d''_n} \asymp \frac{2^{-n-n\log n+\log n} \cdot 2^{-\nu n}}{2^{-(\nu+1)n} \cdot 2^{-n\log n}} \asymp 2^{\log n}.$$

Let  $\{\varphi_n\}$  be the sequence of quasiconformal maps which approximates the standard homeomorphism  $\varphi$  from  $\Lambda'$  to  $\Lambda''$ . It follows then from (2.5) that there is a sequence  $K_0 = 1 < K_1 < K_2 < \dots < K_n < \dots$  with  $K_n \asymp 2^{\log n}$  such that  $\varphi_n$  is  $K_n$ -quasiconformal. Fix  $n$ , let  $K \geq 1$ , and choose  $j$  so that  $K_j \leq K < K_{j+1}$ . Then  $K \asymp K_j \asymp 2^{\log j}$  and

$$\begin{aligned} \text{area}\{z : K_{\varphi_n}(z) > K\} &\leq \text{area}\{z : K_{\varphi_n}(z) > K_j\} \\ &\leq \text{area}(\Lambda'_j) = (d'_j)^2 = 4^{-\nu j} \\ &\leq C e^{-K} \end{aligned}$$

for some constant  $C > 0$  independent of  $n, K$ . This shows  $\varphi_n$  is a David  $(C, 1, 1)$ -homeomorphism, hence  $\varphi = \lim_{n \rightarrow \infty} \varphi_n$  must be David.

The inverse maps  $\psi_n := \varphi_n^{-1}$  are  $K_n$ -quasiconformal with  $K_n \asymp 2^{\log n}$  and they converge uniformly to  $\psi := \varphi^{-1}$ . Moreover, if  $K_j \leq K < K_{j+1}$ , then

$$\begin{aligned} \text{area}\{z : K_{\psi_n}(z) > K\} &\leq \text{area}\{z : K_{\psi_n}(z) > K_j\} \\ &\leq \text{area}(\Lambda''_j) = (d''_j)^2 = 4^{-j\log j} \\ &\leq C e^{-K} \end{aligned}$$

for some constant  $C > 0$  independent of  $n, K$ . Thus all the  $\psi_n$  are David  $(C, 1, 1)$ -homeomorphisms, so  $\psi$  must also be David.

- *Case 3. Mapping between  $\Lambda$  and  $\Lambda''$ .* Using (3.1) and (3.3), we obtain

$$\frac{a_n'' d_n}{a_n d_n''} \asymp \frac{2^{-n-n \log n + \log n} \cdot 2^{-\frac{n}{\log n}}}{\frac{2^{-n-\frac{n}{\log n}}}{\log n} \cdot 2^{-n \log n}} \asymp 2^{\log n} \log n = n^{\log 2} \log n.$$

Let  $\{\varphi_n\}$  be the sequence of quasiconformal maps which approximates the standard homeomorphism  $\varphi$  from  $\Lambda$  to  $\Lambda''$ . It follows then from (2.5) that there is a sequence  $K_0 = 1 < K_1 < K_2 < \dots < K_n < \dots$  with  $K_n \asymp n^{\log 2} \log n$  such that  $\varphi_n$  is  $K_n$ -quasiconformal. Hence, fixing  $n$  and letting  $K \geq 1$ , if  $j$  is chosen so that  $K_j \leq K < K_{j+1}$ , we have

$$\begin{aligned} \text{area}\{z : K_{\varphi_n}(z) > K\} &\leq \text{area}\{z : K_{\varphi_n}(z) > K_j\} \\ &\leq \text{area}(\Lambda_j) = (d_j)^2 = 4^{-\frac{j}{\log j}}. \end{aligned}$$

But  $K \asymp K_j \asymp j^{\log 2} \log j \asymp j / \log j$ , so that

$$\text{area}\{z : K_{\varphi_n}(z) > K\} \leq C e^{-K}$$

for a constant  $C > 0$  independent of  $n, K$ . It follows that  $\varphi_n$  is a David  $(C, 1, 1)$ -homeomorphism, hence  $\varphi = \lim_{n \rightarrow \infty} \varphi_n$  must be David.

The inverse maps  $\psi_n := \varphi_n^{-1}$  are  $K_n$ -quasiconformal with  $K_n \asymp n^{\log 2} \log n$  and they converge uniformly to  $\psi := \varphi^{-1}$ . Moreover, if  $K_j \leq K < K_{j+1}$ , then

$$\begin{aligned} \text{area}\{z : K_{\psi_n}(z) > K\} &\leq \text{area}\{z : K_{\psi_n}(z) > K_j\} \\ &\leq \text{area}(\Lambda_j'') = (d_j'')^2 = 4^{-j \log j} \\ &\leq C e^{-K}, \end{aligned}$$

where the constant  $C > 0$  is independent of  $n, K$ . This means the  $\psi_n$  are all David  $(C, 1, 1)$ -homeomorphisms, so  $\psi$  must also be David.  $\square$

#### 4. PROOF OF THEOREM B

The idea of the proof of Theorem B is to construct a David homeomorphism  $\varphi : \mathbb{C} \rightarrow \mathbb{C}$  which maps a *linear* Cantor set  $\Sigma \subset [0, 1]$  to a Cantor set of the form  $\Lambda(\mathbf{d})$  with dimension 2. The image  $\varphi([0, 1])$  will then be a closed embedded arc of dimension 2. Since the construction allows  $\varphi = \text{id}$  outside the unit square  $[0, 1]^2$ , we can easily complete this arc to a David circle.

**A linear Cantor set.** Consider the closed unit square  $\Sigma_0 := [0, 1]^2$  in the plane. We construct a nested sequence  $\{\Sigma_n\}_{n \geq 0}$  of compact sets in whose intersection is a linear Cantor set. For  $1 \leq i \leq 4$ , let  $f_i : \mathbb{C} \rightarrow \mathbb{C}$  be the affine contraction defined by

$$f_i(z) = \frac{1}{8}z + \frac{2i-1}{8},$$

and set

$$\Sigma_n := \bigcup_{i_1, \dots, i_n} f_{i_1} \circ \dots \circ f_{i_n}(\Sigma_0),$$

where the union is taken over all unordered  $n$ -tuples  $i_1, \dots, i_n$  chosen from  $\{1, 2, 3, 4\}$ . It is easy to see that  $\Sigma_n$  is the disjoint union of  $4^n$  closed squares of size  $8^{-n}$  with centers on  $\mathbb{R}$  and sides parallel to coordinate axes. We define the Cantor set  $\Sigma$  as the intersection  $\bigcap_{n=0}^{\infty} \Sigma_n$ . Evidently,  $\Sigma$  is a subset of  $[0, 1]$  which has measure zero and Hausdorff dimension  $2/3$ .

**A quasiconformal twist.** The proof of Theorem B also depends on the following lemma which is a triply-connected version of Lemma 2.2. For simplicity we denote by  $S(p, r)$  the open square centered at  $p$  whose side-length is  $r$ .

**Lemma 4.1.** *Fix  $0 < a < 1/5$  and let  $A, B$  be closed triply-connected sets defined by*

$$\begin{aligned} A &:= \left( \left[ 0, \frac{1}{2} \right] \times \left[ -\frac{1}{2}, \frac{1}{2} \right] \right) \setminus \left( S\left(\frac{1}{8}, \frac{1}{8}\right) \cup S\left(\frac{3}{8}, \frac{1}{8}\right) \right) \\ B &:= \left( \left[ 0, \frac{1}{2} \right] \times \left[ -\frac{1}{2}, \frac{1}{2} \right] \right) \setminus \left( S\left(\frac{1+i}{4}, \frac{1}{2} - 2a\right) \cup S\left(\frac{1-i}{4}, \frac{1}{2} - 2a\right) \right) \end{aligned}$$

(see Fig. 3). Let  $\varphi : \partial A \rightarrow \partial B$  be a homeomorphism which acts as the identity on the outer boundary component and affinely on the inner boundary components, mapping the boundary of  $S(\frac{1}{8}, \frac{1}{8})$  to the boundary of  $S(\frac{1+i}{4}, \frac{1}{2} - 2a)$  and the boundary of  $S(\frac{3}{8}, \frac{1}{8})$  to the boundary of  $S(\frac{1-i}{4}, \frac{1}{2} - 2a)$ , preserving the horizontal and vertical sides. Then  $\varphi$  can be extended to a  $K$ -quasiconformal homeomorphism  $A \rightarrow B$ , with

$$(4.1) \quad K \asymp \frac{1}{a}.$$

*Proof.* We take the affine cell divisions of  $A$  and  $B$  shown in Fig. 3 and require  $\varphi$  to map each cell in  $A$  to its corresponding cell in  $B$  in a piecewise affine fashion. By symmetry, it suffices to define  $\varphi$  piecewise affinely between the cells labeled I, II, III, and IV. We let  $\varphi$  be affine between the triangular cells III. On the cells I and II we subdivide the trapezoids into two triangular cells and define  $\varphi$  to be affine on each of them. An easy computation based on (2.4) then shows that the dilatation of  $\varphi$  on I, II, and III is comparable to  $1/a$ .

It remains to define  $\varphi$  between the cells IV and estimate its dilatation. Note that the cell IV in  $A$  has bounded geometry so there is a piecewise affine  $K_1$ -quasiconformal map  $f_1$  from this cell to the square with vertices  $0, 1, (1+i)/2, (1-i)/2$ , with  $K_1 \asymp 1$ . The cell IV in  $B$ , after rescaling, becomes the tetragon with vertices

$$0, 1, z := -\frac{1-2a}{4a} + \frac{i}{2}, z' := 1 - \frac{(1-4a)i}{4a}.$$

Let  $f_2$  be the piecewise affine map on this tetragon which maps the triangle  $\Delta(0, 1, z)$  affinely to  $\Delta(0, 1, (1+i)/2)$  and the triangle  $\Delta(0, 1, z')$  affinely to  $\Delta(0, 1, (1-i)/2)$  (see

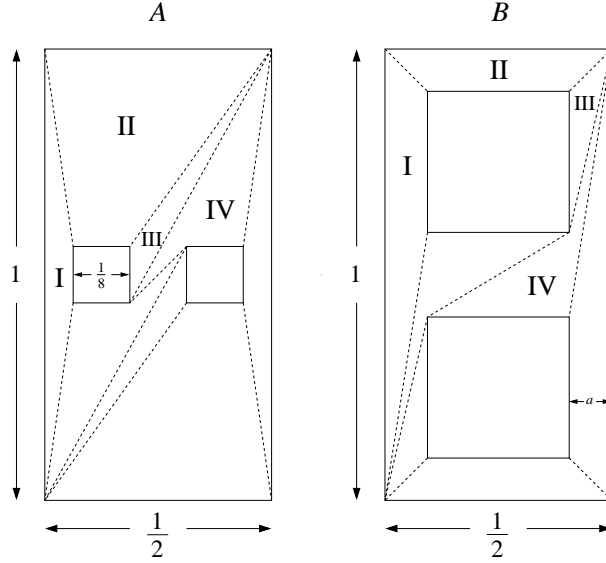

 FIGURE 3. Cell divisions of  $A$  and  $B$ .

Fig. ??). Then a brief calculation based on (2.4) shows that  $f_2$  is  $K_2$ -quasiconformal, with  $K_2 \asymp 1/a$ . The map  $\varphi$  can then be defined by  $f_2^{-1} \circ f_1$ , whose dilatation is clearly comparable to  $1/a$ .  $\square$

We are now ready to prove Theorem B cited in §1.

*Proof of Theorem B.* Consider the Cantor set  $\Sigma = \bigcap_{n=1}^{\infty} \Sigma_n$  constructed above and the Cantor set  $\Lambda = \Lambda(\mathbf{d})$  constructed in §2, where  $\mathbf{d} = \{d_n\}$  is defined by  $d_n := 2^{-\sqrt{n}}$ . It follows from Lemma 2.1 that  $\dim_{\mathbb{H}}(\Lambda) = 2$ .

We construct a David homeomorphism  $\varphi : \mathbb{C} \rightarrow \mathbb{C}$ , identity outside the closed unit square, with the property  $\varphi(\Sigma) = \Lambda$ . Then the closed embedded arc  $\varphi([0, 1])$  contains  $\Lambda$  and hence has dimension 2. By pre-composing  $\varphi$  with an appropriate quasiconformal map, we obtain a David homeomorphism mapping the round circle to a Jordan curve of dimension 2.

The map  $\varphi$  will be the uniform limit of a sequence of quasiconformal maps  $\varphi_n : \mathbb{C} \rightarrow \mathbb{C}$  with  $\varphi_n(\Sigma_n) = \Lambda_n$ , defined inductively as follows. Let  $\varphi_0$  be the identity map on  $\mathbb{C}$ . Suppose  $\varphi_{n-1}$  is constructed for some  $n \geq 1$  and that it maps each square in  $\Sigma_{n-1}$  affinely to the corresponding square in  $\Lambda_{n-1}$ . Define  $\varphi_n = \varphi_{n-1}$  on  $\mathbb{C} \setminus \Sigma_{n-1}$  and let  $\varphi_n$  map each square in  $\Sigma_n$  affinely to the corresponding square in  $\Lambda'_n$ . The remaining set  $\Sigma_{n-1} \setminus \Sigma_n$  is the union of  $4^n$  annuli on the boundary of which  $\varphi_n$  can be defined affinely. By rescaling each annulus in  $\Lambda_{n-1} \setminus \Lambda_n$  and the corresponding annulus in  $\Lambda'_{n-1} \setminus \Lambda'_n$ , we are in the situation of Lemma 2.2, so we can extend  $\varphi_n$  in a piecewise affine fashion as in that lemma. This defines  $\varphi_n$  everywhere, and the inductive definition is complete.

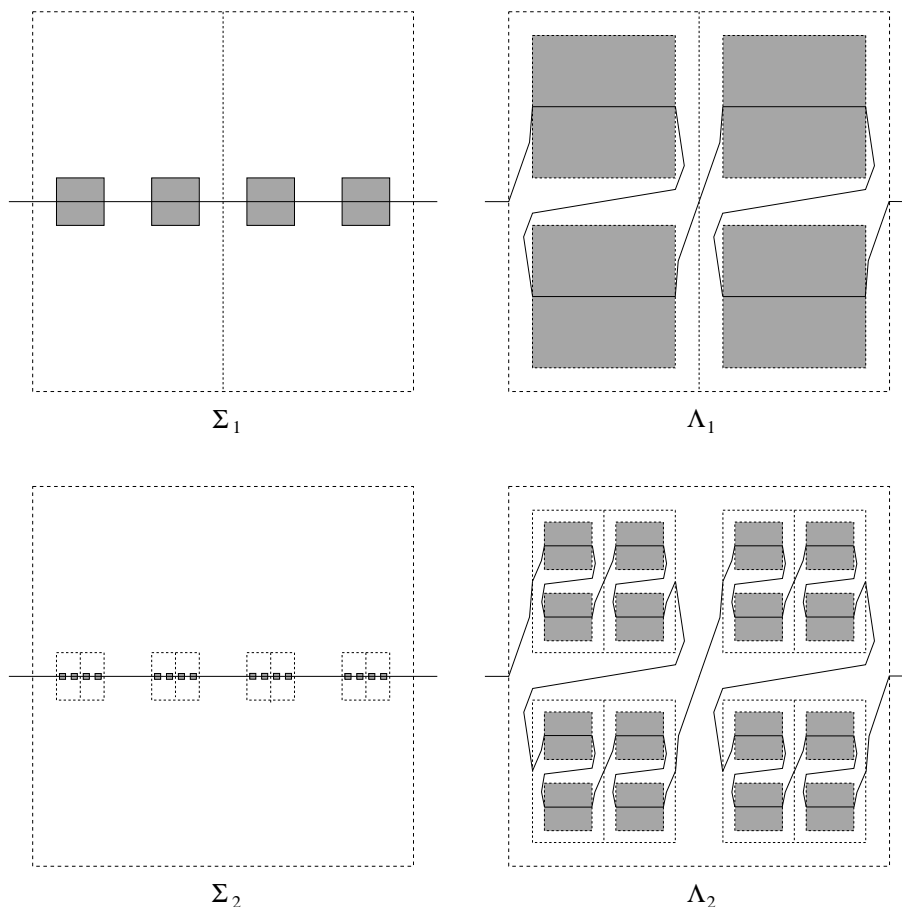

FIGURE 4. First two steps in the construction of the map  $\varphi$ . The solid arcs on the right are  $\varphi_n([0, 1])$  for  $n = 1, 2$ .

#### REFERENCES

- [A] L. Ahlfors, *Lectures on quasiconformal mappings*, Van Nostrand, 1966.
- [AB] L. Ahlfors and L. Bers, *Riemann mapping's theorem for variable metrics*, *Annals of Math.* **72** (1960) 385-404.
- [As] K. Astala, *Area distortion of quasiconformal mappings*, *Acta Math.* **173** (1994) 37-60.
- [D] G. David, *Solutions de l'equation de Beltrami avec  $\|\mu\|_\infty = 1$* , *Ann. Acad. Sci. Fenn. Ser. A I Math.* **13** (1988) 25-70.
- [GV] F. Gehring, J. Väisälä, *Hausdorff dimension and quasiconformal mappings*, *J. London Math. Soc.* **6** (1973) 504-512.
- [LV] O. Lehto, K. Virtanen, *Quasiconformal mappings in the plane*, Springer-Verlag, 1973.
- [M] P. Mattila, *Geometry of Sets and Measures in Euclidean spaces*, Cambridge University Press, 1995.
- [PZ] C. L. Petersen, S. Zakeri, *On the Julia set of a typical quadratic polynomial with a Siegel disk*, Stony Brook IMS preprint 2000/6, submitted to *Annals of Math.*

- [T] P. Tukia, *Compactness properties of  $\mu$ -homeomorphisms*, Ann. Acad. Sci. Fenn. Ser. A I Math. **16** (1991) 47-69.

S. ZAKERI, DEPARTMENT OF MATHEMATICS, UNIVERSITY OF PENNSYLVANIA, PHILADELPHIA  
19104-6395, USA

*E-mail address:* `zakeri@math.upenn.edu`