

Laminar free hyperbolic 3-manifolds

Sérgio R. Fenley *

October 30, 2018

1 Introduction

We analyse the existence question for essential laminations in 3-manifolds. The purpose of the article is to prove that there are infinitely many closed hyperbolic 3-manifolds which do not admit essential laminations. This answers in the negative a fundamental question posed by Gabai and Oertel when they introduced essential laminations in [Ga-Oe], see also [Ga4, Ga5]. The proof is obtained by analysing certain group actions on trees and showing that certain 3-manifold groups only have trivial actions on trees. There are corollaries concerning the existence question for Reebless foliations and pseudo-Anosov flows.

This article deals with the topological structure of 3-manifolds. Two dimensional manifolds are extremely well behaved in the sense that the universal cover is always either the plane or the sphere (for closed manifolds), the fundamental group determines the manifold and many other important properties. Similarly for a 3-manifold one asks: When is the universal cover \mathbf{R}^3 ? When does the fundamental group determine the manifold? Are homotopic homeomorphisms always isotopic? An obvious necessary condition is that the manifold be *irreducible*, that is, every embedded sphere bounds a ball. As for 2-manifolds, the existence of a compact codimension one object which is topologically good is extremely useful. A properly embedded 2-sided surface not $\mathbf{S}^2, \mathbf{D}^2$ is *incompressible* if it injects in the fundamental group level [He]. A compact, irreducible manifold with an incompressible surface is called *Haken*. Fundamental work of Haken [Hak1, Hak2] and Waldhausen [Wa] shows that Haken manifolds have fantastic properties, answering in the positive the 3 questions above.

But how common are Haken 3-manifolds, that is how common are incompressible surfaces amongst irreducible 3-manifolds? In some sense they are not very common. Recall that *Dehn surgery* along an orientation preserving simple closed curve δ is the process of removing a tubular neighborhood $N(\delta)$ (a solid torus) and glueing back by a homeomorphism of the boundary - which is a two dimensional torus T_1 [Rol, Bu-Zi]. The surgered manifold is completely determined by which simple closed curve in T_1 becomes the new *meridian*, that is, which curve of T_1 is glued to the null homotopic curve in the boundary of $N(\delta)$. Hence this is parametrized by a pair of relatively prime integers (q, p) , corresponding to the description of simple closed curves in T_1 . When viewed this way, this set of relatively prime (q, p) is the *Dehn surgery space* - a subset of $\mathbf{Z}^2 \subset \mathbf{R}^2$. The same can be done iterating the process doing Dehn surgery on links [He, Rol, Bu-Zi]. Notice that all closed, orientable 3-manifolds can be obtained from \mathbf{S}^3 by some Dehn surgery on an appropriate link in \mathbf{S}^3 [Rol]. So one can interpret how common a property is by verifying how many of the Dehn surgered manifolds have that property. Along these lines some of the many results on incompressible surfaces are: If K is a two bridge knot in \mathbf{S}^3 then almost all Dehn surgeries on K yield manifolds without incompressible surfaces [Ha-Th]. The same is true for any knot K in a manifold M so that $M - K$ does not have any closed incompressible surfaces [Hat1]. Notice that there are also results on the other direction: for example Oertel [Oe] proved that for many star links in \mathbf{S}^3 , then any non trivial Dehn surgery yields a manifold with incompressible surfaces. There are similar results for Montesinos knots [Ha-Oe]. Basically a lot of it depends on whether the complement has closed

*Research partially supported by NSF grant DMS 0296139.

incompressible surfaces or not. In many cases the complement does not have such surfaces, yielding the non existence results for most Dehn surgered manifolds.

This amongst other reasons led to the concept of an essential lamination as introduced by Gabai and Oertel in the seminal paper [Ga-Oe] of the late 80's. A *lamination* is a foliation of a closed subset of the manifold. Roughly a lamination in a closed 3-manifold is *essential* if it has no sphere leaves or tori leaves bounding solid tori, the complement of the lamination is irreducible and the leaves in the boundary of the complement are incompressible and end incompressible in their respective complementary components [Ga-Oe]. Gabai and Oertel proved the fundamental result that essential laminations have deep consequences: the manifold M is irreducible, its universal cover is \mathbf{R}^3 , leaves of the lamination inject in the fundamental group level, efficient closed transversals are not null homotopic; amongst other consequences [Ga-Ka3]. In addition manifolds with *genuine* essential laminations satisfy the weak hyperbolization conjecture [Ga-Ka4]: either there is a $\mathbf{Z} \oplus \mathbf{Z}$ subgroup of the fundamental group or the fundamental group is Gromov hyperbolic [Gr, Gh-Ha]. Genuine means that not all complementary regions are I -bundles, or equivalently it is not just a blow up of a foliation. Brittenham also proved properties concerning homotopy equivalences for manifolds with essential laminations [Br2].

In addition essential laminations are extremely common: For example if K is a non trivial knot in \mathbf{S}^3 then off of at most two lines and a couple of points in Dehn surgery space, the surgered manifold contains an essential lamination. This is obtained as follows: first Gabai constructed a Reebless foliation \mathcal{F} in $(\mathbf{S}^3 - N(K))$ which is transverse to the boundary [Ga1, Ga2, Ga3]. Reebless means it does not have a Reeb component: a foliation of the solid torus with the boundary being a leaf, all other leaves are planes spiralling to the boundary [Re, No]. Then results of Mosher, Gabai [Mo2] show that either there is an incompressible torus transverse to \mathcal{F} or there is an essential lamination in $\mathbf{S}^3 - N(K)$ with solid torus complementary regions. This lamination remains essential off of at most two lines in Dehn surgery space [Mo2] - see more on solid torus complementary regions later. Also Brittenham produced examples of essential laminations which remain essential after all non trivial Dehn surgeries [Br3, Br4]. Roberts has also obtained many important existence results concerning alternating knots in the sphere [Ro1, De-Ro] (partly jointly with Delman) and punctured surface bundles [Ro2, Ro3].

So succesful was the search for essential laminations that at first one might wonder whether all manifolds that can (irreducible, with infinite fundamental group), in fact do admit essential laminations. Given that an incompressible torus is an essential lamination, the Geometrization conjecture [Th2] suggests that one should only have to analyse Seifert fibered spaces and hyperbolic manifolds [Sc, Th2].

The situation for Seifert fibered spaces has been resolved: Brittenham produced examples of Seifert fibered spaces which are irreducible, have infinite fundamental group, universal cover \mathbf{R}^3 , but which do not have essential laminations [Br1]. Naimi [Na], using work of Bieri, Neumann and Strebel [BNS], completely determined which Seifert fibered manifolds admit essential laminations.

For hyperbolic 3-manifolds there were two fundamental open questions: 1) (Thurston) Does every closed hyperbolic 3-manifold admit a Reebless foliation? 2) (Gabai-Oertel [Ga-Oe], see also [Ga4, Ga5]) Does every closed hyperbolic 3-manifold admit an essential lamination? In the past year question 1) was answered in the negative by Roberts, Shareshian and Stein [RSS] who produced infinitely many counterexamples. The goal of this article is to answer question 2) in the negative. We now proceed to describe the examples.

Basically one starts with a torus bundle M over the circle and do Dehn surgery on a particular closed curve. Let ϕ be the monodromy of the fibration associated to a 2 by 2 integer matrix A , so that A is hyperbolic. Let R be a fiber which is a torus. There are two foliations in R which are invariant under the monodromy ϕ , the stable and unstable foliations. The suspension flow in M induces two foliations in M with leaves being planes, annuli and Möebius bands. Suppose there is a Möebius band leaf. Blow up that leaf, producing a lamination with a solid torus complementary component with closure a solid torus with core δ and with some curves η removed from the boundary. The curves η are called the *degeneracy locus* of the complementary region of the lamination [Ga-Ka1]. One can think of η as lying in the boundary of $N(\delta)$, which is a two dimensional torus. Let $(1,0)$ be the curve in $\partial N(\delta)$ which bounds

the fiber in $M - N(\delta)$. Under an appropriate choice for the curve $(0, 1)$ of $\partial N(\delta)$ then η is represented by $(1, 2)$. Do Dehn surgery along δ . If ξ is the new meridian (the Dehn surgery slope), then results of essential laminations [Ga-Oe, Ga-Ka1] show that λ remains essential in the Dehn surgery manifold M_ξ if the intersection number of ξ and η is at least 2 in absolute value. If ξ is described as (q, p) then this is equivalent to $|p - 2q| \geq 2$. Therefore the open cases for essential laminations are $|p - 2q| \leq 1$.

For simplicity of notation we omit the explicit dependence of M on ϕ . It is always understood that M depends on the particular ϕ .

In a beautiful and fundamental result, Hatcher [Hat2], showed that if $p < q$ then the Dehn surgery manifold $M_\xi = M_{p/q}$ has a Reebless foliation. This is done via an explicit construction involving train tracks and branched surfaces. In the last year Roberts, Shareshian and Stein considered a particular type of monodromy, namely generated by the matrix

$$A = \begin{bmatrix} m & -1 \\ 1 & 0 \end{bmatrix} \quad m \leq -3$$

The eigenvalues of A are negative. Consider the point $(0, 0)$ in \mathbf{R}^2 and its projection O to the fibering torus R . Let δ be the closed orbit of the suspension flow through O . Because the eigenvalues are negative, the leaf of the stable foliation through O is a Möbius band. When it is blown open into an annulus the degeneracy locus is $(1, 2)$ as described above. In a groundbreaking work, Roberts, Shareshian and Stein [RSS] considered Dehn surgery on these manifolds and proved a wonderful result: if p is odd, m is odd and $p \geq q$ then $M_{p/q}$ does not admit Reebless foliations. In this article we consider a subclass of these manifolds and show they do not admit essential laminations:

Main Theorem: Let M be a torus bundle over the circle with monodromy induced by the matrix A above. Let δ be the orbit of the suspension flow coming from the origin and $M_{(q,p)} = M_{p/q}$ be the manifold obtained by (q, p) Dehn surgery on δ . Here $(1, 0)$ bounds the fiber in $M - N(\delta)$ and $(1, 2)$ is the degeneracy locus. Then if $m \leq -4$ and $|p - 2q| = 1$, the manifold $M_{p/q}$ does not admit essential laminations.

The manifold $M - \delta$ is atoroidal [Th4, Bl-Ca] and fibers over the circle with fiber a punctured torus. By Thurston's hyperbolization theorem in the fibering case $M - \delta$ has a complete hyperbolic structure of finite volume [Th3]. By Thurston's Dehn surgery theorem $M_{p/q}$ is hyperbolic for almost all p/q [Th1]. Therefore:

Corollary: There are infinitely many closed, hyperbolic 3-manifolds which do not admit essential laminations.

We mention that Calegari and Dunfield [Ca-Du] approached the existence problem from a different point of view. Following ideas and results of Thurston [Th5, Th6] concerning the universal circle for foliations they showed that a wide class of essential laminations also possess a universal circle. One consequence is that tight essential laminations with torus guts (see [Ca-Du] for definitions) have universal circles. Hence the fundamental groups act on the circle. Under certain conditions and if the fundamental group is orderable then the action lifts to a non trivial action in \mathbf{R} and they obtain nonexistence results for these types of laminations. See more below.

Another immediate corollary is:

Corollary: If $m \leq -4$ and $|p - 2q| = 1$, then the manifolds $M_{p/q}$ above do not admit Reebless foliations.

About half of this result has already been established by Roberts, Stein and Shareshian [RSS], namely the situation when m is odd. See more on m odd below. Another consequence is:

Corollary: If $m \leq -4$ and $|p - 2q| = 1$ then $M_{p/q}$ does not admit pseudo-Anosov flows.

For basic definitions and properties of pseudo-Anosov flows consult [Mo1, Mo2]. This result provides infinitely many hyperbolic manifolds without pseudo-Anosov flows. We stress that Calegari and Dunfield [Ca-Du] previously obtained conditions implying manifolds do not admit pseudo-Anosov flows and showed for example that the Weeks manifold does not admit pseudo-Anosov flows.

We remark that Dehn surgery on torus bundles over the circle has been widely studied, for example: a) Which surgered manifolds have incompressible surfaces [Fl-Ha, CJR], b) Virtual homology [Bk1, Bk2], c) geometrization [Jo, Th1, Th2, Th3, Th4].

We now describe the key ideas of the proof of the main theorem. The proof is done by looking at group actions on trees. For simplicity first consider the case of a Reebless foliation \mathcal{F} . Novikov proved that leaves are incompressible and transversals are never null homotopic [No]. Hence the lift to the universal cover $\tilde{\mathcal{F}}$ is a foliation by planes and its leaf space is a simply connected 1-dimensional manifold, which may not be Hausdorff. This 1-manifold can be collapsed to a tree. The fundamental group acts on this tree. Roberts et al analysed group actions on simply connected non Hausdorff 1-manifolds and also on trees – under the conditions $p \geq q$ and p, m odd, they ruled out the existence of Reebless foliations [RSS]. Notice that the leaf space of the lifted foliation $\tilde{\mathcal{F}}$ is an orientable object and it makes sense to talk about orientation preserving homeomorphisms. In order to stay in the orientation preserving world they restricted to p, m odd.

Now consider an essential lamination λ . The results of Gabai and Oertel [Ga-Oe] imply that the lift to the universal cover $\tilde{\lambda}$ is a lamination by planes in \tilde{M} . To get the leaf space blow down closures of complementary regions to points and also non isolated leaves (on both sides) to points. This produces an order tree as defined by Gabai-Kazez [Ga-Ka2] also called a non Hausdorff tree in this situation [Fe]. A further appropriate collapsing of the (possible) non Hausdorff points yields an actual tree where the group acts non trivially. The strategy is to show there are no nontrivial actions of the group on trees. An action is *trivial* if it has a global fixed point. A crucial difference from the case of foliations is that in the case of laminations the tree does not have an orientation in general. Hence orientation dependent arguments cannot be used. This was very important and widely used in [RSS]. Since we do not have an orientation here, the condition m odd does not play a role, which allows us to consider m even as well. Notice that the condition $|p - 2q| = 1$ obviously implies that p is odd. On the other hand there are many examples with p even so that $M_{p/q}$ has a Reebless foliation - for example $p = 4, q = 1$ or $p = 8, q = 3$ (this has $p > q!$). So to rule out Reebless foliations, some further condition on p, q should be necessary when p is even. Except for ruling out trivial actions, the proof here is done entirely in the tree – we never go back to the original non Hausdorff tree. For the sake of completeness we state this result from which the main theorem is an easy corollary:

Theorem: Let $M_{p/q}$ be the manifold described above. If $m \leq -4$ and $|p - 2q| = 1$, then every action of $\pi_1(M_{p/q})$ on a tree is trivial.

The fundamental group of $M_{p/q}$ denoted by \mathcal{G} can be generated by two elements α and τ . Actions of a homeomorphism on a tree are easy to understand: either there is a fixed point or in the free case there is an invariant axis. An axis is a properly embedded copy of the reals where the homeomorphism acts by translation. The proof breaks down as to whether the generators above act freely or not yielding 3 main cases to consider (when τ acts freely it does not matter the behavior of α). The proof subdivides into various subcases. Invariably the analysis goes like this: apply a certain relation in the group to a well chosen point. One side of the relation implies the image of the point is in a certain region of the tree while the other side of the relation implies it is in a different region - contradiction! An important idea is that of a *local axis*, which has all the properties of axis except perhaps being properly embedded. Homeomorphisms with fixed points may have local axes. This is extremely useful in a variety of cases.

We note that \mathbf{Z} actions on non Hausdorff trees had been previously analysed in [Fe] and [Ro-St1, Ro-St2], with consequences for pseudo-Anosov flows [Fe] and Seifert fibered spaces [Ro-St1, Ro-St2].

There is a large literature of group actions on trees which were brought to the forefront by Serre's fundamental monograph [Se]. The analysis usually involve a metric which is invariant under the actions [Mo-Sh1, Mo-Sh2, Mo-Sh3] or actions on simplicial trees [Se]. We stress that the tree involved in here is not simplicial and it is not presented in general with a group invariant metric – unless there is a holonomy invariant transverse measure of full support in the lamination, e.g when there is an incompressible surface. So the proof is entirely topological and in that sense elementary. The topology of the manifold, particularly the condition $|p - 2q| = 1$ plays a crucial role. Notice that in the foliations case there is a pseudo-metric lying in the background which is used from time to time in the proof by Roberts et al [RSS]. The pseudometric distance between two points measures how many jumps between non separated points are necessary to go from one point to the other. This pseudometric was analysed and used previously by Barbot in [Ba1, Ba2] with consequences for foliations.

The results of this article mean that the search for structures more general than essential laminations, but still useful takes an added relevance. One idea previously proposed by Gabai [Ga5] is that of a *loosesse lamination*. We will have more comments on that in the final remarks section.

We are very thankful to Rachel Roberts who introduced the idea of considering group actions in the foliations case and other ideas.

2 The group

Here we compute the fundamental group of $M_{p/q}$. Start with M the torus bundle over the circle with monodromy induced by

$$A = \begin{bmatrix} m & -1 \\ 1 & 0 \end{bmatrix} \quad \text{where } m \leq -3$$

For notational simplicity the dependence of M on A is omitted.

The eigenvalues of A are

$$\frac{m \pm \sqrt{m^2 - 4}}{4}$$

which are both negative and the matrix is hyperbolic. The eigenvector directions produce two linear foliations in \mathbf{R}^2 with irrational slope and invariant under A . They induce two foliations in the torus T^2 . Since A is integral it induces a homeomorphism ϕ of T^2 , which leaves the foliations invariant. Let O in T^2 be the image of the origin. Let M be the suspension of ϕ and let \mathcal{F} be (say) the suspension of the stable foliation of T^2 . Then \mathcal{F} has leaves which are planes, annuli and Möebius bands. Identify T^2 with a fiber in M and let δ be the orbit through O , which is a closed orbit intersecting T^2 once. Since the eigenvalues of A are negative, the stable leaf containing δ is a Möebius band. We do Dehn surgery on δ . We first determine the fundamental group of $M - N(\delta)$. To do that let

$$D = N(\delta) \cap T^2 \text{ (a disk), } \quad V = T^2 - D \text{ (a punctured torus).}$$

Choose a basis for the homology of $\partial N(\delta) = T_1$, a torus. Let $(1, 0)$ be the curve in T_1 bounding the fiber V of $M - N(\delta)$. Blow up the leaf of \mathcal{F} through δ . It blows to a single annulus and the complementary region is a solid torus with core δ . The closure of the complementary region is a solid torus with a closed curve in the boundary removed. The removed curve is the degeneracy locus of the complementary component [Ga-Ka1]. Since the leaf of \mathcal{F} was a Möebius band, the degeneracy locus intersects the curve $(1, 0)$ twice. Choose the curve $(0, 1)$ so that the degeneracy locus is the curve $(1, 2)$ in this basis. Let $M_{p/q}$ be the manifold obtained from M by doing (q, p) Dehn surgery on δ . By results about essential laminations, the lamination λ remains essential in $M_{p/q}$ if $|p - 2q| \geq 2$. Let γ be the curve $(0, 1)$ in T_1 and τ be the curve $(1, 0)$. The degeneracy locus is the curve $\gamma\tau^2$. Notice there are two tori here: one which is a fiber of the original fibration (here denoted by T^2), another which is the boundary of $N(\delta)$ (here denoted by T_1). The Dehn surgery coefficients refer to T_1 .

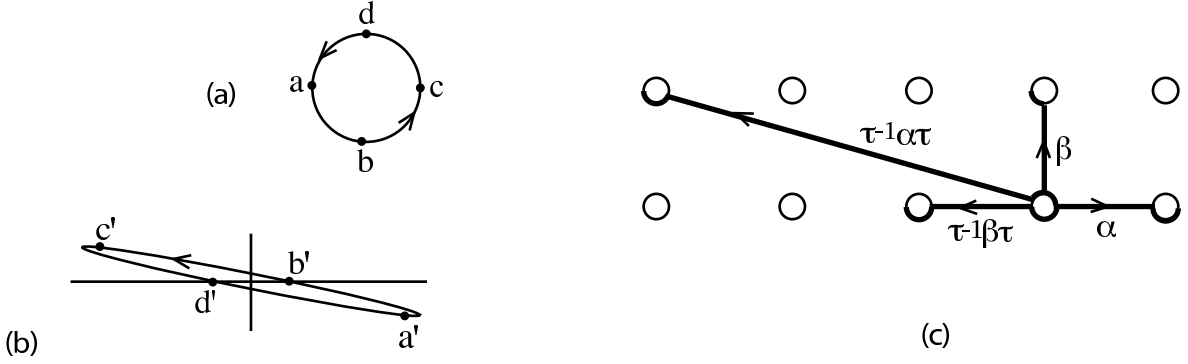

Figure 1: *Computing the fundamental group of $M - N(\delta)$.*

Suppose the disk D above is a round disk of radius ϵ sufficiently small. The universal abelian cover of $T^2 - D$ is the plane with disks of radius ϵ around integer lattice points removed. Let E be the one around the origin. We pick 4 points in ∂E : $a = (-\epsilon, 0), b = (0, -\epsilon), c = (\epsilon, 0)$ and $d = (0, \epsilon)$, see fig. 1, a. Let a' be the image of a under A , etc., see fig. 1, b.

The image of ∂E under A is an ellipse which can be deformed back to ∂E , see fig. 1, b. Notice b', d' are in the x axis and $d' = a$.

Let the image of a in $T^2 - D$ be the basepoint of the fundamental group of $M - N(\delta)$ for simplicity still denoted by a and likewise for b, c, d . Let l be an arc along the image of ∂E under A , going counterclockwise from d' to a' .

We pick a basis for $\pi_1(T^2 - D)$: Let $\alpha = \overline{ac} * l_1$ (see fig. 1, c) where the arc $\overline{ac} \subset \partial E$ is traversed in the counterclockwise direction and l_1 is parametrized as $\{(t, 0) \mid \epsilon \leq t \leq 1 - \epsilon\}$. Here $*$ denotes concatenation of arcs. Let also

$$\beta = \overline{ad}_{clo} * l_2 * \overline{ba}_{clo},$$

where l_2 is parametrized as $\{(0, t) \mid \epsilon \leq t \leq 1 - \epsilon\}$, and the “clo” subscript means the arcs are traversed clockwise in ∂E . We identify α and β with their images in $T_2 - D$, so they generate the fundamental group of $T_2 - D$. It is easy to see that the curve $\gamma = [\alpha, \beta]$ is just an counterclockwise turn around ∂E . Then

$$\tau^{-1}\alpha\tau = l * \overline{a'c'} * l'_1 * l^{-1}.$$

The composition $l * \overline{a'c'}$ is roughly one counterclockwise turn around ∂E so it is the curve γ . The straight arc l'_1 goes from $c' = (m\epsilon, \epsilon)$ to $(m(1 - \epsilon), 1 - \epsilon)$ - roughly going one step up and $|m|$ steps to the left. This together with l^{-1} can be isotoped to $\beta\alpha^m$ (where we are identifying α, β with the appropriate covering translates). We conclude that $\tau^{-1}\alpha\tau = \gamma\beta\alpha^m$. Similarly

$$\tau^{-1}\beta\tau = l * \overline{a'd'}_{clo} * l'_2 * \overline{b'a'}_{clo} * l^{-1}$$

So in the same way it is easy to see that $\tau^{-1}\beta\tau = \alpha^{-1}$. Notice that α, τ generate $\pi_1(M - N(\delta))$. Hence

$$\pi(M - N(\delta)) = \{ \alpha, \tau \mid \tau^{-1}\alpha\tau = \gamma\beta\alpha^m, \tau^{-1}\beta\tau = \alpha^{-1}, \gamma = [\alpha, \beta] \}$$

After (q, p) Dehn surgery on δ we obtain $q\gamma + p\tau$ is the new meridian or $\tau^p\gamma^q = 1$. Hence

$$\mathcal{G} = \pi_1(M_{p/q}) = \{ \alpha, \tau \mid \tau^{-1}\alpha\tau = \gamma\beta\alpha^m, \tau^{-1}\beta\tau = \alpha^{-1}, \gamma = [\alpha, \beta], \tau^p\gamma^q = 1 \}$$

In the proof we will use these and the following variations of these relations extensively:

$$\tau^{-1}\beta\tau = \alpha^{-1}, \tau\alpha\tau^{-1} = \beta,$$

$$\tau^{-1}\alpha\tau = \gamma\beta\alpha^m = \alpha\beta\alpha^{m-1} = \alpha\tau\alpha^{-1}\tau^{-1}\alpha^{m-1}$$

$$\alpha\tau = \tau\gamma\beta\alpha^m = \tau\alpha\beta\alpha^{m-1}$$

$$\alpha\beta = \gamma\beta\alpha, \quad \text{or} \quad \alpha\tau\alpha^{-1}\tau^{-1} = \tau\gamma\alpha^{-1}\tau^{-1}\alpha$$

A little manipulation with the relations also yields

$$\tau\beta\tau^{-1} = \beta\alpha\beta^{m-1} = \gamma^{-1}\alpha\beta^m$$

These and circular variations of these will be used throughout the article.

Since q, p are relatively prime there are e, f in \mathbf{Z} with $ep + fq = 1$. Let $\kappa = \tau^f\gamma^{-e}$. Then κ is a generator of the \mathbf{Z} subgroup of \mathcal{G} generated by τ, γ and $\tau = \kappa^q, \gamma = \kappa^{-p}$.

NOTATION: – In the arguments group elements act on the right.

3 Outline of the proof

Given the presentation of \mathcal{G} above the proof of the main theorem is broken into 4 cases:

- Case R - **R**-covered case
- Case A - τ acts freely
- Case B - α acts freely τ has a fixed point.
- Case C - α and τ have fixed points.

If μ acts freely on a tree, let \mathcal{A}_μ be its axis. If μ has a local axis, we denote it by $\mathcal{L}\mathcal{A}_\mu$. Unlike a true axis, a homeomorphism may have more than one local axis. The context will make it clear which one is being considered.

Case R – **R** covered case.

The **R**-covered case is simple. Given that p is odd, this implies that τ is orientation preserving in **R**. The case α orientation preserving is simple. The other case (which implies m is even) leads to $p > 3q$ which for our purposes is enough. It also leads us to move away from orientation preserving arguments, which is more like the laminations case. We note that there is an easy linear non trivial action on **R** when $p = 4, q = 1$. Notice that in this case p is even.

Case A – τ acts freely.

This implies that κ also acts freely and $\mathcal{A}_\kappa = \mathcal{A}_\tau$. We analyse how \mathcal{A}_κ intersects $\mathcal{A}_\kappa\alpha$ and other translates (here $\mathcal{A}_\kappa\alpha$ is the image of \mathcal{A}_κ under α). Let $u = \alpha\beta$. One uses the relation $\alpha\beta = \gamma\beta\alpha$ to analyse how \mathcal{A}_κ intersects $\mathcal{A}_\kappa u$ which breaks down into various cases as to whether this intersection is empty, a single point or a segment. One particularly tricky case needs the condition $m \neq -3$.

Case B – α acts freely, τ has a fixed point.

Let z be a fixed point of τ . First suppose that z is not in the axis \mathcal{A}_α of α . Suppose there is no fixed point of τ between z and \mathcal{A}_α . Here let \mathcal{U} be the component of $T - \{z\}$ containing \mathcal{A}_α . The case $\mathcal{U}\tau \neq \mathcal{U}$ is easy to deal with. It follows that $\mathcal{U}\tau = \mathcal{U}$ producing a local axis $\mathcal{L}\mathcal{A}_\tau$ of τ which is contained in \mathcal{U} and has one limit point in z . The proof breaks down as to whether $\mathcal{L}\mathcal{A}_\tau$ intersects \mathcal{A}_α or not. Empty intersections are easy to deal with, the other case being trickier.

Then suppose z is in \mathcal{A}_α . We remark this is a crucial case, because this is likely what happens for the essential laminations we know to exist when $|p - 2q| \geq 2$. These come from the original stable lamination on the fibering manifold. In that manifold, α acted freely and τ had a fixed point in \mathcal{A}_α . After the surgery α would still have at least a local axis, which contains a fixed point of τ . So one knows the exact condition $|p - 2q| = 1$ will have to be used here!

In this case consider \mathcal{U}_1 be the component of $T - \{z\}$ containing $z\alpha$ and \mathcal{U}_2 the one containing $z\alpha^{-1}$. It is easy to show that $\mathcal{U}_1\tau$ is not \mathcal{U}_1 and that $\mathcal{U}_1\tau$ is in fact equal to \mathcal{U}_2 . When $\mathcal{U}_1\tau^{-1} = \mathcal{U}_2$ then one produces a contradiction just using that p is odd. The case $\mathcal{U}_1\tau^{-1} \neq \mathcal{U}_2$ or $\mathcal{U}_2\tau \neq \mathcal{U}_1$ is much more interesting. Here the exact condition $|p - 2q| = 1$ is used to show it would imply $\mathcal{U}_1\tau = \mathcal{U}_1$ which was disallowed at the beginning. This actually has connections with the topology of the situation, see detailed explanation in section 7. This is a crucial part of the proof. One very tricky issue is that a priori z is only a fixed point of τ and not of γ – part of the proof is ruling this out.

Case C

Generally an axis is good because it gives information about where points go. The case of fixed points is trickier and one many times searches for local axis.

Given two points a, b in a tree let $[a, b]$ be the unique embedded segment connecting them. Let $(a, b) = [a, b] - \{a, b\}$. Notice (a, b) is exactly the set of points in the tree separating a from b .

Here let s be a fixed point of κ and w a fixed point of α so that there is no fixed point of either in (s, w) . Notice there may be fixed points of τ in (s, w) ! Let \mathcal{W} be the component of $T - \{s\}$ containing w and \mathcal{V} the component of $T - \{w\}$ containing s . The first part of the proof shows that $\mathcal{W}\tau = \mathcal{W}$ and $\mathcal{V}\alpha = \mathcal{V}$. These are moderately involved cases. This immediately produces a local axis $\mathcal{L}\mathcal{A}_\alpha$ of α contained in \mathcal{V} and with one ideal point w . One does not have yet a local axis for τ because we do not know a priori that τ has no fixed points in (s, w) . Some technical complications ensue.

One then shows that $s\alpha, s\alpha^{-1}$ are in \mathcal{W} . Let z be the fixed point of τ in $[s, w)$ which is closest to w – z could be s . Using the previous results show that the component \mathcal{U} of $T - \{z\}$ containing w is invariant under τ . Now this produces a local axis $\mathcal{L}\mathcal{A}_\tau$ of τ in \mathcal{U} with ideal point z and some further properties. One then shows that w is not in $\mathcal{L}\mathcal{A}_\tau$ and z not in $\mathcal{L}\mathcal{A}_\alpha$.

We are now in familiar ground. If $\mathcal{L}\mathcal{A}_\alpha \cap \mathcal{L}\mathcal{A}_\tau$ has at most one point, then it is easy. When $\mathcal{L}\mathcal{A}_\alpha \cap \mathcal{L}\mathcal{A}_\tau$ has more than one point we use arguments done in case B – this part of the arguments in case B is done in more generality using local axis (rather than axis as needed in case B) and can be used in case C as well. This finishes the proof of case C. This finally yields the proof of the main theorem.

The arguments in this article are very involved. One possibility to read the article and get a quick grasp of the proof is to first analyse the \mathbf{R} -covered proof. Then go to the proof of case B.2 – α acts freely and τ has a fixed point in the axis of α – this case admits essential laminations if $|p - 2q| \geq 2$ and the topology can be detected. Then read the proof of τ acts freely and the other proofs.

4 Preliminaries

Let λ be an essential lamination on a 3-manifold N . We'll modify λ if necessary to eventually obtain a group action on a tree which is essentially the leaf space of the lifted lamination $\tilde{\lambda}$ to the universal cover \tilde{N} . First if there are any leaves of λ which are isolated on both sides, then blow each of them into an I -bundle of leaves – needs to be done at most countably many times. Now $\tilde{\lambda}$ is a lamination by planes with no leaves isolated on both sides [Ga-Oe].

Suppose L is a leaf of $\tilde{\lambda}$ which is non separated from another leaf F – that is, there are L_i leaves of $\tilde{\lambda}$ with L_i converging to both L and F . We do not want that L is not separated from some other leaf in the other side (the one not containing F). If that happens, blow up L into an I -bundle of leaves. This can also be achieved by a blow up in λ . Since there are at most countably many leaves non separated from some other leaf we can get rid of leaves non separated from leaves on both sides. If needed use blow ups so that non separated leaves of $\tilde{\lambda}$ are not boundary leaves of a complementary region of $\tilde{\lambda}$ (on the

opposite side). After all these possible modifications assume this is the original lamination λ .

Now define a set T_* whose elements are: closures of complementary components of $\tilde{\lambda}$ and also leaves of $\tilde{\lambda}$ which are non isolated on both sides. Then T_* is an *order tree* [Ga-Ka2, Ro-St2], also called non Hausdorff tree [Fe]. The fundamental group $\pi_1(N)$ naturally acts on T_* . If e is any point of T_* which is non separated another point e' , collapse all points non separated from e together with e . This is OK since no such e is non separated on more than one side and e also does not come from a complementary region of $\tilde{\lambda}$. The collapsed object is now an actual tree T and the action of $\pi_1(N)$ on T_* induces a natural action of $\pi_1(N)$ on T . In our proof $N = M_{p/q}$ and we will analyse group actions of $\mathcal{G} = \pi_1(M_{p/q})$ on the tree T .

Definition 4.1. *A group action on a tree T is nontrivial if no point of T is fixed by all elements of the group.*

A lot of results on group actions on trees are to rule out non trivial group actions [Cu-Vo].
Given point a, b on a tree T let

$$(a, b) = \{c \in T \mid c \text{ separates } a \text{ from } b\}.$$

If $a = b$, then (a, b) is empty, otherwise it is an open segment. Let $[a, b]$ be the union of (a, b) and $\{a, b\}$. Then $[a, b]$ is always a closed segment.

One fundamental concept here is the following:

Definition 4.2. *(bridge) If x is a point of a tree T not contained in a connected set B , then there is a unique embedded path $[x, y]$ from x to B . This path has $(x, y) \cap B = \emptyset$ and either y is in B or y is an accumulation point of B . We say that $[x, y]$ is the bridge from x to B and if y is in B we say that x bridges to B in y or that x bridges to y in B .*

For example if T is the reals and $B = (0, 1)$, $x = 2$, then the bridge from x to B is $[2, 1]$. One common use of bridges will be: if x is not in a properly embedded line l (as an axis defined below) let $[x, y]$ be the bridge from x to l . The crucial property of the bridge is that given x and B , the bridge is unique. In various situations this will force some useful equalities of points. Another fundamental concept is:

Definition 4.3. *(axis) Suppose that g is a homeomorphism acting freely on a tree T . Then g has an axis \mathcal{A}_g , a properly embedded line in T , invariant under g and g acts by translations on \mathcal{A}_g .*

This is classical. Here y is in \mathcal{A}_g if and only if yg is in (y, yg^2) , that is yg separates y from yg^2 . Then it is easy to see that the axis must be the union of $[yg^i, yg^{i+1}]$ where $i \in \mathbf{Z}$ [Ba1, Fe]. To obtain an element in \mathcal{A}_g consider any $x \in T$. If $xg \in (x, xg^2)$ done. Else there is a unique

$$y \in [x, xg] \cap [x, xg^2] \cap [xg, xg^2].$$

y is the basis of the tripod with corners x, xg, xg^2 [Gr, Gh-Ha]. A simple analysis of cases using free action yields y is in the axis.

Another simple but fundamental concept for us is:

Definition 4.4. *(local axis) Suppose l is a line in a tree T where a homeomorphism g acts by translation. Then l is a local axis for g and is denoted by $\mathcal{L}\mathcal{A}_g$. The local axis may not be unique, the context specifies which one we refer to.*

For example if g acts in \mathbf{R} by $xg = 2x$, then $\mathbf{R}_+, \mathbf{R}_-$ are both local axes of g with accumulation point $x = 0$. Another characterization of local axis: x is in a local axis of g if and only if xg separates x from xg^2 (same definition as for axis except requiring that g acts freely). Another characterization: suppose xg is not x and let \mathcal{U} be the component of $T - \{x\}$ containing xg . Then x is in a local axis of g if and only if $\mathcal{U}g \subset \mathcal{U}$.

Let x be a point in a tree T . A *prong* at x is a non degenerate segment I of T so that x is one of the endpoints of I . Two prongs at x are equivalent if they share a subprong at x . Associated to a subprong I at x there is a unique component \mathcal{U} of $T - \{x\}$ containing $I - \{x\}$.

Notation – If x, y, z are elements in a tree we will write $x \prec y \prec z$ if y separates x from z , or y is in (x, z) . We say that x, y, z (in this order) are *aligned*. Also $x \prec y \preceq z$ if one also allows $y = z$ and so on. Notice that this is invariant under homeomorphisms of the tree.

The following simple results will be very useful:

Lemma 4.5. *Let x be a point in a tree T . Then two prongs I_1, I_2 at x are equivalent if and only if the associated complementary components $\mathcal{U}_1, \mathcal{U}_2$ are the same.*

Proof. If I_1, I_2 are equivalent, there is y in $I_1 - \{x\}$ also in I_2 . Then clearly $y \in \mathcal{U}_1$ and $y \in \mathcal{U}_2$, so $\mathcal{U}_1 = \mathcal{U}_2$. Conversely suppose $\mathcal{U}_1 = \mathcal{U}_2$. If I_1 is not equivalent to I_2 , then $I_1 \cap I_2 = \{x\}$ because T is a tree and it also follows that x separates I_1 from I_2 . This would imply $\mathcal{U}_1, \mathcal{U}_2$ disjoint, contradiction. \square

Lemma 4.6. *Let T be a tree and η a homeomorphism so that there are two points x, y of T so that $x \prec x\eta \prec y \prec y\eta$ or $x \prec y \prec x\eta \prec y\eta$. Then x and y are in a local axis of η .*

Proof. We do the proof for the first situation, the other being very similar. Let \mathcal{U} be the component of $T - \{x\}$ containing $x\eta$. Using $x \prec x\eta \prec y$ this is also the component of $T - \{x\}$ containing y . Apply η , then \mathcal{U} is taken to the component of $T - \{x\eta\}$ containing $y\eta$. Then $\mathcal{U}\eta$ is contained in \mathcal{U} and x is in a local axis. Apply η^{-1} to y to get y is in a local axis as well. We stress the two local axes produced in this way a priori may not be the same: there may be a fixed point of η in (x, y) . \square

Global fixed points

Here we consider the case that an essential lamination λ on N would produce a trivial group action on a tree T .

Recall the notion of *efficient* transversal to a lamination: let η be a transversal to a lamination λ . Then η is efficient [Ga-Oe] if for any subarc η_0 with both endpoints in leaves of λ and interior disjoint from λ , then η_0 is not homotopic rel endpoints into a leaf of λ . Gabai and Oertel showed that if λ is essential then any efficient transversal cannot be homotoped rel endpoints into a leaf of λ . Also closed efficient transversals are not null homotopic.

Lemma 4.7. *If λ is an essential lamination in N then the associated group action of $\pi_1(N)$ on a tree T as described above has no global fixed point.*

Proof. Suppose on the contrary that a point x of T is left invariant by the whole group. Look at the preimage of x in the possibly non Hausdorff tree T_* . There are 3 options:

1– x comes from a non singular, Hausdorff leaf E of $\tilde{\lambda}$. Then E is left invariant by the whole group $\pi_1(N)$,

2– x comes from the closure R of a complementary region of $\tilde{\lambda}$ in the universal cover. Then R is left invariant by the whole group. In this case let E be a boundary leaf of R .

3– Finally x may come from a non Hausdorff leaf E . Then the orbit of E under $\pi_1(N)$ consists only of the non separated leaves from E .

By construction of the tree T above these 3 cases are mutually exclusive. It follows that in any of the 3 options there is at least one component B of $\tilde{N} - E$ which does not contain any translate of E . In option 1) any component will do, in option 2) choose the component not containing $R - E$ and in option 3) choose the component not containing leaves non separated from E .

Let $A = \pi(E)$ where $\pi : \tilde{N} \rightarrow N$ is the universal covering map. Suppose first that A is not compact. Then it limits on some leaves of λ and there is a laminated box where A intersects it in at least 3 leaves and the box intersects an efficient transversal to λ . Lifting to \tilde{N} so that the middle leaf is E then the

other 2 leaves are not E (efficient transversal) and one of them is contained in B producing a covering translate of E in B , contradiction. The same is of course true if A intersects an efficient closed transversal.

Now A is compact. If A is non separating, then it intersects a closed transversal associated to g in $\pi_1(N)$ only once. Same proof yields either Eg or Eg^{-1} in B , done.

Finally suppose that A is separating. Then $C = \pi(B \cup E)$ is a compact submanifold of N which has A as its unique boundary component. For any g in $\pi_1(C)$ then Eg is contained in $B \cup E$, so by hypothesis must be E , therefore $\pi_1(A)$ surjects in $\pi_1(C)$. As λ is essential then $\pi_1(A)$ also injects [Ga-Oe], so $\pi_1(A)$ is isomorphic to $\pi_1(C)$. As C is irreducible [Ga-Oe], then theorem 10.5 of Hempel [He] implies that C is homomorphic to $A \times I$ with A corresponding to $A \times \{0\}$. This contradicts the fact that A is the only boundary component of C . This finishes the proof of the lemma. \square

Remark: – Notice that leaves of essential laminations may not intersect a closed transversal. For example this occurs for separating incompressible surfaces. It also occurs for leaves of Reebless foliations which have a separating leaf (which necessarily must be a torus or Klein bottle) – there are many examples of these. So Reebless foliations which are also essential laminations need not be taut foliations!

5 Case R – the **R**-covered case

For the remainder of the article we consider the manifold $M_{p/q}$ as described in section 2 with fundamental group \mathcal{G} . The goal is to show it does not admit an essential lamination. Suppose then on the contrary that there is an essential lamination λ on $M_{p/q}$. Let T be the associated tree with non trivial action of \mathcal{G} on it. Notice that since α, τ generate \mathcal{G} then no point of T is fixed by both α and τ .

The conditions on the parameters are $|p - 2q| = 1$ and $m \leq -4$. They will not be used in full force for all the arguments. Many times all we need is $p \geq q$ or p odd or m negative or none of these. The proof is done by subdividing into subcases and showing each subcase is impossible leading to various contradictions.

In this section we assume that T is homeomorphic to the real numbers and study non trivial actions of \mathcal{G} in **R**. Notice that γ being a commutator is an orientation preserving homeomorphism of **R**. Since $\tau^p \gamma^q = id$, then τ^p is also orientation preserving.

We use the relations from the group presentation of \mathcal{G} or variations thereof.

Suppose first the action is orientation preserving on **R**:

Case R.1 – α, τ are orientation preserving.

As $\beta = \tau \alpha \tau^{-1}$ then β also is orientation preserving and so is the whole group \mathcal{G} . We subdivide into subcases:

Case R.1.1 – τ has a fixed point x .

Then $x\alpha$ is not x . Orient **R** so that $x\alpha > x$. As γ is orientation preserving then $x\gamma = x$. Then applying $\gamma\tau\beta\alpha^m = \alpha\tau$ to x :

$$x\gamma\tau\beta\alpha^m = x\alpha\tau > x\tau = x$$

which uses τ orientation preserving. Hence $x\beta\alpha^m > x$ or $x\beta > x\alpha^{-m} > x$ (as $-m > 0$). Hence $x\beta^{-1} < x$. But also

$$x\beta^{-1} = x\tau\alpha\tau^{-1} = x\alpha\tau^{-1} > x\tau^{-1} = x.$$

This is a contradiction, ruling out this case.

Case R.1.2 – τ acts freely, α has a fixed point x .

Assume τ is increasing in **R**. As $\tau = \kappa^q$ and q is positive then κ is increasing. Here use $x\alpha\tau = x\tau = x\gamma\tau\beta\alpha^m$. Hence $x\tau\alpha^{-m} = x\gamma\tau\beta$. As $x\tau > x$ then $x\tau\alpha^{-m} > x$. Hence $x\gamma\tau > x\beta^{-1}$. Here $\gamma = \kappa^{-p}$ and $\gamma\tau = \kappa^{q-p}$. As $q \leq p$ then $q - p \leq 0$ and $\gamma\tau$ is monotone decreasing or constant. Hence

$$x\beta^{-1} < x\gamma\tau \leq x.$$

One fact that will be used in a lot of arguments is that under the condition $p \geq q$ when γ, τ act freely and $x\tau > x$ then $x\gamma \leq x\tau^{-1}$. Notice that $x\tau^{-1}\beta = x\alpha\tau^{-1} = x\tau^{-1}$. On the other hand

$$x\beta = x\alpha\beta = x\gamma\beta\alpha \leq x\tau^{-1}\beta\alpha = x\tau^{-1}\alpha < x\alpha = x.$$

leading to the contradiction that both $x\beta$ and $x\beta^{-1}$ are $< x$.

Notice a lot of these arguments are using orientation preserving homeomorphisms.

Case R.1.3 – τ acts freely increasing in **R** and α acts freely, also increasing in **R**.

Take any x in **R**. Then $x\alpha\tau > x$ so $x\gamma\tau\beta\alpha^m > x$. So $x\gamma\tau\beta > x\alpha^{-m} > x$. Since $x\gamma\tau \leq x$ this implies $x\beta > x$. On the other hand,

$$x\beta = x\tau\alpha^{-1}\tau^{-1} < x\tau\tau^{-1} = x,$$

contradiction.

Case R.1.4 – τ acts freely and increasing in **R**, α acts freely and decreasing in **R**.

This implies $z\alpha^{-1} > z$ for all z in **R**. For any x in **R**, $x\beta = x\tau\alpha^{-1}\tau^{-1} > x\tau\tau^{-1} = x$. Also $x\tau^{-1}\alpha\tau < x$ for all x . Hence

$$x\alpha\beta\alpha^{m-1} = x\tau^{-1}\alpha\tau < x,$$

for all x . Hence $x\alpha\beta < x\alpha\alpha^{-m} < x\alpha$ for all x ($-m > 0$). But this contradicts $(x\alpha)\beta > x\alpha$ because β is increasing everywhere as proved above.

This finishes the analysis of T homeomorphic to **R** and orientation preserving action.

We now deal with orientation reversing cases. The general case of τ orientation reversing is hard, so we use one of the hypothesis to discard it as follows: $\tau^p = \gamma^{-q}$ is orientation preserving as γ always is. We are mainly interested in $|p-2q| = 1$, which implies p odd and if p is odd and τ^p orientation preserving then τ is also orientation preserving. We now deal with the case α orientation reversing.

Case R.2 – α orientation reversing, τ orientation preserving.

Let x be the unique fixed point of α . As $x\tau \neq x$, assume $x\tau > x$. As $\tau = \kappa^q$ and $q > 0$, this implies k is increasing in x . Notice that $x\tau^{-1}$ is the unique fixed point of β . The subcases depend on the relative position of $x\tau\alpha$ and $x\tau^{-1}$. Notice that $x\tau > x$, so $x\tau\alpha < x\alpha = x$.

Case R.2.1 – $x\tau\alpha < x\tau^{-1}$

Then $x\tau\alpha\tau^{-1} = x\beta^{-1} < x\tau^{-2}$. Notice

$$x\tau\gamma\beta\alpha^m = x\alpha\tau = x\tau > x$$

so $x\tau\gamma\beta > x\alpha^{-m} = x$ and so

$$x\tau\gamma < x\beta^{-1} < x\tau^{-2}$$

or $x\tau^3\gamma < x$. As $\tau^3 = \kappa^{3q}$ and $\gamma = \kappa^{-q}$, then $x\kappa^{3q-p} < x$. As κ is increasing in x then $3q - p < 0$ or $p > 3q$. Arguments such as this will be used in various parts of the proof. Since in the end we want $p = 2q \pm 1$ we can discard this case.

Remark – What we really wanted was to rule out this case without using $p = 2q \pm 1$, but we were unable to do that. Our partial results (without using $p = 2q \pm 1$) show that $x\tau\alpha^3 > x\tau\alpha$ so $x < x\tau\alpha^2 < x\tau$. Also there is a fixed point of α^2 between $x\tau$ and $x\tau^2$ and α^2 acts expandingly (away from x) in some point. Something similar is also true in the following case.

Case R.2.2 – $x\tau\alpha > x\tau^{-1}$

First notice that $x\beta^{-1} < x\tau^{-1}$. Use

$$(x\tau)\tau\gamma\beta\alpha^m = (x\tau)\alpha\tau > x\tau^{-1}\tau = x$$

so $x\tau^2\gamma\beta > x\alpha^{-m} = x$ and

$$x\tau^2\gamma < x\beta^{-1} < x\tau^{-1}.$$

We conclude as in the previous case that $x\tau^3\gamma < x$ or $p > 3q$, also disallowed.

The reader may think we just got lucky to get $p > 3q$ as we have the hypothesis $p = 2q \pm 1$. The remaining case explains why this has happened.

Case R.2.3 – $x\tau\alpha = x\tau^{-1}$.

This case is much more interesting. First

$$x\alpha\tau = x\tau\alpha\beta\alpha^{m-1}$$

Since $x\tau\alpha = x\tau^{-1}$ this is left invariant by β , so the right side is $x\tau\alpha\alpha^{m-1} = x\tau\alpha^m$ equal to $x\tau$. Since m is even, α^m preserves orientation, therefore $x\tau\alpha^2 = x\tau$. Also $x\tau\alpha = x\tau\alpha^{-1} = x\tau^{-1}$. Now notice that

$$x\tau\gamma\beta\alpha^m = x\alpha\tau = x\tau, \quad \text{so} \quad x\tau\gamma = x\tau\alpha^{-m}\beta^{-1},$$

or $x\tau\gamma = x\tau\beta^{-1}$. Now we show that $x\tau^2\alpha = x\tau^{-2}$. To show this use $x\beta^{-1}\tau = x\tau\alpha = x\tau^{-1}$, hence $x\beta^{-1} = x\tau^{-2}$. Use

$$\tau^{-2}\beta\tau^2 = \tau^{-1}\alpha^{-1}\tau = \alpha^{1-m}\beta^{-1}\alpha^{-1}$$

applied to x :

$$x\tau^{-2}\beta\tau^2 = x\alpha^{1-m}\beta^{-1}\alpha^{-1}$$

or $x\beta^{-1}\beta\tau^2 = x\beta^{-1}\alpha^{-1}$ so

$$x\tau^2 = x\tau^{-2}\alpha^{-1}.$$

Then

$$x\tau^{-2} = x\tau^2\alpha = (x\tau)\tau\alpha = x\tau\beta^{-1}\tau = x\tau\gamma\tau$$

or

$$x\gamma\tau^4 = x$$

As seen before this implies $p = 4q$ or $p = 4$, $q = 1$. This is disallowed by p being odd.

We remark that in this case the group in fact acts non trivially in **R**. For instance let

$$x\alpha = -x, \quad x\tau = x + 1$$

It is easy to check they satisfy the equations if m is even!

It may be true that this is the only possibility and when $x\tau\alpha \neq x\tau^{-1}$ we get a perturbation of this, namely that p is close to $4q$ and in fact $p > 3q$.

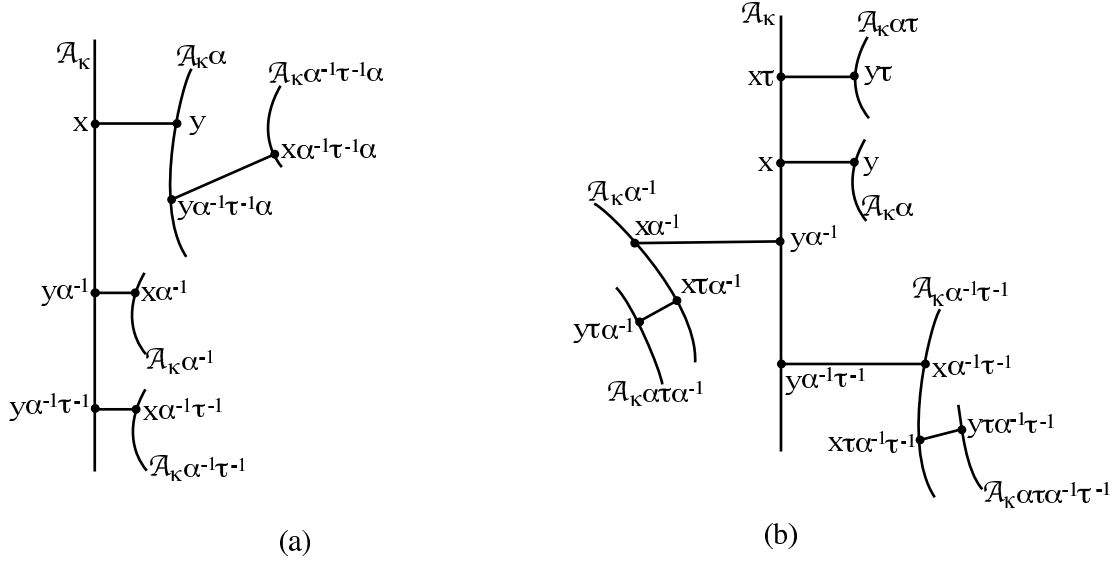

Figure 2: The case $\mathcal{A}_\kappa \cap \mathcal{A}_\kappa \alpha = \emptyset$. The same arguments can be used for intersection a single point. a. Using $\mathcal{A}_\kappa u = \mathcal{A}_\kappa \alpha^{-1} \tau^{-1} \alpha$, b. Using $\mathcal{A}_\kappa u = \mathcal{A}_\kappa \alpha \tau \alpha^{-1} \tau^{-1}$.

6 Case A – τ acts freely

In this section we consider the case that τ acts freely in T . This implies that κ^q acts freely in the tree, and therefore κ itself acts freely. In addition the axes are the same $\mathcal{A}_\kappa = \mathcal{A}_\tau$. Here we will use the relation $\alpha\beta = \gamma\beta\alpha$ in the following form, defining an element u of \mathcal{G} :

$$u = \alpha\tau\alpha^{-1}\tau^{-1} = \gamma\tau\alpha^{-1}\tau\alpha$$

We will consider the intersections $\mathcal{A}_\kappa \cap \mathcal{A}_\kappa \alpha$ and $\mathcal{A}_\kappa \cap \mathcal{A}_\kappa u$. The axis \mathcal{A}_κ is homeomorphic to the real numbers. Put an order $<$ in \mathcal{A}_κ so that $x < x\tau$ for any x in \mathcal{A}_κ . This induces an order $<_\alpha$ in $\mathcal{A}_\kappa \alpha$ so that $x < y$ in \mathcal{A}_κ if and only if $x\alpha <_\alpha y\alpha$ in $\mathcal{A}_\kappa \alpha$ and similarly put order $<_u$ in $\mathcal{A}_\kappa u$ so that $x < y$ in \mathcal{A}_κ if and only if $xu <_u yu$ in $\mathcal{A}_\kappa u$.

Case A.1 – $\mathcal{A}_\kappa \alpha \cap \mathcal{A}_\kappa$ has at most one point.

If the intersection is a single point x , let $y = x$ as well.

If they are disjoint, there is a single point x in \mathcal{A}_κ bridging to $\mathcal{A}_\kappa \alpha$. For instance x is the unique point so that there is a path from x to $\mathcal{A}_\kappa \alpha$ intersecting \mathcal{A}_κ only in x . Another way to characterize x , it is the only point so that x separates the rest of \mathcal{A}_κ from $\mathcal{A}_\kappa \alpha$. In other words the components of $T - \{x\}$ containing $\mathcal{A}_\kappa \alpha$ and the rest of \mathcal{A}_κ are all disjoint. In the same way there is a single y in $\mathcal{A}_\kappa \alpha$ which is the closest to \mathcal{A}_κ . Then $[x, y]$ is a path from \mathcal{A}_κ to $\mathcal{A}_\kappa \alpha$ so that (x, y) does not intersect either \mathcal{A}_κ or $\mathcal{A}_\kappa \alpha$ – this is an equivalent way to get the segment $[x, y]$. This path $[x, y]$ is called the *bridge* from \mathcal{A}_κ to $\mathcal{A}_\kappa \alpha$. This extended notion of bridges will also be used in the article. It is invariant by homeomorphisms of the tree. The bridge between connected sets is also unique.

We now use the relation above. The proof is very similar to ping pong lemma arguments. Since \mathcal{A}_κ is invariant under γ and τ , the right side says that $\mathcal{A}_\kappa u = \mathcal{A}_\kappa \alpha^{-1} \tau^{-1} \alpha$.

The bridge from \mathcal{A}_κ to $\mathcal{A}_\kappa \alpha$ is $[x, y]$ - degenerate $[x, x]$ when they intersect in a point. Therefore the bridge from $\mathcal{A}_\kappa \alpha^{-1}$ to \mathcal{A}_κ is $[x\alpha^{-1}, y\alpha^{-1}]$, see fig. 2, a. Then the bridge $\mathcal{A}_\kappa \alpha^{-1} \tau^{-1}$ to \mathcal{A}_κ is $[x\alpha^{-1} \tau^{-1}, y\alpha^{-1} \tau^{-1}]$. This implies that the bridge from

$$\mathcal{A}_\kappa \alpha^{-1} \tau^{-1} \alpha \text{ to } \mathcal{A}_\kappa \alpha \text{ is } [x\alpha^{-1} \tau^{-1} \alpha, y\alpha^{-1} \tau^{-1} \alpha].$$

Notice that $y\alpha^{-1} \tau^{-1}$ is not $y\alpha^{-1}$. Therefore $y\alpha^{-1} \tau^{-1} \alpha$ is not y . It now follows that

the bridge from $\mathcal{A}_\kappa u = \mathcal{A}_\kappa \alpha^{-1} \tau^{-1} \alpha$ to \mathcal{A}_κ is $[x \alpha^{-1} \tau^{-1} \alpha, x]$.

On the other hand use that $\mathcal{A}_\kappa u = \mathcal{A}_\kappa \alpha \tau \alpha^{-1} \tau^{-1}$. The bridge from $\mathcal{A}_\kappa \alpha \tau$ to \mathcal{A}_κ is $[y \tau, x \tau]$, see fig. 2, b. The bridge from $\mathcal{A}_\kappa \alpha \tau \alpha^{-1}$ to $\mathcal{A}_\kappa \alpha^{-1}$ is $[y \tau \alpha^{-1}, x \tau \alpha^{-1}]$ and the bridge from $\mathcal{A}_\kappa \alpha^{-1}$ to \mathcal{A}_κ is $[x \alpha^{-1}, y \alpha^{-1}]$. Since $x \alpha^{-1}$ is not equal $x \tau \alpha^{-1}$ then the bridge from $\mathcal{A}_\kappa \alpha \tau \alpha^{-1}$ to \mathcal{A}_κ is $[y \tau \alpha^{-1}, y \alpha^{-1}]$. Finally

the bridge from $\mathcal{A}_\kappa u$ to \mathcal{A}_κ is $[y \tau \alpha^{-1} \tau^{-1}, y \alpha^{-1} \tau^{-1}]$.

Since the bridge from $\mathcal{A}_\kappa u$ to \mathcal{A}_κ is uniquely defined this implies

$$y \alpha^{-1} \tau^{-1} = x, \quad y \tau \alpha^{-1} \tau^{-1} = x \alpha^{-1} \tau^{-1} \alpha.$$

So $y = x \tau \alpha$ and

$$x \alpha^{-1} \tau^{-1} \alpha = x \tau \alpha \tau \alpha^{-1} \tau^{-1}, \quad \text{or} \quad x \alpha^{-1} \tau^{-1} \alpha \tau \alpha = x \tau \alpha \tau.$$

Use $\tau^{-1} \alpha \tau = \alpha \beta \alpha^{m-1}$, so

$$\alpha^{-1} \tau^{-1} \alpha \tau \alpha = \alpha^{-1} \alpha \beta \alpha^{m-1} \alpha = \beta \alpha^m = \gamma^{-1} \tau^{-1} \alpha \tau,$$

so $x \gamma^{-1} \tau^{-1} \alpha \tau = x \tau \alpha \tau$, or $x \gamma^{-1} \tau^{-1} = x \tau$. This implies $x \gamma \tau^2 = x$ and as seen before implies $p = 2q$. This is disallowed by p odd.

We now consider intersections with more than one point.

Case A.2 – $\mathcal{A}_\kappa \cap \mathcal{A}_\kappa \alpha = [x, y]$.

Here x is not equal to y and $x < y$ in \mathcal{A}_κ . We include some ideal point cases: x could $-\infty$ and y could be $+\infty$, in which case the intersection is a ray in \mathcal{A}_κ . On the other hand we can never have $\mathcal{A}_\kappa = \mathcal{A}_\kappa \alpha$. Otherwise α, τ leave \mathcal{A}_κ invariant, so the whole group does. But \mathcal{A}_κ is homomorphic to \mathbf{R} – this was disallowed by no actions on \mathbf{R} .

Since the intersection is a non trivial interval one considers separately whether the orders $<$, $<_\alpha$ agree on the intersection.

Case A.2.1 – The orders $<$ and $<_\alpha$ agree on $\mathcal{A}_\kappa \cap \mathcal{A}_\kappa \alpha$.

It is easy to check that this is equivalent to $x \alpha^{-1} < y \alpha^{-1}$ in \mathcal{A}_κ , by applying α to the pair $x \alpha^{-1}, y \alpha^{-1}$ both of which are in \mathcal{A}_κ .

We now consider $\mathcal{A}_\kappa u$. We first use $\mathcal{A}_\kappa u = \mathcal{A}_\kappa \alpha^{-1} \tau^{-1} \alpha$. Notice that

$$\mathcal{A}_\kappa \cap \mathcal{A}_\kappa \alpha^{-1} = [x \alpha^{-1}, y \alpha^{-1}] \quad \text{so} \quad \mathcal{A}_\kappa \alpha^{-1} \tau^{-1} \cap \mathcal{A}_\kappa = [x \alpha^{-1} \tau^{-1}, y \alpha^{-1} \tau^{-1}],$$

in the correct order. Hence

$$\mathcal{A}_\kappa u \cap \mathcal{A}_\kappa = [x \alpha^{-1} \tau^{-1} \alpha, y \alpha^{-1} \tau^{-1} \alpha].$$

In addition $x \alpha^{-1} \tau^{-1} \alpha <_\alpha y \alpha^{-1} \tau^{-1} \alpha$.

Notice that $x \alpha^{-1} \tau^{-1} < x \alpha^{-1}$ in \mathcal{A}_κ , hence $x \alpha^{-1} \tau^{-1} \alpha <_\alpha x$ in $\mathcal{A}_\kappa \alpha$. Also $y \alpha^{-1} \tau^{-1} \alpha <_\alpha y$ in $\mathcal{A}_\kappa \alpha$. Given this there are 3 options:

1) If $y \alpha^{-1} \tau^{-1} \alpha <_\alpha x$ in $\mathcal{A}_\kappa \alpha$ then $\mathcal{A}_\kappa u \cap \mathcal{A}_\kappa = \emptyset$ and the bridge from \mathcal{A}_κ to $\mathcal{A}_\kappa u$ is $[x, y \alpha^{-1} \tau^{-1} \alpha]$, fig. 3, a.

2) If $y \alpha^{-1} \tau^{-1} \alpha >_\alpha x$ in $\mathcal{A}_\kappa \alpha$ then $y \alpha^{-1} \tau^{-1} \alpha$ is in (x, y) and $\mathcal{A}_\kappa u \cap \mathcal{A}_\kappa = [x, y \alpha^{-1} \tau^{-1} \alpha]$. In addition the orders $<$ and $<_u$ agree on $\mathcal{A}_\kappa \cap \mathcal{A}_\kappa \alpha$, see fig. 3, b.

3) If $y \alpha^{-1} \tau^{-1} \alpha = x$, then $\mathcal{A}_\kappa \alpha \cap \mathcal{A}_\kappa = [z, x]$. In addition if z is not x then the orders $<$ and $<_u$ disagree on $\mathcal{A}_\kappa \cap \mathcal{A}_\kappa u$, see fig. 3, c. In this case both x and y are finite. The last option can occur because

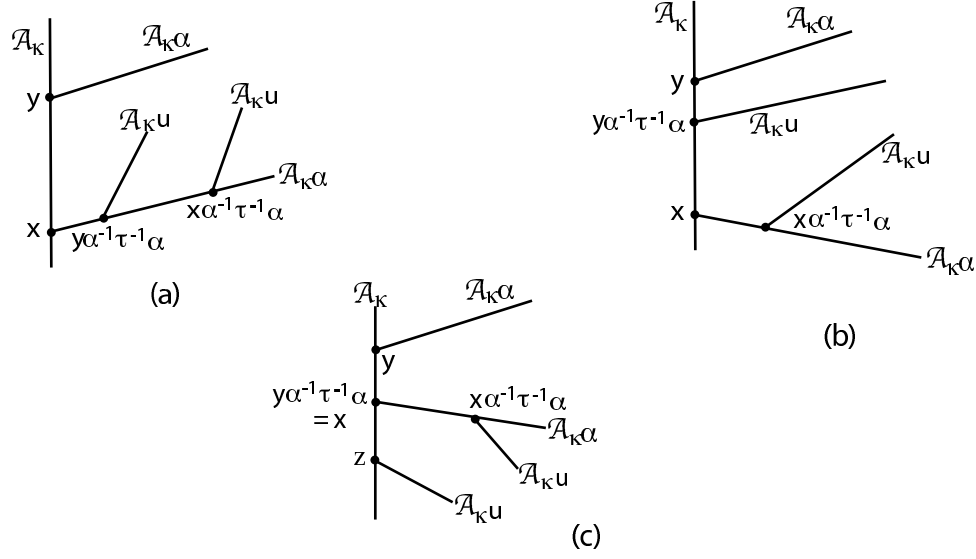

Figure 3: Evaluating $\mathcal{A}_\kappa u \cap \mathcal{A}_\kappa$, using $\mathcal{A}_\kappa u = \mathcal{A}_\kappa \alpha^{-1} \tau^{-1} \alpha$, a. $y \alpha^{-1} \tau^{-1} \alpha <_\alpha x$, b. $y \alpha^{-1} \tau^{-1} \alpha >_\alpha x$, c. $y \alpha^{-1} \tau^{-1} \alpha = x$.

$\mathcal{A}_\kappa u$ can enter \mathcal{A}_κ in x but rather than going up, going in the opposite direction – the one containing $x\tau^{-1}$.

Notice that the 3 options are mutually exclusive. We now consider $\mathcal{A}_\kappa u = \mathcal{A}_\kappa \alpha \tau \alpha^{-1} \tau^{-1}$. Use

$$\mathcal{A}_\kappa u \cap \mathcal{A}_\kappa = (\mathcal{A}_\kappa \alpha \tau \cap \mathcal{A}_\kappa \alpha) \alpha^{-1} \tau^{-1}.$$

Here $\mathcal{A}_\kappa \alpha \tau \cap \mathcal{A}_\kappa = [x\tau, y\tau]$. So whether $\mathcal{A}_\kappa \alpha \tau \alpha^{-1}$ and \mathcal{A}_κ intersect, depends on the relative positions of $x\tau$ and y . Notice that $x\tau > x$ in \mathcal{A}_κ .

1') If $x\tau > y$ in \mathcal{A}_κ then $\mathcal{A}_\kappa \alpha \tau \cap \mathcal{A}_\kappa \alpha = \emptyset$, so $\mathcal{A}_\kappa \alpha \tau \alpha^{-1} \cap \mathcal{A}_\kappa = \emptyset$. Therefore $\mathcal{A}_\kappa u \cap \mathcal{A}_\kappa = \emptyset$ and the bridge from \mathcal{A}_κ to $\mathcal{A}_\kappa u$ is $[y\alpha^{-1}\tau^{-1}, x\tau\alpha^{-1}\tau^{-1}]$, see fig. 4, a. Here x, y finite.

2') If $x\tau < y$ in \mathcal{A}_κ then $\mathcal{A}_\kappa \alpha \tau \cap \mathcal{A}_\kappa \alpha = [x\tau, y]$, then $\mathcal{A}_\kappa \cap \mathcal{A}_\kappa u$ is $[x\tau\alpha^{-1}\tau^{-1}, y\alpha^{-1}\tau^{-1}]$ (the first term smaller in \mathcal{A}_κ), and the orders $<$ and $<_u$ agree on $\mathcal{A}_\kappa \cap \mathcal{A}_\kappa u$, see fig. 4, b.

3') If $x\tau = y$, then $\mathcal{A}_\kappa \alpha \tau \cap \mathcal{A}_\kappa \alpha = [y, v]$. Notice we may have $v \neq y$. So $\mathcal{A}_\kappa u \cap \mathcal{A}_\kappa = [y\alpha^{-1}\tau^{-1}, w]$, where $w = v\alpha^{-1}\tau^{-1}$. Here x and y are finite and if w is not equal to $x\tau\alpha^{-1}\tau^{-1}$, then the orders $<$ and $<_u$ disagree on $\mathcal{A}_\kappa \cap \mathcal{A}_\kappa u$. Notice that order in $\mathcal{A}_\kappa \alpha \tau$ goes from v to y , so the increasing order $<_u$ in $\mathcal{A}_\kappa u$ from $w = v\alpha^{-1}\tau^{-1}$ to $y\alpha^{-1}\tau^{-1}$, see fig. 4, c.

Notice that again all 3 cases are mutually exclusive. Therefore we can match the 2 pairs of 3 possibilities to get 3 mutually exclusive cases:

I – $y \alpha^{-1} \tau^{-1} \alpha <_\alpha x$ in $\mathcal{A}_\kappa \alpha$ or $x\tau > y$ in \mathcal{A}_κ and $\mathcal{A}_\kappa \cap \mathcal{A}_\kappa u = \emptyset$. In this case

$$[x, y \alpha^{-1} \tau^{-1} \alpha] = [y \alpha^{-1} \tau^{-1}, x \tau \alpha^{-1} \tau^{-1}]$$

II – $y \alpha^{-1} \tau^{-1} \alpha >_\alpha x$ in $\mathcal{A}_\kappa \alpha$ or $x\tau < y$ in \mathcal{A}_κ and

$$\mathcal{A}_\kappa \cap \mathcal{A}_\kappa u = [x, y \alpha^{-1} \tau^{-1} \alpha] = [x \tau \alpha^{-1} \tau^{-1}, y \alpha^{-1} \tau^{-1}]$$

III – $y \alpha^{-1} \tau^{-1} \alpha = x$ or $x\tau = y$. Then

$$\mathcal{A}_\kappa \cap \mathcal{A}_\kappa u = [z, x] = [y \alpha^{-1} \tau^{-1}, w]$$

If z is not x then the orders $<$ and $<_u$ disagree on $\mathcal{A}_\kappa \cap \mathcal{A}_\kappa u$.

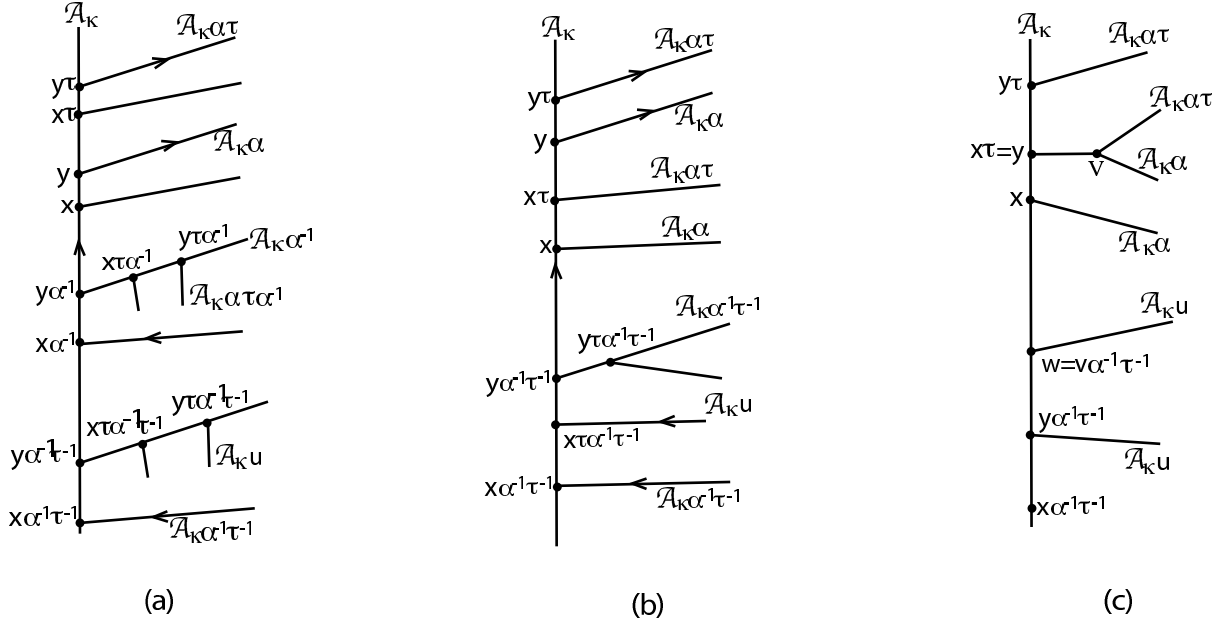

Figure 4: Using $\mathcal{A}_\kappa u = \mathcal{A}_\kappa \alpha \tau \alpha^{-1} \tau^{-1}$, a. $x\tau > y$, b. $x\tau < y$, c. $x\tau = y$.

We now deal with each situation separately.

Situation II –

Here $x\tau\alpha = x\tau$ and $x\tau$ is in (x, y) . Let \mathcal{U}_1 , (respectively \mathcal{U}_2) be the component of $T - \{x\tau\}$ containing y (respectively x). Here $[x, y] = \mathcal{A}_\kappa \cap \mathcal{A}_\kappa \alpha$, $x\tau$ is in the interior of $[x, y]$ and then the orders $<$, $<_\alpha$ agree on $[x, y]$. It follows that the prongs $[x\tau, y]$, $[x\tau, y\alpha]$ are equivalent. By lemma 4.5, $\mathcal{U}_1\alpha = \mathcal{U}_1$. In the same way $\mathcal{U}_2\alpha = \mathcal{U}_2$. This situation is disallowed by the following lemma.

Lemma 6.1. *Suppose that \mathcal{L} is a local axis for τ and r is a point in \mathcal{L} with $r\alpha = r$. Suppose that \mathcal{U}_1 (\mathcal{U}_2 respectively) is the component of $T - \{r\}$ containing $r\tau$ ($r\tau^{-1}$ respectively). Then at least one of \mathcal{U}_1 or \mathcal{U}_2 is not invariant under α .*

Proof. On the contrary suppose that $\mathcal{U}_i\alpha = \mathcal{U}_i$ for $i = 1, 2$. We will arrive at a contradiction. Let $\mathcal{V}_i = \mathcal{U}_i\tau^{-1}$. Then the conjugation of β with α^{-1} by τ implies that $\mathcal{V}_i\beta = \mathcal{V}_i$, $i = 1, 2$. Use

$$r\tau^{-1}\alpha\tau = r\gamma\beta\alpha^m$$

Since $p \geq q$, then $r\gamma \leq r\tau^{-1}$ in \mathcal{L} (with τ increasing in \mathcal{L} and so $r\gamma\beta$ is in $\mathcal{V}_2 \cup \{r\tau^{-1}\}$ contained in \mathcal{U}_2 . Therefore $r\gamma\beta\alpha^m$ is in \mathcal{U}_2 . Consequently $r\tau^{-1}\alpha\tau$ is in \mathcal{U}_2 and $r\tau^{-1}\alpha$ is in $\mathcal{U}_2\tau^{-1} = \mathcal{V}_2$ (*).

On the other hand $r\gamma \in \mathcal{V}_2 \cup \{r\tau^{-1}\}$, so

$$r\beta\alpha^{-1} = r\gamma\beta \in \mathcal{V}_2 \cup \{r\tau^{-1}\},$$

so $r\tau^{-1}$ is in $[r\beta\alpha^{-1}, r)$. Apply α to obtain

$$r\tau^{-1}\alpha \in [r\beta, r) \quad (**).$$

Now

$$r\beta = r\tau\alpha^{-1}\tau^{-1} \quad \text{and} \quad r\tau \in \mathcal{U}_1 \Rightarrow r\tau\alpha^{-1} \in \mathcal{U}_1 \Rightarrow r\beta = r\tau\alpha^{-1}\tau^{-1} \in \mathcal{V}_1.$$

As r is also in \mathcal{V}_1 , it follows from (**) that $r\tau^{-1}\alpha$ is also in \mathcal{V}_1 . This contradicts (*) above and finishes the proof. \square

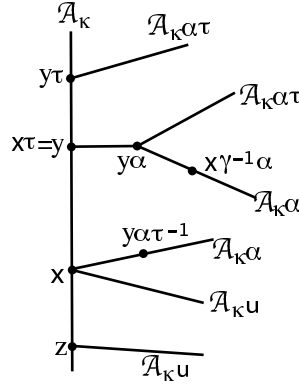
 Figure 5: *Situation III leading to a contradiction.*

Situation III – Here $\mathcal{A}_\kappa u \cap \mathcal{A}_\kappa = [z, x]$ with $z \leq x$ in \mathcal{A}_κ . Then

$$\mathcal{A}_\kappa u \tau \cap \mathcal{A}_\kappa = \mathcal{A}_\kappa \alpha \tau \alpha^{-1} \cap \mathcal{A}_\kappa = [z\tau, x\tau] = [z\tau, y].$$

Hence $\mathcal{A}_\kappa \alpha \tau \cap \mathcal{A}_\kappa \alpha = [z\tau\alpha, y\alpha]$ and $z\tau\alpha = y \leq_\alpha y\alpha$ in $\mathcal{A}_\kappa \alpha$ – this is the crucial fact. Now

$$\begin{aligned} x\gamma^{-1}\alpha &= x\beta\alpha\beta^{-1} = x\tau\alpha^{-1}\tau^{-1}\alpha\beta^{-1} = y\alpha^{-1}\tau^{-1}\alpha\beta^{-1} \\ &= x\beta^{-1} = x\tau\alpha\tau^{-1} = y\alpha\tau^{-1}. \end{aligned}$$

Here the bridge of $y\alpha$ to \mathcal{A}_κ is $[y\alpha, y]$ (which a priori could be the single point y). So the bridge from $y\alpha\tau^{-1}$ to \mathcal{A}_κ is $[y\alpha\tau^{-1}, y\tau^{-1}] = [y\alpha\tau^{-1}, x]$. On the other hand $y \leq x\gamma^{-1}$ in \mathcal{A}_κ so $y\alpha \leq_\alpha x\gamma^{-1}\alpha$ in $\mathcal{A}_\kappa \alpha$. It follows that the bridge from $x\gamma^{-1}\alpha$ to \mathcal{A}_κ is $[x\gamma^{-1}\alpha, y]$. This would imply $x = y$, contradiction.

Situation I – Surprisingly this is the most difficult case. Here

$$y\alpha^{-1}\tau^{-1}\alpha <_\alpha x \text{ in } \mathcal{A}_\kappa \alpha, \quad x\tau > y \text{ in } \mathcal{A}_\kappa, \quad x = y\alpha^{-1}\tau^{-1}, \quad y\alpha^{-1}\tau^{-1}\alpha = x\tau\alpha^{-1}\tau^{-1}.$$

As $y\alpha^{-1}\tau^{-1}\alpha <_\alpha x$ in $\mathcal{A}_\kappa \alpha$ then $y\alpha^{-1}\tau^{-1}\alpha$ is not in \mathcal{A}_κ . Also

$$x\alpha = (y\alpha^{-1}\tau^{-1})\alpha = x\tau\alpha^{-1}\tau^{-1} = x\beta,$$

so $x\alpha = x\beta$ – this is a crucial fact in this proof. The bridge from $x\alpha$ to \mathcal{A}_κ is $[x\alpha, x]$. Notice also that

$$x\alpha^{-1}\tau^{-1}\alpha <_\alpha y\alpha^{-1}\tau^{-1}\alpha <_\alpha x \text{ in } \mathcal{A}_\kappa \alpha,$$

so the bridge from $x\alpha^{-1}\tau^{-1}\alpha$ to \mathcal{A}_κ is $[x\alpha^{-1}\tau^{-1}\alpha, x]$. It follows that

$$\text{the bridge from } x\alpha\tau^{-1}\alpha\tau \text{ to } \mathcal{A}_\kappa \text{ is } [x\alpha^{-1}\tau^{-1}\alpha\tau, x\tau] = [x\alpha^{-1}\tau^{-1}\alpha\tau, y\alpha^{-1}].$$

Now

$$x\alpha^{-1}\tau^{-1}\alpha\tau = (x\alpha^{-1})\alpha\beta\alpha^{m-1} = x\beta\alpha^{m-1} = x\alpha\alpha^{m-1} = x\alpha^m$$

Here $x\alpha \prec x \prec y \prec y\alpha^{-1}$ – they are aligned. It follows from lemma 4.6 that $x, x\alpha$ are in a local axis $\mathcal{L}\mathcal{A}_\alpha$ for α , similarly y is also in a local axis. Since y is in $[x\alpha^m, x]$, then also $y, y\alpha^{-1}$ are in $\mathcal{L}\mathcal{A}_\alpha$. In the same way $(\mathcal{L}\mathcal{A}_\alpha)\tau^{-1} = \mathcal{L}\mathcal{A}_\beta$ is a local axis for β and $x\beta, x, x\tau^{-1}$ are in $\mathcal{L}\mathcal{A}_\beta$. Now

$$x\beta = x\tau\alpha^{-1}\tau^{-1} = x\alpha, \quad \text{so} \quad x\alpha\tau = x\tau\alpha^{-1} = y\alpha^{-2}$$

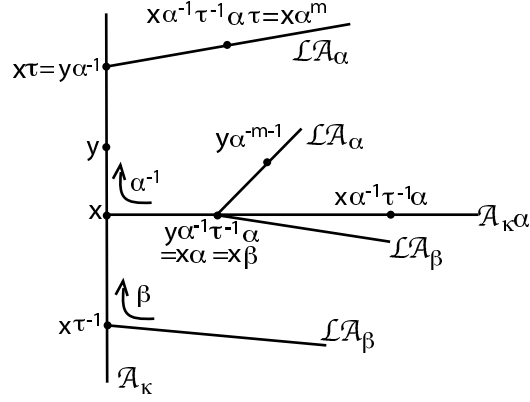
 Figure 6: *Situation I, the hard case.*

Apply $\alpha\beta\alpha^{m-1} = \tau^{-1}\alpha\tau$ to $y\alpha^{-1}$:

$$(y\alpha^{-1})\alpha\beta\alpha^{m-1} = y\beta\alpha^{m-1} = (y\alpha^{-1})\tau^{-1}\alpha\tau = (x\tau)\tau^{-1}\alpha\tau = x\alpha\tau = y\alpha^{-2}.$$

The conclusion is $y\beta = y\alpha^{-m-1}$ and it is in $\mathcal{L}\mathcal{A}_{\alpha}$. Now y is not in $\mathcal{L}\mathcal{A}_{\beta}$ and the bridge from y to $\mathcal{L}\mathcal{A}_{\beta}$ is $[y, x]$, so the bridge from $y\beta$ to $\mathcal{L}\mathcal{A}_{\beta}$ is $[y\beta, x\beta] = [y\alpha^{-m-1}, x\alpha]$. Therefore $\mathcal{L}\mathcal{A}_{\alpha}$ and $\mathcal{L}\mathcal{A}_{\beta}$ split away from each other in $x\alpha = x\beta$, or

$$\mathcal{L}\mathcal{A}_{\alpha} \cap \mathcal{L}\mathcal{A}_{\beta} = [x, x\alpha] = [x, x\beta].$$

The homeomorphism τ conjugates the action of α^{-1} in $\mathcal{L}\mathcal{A}_{\alpha}$ to the action of β in $\mathcal{L}\mathcal{A}_{\beta}$ (see fig. 6). Now apply $\alpha\tau\alpha^{-m} = \tau\gamma\beta$ to x :

$$(x\alpha\tau)\alpha^{-m} = (y\alpha^{-2})\alpha^{-m} = y\alpha^{-2-m} = x\tau\gamma\beta.$$

As $x\alpha$ is in $\mathcal{L}\mathcal{A}_{\beta}$, then $x\alpha\tau$ is in $\mathcal{L}\mathcal{A}_{\alpha}$ and it follows that $x\tau\gamma\beta$ is in $\mathcal{L}\mathcal{A}_{\alpha}$. If $x\tau\gamma \leq x\tau^{-1}$ in \mathcal{A}_{κ} , then the bridge from $x\tau\gamma$ to $\mathcal{L}\mathcal{A}_{\beta}$ is $[x\tau\gamma, x\tau^{-1}]$ and so the bridge from $x\tau\gamma\beta$ to $\mathcal{L}\mathcal{A}_{\beta}$ is $[x\tau\gamma\beta, x\tau^{-1}\beta]$. But $x\tau^{-1}\beta = x\alpha^{-1}\tau^{-1}$ and

$$x\alpha^{-1}\tau^{-1} < y\alpha^{-1}\tau^{-1} < x \text{ in } \mathcal{A}_{\kappa}.$$

This would imply $x\tau\gamma\beta$ is not in $\mathcal{L}\mathcal{A}_{\alpha}$, contradiction. Notice

$$x\beta^{-1} = x\tau\alpha\tau^{-1} = y\tau^{-1} \in (x\tau^{-1}, x).$$

If $x\tau\gamma$ is in $[x\tau^{-1}, x\beta^{-1})$ then $x\tau\gamma\beta$ is in $[x\tau^{-1}\beta, x)$ and not in $\mathcal{L}\mathcal{A}_{\alpha}$ either, contradiction again. Therefore $x\tau\gamma$ is in $[x\beta^{-1}, x]$. The case $x\tau\gamma = x$ can only occur when $p = q = 1$. This case can also be ruled out by a further argument, but as we are mainly interested in $|p - 2q| = 1$ we assume here that $p > q$. Then $x\tau\gamma$ is in $[x\beta^{-1}, x)$ and $x\tau\gamma\beta$ is in $[x, x\beta)$. We conclude that

$$y\alpha^{-2-m} \in [x, x\alpha).$$

Claim – $y\tau\gamma\beta$ is in $\mathcal{L}\mathcal{A}_{\alpha}$.

If $y\tau\gamma \geq x$ in \mathcal{A}_{κ} , then $x \leq y\tau\gamma \leq y$ in \mathcal{A}_{κ} . So $y\tau\gamma\beta$ is in $[x\beta, y\beta]$ or

$$y\tau\gamma\beta \in [x\alpha, y\alpha^{-m-1}] \subset \mathcal{L}\mathcal{A}_{\alpha}.$$

Notice $x\tau\gamma\beta \in \mathcal{L}\mathcal{A}_{\alpha}$. If on the other hand $y\tau\gamma < x$ in \mathcal{A}_{κ} , then $x\tau\gamma < y\tau\gamma < x$ in \mathcal{A}_{κ} , and

$$y\tau\gamma\beta \in (x\tau\gamma\beta, x\beta) = (x\tau\gamma\beta, x\alpha) \subset \mathcal{L}\mathcal{A}_{\alpha}$$

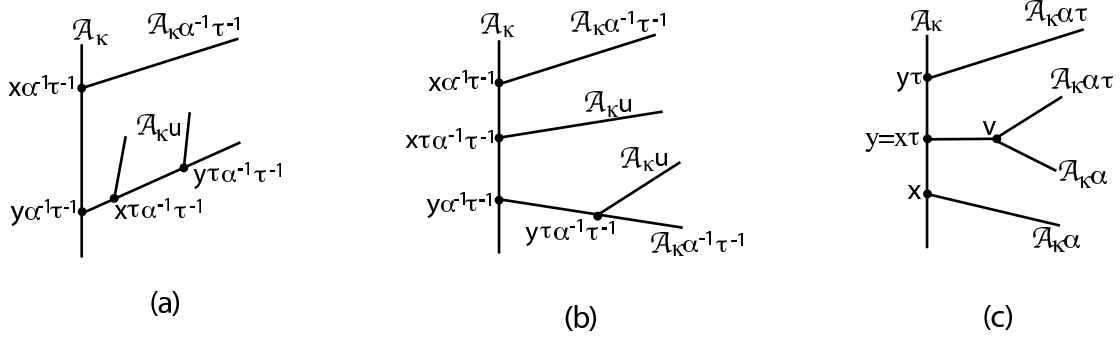

Figure 7: The orientation reversing situation, a. $x\tau > y$, b. $x\tau < y$, c. $x\tau = y$.

and again $y\tau\gamma\beta$ is in $\mathcal{L}\mathcal{A}_\alpha$.

Therefore the claim is proved.

It now follows that $y\tau\gamma\beta\alpha^m = y\alpha\tau$ is in $\mathcal{L}\mathcal{A}_\alpha$. If $y\alpha >_\alpha x$ in $\mathcal{L}\mathcal{A}_\alpha$, then $y\alpha > x$ in \mathcal{A}_κ as well. Then $y\alpha\tau > x\tau = y\alpha^{-1}$ in \mathcal{A}_κ and $y\alpha\tau$ is not in $\mathcal{L}\mathcal{A}_\alpha$ contradiction.

Therefore $y\alpha \leq_\alpha x$ in $\mathcal{L}\mathcal{A}_\alpha$ and so $y\alpha$ is in $[x, x\alpha]$. But $y\alpha^{-2-m} \in [x, x\alpha]$. Since y is in a local axis for α it follows that

$$y\alpha = y\alpha^{-2-m}, \quad \text{or} \quad m = -3.$$

Since we are assuming $m < -3$ this rules out this case as well.

This finishes the analysis of situation I and completes the analysis of the situation orders $<$ and $<_\alpha$ agree on $\mathcal{A}_\kappa \cap \mathcal{A}_\kappa\alpha$.

Case A.2.2 – The orders $<$ and $<_\alpha$ disagree on $\mathcal{A}_\kappa \cap \mathcal{A}_\kappa\alpha$.

Notice this is equivalent to $y\alpha^{-1} < x\alpha^{-1}$ in \mathcal{A}_κ . Again use $u = \alpha\tau\alpha^{-1}\tau^{-1} = \gamma\tau\alpha^{-1}\tau^{-1}\alpha$. Then

$$\mathcal{A}_\kappa u \cap \mathcal{A}_\kappa = (\mathcal{A}_\kappa\alpha\tau\alpha^{-1} \cap \mathcal{A}_\kappa)\tau^{-1} = (\mathcal{A}_\kappa\alpha\tau \cap \mathcal{A}_\kappa\alpha)\alpha^{-1}\tau^{-1}$$

There are the following possibilities:

1) If $x\tau > y$ in \mathcal{A}_κ , then $\mathcal{A}_\kappa\alpha\tau \cap \mathcal{A}_\kappa\alpha$ is empty and the bridge from $\mathcal{A}_\kappa\alpha\tau$ to $\mathcal{A}_\kappa\alpha$ is $[x\tau, y]$. Therefore $\mathcal{A}_\kappa u \cap \mathcal{A}_\kappa = \emptyset$ and the bridge from $\mathcal{A}_\kappa u$ to \mathcal{A}_κ is $[x\tau\alpha^{-1}\tau^{-1}, y\alpha^{-1}\tau^{-1}]$, see fig. 7, a.

2) If $x\tau < y$ in \mathcal{A}_κ , then $\mathcal{A}_\kappa\alpha\tau \cap \mathcal{A}_\kappa = [x\tau, y]$. Hence $\mathcal{A}_\kappa\alpha\tau\alpha^{-1} \cap \mathcal{A}_\kappa = [y\alpha^{-1}, x\tau\alpha^{-1}]$, where the first endpoint is smaller than the second in \mathcal{A}_κ . Finally

$$\mathcal{A}_\kappa u \cap \mathcal{A}_\kappa = [y\alpha^{-1}\tau^{-1}, x\tau\alpha^{-1}\tau^{-1}]$$

and the orders $<$, $<_u$ agree on $\mathcal{A}_\kappa u \cap \mathcal{A}_\kappa$, see fig. 7, b – because $y\alpha^{-1} < x\alpha^{-1}$ in \mathcal{A}_κ and their images under u satisfy $y\tau\alpha^{-1}\tau^{-1} <_u x\tau\alpha^{-1}\tau^{-1}$ in $\mathcal{A}_\kappa u$.

3) Finally if $x\tau = y$, then $\mathcal{A}_\kappa\alpha\tau \cap \mathcal{A}_\kappa\alpha = [y, v]$, where $v \leq_\alpha y$ in $\mathcal{A}_\kappa\alpha$. It follows that the intersection $\mathcal{A}_\kappa\alpha\tau\alpha^{-1} \cap \mathcal{A}_\kappa = [v\alpha^{-1}, y\alpha^{-1}]$, the first point precedes in \mathcal{A}_κ . And then

$$\mathcal{A}_\kappa u \cap \mathcal{A}_\kappa = [v\alpha^{-1}\tau^{-1}, y\alpha^{-1}\tau^{-1}] = [t, y\alpha^{-1}\tau^{-1}].$$

Here if t is not $y\alpha^{-1}\tau^{-1}$ then $<$ and $<_u$ disagree on $\mathcal{A}_\kappa u \cap \mathcal{A}_\kappa$ – because $y\tau^{-1}\alpha^{-1} \leq v\tau^{-1}\alpha^{-1}$ in \mathcal{A}_κ .

Now use $\mathcal{A}_\kappa u \cap \mathcal{A}_\kappa = (\mathcal{A}_\kappa\alpha^{-1}\tau^{-1} \cap \mathcal{A}_\kappa\alpha^{-1})\alpha$. Here $\mathcal{A}_\kappa\alpha^{-1} \cap \mathcal{A}_\kappa = [y\alpha^{-1}, x\alpha^{-1}]$ the first term precedes in \mathcal{A}_κ . Again there are 3 possibilities

1') If $x\alpha^{-1}\tau^{-1} < y\alpha^{-1}$ in \mathcal{A}_κ then $\mathcal{A}_\kappa\alpha^{-1}\tau^{-1} \cap \mathcal{A}_\kappa\alpha^{-1} = \emptyset$ and the bridge from $\mathcal{A}_\kappa\alpha^{-1}\tau^{-1}$ to $\mathcal{A}_\kappa\alpha^{-1}$ is $[x\alpha^{-1}\tau^{-1}, y\alpha^{-1}]$. Hence $\mathcal{A}_\kappa u \cap \mathcal{A}_\kappa = \emptyset$ and the bridge from $\mathcal{A}_\kappa u$ to \mathcal{A}_κ is $[x\alpha^{-1}\tau^{-1}\alpha, y]$, see fig. 8, a.

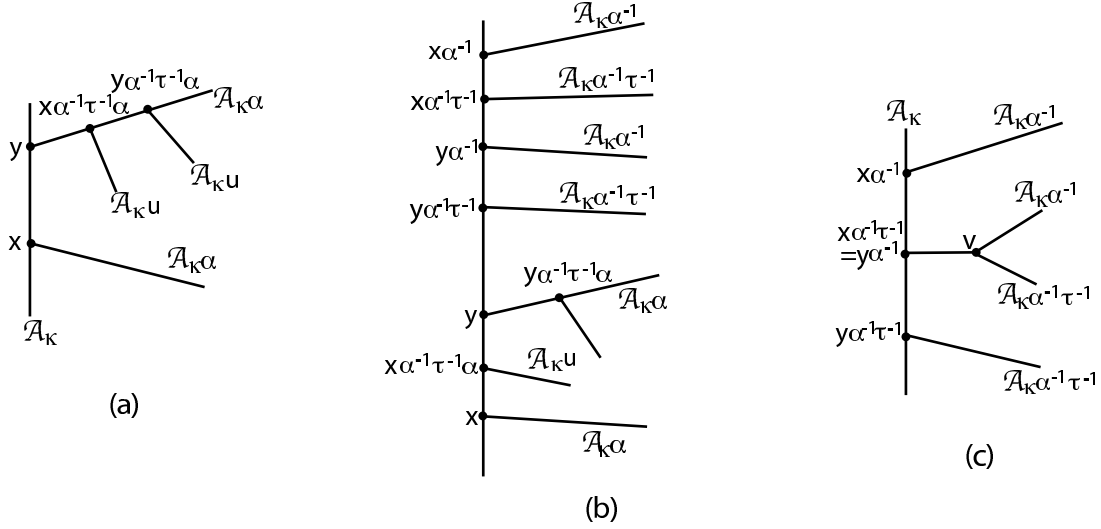

Figure 8: Using $\mathcal{A}_\kappa u = \mathcal{A}_\kappa \alpha \tau \alpha^{-1} \tau^{-1}$: a. $x\alpha^{-1}\tau^{-1} < y\alpha^{-1}$, b. $x\alpha^{-1}\tau^{-1} > y\alpha^{-1}$, c. $x\alpha^{-1}\tau^{-1} = y\alpha^{-1}$.

2') If $x\alpha^{-1}\tau^{-1} > y\alpha^{-1}$ in \mathcal{A}_κ , then $\mathcal{A}_\kappa\alpha^{-1}\tau^{-1} \cap \mathcal{A}_\kappa\alpha^{-1} = [y\alpha^{-1}, x\alpha^{-1}\tau^{-1}]$ and hence $\mathcal{A}_\kappa u \cap \mathcal{A}_\kappa = [x\alpha^{-1}\tau^{-1}\alpha, y]$ and the orders $<$ and $<_u$ agree on $\mathcal{A}_\kappa \cap \mathcal{A}_\kappa u$, see fig. 8, b – because $x < y$ in \mathcal{A}_κ and $x\alpha^{-1}\tau^{-1}\alpha <_u y\alpha^{-1}\tau^{-1}\alpha$ in $\mathcal{A}_\kappa u$.

3') If $x\alpha^{-1}\tau^{-1} = y$, then $\mathcal{A}_\kappa\alpha^{-1}\tau^{-1} \cap \mathcal{A}_\kappa\alpha^{-1} = [c, y\alpha^{-1}]$ and $\mathcal{A}_\kappa u \cap \mathcal{A}_\kappa = [y, z]$ where $z = c\alpha^{-1}$. If z is not equal to y , then the orders $<$ and $<_u$ disagree on $\mathcal{A}_\kappa u \cap \mathcal{A}_\kappa$.

Notice both pairs of 3 alternatives are all mutually exclusive. We match them and obtain 3 possible situations:

I – $x\tau > y$ in \mathcal{A}_κ , $x\alpha^{-1}\tau^{-1} < y\alpha^{-1}$ in \mathcal{A}_κ and

$$\mathcal{A}_\kappa u \cap \mathcal{A}_\kappa = \emptyset, \quad [y\alpha^{-1}\tau^{-1}, x\tau\alpha^{-1}\tau^{-1}] = [y, x\alpha^{-1}\tau^{-1}\alpha].$$

II – $x\tau < y$ in \mathcal{A}_κ , $x\alpha^{-1}\tau^{-1} > y\alpha^{-1}$ in \mathcal{A}_κ ,

$$\mathcal{A}_\kappa u \cap \mathcal{A}_\kappa = [y\alpha^{-1}\tau^{-1}, x\tau\alpha^{-1}\tau^{-1}] = [x\alpha^{-1}\tau^{-1}\alpha, y]$$

and the orders $<$, $<_u$ agree on $\mathcal{A}_\kappa u \cap \mathcal{A}_\kappa$.

III – $x\tau = y$, $x\alpha^{-1}\tau^{-1} = y\alpha^{-1}$ and

$$\mathcal{A}_\kappa u \cap \mathcal{A}_\kappa = [y, z] = [t, y\alpha^{-1}\tau^{-1}].$$

If z is not y then the orders $<$, $<_u$ disagree on $\mathcal{A}_\kappa u \cap \mathcal{A}_\kappa$.

We analyse each case in turn:

Situation II –

Here $x\tau < y$, $x\alpha^{-1}\tau^{-1} > y\alpha^{-1}$ and

$$y = x\tau\alpha^{-1}\tau^{-1}, \quad y\alpha^{-1}\tau^{-1} = x\alpha^{-1}\tau^{-1}\alpha.$$

Suppose first that $[y\alpha^{-1}, x\alpha^{-1}] \cap [x, y] = \emptyset$. Since $y\tau = x\tau\alpha^{-1}$ then $[y\alpha^{-1}, x\alpha^{-1}]$ is contained in the set of points $> y$ in \mathcal{A}_κ .

In addition $y\alpha$ is in $\mathcal{A}_\kappa\alpha - \mathcal{A}_\kappa$ and $y <_\alpha y\alpha$. Hence y is in $(y\alpha^{-1}, y\alpha)$, producing a local axis $\mathcal{L}\mathcal{A}_\alpha$ of α which contains y . Now use $\tau^{-1}\alpha\tau = \alpha\tau\alpha^{-1}\tau^{-1}\alpha^{m-1}$ applied to $x\alpha^{-1}$:

$$x\alpha^{-1}\tau^{-1}\alpha\tau = x\alpha^{-1}\alpha\tau\alpha^{-1}\tau^{-1}\alpha^{m-1} = x\tau\alpha^{-1}\tau^{-1}\alpha^{m-1}$$

Substitute $x\tau\alpha^{-1}\tau^{-1} = y$ in the last term and $x\alpha^{-1}\tau^{-1}\alpha = y\alpha^{-1}\tau^{-1}$ in the first term to get

$$(y\alpha^{-1}\tau^{-1})\tau = y\alpha^{-1} = y\alpha^{m-1}$$

or $y = y\alpha^m$. This is impossible because y is in a local axis of α and m is not zero.

From now on in situation II suppose that $[y\alpha^{-1}, x\alpha^{-1}] \cap [x, y]$ is not empty. Since $x\tau\alpha^{-1} = y\tau > y$ in \mathcal{A}_κ , then $x\alpha^{-1} > y$ in \mathcal{A}_κ . It follows that $y\alpha^{-1} \leq y$ in \mathcal{A}_κ .

Suppose first that $y\alpha^{-1} < y$ in \mathcal{A}_κ . There is r in $[y\alpha^{-1}, y]$ which is fixed by α . Either r is equal to y or $r < y$ in \mathcal{A}_κ . Let \mathcal{U}_1 (respectively \mathcal{U}_2) be the component of $T - \{r\}$ containing $r\tau$ (respectively $r\tau^{-1}$). Since

$$x\alpha^{-1} \in \mathcal{U}_1, \quad x \in \mathcal{U}_2 \quad \text{then} \quad \mathcal{U}_1\alpha = \mathcal{U}_2.$$

If $r < y$ in \mathcal{A}_κ then also we have $\mathcal{U}_2\alpha = \mathcal{U}_1$. Otherwise $\mathcal{U}_2\alpha = \mathcal{U}_3$ which is another component of $T - \{r\}$ which is not $\mathcal{U}_1, \mathcal{U}_2$. We will rule out this case, but the result will be used later on as well, so we state it in more generality:

Lemma 6.2. *Let $\mathcal{L}\mathcal{A}_\tau$ be a local axis for τ . Let r in $\mathcal{L}\mathcal{A}_\tau$ which is fixed by α . Let \mathcal{U}_1 (respectively \mathcal{U}_2 be the component of $T - \{r\}$ containing $r\tau$ (respectively $r\tau^{-1}$). Then $\mathcal{U}_1\alpha$ is not \mathcal{U}_2 and $\mathcal{U}_2\alpha$ is not \mathcal{U}_1 .*

Proof. The proof is as follows: suppose that either $\mathcal{U}_1\alpha = \mathcal{U}_2$ or $\mathcal{U}_2\alpha = \mathcal{U}_1$ and arrive at a contradiction.

First assume that $\mathcal{U}_1\alpha = \mathcal{U}_2$. Either $\mathcal{U}_2\alpha = \mathcal{U}_1$ or $\mathcal{U}_2\alpha$ is another component \mathcal{U}_3 of $T - \{u\}$.

Let $\mathcal{V}_i = \mathcal{U}_i\tau^{-1}$. Since $\mathcal{V}_1\beta = \mathcal{V}_1\tau\alpha^{-1}\tau^{-1} = \mathcal{U}_1\alpha^{-1}\tau^{-1} \neq \mathcal{V}_1$, we have that $\mathcal{V}_1\beta$ is contained in \mathcal{U}_2 . Therefore $r\beta$ is in \mathcal{U}_2 and $r\beta\alpha^{m-1}$ is in $\mathcal{U}_2\alpha^{m-1}$. Also

$$r\tau^{-1}\alpha\tau = r\alpha\beta\alpha^{m-1} = r\beta\alpha^{m-1}$$

As $r\tau^{-1} \in \mathcal{U}_2$ then $r\tau^{-1}\alpha$ is in $\mathcal{U}_2\alpha$, which is either \mathcal{U}_1 or \mathcal{U}_3 . Therefore $r\tau^{-1}\alpha\tau$ is either in $\mathcal{U}_1\tau \subset \mathcal{U}_1$ or in $\mathcal{U}_3\tau$ again a subset of \mathcal{U}_1 . So $r\tau^{-1}\alpha\tau \in \mathcal{U}_1$. Therefore $\mathcal{U}_2\alpha^{m-1} \cap \mathcal{U}_1 \neq \emptyset$. But both are components of $T - \{r\}$, because $r\alpha = r$, so it follows that they are equal. As $\mathcal{U}_2 = \mathcal{U}_1\alpha$ then

$$\mathcal{U}_1\alpha\alpha^{m-1} = \mathcal{U}_1, \quad \text{or} \quad \mathcal{U}_1\alpha^m = \mathcal{U}_1, \quad \mathcal{U}_2\alpha^m = \mathcal{U}_2, \quad \mathcal{U}_3\alpha^m = \mathcal{U}_3 \quad \text{if needed.}$$

In case $r \neq y$ this immediately implies m even.

Now use $r\tau\gamma\beta\alpha^m = r\alpha\tau = r\tau \in \mathcal{U}_1$. Therefore $r\tau\gamma\beta \in \mathcal{U}_1\alpha^m = \mathcal{U}_1$. It follows that

$$r\tau^{-1} \prec r \prec r\tau\gamma\beta$$

– recall this means r separates $r\tau^{-1}$ from $r\tau\gamma\beta$. Applying β^{-1} one gets

$$r\tau^{-1} \prec r\beta^{-1} \prec r\tau\gamma \quad (*)$$

Use $r\beta^{-1} = r\tau\alpha\tau^{-1}$:

$$r\tau \in \mathcal{U}_1 \Rightarrow r\tau\alpha \in \mathcal{U}_2, \quad r\beta^{-1} = r\tau\alpha^{-1}\tau^{-1} \in \mathcal{V}_2.$$

As $r\tau^{-1}$ is an accumulation point of \mathcal{V}_2 , equation (*) above implies that $r\tau\gamma$ is in \mathcal{V}_2 or $r\tau\gamma < r\tau^{-1}$ in \mathcal{A}_κ , which immediately implies $p > 2q$.

As in the **R**-covered case, look at $r\tau\alpha$. If $r\tau\alpha$ is not in \mathcal{V}_2 then $r\tau\alpha\tau \notin \mathcal{U}_2$ so

$$r\tau\alpha\tau = (r\tau^2)\tau^{-1}\alpha\tau = (r\tau^2)\gamma\beta\alpha^m \notin \mathcal{U}_2 \quad \text{and} \quad r\tau\gamma\beta \notin \mathcal{U}_2.$$

So $r\tau^{-1} \prec r \preceq r\tau^2\gamma\beta$ and $r\tau^2\gamma \preceq r\beta^{-1} \prec r\tau^{-1}$. As $r\beta^{-1} = r\tau\alpha\tau^{-1} \in \mathcal{V}_2$, then

$$r\tau^2\gamma \in \mathcal{V}_2, \quad \text{so} \quad r\tau^2\gamma < r\tau^{-1} \quad \text{in} \quad \mathcal{A}_\kappa.$$

As seen before this implies $p > 3q$, which is disallowed and finishes this case.

If $r\tau\alpha \in \mathcal{V}_2$ then $r\beta^{-1} \in \mathcal{V}_2\tau^{-1}$. By (*) $r\tau^{-1} \prec r\beta^{-1} \prec r\tau\gamma$, so

$$r\tau\gamma \in \mathcal{V}_2\tau^{-1} \Rightarrow r\tau\gamma < r\tau^{-2} \text{ in } \mathcal{A}_\kappa.$$

As seen before this also implies $p > 3q$ contradiction.

This finishes the analysis of the case $\mathcal{U}_1\alpha = \mathcal{U}_2$.

Now suppose that $\mathcal{U}_2\alpha = \mathcal{U}_1$. If $\mathcal{U}_1\alpha = \mathcal{U}_2$, then this is taken care by the previous situation. So now assume $\mathcal{U}_2\alpha^{-1} = \mathcal{U}_3$ which is not \mathcal{U}_1 or \mathcal{U}_2 .

Here use $r\tau^{-1}\alpha\tau = r\alpha\beta\alpha^{m-1} = r\tau\alpha^{-1}\tau^{-1}\alpha^{m-1}$. First

$$r\tau^{-1} \in \mathcal{U}_2 \Rightarrow r\tau^{-1}\alpha \in \mathcal{U}_2\alpha = \mathcal{U}_1 \Rightarrow r\tau^{-1}\alpha\tau \in \mathcal{U}_1.$$

On the other hand

$$r\tau \in \mathcal{U}_1 \Rightarrow r\tau\alpha^{-1} \in \mathcal{U}_1\alpha^{-1} = \mathcal{U}_2 \Rightarrow r\tau\alpha^{-1}\tau^{-1} \in \mathcal{U}_2\tau^{-1} \subset \mathcal{U}_2 \Rightarrow r\tau\alpha^{-1}\tau^{-1}\alpha^{m-1} \in \mathcal{U}_2\alpha^{m-1}.$$

From which we conclude that $\mathcal{U}_2\alpha^{m-1} = \mathcal{U}_1 = \mathcal{U}_2\alpha$.

Now use $r\tau^{-1}\alpha\tau = r\gamma\beta\alpha^m$. The right side is in $\mathcal{U}_1 = \mathcal{U}_2\alpha$. The fact that $\mathcal{U}_2\alpha^{-1}$ is not \mathcal{U}_1 implies that $\mathcal{V}_2\beta$ is not \mathcal{V}_1 , hence $\mathcal{V}_2\beta$ is contained in \mathcal{U}_2 . We know that $r\gamma$ is $\leq r\tau^{-1}$ in $\mathcal{L}\mathcal{A}_\tau$ so it is either in \mathcal{V}_2 or is equal to $r\tau^{-1}$. Hence $r\gamma\beta$ is either $r\tau^{-1}$ or is in $\mathcal{V}_2\beta$ – in either case it is in \mathcal{U}_2 . Finally $r\gamma\beta\alpha^m$ is in $\mathcal{U}_2\alpha^m$ which must be \mathcal{U}_1 . But then $\mathcal{U}_2\alpha^m = \mathcal{U}_2\alpha^{m-1}$ contradiction.

This finishes the analysis of the case $\mathcal{U}_2\alpha = \mathcal{U}_1$ and so finishes the proof of lemma 6.2. \square

This finishes the analysis of situation II.

Situation I –

In this case $x\alpha^{-1}\tau^{-1} < y\alpha^{-1}$ in \mathcal{A}_κ and $y < x\tau$ in \mathcal{A}_κ . In addition

$$y\tau = y\alpha^{-1}, \quad x\alpha^{-1}\tau^{-1}\alpha = x\tau\alpha^{-1}\tau^{-1} \quad (*)$$

Here $x\alpha^{-1} > y\alpha^{-1} = y\tau$ in \mathcal{A}_κ (orientation reversing case) so $x\alpha^{-1}\tau^{-1} > y$ in \mathcal{A}_κ . Therefore $x\alpha^{-1}\tau^{-1} \in (y, y\alpha^{-1})$. Also $x\tau < y\tau = y\alpha^{-1}$ in \mathcal{A}_κ , so one concludes

$$x\alpha^{-1}\tau^{-1}, \quad x\tau \in (y, y\alpha^{-1})$$

On the other hand $y \prec y\alpha^{-1} \prec x\alpha^{-1}$, so $y\alpha \prec y \prec x$ and $y\alpha$ is in $\mathcal{A}_\kappa\alpha - \mathcal{A}_\kappa$. It follows that $y\alpha^{-1} \prec y \prec y\alpha$ and y is in a local axis $\mathcal{L}\mathcal{A}_\alpha$ for α . This implies that the translates $[y\alpha^i, y\alpha^{i+1})$ are all disjoint (as i varies in \mathbf{Z}). Use the relation $\tau^{-1}\alpha\tau = \alpha\tau\alpha^{-1}\tau^{-1}\alpha^{m-1}$ in the form

$$\alpha^{-1}\tau^{-1}\alpha\tau\alpha^{1-m} = \tau\alpha^{-1}\tau^{-1}$$

applied to x to get

$$(x\alpha^{-1}\tau^{-1}\alpha)\tau\alpha^{1-m} = x\tau\alpha^{-1}\tau^{-1} \quad (**)$$

Now apply the second equality of (*) both sides of (**) to get

$$(x\tau\alpha^{-1}\tau^{-1})\tau\alpha^{1-m} = x\alpha^{-1}\tau^{-1}\alpha \quad \text{or} \quad (x\tau)\alpha^{-m} = (x\alpha^{-1}\tau^{-1})\alpha.$$

But $x\tau \in (y, y\alpha^{-1})$, so $x\tau\alpha^{-m} \in (y, y\alpha^{-1})\alpha^{-m}$. Similarly $x\alpha^{-1}\tau^{-1}\alpha$ is in $(y, y\alpha^{-1})\alpha$. Since they are equal then $-m = 1$ or $m = -1$, impossible.

Situation III –

Here $x\tau = y$, $x\alpha^{-1}\tau^{-1} = y\alpha^{-1}$ and

$$\mathcal{A}_\kappa u \cap \mathcal{A}_\kappa = [y, z] = [t, y\alpha^{-1}\tau^{-1}]$$

and if $t \neq y$, then $<$, $<_u$ disagree on $\mathcal{A}_\kappa u \cap \mathcal{A}_\kappa$.

Notice that $y \leq z = y\alpha^{-1}\tau^{-1}$ so $y < y\alpha^{-1}$ in \mathcal{A}_κ , and $y\alpha^{-1}$ is in $\mathcal{A}_\kappa - \mathcal{A}_\kappa\alpha$. Also $y\tau \leq y\alpha^{-1}$ in \mathcal{A}_κ . Now

$$y < y\alpha^{-1} < x\alpha^{-1} \Rightarrow x < y < y\alpha \quad \text{all in } \mathcal{A}_\kappa\alpha.$$

Hence $y\alpha <_u y$ in \mathcal{A}_κ and $y\alpha$ is in $\mathcal{A}_\kappa\alpha - \mathcal{A}_\kappa$. Hence y is in $(y\alpha^{-1}, y\alpha)$ and there is a local axis $\mathcal{L}\mathcal{A}_\alpha$ of α with y in $\mathcal{L}\mathcal{A}_\alpha$. Consider the relation $\tau^{-1}\alpha\tau = \alpha\beta\alpha^{m-1}$. Substitute $\beta = \tau\alpha^{-1}\tau^{-1}$ and rearrange the terms to get $\alpha^{-1}\tau^{-1}\alpha = \tau\alpha^{-1}\tau^{-1}\alpha^{m-1}\tau^{-1}$. Now apply it to x :

$$y = x\alpha^{-1}\tau^{-1}\alpha = x\tau\alpha^{-1}\tau^{-1}\alpha^{m-1}\tau^{-1},$$

or $y\tau\alpha^{1-m} = y\alpha^{-1}\tau^{-1}$. Now $y\tau \in [y, y\alpha^{-1}]$, so $y\tau$ is in $\mathcal{L}\mathcal{A}_\alpha$ and

$$y\tau\alpha^{1-m} \in [y\alpha^{1-m}, y\alpha^{-m}],$$

so $y\tau\alpha^{1-m}$ is not in \mathcal{A}_κ . But $y\alpha^{-1}\tau^{-1}$ is in \mathcal{A}_κ , contradiction.

This finishes the analysis of $\mathcal{A}_\kappa u \cap \mathcal{A}_\kappa = [x, y]$ with x not equal y . Consequently this finishes the analysis of Case A, τ acts freely, which we now proved cannot happen.

7 Case B – τ has a fixed point, α acts freely

Here α has an (actual) axis \mathcal{A}_α and so does β with axis $\mathcal{A}_\beta = \mathcal{A}_\alpha\tau^{-1}$. Let $Fix(\tau)$ be the set of fixed points of τ . As usual there are various possibilities. This case is very interesting because the topology of the manifold $M_{p/q}$ will play a key role.

Recall that if t is a point not in a connected set B of the tree T , then the segment $[t, u]$ is the bridge from t to B if the subsegment $[x, u]$ does not intersect B and if u is either in B or is an accumulation point of B . Again the important fact is that the bridge from x to B is unique: it is the only embedded path from x to B because T is a tree. As in case A this will be explored here. If u is in B we say that t bridges to u in B .

We say that a point a is an ideal point of a local axis l if a is not in l but is an accumulation point of l . Obviously this implies that l is not properly embedded in T in the side accumulating to a .

There are two main cases depending on whether $Fix(\tau)$ intersects \mathcal{A}_α or not.

Case B.1 – $Fix(\tau) \cap \mathcal{A}_\alpha = \emptyset$.

Then κ also has a fixed point s . Choose s closest to \mathcal{A}_α , that is, the bridge $[s, c]$ from s to \mathcal{A}_α has no other fixed point of κ . Let z in $[s, c]$ fixed by τ and closest to \mathcal{A}_α , that is, the bridge $[z, c]$ from z to \mathcal{A}_α has no other fixed point of τ besides z . A priori we do not know whether z is equal to s or not. Let \mathcal{U} be the component of $T - \{z\}$ containing \mathcal{A}_α .

Then \mathcal{A}_β is a subset of $\mathcal{U}\tau \neq \mathcal{U}$ and z bridges to $c\tau^{-1}$ in \mathcal{A}_β .

Case B.1.1 – Suppose $\mathcal{U}\tau \neq \mathcal{U}$.

Then $\mathcal{U}\tau^{-1} \neq \mathcal{U}$ as well. Apply $\alpha\tau = \tau\alpha\beta\alpha^{m-1}$ to z : the point z bridges to c in \mathcal{A}_α , so $z\alpha$ bridges to $c\alpha$ in \mathcal{A}_α . As $c\alpha$ is not c then $z\alpha$ is in \mathcal{U} , so $z\alpha\tau$ is in $\mathcal{U}\tau$, see fig. 9, a. On the other hand $z\tau\alpha = z\alpha$ is in \mathcal{U} and hence z separates it from \mathcal{A}_β . It follows that $z\alpha$ also bridges to $c\tau^{-1}$ in \mathcal{A}_β . Then

$$z\alpha\tau\beta \text{ bridges to } c\tau^{-1}\beta \text{ in } \mathcal{A}_\beta \text{ and } c\tau^{-1}\beta \neq c\tau^{-1}, \text{ so } z\tau\alpha\beta \in \mathcal{U}\tau^{-1}.$$

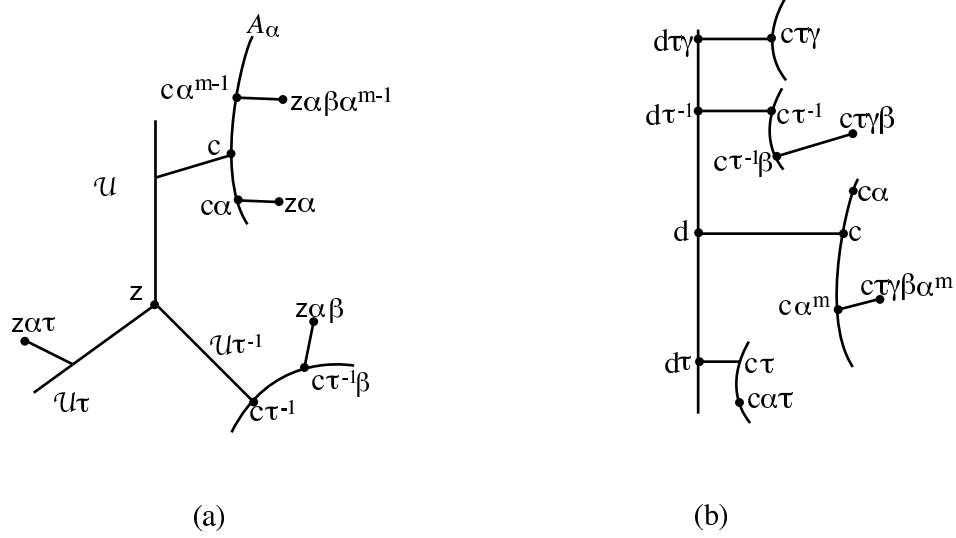

Figure 9: a. The case $\mathcal{U}\tau \neq \mathcal{U}$, b. The case $\mathcal{L}\mathcal{A}_\tau \cap \mathcal{A}_\alpha = \emptyset$.

Therefore $z\tau\alpha\beta$ bridges to c in \mathcal{A}_α , so $z\tau\alpha\beta\alpha^{m-1}$ bridges to $c\alpha^{m-1}$ in \mathcal{A}_α . This implies $z\tau\alpha\beta\alpha^{m-1}$ is in \mathcal{U} , impossible since it is equal to $z\alpha\tau \in \mathcal{U}\tau$.

We conclude that $\mathcal{U}\tau = \mathcal{U}$, which will be assumed from now on in this proof.

Choose a prong η at z which is a subset of $[z, c]$. This prong is associated to the component \mathcal{U} of $T - \{z\}$, hence the prong $\eta\tau$ also is associated to the component $\mathcal{U} = \mathcal{U}\tau$ and $\eta \cap \eta\tau$ is not just z . Let e be another point in the intersection. Then $e\tau^{-1}, e$ are both in η and $e\tau^{-1}$ is not equal e – by choice of z as the fixed point of τ in $[z, c]$ closest to \mathcal{A}_α . So either e is in $[z, e\tau)$ or $e\tau$ is in $[z, e)$. In the first case (say) apply τ to get $e\tau$ is in $[z, e\tau^2)$ and it now follows that $e \prec e\tau \prec e\tau^2$. The same alignment of points happens in the second case. We conclude that there is a local axis $\mathcal{L}\mathcal{A}_\tau$ for τ , with e in the local axis.

This construction of a local axis is crucial in case B and also in case C of the proof.

Conclusion – If $\mathcal{U}\tau = \mathcal{U}$ and there is no fixed point of τ in $(z, w]$, then there is a local axis of τ contained in \mathcal{U} with one ideal point z .

Case B.1.2 – Suppose that $\mathcal{L}\mathcal{A}_\tau \cap \mathcal{A}_\alpha$ is at most one point.

Let $[d, c]$ be the bridge from $\mathcal{L}\mathcal{A}_\tau$ to \mathcal{A}_α – here $d = c$ if $\mathcal{L}\mathcal{A}_\tau \cap \mathcal{A}_\alpha$ is a single point. We do the proof for $\mathcal{L}\mathcal{A}_\tau \cap \mathcal{A}_\alpha = \emptyset$, the case of single point intersection being entirely similar. The bridge from $c\alpha\tau$ to $\mathcal{L}\mathcal{A}_\tau$ is $[c\alpha\tau, d\tau]$, see fig. 9, b. Now the bridge from $c\tau\gamma$ to $\mathcal{L}\mathcal{A}_\tau$ is $[c\tau\gamma, d\tau\gamma]$. Here use p odd to get $d\tau\gamma \neq d\tau^{-1}$, so the bridge from $c\tau\gamma$ to \mathcal{A}_β is $[c\tau\gamma, c\tau^{-1}]$. Therefore

$$c\tau\gamma\beta \text{ bridges to } c\tau^{-1}\beta \text{ in } \mathcal{A}_\beta, \text{ hence bridges to } d\tau^{-1} \text{ in } \mathcal{L}\mathcal{A}_\tau \text{ and to } c \text{ in } \mathcal{A}_\alpha.$$

Finally $c\tau\gamma\beta\alpha^m$ bridges to \mathcal{A}_α in $c\alpha^m \neq c$ and so bridges to $\mathcal{L}\mathcal{A}_\tau$ in c .

As $c\alpha\tau = c\tau\gamma\beta\alpha^m$, this implies $c = c\tau$, impossible. This rules out this case.

We conclude that $\mathcal{L}\mathcal{A}_\tau \cap \mathcal{A}_\alpha$ is more than one point. If $\mathcal{L}\mathcal{A}_\tau \cap \mathcal{A}_\alpha$ is $(z, d]$, then either $z\alpha = z$ or α has a fixed point in $\mathcal{L}\mathcal{A}_\tau$, both impossible. Therefore from now on in case B.1 let $\mathcal{L}\mathcal{A}_\tau \cap \mathcal{A}_\alpha = [a, b]$, with $a \neq z$ and a closest to z . By an abuse of notation b can be $+\infty$, meaning the intersection is a ray in $\mathcal{L}\mathcal{A}_\tau$. Put an order $<$ in $\mathcal{L}\mathcal{A}_\tau$ so that $a < b$ in $\mathcal{L}\mathcal{A}_\tau$. Also let $<_\alpha$ be the order in \mathcal{A}_α with $a <_\alpha b$.

From now on in case B.1 the proof will depend on whether $\mathcal{U}\gamma$ is equal to \mathcal{U} or not. The arguments here are also very similar to what will be needed for case C, therefore we will make the arguments in more generality so that they can be used in case C, namely when α has a fixed point but has a local axis with certain properties. We first specify the conditions under which the analysis works.

Conditions – Consider two conditions:

Condition F – τ has a fixed point z , α acts freely and z is not in the axis \mathcal{A}_α . Let \mathcal{A}_α be in the component \mathcal{U} of $T - \{z\}$. There is a fixed point s of κ so that s is either z or z separates s from \mathcal{A}_α . Let $(s, c]$ be the bridge from s to \mathcal{A}_α . Then $(s, c]$ has no fixed point of κ and $(z, c]$ has no fixed point of τ . Also $\mathcal{U}\tau = \mathcal{U}$ and there is a local axis $\mathcal{L}\mathcal{A}_\tau$ of τ in \mathcal{U} with ideal point z . Finally $\mathcal{L}\mathcal{A}_\tau \cap \mathcal{A}_\alpha = [a, b]$ where $a \neq z$ and a is in (z, b) .

Condition N – τ has a fixed point z ; κ has a fixed point s and α has a fixed point w so that (s, w) has no fixed point of either κ or α . In addition either $z = s$ or $z \in (s, w)$ and (z, w) has no fixed point of τ . In addition let \mathcal{U} be $T_z(w)$ and \mathcal{V} be $T_w(z)$. Then $\mathcal{U}\tau = \mathcal{U}$ and $\mathcal{V}\alpha = \mathcal{V}$. There is a local axis $\mathcal{L}\mathcal{A}_\tau$ of τ in \mathcal{U} with one ideal point z and a local axis $\mathcal{L}\mathcal{A}_\alpha$ of α in \mathcal{V} with ideal point w . The intersection of $\mathcal{L}\mathcal{A}_\alpha$ and $\mathcal{L}\mathcal{A}_\tau$ is $[a, b]$ where a is the closest point to z and b can be $+\infty$ in $\mathcal{L}\mathcal{A}_\tau$.

Here condition F is for free action of α (which is used here) and condition N is for non free action of α (which is used in Case C). In either case the order $<_\alpha$ in $\mathcal{L}\mathcal{A}_\alpha$ corresponds to $a <_\alpha b$. This implies the orders $<, <_\alpha$ coincide in the intersection. Beware that the order $<_\alpha$ here is in $\mathcal{L}\mathcal{A}_\alpha$ and not in $(\mathcal{A}_\tau)\alpha$ as in case A.

Caution – An axis is also a local axis. For the sake of simplicity and to use it for case C, we will use the notation $\mathcal{L}\mathcal{A}_\alpha$ even in the case of α acting freely for the rest of the proof of case B.1. In case B.2, we will return to use the notation \mathcal{A}_α for the axis of α .

Case B.1.3 – $\mathcal{U}\gamma \neq \mathcal{U}$.

We first claim that this implies that $\mathcal{U}\gamma \cap \mathcal{U}$ is empty. Recall that $\partial\mathcal{U} = z$ and $z\tau = z$. Notice we do not know a priori that $z\gamma = z$. If $z\gamma = z$ then γ permutes the components of $T - \{z\}$ so one has $\mathcal{U}\gamma \cap \mathcal{U} = \emptyset$. Suppose then that $z\gamma$ is not z . Recall that there is a fixed point s of κ with $z \in [s, w]$ – maybe $s = z$. If $z\gamma \neq z$, then

$$[s, z] \cap [s, z\gamma] = [s, t] \quad \text{with } t \in [s, z), \quad \text{hence } t \in (z, z\gamma).$$

In particular z is not equal to s . Notice t may be equal to s . Here z separates \mathcal{U} from s , hence z separates \mathcal{U} from t . Also $z\gamma$ separates $\mathcal{U}\gamma$ from s , hence $z\gamma$ separates $\mathcal{U}\gamma$ from t . It follows that t separates \mathcal{U} from $\mathcal{U}\gamma$ and $\mathcal{U} \cap \mathcal{U}\gamma = \emptyset$. This proves the claim.

Situation I – Suppose $a\alpha <_\alpha a$ in $\mathcal{L}\mathcal{A}_\alpha$.

Situation I.1 – Suppose $a\alpha^{-1} >_\alpha b$ in $\mathcal{L}\mathcal{A}_\alpha$, see fig. 10, a.

This implies that $a\alpha$ is not in $\mathcal{L}\mathcal{A}_\tau$, see fig. 10, a. Also this implies b is finite. Notice that

$$z\tau^{-1}\alpha^{-1}\tau = z\alpha^{-m}\beta^{-1}\gamma^{-1} = z\alpha^{-m}\tau\alpha\tau^{-1}\gamma^{-1}$$

The point z bridges to $\mathcal{L}\mathcal{A}_\alpha$ in a . Hence $z\tau^{-1}\alpha^{-1} = z\alpha^{-1}$ bridges to $\mathcal{L}\mathcal{A}_\alpha$ in $a\alpha^{-1}$, so $z\alpha^{-1}$ is in \mathcal{U} and $z\alpha^{-1}\tau$ is also in \mathcal{U} , which is invariant under τ . Since $\mathcal{U}\gamma \cap \mathcal{U} = \emptyset$, then

$$z\alpha^{-m}\tau\alpha \notin \mathcal{U} \quad \text{and it bridges to } \mathcal{L}\mathcal{A}_\alpha \text{ in } a \Rightarrow z\alpha^{-m}\tau \text{ bridges to } \mathcal{L}\mathcal{A}_\alpha \text{ in } a\alpha^{-1}$$

and hence bridges to $\mathcal{L}\mathcal{A}_\tau$ in b . But $z\alpha^{-m}$ bridges to $\mathcal{L}\mathcal{A}_\alpha$ in $a\alpha^{-m}$ so bridges to $\mathcal{L}\mathcal{A}_\tau$ in a . So $z\alpha^m\tau$ bridges to $\mathcal{L}\mathcal{A}_\tau$ in $a\tau$. This implies $a\tau = b$ and also that τ is increasing in $(\mathcal{L}\mathcal{A}_\tau, <)$.

In addition

$$\mathcal{L}\mathcal{A}_\beta = (\mathcal{L}\mathcal{A}_\alpha)\tau^{-1} \quad \text{so } \mathcal{L}\mathcal{A}_\beta \cap \mathcal{L}\mathcal{A}_\tau = [a\tau^{-1}, a] = [a\tau^{-1}, b\tau^{-1}]$$

and $a\beta^{-1}$ is not in $\mathcal{L}\mathcal{A}_\tau$ and bridges to $\mathcal{L}\mathcal{A}_\tau$ in $a\tau^{-1}$. So this point bridges to $\mathcal{L}\mathcal{A}_\alpha$ in a and $a\beta^{-1}\alpha^{-1}$ bridges to $\mathcal{L}\mathcal{A}_\alpha$ in $a\alpha^{-1}$. As a result $a\beta^{-1}\alpha^{-1}$ is in \mathcal{U} .

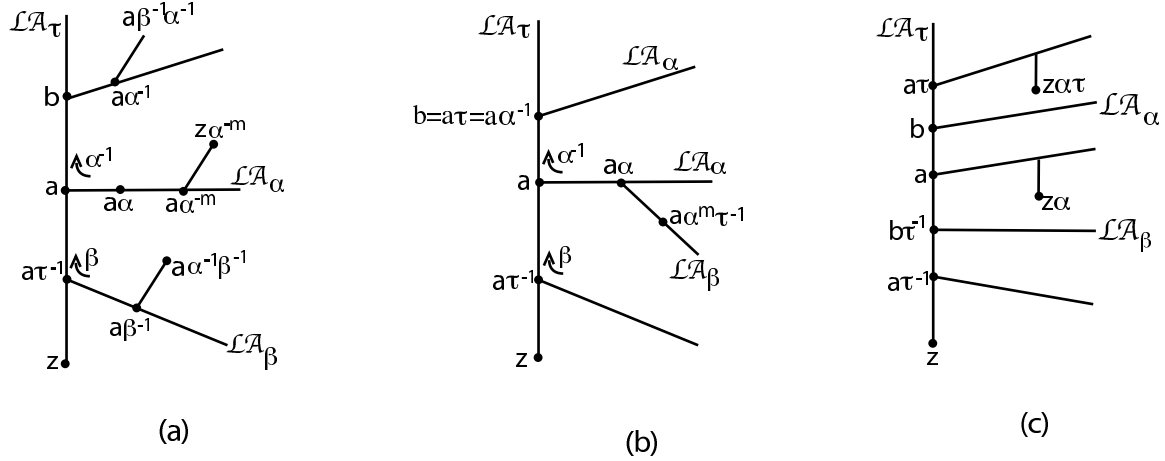

Figure 10: The case $\mathcal{L}A_\alpha \cap \mathcal{L}A_\tau = [a, b]$: a. Case $a\alpha <_\alpha a$, $b <_\alpha a\alpha^{-1}$, b. Case $b = a\tau = a\alpha^{-1}$, c. Case $a\tau > b$.

Also $a\alpha^{-1}$ bridges to $\mathcal{L}A_\tau$ in $b = a\tau$. Hence it bridges to $\mathcal{L}A_\beta$ in a . This implies that $a\alpha^{-1}\beta^{-1}$ bridges to $\mathcal{L}A_\beta$ in $a\beta^{-1}$ so again $a\alpha^{-1}\beta^{-1}$ is in \mathcal{U} . Now $(a\beta^{-1}\alpha^{-1})\gamma = a\alpha^{-1}\beta^{-1}$. Which implies $\mathcal{U}\gamma \cap \mathcal{U}$ is not empty. This contradicts the first claim in Case B.1.3.

Situation I.1 cannot happen.

Situation I.2 – Suppose $a\alpha^{-1} \leq_\alpha b$ in $\mathcal{L}A_\alpha$.

Similarly to the arguments in situation I.1, $z\alpha^{-1}\tau$ is in \mathcal{U} , so $z\alpha^{-m}\tau\alpha$ is not in \mathcal{U} so

$$z\alpha^{-m}\tau\alpha \text{ bridges to } \mathcal{L}A_\alpha \text{ in } a, \quad z\alpha^{-m}\tau \text{ bridges to } \mathcal{L}A_\alpha \text{ in } a\alpha^{-1}.$$

Also $a\alpha^{-1} \leq_\alpha b$ in $\mathcal{L}A_\alpha$, hence $a\alpha^{-1}$ is in $\mathcal{L}A_\tau$ and $a\alpha^{-1} \leq b$ in $\mathcal{L}A_\tau$ as well. On the other hand $z\alpha^{-m}$ bridges to $\mathcal{L}A_\tau$ in a so $z\alpha^{-m}\tau$ bridges to $\mathcal{L}A_\tau$ in $a\tau$. From this it follows that $a\tau \geq a\alpha^{-1}$ in $\mathcal{L}A_\tau$. There are two possibilities:

The first possibility is that $a\alpha^{-1} \neq b$. In this case $z\alpha^{-m}\tau$ bridges to $\mathcal{L}A_\alpha$ in $a\alpha^{-1}$ which is in the interior of $[a, b]$, hence this point also bridges to $\mathcal{L}A_\tau$ in $a\alpha^{-1}$. It follows that

$$a\tau = a\alpha^{-1} \Rightarrow a\beta^{-1} = a\tau^{-1} \text{ bridges to } \mathcal{L}A_\alpha \text{ in } a.$$

Then $a\beta^{-1}\alpha^{-1}$ bridges to $\mathcal{L}A_\alpha$ in $a\alpha^{-1}$ so is in \mathcal{U} . As before consider $a\alpha^{-1}\beta^{-1}$. Here $a\alpha^{-1}$ is either in $\mathcal{L}A_\beta$ or bridges to $\mathcal{L}A_\beta$ in $b\tau^{-1}$ (the top intersection of $\mathcal{L}A_\beta$ with $\mathcal{L}A_\tau$). If $a\alpha^{-1}$ in $\mathcal{L}A_\beta$ then $a\alpha^{-1}\beta^{-1}$ is in $\mathcal{L}A_\beta$ so in \mathcal{U} , as above contradiction. If it bridges to $\mathcal{L}A_\beta$ in $b\tau^{-1}$ then $a\alpha^{-1}\beta^{-1}$ bridges to $\mathcal{L}A_\beta$ in $b\tau^{-1}\beta^{-1} = b\alpha\tau^{-1}$. Since in this case

$$b\alpha > a \text{ in } \mathcal{L}A_\tau, \text{ then } b\alpha\tau^{-1} > a\tau^{-1} \text{ in } \mathcal{L}A_\tau \Rightarrow a\alpha^{-1}\beta^{-1} \in \mathcal{U},$$

again a contradiction.

The second possibility is that $a\alpha^{-1} = b$. Here we have to split further into two options:

Recall that $a\tau \geq a\alpha^{-1}$ in $\mathcal{L}A_\tau$. First consider the case that $a\tau = a\alpha^{-1}$, see fig. 10, b. We have the equalities $a\beta^{-1} = a\tau\alpha\tau^{-1} = a\tau^{-1}$. Use

$$(a\alpha^m)\tau^{-1}\alpha^{-1}\tau = a\alpha^m\alpha^{-m}\beta^{-1}\gamma^{-1} = a\beta^{-1}\gamma^{-1} = a\tau^{-1}\gamma^{-1} \notin \mathcal{U}$$

Hence $a\alpha^m\tau^{-1}\alpha^{-1}$ is not in \mathcal{U} and bridges to $\mathcal{L}A_\alpha$ in a , $a\alpha^m\tau^{-1}$ bridges to $\mathcal{L}A_\alpha$ in $a\alpha$. But

$$a\alpha^m \in \mathcal{L}A_\alpha \Rightarrow a\alpha^m\tau^{-1} \in \mathcal{L}A_\beta \Rightarrow \mathcal{L}A_\alpha \cap \mathcal{L}A_\beta = [a, a\alpha],$$

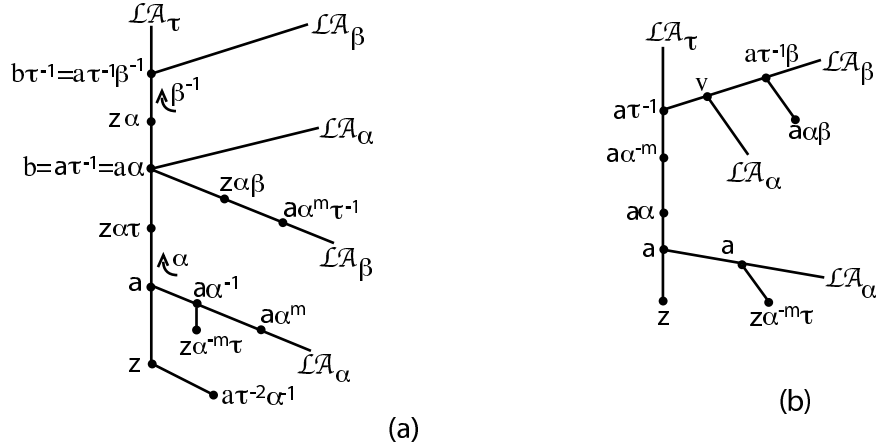

Figure 11: Case $a\alpha^{-1} <_{\alpha} a$ in \mathcal{LA}_{α} : a. Picture when $a\alpha^{-m} \notin \mathcal{LA}_{\tau}$, $a\alpha = a\tau^{-1}$, b. Picture when $a\alpha^{-m} \in \mathcal{LA}_{\tau}$, $a\tau^{-1}\beta \notin \mathcal{LA}_{\alpha}$.

see fig. 10, b. Now evaluate $\gamma^{-1} = \beta\alpha\beta^{-1}\alpha^{-1}$ on $a\tau^{-1}$:

$$(a\tau^{-1})\gamma^{-1} = (a\beta^{-1})\beta\alpha\beta^{-1}\alpha^{-1} = a\alpha\beta^{-1}\alpha^{-1}.$$

Notice that $a\alpha$ is in \mathcal{LA}_{β} so $a\alpha\beta^{-1}$ is in \mathcal{LA}_{β} . Either $a\alpha\beta^{-1}$ is in \mathcal{LA}_{α} and then $a\alpha\beta\alpha^{-1}$ is in $\mathcal{LA}_{\alpha} \subset \mathcal{U}$ (contradiction) – or

$$a\alpha\beta^{-1} \notin \mathcal{LA}_{\alpha} \text{ so bridges to } \mathcal{LA}_{\alpha} \text{ in } a \text{ and } a\alpha\beta\alpha^{-1} \text{ bridges to } \mathcal{LA}_{\alpha} \text{ in } a\alpha^{-1}$$

and again this point is in \mathcal{U} . In either case $\mathcal{U}\gamma \cap \mathcal{U} \neq \emptyset$, contradiction.

The last option of the second possibility $a\alpha^{-1} = b$ is that $a\tau > b = a\alpha^{-1}$ in \mathcal{LA}_{τ} . Then

$$b\tau^{-1} = a\tau^{-1}\beta < a \text{ in } \mathcal{LA}_{\tau} \Rightarrow \mathcal{LA}_{\alpha} \cap \mathcal{LA}_{\beta} = \emptyset,$$

see fig. 10, c. Here use $\alpha\tau = \tau\alpha\beta\alpha^{m-1}$ applied to z : The point $z\alpha$ bridges to a in \mathcal{LA}_{τ} and $z\alpha\tau$ bridges to $a\tau$ in \mathcal{LA}_{τ} . Since $a\tau > b$, then $z\alpha\tau$ bridges to $b = a\alpha^{-1}$ in \mathcal{LA}_{α} .

On the other hand $z\alpha$ bridges to $b\tau^{-1}$ in \mathcal{LA}_{β} hence $z\alpha\beta$ bridges to $b\tau^{-1}\beta$ in \mathcal{LA}_{β} , hence to a in \mathcal{LA}_{α} . Finally $z\alpha\beta\alpha^{m-1}$ bridges to $a\alpha^{m-1}$ in \mathcal{LA}_{α} . Since m is not 0 this is a contradiction.

We conclude that situation I cannot happen.

Situation II – $a\alpha^{-1} <_{\alpha} a$ in \mathcal{LA}_{α} .

Situation II.1 – $a\alpha^{-m}$ is not in \mathcal{LA}_{τ} . Here use

$$z\alpha^{-1}\tau = z\tau^{-1}\alpha^{-1}\tau = z\alpha^{-m}\tau\alpha\tau^{-1}\gamma^{-1}$$

is in \mathcal{U} , so $z\alpha^{-m}\tau\alpha$ is not in \mathcal{U} . It bridges to \mathcal{LA}_{α} in a , hence $z\alpha^{-m}\tau$ bridges to \mathcal{LA}_{α} in $a\alpha^{-1}$ and hence bridges to \mathcal{LA}_{τ} in a . On the other hand $z\alpha^{-m}$ bridges to \mathcal{LA}_{α} in $a\alpha^{-m}$, so bridges to \mathcal{LA}_{τ} in b . It follows that $z\alpha^{-m}\tau$ bridges to \mathcal{LA}_{τ} in $b\tau$ which then must be a . So $a < a\tau^{-1}$ in \mathcal{LA}_{τ} .

Notice $\mathcal{LA}_{\beta} \cap \mathcal{LA}_{\tau}$ is equal to $[a\tau^{-1}, b\tau^{-1}]$ and this intersects \mathcal{LA}_{α} in $a\tau^{-1} = b$.

Suppose first that $a\alpha$ is not $a\tau^{-1} = b$. Here

$$a\beta^{-1} \text{ bridges to } \mathcal{LA}_{\beta} \text{ in } a\tau^{-1}\beta^{-1}, \text{ so bridges to } \mathcal{LA}_{\alpha} \text{ in } a\tau^{-1}.$$

Then $a\beta^{-1}\alpha^{-1}$ bridges to \mathcal{LA}_{α} in $a\tau^{-1}\alpha^{-1} \neq a$. It follows that $a\beta^{-1}\alpha^{-1}$ is in \mathcal{U} .

On the other hand $a\alpha^{-1}$ bridges to $\mathcal{L}\mathcal{A}_\beta$ in $a\tau^{-1} = b$, so $a\alpha^{-1}\beta^{-1}$ bridges to $\mathcal{L}\mathcal{A}_\beta$ in $b\beta^{-1}$ which is not b and it follows that $a\alpha^{-1}\beta^{-1}$ is also in \mathcal{U} . As seen before this implies $\mathcal{U}\gamma \cap \mathcal{U}$ is not emptyset, contradiction.

The second option in situation II.1 is that $a\alpha = a\tau^{-1}$, see fig. 11, a.

Apply $\alpha^{-m}\beta^{-1}\gamma^{-1} = \tau^{-1}\alpha^{-1}\tau$ to $a\alpha^m$. The right side becomes $a\beta^{-1}\gamma^{-1}$. Here

$$a\beta^{-1} \in \mathcal{U} \Rightarrow a\beta^{-1}\gamma^{-1} \notin \mathcal{U} \Rightarrow a\alpha^m\tau^{-1}\alpha^{-1} \notin \mathcal{U}$$

and bridges to $\mathcal{L}\mathcal{A}_\alpha$ in a . It follows that $a\alpha^m\tau^{-1}$ bridges to $\mathcal{L}\mathcal{A}_\alpha$ in $a\alpha = a\tau^{-1} = b$. But $a\alpha^m$ is in $\mathcal{L}\mathcal{A}_\alpha$, so $a\alpha^m\tau^{-1}$ is in $\mathcal{L}\mathcal{A}_\beta$. Consequently $\mathcal{L}\mathcal{A}_\alpha \cap \mathcal{L}\mathcal{A}_\beta = a\tau^{-1} = b$, see fig. 11, a.

The point $a\beta^{-1}$ is in \mathcal{U} , hence

$$a\beta^{-1}\gamma^{-1} = a\alpha\beta^{-1}\alpha^{-1} = a\tau^{-1}\beta^{-1}\alpha^{-1} = a\tau^{-2}\alpha^{-1}$$

is not in \mathcal{U} . Not only that, but also $a\beta^{-1}\gamma^{-1}$ is not equal to z – else some point near $a\beta^{-1}$ in \mathcal{U} will have image under γ in \mathcal{U} , which is disallowed. Then

$$z \in (a, a\tau^{-2}\alpha^{-1}) \Rightarrow z\alpha \in (a\alpha, a\tau^{-2}) = (a\tau^{-1}, a\tau^{-2}) \Rightarrow z\alpha\tau \in (a, a\tau^{-1}).$$

In particular $z\alpha\tau$ is in $\mathcal{L}\mathcal{A}_\alpha$ and $z\alpha\tau\alpha^{1-m}$ is in $\mathcal{L}\mathcal{A}_\alpha$ as well. This point is equal to $z\alpha\beta$.

On the other hand

$$z\alpha \in (a\tau^{-1}, a\tau^{-2}) = (a\tau^{-1}, a\tau^{-1}\beta^{-1}) \Rightarrow z\alpha\beta \in (a\tau^{-1}, a\tau^{-1}\beta).$$

But then $z\alpha\beta$ is not in $\mathcal{L}\mathcal{A}_\alpha$, contradiction.

This finishes the analysis of situation II.1, $a\alpha^{-m}$ is not in $\mathcal{L}\mathcal{A}_\tau$.

Situation II.2 – $a\alpha^{-m}$ is in $\mathcal{L}\mathcal{A}_\tau$.

In particular $a\alpha$ is in $(a, b]$. Here $z\alpha^{-m}\beta^{-1}\gamma^{-1} = z\tau^{-1}\alpha^{-1}\tau$ is in \mathcal{U} . As usual this implies $z\alpha^{-m}\tau\alpha$ is not in \mathcal{U} and bridges to $\mathcal{L}\mathcal{A}_\alpha$ in a and $z\alpha^{-m}\tau$ bridges to $\mathcal{L}\mathcal{A}_\alpha$ in $a\alpha^{-1}$, see fig. 11, b; so $z\alpha^{-m}\tau$ bridges to $\mathcal{L}\mathcal{A}_\tau$ in a . So

$$z\alpha^{-m} \text{ bridges to } \mathcal{L}\mathcal{A}_\tau \text{ in } a\tau^{-1} \Rightarrow a\tau^{-1} > a \text{ in } \mathcal{L}\mathcal{A}_\tau.$$

Notice $z\alpha^{-m}$ bridges to $\mathcal{L}\mathcal{A}_\alpha$ in $a\alpha^{-m}$. If $a\alpha^{-m} <_\alpha b$ in $\mathcal{L}\mathcal{A}_\alpha$, then $z\alpha^{-m}$ also bridges to $\mathcal{L}\mathcal{A}_\tau$ in $a\alpha^{-m}$ and $a\alpha^{-m} = a\tau^{-1}$. If

$$a\alpha^{-m} = b \text{ then } z\alpha^{-m} \text{ bridges to } \mathcal{L}\mathcal{A}_\tau \text{ in a point } \geq a\alpha^{-m},$$

that is, $a\tau^{-1} \geq a\alpha^{-m}$ in $\mathcal{L}\mathcal{A}_\tau$. In any case $a\alpha^{-m} \leq a\tau^{-1}$ in $\mathcal{L}\mathcal{A}_\tau$ and $a\alpha < a\tau^{-1}$ in $\mathcal{L}\mathcal{A}_\tau$.

Now compute $a\gamma = a\alpha\beta\alpha^{-1}\beta^{-1}$. Here $a\alpha$ is in $[a, a\tau^{-1}]$ and bridges to $\mathcal{L}\mathcal{A}_\beta$ in $a\tau^{-1}$. Hence $a\alpha\beta$ bridges to $\mathcal{L}\mathcal{A}_\beta$ in $a\tau^{-1}\beta$. There are two options: First if $a\tau^{-1}\beta$ is not in $\mathcal{L}\mathcal{A}_\alpha$, then $a\alpha\beta$ bridges to a point v in $\mathcal{L}\mathcal{A}_\alpha$ and $v \in (a, a\tau^{-1}\beta)$ – see fig. 12, b. Here v could be in $\mathcal{L}\mathcal{A}_\tau$. Then

$$a\alpha\beta\alpha^{-1} \text{ bridges to a point } v\alpha^{-1} \text{ in } \mathcal{L}\mathcal{A}_\alpha \Rightarrow \text{it bridges a point } c \text{ in } \mathcal{L}\mathcal{A}_\beta, c \in (b\tau^{-1}, a\tau^{-1}\beta).$$

It follows that $a\gamma = a\alpha\beta\alpha^{-1}\beta^{-1}$ bridges to a point in $\mathcal{L}\mathcal{A}_\beta$ which is not $a\tau^{-1}$, hence $a\gamma$ is in \mathcal{U} , contradiction.

The second option here is that $a\tau^{-1}\beta$ is in $\mathcal{L}\mathcal{A}_\alpha$. Here $a\tau^{-1}$ is in $\mathcal{L}\mathcal{A}_\alpha$. Then consider $a\tau^{-1}\alpha^{-1}$ which is in $\mathcal{L}\mathcal{A}_\alpha$ and hence in \mathcal{U} . Then

$$(a\tau^{-1}\alpha^{-1})\alpha\beta\alpha^{-1} = a\tau^{-1}\beta\alpha^{-1}$$

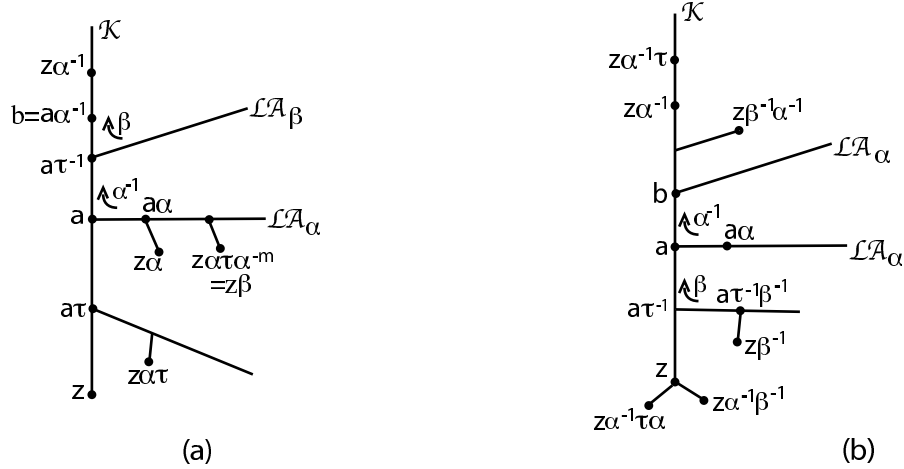

Figure 12: *Analysing $z\alpha^{-1} \in \mathcal{K}$: a. Picture when $a\tau \in [z, a)$, b. Picture when $a\tau^{-1} \in [z, a)$.*

is in $\mathcal{L}\mathcal{A}_\alpha$ and $a\tau^{-1}\beta\alpha^{-1} <_\alpha a\tau^{-1}\beta$ in $\mathcal{L}\mathcal{A}_\alpha$. Therefore

$$a\tau^{-1}\beta\alpha^{-1} \text{ bridges to a point in } \mathcal{L}\mathcal{A}_\beta \text{ contained in } (b\tau^{-1}, a\tau^{-1}\beta).$$

Apply β^{-1} – the resulting point bridges to a point in $\mathcal{L}\mathcal{A}_\beta$ which is not $a\tau^{-1}$, hence $(a\tau^{-1}\alpha^{-1})\gamma$ is in \mathcal{U} , again a contradiction.

This finishes the analysis of situation *II*. Hence this finishes the analysis of case B.1.3, $\mathcal{U}\gamma$ is not equal to \mathcal{U} .

Case B.1.4 – Suppose $\mathcal{U}\gamma = \mathcal{U}$.

Since the boundary $\partial\mathcal{U}$ in T is the point z this implies that $z\gamma = z$. Here $(\mathcal{L}\mathcal{A}_\tau)\gamma \cap \mathcal{L}\mathcal{A}_\tau \neq \emptyset$, choose $c\gamma$ in this intersection. So $c, c\gamma$ are disjoint and in $\mathcal{L}\mathcal{A}_\tau$. It follows that $z, c, c\gamma$ are aligned (the particular order is not important) and c is in a local axis of γ . But $c\gamma^{-q} = c\tau^p$ is also in $\mathcal{L}\mathcal{A}_\tau$ and it follows easily that the local axis is contained in and therefore equal to the local axis $\mathcal{L}\mathcal{A}_\tau$ of τ so γ, τ and hence κ leaves $\mathcal{L}\mathcal{A}_\tau$ invariant. This sort of argument will be used from time to time from now on.

Here the ideal would be to apply the proof of case A, where τ acted freely and \mathcal{A}_τ was invariant by γ and τ . We already have $\mathcal{L}\mathcal{A}_\tau$ invariant under γ and τ , however $\mathcal{L}\mathcal{A}_\tau$ is not properly embedded in T – at least in the z direction. In order to apply the proof of case A, we analyse the relative positions of $(\mathcal{L}\mathcal{A}_\tau)\alpha, (\mathcal{L}\mathcal{A}_\tau)\alpha\tau$ and so on. In particular for that analysis to work we must have $(\mathcal{L}\mathcal{A}_\tau)\alpha$ contained in \mathcal{U} and so on. So first we do preparation work, showing all images of the local axis are in \mathcal{U} and then we can apply the proof of case A.

For simplicity of notation in case B.1.4 we do the following: \mathcal{K} will denote the local axis $\mathcal{L}\mathcal{A}_\tau$ which is contained in \mathcal{U} and has an ideal point z . Again as we want to use this in section C as well, we will consider a local axis $\mathcal{L}\mathcal{A}_\alpha$ for α . The key result is the following:

Lemma 7.1. *We have $\mathcal{K}\alpha \subset \mathcal{U}$, $\mathcal{K}\alpha^{-1} \subset \mathcal{U}$ and $\mathcal{K}\alpha\tau\alpha^{-1} \subset \mathcal{U}$.*

Proof. We treat each case in turn:

Problem 1 – Is $\mathcal{K}\alpha \subset \mathcal{U}$?

Suppose not. Then as $a\alpha$ is in $\mathcal{L}\mathcal{A}_\alpha$ contained in \mathcal{U} there is t in \mathcal{K} with $t\alpha = z$ or $z\alpha^{-1}$ is in \mathcal{K} , see fig. 13, a. Here z bridges to a in $\mathcal{L}\mathcal{A}_\alpha$ so $z\alpha^{-1}$ bridges to $a\alpha^{-1}$ in $\mathcal{L}\mathcal{A}_\alpha$. So $z\alpha^{-1}$ can only be in \mathcal{K} if b is in $(z, z\alpha^{-1})$ and $a\alpha^{-1} = b$. In particular $a\alpha <_\alpha a$ in $\mathcal{L}\mathcal{A}_\alpha$.

There are two possibilities depending on whether τ is expanding away from z or not:

First suppose $a\tau$ is in $[z, a)$, see fig. 12, a. As $z\alpha$ bridges to a in \mathcal{K} then $z\alpha\tau$ bridges to $a\tau$ in \mathcal{K} so bridges to a in $\mathcal{L}\mathcal{A}_\alpha$. Then $z\alpha\tau\alpha^{-m}$ bridges to $a\alpha^{-m}$ in $\mathcal{L}\mathcal{A}_\alpha$. The point $z\alpha\tau\alpha^{-m}$ is equal to $z\beta$ and bridges to a in \mathcal{K} so bridges to $a\tau^{-1}$ in $\mathcal{L}\mathcal{A}_\beta$. But z also bridges to $a\tau^{-1}$ in $\mathcal{L}\mathcal{A}_\beta$, contradiction.

The second option is $a\tau > a$ in \mathcal{K} , see fig. 12, b. Here $z\beta^{-1}$ bridges to $a\tau^{-1}\beta^{-1}$ in $\mathcal{L}\mathcal{A}_\beta$ and so to a in $\mathcal{L}\mathcal{A}_\alpha$. Hence

$$z\beta^{-1}\alpha^{-1} \text{ bridges to } a\alpha^{-1} \text{ in } \mathcal{L}\mathcal{A}_\alpha \Rightarrow z\beta^{-1}\alpha^{-1} \in \mathcal{U}.$$

On the other hand $z\alpha^{-1}\beta^{-1} = z\alpha^{-1}\tau\alpha\tau^{-1}$. Here

$$z\alpha^{-1}\tau \in \mathcal{K} \Rightarrow z\alpha^{-1} \in (z, z\alpha^{-1}\tau) \Rightarrow z\alpha^{-1}\tau\alpha \notin \mathcal{U} \Rightarrow z\alpha^{-1}\beta^{-1} \notin \mathcal{U}.$$

But $z\beta^{-1}\alpha^{-1}\gamma = z\alpha^{-1}\beta^{-1}$, leading to $\mathcal{U}\gamma \neq \mathcal{U}$, contradiction to case B.1.3.

So we obtain $z\alpha^{-1} \in \mathcal{U}$ is impossible. Hence $\mathcal{K}\alpha \subset \mathcal{U}$. If $\mathcal{K}\alpha$ intersects \mathcal{K} in at most one point we can use the analysis of Case B.1.2 (or of case A) and disallow it. If

$$\mathcal{K} \cap \mathcal{K}\alpha = (z, t), \text{ then } \mathcal{K}, \mathcal{K}\alpha \text{ share a ray.}$$

The orientations in \mathcal{K} and $\mathcal{K}\alpha$ may agree or not. In the first case $z\alpha = z$ and in the second case there is a fixed point r of α in $\mathcal{L}\mathcal{A}_\tau = \mathcal{K}$. If $z\alpha = z$, then z is a global fixed point, impossible by non trivial action. In the second option let \mathcal{U}_1 (respectively \mathcal{U}_2) be the component of $T - \{r\}$ containing $r\tau$ (respectively $r\tau^{-1}$). The condition $\mathcal{K}\alpha \cap \mathcal{K} = (z, t)$ implies that $\mathcal{U}_1\alpha = \mathcal{U}_2$. This is now disallowed by lemma 6.2.

Now consider the situation that \mathcal{K} has another ideal point v . Then $v\kappa = v$. Suppose first that v is in $\mathcal{L}\mathcal{A}_\alpha$. Here we split into cases: if α acts freely then v is a fixed point of τ in the axis of α and this falls under case B.2. Consider then the case that α does not act freely. Then (w, v) has no fixed point of α (as v is in $\mathcal{L}\mathcal{A}_\alpha$) and also no fixed point of τ or γ . Also $T_w(v)$ is invariant under α and $T_v(w)$ is invariant under τ . Then v in $\mathcal{L}\mathcal{A}_\alpha$ is disallowed by lemma 8.4.

It follows that v has the same properties as z . In any case one obtains that

$$\mathcal{K}\alpha \cap \mathcal{K} = [t, r], \quad t \neq r, \quad t \text{ closest to } z$$

and if \mathcal{K} is not properly embedded in the other direction then r is an actual point in \mathcal{K} . Then $\mathcal{K}\alpha\tau \cap \mathcal{K} = [t\tau, r\tau]$. So the intersections are the same as occurred in Case A so far.

Problem 2 – Is $\mathcal{K}\alpha^{-1} \subset \mathcal{U}$?

This is similar to problem 1. As before if $\mathcal{K}\alpha^{-1}$ not contained in \mathcal{U} , then $z \in \mathcal{K}\alpha^{-1}$ and $z\alpha \in \mathcal{K}$. This can only happen if $b \in (z, z\alpha)$, $a\alpha = b$ and $a\alpha^{-1} <_\alpha a$ in $\mathcal{L}\mathcal{A}_\alpha$.

First suppose that $a\tau^{-1} \in [z, a]$. Then

$$a\tau^{-1}\alpha \in [z\alpha, a\alpha] = [b, z\alpha] \Rightarrow a\tau^{-1}\alpha \in \mathcal{K} \Rightarrow a\tau^{-1}\alpha\tau \in \mathcal{K}$$

and this last point bridges to b in $\mathcal{L}\mathcal{A}_\alpha$. Then $a\tau^{-1}\alpha\tau\alpha^{-m} = a\gamma\beta$ bridges to $b\alpha^{-m}$ in $\mathcal{L}\mathcal{A}_\alpha$. But

$$b\alpha^{-m} <_\alpha b \text{ in } \mathcal{L}\mathcal{A}_\alpha \Rightarrow a\gamma\beta \text{ bridges to } b\tau^{-1} \text{ in } \mathcal{L}\mathcal{A}_\beta.$$

On the other hand $a\gamma \in [z, a\tau^{-1}]$ and bridges to a in $\mathcal{L}\mathcal{A}_\beta$, so $a\gamma\beta$ bridges to $a\tau^{-1}\beta$. Since $a\tau^{-1}\beta$ is a point in $\mathcal{L}\mathcal{A}_\beta - \mathcal{K}$ it is not equal to $b\tau^{-1}$, leading to a contradiction.

The second option is $a\tau^{-1} > a$ in \mathcal{K} . Here use

$$z\beta^{-1} = z\alpha\tau^{-1} \in \mathcal{K}, \quad z\alpha \in [z, z\beta^{-1}) \Rightarrow z\beta^{-1}\alpha^{-1} \notin \mathcal{U}.$$

On the other hand $z\alpha^{-1}$ bridges to $a\alpha^{-1}$ in $\mathcal{L}\mathcal{A}_\alpha$ so bridges to $a\tau^{-1}$ in $\mathcal{L}\mathcal{A}_\beta$. So $z\alpha^{-1}\beta^{-1}$ bridges to $a\tau^{-1}\beta^{-1}$ in $\mathcal{L}\mathcal{A}_\beta$ and is in \mathcal{U} . As above this is a contradiction.

We conclude that problem 2 does not occur.

As in problem 1, this implies that

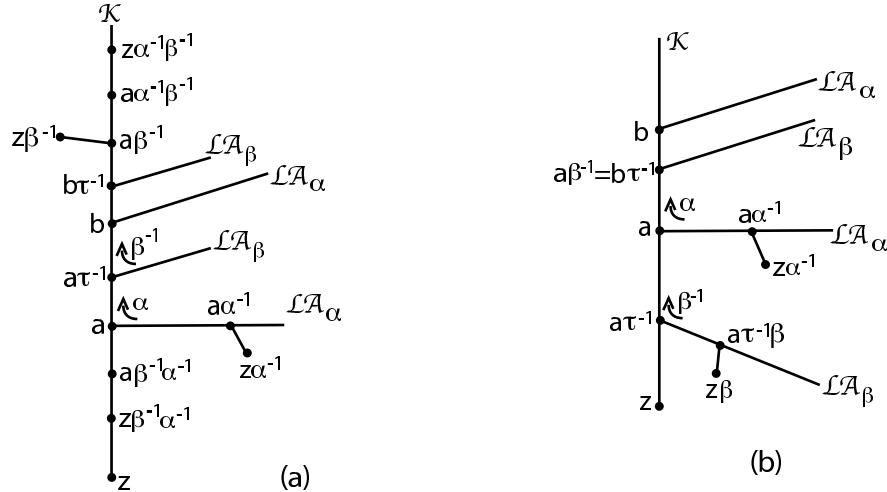

Figure 13: Situation $a\alpha^{-1} <_{\alpha} a$ in $\mathcal{L}\mathcal{A}_{\alpha}$: a. Picture when $a\tau < a$ in \mathcal{K} , b. Picture when $a\tau^{-1} < a$ in \mathcal{K} .

$$\mathcal{K}\alpha^{-1} \cap \mathcal{K} = [t', r'], \quad \text{with } t' \neq r', t' \neq z$$

and if \mathcal{K} not properly embedded on the other side then r' has to be finite in \mathcal{K} .

Then clearly $\mathcal{K}\alpha^{-1}\tau^{-1} \subset \mathcal{U}$ and intersects \mathcal{K} in a segment.

The last problem is the following:

Problem 3 – Does $\mathcal{K}\alpha\tau\alpha^{-1} \subset \mathcal{U}$?

Suppose not, that is, $\mathcal{K}\alpha\tau\alpha^{-1} \not\subset \mathcal{U}$. We have to be careful here. First a preliminary claim:

Claim – $z \in \mathcal{K}\alpha\tau\alpha^{-1}$.

If this is not true then $\mathcal{K}\alpha\tau\alpha^{-1} \cap \mathcal{U} = \emptyset$. Notice that

$$\mathcal{K}\alpha\tau \cap \mathcal{L}\mathcal{A}_{\alpha} \neq \emptyset \Rightarrow \mathcal{K}\alpha\tau\alpha^{-1} \cap \mathcal{L}\mathcal{A}_{\alpha} \neq \emptyset \quad \text{and} \quad \mathcal{K}\alpha\tau\alpha^{-1} \cap \mathcal{U} \neq \emptyset,$$

contrary to assumption here.

So consider $\mathcal{K}\alpha\tau \cap \mathcal{L}\mathcal{A}_{\alpha} = \emptyset$. Also here $\mathcal{K}\alpha\tau \cap \mathcal{K}$ is a non trivial segment. If $\mathcal{K}\alpha\tau$ bridges to a in $\mathcal{L}\mathcal{A}_{\alpha}$ then $\mathcal{K}\alpha\tau\alpha^{-1}$ is contained in \mathcal{U} and we are done. It follows that $\mathcal{K}\alpha\tau$ has to bridge to b in $\mathcal{L}\mathcal{A}_{\alpha}$ and hence $z\alpha$ has to be in this bridge. But then $z\alpha$ is in \mathcal{K} , which was disallowed in problem 2. This proves the claim.

We now analyse what happens when

$$z \in \mathcal{K}\alpha\tau\alpha^{-1} \quad \text{so} \quad z\tau^{-1} = z \in \mathcal{K}\alpha\beta \quad \text{and} \quad z\beta^{-1}\alpha^{-1} \in \mathcal{K}.$$

Also $z\beta^{-1}\alpha^{-1}\gamma = z\alpha^{-1}\beta^{-1}$ is in \mathcal{K} as well.

Situation I – $a\alpha^{-1} <_{\alpha} a$ in $\mathcal{L}\mathcal{A}_{\alpha}$.

Situation I.1 – $a\tau < a$ in \mathcal{K} .

Here $z\alpha^{-1}$ bridges to $a\alpha^{-1}$ in $\mathcal{L}\mathcal{A}_{\alpha}$, so it bridges to $a\tau^{-1}$ in $\mathcal{L}\mathcal{A}_{\beta}$. Also

$$z\alpha^{-1}\beta^{-1} \in \mathcal{K} \quad \text{and} \quad a\tau^{-1} \prec a \prec a\alpha^{-1} \prec z\alpha^{-1}.$$

As β^{-1} moves points up along \mathcal{K} , it follows that $z\alpha^{-1}\beta^{-1} > b$ in \mathcal{K} and $a\tau^{-1}\beta^{-1} = b\tau^{-1}$. Here $a\alpha^{-1} \in [a\tau^{-1}, z\alpha^{-1}]$, see fig. 13, a. Then

$$a\tau^{-1}\beta^{-1} = b\tau^{-1} \prec a\beta^{-1} \prec a\alpha^{-1}\beta^{-1} = v_1 \prec z\alpha^{-1}\beta^{-1} = v_2$$

and all are in \mathcal{K} . Also $a\beta^{-1} \in (b, a\alpha^{-1}\beta^{-1}) \subset \mathcal{K}$ and $z\beta^{-1}$ bridges to \mathcal{K} in $a\beta^{-1}$ so bridges to \mathcal{LA}_α in b . Then $z\beta^{-1}\alpha^{-1} = v_2\gamma^{-1} \in \mathcal{K}$ bridges to a in \mathcal{LA}_α and $a\beta^{-1}\alpha^{-1} = v_1\gamma^{-1}$ is in $(z\beta^{-1}\alpha^{-1}, a)$, see fig. 13, a. Then

$$z\beta^{-1}\alpha^{-1} \prec a\beta^{-1}\alpha^{-1} \prec a\alpha^{-1}\beta^{-1} \prec z\alpha^{-1}\beta^{-1}$$

all points in \mathcal{K} . This contradicts the fact that γ acts as a translation in \mathcal{K} .

Situation I.2 – $a\tau > a$ in \mathcal{K} .

Here $z\alpha^{-1}$ bridges to a in \mathcal{K} , see fig. 13, b. If $a \geq b\tau^{-1}$ in \mathcal{K} then $z\alpha^{-1}$ bridges to a point $t \geq_\beta b\tau^{-1}$ in \mathcal{LA}_β , so

$$z\alpha^{-1}\beta^{-1} \text{ bridges to } \mathcal{LA}_\beta \text{ in a point } \geq_\beta b\tau^{-1}\beta \text{ and } z\alpha^{-1}\beta^{-1} \notin \mathcal{K},$$

contradiction. Hence $a < b\tau^{-1}$ in \mathcal{K} and $z\alpha^{-1}$ bridges to a in \mathcal{LA}_β so $z\alpha^{-1}\beta^{-1}$ bridges to $a\beta^{-1}$ in \mathcal{LA}_β and as $z\alpha^{-1}\beta^{-1}$ is in \mathcal{K} then

$$z\alpha^{-1}\beta^{-1} > b\tau^{-1} \text{ in } \mathcal{K} \text{ and } a\beta^{-1} = b\tau^{-1} \text{ or } a\tau\alpha = b.$$

Now

$$a\beta^{-1} = b\tau^{-1} \text{ so } a\alpha = a\tau^{-1}\beta^{-1}\tau < a\beta^{-1}\tau = b$$

so in particular $a\alpha$ is in \mathcal{K} . Also $z\beta$ bridges to a in \mathcal{LA}_α and so does z . Hence $z\beta\alpha = z\alpha\beta$ and $z\alpha$ bridge to $a\alpha$ in \mathcal{LA}_α . Since $a\alpha < b$ then $z\alpha, z\alpha\beta$ bridge to $a\alpha$ in \mathcal{LA}_τ as well.

If $a\alpha < b\tau^{-1}$ in \mathcal{K} then $z\alpha, z\alpha\beta$ bridge to $a\alpha$ in \mathcal{LA}_β , impossible – they have to bridge to distinct points in \mathcal{LA}_β . If

$$b\tau^{-1} \in (a, a\alpha) \Rightarrow z\alpha, z\alpha\beta \text{ bridge to } b\tau^{-1} \text{ in } \mathcal{LA}_\beta,$$

also contradiction. Therefore $a\alpha = b\tau^{-1}$ or $a\alpha\tau = b$. Now

$$a\alpha\tau\alpha^{-1}\tau^{-1} = b\alpha^{-1}\tau^{-1} = a \text{ so } a\gamma = a\alpha^{-1}\beta^{-1}.$$

Notice $a\gamma \in [z, a\tau^{-1}]$. But $a\alpha^{-1}$ bridges to a in \mathcal{LA}_β so $a\alpha^{-1}\beta^{-1}$ bridges to $a\beta^{-1} = b\tau^{-1}$ in \mathcal{LA}_β and $a\alpha^{-1}\beta^{-1}$ cannot be $a\gamma$, contradiction.

This finishes the analysis of situation I.

The remaining options are extremely similar and have shortened proofs.

Situation II – $a\alpha <_\alpha a$ in \mathcal{LA}_α .

Situation II.1 – $a\tau^{-1} < a$ in \mathcal{K} .

This is as situation I.1 above. Here $z\beta^{-1}$ bridges to a in \mathcal{LA}_α , so $z\beta^{-1}\alpha^{-1}$ bridges to $a\alpha^{-1}$ in \mathcal{LA}_α and $a\alpha^{-1} = b$. It follows that

$$b \prec a\tau^{-1}\alpha^{-1} \prec a\tau^{-1}\beta^{-1}\alpha^{-1} \prec z\beta^{-1}\alpha^{-1},$$

all points in \mathcal{K} .

On the other hand $a\tau^{-1}\alpha^{-1} \in (b, (a\tau^{-1})\beta^{-1}\alpha^{-1}) \subset \mathcal{K}$. The point $z\alpha^{-1}$ bridges to $(a\tau^{-1})\alpha^{-1}$ in \mathcal{K} . It follows that

$$z\alpha^{-1}\beta^{-1} \prec (a\tau^{-1})\alpha^{-1}\beta^{-1} \prec (a\tau^{-1})\beta^{-1}\alpha^{-1} \prec z\beta^{-1}\alpha^{-1},$$

all points in \mathcal{K} . As before this contradicts the fact that γ acts as a translation in \mathcal{K} .

Situation II.2 – $a\tau < a$ in \mathcal{K} .

This is very much like situation I.2. Here $z\beta^{-1}$ bridges to $a\tau^{-1}$ in \mathcal{K} . If $a\tau^{-1} \geq b$ in \mathcal{K} , then

$$z\beta^{-1}\alpha^{-1} \text{ bridges to a point } >_{\alpha} b \text{ in } \mathcal{L}\mathcal{A}_{\alpha} \Rightarrow z\beta^{-1}\alpha^{-1} \notin \mathcal{K},$$

contradiction. Hence

$$a\tau^{-1} < b \text{ in } \mathcal{K}, \quad z\beta^{-1}\alpha^{-1} > b \text{ in } \mathcal{K} \quad \text{and} \quad a\tau^{-1}\alpha^{-1} = b \text{ or } a = b\alpha\tau.$$

In addition

$$z\alpha, z \text{ bridge to } \mathcal{L}\mathcal{A}_{\beta} \text{ in } a\tau^{-1} \Rightarrow z\beta\alpha = z\alpha\beta, \quad z\beta \text{ bridge to } \mathcal{L}\mathcal{A}_{\beta} \text{ in } a\tau^{-1}\beta$$

and similarly to situation I.2, this implies $a\tau^{-1}\beta = b$ or $a = b\tau\alpha$. Then $b\alpha\beta = b$ and $b\gamma = b\alpha^{-1}\beta^{-1}$. But $b\gamma \geq b\tau^{-1}$ in \mathcal{K} and $b\alpha^{-1}$ bridges to b in $\mathcal{L}\mathcal{A}_{\beta}$, so $b\alpha^{-1}\beta^{-1}$ bridges to $b\beta^{-1} = a\tau^{-1}$ and cannot be equal to $b\tau^{-1}$.

This contradiction shows that problem 3 cannot occur. This finishes the proof of lemma 7.1. \square

It follows from lemma 7.1 that $\mathcal{K}\alpha\tau\alpha^{-1} \subset \mathcal{U}$, so $\mathcal{K}\alpha\beta \subset \mathcal{U}$ as is $\mathcal{K}\gamma\beta\alpha$. So all of the sets \mathcal{K} , $\mathcal{K}\alpha$, $\mathcal{K}\alpha\tau$, $\mathcal{K}\alpha\tau\alpha^{-1}$, $\mathcal{K}\alpha\beta$, $\mathcal{K}\alpha^{-1}$, $\mathcal{K}\alpha^{-1}\tau^{-1}$ and $\mathcal{K}\alpha^{-1}\tau^{-1}\alpha$ are contained in \mathcal{U} and none has z as an ideal point. If \mathcal{K} has another ideal point v , then v has the same properties as z and the same situation occurs with respect to this other ideal point.

Given these facts, an analysis exactly as in case A.2 can be applied here. That analysis then shows that case B.1.3 is not possible.

Hence case B.1.4 is disallowed. This also finishes the proof of case B.1.

For case B.2 we return to the study of α acting freely using the axis \mathcal{A}_{α} .

Case B.2 – $Fix(\tau) \cap \mathcal{A}_{\alpha} \neq \emptyset$.

This is the key case of the proof for essential laminations. In this case the topology will be important, in particular, the exact condition $|p - 2q| = 1$ will be used in a crucial manner. Let $z \in Fix(\tau) \cap \mathcal{A}_{\alpha}$. Let \mathcal{U}_1 (respectively \mathcal{U}_2) be the component of $T - \{z\}$ containing $z\alpha$ (respectively $z\alpha^{-1}$). A priori we do not know whether z is also a fixed point of γ . In some subcases, the tricky part will be in fact to show that $z\gamma = z$.

Case B.2.1 – $\mathcal{U}_1\tau = \mathcal{U}_1$.

Notice that $\mathcal{U}_1\alpha$ is contained in \mathcal{U}_1 . Here use $z\alpha\tau = z\tau\gamma\beta\alpha^m = z\gamma\beta\alpha^m$.

$$z\alpha \in \mathcal{U}_1 \Rightarrow z\alpha\tau \in \mathcal{U}_1 \Rightarrow z\alpha\tau\alpha^{-m} \in \mathcal{U}_1\alpha^{-m} \subset \mathcal{U}_1 \Rightarrow z\gamma\beta \in \mathcal{U}_1.$$

So $z\gamma\tau\alpha^{-1}\tau^{-1}$ is in \mathcal{U}_1 and then $z\gamma\alpha^{-1}$ is in \mathcal{U}_1 or $z\gamma$ is in $\mathcal{U}_1\alpha$. In particular $z \prec z\alpha \prec z\gamma$, see fig. 14,

a. We stress that in this case $z\gamma$ is not equal to z !

Use now $z\alpha\tau = z\alpha\beta\alpha^{m-1} = z\alpha\tau\alpha^{-1}\tau^{-1}\alpha^{m-1}$.

$$z\alpha\tau\alpha^{1-m} \in \mathcal{U}_1 \Rightarrow z\alpha\tau\alpha^{-1}\tau^{-1} \in \mathcal{U}_1 \Rightarrow z\alpha\tau\alpha^{-1} \in \mathcal{U}_1 \Rightarrow z\alpha\tau \in \mathcal{U}_1\alpha.$$

In particular $z \prec z\alpha \prec z\alpha\tau$ and $z \prec z\alpha\tau^{-1} \prec z\alpha$ and so $z\alpha\tau^{-1}\alpha^{-1} \in (z\alpha^{-1}, z)$. In other words

$$z\alpha\tau^{-1}\alpha^{-1} = z\tau\alpha\tau^{-1}\alpha^{-1} = z\beta^{-1}\alpha^{-1} \in (z\alpha^{-1}, z).$$

Then $z\beta^{-1}\alpha^{-1}$ is in \mathcal{U}_2 so $z\beta^{-1}\alpha^{-1}\gamma$ is in $\mathcal{U}_2\gamma$. Notice $z\beta^{-1} = z\tau\alpha\tau^{-1} = z\alpha\tau^{-1}$ with $z\alpha \in \mathcal{U}_1$, $z\alpha\tau^{-1}$ also in \mathcal{U}_1 .

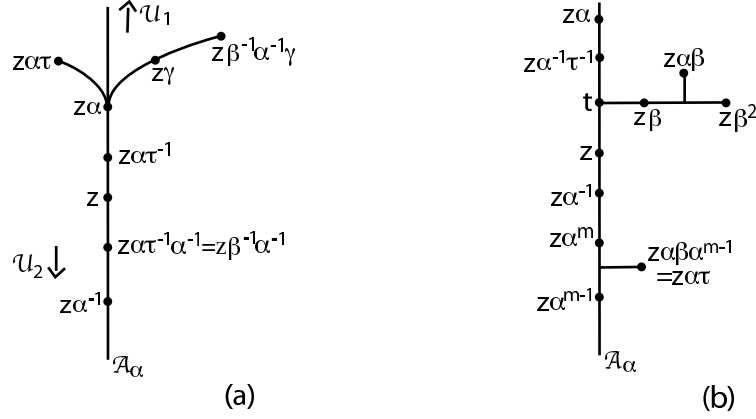

Figure 14: Case B: a. Picture when $\mathcal{U}_1\tau = \mathcal{U}_1$, b. Picture when $\mathcal{U}_1\tau^{-1} = \mathcal{U}_2$ and $[z, z\beta] \cap [z, z\alpha] = [z, t]$.

Recall that $z\gamma \neq z$. If $\mathcal{U}_1\gamma \subset \mathcal{U}_1$ this implies that z is in a local axis for γ contradicting $z\gamma^q = z\tau^{-p} = z$. Therefore $\mathcal{U}_1\gamma$ is not contained in \mathcal{U}_1 and consequently $\mathcal{U}_2\gamma$ is contained in \mathcal{U}_1 and so $z\gamma$ separates $\mathcal{U}_2\gamma$ from z . Hence

$$z\alpha \text{ separates } \mathcal{U}_2\gamma \text{ from } z \text{ and } z\beta^{-1}\alpha^{-1}\gamma \in \mathcal{U}_2\gamma.$$

But $z\beta^{-1}\alpha^{-1}\gamma = z\alpha^{-1}\beta^{-1} = z\alpha^{-1}\tau\alpha\tau^{-1}$. Now $z\alpha$ separates z from $z\alpha^{-1}\tau\alpha\tau^{-1}$ which is in $\mathcal{U}_2\gamma$. Apply τ : $z\alpha\tau$ separates z from $z\alpha^{-1}\tau\alpha$. Then

$$z\alpha\tau \in \mathcal{U}_1\alpha \Rightarrow z\alpha^{-1}\tau\alpha \in \mathcal{U}_1\alpha \Rightarrow z\alpha^{-1}\tau \in \mathcal{U}_1 \text{ and } z\alpha^{-1} \in \mathcal{U}_1\tau^{-1} = \mathcal{U}_1.$$

But this contradicts $z\alpha^{-1}$ is in \mathcal{U}_2 . This is an impossible case.

We conclude that $\mathcal{U}_1\tau \neq \mathcal{U}_1$.

Case B.2.2 – $\mathcal{U}_1\tau \neq \mathcal{U}_2$.

Then $z\alpha\tau$ is not in \mathcal{U}_2 , which implies $z\alpha\tau\alpha^{1-m}$ is in \mathcal{U}_1 , or $z\alpha\beta \in \mathcal{U}_1$ and $z\alpha\tau\alpha^{-1}\tau^{-1}$ is in \mathcal{U}_1 . By assumption $z\alpha\tau \notin \mathcal{U}_1$, hence $z\alpha\tau\alpha^{-1} \in \mathcal{U}_2$ and $z\alpha\tau\alpha^{-1}\tau^{-1} \in \mathcal{U}_2\tau^{-1}$. This would imply $\mathcal{U}_2\tau^{-1} = \mathcal{U}_1$ or $\mathcal{U}_1\tau = \mathcal{U}_2$, so the assumption is incompatible.

We conclude that $\mathcal{U}_1\tau = \mathcal{U}_2$.

Case B.2.3 – $\mathcal{U}_1\tau^{-1} = \mathcal{U}_2$.

This is a very interesting case. Here we only use the fact that p is odd.

First consider $z\beta = z\tau\alpha^{-1}\tau^{-1} = z\alpha^{-1}\tau^{-1}$ which is in $\mathcal{U}_2\tau^{-1} = \mathcal{U}_1$. Then $z\alpha, z\beta$ are in the component \mathcal{U}_1 , hence $[z, z\alpha], [z, z\beta]$ share a subprong. Suppose first that

$$[z, z\beta] \cap [z, z\alpha] = [z, t], \quad t \neq z\alpha, z\beta, \quad \text{that is } z\alpha \notin [z, z\beta], \quad z\beta \notin [z, z\alpha]$$

see fig. 14, b. Then $z\alpha\beta$ bridges to t in \mathcal{A}_α and $z\alpha\beta\alpha^{m-1}$ bridges to \mathcal{A}_α in $t\alpha^{m-1}$ which is a point in $(z\alpha^m, z\alpha^{m-1})$. But

$$z\alpha\beta\alpha^{m-1} = z\alpha\tau \Rightarrow z\alpha^{-1}\tau^{-1} \in [z, z\alpha] \Rightarrow z\beta = z\alpha^{-1}\tau^{-1} \in [z, z\alpha],$$

contradiction.

So either $z\beta \in [z, z\alpha]$ or $z\alpha \in [z, z\beta]$.

Situation I – $z\alpha$ is in $[z, z\beta]$.

Use $z\beta\tau = z\tau\alpha^{-1} = z\alpha^{-1}$. As $z\alpha$ is in $[z, z\beta]$, then $z\alpha\tau \in [z, z\beta\tau] = [z, z\alpha^{-1}]$ and $z\alpha\tau\alpha^{1-m} \in [z\alpha^{-m}, z\alpha^{1-m}]$. But

$$z\alpha\tau\alpha^{1-m} = z\tau^{-1}\alpha\tau\alpha^{1-m} = z\alpha\beta, \quad \text{so } z\alpha\beta \in [z\alpha^{-m}, z\alpha^{1-m}] \subset \mathcal{A}_\alpha.$$

We stress that $z\alpha\beta \in \mathcal{A}_\alpha$. Here $z\beta^{-1} \prec z \prec z\alpha$, hence $z \prec z\beta \prec z\alpha\beta$. It follows that

$$z\beta \in \mathcal{A}_\alpha \quad \text{and} \quad z\beta \in [z, z\alpha\beta] \quad \Rightarrow \quad z\alpha\beta\alpha^{-1} \in [z\alpha^{m-1}, z\alpha^{-m}].$$

We want $z\gamma = z$ or $z\alpha\beta = z\beta\alpha$. We first analyse the other two possibilities.

Situation I.1 – $z\alpha\beta\alpha^{-1} > z\beta$ in \mathcal{A}_α .

Then $z\beta \prec z\alpha\beta\alpha^{-1} \prec z\alpha\beta$, so $z \prec z\gamma \prec z\alpha$, or $z\gamma \in (z, z\alpha)$, so $z\gamma \in \mathcal{U}_1$. Clearly $z\beta\alpha \in \mathcal{A}_\alpha$. Here $z\alpha\beta > z\beta\alpha$ in \mathcal{A}_α . Then

$$z \prec z\beta\alpha \prec z\alpha\beta \quad \text{all in } \mathcal{A}_\alpha \quad \Rightarrow \quad z\beta^{-1} \prec z\beta\alpha\beta^{-1} \prec z\alpha \quad \text{and} \quad z\beta^{-1}\alpha^{-1} \prec z\gamma^{-1} \prec z.$$

But $z\beta^{-1} = z\alpha\tau^{-1} \in \mathcal{U}_2$, hence $z\beta^{-1}\alpha^{-1}$ is in \mathcal{U}_2 . Now $z\gamma \in \mathcal{U}_1$, $z\gamma^{-1} \in \mathcal{U}_2$, therefore z is in a local axis for γ , hence $z\gamma^q \neq z$, contradiction.

Situation I.2 – Suppose $z\alpha\beta <_\alpha z\beta\alpha$.

Then

$$z \prec z\alpha\beta\alpha^{-1} \prec z\beta \quad \Rightarrow \quad z\beta^{-1} \prec z\gamma \prec z.$$

As $z\beta^{-1} = z\alpha\tau^{-1}$ is in \mathcal{U}_2 , then $z\gamma$ is in \mathcal{U}_2 .

Now $z\alpha\beta <_\alpha z\beta\alpha$. If \mathcal{A}_β contains elements in \mathcal{A}_α above $z\alpha\beta$, that is, $\mathcal{A}_\beta \cap \mathcal{A}_\alpha \supset [z, t]$ with $t >_\alpha z\alpha\beta$. Then

$$z \prec z\alpha \prec t\beta^{-1} \prec z\beta\alpha\beta^{-1}, \quad \text{with } t\beta^{-1} \in \mathcal{A}_\alpha \quad \Rightarrow \quad z \prec t\beta^{-1}\alpha^{-1} \prec z\gamma^{-1}$$

with $t\beta^{-1}\alpha^{-1}$ in \mathcal{A}_α so $z\gamma^{-1}$ is in \mathcal{U}_1 and not in \mathcal{U}_2 .

On the other hand if \mathcal{A}_β escapes \mathcal{A}_α in $z\alpha\beta$, then $z\beta\alpha\beta^{-1}$ bridges to \mathcal{A}_β in $z\alpha$, hence bridges to \mathcal{A}_α in $z\alpha$ as $z\alpha \in (z, z\beta)$. Hence $z\beta\alpha\beta^{-1} \notin \mathcal{U}_2\alpha$ and $z\beta\alpha\beta^{-1}\alpha^{-1} = z\gamma^{-1}$ bridges to \mathcal{A}_α in z and $z\gamma^{-1}$ is not in \mathcal{U}_2 . In any case $z\gamma^{-1}$ is not in \mathcal{U}_2 and $z\gamma$ is in \mathcal{U}_2 so z separates $z\gamma$ from $z\gamma^{-1}$ and z is in a local axis for γ , impossible.

We conclude that $z\alpha\beta = z\beta\alpha$ or that $z\gamma = z$.

Situation I.3 – $z\gamma = z$.

Then γ leaves invariant the set of components of $T - \{z\}$. Recall that $\mathcal{U}_1\tau^{-1} = \mathcal{U}_2$ and $\mathcal{U}_1\tau = \mathcal{U}_2$ in situation I. Use $z\beta^{-1}\alpha^{-1}\gamma = z\alpha^{-1}\beta^{-1}$. The left side is $z\tau\alpha\tau^{-1}\alpha^{-1}\gamma = z\alpha\tau^{-1}\alpha^{-1}\gamma$.

$$z\alpha \in \mathcal{U}_1 \Rightarrow z\alpha\tau^{-1} \in \mathcal{U}_1\tau^{-1} \neq \mathcal{U}_1, \quad \text{so } z\alpha\tau^{-1}\alpha^{-1} \in \mathcal{U}_2 \quad \text{and} \quad z\alpha\tau^{-1}\alpha^{-1}\gamma \in \mathcal{U}_2\gamma.$$

On the other hand the right side is $z\alpha^{-1}\tau\alpha\tau^{-1}$:

$$z\alpha^{-1} \in \mathcal{U}_2 \Rightarrow z\alpha^{-1}\tau \in \mathcal{U}_2\tau = \mathcal{U}_1, \quad z\alpha^{-1}\tau\alpha \in \mathcal{U}_1 \quad \text{and} \quad z\alpha^{-1}\tau\alpha\tau^{-1} \in \mathcal{U}_1\tau^{-1} = \mathcal{U}_2.$$

So $\mathcal{U}_2\gamma \cap \mathcal{U}_2 \neq \emptyset$. Since γ now preserves the set of components of $T - \{z\}$ it follows that $\mathcal{U}_2\gamma = \mathcal{U}_2$ and $\mathcal{U}_1\gamma = \mathcal{U}_2\tau\gamma = \mathcal{U}_2\gamma\tau = \mathcal{U}_2\tau = \mathcal{U}_1$. Now we use p odd and $\tau^p\gamma^q = id$:

$$\mathcal{U}_1 = \mathcal{U}_1\gamma^q\tau^p = \mathcal{U}_1\tau^p = \mathcal{U}_1\tau^{p(\text{mod } 2)} = \mathcal{U}_1\tau.$$

This contradicts $\mathcal{U}_1\tau \neq \mathcal{U}_1$ and finishes the analysis of situation I.

Situation II – $z\beta \in [z, z\alpha]$.

This is very similar to the previous case if we think of it in the appropriate way. The trick here is to switch the roles of α and β , which can be done. Notice first that $z\beta \in \mathcal{U}_1$ and $z\beta^{-1} = z\tau\alpha\tau^{-1} = z\alpha\tau^{-1}$ is in \mathcal{U}_2 . So the component of $T - \{z\}$ containing $z\beta$ (respectively $z\beta^{-1}$) is the \mathcal{U}_1 (respectively \mathcal{U}_2). First rewrite the relations as

$$\tau\alpha\tau^{-1} = \beta^{-1} \quad \tau\beta\tau^{-1} = \gamma^{-1}\alpha\beta^m = \beta\alpha\beta^{m-1}$$

As $z\beta$ is in $[z, z\alpha]$ then $z\beta\tau^{-1}$ is in $[z\tau^{-1}, z\alpha\tau^{-1}] = [z, z\beta^{-1}]$. So

$$z\tau\beta\tau^{-1}\beta^{1-m} = z\beta\tau^{-1}\beta^{1-m} = z\beta\alpha \in [z\beta^{-m}, z\beta^{1-m}] \subset \mathcal{A}_\beta.$$

As $z\beta \in [z, z\alpha]$, then $z\beta\alpha$ is in $[z\alpha, z\alpha^2]$ and

$$z\alpha \in [z, z\beta\alpha] \subset [z, z\beta^{1-m}] \subset \mathcal{A}_\beta.$$

Therefore $z\alpha$ is in \mathcal{A}_β and similarly $z\alpha\beta, z\beta\alpha$ are in \mathcal{A}_β .

From this point on the proof is entirely similar to the analysis in situation I: consider whether $z\alpha\beta <_\beta z\beta\alpha$, $z\alpha\beta >_\beta z\beta\alpha$, or $z\alpha\beta = z\beta\alpha$, with completely analogous proofs.

Therefore this case is disallowed. This finishes the analysis of case B.2.3, $\mathcal{U}_2\tau = \mathcal{U}_1$.

Case B.2.4 – $\mathcal{U}_1\tau = \mathcal{U}_2$, $\mathcal{U}_1\tau^{-1} \neq \mathcal{U}_2$.

This is the most interesting case which relates to the topology in a crucial way.

Use $z\beta^{-1}\alpha^{-1}\gamma = z\alpha^{-1}\beta^{-1}$. The right side is $z\tau\alpha\tau^{-1}\alpha^{-1}\gamma = z\alpha\tau^{-1}\alpha^{-1}\gamma$.

$$z\alpha \in \mathcal{U}_1 \Rightarrow z\alpha\tau^{-1} \in \mathcal{U}_1\tau^{-1} \neq \mathcal{U}_1 \Rightarrow z\alpha\tau^{-1}\alpha^{-1} \in \mathcal{U}_2.$$

Hence $z\beta^{-1}\alpha^{-1}\gamma$ is in $\mathcal{U}_2\gamma$. On the other hand $z\alpha^{-1}\beta^{-1} = z\alpha^{-1}\tau\alpha\tau^{-1}$:

$$z\alpha^{-1}\tau \in \mathcal{U}_2\tau \neq \mathcal{U}_2 \Rightarrow z\alpha^{-1}\tau\alpha \in \mathcal{U}_1 \Rightarrow z\alpha^{-1}\tau\alpha\tau^{-1} \in \mathcal{U}_1\tau^{-1} \neq \mathcal{U}_2.$$

We conclude that

$$\mathcal{U}_2\gamma \cap \mathcal{U}_1\tau^{-1} \neq \emptyset, \quad \text{or} \quad \mathcal{U}_1\tau\gamma \cap \mathcal{U}_1\tau^{-1} \neq \emptyset \quad (*).$$

What we actually want is that these two sets are equal. A priori we have to be careful because γ may not preserve the set of components of $T - \{z\}$, or equivalently we may have $z\gamma \neq z$. So we first deal with this case. We will need the following useful lemma:

Lemma 7.2. *Let η be a homeomorphism of a tree V so that η^l has a fixed point a , where l is not 0. Then there is a fixed point of η in $[a, a\eta]$.*

Proof. Consider $a\eta^2$. If $a\eta^2$ is in $[a, a\eta]$ and not equal to $a\eta$, then η sends $[a, a\eta]$ into itself and has a fixed point there, done. If $a\eta$ is in $(a, a\eta^2)$ then a is in a local axis of η and $a\eta^l$ is not a , impossible. If a is in $(a\eta, a\eta^2)$, then η^{-1} sends $[a\eta, a\eta^2]$ into itself (into $[a, a\eta]$) producing a fixed point there, done.

We can now assume $a\eta^2$ bridges to $[a, a\eta]$ in a point r which is in $(a, a\eta)$, see fig. 15, a. If $r\eta = r$ we are done. Assume $r\eta \neq r$. Then $r\eta$ is in $[a\eta, a\eta^2]$.

Suppose first that $r\eta$ is in $[r, a\eta]$, see fig. 15, a. Then $r\eta^2$ is in $[r\eta, a\eta^2]$ so either $[r\eta, r]$ is contained in its image under η or vice versa. In any case there is a fixed point of η in $[r, r\eta]$.

Suppose now that $r\eta$ is in $(r, a\eta^2]$ see fig. 15, b. Hence $a \prec r \prec r\eta$ and $a\eta \prec r\eta \prec r\eta^2$. Then $r \in (a\eta, r\eta)$ and $r\eta \in (r, r\eta^2)$, so r is in a local axis for η . This implies that $a\eta^t \neq a$ for any nonzero t in \mathbf{Z} , contradiction. This finishes the proof. \square

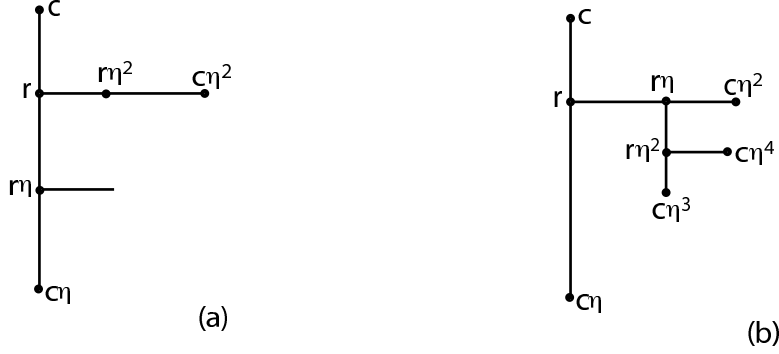

Figure 15: a. $r\eta \in [r, a\eta]$, b. $r\eta \in (r, a\eta^2]$.

We are back to case B.2.4.

Situation I – $z\gamma \neq z$.

Suppose first that $z\gamma \in \mathcal{U}_2$. Notice $\mathcal{U}_2\tau \neq \mathcal{U}_1$ and also $\neq \mathcal{U}_2$. Then there is c in $[z, z\gamma]$ fixed by γ so c is in \mathcal{U}_2 . This implies

$$\mathcal{U}_2\tau\gamma \subset \mathcal{U}_2 \Rightarrow \mathcal{U}_1\tau^2\gamma \subset \mathcal{U}_2, \text{ or } \mathcal{U}_1\tau\gamma \subset \mathcal{U}_1.$$

But by (*) $\mathcal{U}_1\tau\gamma \cap \mathcal{U}_1\tau^{-1} \neq \emptyset$, which now implies $\mathcal{U}_1\tau^{-1} \cap \mathcal{U}_1 \neq \emptyset$. This is impossible and rules out this case.

The second possibility is that $z\gamma \in \mathcal{U}_1$. Here $\mathcal{U}_2\gamma \subset \mathcal{U}_1$ so $\mathcal{U}_1\tau\gamma \subset \mathcal{U}_1$. As $\mathcal{U}_1\tau\gamma \cap \mathcal{U}_1\tau^{-1} \neq \emptyset$ then $\mathcal{U}_1\tau^{-1} \cap \mathcal{U}_1 \neq \emptyset$, also impossible.

The final option is $z\gamma \notin \mathcal{U}_1 \cap \mathcal{U}_2$, $z\gamma \in \mathcal{U}_3$ (which may be $\mathcal{U}_2\tau$ or not). Here there is y fixed by γ with $y \in \mathcal{U}_3$. Here first use

$$\mathcal{U}_2\gamma \subset \mathcal{U}_3, \text{ or } \mathcal{U}_1\tau\gamma \subset \mathcal{U}_3 \Rightarrow \mathcal{U}_1\tau^{-1} \cap \mathcal{U}_3 \neq \emptyset \text{ and } \mathcal{U}_1\tau^{-1} = \mathcal{U}_3.$$

Use $\mathcal{U}_1\gamma \subset \mathcal{U}_3$, so

$$\mathcal{U}_1\tau\gamma \subset \mathcal{U}_3\tau \text{ and } \mathcal{U}_1\tau^{-1} \cap \mathcal{U}_3\tau \neq \emptyset \text{ or } \mathcal{U}_1\tau^{-1} = \mathcal{U}_3\tau.$$

Then $\mathcal{U}_3 = \mathcal{U}_3\tau$ or $\mathcal{U}_1\tau^{-1} = \mathcal{U}_1\tau^{-2}$, so $\mathcal{U}_1\tau = \mathcal{U}_1$, impossible. This rules out this final option.

We conclude that:

Situation II – $z\gamma = z$.

This is a crucial case. In fact there is an essential lamination in $M_{p/q}$ whenever $|p - 2q| \geq 2$ and this essential lamination may satisfy these properties: τ has a fixed point, α has an axis (or at least a local axis) which contains the fixed point of τ . See more below. So here is a part of the proof where the specific condition $|p - 2q| = 1$ needs to be used. See remark below on the topological significance of this condition.

Here is the proof. Since $z\gamma = z$, then γ permutes components of $T - \{z\}$. Since $\mathcal{U}_1\tau\gamma \cap \mathcal{U}_1\tau^{-1} \neq \emptyset$, it now follows that

$$\mathcal{U}_1\tau\gamma = \mathcal{U}_1\tau^{-1} \quad \text{or} \quad \mathcal{U}_1\gamma\tau^2 = \mathcal{U}_1.$$

We now compute

$$\mathcal{U}_1 = \mathcal{U}_1\tau^p\gamma^q = \mathcal{U}_1\tau^{p-2q}\tau^{2q}\gamma^q = \mathcal{U}_1(\gamma\tau^2)^q\tau^{p-2q} = \mathcal{U}_1\tau^{p-2q}.$$

When $|p - 2q| = 1$ then either $\mathcal{U}_1 = \mathcal{U}_1\tau$ or $\mathcal{U}_1 = \mathcal{U}_1\tau^{-1}$ – so in either case $\mathcal{U}_1 = \mathcal{U}_1\tau$! But this contradicts that we proved before that in case B, $\mathcal{U}_1\tau$ is not equal to \mathcal{U}_1 . This is a contradiction showing that case B.2.4 cannot happen. This is quite straightforward, but it needed all the previous steps.

This finishes the proof of case B: $Fix(\tau) \neq \emptyset$, $Fix(\alpha) = \emptyset$.

Remark – We now analyse the topology of this situation. Consider the original stable foliation in the torus bundle over the circle (the manifold M). This produces a lamination λ_1 in $M - N(\delta)$. The solid torus complementary component of λ_1 have degeneracy locus $(1, 2)$ that is $\gamma\tau^2$. This means the $\gamma\tau^2$ is a curve in the boundary leaf of the complementary component and it also preserves the “outer” side of this complementary component. Now do p/q Dehn filling on $M - N(\delta)$ and look at the tree T produced. The leaf through δ collapses to a fixed point z of τ (and γ too). Usually neither τ nor γ preserves the complementary components of z , but the above fact about the degeneracy locus means that $\gamma\tau^2$ does preserve these components – if \mathcal{U}_1 is one such component of $T - \{z\}$ then $\mathcal{U}_1\gamma\tau^2 = \mathcal{U}_1$. After (q, p) Dehn surgery, the leaf space T of the lamination has a singularity at z with exactly $|p - 2q|$ prongs. The transformation τ rotates by one in the set of prongs, hence τ^{p-2q} preserves each of the prongs. This is also detected by $\gamma\tau^2$ preserving the set of prongs and $\tau^p\gamma^q$ being null homotopic. All is well when $|p - 2q| \geq 2$, because we have 2 or more prongs and the lamination is essential and the action is very nice. However when $|p - 2q| = 1$ there is only one prong and the lamination is not essential. It is amazing that this sort of difficulty can still be detected on the level of group action on trees. Notice that this is exactly what the proof shows that $\mathcal{U}_1\tau = \mathcal{U}_1$, which must happen if there is only one prong.

8 Case C – α has a fixed point and τ has a fixed point

Let s in $Fix(\kappa)$, w in $Fix(\alpha)$ with $(s, w] \cap Fix(\kappa) = \emptyset$ and $[s, w) \cap Fix(\alpha) = \emptyset$. The following notation will be very useful in this section. Given $u \neq v$ in T let

$$T_u(v) = \{\text{component of } T - \{u\} \text{ containing } v\}.$$

Let $\mathcal{W} = T_s(w)$, $\mathcal{V} = T_w(s)$. First in this section we will try to prove that \mathcal{W} is invariant under τ and \mathcal{V} is invariant under α . This will produce local axes for α and (eventually) for τ and we will see how the 2 axes interact.

Case C.1 – Suppose $\mathcal{W}\tau \neq \mathcal{W}$.

Case C.1.1 – Suppose $w \in [s, s\alpha]$.

This is equivalent to $\mathcal{V}\alpha \neq \mathcal{V}$. Notice $s\alpha \neq w$. We know $s\alpha\beta = s\beta\alpha$, and $s\beta\alpha = s\alpha^{-1}\tau^{-1}\alpha$. Then

$$s\alpha^{-1} \notin \mathcal{V} \Rightarrow s\alpha^{-1} \in \mathcal{W} \Rightarrow s\alpha^{-1}\tau^{-1} \in \mathcal{W}\tau^{-1} \subset \mathcal{V} \Rightarrow s\alpha^{-1}\tau^{-1}\alpha \in \mathcal{V}\alpha \subset \mathcal{W}.$$

On the other hand $s\alpha\beta = s\alpha\tau\alpha^{-1}\tau^{-1}$. Here

$$s\alpha \in \mathcal{V}\alpha \subset \mathcal{W} \Rightarrow s\alpha\tau \in \mathcal{W}\tau \subset \mathcal{V} \Rightarrow s\alpha\tau^{-1}\alpha^{-1} \in \mathcal{V}\alpha^{-1} \subset \mathcal{W}$$

and $s\alpha\beta$ is in $\mathcal{W}\tau$. These two facts together imply $\mathcal{W} = \mathcal{W}\tau$, contrary to assumption.

Conclusion: if $\mathcal{W}\tau \neq \mathcal{W}$, then $\mathcal{V}\alpha = \mathcal{V}$.

Case C.1.2 – $s\alpha^{-1} \notin [s, w]$, $s\alpha \notin [s, w]$.

This implies $s\alpha, s\alpha^{-1}$ are in \mathcal{W} . For otherwise if $s\alpha$ is not in \mathcal{W} , then s is in $(w, s\alpha]$ and so $s\alpha^{-1}$ is in $[w, s]$.

In this case $s\alpha^{-1}$ bridges to $[s, w]$ in a point r with $r \in (s, w)$ – the important fact is that r is not one of the endpoints which would occur if $s\alpha^{-1}$ is not in \mathcal{W} or \mathcal{V} . Then

$$r \in [w, s] \cap [w, s\alpha^{-1}] \Rightarrow r\alpha^{-1} \in [s, w\alpha^{-1}].$$

Notice $r\alpha^{-1}$ is not equal to r . If $r\alpha^{-1}$ is in $(r, s\alpha^{-1})$, then $s\alpha^{-2}$ bridges to $[r, s\alpha^{-1}]$ in $r\alpha^{-1}$, hence $s\alpha^{-2}$ bridges to $[s, w]$ in r . The same happens for all $s\alpha^n$ with n negative. If on the other hand $r\alpha^{-1}$ is in

(w, r) then $s\alpha^{-2}$ bridges to $r\alpha^{-1}$ in $[s, w]$ and $s\alpha^n$ bridges to $[s, w]$ in $r\alpha^{n+1}$ for all n negative. Notice then $r\alpha^n$ are all in $(w, r) \subset (w, s)$. The important conclusion is that under the hypothesis $s\alpha, s\alpha^{-1}$ both not in $[s, w]$ then any $s\alpha^n$ bridges to $[s, w]$ in a point in the interior of $[s, w]$, Hence all $s\alpha^n$ are in \mathcal{W} and \mathcal{V} .

Use $s\tau^{-1}\alpha\tau = s\gamma\beta\alpha^m$. Here $s\alpha$ is in \mathcal{W} , so $s\alpha\tau$ is in $\mathcal{W}\tau$. Also $s\beta = s\alpha^{-1}\tau^{-1}$ is in $\mathcal{W}\tau^{-1}$ and bridges to s in $[s, w]$. Hence $s\beta\alpha^m$ bridges to $s\alpha^m$ in $[s\alpha^m, w]$. But $s\alpha^m$ is in \mathcal{W} and bridges to $[s, w]$ in a point in the interior of (s, w) . This implies $s\beta\alpha^m$ is in \mathcal{W} , contradiction.

This case is impossible.

Case C.1.3 – Suppose $s\alpha \in [s, w]$.

This implies for instance that $\mathcal{W}\alpha \subset \mathcal{W}$ and $T_s(w\tau^{-1})\beta^{-1} \subset T_s(w\tau^{-1})$.

Case C.1.3.1 – Suppose $s\alpha^{-1} \in \mathcal{W}\tau$.

Then $s\beta^{-1} = s\alpha\tau^{-1}$ is in $(s, w\tau^{-1}) \subset \mathcal{W}\tau^{-1}$. Also $s\alpha^{-1} = s\beta\alpha^{-1}\beta^{-1}$. Here $s\beta = s\alpha^{-1}\tau^{-1}$ is in \mathcal{W} .

In this case suppose first that $s\beta$ is not in \mathcal{V} . Then

$$w \in [w\tau^{-1}, s\beta] \quad \text{and} \quad w\beta^{-1} \in [w\tau^{-1}, s] \quad \Rightarrow \quad w\beta^{-1}\alpha^{-1} \in \mathcal{W}\tau,$$

as $s\alpha^{-1}$ is in $\mathcal{W}\tau$. Notice $w\beta^{-1}\alpha^{-1}$ is not s . Then

$$w\beta^{-1}\alpha^{-1}\gamma = w\alpha^{-1}\beta^{-1} = w\beta^{-1} \quad \text{is in } \mathcal{W}\tau^{-1}.$$

Notice if $w\beta^{-1} = s$, then

$$w\beta^{-1}\alpha^{-1} = w\beta^{-1}\gamma^{-1} = s\gamma^{-1} = s = w\beta^{-1},$$

contradiction because s is not fixed by α .

Collecting all of this together: $w\beta^{-1}\alpha^{-1}\gamma$ is in $\mathcal{W}\tau\gamma$. This point is equal to $w\beta^{-1}$ which is in $\mathcal{W}\tau^{-1}$. Therefore

$$\mathcal{W}\tau\gamma = \mathcal{W}\tau^{-1} \quad \text{or} \quad \mathcal{W}\tau^2\gamma = \mathcal{W}, \quad \text{impossible when } |p - 2q| = 1,$$

as in case B.2.4.

The second option in case C.1.3.1 is that $s\beta \in \mathcal{V}$. Recall that $s\alpha^{-1}\tau^{-1} = s\beta$ is in \mathcal{W} . Notice that

$$\mathcal{L}\mathcal{A}_\beta = (\mathcal{L}\mathcal{A}_\alpha)\tau^{-1} \quad \text{has a segment } [w\tau^{-1}, s] \subset \mathcal{W}\tau^{-1} \cup \{s\}$$

and then it goes into \mathcal{W} , as $s\beta$ is in \mathcal{W} . Then either $s\beta = t \in (w, s)$ or $s\beta$ bridges to $[w, s]$ in $t \in (w, s)$, so bridges to t in $\mathcal{L}\mathcal{A}_\alpha$. In either case $s\beta\alpha^{-1}$ bridges to $t\alpha^{-1}$ in $\mathcal{L}\mathcal{A}_\alpha$ or is $t\alpha^{-1}$. If $t\alpha^{-1}$ is in $[w, s]$, then $s\beta\alpha^{-1}$ bridges to $t\alpha^{-1}$ in $\mathcal{L}\mathcal{A}_\beta$, see fig. 16, a. Here $t\alpha^{-1}$ is in $[w\tau^{-1}, s\beta)$. If

$$s \in [t\alpha^{-1}, w] \quad \text{then} \quad s\beta\alpha^{-1} \quad \text{bridges to } \mathcal{L}\mathcal{A}_\beta \quad \text{in } r, \quad \text{with } r \in [s, w\tau^{-1}].$$

This depends for instance on whether $\mathcal{W}\tau = \mathcal{W}\tau^{-1}$ or not. In any case $s\beta\alpha^{-1}$ bridges to $\mathcal{L}\mathcal{A}_\beta$ in a point in $[w\tau^{-1}, s\beta)$. It follows that $s\beta\alpha^{-1}\beta^{-1}$ bridges to a point t in $\mathcal{L}\mathcal{A}_\beta$ with t in $[w\tau^{-1}, s)$, that is, $s\beta\alpha^{-1}\beta^{-1}$ is in $\mathcal{W}\tau^{-1}$. Then

$$s\alpha^{-1} \in \mathcal{W}\tau, \quad s\beta\alpha^{-1}\beta^{-1} = s\alpha^{-1}\gamma \in \mathcal{W}\tau^{-1} \quad \Rightarrow \quad \mathcal{W}\tau\gamma = \mathcal{W}\tau^{-1},$$

contradiction when $|p - 2q| = 1$.

This shows that case C.1.3.1 cannot occur.

Case C.1.3.2 – $s\alpha^{-1}$ is not in $\mathcal{W}\tau$.

Here $s\beta = s\alpha^{-1}\tau^{-1}$ is not in \mathcal{W} . Also $s\beta^{-1} = s\alpha\tau^{-1}$ is not in \mathcal{W} . It follows that

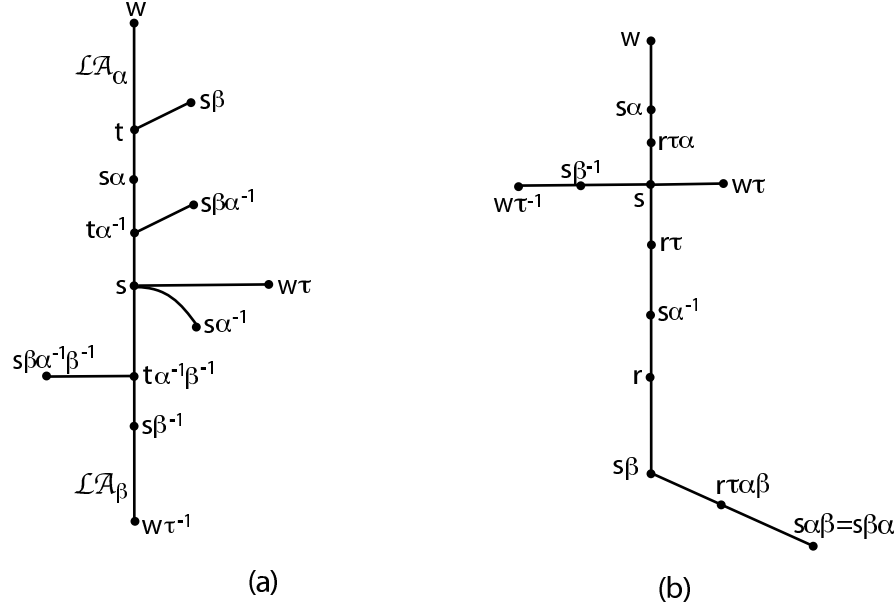

Figure 16: a. Case C.1.3.1, b. Case C.1.3.2.

$$\mathcal{L}\mathcal{A}_\beta \cap [w, s] = \{s\},$$

so $s\alpha$ bridges to $\mathcal{L}\mathcal{A}_\beta$ in s and $s\alpha\beta = s\beta\alpha$ bridges to $\mathcal{L}\mathcal{A}_\beta$ in $s\beta$. Hence $[s, s\beta] \subset (s\alpha, s\beta\alpha)$ and there is a fixed point r of α in $(s, s\beta)$, see fig. 16, b. It also implies that

$$s\alpha^{-1} \in [s, r] \quad \text{and} \quad s\alpha^{-1} \in T_s(s\beta) = T_s(s\beta)\tau,$$

because $s\beta^{-1} = s\alpha\tau^{-1}$. Now apply $\tau\alpha\beta = \alpha\tau\alpha^{1-m}$ to r : $r\tau\alpha\beta = r\tau\alpha^{1-m}$.

As $s\beta\tau = s\alpha^{-1}$ and as $r \in (s, s\beta)$, then

$$r\tau \in (s, s\alpha^{-1}) \Rightarrow r\tau\alpha \in (s, s\alpha) \Rightarrow r\tau\alpha\beta \in (s\beta, s\alpha\beta) \subset T_r(s\beta).$$

As $r\tau\alpha$ is in $(s, s\alpha^{-1}) \subset T_r(s)$ this implies $r\tau\alpha^{1-m}$ is also in $T_r(s)$. Therefore r separates $r\tau\alpha^{1-m}$ from $r\tau\alpha\beta$, contradiction.

This shows that case C.1.3, $s\alpha \in [s, w]$ cannot occur. Finally consider:

Case C.1.4 – Suppose $s\alpha^{-1} \in [s, w]$.

This implies that $\mathcal{W}\alpha^{-1} \subset \mathcal{W}$ and $(\mathcal{W}\tau^{-1})\beta \subset (\mathcal{W}\tau^{-1})$.

Case C.1.4.1 – Suppose $s\alpha \notin \mathcal{W}\tau^{-1}$.

This case is very similar to case C.1.3.2. Here $s\beta \in T_s(w\tau^{-1})$ which is not equal to either $T_s(s\alpha)$ or $T_s(s\alpha^{-1})$. Hence $s\beta$ bridges to $\mathcal{L}\mathcal{A}_\alpha$ in s and $s\beta\alpha = s\alpha\beta$ bridges to $\mathcal{L}\mathcal{A}_\alpha$ in $s\alpha$. Hence

$$s\beta \prec s \prec s\alpha \prec s\alpha\beta$$

and there is a fixed point r of β in $(s, s\alpha)$. Then $s\beta^{-1} \in (s, r) \subset (s, s\alpha)$. Now use $\beta\tau^{-1}\beta^{1-m} = \tau^{-1}\beta\alpha$ applied to r : $r\tau^{-1}\beta^{1-m} = r\tau^{-1}\beta\alpha$. As $s\alpha\tau^{-1} = s\beta^{-1}$ then

$$r\tau^{-1} \in (s, s\beta^{-1}) \quad \text{so} \quad r\tau^{-1}\beta^{1-m} \in (r, s\beta^{1-m}) \subset T_r(s).$$

On the other hand $r\tau^{-1}\beta\alpha$ is in $(s\alpha, s\beta\alpha) \subset T_r(s\alpha)$. As $T_r(s\alpha) \neq T_r(s)$, this is a contradiction, ruling out this case.

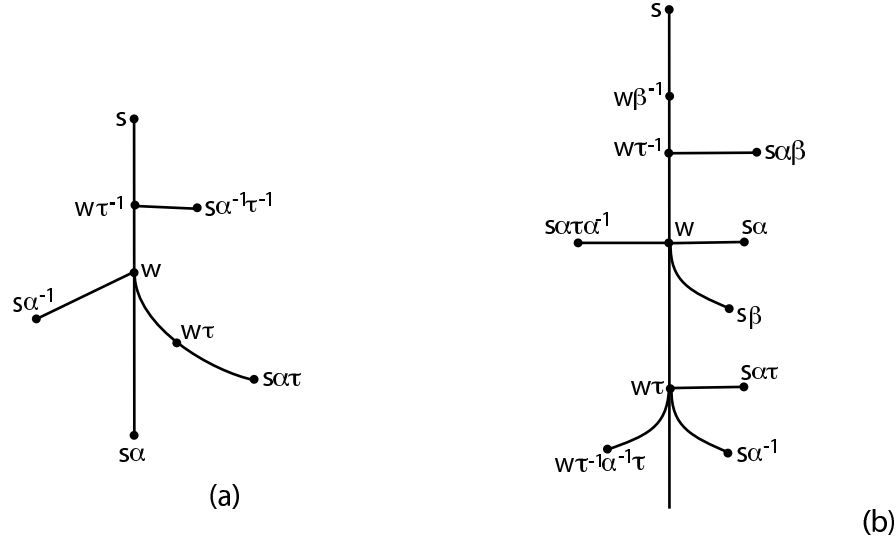

Figure 17: a. Case C.2.2.1, b. Case C.2.2.3.

Case C.1.4.2 – $s\alpha$ is in $\mathcal{W}\tau^{-1}$.

This is similar to case C.1.3.1. Suppose first that $\mathcal{W}\tau^{-1} = \mathcal{W}\tau$. Then $s\alpha\tau^{-1} = s\beta^{-1}$ is in \mathcal{W} . Also $\mathcal{W}\beta^{-1}$ is contained in \mathcal{W} . It follows that

$$s\alpha^{-1}\beta^{-1} \in \mathcal{W} \quad \text{and} \quad s\alpha^{-1}\beta^{-1}\gamma^{-1} = s\beta^{-1}\alpha^{-1} \in \mathcal{W}.$$

Hence $\mathcal{W}\gamma = \mathcal{W}$, $\mathcal{W}\tau^2 = \mathcal{W}$, leading to contradiction when p is odd.

Suppose now that $\mathcal{W}\tau^{-1} \neq \mathcal{W}\tau$. Then $s\alpha \in \mathcal{W}\tau^{-1}$ and $s\alpha\tau^{-1} = s\beta^{-1}$ is not in \mathcal{W} . Also $s\beta^{-1}$ is in $\mathcal{W}\tau^{-2}$. So $s\beta^{-1}$ bridges to s in $\mathcal{L}\mathcal{A}_\alpha$ and $s\beta^{-1}\alpha^{-1}$ bridges to $s\alpha^{-1}$ in $\mathcal{L}\mathcal{A}_\alpha$ implying $s\beta^{-1}\alpha^{-1}$ is in \mathcal{W} .

Also $s\beta^{-1}\alpha^{-1}\gamma = s\alpha^{-1}\beta^{-1}$. Here $s\alpha^{-1}$ bridges to s in $\mathcal{L}\mathcal{A}_\beta$, $s\alpha^{-1}\beta^{-1}$ bridges to $s\beta^{-1}$ in $\mathcal{L}\mathcal{A}_\beta$. But

$$s\beta^{-1} \in \mathcal{W}\tau^{-2} \quad \Rightarrow \quad s\alpha^{-1}\beta^{-1} \in \mathcal{W}\tau^{-2} \quad \Rightarrow \quad \mathcal{W}\gamma = \mathcal{W}\tau^{-2},$$

again impossible when $|p - 2q| = 1$.

This finishes the analysis of case C.1.4, $s\alpha^{-1} \in [s, w]$.

We conclude that case C.1, $\mathcal{W}\tau \neq \mathcal{W}$ is impossible. This implies $\mathcal{W}\tau = \mathcal{W}$. We stress that this does not yet produce a local axis of τ in \mathcal{W} , because we may have other fixed points of τ in (s, w) .

Case C.2 – Suppose that $\mathcal{V}\alpha \neq \mathcal{V}$.

Here we will use $s\alpha\tau = s\beta\alpha^m = s\alpha\beta\alpha^{m-1}$ many times.

Case C.2.1 – Suppose $w\tau, w\tau^{-1}$ are not in $[s, w]$.

The bridge from $w\tau$ to $[s, w]$ is $[w\tau, t]$, where t is in (s, w) . Since $s\alpha \notin \mathcal{V}$, then $s\alpha\tau$ bridges to t in $[s, w]$, so $s\alpha\tau$ is in \mathcal{V} . Hence $s\alpha\tau\alpha^{-m}$ is in $\mathcal{V}\alpha^{-m}$. This point is equal to $s\beta = s\alpha^{-1}\tau^{-1}$. In the same way $s\alpha^{-1}$ is not in \mathcal{V} and bridges to $[s, w]$ in w . It follows that $s\alpha^{-1}\tau^{-1}$ bridges to a point r in $[s, w]$, where r is in (s, w) , hence $s\beta \in \mathcal{V}$. Therefore $\mathcal{V}\alpha^m = \mathcal{V}$.

On the other hand

$$s\alpha\tau = s\alpha\beta\alpha^{m-1} = s\alpha\tau\alpha^{-1}\tau^{-1}\alpha^{m-1}.$$

The point $s\alpha\tau$ is in \mathcal{V} and bridges to t in $[s, w]$. So $s\alpha\tau\alpha^{-1}$ is in $\mathcal{V}\alpha^{-1}$ and bridges to w in $[s, w]$ so $s\alpha\tau\alpha^{-1}\tau^{-1}$ bridges to r in $[s, w]$ (r as above) and as a result this point is in \mathcal{V} . Hence $s\alpha\beta\alpha^{m-1}$ is in $\mathcal{V}\alpha^{m-1}$ and $\mathcal{V}\alpha^m = \mathcal{V}\alpha^{m-1}$, contradicting $\mathcal{V}\alpha \neq \mathcal{V}$.

Case C.2.2 – $w\tau^{-1} \in [s, w]$.

Here $\mathcal{V}\tau^{-1}$ is contained in \mathcal{V} .

The condition implies that w is in a local axis $\mathcal{L}\mathcal{A}_\tau$ of τ (this case will be ruled out, we only establish the existence of a local axis of τ in \mathcal{W} later). Put an order $<$ in $\mathcal{L}\mathcal{A}_\tau$ so $c < d$ in $\mathcal{L}\mathcal{A}_\tau$ if $s \prec c \prec d$ – the order decreases as points get closer to s .

Case C.2.2.1 – $w\tau \in \mathcal{V}\alpha$, $w\tau \notin \mathcal{V}\alpha^{-1}$, see fig. 17, a.

Here $\mathcal{V}\alpha\tau \subset \mathcal{V}\alpha$.

The conditions imply in particular that $\mathcal{V}\alpha \neq \mathcal{V}\alpha^{-1}$. Here $s\alpha\tau \in \mathcal{V}\alpha$, so $s\beta\alpha^m \in \mathcal{V}\alpha$. Also $s\alpha^{-1}$ bridges to $\mathcal{L}\mathcal{A}_\tau$ in w so $s\beta = s\alpha^{-1}\tau^{-1}$ bridges to $\mathcal{L}\mathcal{A}_\tau$ in $w\tau^{-1}$. It follows that $s\beta$ is in \mathcal{V} and $s\beta\alpha^m$ is in $\mathcal{V}\alpha^m$. Hence $\mathcal{V}\alpha^m = \mathcal{V}\alpha$.

On the other hand $s\alpha\tau = s\alpha\beta\alpha^{m-1}$. Use $s\alpha\beta = s\alpha\tau\alpha^{-1}\tau^{-1}$. Here

$$s\alpha \in \mathcal{V}\alpha \Rightarrow s\alpha\tau \in \mathcal{V}\alpha \Rightarrow s\alpha\tau\alpha^{-1} \in \mathcal{V} \Rightarrow s\alpha\tau\alpha^{-1}\tau^{-1} \in \mathcal{V}.$$

Finally $s\alpha\beta\alpha^{m-1}$ is in $\mathcal{V}\alpha^{m-1}$. So $\mathcal{V}\alpha^{m-1} = \mathcal{V}\alpha$ and $\mathcal{V} = \mathcal{V}\alpha$, again contradicting the assumption in this case.

Case C.2.2.2 – Suppose $w\tau$ is not in $\mathcal{V}\alpha$ and $w\tau$ is not in $\mathcal{V}\alpha^{-1}$.

Then $w\tau$ is in \mathcal{R} another component of $T - \{w\}$. Then $s\alpha\tau$ is in \mathcal{R} . Now $s\beta\alpha^m = s\alpha^{-1}\tau^{-1}\alpha^m$. But

$$w\tau \notin \mathcal{V}\alpha^{-1} \Rightarrow s\alpha^{-1} \text{ bridges to } \mathcal{L}\mathcal{A}_\tau \text{ in } w \Rightarrow s\alpha^{-1}\tau^{-1} \text{ bridges to } \mathcal{L}\mathcal{A}_\tau \text{ in } w\tau^{-1}$$

and $s\beta$ is in \mathcal{V} . Therefore $s\beta\alpha^m \in \mathcal{V}\alpha^m = \mathcal{R}$. Notice $\mathcal{R}\alpha^{-1} \neq \mathcal{R}$ because $\mathcal{R} = \mathcal{V}\alpha^m$ and $\mathcal{V}\alpha^{-1} \neq \mathcal{V}$. Use

$$s\alpha\tau = s\alpha\beta\alpha^{m-1} = s\alpha\tau\alpha^{-1}\tau^{-1}\alpha^{m-1} \quad \text{and} \quad s\alpha\tau\alpha^{-1} \in \mathcal{R}\alpha^{-1} \neq \mathcal{R}.$$

Hence $s\alpha\tau\alpha^{-1}$ bridges to $\mathcal{L}\mathcal{A}_\tau$ in a point $\leq w$ in $\mathcal{L}\mathcal{A}_\tau$ (it is in $[s, w]$) and $s\alpha\beta$ bridges to $\mathcal{L}\mathcal{A}_\tau$ in a point $\leq w\tau^{-1}$ in $\mathcal{L}\mathcal{A}_\tau$. Hence

$$s\alpha\beta \in \mathcal{V} \Rightarrow s\alpha\beta\alpha^{m-1} \in \mathcal{V}\alpha^{m-1} \Rightarrow \mathcal{V}\alpha^m = \mathcal{V}\alpha^{m-1},$$

contradiction. Notice that here it doesn't matter whether $\mathcal{V}\alpha = \mathcal{V}\alpha^{-1}$ or not.

Case C.2.2.3 – $w\tau$ is in $\mathcal{V}\alpha^{-1}$, see fig. 17, b.

This implies $\mathcal{V}\alpha^{-1}\tau$ is a subset of $\mathcal{V}\alpha^{-1}$.

Use $s\alpha\tau = s\beta\alpha^m = s\alpha^{-1}\tau^{-1}\alpha^m$. Here

$$s\alpha \notin \mathcal{V} \Rightarrow s\alpha\tau \in T_w(w\tau) = \mathcal{V}\alpha^{-1} \Rightarrow s\alpha\tau\alpha^{-1} \in \mathcal{V}\alpha^{-2} \neq \mathcal{V}\alpha^{-1},$$

so it bridges to a point r in $\mathcal{L}\mathcal{A}_\tau$ with $r \leq w$ in $\mathcal{L}\mathcal{A}_\tau$. Hence $s\alpha\beta$ is in \mathcal{V} and $s\alpha\beta\alpha^{m-1}$ is in $\mathcal{V}\alpha^{m-1}$. Hence $\mathcal{V}\alpha^{m-1} = \mathcal{V}\alpha^{-1}$ or $\mathcal{V}\alpha^m = \mathcal{V}$.

On the other hand $s\alpha\tau = s\beta\alpha^m$ is in $\mathcal{V}\alpha^{-1}$, so

$$s\alpha^{-1}\tau^{-1} = s\beta \quad \text{is in} \quad \mathcal{V}\alpha^{-1-m} = \mathcal{V}\alpha^{-1}.$$

Then $s\beta$ bridges to a point $> w$ in $\mathcal{L}\mathcal{A}_\tau$. But $s\beta = s\alpha^{-1}\tau^{-1}$, so $s\alpha^{-1}$ bridges to a point $> w\tau$ in $\mathcal{L}\mathcal{A}_\tau$, which implies $w\tau \in (w, s\alpha^{-1})$. It follows that $w\tau\alpha \in (w, s)$ and $w\beta^{-1} = w\tau\alpha\tau^{-1}$ is in $(w\tau^{-1}, s)$ is in \mathcal{W} and in \mathcal{V} .

The following arguments use the strategy of case R.2:

Now $w\beta^{-1}\alpha^{-1}\gamma = w\beta^{-1}$ is in \mathcal{W} and $w\beta^{-1}\alpha^{-1} = w\tau^{-1}\alpha^{-1}\tau$. Use

$$w\tau^{-1}\alpha^{-1} \in \mathcal{V}\alpha^{-1} = T_w(w\tau) \quad \text{so} \quad w\tau^{-1}\alpha^{-1}\tau \quad \text{is in} \quad T_{w\tau}(w\tau^2) = \mathcal{V}\alpha^{-1}\tau^{-1} \subset \mathcal{V}\alpha^{-1} \subset \mathcal{W}.$$

Hence $w\beta^{-1}\alpha^{-1} \in \mathcal{W}$. From this it follows that $\mathcal{W}\gamma = \mathcal{W}$. As usual this implies that $(\mathcal{L}\mathcal{A}_\tau)\gamma = \mathcal{L}\mathcal{A}_\tau$ so γ, τ have the common local axis $\mathcal{L}\mathcal{A}_\tau$. In addition $w\beta^{-1}\alpha^{-1}\gamma = w\beta^{-1}$ and as $w\beta^{-1}$ is in $\mathcal{L}\mathcal{A}_\tau$, so does $w\beta^{-1}\alpha^{-1}$.

If $w\tau\alpha \leq w\tau^{-1}$ in $\mathcal{L}\mathcal{A}_\tau$ then $w\beta^{-1} = w\tau\alpha\tau^{-1} \leq w\tau^{-2}$ in $\mathcal{L}\mathcal{A}_\tau$. Also $w\tau, w\beta^{-1}\alpha^{-1}$ are in $\mathcal{L}\mathcal{A}_\tau$ and $w\tau < w\beta^{-1}\alpha^{-1}$ in $\mathcal{L}\mathcal{A}_\tau$. Hence

$$w\tau\gamma < w\beta^{-1}\alpha^{-1}\gamma = w\beta^{-1} \leq w\tau^{-2} \quad \text{in} \quad \mathcal{L}\mathcal{A}_\tau \quad \Rightarrow \quad p > 3q,$$

contradiction to $|p - 2q| = 1$.

If $w\tau\alpha > w\tau^{-1}$ in $\mathcal{L}\mathcal{A}_\tau$ then $w\tau\alpha\tau^{-1} = w\beta^{-1} \in (w\tau^{-2}, w\tau^{-1})$. Here use

$$(w\tau^2)\gamma\beta\alpha^m = w\tau\alpha\tau \in T_w(w\tau) = \mathcal{V}\alpha^{-1} \quad \Rightarrow \quad w\tau^2\gamma\beta \in \mathcal{V}\alpha^{-1},$$

because $\mathcal{V}\alpha^m = \mathcal{V}$. Therefore $w\tau^2\gamma\beta$ bridges to v in $\mathcal{L}\mathcal{A}_\tau$ with $v > w$ in $\mathcal{L}\mathcal{A}_\tau$. Hence $w\tau^2\gamma < w\beta^{-1}$ in $\mathcal{L}\mathcal{A}_\tau$ and as $w\beta^{-1} < w\tau^{-1}$ we also obtain $p > 3q$, contradiction.

This rules out the case C.2.2.3 and hence finishes the analysis of case C.2.2, $w\tau^{-1} \in [s, w]$. The next case is:

Case C.2.3 – $w\tau \in [s, w]$.

This implies that $\mathcal{V}\tau \subset \mathcal{V}$. The case is similar to case C.2.2.

Case C.2.3.1 – $w\tau^{-1} \in \mathcal{V}\alpha^{-1}$, $w\tau^{-1} \notin \mathcal{V}\alpha$.

This implies that $\mathcal{V}\alpha^{-1}\tau^{-1} \subset \mathcal{V}\alpha^{-1}$.

Here $w\tau^{-1}\alpha$ is in \mathcal{V} , $w\tau^{-1}\alpha\tau$ is in \mathcal{V} so $w\alpha\beta\alpha^{m-1} = w\beta\alpha^{m-1}$ is in \mathcal{V} . Also

$$w\tau\alpha^{-1} \in \mathcal{V}\alpha^{-1} \quad \Rightarrow \quad w\beta = w\tau\alpha^{-1}\tau^{-1} \in \mathcal{V}\alpha^{-1} \quad \Rightarrow \quad w\beta\alpha^{m-1} \in \mathcal{V}\alpha^{m-2}$$

which must be equal to \mathcal{V} .

On the other hand $s\alpha\tau = s\beta\alpha^m$. Here $s\alpha \in \mathcal{V}\alpha$ and bridges to w in $\mathcal{L}\mathcal{A}_\tau$, so $s\alpha\tau$ bridges to $w\tau$ in $\mathcal{L}\mathcal{A}_\tau$ and $s\alpha\tau \in \mathcal{V}$. Also

$$s\beta = s\alpha^{-1}\tau^{-1} \in \mathcal{V}\alpha^{-1} \quad \text{and} \quad s\beta\alpha^m \in \mathcal{V}\alpha^{m-1}.$$

It follows that $\mathcal{V}\alpha^{m-1} = \mathcal{V}\alpha^{m-2}$, contradiction to $\mathcal{V} \neq \mathcal{V}\alpha$.

Case C.2.3.2 – $w\tau^{-1} \notin \mathcal{V}\alpha^{-1}$, $w\tau^{-1} \notin \mathcal{V}\alpha$, see fig. 18, a.

Use $s\alpha\tau = s\beta\alpha^m = s\alpha\beta\alpha^{m-1}$. In this case the point $s\alpha$ bridges to w in $\mathcal{L}\mathcal{A}_\tau$ and $s\alpha\tau \in \mathcal{V}$. Also $s\alpha^{-1}$ bridges to w in $\mathcal{L}\mathcal{A}_\tau$ and $s\beta = s\alpha^{-1}\tau^{-1}$ bridges $w\tau^{-1}$ in $\mathcal{L}\mathcal{A}_\tau$ so

$$s\beta \quad \text{is in} \quad \mathcal{R} = T_w(w\tau^{-1}) \neq \mathcal{V}\alpha, \mathcal{V}\alpha^{-1} \quad \Rightarrow \quad s\beta\alpha^m \in \mathcal{R}\alpha^m = \mathcal{V}.$$

So in particular $\mathcal{R} \neq \mathcal{R}\alpha$.

On the other hand $s\alpha\tau\alpha^{-1} \in \mathcal{V}\alpha^{-1}$ and bridges to w in $\mathcal{L}\mathcal{A}_\tau$ so $s\alpha\beta = s\alpha\tau\alpha^{-1}\tau^{-1}$ bridges to $w\tau^{-1}$ in $\mathcal{L}\mathcal{A}_\tau$ and is in \mathcal{R} . Then $s\alpha\beta\alpha^{m-1} \in \mathcal{R}\alpha^{m-1} = \mathcal{V}\alpha^{-1}$. This would imply $\mathcal{V} = \mathcal{V}\alpha^{-1}$, contradiction.

The final case in C.2.3 is:

Case C.2.3.3 – $w\tau^{-1} \in \mathcal{V}\alpha$.

Let $[s\alpha, r]$ be the bridge from $s\alpha$ to $\mathcal{L}\mathcal{A}_\tau$ with r in $\mathcal{L}\mathcal{A}_\tau$. Then $r > w$ in $\mathcal{L}\mathcal{A}_\tau$. Here we have to subdivide.

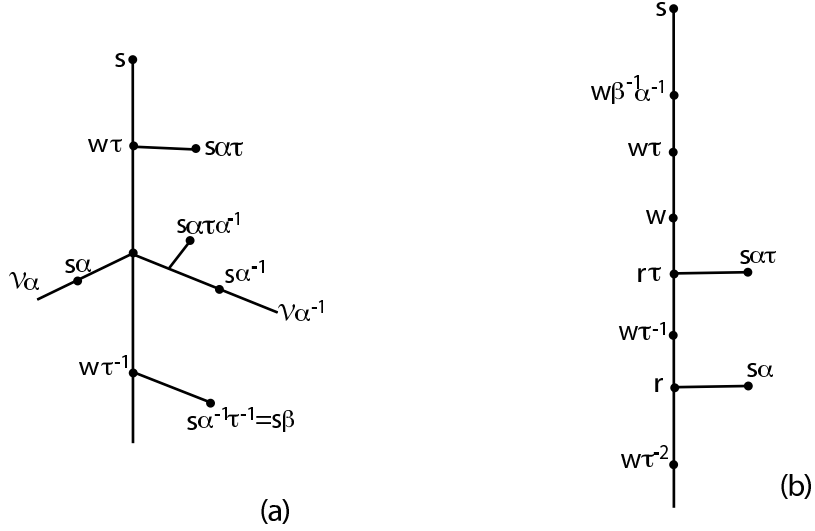

Figure 18: a. Case C.2.3, b. Case C.2.3.3, Situation III.

Situation I – r is in $(w, w\tau^{-1})$.

Then $s\alpha\tau$ bridges to $\mathcal{L}\mathcal{A}_\tau$ in $r\tau \in (w, w\tau)$ and $s\alpha\tau \in \mathcal{V}$. Hence

$$s\alpha\tau\alpha^{-1} \notin \mathcal{V} \Rightarrow s\alpha\tau\alpha^{-1}\tau^{-1} = s\alpha\beta \in \mathcal{V}\alpha \Rightarrow s\alpha\beta\alpha^{m-1} \in \mathcal{V}\alpha^m \Rightarrow \mathcal{V} = \mathcal{V}\alpha^m.$$

On the other hand $s\beta\alpha^m = s\alpha^{-1}\tau^{-1}\alpha^m$. Here $s\alpha^{-1}\tau^{-1}$ is in $\mathcal{V}\alpha$ so $s\beta\alpha^m$ is in $\mathcal{V}\alpha^{m+1}$, implying $\mathcal{V}\alpha^m = \mathcal{V}\alpha^{m+1}$ again a contradiction.

Situation II – $r = w\tau^{-1}$.

Here $s\alpha\tau$ bridges to $\mathcal{L}\mathcal{A}_\tau$ in w hence $s\alpha\tau \notin \mathcal{V}\alpha$ and $s\alpha\tau \notin \mathcal{V}$. So $s\alpha\tau$ is in \mathcal{R} , another component of $T - \{w\}$. Also

$$s\alpha^{-1} \notin \mathcal{V} \Rightarrow s\beta = s\alpha^{-1}\tau^{-1} \in \mathcal{V}\alpha \Rightarrow s\beta\alpha^m \in \mathcal{V}\alpha^{m+1} \Rightarrow \mathcal{R} = \mathcal{V}\alpha^{m+1}.$$

On the other hand $s\alpha\beta\alpha^{m-1} \in \mathcal{V}\alpha^{m+1}$, so $s\alpha\beta \in \mathcal{V}\alpha^2$. Now $\mathcal{V}\alpha^2 \neq \mathcal{V}\alpha$ so $\mathcal{V}\alpha^2\tau$ is contained in \mathcal{V} . Hence $s\alpha\tau\alpha^{-1} = s\alpha\beta\tau$ is in \mathcal{V} . This would imply $s\alpha\tau$ is in $\mathcal{V}\alpha$, contradiction to the first conclusion in this case.

Situation III – $w\tau^{-1} < r$ in $\mathcal{L}\mathcal{A}_\tau$.

This is a little more tricky. Here $s\alpha\tau \in \mathcal{V}\alpha$, see fig. 18, b. Also

$$w\beta^{-1} = w\tau\alpha\tau^{-1} \in \mathcal{V}\alpha \subset \mathcal{W}.$$

Now use $w\beta^{-1}\alpha^{-1} = w\tau^{-1}\alpha^{-1}\tau$. Here

$$w\tau^{-1} \in [w, s\alpha] \Rightarrow w\tau^{-1}\alpha^{-1} \in [w, s] \Rightarrow w\tau^{-1}\alpha^{-1}\tau \in [s, w\tau] \subset \mathcal{L}\mathcal{A}_\tau \subset \mathcal{W}.$$

So $w\beta^{-1}\alpha^{-1}, w\beta^{-1}$ are both in \mathcal{W} , with the usual implications that $\mathcal{W}\gamma = \mathcal{W}$ and γ leaves $\mathcal{L}\mathcal{A}_\tau$ invariant. As $w\beta^{-1}\alpha^{-1}$ is in $\mathcal{L}\mathcal{A}_\tau$ then $w\beta^{-1}$ is in $\mathcal{L}\mathcal{A}_\tau$ as well. Also

$$w\beta^{-1}\alpha^{-1} = w\tau^{-1}\alpha^{-1}\tau < w\tau \in \mathcal{L}\mathcal{A}_\tau \Rightarrow w\tau\alpha \in \mathcal{L}\mathcal{A}_\tau.$$

The proof is now analogous to previous arguments. If

$$w < w\tau^{-1} < w\tau\alpha \Rightarrow w\tau^{-1} < w\tau^{-2} < w\tau\alpha\tau^{-1} = w\beta^{-1}.$$

But

$$w\beta^{-1}\alpha^{-1}\gamma = w\beta^{-1} \quad \text{and} \quad w\beta^{-1}\alpha^{-1} \in (s, w\tau)$$

implies as before that $p > 3q$, contradiction.

On the other hand if $w \prec w\tau\alpha \prec w\tau^{-1}$, then $w\tau^{-1} \prec w\tau\alpha\tau^{-1} = w\beta^{-1} \prec w\tau^{-2}$ all in $\mathcal{L}\mathcal{A}_\tau$. Here $s\alpha\tau \in \mathcal{V}\alpha$. Now $s\beta\alpha^m = s\alpha^{-1}\tau^{-1}\alpha^m$. Also

$$s\alpha^{-1} \notin \mathcal{V} \Rightarrow s\alpha^{-1}\tau^{-1} \in \mathcal{V}\alpha \Rightarrow s\beta\alpha^m \in \mathcal{V}\alpha^{m+1} \Rightarrow \mathcal{V}\alpha = \mathcal{V}\alpha^{m+1} \text{ or } \mathcal{V} = \mathcal{V}\alpha^m.$$

Now use $w\tau^2\gamma\beta\alpha^m = w\tau\alpha\tau$. Here

$$w\tau \prec w\tau\alpha\tau \prec w \text{ in } \mathcal{L}\mathcal{A}_\tau \Rightarrow w\tau\alpha\tau \in \mathcal{V}, \quad w\tau^2\gamma\beta \in \mathcal{V}\alpha^{-m} = \mathcal{V}.$$

So $w\tau^2\gamma \prec w\beta^{-1} \prec w\tau^{-1} \prec w$, implying again $p > 3q$, contradiction.

This finishes the analysis of case C.2.3, $w\tau \in [s, w]$ and so proves that the case $\mathcal{V}\alpha \neq \mathcal{V}$ cannot occur. From now on in case C assume:

Case C.3 – $\mathcal{W}\tau = \mathcal{W}$ and $\mathcal{V}\alpha = \mathcal{V}$.

Since there is no other fixed point of α in (s, w) , this immediately implies there is a local axis $\mathcal{L}\mathcal{A}_\alpha$ of α contained in \mathcal{V} with w as an ideal point of $\mathcal{L}\mathcal{A}_\alpha$. We stress that at this point we do not yet have an axis for τ , because there may be other fixed points of τ in (s, w) .

Lemma 8.1. $s\alpha, s\alpha^{-1} \in \mathcal{W}$, so $s\alpha, s\alpha^{-1}$ are not in $[s, w)$.

Proof. Suppose first that $s\alpha$ is not in \mathcal{W} . Then

$$s\alpha^{-1} \in (s, w) \subset \mathcal{W} \Rightarrow s\alpha^{-1}\tau^{-1} \in \mathcal{W}\tau = \mathcal{W}.$$

So $s\beta \in \mathcal{W}$ and bridges to $[s, w]$ in a point r which is in $(s, w]$. Then $s\beta\alpha^m$ bridges to $[s, w]$ in $r\alpha^m$ and $s\beta\alpha^m$ is in \mathcal{W} . Therefore $s\alpha\tau$ is in \mathcal{W} and $s\alpha$ is in $\mathcal{W}\tau^{-1} = \mathcal{W}$, contradiction.

On the other hand suppose that $s\alpha^{-1} \notin \mathcal{W}$. Then $s\alpha \in (s, w]$. Also $s\beta = s\alpha^{-1}\tau^{-1} \notin \mathcal{W}$, so bridges to $[s, w]$ in s . Then $s\beta\alpha^m$ bridges to $[s\alpha^m, x]$ in $s\alpha^m$. Since $s\alpha^m \notin \mathcal{W}$ this implies $s\beta\alpha^m \notin \mathcal{W}$, therefore $s\alpha\tau \notin \mathcal{W}$. But then $s\alpha$ is not in \mathcal{W} , contradiction. This finishes the proof. \square

We conclude that $s\alpha, s\alpha^{-1}$ are in $\mathcal{W} \cap \mathcal{V}$. Let $s\alpha$ bridge to r in $[s, w]$, hence $r \in (s, w)$ and $s\alpha^{-1}$ bridges to $[s, w]$ in a point t also in (s, w) .

Let z be the fixed point of τ in $[s, w]$ which is closest to w . Then z may be equal to s , but is not w . Let $\mathcal{U} = T_z(w)$. One important goal is to prove that $\mathcal{U}\tau = \mathcal{U}$.

Lemma 8.2. Let $\mathcal{U} = T_z(w)$. Then $\mathcal{U}\tau = \mathcal{U}$. If $z \neq s$ then $z\gamma, w\gamma \notin \mathcal{W}$, and $z\alpha, z\alpha^{-1} \notin (z, w)$.

Proof. If $z = s$ then $\mathcal{U} = \mathcal{W}$ and the result follows from Case C.1. For the rest of the proof of the lemma assume that $s \neq z$.

We first analyse the possibility that $z\gamma \in \mathcal{W}$. As κ fixes s then $z\gamma^{-1} \in \mathcal{W}$ also. If $z\gamma = z$, then $z\kappa = z$, contradiction.

Suppose that $z\gamma$ or $z\gamma^{-1}$ is in $[s, z)$. Then as $s\gamma = s$, it follows that z is in a local axis for γ and $z\gamma^q \neq z$, contradiction to z fixed by τ . Hence $z\gamma, z\gamma^{-1} \notin [s, z]$.

Let $[z\gamma, r]$ be the bridge from $z\gamma$ to $[s, z]$. Notice that r is in (s, z) , because $z\gamma, z\gamma^{-1}$ are not in $[s, w]$. Then

$$r \in [s, z] \cap [s, z\gamma] \Rightarrow r\gamma^{-1} \in [s, z].$$

If $r\gamma = r$, then $r\tau^p = r\gamma^{-q} = r$. But $([s, z])\tau = [s, z]$, so this would imply $r\tau = r$. Together these imply $r\kappa = r$, contradiction to s the fixed point of κ in $[s, w]$ which is closest to w .

We conclude that $r\gamma \neq r$. But as $s\gamma = s$, this implies that r is in a local axis \mathcal{LA}_γ of γ . Compute r^{nq} , $n \in \mathbf{Z}$. Assume without loss of generality that r^{nq} moves away from s as $n \rightarrow +\infty$. Then

$$r\gamma^{nq} = r\tau^{-np} \in [s, w], \quad \forall n \quad \text{and} \quad r\gamma^{nq} \rightarrow c \in (s, z] \text{ as } n \rightarrow +\infty.$$

Then $c\gamma = c$ and also $c\tau = c$, contradiction.

This contradiction shows that $z\gamma \in \mathcal{W}$ is impossible. Notice that if $z\gamma$ is not in \mathcal{W} , then $z\gamma$ separates $\mathcal{W}\gamma$ from s and hence from \mathcal{W} . It follows that $\mathcal{W}\gamma \cap \mathcal{W} = \emptyset$, so $w\gamma \notin \mathcal{W}$. This proves one assertion of lemma 8.2.

We now consider where $z\alpha$ and $z\alpha^{-1}$ are. Notice they are both in \mathcal{V} . Remember that for the rest of the proof $s \neq z$.

Situation I – Suppose first that $z\alpha \in (z, w)$.

Use $\alpha\tau = \tau\gamma\beta\alpha^m$, applied to z . Here $z\alpha$ is in \mathcal{U} so $z\alpha\tau$ is in $\mathcal{U}\tau$. Suppose first that $\mathcal{U}\tau \neq \mathcal{U}\alpha^{-1}$. Then $z\alpha\tau$ bridges to \mathcal{LA}_α in a point in $[z, w]$ and hence $a = z\alpha\tau\alpha^{-m}$ bridges to \mathcal{LA}_α in a point in $[z\alpha^{-m}, w]$ and a is in \mathcal{U} . Here

$$z\alpha\tau\alpha^{-m} = z\gamma\beta = z\gamma\alpha^{-1}\tau^{-1} \Rightarrow z\gamma\alpha^{-1} \in \mathcal{U}\tau \neq \mathcal{U}.$$

Again $z\gamma\alpha^{-1}$ bridges to \mathcal{LA}_α in a point in $[z, w]$ and it follows that $z\gamma$ is in \mathcal{U} , hence $z\gamma \in \mathcal{W}$ contradicting $\mathcal{W}\gamma \cap \mathcal{W} = \emptyset$.

The remaining possibility is $\mathcal{U}\tau = T_z(z\alpha^{-1})$, so in particular $\mathcal{U}\tau \neq \mathcal{U}$, see fig. 19, a. Consider $w\tau^{-1}\alpha^{-1}\tau$. The point $w\tau^{-1}$ is not in \mathcal{U} , hence it bridges to \mathcal{LA}_α in a point not in $(z, w]$. Therefore $w\tau\alpha^{-1}$ bridges to \mathcal{LA}_α in a point not in $(z\alpha^{-1}, w]$, so $w\tau\alpha^{-1}$ is in $T_z(z\alpha^{-1}) = \mathcal{U}\tau$. Hence

$$w\tau^{-1}\alpha^{-1}\tau = w\beta^{-1}\alpha^{-1} \quad \text{is in } \mathcal{U}\tau^2 \neq \mathcal{U}\tau, T_z(s).$$

Notice that

$$(T_z(s))\tau = T_z(s), \quad \text{since } s\tau = s, \quad \text{so } T_z(s) \neq \mathcal{U}\tau^2.$$

In particular $w\beta^{-1}\alpha^{-1}$ is in \mathcal{W} and also bridges to \mathcal{LA}_α in a point which is in $[z, w]$. Then $w\beta^{-1}$ bridges to \mathcal{LA}_α in a point which is in $[z\alpha, w]$ so in particular $w\beta^{-1}$ is in $\mathcal{U} \subset \mathcal{W}$. But then $w\beta^{-1}\alpha^{-1}$ and $w\alpha^{-1}$ are both in \mathcal{U} , contradicting $\mathcal{W}\gamma \cap \mathcal{W} = \emptyset$.

This finishes the analysis of possibility $z\alpha \in (z, w)$.

Situation II – Suppose $z\alpha^{-1} \in (z, w)$.

Consider first the case when $z\alpha \in \mathcal{U}\tau^{-1}$, that is $T_z(z\alpha) = T_z(w\tau^{-1})$. This is very similar to Situation I, second part. Since $z\alpha$ is not in \mathcal{U} , this in particular implies $\mathcal{U}\tau \neq \mathcal{U}$. Here $w\tau \notin \mathcal{U}$, hence it bridges to \mathcal{LA}_α in a point which is not in $(z, w]$. It follows that $w\tau\alpha$ bridges to \mathcal{LA}_α in a point which is not in $(z\alpha, w]$. This implies that $w\tau\alpha$ is in $T_z(z\alpha) = T_z(w\tau^{-1})$. Hence

$$w\beta^{-1} = w\tau\alpha\tau^{-1} \quad \text{is in } T_z(w\tau^{-2}) \neq T_z(s), T_z(w\tau^{-1}).$$

The first fact means that $w\beta^{-1}$ is in \mathcal{W} . The second fact means that $w\beta^{-1}$ is not in $T_z(z\alpha)$, hence $w\beta^{-1}$ bridges to \mathcal{LA}_α in a point contained in $[z, w]$. Hence $w\beta^{-1}\alpha^{-1}$ bridges to \mathcal{LA}_α in a point contained in $[z\alpha^{-1}, w]$ and is in \mathcal{W} . As $w\beta^{-1}\alpha^{-1}\gamma = w\beta^{-1}$, this would imply $\mathcal{W}\gamma = \mathcal{W}$, again contradiction. Hence this cannot occur.

Now we know $z\alpha$ is not in $T_z(w\tau^{-1})$. The point $z\beta = z\alpha^{-1}\tau^{-1}$ is in $T_z(w\tau^{-1})$, hence it bridges to \mathcal{LA}_α in a point contained in $[z, w]$. It follows that $z\beta\alpha^m$ bridges to \mathcal{LA}_α in a point contained in $[z\alpha^m, w]$. But

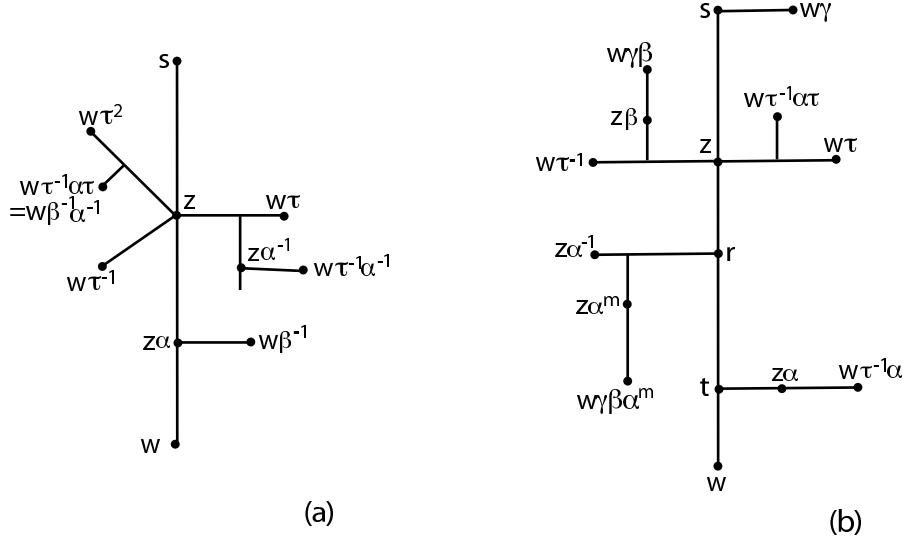

Figure 19: a. Situation I, Situation III.

$$z\alpha^m \in \mathcal{U} \Rightarrow z\beta\alpha^m \in \mathcal{U} \Rightarrow z\gamma^{-1}\alpha\tau \in \mathcal{U} \text{ or } z\gamma^{-1}\alpha \in T_z(w\tau^{-1})$$

and bridges to $\mathcal{L}\mathcal{A}_\alpha$ in a point in $[z, w]$. It follows that $z\gamma^{-1}$ bridges to $\mathcal{L}\mathcal{A}_\alpha$ in a point in $[z\alpha^{-1}, w]$, hence $z\gamma^{-1} \in \mathcal{U} \subset \mathcal{W}$, impossible.

We conclude that situation II cannot occur. This proves the last 2 assertions of the lemma 8.2. It also implies that the following situation must occur:

Situation III – $z\alpha \notin (z, w), z\alpha^{-1} \notin (z, w)$, see fig. 19, b.

What is left to prove of lemma 8.2 is that $\mathcal{U}\tau = \mathcal{U}$. So suppose that $\mathcal{U}\tau \neq \mathcal{U}$.

Here $z\alpha^{-1}$ bridges to $[z, w]$ in a point r which is in (z, w) . Also $z\alpha$ bridges to t in $[z, w]$ with t also in (z, w) .

The point $w\gamma$ is not in \mathcal{W} , so it is in $T_z(s)$ and bridges to $[w\tau^{-1}, z]$ in z . Hence $w\gamma\beta$ bridges to $[w\tau^{-1}, z\beta]$ in $z\beta$. But $z\beta = z\alpha^{-1}\tau^{-1}$ bridges to $[z, w\tau^{-1}]$ in $r\tau^{-1}$. Then $w\gamma\beta$ bridges to $[z, w]$ in z (this uses $\mathcal{U}\tau \neq \mathcal{U}$!). Then

$$w\gamma\beta\alpha^m \text{ bridges to } [z, w] \text{ in a point in } (z, w) \text{ so } w\gamma\beta\alpha^m \in \mathcal{U}.$$

On the other hand $w\tau^{-1}$ bridges to $[z, w]$ in z so $w\tau^{-1}\alpha$ bridges to $[z, w]$ in a point in (z, w) and $w\tau^{-1}\alpha$ is in \mathcal{U} . Then $w\tau^{-1}\alpha\tau$ is in $\mathcal{U}\tau$. Of course this implies $\mathcal{U}\tau = \mathcal{U}$, contrary to assumption.

So in any case we conclude that $\mathcal{U}\tau = \mathcal{U}$. This finishes the proof of lemma 8.2. \square

This lemma is very useful. Since there is no fixed point of τ in (z, w) and $T_z(w)\tau = T_z(w)$ it follows that there is a local axis $\mathcal{L}\mathcal{A}_\tau$ of τ contained in $\mathcal{U} = T_z(w)$ with an ideal point z .

Lemma 8.3. w is not in $\mathcal{L}\mathcal{A}_\tau$.

Proof. Suppose not, that is, $w \in \mathcal{L}\mathcal{A}_\tau$. Here we will use lemma 4.6: Suppose that $\mathcal{L}\mathcal{A}_\tau$ is a local axis for τ and w is a point in $\mathcal{L}\mathcal{A}_\tau$ with $w\alpha = w$. Then at least one of the components of $T - \{w\}$ containing $w\tau, w\tau^{-1}$ is not invariant under α .

Situation I – $w\tau^{-1} \in [z, w]$.

Here $\mathcal{V} = T_w(z) = T_w(w\tau^{-1})$ is invariant under α . By lemma 4.6, the set $\mathcal{R} = T_w(w\tau)$ is not invariant under α . Notice that $\mathcal{R}\alpha$ is not equal to \mathcal{V} either.

Use $w\alpha\tau = w\tau = w\tau\alpha\beta\alpha^{m-1}$. Here

$$w\tau \in \mathcal{R} \Rightarrow w\tau\alpha \in \mathcal{R}\alpha \neq \mathcal{V} \Rightarrow w\tau\alpha\tau \in \mathcal{R}\tau \subset \mathcal{R} \Rightarrow c = w\tau\alpha\tau\alpha^{-1} \in \mathcal{R}\alpha^{-1} \neq \mathcal{R}.$$

So c bridges to w in $\mathcal{L}\mathcal{A}_\tau$ and then $w\tau\alpha\tau\alpha^{-1}\tau^{-1} = w\tau\alpha\beta$ bridges to $w\tau^{-1}$ in $\mathcal{L}\mathcal{A}_\tau$ and is then in \mathcal{V} . Finally $w\tau\alpha\beta\alpha^{m-1}$ is in $\mathcal{V}\alpha^{m-1} = \mathcal{V}$. This is not \mathcal{R} , contradiction.

Situation II – $w\tau \in (z, w)$.

Here $\mathcal{V} = T_w(w\tau) = T_w(z)$ is invariant under α . Let $\mathcal{R} = T_w(w\tau^{-1})$, which is not invariant under α . Use $w\tau^{-1}\alpha\tau = w\alpha\beta\alpha^{m-1}$. Then $w\tau^{-1}$ is in \mathcal{R} , so $w\tau^{-1}\alpha$ is not in \mathcal{R} or \mathcal{V} and bridges to w in $\mathcal{L}\mathcal{A}_\tau$. Then $w\tau^{-1}\alpha\tau$ bridges to $w\tau$ in $\mathcal{L}\mathcal{A}_\tau$ and is in \mathcal{V} . It follows that

$$w\tau^{-1}\alpha\tau\alpha^{1-m} = w\alpha\beta = w\beta = w\tau\alpha^{-1}\tau^{-1} \text{ is in } \mathcal{V}.$$

Hence $w\tau\alpha^{-1}$ is in $\mathcal{V}\tau$. This implies

$$w\tau\alpha^{-1} \prec w\tau \prec w \quad \Rightarrow \quad w\tau \prec w\tau\alpha \prec w \quad \Rightarrow \quad w \prec w\tau\alpha\tau^{-1} = w\beta^{-1} \prec w\tau^{-1}.$$

In particular $w\beta^{-1}$ is in \mathcal{R} and $w\beta^{-1}\alpha^{-1}$ is in $\mathcal{R}\alpha^{-1}$ which is not equal to \mathcal{V} . Also $w\beta^{-1}\alpha^{-1} = w\tau^{-1}\alpha^{-1}\tau$. Here $w\tau^{-1}\alpha^{-1}$ is in $\mathcal{R}\alpha^{-1}$ and bridges to w in $\mathcal{L}\mathcal{A}_\tau$ and so $w\tau^{-1}\alpha^{-1}\tau$ bridges to $w\tau$ in $\mathcal{L}\mathcal{A}_\tau$ and so is in \mathcal{V} . As \mathcal{V} is not equal to $\mathcal{R}\alpha^{-1}$, this is a contradiction.

We conclude that situation II cannot happen either. This finishes the proof of the lemma. \square

Now we know that w is not in $\mathcal{L}\mathcal{A}_\tau$.

Lemma 8.4. z is not in $\mathcal{L}\mathcal{A}_\alpha$.

Proof. Suppose not, that is, $z \in \mathcal{L}\mathcal{A}_\alpha$. This implies that either $z\alpha$ or $z\alpha^{-1}$ is in (z, w) . Then lemma 8.2 implies that $s = z$.

Suppose first that $z\alpha \in (z, w)$. So $z\alpha^{-1} \notin T_z(w) = \mathcal{U}$. Use $z\alpha\tau = z\beta\alpha^m$. As $z\alpha \in \mathcal{U}$, then $z\alpha\tau$ is in \mathcal{U} also. Then

$$z\alpha^{-1} \notin \mathcal{U} \Rightarrow z\alpha^{-1}\tau^{-1} \notin \mathcal{U} \Rightarrow z\beta \text{ bridges to } [z, w] \text{ in } z$$

and $z\beta\alpha^m$ bridges to $[z\alpha^m, w] \supset [z, w]$ in $z\alpha^m$. It follows that $z\beta\alpha^m$ is not in \mathcal{U} , contradiction.

Suppose now that $z\alpha^{-1}$ is in $[z, w]$. Then $z\alpha^{-1}\tau^{-1} = z\beta$ is in \mathcal{U} and bridges to $[z, w]$ in a point t which is not z . Then $z\beta\alpha^m$ bridges to $[z, w]$ in $t\alpha^m$ and $z\beta\alpha^m$ is in \mathcal{U} . On the other hand $z\alpha$ is not in \mathcal{U} and so $z\alpha\tau$ is not in \mathcal{U} either. This is a contradiction.

This finishes the proof of the lemma. \square

Summary in Case C.3 – So far we have proved: suppose that $w\alpha = w$, $s\kappa = s$, no fixed points of κ or α in (s, w) . Let $z \in [s, w)$, the closest to w with $z\tau = z$. Then

$$T_z(w)\tau = T_z(w), \quad T_w(z)\alpha = T_w.$$

If $\mathcal{L}\mathcal{A}_\tau, \mathcal{L}\mathcal{A}_\alpha$ are the corresponding local axes of τ and α then $z \notin \mathcal{L}\mathcal{A}_\alpha$, $w \notin \mathcal{L}\mathcal{A}_\tau$.

Case C.3.0 – Suppose that $\mathcal{L}\mathcal{A}_\alpha \cap \mathcal{L}\mathcal{A}_\tau$ has at most one point.

This is very simple. Let $[c, d]$ be the bridge from $\mathcal{L}\mathcal{A}_\tau$ to $\mathcal{L}\mathcal{A}_\alpha$, where $c = d$ if the intersection is one point. We do the proof for $c \neq d$, the other is very similar. Use $z\tau^{-1}\alpha\tau = z\alpha\beta\alpha^{m-1}$. The right side is $z\alpha\tau$. Here $z\alpha$ bridges to $\mathcal{L}\mathcal{A}_\alpha$ in $d\alpha$, hence bridges to $\mathcal{L}\mathcal{A}_\tau$ in c . So $z\alpha\tau$ bridges to $\mathcal{L}\mathcal{A}_\tau$ in $c\tau$.

So $z\alpha\tau$ bridges to \mathcal{LA}_α in d so $z\alpha\tau\alpha^{-1}$ bridges to \mathcal{LA}_α in $d\alpha^{-1}$ and to \mathcal{LA}_τ in c . So $z\alpha\tau\alpha^{-1}\tau^{-1} = z\alpha\beta$ bridges to \mathcal{LA}_τ in $c\tau^{-1}$ hence to \mathcal{LA}_α in c . Finally $z\alpha\beta\alpha^{m-1}$ bridges to \mathcal{LA}_α in $d\alpha^{m-1}$ hence to \mathcal{LA}_τ in c . Since $c \neq c\tau$ this is a contradiction.

Case C.3.1 – Now assume $\mathcal{LA}_\alpha \cap \mathcal{LA}_\tau$ has more than one point. We will use the analysis done in case B.

If $\mathcal{U}\gamma$ is not equal \mathcal{U} then we use the proof of case B.1.3 – which was done also for local axis of α . This disallows this case.

The remaining case is that $\mathcal{U}\gamma$ is equal to \mathcal{U} . As explained in case B.1.4 this implies γ leaves \mathcal{LA}_τ invariant. Here we consider the intersection $\mathcal{B} = \mathcal{LA}_\alpha \cap \mathcal{LA}_\tau$. First notice that z is not in \mathcal{B} . If z were a limit point of \mathcal{B} then \mathcal{B} would be $(z, r]$ (recall that w is not in \mathcal{LA}_τ). Then as α leaves invariant \mathcal{LA}_α we would have $z\alpha = z$ also ruled out by non trivial action of the group on T . If \mathcal{LA}_τ is not properly embedded on the other side let v be the other ideal point of \mathcal{LA}_τ . Then

$$v\kappa = v, \quad (T_w(v))\alpha = T_w(v), \quad (T_v(w))\tau = T_v(w).$$

Also (w, v) has no fixed points of τ . Suppose that v is in \mathcal{LA}_α . Then (w, v) also has no fixed points of α . But then v has the same properties as z and this case is ruled out by lemma 8.4. It follows that v is not in \mathcal{LA}_α . So if \mathcal{LA}_τ has another ideal point v , then \mathcal{B} is $[r, t]$ with t an actual point in \mathcal{LA}_τ .

Now we can apply the analysis of case B.1.4 which was also done for α with a local axis. The analysis rules out this situation.

This shows that case C.3.1 cannot happen either.

This finishes the proof of the main theorem.

9 Remarks

There are a lot of interesting questions still open. First we discuss some internal questions about the proofs in this article. The proof of the **R**-covered case uses $p > 3q$ for α orientation reversing. It would be useful to get a more general proof – for instance showing that p must be equal to 4 or that p has to be even. We obtained some preliminary results, but not conclusive. The same argument and condition $p > 3q$ are then used in various places of the article so it would be very good to discover a more general proof.

Also the best possible result for the manifolds $M_{p/q}$ described in this article would be the following: If $p \geq q$, p odd, $m \leq -4$ then the only possible essential laminations are those coming from either stable or unstable lamination in the original manifold M – these remain essential whenever $|p - 2q| \geq 2$. One way to interpret such a goal is a rigidity result – all laminations in this manifold have to be of this type. Notice that Brittenham's results for Seifert fibered spaces [Br1] are of this form. Also Hatcher and Thurston's results for surgery on 2-bridge links [Ha-Th] are along these lines.

Now on for more general goals: How far can the methods of this article be generalized? Can they be used whenever M is a punctured torus bundle over S^1 with Anosov monodromy and degeneracy locus $(1, 2)$? Probably a mixture of topological methods and group action methods needs to be used. How about surface bundles, where the surface has higher genus? What about other degeneracy locus as discovered by Gabai-Kazez [Ga-Ka1]?

Since essential laminations do not exist in every closed hyperbolic 3-manifold, one looks for useful generalizations. One possible idea was introduced by Gabai in [Ga5]: a lamination λ in M , compact, orientable, irreducible is *loosesse* if λ satisfies:

0) λ has no sphere leaves and

1) for any leaf L of λ , the homomorphism $\pi_1(L) \rightarrow \pi_1(M)$ induced by inclusion is injective, and for any closed complementary region V , the homomorphism $\pi_1(V) \rightarrow \pi_1(M)$ induced by inclusion is injective.

Gabai [Ga5] conjectured that under these conditions and M closed then $\tilde{\lambda}$ is a product lamination and \tilde{M} is homeomorphic to \mathbf{R}^3 . One test case is the class of manifolds $M_{p/q}$ studied in this article. When $|p - 2q| = 1$ the lamination coming from the stable lamination has monogons. The leaves are either planes or have \mathbf{Z} fundamental group. The complementary region is a solid torus. So to check for looseness one only needs to understand if leaves inject in the fundamental group level.

References

- [Bk1] M. Baker, *Covers of Dehn fillings on once punctured bundles*, Proc. A.M.S. **105** (1989) 747-754.
- [Bk2] M. Baker, *Covers of Dehn fillings on once punctured bundles, II*, Proc. A.M.S. **110** (1990) 1099-1108.
- [Ba1] T. Barbot, *Flots d'Anosov sur les variétés graphées au sens de Waldhausen*, Ann. Inst. Fourier Grenoble **46** (1996) 1451-1517.
- [Ba2] T. Barbot, *Actions de groupes sur les 1-variétés non séparées et feuilletages de codimension un*, Ann. Fac. Sci. Toulouse Math. **7** (1998) 559-597.
- [BNS] R. Bieri, W. Neumann and R. Strebel, *A geometric invariant of discrete groups*, Inven. Math. **90** (1987) 451-477.
- [Bl-Ca] S. Bleiler and A. Casson, *Automorphisms of surfaces after Nielsen and Thurston*, Cambridge Univ. Press, 1988.
- [Br1] M. Brittenham, *Essential laminations in Seifert fibered spaces*, Topology **32** (1993) 61-85.
- [Br2] M. Brittenham, *Essential laminations and deformations of homotopy equivalences: from essential pullback to homeomorphism*, Topol. Appl. **60** (1994) 249-265.
- [Br3] M. Brittenham, *Persistently laminar tangles*, Jour. Knot Th. Ram. **8** (1999) 415-428.
- [Br4] M. Brittenham, *Persistent laminations from Seifert surfaces*, Jour. Knot Th. Ram. **10** (2001) 1155-1168.
- [Bu-Zi] G. Burde and H. Zieschang, *Knots*, Studies in Mathematics **5**, de Gruyter, Berlin, 1985.
- [Ca-Du] D. Calegari and N. Dunfield, *Laminations and groups of homeomorphisms of the circle*, preprint, 2002.
- [CJR] M. Culler, W. Jaco and H. Rubinstein, *Incompressible surfaces in once punctured torus bundles*, Proc. L.M.S. **45** (1982) 385-419.
- [Cu-Vo] M. Culler and K. Vogtman, *A group theoretic criterion for property FA*, Proc. A.M.S. **124** (1996) 676-683.
- [De-Ro] C. Delman and R. Roberts, *Alternating knots satisfy strong property P*, Comm. Math. Helv. **74** (1999) 376-397. Comm. Math. Helv. **73** (1998) 259-297.
- [Fe] S. Fenley, *Pseudo-Anosov flows and incompressible tori*, submitted.
- [Fl-Ha] W. Floyd and A. Hatcher, *Incompressible surfaces in punctured torus bundles*, Topol. Appl. **13** (1982) 263-282.
- [Ga1] D. Gabai, *Foliations and the topology of 3-manifolds*, J. Diff. Geo. **18** (1983) 445-503.
- [Ga2] D. Gabai, *Foliations and the topology of 3-manifolds II*, J. Diff. Geo. **26** (1987) 461-478.
- [Ga3] D. Gabai, *Foliations and the topology of 3-manifolds III*, J. Diff. Geo. **26** (1987) 479-536.
- [Ga4] D. Gabai, *8 problems in foliations and laminations*, in Geometric Topology, W. Kazez, ed., Amer. Math. Soc. 1987, 1-33.
- [Ga5] D. Gabai, *3 lectures on foliations and laminations on 3-manifolds*, Laminations and foliations in dynamics, geometry and topology (Stony Brook, NY 1998), 87-109, Contemp. Math., 269, Amer. Math. Soc. Providence, 2001.
- [Ga-Ka1] D. Gabai and W. Kazez, *Pseudo-Anosov maps and surgery on fibred 2-bridge knots*, Topol. Appl. **37** (1990) 93-100.
- [Ga-Ka2] D. Gabai and W. Kazez, *Order trees and laminations of the plane*, Math. Res. Lett. **4** (1997) 603-616.
- [Ga-Ka3] D. Gabai and W. Kazez, *Homotopy, isotopy and genuine laminations of 3-manifolds*, in Geometric Topology (Athens, GA 1993) 123-138, AMS/IP Stud. Adv. Math., 2.1, Amer. Math. Soc., Providence, RI, 1997.
- [Ga-Ka4] D. Gabai and W. Kazez, *Group negative curvature for 3-manifolds with genuine laminations*, Geom. Topol. **2** (1998) 65-77.
- [Ga-Oe] D. Gabai and U. Oertel, *Essential laminations and 3-manifolds*, Ann. of Math. **130** (1989) 41-73.
- [Gh-Ha] *Sur les groupes hyperboliques d'après Mikhael Gromov*, E. Ghys and P. De la Harpe, editors, Birkhäuser, 1990.
- [Gr] M. Gromov, *Hyperbolic groups*, in Essays on Group theory, Springer-Verlag, 1987, pp. 75-263.
- [Hak1] W. Haken, *Theorie der normal flächen*, Acta Math. **105** (1961) 245-375.
- [Hak2] W. Haken, *Some results on surfaces in 3-manifolds*, Studies in modern topology, Math. Assoc. Amer., distributed by Prentice Hall (1968) 39-98.
- [Hat1] A. Hatcher, *On the boundary curves of incompressible surfaces*, Pac. Jour. Math. **99** (1982) 373-377.
- [Hat2] A. Hatcher, *Some examples of essential laminations in 3-manifolds*, Ann. Inst. Fourier Grenoble **42** (1992) 313-325.
- [Ha-Oe] A. Hatcher and U. Oertel, *Boundary slopes for Montesinos knots*, Topology **28** (1989) 453-480.

- [Ha-Th] A. Hatcher and W. Thurston, *Incompressible surfaces in 2-bridge knot complements*, Inven. Math. **79** (1985) 225-246.
- [He] J. Hempel, *3-manifolds*, Ann. of Math. Studies 86, Princeton University Press, 1976.
- [Jo] T. Jorgenson, *Compact 3-manifolds of constant negative curvature*, Annals of Math. **106** (1977) 61-72.
- [Mo-Sh1] J. Morgan and P. Shalen, *Valuations, trees and degenerations of hyperbolic structures, I*, Ann. of Math. **120** (1984) 401-476.
- [Mo-Sh2] J. Morgan and P. Shalen, *Degenerations of hyperbolic structures, II. Measured laminations in 3-manifolds*, Ann. of Math. **127** (1988) 403-456.
- [Mo-Sh3] J. Morgan and P. Shalen, *Degenerations of hyperbolic structures, III. Actions of 3-manifold groups on trees and Thurston's compactness theorem*, Ann. of Math. **127** (1988) 457-519.
- [Mo1] L. Mosher, *Dynamical systems and the homology norm of a 3-manifold I. Efficient intersection of surfaces and flows*, Duke Math. Jour. **65** (1992) 449-500.
- [Mo2] L. Mosher, *Laminations and flows transverse to finite depth foliations*, Part I: Branched surfaces and dynamics – available from <http://newark.rutgers.edu:80/~mosher/>, Part II in preparation.
- [Na] R. Naimi, *Foliations transverse to fibers of Seifert manifolds*, Comm. Math. Helv., **69** (1994) 155-162.
- [No] S. P. Novikov, *Topology of foliations*, Trans. Moscow Math. Soc. **14** (1963) 268-305.
- [Oe] U. Oertel, *Closed incompressible surfaces in complements of star links*, Pac. Jour. Math. **111** (1984) 209-230.
- [Re] G. Reeb, *Sur certains propriétés topologiques des variétés feuilletées*, Actual. Sci. Ind. **1183**, Hermann, Paris, 1952.
- [Ro1] R. Roberts, *Constructing taut foliations*, Comm. Math. Helv. **70** (1995) 516-545.
- [Ro2] R. Roberts, *Taut foliations in punctured surfaces bundles, I*, Proc. London Math. Soc. (3) **82** (2001) 747-768.
- [Ro3] R. Roberts, *Taut foliations in punctured surface bundles, II*, Proc. London Math. Soc. (3) **83** (2001) 443-471.
- [Ro-St1] R. Roberts and M. Stein, *Exceptional Seifert group actions on \mathbf{R}* , Jour. Knot Th. Ram. **8** (1999) 241-247.
- [Ro-St2] R. Roberts and M. Stein, *Group actions on order trees*, Topol. Appl. **115** (2001) 175-201.
- [RSS] R. Roberts, J. Shareshian and M. Stein, *Infinitely many hyperbolic 3-manifolds which contains no Reebless foliation*, preprint, 2001.
- [Rol] D. Rolfsen, *Knots and links*, Publish or Perish, 1976.
- [Sc] P. Scott, *The geometries of 3-manifolds*, Bull. London Math. Soc. **15** (1983) 401-487.
- [Se] J. P. Serre, *Trees*, Springer, Berlin 1980.
- [Th1] W. Thurston, *The geometry and topology of 3-manifolds*, Princeton University Lecture Notes, 1982.
- [Th2] W. Thurston, *Three dimensional manifolds, Kleinian groups and hyperbolic geometry*, Bull. A.M.S. **6** (1982) 357-381.
- [Th3] W. Thurston, *Hyperbolic structures on 3-manifolds II: Surface groups and 3-manifolds that fiber over the circle*, preprint.
- [Th4] W. Thurston, *On the geometry and dynamics of diffeomorphisms of surfaces*, Bull. A.M.S. **19** (1988) 417-431.
- [Th5] W. Thurston, *3-manifolds, foliations and circles II: Transverse asymptotic geometry of foliations*, preprint.
- [Th6] W. Thurston, *The universal circle for foliations and transverse laminations*, lectures in M.S.R.I., 1997.
- [Wa] K. Waldhausen, *On irreducible 3-Manifolds which are sufficiently large*, Ann. of Math. **87** (1968) 56-88.

Florida State University
Tallahassee, FL 32306-4510