

Complex Angular Momentum in General Quantum Field Theory

J. Bros ^a and G.A. Viano ^b

^a Service de Physique Théorique, CEA–Saclay
F–91191 Gif–sur–Yvette Cedex, France

^b Istituto Nazionale di Fisica Nucleare (I.N.F.N.),
Sezione di Genova,
Dipartimento di Fisica dell’Università, Genova, Italy

November 20, 1998

Abstract

It is proven that for each given two-field channel - called the “ t -channel” - with (off-shell) “scattering angle” Θ_t , the four-point Green’s function of any scalar Quantum Fields satisfying the basic principles of locality, spectral condition together with temperateness admits a Laplace-type transform in the corresponding complex angular momentum variable λ_t , dual to Θ_t . This transform enjoys the following properties: a) it is holomorphic in a half-plane of the form $\text{Re } \lambda_t > m$, where m is a certain “degree of temperateness” of the fields considered, b) it is in one-to-one (invertible) correspondence with the (off-shell) “absorptive parts” in the crossed two-field channels, c) it extrapolates in a canonical way to complex values of the angular momentum the coefficients of the (off-shell) t -channel partial-wave expansion of the Euclidean four-point function of the fields. These properties are established for all space-time dimensions $d + 1$ with $d \geq 2$.

1 Introduction

The complex angular momentum analysis was widely used in the sixties, in particle physics, for describing the high-energy asymptotic behaviour of the scattering amplitude. With the arrival of QCD much attention was diverted away from the “old-fashioned” approach to the strong interactions. Interest was reignited (see [1] and references therein) within the particle physics community with the arrival of colliders capable of delivering very large centre-of-mass energies (e.g. the HERA collider at DESY and the Tevatron collider at FNAL); from the theoretical viewpoint, this revival was made possible by the much earlier important results of BFKL[2] who discovered and characterized the Regge-like asymptotic properties of appropriate resummations of perturbative amplitudes ¹ in QCD.

In the deep inelastic lepton-proton scattering a central role is played by the so-called “structure-functions” which parametrize the structure of the target as “seen” by the virtual photon. They are usually denoted by $F_i(x, Q^2)$, where $Q^2 = -q^2$ and $q^\mu = k^\mu - k'^\mu$ is the momentum transfer (k^μ and k'^μ being respectively the incoming and outgoing lepton four-momenta), while $x = \frac{Q^2}{2\nu}$, $\nu = p \cdot q$ ($p^2 = M^2$, M being the proton mass). It is now possible to explore the structure functions in a region where the momentum transfer is much smaller than the centre- of - mass energy, i.e. for small values of x . In the parton model one can show that the x -dependence, in the limit $x \rightarrow 0$, is related to the behaviour of hadronic scattering cross-sections at high energy [4]. This behaviour, which appears to exhibit Regge-like asymptotic properties, is reminiscent of the concept of “exchange of families of particles with different spins”. A detailed analysis of small x structure function measurements, at fixed target energies [5], show that they are indeed approximately consistent with the predictions of such a model. We can thus say that, on one side, the phenomenology calls for an extension of the conventional exchange process and suggests an exchange mechanism involving families of particles; on the other side, from a theoretical viewpoint, these families could be described by “moving poles”, namely, poles in a certain “complex angular momentum plane”.

The complex angular momentum theory originated long ago in connection with some problems of classical mathematical physics, mainly the diffraction

¹see also [3] for similar results in the case of scalar fields

[6]. Then Regge [7] extended these methods to quantum mechanics and specifically to the scattering by Yukawian potentials (see also [8]). In these works, the complex angular momentum analysis was produced by a direct analytic interpolation to complex values of the angular momentum variable of the relevant differential equations for partial waves. Then several authors (see [9] and references therein) conjectured that the results proved by Regge, at non-relativistic level, might as well be applied to the high energy relativistic dynamics where the method could really display all its power. This relativistic extension, which of course could no more be justified in a simple framework of differential equations, was given a tentative formulation [9] in the approach of the so-called “*S*-matrix theory” based on the general, but rather loose concept of “maximal analyticity”. However, it must be emphasized that since that time no genuine relativistic complex angular momentum theory relying on the general principles of Quantum Field Theory (Q.F.T.) has been given at all.

In view of the considerations developed above, one is then led to set the following question whose conceptual interest is of primary importance:

Is it possible to find in the framework of general Q.F.T. a mathematical structure which leads to poles moving in the complex angular momentum plane and that are responsible for an exchange mechanism involving families of particles and giving rise to Regge-like asymptotic properties, as suggested by the analyses of BFKL[2] and Bergère et al.[3] in the philosophy of resummations of perturbative QFT?

We have already announced and briefly sketched a positive answer to this question in a previous work [10]. Here we shall provide a detailed proof of the first basic result of [10], namely the existence of a field-theoretical off-shell version of the Froissart-Gribov representation of the partial-waves [11,12]; the latter had been discovered by these authors in 1961 in the analytic *S*-matrix approach of particle physics, requiring that the scattering amplitude should satisfy the Mandelstam representation. In order to prove our field-theoretical result we make use of a basic analyticity property of the four-point function *F* implied by the standard axioms of locality, spectrum and Lorentz invariance; moreover we use a majorization of *F* which is a consequence of the “temperateness axiom” of quantum field theory. The result which can be derived from these properties is the following: for each given two-field channel called the *t*-channel, with total squared energy-momentum *t* and (off-shell) scattering angle Θ_t , there exists an appropriate Fourier–Laplace type trans-

form of F with certain analyticity properties in the complex angular momentum λ_t which is the natural conjugate variable of Θ_t . One thus obtains a generalization of the relationship which exists in the standard Laplace transform theory between analyticity properties (including possible poles) of the transform and the asymptotic behaviour of the original function. From our viewpoint this Laplace-type transform can be regarded as the mathematical structure which relates the complex angular momentum poles (moving poles) to the high-energy asymptotic behaviour. Moreover this approach presents further advantages:

i) The analysis is completely worked out in the complex momentum space scenario appropriate to Q.F.T.[13] (see, on this point, our comment below).

ii) It is the joint exploitation of harmonic analysis on orbital manifolds of the Lorentz group together with basic analyticity properties of Q.F.T. which entails the complex angular momentum structure; this method holds in any space-time dimension $d + 1$ with $d \geq 2$.

iii) By the use of our Fourier-Laplace-type transformation one can perform a partial diagonalization (namely a diagonalization with respect to the angular variables) of the convolution product involved in the Bethe-Salpeter integral equations. This rigorous mathematical structure, which pertains to the general framework of Q.F.T., is thereby directly responsible for the existence of poles in the complex angular momentum variable. This is the content of our second basic result presented in [10], whose detailed proof will be given elsewhere[14].

One can specify the advantage mentioned in i) under two respects:

a) with respect to the S-matrix approach. The absorptive parts of F in the crossed two-field channels have their supports inside regions of appropriate one-sheeted hyperboloids determined by the future cone ordering relation (in view of the spectral conditions). This geometrical property can be properly specified in terms of energy-momentum configurations, which are of more controllable interpretation than the sets of Lorentz invariants, as they were used in the Mandelstam representation. As a matter of fact, the Mandelstam double spectral region (used in [11,12]) corresponds to complex energy-momentum configurations which have no simple physical interpretation.

b) with respect to the approach of Euclidean Q.F.T.. The fact that the “Euclidean partial-waves” admit an analytic interpolation in the complex angular momentum variables is explicitly shown to be equivalent to

the property of analytic continuation of the four-point function from Euclidean momentum-space to Minkowskian momentum-space (through a domain which is permitted by the requirements of locality and spectral conditions).

We now wish to stress that the conceptual interest of the present study can be envisaged from two viewpoints, according to whether the fundamental fields considered are those of the QCD-theory or the “elementary meson and baryon fields” used at the age of dispersion theory. In the latter case, which is the traditional case of application of the axioms of Q.F.T., our results appear as “off-shell results”; but in order to get rid of this restriction, one can use the analytic continuation technique adopted in the proof of dispersion relations (see [15] and references therein) and/or positivity constraints (analogous to those used by Martin[16]) to reach the mass-shell values and possibly a positive interval in the energy variable t , so that a range of possible bound-states might be included in our analysis. We now conjecture that our results might be applicable with even more interest to the former case, in which the phenomenon of confinement is present, so that the off-shell character of our study not only remains relevant but is even the only one to be relevant! In fact, it seems admitted that the general principles used here (locality, spectrum, Lorentz covariance, temperateness) still apply to theories of QCD-type in suitable gauges: our results on complex angular momentum analysis then follow without requiring the existence of asymptotic elementary particles of the fields and are fully consistent with confinement. Moreover, the possible production of *a discrete spectrum of composite particles (namely hadrons and possibly “glueballs”) appearing as “Regge-type particles”* via appropriate Bethe-Salpeter-type equations is built-in [10,14] in this general field-theoretical framework. In the present study, we only considered (for simplicity) the case of scalar fields; but one can expect that the joint exploitation of harmonic analysis on Lorentz orbital manifolds together with axiomatic analyticity still yields similar results for more general fields in Lorentz covariant gauges.

The paper is organized as follows. Sec.2 is devoted to an appropriate analysis of the complex geometry associated with a given two field t -channel. In Sec.3 we derive axiomatic analyticity properties and bounds of the four-point functions with respect to the (off-shell) scattering angle Θ_t in manifolds bordered by the s -cut and u -cut of the crossed channels. It is then shown in Sec.4 that these properties of the four-point function are equiva-

lent to the existence of a Laplace-type transform of the latter with respect to the corresponding complex angular momentum variable λ_t . This transform, which is explicitly defined in terms of the (off-shell) absorptive parts of the crossed s - and u -channels, is studied in arbitrary space-time dimension $d + 1$ ($d \geq 2$): analyticity and bounds in a half-plane $\text{Re } \lambda_t > m$ and the property of Carlsonian interpolation of the Euclidean partial-waves satisfied by this Laplace-type transform (Froissart-Gribov-type equalities) are established. The inverse of the transformation is also described and, as a by-product, the connection (mentioned above) between the analytic continuation from Euclidean to Minkowskian space and the analytic interpolation in the complex angular momentum plane is displayed. In Appendix A, we give mathematical tools used for the analytic completion of Sec.3. Appendix B is devoted to primitives and derivatives of non-integral order in a complex domain and to their Laplace transforms: it provides a complete treatment of the distribution-like character of the Green functions and absorptive parts in Sec.4.

2 Complex geometry associated with a two-field channel

Space-time and energy-momentum space are $(d+1)$ -dimensional, with $d \geq 2$. Vectors in $(d + 1)$ -dimensional Minkowskian space are represented by $k = (k^{(0)}, \vec{k}) = (k^{(0)}, k^{(1)}, \dots, k^{(d)})$; the corresponding scalar product is denoted $k.k' = k^{(0)}k'^{(0)} - k^{(1)}k'^{(1)} \dots - k^{(d)}k'^{(d)}$ and $k^2 = k.k = k^{(0)2} - \vec{k}^2$.

In all the following, a special role is played by a given two-field channel (called the t -channel) in which the pairs of incoming and outgoing complex energy-momenta are denoted respectively (k_1, k_2) and (k'_1, k'_2) ; we choose the corresponding set of independent vector-variables $K = k_1 + k_2 = k'_1 + k'_2$, $Z = \frac{k_1 - k_2}{2}$, $Z' = \frac{k'_1 - k'_2}{2}$. K is the total energy-momentum vector of this t -channel, whose squared energy is $t = K^2$. In this paper we shall always assume that K is fixed real and space-like, i.e. $t \leq 0$. We shall call \hat{M}_K (resp. $\hat{M}_K^{(c)}$) the space of all real (resp. complex) momentum configurations $[k] = (k_1, k_2, k'_1, k'_2)$ such that $k_1 + k_2 = k'_1 + k'_2 = K$. \hat{M}_K (resp. $\hat{M}_K^{(c)}$) is isomorphic to the real (resp. complex) space $\mathbb{R}^{2(d+1)}$ (resp. $\mathbb{C}^{2(d+1)}$) of the

couple of vectors (Z, Z') , Z and Z' being respectively the relative incoming and outgoing (off-shell) $(d + 1)$ -momenta of the t -channel.

Choosing once for all a time-axis with unit vector e_0 ($e_0^2 = 1$) determines the “Euclidean subspace” $\hat{\mathcal{E}}_K$ of $\hat{M}_K^{(c)}$ in which all the energy-momenta are of the form $k_i = \left(iq_i^{(0)}, \vec{p}_i \right)$, $k'_i = \left(iq_i'^{(0)}, \vec{p}_i' \right)$ (with $\vec{p}_i, \vec{p}_i', q_i^{(0)}, q_i'^{(0)}$ real).

We shall mainly consider the case $K \neq 0$, and choose K along the d -axis of coordinates: $K = \sqrt{-t} e_d$, where e_d denotes the corresponding unit vector ($e_d^2 = -1$). We also introduce the (off shell) “scattering angle” Θ_t of the t -channel as being the angle between the two-planes π and π' spanned respectively by the pairs of vectors (Z, K) (or (k_1, k_2)) and (Z', K) (or (k'_1, k'_2)). It is convenient to introduce (real or complex) unit vectors z, z' , (uniquely determined up to a sign) orthogonal to K and belonging respectively to π and π' , such that the following orthogonal decompositions hold:

$$Z = \rho z + w K, \quad Z' = \rho' z' + w' K, \quad (2.1.a)$$

$$\text{with} \quad z.K = z'.K = 0, \quad z^2 = z'^2 = -1, \quad (2.1.b)$$

or equivalently:

$$k_1 = \rho z + \left(w + \frac{1}{2} \right) K, \quad k_2 = -\rho z - \left(w - \frac{1}{2} \right) K, \quad (2.2.a)$$

$$k'_1 = \rho' z' + \left(w' + \frac{1}{2} \right) K, \quad k'_2 = -\rho' z' - \left(w' - \frac{1}{2} \right) K. \quad (2.2.b)$$

Then, the “scattering angle” Θ_t of the t -channel is defined by the equation:

$$\cos \Theta_t = -z.z' \quad (2.3)$$

(note that $\Theta_t = 0$ for $z = z'$).

The parameters ρ, w (resp. ρ', w') introduced in Eqs. (2.1), (2.2) can be computed in terms of the scalar products $Z^2, Z.K, K^2$ (resp. $Z'^2, Z'.K, K^2$) or, equivalently, in terms of the Lorentz invariants $\zeta_i = k_i^2$ (resp. $\zeta'_i = k_i'^2$), $i = 1, 2$, and t . One readily obtains:

$$w = \frac{Z.K}{t} = \frac{\zeta_1 - \zeta_2}{2t}, \quad w' = \frac{Z'.K}{t} = \frac{\zeta'_1 - \zeta'_2}{2t} \quad (2.4)$$

$$\rho^2 = -Z^2 + w^2 t = \frac{\Lambda(\zeta_1, \zeta_2, t)}{4t} \quad (2.5)$$

$$\rho'^2 = -Z'^2 + w'^2 t = \frac{\Lambda(\zeta'_1, \zeta'_2, t)}{4t}, \quad (2.6)$$

where:

$$\Lambda(a, b, c) = a^2 + b^2 + c^2 - 2(ab + bc + ca) = (a - b)^2 - 2(a + b)c + c^2 \quad (2.7)$$

Finally, the variable $\cos \Theta_t$ is also a Lorentz invariant which can be expressed as follows in terms of ζ_i, ζ'_i ($i = 1, 2$), t and the squared momentum transfer $s = (k_1 - k'_1)^2 = (Z - Z')^2$:

$$\cos \Theta_t = \frac{s + \rho^2 + \rho'^2 - (w - w')^2 t}{2\rho\rho'} \quad (2.8.a)$$

$$\text{or } \cos \Theta_t = \frac{2st + t^2 - (\zeta_1 + \zeta_2 + \zeta'_1 + \zeta'_2)t + (\zeta_1 - \zeta_2)(\zeta'_1 - \zeta'_2)}{[\Lambda(\zeta_1, \zeta_2, t)\Lambda(\zeta'_1, \zeta'_2, t)]^{1/2}} \quad (2.8.b)$$

The following alternative expression also holds:

$$\cos \Theta_t = \frac{-(u + \rho^2 + \rho'^2) + (w + w')^2 t}{2\rho\rho'}, \quad (2.9)$$

where u denotes the squared momentum transfer in the crossed channel, namely $u = (k_1 - k'_2)^2 = (Z + Z')^2$, which is such that:

$$u = -s - t + \zeta_1 + \zeta_2 + \zeta'_1 + \zeta'_2.$$

For $K = 0$, Eqs (2.1) ... (2.9) reduce to the following ones:

$$k_1 = -k_2 = Z = \rho z, \quad k'_1 = -k'_2 = Z' = \rho' z', \quad (2.10)$$

$$\rho^2 = -\zeta_1 = -\zeta_2, \quad \rho'^2 = -\zeta'_1 = -\zeta'_2 \quad (2.11)$$

$$\text{and } \cos \Theta_t = -\frac{Z.Z'}{\rho\rho'} = \frac{s - \zeta_1 - \zeta'_1}{2(\zeta_1\zeta'_1)^{1/2}} = -\frac{u - \zeta_1 - \zeta'_1}{2(\zeta_1\zeta'_1)^{1/2}} \quad (2.12)$$

The space of Lorentz invariants:

For any point $[k] = (k_1, k_2, k'_1, k'_2)$ in $\hat{M}_K^{(c)}$, we call $\mathcal{I}([k])$ the corresponding set of Lorentz invariants, namely $\{\zeta = (\zeta_1, \zeta_2), \zeta' = (\zeta'_1, \zeta'_2), (s, t, u)$ with $s + t + u = \zeta_1 + \zeta_2 + \zeta'_1 + \zeta'_2\}$, which vary in a complex space $\mathbb{C}_{(\mathcal{I})}^6$. In this space, the choice of variables adapted to the t -channel is specified as follows: $\mathcal{I}([k]) = (\mathcal{I}_t([k]), \cos \Theta_t)$ with $\mathcal{I}_t([k]) = (\zeta_1, \zeta_2, \zeta'_1, \zeta'_2, t)$.

For each K with $t = K^2 \leq 0$, let $\hat{\Omega}_K$ be the subset of all points $[k]$ in $\hat{M}_K^{(c)}$ whose parameters ρ, w, ρ', w' in the representation (2.2) are real-valued. This reality condition is equivalent (in view of Eqs (2.4), (2.5), (2.6)) to the fact that ζ_i, ζ'_i , ($i = 1, 2$) are real and satisfy the following inequalities:

$$\Lambda(\zeta_1, \zeta_2, t) \leq 0, \quad \Lambda(\zeta'_1, \zeta'_2, t) \leq 0,$$

which imply, for $K \neq 0$, that the points $\zeta = (\zeta_1, \zeta_2)$ and $\zeta' = (\zeta'_1, \zeta'_2)$ belong to the following parabolic region (see Fig 1):

$$\Delta_t = \{\zeta = (\zeta_1, \zeta_2) \in \mathbb{R}^2; (\zeta_1 - \zeta_2)^2 - 2(\zeta_1 + \zeta_2)t + t^2 \leq 0\} \quad (2.13)$$

For $K = 0$, the corresponding set Δ_0 is (in view of Eqs (2.11)) the half-line $\zeta_1 = \zeta_2 \leq 0$.

2.1 Lorentz foliation and the associated complex quadrics; the case $K \neq 0$:

Using the $(d - 1)$ -dimensional unit complex quadric:

For $K \neq 0$, the range of each vector z, z' in Eqs (2.2) is (in view of Eqs (2.1.b)) a $(d - 1)$ -dimensional complex quadric $X_{d-1}^{(c)}$ in the subspace orthogonal to K , namely:

$$X_{d-1}^{(c)} = \{z = (z^{(0)}, z^{(1)}, \dots, z^{(d-1)}) \in \mathbb{C}^d; z^{(0)2} - z^{(1)2} - \dots - z^{(d-1)2} = -1\} \quad (2.14)$$

Two real submanifolds of $X_{d-1}^{(c)}$ play an important role:

a) the one-sheeted hyperboloid $X_{d-1} = X_{d-1}^{(c)} \cap \mathbb{R}^d$, obtained by restricting $(z^{(0)}, \dots, z^{(d-1)})$ to real values in Eq. (2.14).

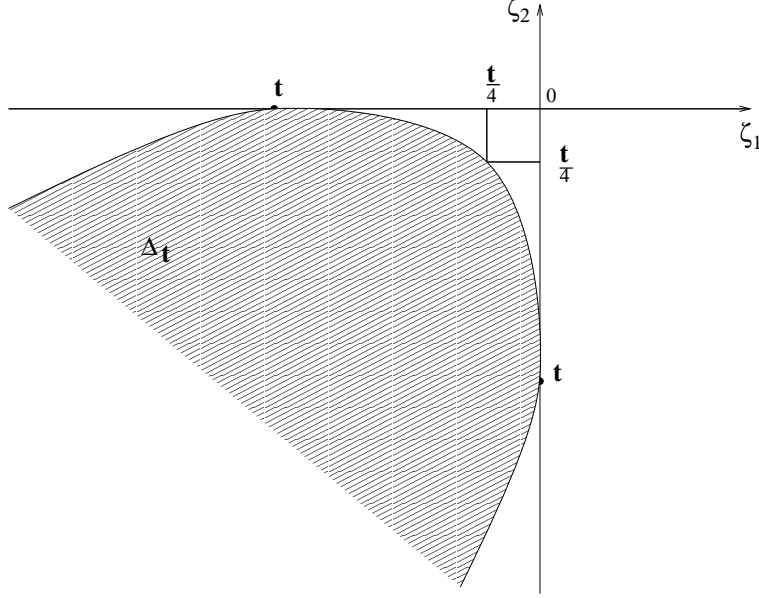

Figure 1

b) the “euclidean sphere” $\mathbb{S}_{d-1} = X_{d-1}^{(c)} \cap (i\mathbb{R} \times \mathbb{R}^{d-1})$, obtained by putting $z^{(0)} = iy^{(0)}$ and $z^{(1)} \dots z^{(d-1)}$ real in Eq. (2.14).

In view of Eqs (2.2)...(2.6), each point $[k] = (k_1, k_2, k'_1, k'_2)$ in $\hat{M}_K^{(c)}$ can thus be represented by $(\mathcal{I}_t([k]), (z, z'))$, with $\mathcal{I}_t([k]) = (\zeta, \zeta', t)$, $(\zeta, \zeta') \in \mathbb{C}^4$ and the pair (z, z') in $X_{d-1}^{(c)} \times X_{d-1}^{(c)}$.

We introduce the following *Cauchy–Riemann submanifold* $\hat{\Omega}_K$ of $\hat{M}_K^{(c)}$:

$$\hat{\Omega}_K = \left\{ [k] \equiv (\mathcal{I}_t([k]), (z, z')); (\zeta, \zeta') \in \Delta_t \times \Delta_t, (z, z') \in X_{d-1}^{(c)} \times X_{d-1}^{(c)} \right\}$$

We then distinguish the following *two maximal real submanifolds* of $\hat{\Omega}_K$:

a) (z, z') in $X_{d-1} \times X_{d-1}$: this submanifold is the subset $\hat{M}_K^{(sp)}$ of \hat{M}_K characterized by the condition that the two-planes π and π' determined respectively by the real vectors (k_1, k_2) (or (z, K)) and (k'_1, k'_2) (or (z', K)) are space-like.

b) (z, z') in $\mathbb{S}_{d-1} \times \mathbb{S}_{d-1}$: this is the Euclidean subspace $\hat{\mathcal{E}}_K$ of $\hat{M}_K^{(c)}$.

We note that in the representation $(\mathcal{I}_t([k]), (z, z'))$ of $[k]$ the pair (z, z') still contains *one Lorentz invariant*, namely $\cos \Theta_t = -z \cdot z'$, replaced equiv-

alently by s or u according to Eqs (2.8), (2.9), and that three situations are of special interest:

- i) $[k] \in \hat{\mathcal{E}}_K$: the corresponding condition $(z, z') \in \mathbb{S}_{d-1} \times \mathbb{S}_{d-1}$ then implies that $-1 \leq \cos \Theta_t \leq 1$
- ii) $[k] \in \hat{M}_K^{(sp)}$ and $s = (k_1 - k'_1)^2 > 0$: Eq. (2.8) implies that $\cos \Theta_t - 1 > 0$; the corresponding pair (z, z') lies in $X_{d-1} \times X_{d-1}$ in such a way that the two-plane spanned by z and z' is time-like (i.e. $\Theta_t = iv$ with v real, and $z.z' = -\cosh v$).
- iii) $[k] \in \hat{M}_K^{(sp)}$ and $u = (k_1 - k'_2) > 0$: Eq. (2.9) implies that $\cos \Theta_t + 1 < 0$ and one has: $(z, z') \in X_{d-1} \times X_{d-1}$ with $z.z' = \cosh v$ (i.e. $\Theta_t = \pi + iv$).

Let G be the connected Lorentz group acting in the Minkowskian space \mathbb{R}^{d+1} , namely $G \approx SO_0(1, d)$ and let $G^{(c)} \approx SO_0(1, d)^{(c)}$ be the complexified of G , acting on \mathbb{C}^{d+1} . Let then G_K (resp. $G_K^{(c)}$) be the stabilizer of K in G (resp. $G^{(c)}$). Since K is real and space-like, one has $G_K \approx SO_0(1, d-1)$ and $G_K^{(c)} \approx SO_0(1, d-1)^{(c)}$; G_K and $G_K^{(c)}$ act transitively respectively on X_{d-1} and $X_{d-1}^{(c)}$. We also introduce the maximal orthogonal subgroup $O_K \approx SO(d)$ of $G_K^{(c)}$ which acts transitively on the euclidean sphere \mathbb{S}_{d-1} of $X_{d-1}^{(c)}$.

With each (ζ, ζ', K) , $\zeta \in \Delta_t$, $\zeta' \in \Delta_t$, we associate the manifold

$$\hat{\Omega}_{(\zeta, \zeta', K)} = \left\{ [k] \in \hat{M}_K^{(c)}; [k] = [k]_{(\zeta, \zeta', K)}(z, z'); (z, z') \in X_{d-1}^{(c)} \times X_{d-1}^{(c)} \right\}, \quad (2.15)$$

where the mapping $[k] = [k]_{(\zeta, \zeta', K)}(z, z')$ is defined by Eqs (2.2), with the parameters ρ, w, ρ', w' reexpressed in terms of (ζ, ζ', t) via Eqs (2.4)...(2.6), namely

$$[k] = [k]_{(\zeta, \zeta', K)}(z, z'), \quad (z, z') \in X_{d-1}^{(c)} \times X_{d-1}^{(c)} : \quad (2.16.a)$$

$$k_1 = \left[\frac{\Lambda(\zeta_1, \zeta_2, t)}{4t} \right]^{\frac{1}{2}} z + \frac{\zeta_1 - \zeta_2 + t}{2t} K, \quad k_2 = - \left[\frac{\Lambda(\zeta_1, \zeta_2, t)}{4t} \right]^{\frac{1}{2}} z - \frac{\zeta_1 - \zeta_2 - t}{2t} K, \quad (2.16.b)$$

$$k'_1 = \left[\frac{\Lambda(\zeta'_1, \zeta'_2, t)}{4t} \right]^{\frac{1}{2}} z' + \frac{\zeta'_1 - \zeta'_2 + t}{2t} K, \quad k'_2 = - \left[\frac{\Lambda(\zeta'_1, \zeta'_2, t)}{4t} \right]^{\frac{1}{2}} z' - \frac{\zeta'_1 - \zeta'_2 - t}{2t} K. \quad (2.16.c)$$

The set $\{\hat{\Omega}_{(\zeta, \zeta', K)}; (\zeta, \zeta') \in \Delta_t \times \Delta_t\}$ defines a *foliation* of $\hat{\Omega}_K$ whose sheets $\hat{\Omega}_{(\zeta, \zeta', K)}$ have the following interpretation: for ζ and $\zeta' \notin \partial\Delta_t$, each submanifold $\hat{\Omega}_{(\zeta, \zeta', K)}$ is the product of two $(d-1)$ -dimensional complex quadrics and can be seen as *an orbit of the group* $G_K^{(c)} \times G_K^{(c)}$ via the action $(k_i, k'_i) \rightarrow (gk_i, g'k'_i), i = 1, 2, (g, g') \in (G_K^{(c)} \times G_K^{(c)})$. (Note that a similar foliation could be defined for the whole set $\hat{M}_K^{(c)}$; it is not used in the present paper).

We also note that the ‘‘Euclidean spheres’’ of the manifolds $\hat{\Omega}_{(\zeta, \zeta', K)}$ (obtained by restricting Eq.(2.16.a) to the set $\{(z, z') \in \mathbb{S}_{d-1} \times \mathbb{S}_{d-1}\}$) define correspondingly a foliation of the Euclidean subset $\hat{\mathcal{E}}_K$ of $\hat{\Omega}_K$.

Choice of a base point

Since the group $G_K^{(c)}$ acts transitively on $X_{d-1}^{(c)}$ it is convenient to introduce a ‘‘base-point’’ z_0 on the latter which we choose on the $(d-1)$ -axis of coordinates, namely $z_0 = (0, \dots, 0, 1, 0)$. By now assuming that the point z' is fixed at $z' = z_0$ in Eqs (2.2), one obtains a set of definitions which parallel those of the previous paragraph.

One thus defines $M_K^{(c)}$ (resp. Ω_K) as the subset of $\hat{M}_K^{(c)}$ (resp. $\hat{\Omega}_K$) in which the vectors (k'_1, k'_2) are real and belong to the (z_{d-1}, z_d) -plane of coordinates.

One also associates with each $(\zeta, \zeta', K), \zeta \in \Delta_t, \zeta' \in \Delta_t$, the manifold

$$\Omega_{(\zeta, \zeta', K)} = \left\{ [k] \in M_K^{(c)}; [k] = [k]_{(\zeta, \zeta', K)}(z, z_0); z \in X_{d-1}^{(c)} \right\}. \quad (2.17)$$

If $\zeta \notin \partial\Delta_t$, $\Omega_{(\zeta, \zeta', K)}$ is a $(d-1)$ dimensional complex quadric which is an orbit of the group $G_K^{(c)}$ via the action $(k_i, k'_i) \rightarrow (gk_i, k'_i), i = 1, 2, g \in G_K^{(c)}$. The set $\{\Omega_{(\zeta, \zeta', K)}; (\zeta, \zeta') \in \Delta_t \times \Delta_t\}$ thus defines a foliation of Ω_K ; Ω_K is a Cauchy-Riemann submanifold of $M_K^{(c)}$ whose complex structure is parametrized by the variable z in $X_{d-1}^{(c)}$ and which contains as maximal real submanifolds:

a) the real submanifold $M_K^{(sp)} = M_K^{(c)} \cap \hat{M}_K^{(sp)}$ obtained for z varying in X_{d-1} and characterized by the property that the plane π defined by the (real) points k_1, k_2 is space-like.

b) the euclidean subspace $\mathcal{E}_K = M_K^{(c)} \cap \hat{\mathcal{E}}_K$ obtained for z varying in \mathbb{S}_{d-1} .

Finally, the passage from the vectors to the invariants is summarized in

Proposition 1

Let \mathcal{I} be the projection which associates with each configuration $[k] \equiv (\mathcal{I}_t([k]), (z, z'))$ in $\hat{M}_K^{(c)}$ the set of invariants $\mathcal{I}([k]) = (\mathcal{I}_t([k]), \cos \Theta_t)$. This projection is implemented by the mapping $(z, z') \xrightarrow{i} \cos \Theta_t = -z \cdot z'$ which projects $X_{d-1}^{(c)} \times X_{d-1}^{(c)}$ onto \mathbb{C} .

Correspondingly, the restriction of \mathcal{I} to the subspace $M_K^{(c)}$ of $\hat{M}_K^{(c)}$ is implemented by the mapping $z \xrightarrow{i} \cos \Theta_t = -z \cdot z_0 = z^{(d-1)}$ which projects $X_{d-1}^{(c)}$ onto the complex $z^{(d-1)}$ -plane.

2.2 Lorentz foliation and the associated complex quadrics; the case $K = 0$:

For $K = 0$, the range of the vectors z and z' is the complex quadric:

$$X_d^{(c)} = \left\{ z = (z^{(0)}, z^{(1)}, \dots, z^{(d)}) \in \mathbb{C}^{d+1}; z^{(0)^2} - z^{(1)^2} - \dots - z^{(d)^2} = -1 \right\} \quad (2.18)$$

and one similarly introduces the real one-sheeted hyperboloid $X_d = X_d^{(c)} \cap \mathbb{R}^{d+1}$ and the euclidean sphere $\mathbb{S}_d = X_d^{(c)} \cap (i\mathbb{R} \times \mathbb{R}^d)$.

Each point $[k] = (k_1, -k_1, k'_1, -k'_1)$ in $\hat{M}_0^{(c)}$ is represented by $(\mathcal{I}_0([k]), (z, z'))$ where $\mathcal{I}_0([k]) = (\zeta, \zeta', 0)$ with $\zeta = (\zeta_1, \zeta_1)$, $\zeta' = (\zeta'_1, \zeta'_1)$, $\zeta_1 \in \mathbb{C}$, $\zeta'_1 \in \mathbb{C}$, and $(z, z') \in X_d^{(c)} \times X_d^{(c)}$. We note the degeneracy of the representation $(\mathcal{I}_0([k]), (z, z'))$ for the space $\hat{M}_0^{(c)}$, namely the fact that the number of Lorentz invariants in $\mathcal{I}_0([k])$ reduces from four to two, while the number of “orbital variables” (z, z') increases correspondingly from $2(d-1)$ to $2d$.

The set $\hat{\Omega}_0$ is the following Cauchy-Riemann manifold

$$\hat{\Omega}_0 = \left\{ [k] \equiv (\mathcal{I}_0([k]), (z, z')); (\zeta, \zeta') \in \Delta_0 \times \Delta_0, (z, z') \in X_d^{(c)} \times X_d^{(c)} \right\},$$

which contains *as maximal real submanifolds* the Minkowskian and Euclidean submanifolds $\hat{M}_0^{(sp)}$ and $\hat{\mathcal{E}}_0$ of $\hat{M}_0^{(c)}$, obtained respectively for the ranges $\{z, z' \in X_d \times X_d\}$ and $\{(z, z') \in \mathbb{S}_d \times \mathbb{S}_d\}$. All the previous considerations concerning the variable $\cos \Theta_t = -z \cdot z'$ remain valid in the case $K = 0$.

With each point $(\zeta, \zeta', 0)$, with $\zeta = (\zeta_1, \zeta_1)$, $\zeta_1 \leq 0$, $\zeta' = (\zeta'_1, \zeta'_1)$, $\zeta'_1 \leq 0$, one now associates the manifold

$$\hat{\Omega}_{(\zeta, \zeta', 0)} = \left\{ [k] \in \hat{M}_0^{(c)}; [k] = [k]_{(\zeta, \zeta', 0)}(z, z'); (z, z') \in X_d^{(c)} \times X_d^{(c)} \right\}$$

The set $\left\{ \hat{\Omega}_{(\zeta, \zeta', 0)}; \zeta = (\zeta_1, \zeta_1), \zeta_1 \leq 0, \zeta' = (\zeta'_1, \zeta'_1), \zeta'_1 \leq 0 \right\}$ defines a foliation of $\hat{\Omega}_0$; in this foliation, each sheet $\hat{\Omega}_{(\zeta, \zeta', 0)}$ is the product of two d -dimensional complex quadrics and can be seen as *an orbit of the group* $G^{(c)} \times G^{(c)}$ via the action: $(k_i, k'_i) \rightarrow (gk_i, g'k'_i), i = 1, 2, (g, g') \in G^{(c)} \times G^{(c)}$.

We can make use of the same base point z_0 as before ($z_0 = (0, \dots, 0, 1, 0)$) and introduce the subspace $M_0^{(c)}$ of $\hat{M}_0^{(c)}$ in which $k'_1 = -k'_2$ is real and along the z_{d-1} -axis. Then for all $(\zeta, \zeta') \in \Delta_0 \times \Delta_0$ the following d -dimensional complex manifolds

$$\Omega_{(\zeta, \zeta', 0)} = \left\{ [k] \in M_0^{(c)}; [k] = [k]_{(\zeta, \zeta', 0)}(z, z_0); z \in X_d^{(c)} \right\},$$

are orbits of the group $G^{(c)}$ via the action $(k_i, k'_i) \rightarrow (gk_i, k'_i), i = 1, 2, g \in G^{(c)}$.

The set $\left\{ \Omega_{(\zeta, \zeta', 0)}; \zeta = (\zeta_1, \zeta_1), \zeta_1 \leq 0; \zeta' = (\zeta'_1, \zeta'_1), \zeta'_1 \leq 0 \right\}$ defines a foliation of the subset Ω_0 of $\hat{\Omega}_0$ in which the vector $k'_1 = -k'_2$ is real and along the z_{d-1} -axis. Ω_0 is a Cauchy-Riemann manifold whose complex structure is parametrized by z ($z \in X_d^{(c)}$), and which contains the real Minkowskian submanifold $M_0^{(sp)}$ and the Euclidean subspace \mathcal{E}_0 of $M_0^{(c)}$ (obtained respectively for $z \in X_d$ and $z \in \mathbb{S}_d$).

Proposition 1 remains true up to obvious changes ($X_{d-1}^{(c)}$ being replaced by $X_d^{(c)}$).

2.3 The spectral sets Σ_s and Σ_u

We define *the s -channel and u -channel spectral sets* Σ_s and Σ_u associated with a given field theory as the following analytic hypersurfaces in complex momentum space $\mathbb{C}_{(k)}^{3(d+1)}$:

$$\Sigma_s = \left\{ [k] \equiv (K, Z, Z') \in \mathbb{C}^{3(d+1)}; s = (Z - Z')^2 = s_0 + \tau; \tau \geq 0 \right\}, \quad (2.19)$$

$$\Sigma_u = \left\{ [k] \equiv (K, Z, Z') \in \mathbb{C}^{3(d+1)}; u = (Z + Z')^2 = u_0 + \tau; \tau \geq 0 \right\}, \quad (2.20)$$

where s_0 and u_0 are positive numbers interpreted as the mass thresholds of the corresponding channels.

Since Σ_s and Σ_u are Lorentz-invariant sets, their projections onto the space of Lorentz invariants ($\mathcal{I}_t([k]; \cos \Theta_t)$) are analytic hypersurfaces $\mathcal{I}(\Sigma_s)$ and $\mathcal{I}(\Sigma_u)$ whose equations result from Eqs. (2.8), (2.9) namely:

$$\mathcal{I}(\Sigma_s) \begin{cases} \cos \Theta_t - 1 = \frac{[s_0 + (\rho - \rho')^2 - (w - w')^2 t] + \tau}{2\rho\rho'}; \\ \text{with } \tau \geq 0. \end{cases} \quad (2.21)$$

$$\mathcal{I}(\Sigma_u) \begin{cases} \cos \Theta_t + 1 = \frac{[-u_0 - (\rho - \rho')^2 + (w + w')^2 t] - \tau}{2\rho\rho'} \\ \text{with } \tau \geq 0. \end{cases} \quad (2.22)$$

Let us now consider the intersections of Σ_s and Σ_u with any orbit $\hat{\Omega}_{(\zeta, \zeta', K)}$ in $\hat{\Omega}_K$; it readily follows from Eqs. (2.21) and (2.22) that these intersections can be parametrized by the variables z, z' in the following way:

$$\begin{aligned} & \Sigma_s \cap \hat{\Omega}_{(\zeta, \zeta', K)} = \\ & \left\{ [k]; [k] = [k]_{(\zeta, \zeta', K)}(z, z'); (z, z') \in X_{d-1}^{(c)} \times X_{d-1}^{(c)}, -z.z' = \cosh v, \quad v \geq v_s \right\} \end{aligned} \quad (2.23)$$

$$\begin{aligned} & \Sigma_u \cap \hat{\Omega}_{(\zeta, \zeta', K)} = \\ & \left\{ [k]; [k] = [k]_{(\zeta, \zeta', K)}(z, z'); (z, z') \in X_{d-1}^{(c)} \times X_{d-1}^{(c)}, z.z' = \cosh v, \quad v \geq v_u \right\} \end{aligned} \quad (2.24)$$

where $v_s = v_s(\zeta, \zeta', t)$ and $v_u = v_u(\zeta, \zeta', t)$ are defined by the equations:

$$\cosh v_s - 1 = \frac{s_0 + (\rho - \rho')^2 - (w - w')^2 t}{2\rho\rho'}, \quad (2.25)$$

$$\cosh v_u - 1 = \frac{u_0 + (\rho - \rho')^2 - (w + w')^2 t}{2\rho\rho'}, \quad (2.26)$$

with ρ, w, ρ', w' expressed by Eqs. (2.4), (2.5), (2.6).

We then see that the images of these sets in the $\cos \Theta_t$ -plane (by the projection \hat{i} introduced in Proposition 1) are the two real half-lines

$$\underline{\sigma}_+(v_s) = [\cosh v_s, +\infty[\quad \text{and} \quad \underline{\sigma}_-(v_u) =] - \infty, -\cosh v_u] \quad (2.27)$$

In the next section, the previous sets will appear as “cuts” bordering analyticity domains, namely the following “cut orbits” (for each (ζ, ζ', K)):

$$\hat{\Omega}_{(\zeta, \zeta', K)}^{(\text{cut})} = \hat{\Omega}_{(\zeta, \zeta', K)} \setminus (\Sigma_s \cup \Sigma_u); \quad (2.28)$$

We also introduce correspondingly in Ω_K the *cut orbits*:

$$\Omega_{(\zeta, \zeta', K)}^{(\text{cut})} = \Omega_{(\zeta, \zeta', K)} \setminus (\Sigma_s \cup \Sigma_u); \quad (2.29)$$

each of them is represented in the parametric variables z by the complex quadric $X_{d-1}^{(c)}$ minus the cuts

$$\Sigma_+^{(c)}(v_s) = \left\{ z \in X_{d-1}^{(c)}; z^{(d-1)} \in [\cosh v_s, +\infty[\right\} \quad (2.30)$$

and

$$\Sigma_-^{(c)}(v_u) = \left\{ z \in X_{d-1}^{(c)}; z^{(d-1)} \in] - \infty, -\cosh v_u] \right\}. \quad (2.31)$$

As an immediate consequence of Proposition 1 one then has:

Lemma 1

The projection of each set $\hat{\Omega}_{(\zeta, \zeta', K)}^{(\text{cut})}$ by \hat{i} and of each set $\Omega_{(\zeta, \zeta', K)}^{(\text{cut})}$ by i onto the $\cos \Theta_t$ -plane is the corresponding cut-plane

$$\mathbb{H}_{(\rho, w, \rho', w', t)} = \mathbb{C} \setminus \{ \underline{\sigma}_+(v_s) \cup \underline{\sigma}_-(v_u) \}. \quad (2.32)$$

entirely specified by formulas (2.25), (2.26) and (2.4)...(2.6).

3 Perikernel structure of four-point functions in complex momentum space

3.1 Four-point functions of local fields: primitive analyticity domain and bounds

We here recall some basic results of the theory of four-point functions in the axiomatic framework of quantum field theory (see e.g. [13] and references therein). In this theory, one deals with the set of “generalized retarded functions” which are built from vacuum expectation values of the form:

$$W^{(i)}(x_1, x_2, x_3, x_4) = \langle \Omega, \phi_{i_1}(x_{i_1}) \phi_{i_2}(x_{i_2}) \phi_{i_3}(x_{i_3}) \phi_{i_4}(x_{i_4}) \Omega \rangle,$$

$(i) = (i_1, i_2, i_3, i_4)$ denoting any permutation of $(1, 2, 3, 4)$; here, the ϕ_j 's ($j = 1, 2, 3, 4$) denote local fields which satisfy mutually the *postulate of local commutativity*: $[\phi_j(x), \phi_\ell(y)] = 0$ if $(x - y)^2 < 0$ ($j, \ell = 1, 2, 3, 4$). In view of the translation invariance of the theory, the so-called “Wightman functions” $W^{(i)}(x_1, x_2, x_3, x_4)$ are defined in the space $\mathbb{R}^{4(d+1)}/\mathbb{R}^{d+1}$ of the vector variables $\xi = (\xi_i = x_i - x_{i+1}, i = 1, 2, 3)$; in the standard formulation of Wightman field theory, they are defined as tempered distributions.

The construction of the generalized retarded functions (g.r.f.) in terms of the Wightman functions requires the use of the algebra generated by multiple commutators of the fields together with step functions of the time-coordinates $\theta(x_i^{(0)} - x_j^{(0)})$ [17,18,19]. The g.r.f. are special elements $r_\alpha(x)$ of this algebra which have minimal support properties in the configuration space $\mathbb{R}^{4(d+1)}$ in the following sense. In ξ -space (i.e. $\mathbb{R}^{4(d+1)}/\mathbb{R}^{d+1}$) the support Γ_α of each g.r.f. $r_\alpha(x) = \underline{r}_\alpha(\xi)$ is a Lorentz-invariant cone whose convex hull $\hat{\Gamma}_\alpha$ is a salient cone with apex at the origin: *each cone Γ_α is determined explicitly as a consequence of the postulate of local commutativity*. It is assumed that the set of g.r.f. \underline{r}_α can be defined ² as tempered distributions on $\mathbb{R}^{4(d+1)}/\mathbb{R}^{d+1}$ satisfying the previously mentioned support properties.

Analyticity and bounds in the tubes \mathcal{T}_α :

Analyticity in complex momentum space is readily obtained by introducing the Fourier-Laplace transforms of the g.r.f. r_α .

²The use of “sharp” time-ordered or retarded products (involving formally the product of distributions with the “sharp” step-function $\theta(x^{(0)})$) necessitates an extra-postulate with respect to the Wightman axioms (see e.g. the axiomatic presentations of [20] and [21]).

Due to translation invariance, the Fourier transforms of the g.r.f. $r_\alpha(x)$ are of the form: $\delta(p_1 + p_2 + p_3 + p_4) \tilde{r}_\alpha(p)$, where each $\tilde{r}_\alpha(p)$ is a tempered distribution on the linear space $M = \{p = (p_1, \dots, p_4); p_1 + p_2 + p_3 + p_4 = 0\}$. Let $M^{(c)}$ be the complexified of M , whose points are denoted by $k = p + iq = (k_1, k_2, k_3, k_4)$, with $k_1 + k_2 + k_3 + k_4 = 0$.

The support properties of the distributions $\underline{r}_\alpha(\xi) = r_\alpha(x)$ imply that one can define the corresponding Fourier-Laplace transforms (still denoted by) $\tilde{r}_\alpha(k)$, formally given by

$$\tilde{r}_\alpha(k) = \frac{1}{(2\pi)^{2(d+1)}} \int e^{i(k.\xi)} \underline{r}_\alpha(\xi) d\xi_1 d\xi_2 d\xi_3,$$

with

$$(k.\xi) = k_1.\xi_1 + (k_1 + k_2).\xi_2 + (k_1 + k_2 + k_3).\xi_3 \equiv \sum_{i=1}^4 k_i x_i,$$

as *holomorphic functions* in the respective domains $\mathcal{T}_\alpha = M + i \mathcal{C}_\alpha$ of $M^{(c)}$, called “the tubes \mathcal{T}_α with bases \mathcal{C}_α ”. For each α , \mathcal{C}_α is the (open)³ dual cone of the support Γ_α of \underline{r}_α (or of the convex hull $\hat{\Gamma}_\alpha$ of the latter), namely:

$$\mathcal{C}_\alpha = \left\{ q \in M; (q.\xi) > 0 \text{ for all } \xi \in \hat{\Gamma}_\alpha \right\}.$$

Moreover, as a consequence of the tempered character of $\underline{r}_\alpha(\xi)$, $\tilde{r}_\alpha(k)$ satisfies a global majorization of the following form in its domain \mathcal{T}_α :

$$|\tilde{r}_\alpha(k)| \leq C \max \left[(1 + \|k\|)^m, [d(q, \partial\mathcal{C}_\alpha)]^{-n} \right] \quad (3.1)$$

where $\| \cdot \|$ denotes a euclidean norm in $M^{(c)}$, $d(q, \partial\mathcal{C}_\alpha)$ denotes the corresponding distance from q to the boundary $\partial\mathcal{C}_\alpha$ of \mathcal{C}_α , and $m \geq 0$, $n \geq 0$. These numbers characterize the “degrees of temperateness” of the theory by taking into account respectively the dominant ultraviolet behaviour and the highest degree of local singularities of the four-point function in momentum space. In view of the role which they will be shown to play in complex angular momentum analysis, it is better to assume that they are general real numbers, i.e. not necessarily integers (as often assumed in standard Q.F.T.).

³ \mathcal{C}_α is open and non-empty, since $\hat{\Gamma}_\alpha$ is a *salient* cone.

Under these assumptions, each Fourier transform $\tilde{r}_\alpha(p)$ is then rigorously characterized as the “distribution-boundary value” of the corresponding holomorphic function $\tilde{r}_\alpha(k)$ from the tube \mathcal{T}_α namely:

$$\lim_{q \rightarrow 0, q \in \mathcal{C}_\alpha} \int \tilde{r}_\alpha(p + iq) \varphi(p) dp = \langle \tilde{r}_\alpha, \varphi \rangle$$

for all test-functions $\varphi(p)$ in the Schwartz space $\mathcal{S}(M)$.

We now recall the definition of the cones \mathcal{C}_α (see [13] and references therein). Let $\alpha = ((\alpha_i; i = 1, 2, 3, 4), (\alpha_{j\ell}; j, \ell = 1, 2, 3, 4, j \neq \ell))$, where the α_i and $\alpha_{j\ell}$ are equal to +1 or -1. The corresponding cone \mathcal{C}_α is defined by the following conditions:

$$\alpha_i q_i \in V^+, \alpha_{j\ell} (q_j + q_\ell) \in V^+; i, j, \ell = 1, 2, 3, 4, j \neq \ell; \quad (3.2)$$

the condition of non-emptiness of \mathcal{C}_α puts obvious constraints on the set α , such as $\alpha_{j\ell} = -\alpha_{mn}$ if $(j, \ell, m, n) = (1, 2, 3, 4)$, $\alpha_{j\ell} = \alpha_j$ if $\alpha_j = \alpha_\ell$, $\alpha_n = -\alpha_j$ if $\alpha_j = \alpha_\ell = \alpha_m$ etc...

Each cone \mathcal{C}_α is represented conveniently by a simplicial triedron in $\mathbb{R}_{(s_1, s_2, s_3)}^3$ whose faces are contained in three of the planes with equations $s_i = 0$, $i = 1, 2, 3$, $s_4 = -(s_1 + s_2 + s_3) = 0$, $s_i + s_j = 0$, $i, j = 1, 2, 3$, or equivalently by a triangular cell determined by these planes on the unit sphere $s_1^2 + s_2^2 + s_3^2 = 1$: we thus obtain the so-called “*Steinmann sphere*” representation of the tubes \mathcal{T}_α of the four-point function in complex momentum space.

The coincidence region \mathcal{R} :

It follows from the spectral conditions of the field theory considered that all the distributions $\tilde{r}_\alpha(p)$ coincide in the following region \mathcal{R} of M :

$$\mathcal{R} = \left\{ p = (p_1, p_2, p_3, p_4) \in M; p_j^2 < M_j^2, 1 \leq j \leq 4, \right. \\ \left. t \equiv (p_1 + p_2)^2 < t_0, s \equiv (p_1 + p_3)^2 < s_0, u \equiv (p_1 + p_4)^2 < u_0 \right\},$$

where the numbers M_j , $1 \leq j \leq 4$ are mass thresholds associated with the corresponding fields, and t_0, s_0, u_0 are the mass thresholds of the corresponding two-field channels.

The region \mathcal{R} is a star-shaped region with respect to the origin in M .

The four-point function $H(k)$:

Since all the holomorphic functions $\tilde{r}_\alpha(k)$ have boundary values on the reals which coincide on the region \mathcal{R} , they admit a common analytic continuation denoted by $H(k)$ whose existence results from the “edge-of-the-wedge theorem” (see [22] and references therein). This function $H(k)$, called *the analytic four-point function in complex momentum space* of the set of fields considered, is holomorphic in the following complex domain D of $M^{(c)}$:

$$D = \left(\bigcup_{\alpha} \mathcal{T}_{\alpha} \right) \cup \mathcal{N}(\mathcal{R}),$$

where $\mathcal{N}(\mathcal{R})$ is a certain complex neighborhood of the region \mathcal{R} (chosen for example as $\mathcal{N}(\mathcal{R}) = \{k = p + iq; p \in \mathcal{R}, \|q\| < \varepsilon_0\}$).

The bounds (3.1) on $H(k)$ in the tubes \mathcal{T}_{α} imply⁴ similar majorizations in $\mathcal{N}(\mathcal{R})$, namely:

$$|H(p + iq)| \leq C' \max \left[(1 + \|p\|)^m, [d(p, \partial\mathcal{R})]^{-n} \right], \quad (3.3)$$

where $d(p, \partial\mathcal{R})$ is the distance from the real point p to the boundary of \mathcal{R} .

D is called the *primitive axiomatic domain* of the four-point function. D is not a “natural” holomorphy domain; this means that it admits a *holomorphy envelope* $\mathcal{H}(D)$ in which all functions which are holomorphic in D can be analytically continued [22].

Some general properties of the holomorphy envelope $\mathcal{H}(D)$:

The problem of the determination of (parts of) the holomorphy envelope $\mathcal{H}(D)$ of D by means of various methods (such as the tube theorem, etc...[22]) is called “the analytic completion problem”. Although the complete knowledge of $\mathcal{H}(D)$ has not been obtained, the following general properties of this domain have been established [13] (the proof of a) and c) requires all the mass thresholds M_j , $1 \leq j \leq 4$, s_0, t_0, u_0 to be strictly positive).

Theorem

a) $\mathcal{H}(D)$ is a domain of $M^{(c)}$ which is star-shaped with respect to the origin,
b) $\mathcal{H}(D)$ is invariant under the diagonal action of the complex Lorentz group $G^{(c)} = SO_0(1, d)^{(c)}$, namely if $k = (k_1, k_2, k_3, k_4) \in \mathcal{H}(D)$, then $gk = (gk_1, gk_2, gk_3, gk_4) \in \mathcal{H}(D)$, for every g in $G^{(c)}$,

⁴This result can be obtained as a direct application of proposition A.3.

c) For any fixed choice of the time-axis, the corresponding Euclidean subspace $\mathcal{E} = \left\{ k = (k_i; 1 \leq i \leq 4) \in M^{(c)}; k_i = p_i + iq_i; p_i = (0, \vec{p}_i), q_i = (q_i^{(0)}, 0) \right\}$, is contained in $\mathcal{H}(D)$.

d) The seven “spectral sets” $\Sigma_s = \{k \in M^{(c)}; s = (k_1 + k_3)^2 \geq s_0\}$, $\Sigma_u = \{k \in M^{(c)}; u = (k_1 + k_4)^2 \geq u_0\}$, $\Sigma_t = \{k \in M^{(c)}; t = (k_1 + k_2)^2 \geq t_0\}$, $\Sigma^{(j)} = \{k \in M^{(c)}; k_j^2 \geq M_j^2\}$, $1 \leq j \leq 4$, do not intersect $\mathcal{H}(D)$.

Absorptive parts:

The axiomatic framework also provides a complete description of the structure and primitive analyticity domains of the *off-shell absorptive parts*, which are the discontinuity functions $\Delta_s H, \Delta_u H, \Delta_t H$ of H in the respective s, u and t -channels. To be specific $\Delta_s H(k)$ is a holomorphic function of k_1 and k_2 which is defined in the “face” $\{k; \text{Im}(k_1 + k_3) = 0\}$ of the complex momentum space “triangulation” described above; its support is the intersection of the face $\text{Im}(k_1 + k_3) = 0$ with the corresponding “spectral set” $\Sigma_s = \{k \in M^{(c)}; s \geq s_0\}$ (also introduced with the notations of Sec.2) in (2.19)). The primitive analyticity domain D_s of $\Delta_s H$ in (k_1, k_2) -space is the union of the four tubes $\{(k_1, k_2); \text{Im} k_1 \in \varepsilon_1 V^+, \text{Im} k_2 \in \varepsilon_2 V^+; \varepsilon_1, \varepsilon_2 = + \text{ or } -\}$ connected together by a complex neighborhood of the region:

$$\mathcal{R}_s = \{k \text{ real}; k \in \Sigma_s; k_j^2 < M_j^2, 1 \leq j \leq 4\}. \quad (3.4)$$

“Sections of maximal analyticity” or “cut-submanifolds”

We shall say that a complex submanifold \mathcal{L} of $M^{(c)}$ provides a *section of maximal analyticity or a cut-submanifold of the domain D (resp. of its holomorphy envelope $\mathcal{H}(D)$) for the s and u -channels* if $\mathcal{L} \cap \mathcal{D}$ (resp. $\mathcal{L} \cap \mathcal{H}(D)$) is equal to $\mathcal{L} \setminus (\Sigma_s \cup \Sigma_u)$. Such sections of $\mathcal{H}(D)$ will be produced below (see §3.3); in these sections, the jumps of $H(k)$ across Σ_s and Σ_u are always equal to the analytic continuations of the corresponding absorptive parts $\Delta_s H, \Delta_u H$. In fact, the existence of the analytic continuation of H in \mathcal{L} implies that the jumps $\Delta_s H, \Delta_u H$ are obtained there as distributions in the real submanifold of \mathcal{L} ; they are defined as differences of boundary values of holomorphic functions from the complex regions of \mathcal{L} , namely from *new* directions of $\text{Im} k$ -space which belong to $\mathcal{H}(D)$, although not to D . If \mathcal{L} is one-dimensional, $\mathcal{L} \setminus (\Sigma_s \cup \Sigma_u)$ is called a “cut-plane section” of $\mathcal{H}(D)$.

Complex Lorentz invariance of $H(k)$:

In the following, we shall restrict ourselves to the case of *scalar local fields*. In this case, the g.r.f. $r_\alpha(x)$ are invariant under the (diagonal) action of the real connected Lorentz group $G = SO_0(1, d)$; this invariance property is then satisfied by the corresponding Fourier–Laplace transforms $\tilde{r}(k)$ and therefore by $H(k)$ in its analyticity domain D (D being itself invariant under this group). By a standard argument (based on the uniqueness of analytic continuation), it follows that $H(k)$ is also invariant under the *complex* connected Lorentz group $G^{(c)}$, i.e. $H(k_i, \dots, k_4) = H(gk_i, \dots, gk_4)$ for all g in $G^{(c)}$, this property being satisfied in the whole holomorphy envelope $\mathcal{H}(D)$.

3.2 A simple step in the analytic completion problem

From now on, we adopt the notations of the t –channel kinematics given in Sec.2, namely we put $k'_1 = -k_3$, $k'_2 = -k_4$ so that $k_1 + k_2 = k'_1 + k'_2 = K$, and we replace the notation $k = (k_1, k_2, k_3, k_4)$ of §3.1 by $[k] = (k_1, k_2, k'_1, k'_2)$; accordingly, the four-point function is now denoted $H([k])$.

The step of the analytic completion problem which we shall perform will yield domains in any subspace $M_K^{(c)}$ such that $K^2 = t \leq 0$, with the coordinatization of Sec.2: $K = \sqrt{-t} e_d$ and (as specified in §2.1), k'_1 and k'_2 are real vectors varying in the (e_{d-1}, e_d) –plane of the completed coordinate system.

This step can be said to be “simple” because all the new points obtained are boundary points of the primitive domain D described in §3.1: in fact, the simple geometrical property which we use is that each subspace $M_K^{(c)}$ is a linear manifold containing a common part of the boundaries of the following two tubes ⁵ $\mathcal{T}_{(1)}^+ = \{[k]; \text{Im } k'_1 \in V^-, \text{Im } k'_2 \in V^-, \text{Im } k_1 \in V^+\}$ and $\mathcal{T}_{(2)}^- = \{[k]; \text{Im } k'_1 \in V^+, \text{Im } k'_2 \in V^+, \text{Im } k_2 \in V^-\}$. This “common face” (carried by the linear manifold $\text{Im } k'_1 = \text{Im } k'_2 = 0$) is the tube

$$\mathcal{T}_K^+ = \{[k] \in M_K^{(c)}; \text{Im } k_1 = -\text{Im } k_2 \in V_K^+\},$$

where V_K^+ denotes the intersection of the hyperplane orthogonal to K (namely the space \mathbb{R}^d spanned by e_0, e_1, \dots, e_{d-1}) with the forward light cone V^+ of \mathbb{R}^{d+1} .

⁵these tubes are the analyticity domains of the Laplace transforms of the ordinary advanced and retarded four-point functions $a_{(2)}$ and $r_{(1)}$

Similarly we introduce the opposite tube

$$\mathcal{T}_K^- = \{[k] \in M_K^{(c)}; \text{Im } k_1 = -\text{Im } k_2 \in V_K^-\},$$

where $V_K^- = -V_K^+$. \mathcal{T}_K^- is the common face (in $M_K^{(c)}$) of the tubes $\mathcal{T}_{(1)}^- = -\mathcal{T}_{(1)}^+$ and $\mathcal{T}_{(2)}^+ = -\mathcal{T}_{(2)}^-$ of the primitive domain D .

The following statement is then contained in Theorem 4 of [23], but for simplicity and self-consistency of the present paper, we prefer to give here a direct ⁶ proof of this result (with the help of Appendix A).

Proposition 2:

a) $\mathcal{H}(D)$ contains the set of all points $[k]$ in $\mathcal{T}_K^+ \cup \mathcal{T}_K^-$; moreover, at all the points in \mathcal{T}_K^+ (resp. \mathcal{T}_K^-), $H([k])$ admits a common analytic continuation from both tubes $\mathcal{T}_{(1)}^+$ and $\mathcal{T}_{(2)}^-$ (resp. $\mathcal{T}_{(1)}^-$ and $\mathcal{T}_{(2)}^+$) of the primitive domain D .

b) The two sets \mathcal{T}_K^+ and \mathcal{T}_K^- are connected in $\mathcal{H}(D)$ by $\mathcal{N}(\mathcal{R}) \cap M_K^{(c)}$.

Proof:

Let $[\hat{k}] = (\hat{k}_1, \hat{k}_2, \hat{k}'_1, \hat{k}'_2)$ be any real momentum configuration in $M_K^{(c)}$ contained in the (e_1, e_2, \dots, e_d) -hyperplane of coordinates; $[\hat{k}]$ belongs to the region \mathcal{R} , since all quantities \hat{k}_i^2 , $\hat{k}'_i{}^2$, $(\hat{k}_i - \hat{k}'_j)^2$, $i, j = 1, 2$ and $(\hat{k}_1 + \hat{k}_2)^2 = t$ are ≤ 0 . We shall now exhibit a two-dimensional (complex) section of the tubes $\mathcal{T}_{(1)}^+$ and $\mathcal{T}_{(1)}^-$ of the domain D by putting

$$k_1 = \hat{k}_1 + \eta e, \quad k'_1 = \hat{k}'_1 - \eta' e, \quad k_2 = \hat{k}'_2 - \eta' e, \quad (3.5)$$

with e fixed in V_K^+ .

This two-dimensional section is represented by the union of the tubes $\mathcal{T}_+, \mathcal{T}_-$ of (η, η') space described in Proposition A-1. Now, it is clear that there exists a square of the form $|\eta| < a, |\eta'| < a$ in \mathbb{R}^2 whose image by the mapping (3.5) belongs to the region \mathcal{R} (since the point $\eta = \eta' = 0$ represents the configuration $[\hat{k}]$ which belongs to \mathcal{R}).

Corollary A-2 then implies that all the points $[k] = (k_1 = \eta e + \hat{k}_1, \hat{k}'_1, \hat{k}'_2)$ such that either $\text{Im } \eta > 0$ or $\text{Im } \eta < 0$ or $\eta \in]-a, +a[$ lie in $\mathcal{H}(D)$; since this holds for every choice of e in V_K^+ and \hat{k}_1 in the (e_1, e_2, \dots, e_d) -hyperplane, it is

⁶the proof given in [23] makes use of a theorem by Bremermann and relies on a condition of coincidence for adjacent tubes which, for simplicity, we have omitted in §3.1.

thus proved that all points in \mathcal{T}_K^+ (resp. \mathcal{T}_K^-) appear as points of analyticity for $H([k])$ obtained from the tube $\mathcal{T}_{(1)}^+$ (resp. $\mathcal{T}_{(1)}^-$).

A similar argument based on a two-dimensional section of $\mathcal{T}_{(2)}^- \cup \mathcal{T}_{(2)}^+$ would exhibit all the points in \mathcal{T}_K^+ (resp. \mathcal{T}_K^-) as points of analyticity obtained from the tube $\mathcal{T}_{(2)}^-$ (resp. $\mathcal{T}_{(2)}^+$).

The fact that the analytic continuations of $H([k])$ obtained by these two procedures coincide results from the principle of uniqueness of analytic continuation, since both of them coincide in the intersection of \mathcal{T}_K^\pm with the edge-of-the-wedge neighborhood $\mathcal{N}(\mathcal{R})$ (contained in D).

Point a) of Proposition 2 is thus proved and point b) is then trivial.

We shall now restate the result of Proposition 2 in terms of the variables introduced in Sec.2. A parametrization of $M_K^{(c)}$ is given by Eqs (2-2) in which $\rho z = \underline{k} = (\underline{k}^{(0)}, \dots, \underline{k}^{(d-1)}, 0)$ varies in \mathbb{C}^d , $z' = z_0 = (0, \dots, 0, 1, 0)$ and w, ρ', w' are real ($\rho' \geq 0$), namely

$$\begin{aligned} [k] &= [k](\underline{k}; w, \rho', w', K) \equiv \\ k_1 &= \underline{k} + (w + \frac{1}{2})K, \quad k_2 = -\underline{k} - (w - \frac{1}{2})K, \\ k'_1 &= \rho' z_0 + (w' + \frac{1}{2})K, \quad k'_2 = -\rho' z_0 - (w' - \frac{1}{2})K, \end{aligned} \quad (3.6)$$

Proposition 3:

Let $\underline{D}_{(w, w', \rho')}$ be the following domain in the space \mathbb{C}^d of the complex vector \underline{k} : $\underline{D}_{(w, w', \rho')} = \underline{\mathcal{I}}^+ \cup \underline{\mathcal{I}}^- \cup \underline{\mathcal{N}}(\mathcal{R}_{(w, w', \rho')})$, where:

a) $\underline{\mathcal{I}}^\pm = \mathbb{R}^d + i\underline{V}^\pm$, with

$$\underline{V}^+ = -\underline{V}^- = \{\underline{q} \in \mathbb{R}^d; \underline{q}^{(0)} > [\underline{q}^{(1)^2} + \dots + \underline{q}^{(d-1)^2}]^{\frac{1}{2}}\}$$

b) $\underline{\mathcal{N}}(\mathcal{R}_{(w, w', \rho')})$ is a suitable complex neighborhood of the following region $\underline{\mathcal{R}}_{(w, w', \rho')} = \{\underline{k} \in \mathbb{R}^d; \underline{k}^2 < \mu^2, (\underline{k} - \rho' z_0)^2 < \mu_s^2, (\underline{k} + \rho' z_0)^2 < \mu_u^2\}$; in the latter, the constants, μ^2, μ_s^2, μ_u^2 are defined in terms of the mass thresholds M_1^2, M_2^2, s_0, u_0 by the following expressions

$$\begin{aligned} \mu^2 &= \min \left(M_1^2 - t \left(w + \frac{1}{2} \right)^2, M_2^2 - t \left(w - \frac{1}{2} \right)^2 \right), \\ \mu_s^2 &= s_0 - t \left(w - w' \right)^2, \quad \mu_u^2 = u_0 - t \left(w + w' \right)^2. \end{aligned}$$

Then $\mathcal{H}(D)$ contains the union of the following sets:

$$\hat{D}_{(w,w',\rho')} = \left\{ [k] \in M_K^{(c)}; [k] = [k](\underline{k}; w, \rho', w', K); \underline{k} \in \underline{D}_{(w,w',\rho')} \right\}, \text{ for all real values of } w, w' \text{ and } \rho' (\rho' \geq 0).$$

Proof:

This statement is a direct consequence of Proposition 2 since (in view of the parametrization (3.6)) $\underline{\mathcal{R}}_{(w,w',\rho')}$ is the trace of \mathcal{R} in complex \underline{k} -space, for fixed values of w, w', ρ' .

We shall now prove that bounds of the type (3-1) are satisfied by the analytic continuation of the four-point function $H([k])$ in the regions described in Proposition 3 ; this is a simple example of the extension to points of $\mathcal{H}(D)$ of bounds which are prescribed in the primitive domain D .

Proposition 4:

Bounds of the following form are satisfied by $H([k](\underline{k}; w, \rho', w', K))$ for \underline{k} varying in the domains $\underline{D}_{(w,w',\rho')}$ of Proposition 3.

$$|H([k](\underline{k}; w, \rho', w', K))| \leq C_{w,\rho',w'} \max \left[(1 + \|\underline{k}\|)^m, d(\underline{k}, \partial \underline{D}_{(w,w',\rho')})^{-n} \right] \quad (3.7)$$

where

$$\|\underline{k}\|^2 = \sum_{0 \leq i \leq d-1} \left| \underline{k}^{(i)} \right|^2$$

and m, n are the same numbers as in formula (3.1) ($m \geq 0, n \geq 0$).

Proof:

For w, w', ρ' fixed, we consider the section of the primitive domain D by the following complex submanifold parametrized by \underline{k} and η , $\underline{k} \in \mathbb{C}^d$, $\eta \in \mathbb{C}$:

$$[k] = [k](\underline{k}, \eta) \left| \begin{array}{l} k_1 = \underline{k} + (w + \frac{1}{2})K + \eta e_0 \\ k_2 = -\underline{k} - (w - \frac{1}{2})K + \eta e_0 \end{array} \right| \left| \begin{array}{l} k'_1 = \underline{\rho}' z_0 + (w' + \frac{1}{2})K + \eta e_0 \\ k'_2 = -\underline{\rho}' z_0 - (w' - \frac{1}{2})K + \eta e_0 \end{array} \right. \quad (3.8)$$

Let us first consider the case when \underline{k} varies in the tube $\underline{\mathcal{I}}^+$. One then checks that if η varies in a strip $0 < \text{Im } \eta < h(\underline{k})$ such that $\text{Im } \underline{k} - h(\underline{k}) e_0 \in \partial V_+$, the corresponding point $[k] = [k](\underline{k}, \eta)$ defined by (3.8) varies in the tube $\mathcal{T}_{(2)}^- = \{[k]; \text{Im } k'_1 \in V^+, \text{Im } k'_2 \in V^+, \text{Im } k_2 \in V^-\}$ of the domain D . Similarly,

for η varying in the strip $-h(\underline{k}) < \text{Im } \eta < 0$, the corresponding point $[k] = [k](\underline{k}, \eta)$ varies in the tube $\mathcal{T}_{(1)}^+ = \{[k]; \text{Im } k'_1 \in V^-, \text{Im } k'_2 \in V^-, \text{Im } k_1 \in V^+\}$.

Moreover, when η varies in a real interval $[-a, +a]$ such that k'_1, k'_2 and $t = (k'_1 + k'_2)^2$ remain negative, the boundary values of $H([k])$ from the two previous tubes (i.e. from the sides $\text{Im } \eta > 0$, and $\text{Im } \eta < 0$) define a common analytic continuation of the corresponding two branches of $H([k](\underline{k}, \eta))$ across the interval $[-a, +a]$: this follows from the application of Proposition 2 to all situations such that $k'_1 + k'_2 = K + 2\eta e_0$ (which is legitimate for $\eta \in [-a, +a]$).

We shall now consider the majorizations (3.1) of $H([k])$ in the tubes $\mathcal{T}_{(2)}^-$ and $\mathcal{T}_{(1)}^+$ and give their expressions in terms of the complex variables \underline{k} and η when $[k]$ belongs to the submanifold (3.8).

For \underline{k} in \mathcal{I}^+ , the following majorizations follow from (3.1), if η varies in the set $\{\eta \in \mathbb{C}; |\text{Re } \eta| < a, 0 < |\text{Im } \eta| < h(\underline{k})\}$:

$$|H([k](\underline{k}, \eta))| \leq \underline{C} \max [(1 + \|\underline{k}\|)^m, |\text{Im } \eta|^{-n}, (h(\underline{k}) - |\text{Im } \eta|)^{-n}] \quad (3.9)$$

where \underline{C} is a suitable constant.

In order to obtain a bound for $H([k](\underline{k}, \eta))$ at $\eta = 0$, i.e. at the corresponding point $[k] = [k](\underline{k}; w, \rho', w', K)$ (see (3.6)) of the set $\hat{D}_{(w, w', \rho')}$, it is appropriate to apply Proposition A-3 to the function $f(\eta) = H([k](\underline{k}, \eta))$ in a square Δ_b such that $b = \min\left(\frac{h(\underline{k})}{\sqrt{2}}, (1 + \|\underline{k}\|)^{-\frac{m}{n}}, a\right)$. In fact, one checks that in this domain Δ_b the majorization (A-1) is implied by (3.9) (with $M = \underline{C}(\sqrt{2} - 1)^{-n}$). We can therefore apply the majorization (A-2) which yields (for the chosen value of b):

$$|H([k](\underline{k}, 0))| \leq c_n \underline{C} \max \left[(1 + \|\underline{k}\|)^m, \left(\frac{h(\underline{k})}{\sqrt{2}}\right)^{-n}, a^{-n} \right]. \quad (3.10)$$

Since $d(\underline{k}, \partial\mathcal{I}^+) = \frac{h(\underline{k})}{\sqrt{2}}$ and the constant a is independent of \underline{k} , the inequality (3.10) can be replaced by

$$|H([k](\underline{k}, 0))| \leq \underline{C}' \max \left[(1 + \|\underline{k}\|)^m, (d(\underline{k}, \partial\mathcal{I}^+))^{-n} \right], \quad (3.11)$$

(\underline{C}' being a new constant).

The previous argument holds similarly, when \underline{k} varies in the tube $\underline{\mathcal{I}}^-$ (the tubes $\mathcal{T}_{(1)}^+$ and $\mathcal{T}_{(2)}^-$ being now replaced by their opposites) and yields:

$$|H([k](\underline{k}, 0))| \leq \underline{C}' \max \left[(1 + \|\underline{k}\|)^m, (d(\underline{k}, \partial \underline{\mathcal{I}}^-))^{-n} \right] \quad (3.11')$$

Finally, when \underline{k} belongs to $\underline{\mathcal{N}}(\underline{\mathcal{R}}_{(w, w', \rho')})$, the majorization (3.3) yields immediately ⁷ (by restriction to the submanifold (3.8)):

$$|H([k](\underline{p} + i\underline{q}, 0))| \leq \underline{C}'' \max \left[(1 + \|\underline{p}\|)^m, (d(\underline{p}, \partial \underline{\mathcal{R}}_{(w, w', \rho')}))^{-n} \right] \quad (3.12)$$

The set of majorizations (3.11), (3.11'), (3.12) is equivalent to the global majorization (3.7) in the domain $\underline{D}_{(w, w', \rho')}$.

3.3 The perikernel structure in the space $\hat{M}_K^{(c)}$

In this subsection, we shall establish the analyticity properties and bounds of the four-point function $H([k])$ which are necessary for introducing (in the next section) an appropriate Laplace-type transform of H in a complex angular-momentum variable associated with the t -channel. These analyticity properties and bounds are direct applications of the results of Propositions 3 and 4, which will be completed in a second step by making use of the property of complex Lorentz invariance of $H([k])$.

We first consider the following family of one-dimensional complex submanifolds $\omega_{(\zeta, \zeta', K)}$ in $M_K^{(c)}$. With each (ζ, ζ', K) such that $t < 0, \zeta \in \Delta_t \setminus \partial \Delta_t, \zeta' \in \Delta_t$ (see Eq. (2.13)), we associate the complex hyperbola

$$\omega_{(\zeta, \zeta', K)} = \left\{ [k]; [k] = [k]_{(\zeta, \zeta', K)}(z, z_0); z = (-i \sin \theta, 0, \dots, 0, \cos \theta), \theta \in \mathbb{C} \right\} \quad (3.13)$$

where $[k] = [k]_{(\zeta, \zeta', K)}(z, z')$ is the mapping defined by Eqs (2.16).

Each hyperbola $\omega_{(\zeta, \zeta', K)}$ appears to be the *meridian hyperbola in the* (e_o, e_{d-1}) -*plane* of the corresponding hyperboloid $\Omega_{(\zeta, \zeta', K)}$ (see Eq. (2.17)).

We shall then prove:

⁷The majorization (3.12) can also be obtained directly from (3.11), (3.11') and the analyticity of H in $\mathcal{R}_{(w, w', \rho')}$ by applying again Proposition A.3.

Proposition 5:

a) For each (ζ, ζ', K) with $\zeta \in \Delta_t \setminus \partial\Delta_t$, $\zeta' \in \Delta_t$, the submanifold $\omega_{(\zeta, \zeta', K)}$ provides a section of maximal analyticity of $\mathcal{H}(D)$ which is the cut-domain $\omega_{(\zeta, \zeta', K)}^{(\text{cut})} = \omega_{(\zeta, \zeta', K)} \setminus (\Sigma_s \cup \Sigma_u)$; Σ_s, Σ_u are the spectral sets defined by Eqs (2.19) (2.20).

b) The domain $\omega_{(\zeta, \zeta', K)}^{(\text{cut})}$ is represented in the 2π -periodic θ -plane as the following cut-plane:

$$\Pi_{(\rho, w, \rho', w', t)} = \mathbb{C} \setminus \{\sigma_+(v_s) \cup \sigma_-(v_u)\}, \quad (3.15)$$

where:

$$\sigma_+(v_s) = \{\theta \in \mathbb{C}; \theta = iv + 2\ell\pi, |v| \geq v_s, \ell \in \mathbb{Z}\}, \quad (3.16)$$

$$\sigma_-(v_u) = \{\theta \in \mathbb{C}; \theta = iv + (2\ell + 1)\pi, |v| \geq v_u, \ell \in \mathbb{Z}\}. \quad (3.17)$$

(with v_s, v_u defined by Eqs (2.25), (2.26)).

c) The restriction of the function $H([k])$ to each submanifold $\omega_{(\zeta, \zeta', K)}$ is well defined as a 2π -periodic function:

$$H_{\omega_{(\zeta, \zeta', K)}}(\theta) = H([k]_{(\zeta, \zeta', K)}(z, z_0)) \Big|_{z=(-i \sin \theta, 0, \dots, 0, \cos \theta)}, \quad (3.18)$$

which is holomorphic in the domain $\Pi_{(\rho, w, \rho', w', t)}$ and satisfies bounds of the following form:

$$\left| H_{\omega_{(\zeta, \zeta', K)}}(\theta) \right| \leq C_{(\zeta, \zeta', K)} e^{m_* |\text{Im} \theta|} [d(\theta, \sigma_+(v_s) \cup \sigma_-(v_u))]^{-n}. \quad (3.19)$$

in the latter $m_* = \max(m, n)$ and $C_{(\zeta, \zeta', K)}$ is a suitable constant.

Proof:

a) we shall prove that for every (ζ, ζ', K) with $\zeta \in \Delta_t \setminus \partial\Delta_t$, $\zeta' \in \Delta_t$, the cut-domain $\omega_{(\zeta, \zeta', K)}^{(\text{cut})}$ is contained in the corresponding subset $\hat{D}_{(w, w', \rho)}$ of $\mathcal{H}(D)$ obtained in Proposition 3. In fact, each point $[k]$ in $\omega_{(\zeta, \zeta', K)}$ is such that $[k] = [k](\underline{k}; w, \rho', w', K)$ (see Eqs (3.6)), with $\underline{k} = \rho z, z = (-i \sin \theta, 0, \dots, 0, \cos \theta)$.

By putting $\theta = u + iv$, we check that:

$$(\text{Im} \underline{k})^2 = \rho^2 (\text{Im} z)^2 = \rho^2 \sin^2 u \geq 0 \quad (3.20)$$

Since we have assumed that $\zeta \notin \partial\Delta_t$, i.e. $\rho \neq 0$, we see from (3.20) that all the complex points $[k]$ of $\omega_{(\zeta, \zeta', K)}$ are represented by vectors \underline{k} such that $(\text{Im } \underline{k})^2 > 0$, which means that \underline{k} belongs either to $\underline{\mathcal{I}}^+$ or to $\underline{\mathcal{I}}^-$ and therefore to the domain $\underline{D}_{(w, w', \rho')}$ of Proposition 3.

Moreover, the real points of $\omega_{(\zeta, \zeta', K)}$ are represented by real vectors \underline{k} , such that $\underline{k}^2 = \rho^2 z^2 = -\rho^2 < 0$; therefore, they belong to $\underline{D}_{(w, w', \rho')}$, i.e. to the region $\underline{\mathcal{R}}_{(w, w', \rho')}$, if and only if they do not belong to the union of the spectral sets Σ_s and Σ_u . This proves that the domain $\omega_{(\zeta, \zeta', K)}^{(\text{cut})} = \omega_{(\zeta, \zeta', K)} \setminus (\Sigma_s \cup \Sigma_u)$ is contained in $\mathcal{H}(D)$. Since all points in $\Sigma_s \cup \Sigma_u$ are outside $\mathcal{H}(D)$ (see d) of Theorem in §3.1), $\omega_{(\zeta, \zeta', K)}^{(\text{cut})}$ is actually the intersection of $\mathcal{H}(D)$ with $\omega_{(\zeta, \zeta', K)}$.

b) In view of (3.20), all the complex points of $\omega_{(\zeta, \zeta', K)}^{(\text{cut})}$ are represented in the θ -plane by the set $\{\theta = u + iv; u \neq \ell\pi, \ell \in \mathbb{Z}\}$; the real points form two disjoint sets, represented respectively by $\{\theta = iv + 2\ell\pi; |v| < v_s, \ell \in \mathbb{Z}\}$ and $\{\theta = iv + (2\ell + 1)\pi; |v| < v_u, \ell \in \mathbb{Z}\}$. This shows that $\omega_{(\zeta, \zeta', K)}^{(\text{cut})}$ is represented by the periodic cut-plane $\Pi_{(\rho, w, \rho', w', t)}$.

c) We shall apply the majorizations of proposition 4 to the present situation, in which $\underline{k} = \rho z$, $z = (-i \sin \theta, 0, \dots, 0, \cos \theta)$, $\theta = u + iv$. Since

$$\text{Re } \underline{k} = (\rho \cos u \sinh v, 0, \dots, 0, \rho \cos u \cosh v)$$

$$\text{Im } \underline{k} = (-\rho \sin u \cosh v, 0, \dots, 0, -\rho \sin u \sinh v)$$

we get:

$$\|\underline{k}\|^2 = \|\text{Re } \underline{k}\|^2 + \|\text{Im } \underline{k}\|^2 = \rho^2 (2 \cosh^2 v - 1) \quad (3.21)$$

On the other hand, for $\underline{k} \in \underline{\mathcal{I}}^\pm$, we have:

$$d(\underline{k}, \partial\underline{\mathcal{I}}^\pm) = \inf \left(\left| \text{Im} \left(\underline{k}^{(0)} + \underline{k}^{(d-1)} \right) \right|, \left| \text{Im} \left(\underline{k}^{(0)} - \underline{k}^{(d-1)} \right) \right| \right) = \rho |\sin u| e^{-|v|}. \quad (3.22)$$

In this situation, which corresponds to $\sin u \neq 0$, the majorizations (3.11), (3.11') therefore yield (in view of Eqs (3.21), (3.22)):

$$\left| H_{\omega_{(\zeta, \zeta', K)}}(u + iv) \right| \leq C \max \left[\left(1 + \rho\sqrt{2} \cosh v \right)^m, \frac{e^{n|v|}}{\rho^n |\sin u|^n} \right], \quad (3.23)$$

which implies a bound of the form (3.19) when θ varies in $\Pi_{(\rho, w, \rho', w', t)}$ by staying outside neighborhoods of the intervals $\{\theta = iv + 2\ell\pi; |v| < v_s, \ell \in \mathbb{Z}\}$ and $\{\theta = iv + (2\ell + 1)\pi, |v| < v_u; \ell \in \mathbb{Z}\}$. When θ varies in these neighborhoods, one makes use of the majorization (3.12) (since in this case $\underline{k} \in \underline{\mathcal{N}}(\underline{\mathcal{R}}_{(w, w', \rho')})$), which completes the proof of the bound (3.19).

Remark: In the limiting case where $\rho = 0$, i.e. $\zeta \in \partial\Delta_t$, the set $\omega_{(\zeta, \zeta', K)}$ reduces to a single point $[k]$, which belongs to $\underline{\mathcal{R}}$, and therefore to $\mathcal{H}(D)$, but the statement of proposition 5 has a trivial content; we notice that (according to the expressions (2.25), (2.26) of v_s, v_u) the cuts $\sigma_+(v_s)$, $\sigma_-(v_u)$ of $\Pi_{(\rho, w, \rho', w')}$ are shifted up to infinity when ρ tends to zero.

We shall now extend the previous analyticity properties of $H([k])$ to the manifolds $\Omega_{(\zeta, \zeta', K)}$ and $\hat{\Omega}_{(\zeta, \zeta', K)}$ (see Eqs (2.17), (2.15)) by exploiting the Lorentz invariance of H . We shall first use the invariance of $H([k])$ under the subgroup of complex Lorentz transformations which leave the vectors k'_1, k'_2 unchanged. When $K \neq 0$, this is the subgroup $\underline{G}^{(c)} = SO_0^{(c)}(1, d-2)$ which leaves the (e_{d-1}, e_d) -plane of coordinates unchanged. In this case, $H([k])$ is then holomorphic and constant at all points $[k] = [k](g\underline{k}; w, \rho', w')$ deduced from the points $[k](\underline{k}; w, \rho', w')$ in $\omega_{(\zeta, \zeta', K)}^{(\text{cut})}$ by the action of any element g in $\underline{G}^{(c)}$. For $K = 0$, the analysis is similar, except that the group $\underline{G}^{(c)}$ is now the subgroup $SO_0^{(c)}(1, d-1)$ which leaves the point z_0 (i.e. e_{d-1}) unchanged.

In particular, for each point $[\hat{k}]$ in $\omega_{(\zeta, \zeta', K)}$, represented by a vector $\hat{k} = \rho\hat{z}$ with $\hat{z} = (-i \sin \theta, 0, \dots, 0, \cos \theta)$, the corresponding point $[\check{k}] = [k](\check{k}; w, \rho', w')$, obtained by the symmetry $\theta \rightarrow -\theta$ (namely such that $\check{k} = \rho\check{z}$, with $\check{z} = (i \sin \theta, 0, \dots, 0, \cos \theta)$) belongs to the orbit $\{[k] = [k](g\hat{k}; w; \rho', w')\}$ of $\underline{G}^{(c)}$ (in fact, one can find an element $g_{\hat{k} \rightarrow \check{k}}$ of $\underline{G}^{(c)}$ such that: $\check{k} = g_{\hat{k} \rightarrow \check{k}}(\hat{k})$). It follows that $H([\hat{k}]) = H([\check{k}])$; correspondingly $H_{\omega_{(\zeta, \zeta', K)}}(\theta)$ is an *even* function of θ and therefore a holomorphic function of $\cos \theta$ which we denote by $\underline{H}_{(\zeta, \zeta', K)}(\cos \theta)$. The domain of the latter, which is the image of $\Pi_{(\rho, w, \rho', w', t)}$ onto the $\cos \theta$ -plane, is the cut-plane $\underline{\Pi}_{(\rho, w, \rho', w', t)}$ introduced in (2.32).

In view of Lemma 1 one can now define $H([k])$ in each cut-domain $\Omega_{(\zeta, \zeta', K)}^{(\text{cut})}$ of $\Omega_{(\zeta, \zeta', K)}$ (see Eqs (2.17), (2.29)) as the $\underline{G}^{(c)}$ -invariant function

$$H([k]) = \underline{H}_{(\zeta, \zeta', K)}(\cos \Theta_t), \quad (3.24)$$

where $[k] \equiv ((\zeta, \zeta', K), (z, z_0))$ and $\cos \Theta_t = -z.z_0 = z^{(d-1)}$; Θ_t is the off-shell scattering angle introduced in (2.3) (with here $z' = z_0$) and $\cos \Theta_t$ therefore coincides with the variable $\cos \theta$ of the parametrization (3.13) when z belongs to the meridian hyperbola $\omega_{(\zeta, \zeta', K)}$ of $\Omega_{(\zeta, \zeta', K)}$. We can thus state

Proposition 6

For every submanifold $\Omega_{(\zeta, \zeta', K)}$ in Ω_K (with $\zeta \in \Delta_t \setminus \partial\Delta_t$, $\zeta' \in \Delta_t$), the corresponding “cut-submanifold” $\Omega_{(\zeta, \zeta', K)}^{(\text{cut})}$ belongs to $\mathcal{H}(D)$. In each of these submanifolds, the restriction of the function $H([k])$ is invariant under the group $\underline{G}^{(c)}$ and can be identified with a holomorphic function $\underline{H}_{(\zeta, \zeta', K)}(\cos \theta)$ whose domain is the cut-plane $\underline{\Pi}_{(\rho, w, \rho', w', t)}$. Moreover, the jumps of $H([k])$ across the two cuts Σ_s and Σ_u in $\Omega_{(\zeta, \zeta', K)}$ (or equivalently the jumps of $\underline{H}_{(\zeta, \zeta', K)}(\cos \theta)$ across the cuts $\underline{\sigma}_+(v_s)$ and $\underline{\sigma}_-(v_u)$) are the corresponding restrictions of the absorptive parts $\Delta_s H$ and $\Delta_u H$ of H .

(For a complete justification of the last statement in Proposition 6, we refer the reader to the paragraph “Absorptive parts” in §3.1.)

One similarly extends $H([k])$ to the cut-domains $\hat{\Omega}_{(\zeta, \zeta', K)}^{(\text{cut})}$ of the submanifolds $\hat{\Omega}_{(\zeta, \zeta', K)}$ (see Eqs (2.15), (2.16), (2.28)) by now using formula (3.24) with $[k] \equiv ((\zeta, \zeta', K), (z, z'))$ and $\cos \Theta_t = -z.z'$. By also taking into account the bounds (3.19) on $H_{\omega_{(\zeta, \zeta', K)}}(\Theta_t) = \underline{H}_{(\zeta, \zeta', K)}(\cos \Theta_t)$, one can then state:

Theorem 1 For every submanifold $\hat{\Omega}_{(\zeta, \zeta', K)}$ in $\hat{\Omega}_K$ (with $\zeta, \zeta' \notin \partial\Delta_t$), the corresponding “cut-submanifold” $\hat{\Omega}_{(\zeta, \zeta', K)}^{(\text{cut})}$ belongs to $\mathcal{H}(D)$. The restriction of $H([k])$ to each of these submanifolds defines an “invariant perikernel of moderate growth with distribution boundary values” on the corresponding complexified hyperboloid $X_{d-1}^{(c)}$ (if $K \neq 0$) or $X_d^{(c)}$ (if $K = 0$).

This invariant perikernel $H([k]_{(\zeta, \zeta', K)}(z, z'))$ is holomorphic on the domain of $X_{d-1}^{(c)} \times X_{d-1}^{(c)}$ (resp. $X_d^{(c)} \times X_d^{(c)}$) which is defined as the complement of the union of the cuts $\{(z, z'); z.z' \leq -\cosh v_s\}$ and $\{(z, z'); z.z' \geq \cosh v_u\}$. It can be identified with the holomorphic function $\underline{H}_{(\zeta, \zeta', K)}(-z.z')$ of the single variable $\cos \Theta_t = -z.z'$, Θ_t being the off-shell scattering angle of the t -channel. The domain of this function is the cut-plane $\underline{\Pi}_{(\rho, w, \rho', w', t)}$ and its growth is controlled by the following bounds in terms of $u = \text{Re } \Theta_t$ and $v = \text{Im } \Theta_t$:

$$\left| \underline{H}_{(\zeta, \zeta', K)}(\cos(u + iv)) \right| \leq \underline{C}_{(\zeta, \zeta', K)} e^{m_* |v|} |\sin u|^{-n} \quad (3.25)$$

if $\cos \Theta_t \notin \mathbb{R}$, and:

$$|\underline{H}_{(\zeta, \zeta', K)}(\cos \Theta_t)| \leq \underline{C}_{(\zeta, \zeta', K)} |\cos \Theta_t - \cosh v_s|^{-n} |\cos \Theta_t + \cosh v_u|^{-n}, \quad (3.26)$$

if $\cos \Theta_t$ belongs to a neighborhood of the real interval $]-\cosh v_u, \cosh v_s[$. In these bounds, $m^* = \max(m, n)$, m and n being the “degrees of temperateness” of the theory (introduced in (3.1)).

The notion of “invariant perikernel of moderate growth on a complexified hyperboloid” has been introduced in [24,25] as an appropriate notion for studying the Laplace transformation associated with the complexified Lorentz group. While the term “perikernel” refers to the analyticity property of $H([k]_{(\zeta, \zeta', K)}(z, z'))$ in the cut-domain described above, its “invariant” character means that it satisfies the condition $H([k]_{(\zeta, \zeta', K)}(gz, gz')) = H([k]_{(\zeta, \zeta', K)}(z, z'))$ for all g in $G_K^{(c)}$. Finally the property of “moderate growth”, characterized by the bounds (3.25), (3.26), fits with the definition given in [25] as far as the behaviour at infinity is concerned. However, the present perikernels have distribution-like (instead of continuous) boundary values on the reals.

Remark. The condition ζ (and ζ') $\notin \partial\Delta_t$ in Proposition 6 and Theorem 1 simply expresses the non-degeneracy of the corresponding submanifolds $\Omega_{(\zeta, \zeta', K)}$ and $\hat{\Omega}_{(\zeta, \zeta', K)}$. In the degenerate cases these sets are trivially contained in $\mathcal{H}(D)$ (see our previous remark after Proposition 5).

4 Harmonic analysis of the four-point functions of scalar fields

Having established in Theorem 1 the perikernel structure of a four-point function $H([k])$ relatively to a given t -channel we are now in a position to apply the results of [25] which concern the harmonic analysis of invariant perikernels of moderate growth on the complexified (unit) hyperboloid $X_{d-1}^{(c)}$. We shall give a self-contained account of these results in §4-1 for the case $d = 2$ and in §4-2 for the general case $d > 2$. As a matter of fact, we need to present an extended version of the results of [25] which includes:

- a) the presence of two cuts (instead of one, as in [25]) in the definition of the analyticity domain of the perikernels (the corresponding results have already been announced and their derivation outlined in [10])
- b) the occurrence of perikernels with distribution-like boundary values on the reals (as previously noticed).

Concerning the rigorous treatment of b), our arguments will make use of results proved in Appendix B.

In §4-3, we come back to our analysis of the four-point function $H([k])$ of scalar local fields, also written in terms of the t -channel variables as follows:

$$H([k]) = F(\zeta, \zeta'; t, \cos \Theta_t). \quad (4.1)$$

The restrictions of H to the manifolds $\hat{\Omega}_{(\zeta, \zeta', K)}$ of the ‘‘Lorentz-foliation’’ of $\hat{\Omega}_K$ defined in Eqs (2.15), (2-16) can then be identified with the perikernels of Theorem 1 (in their reduced form \underline{H}), namely:

for all (ζ, ζ', t) with (ζ, ζ') in $\Delta_t \times \Delta_t$,

$$F(\zeta, \zeta'; t, \cos \Theta_t) = \underline{H}_{(\zeta, \zeta', K)}(\cos \Theta_t) \quad (4.1')$$

Applying the results of §4.1 and §4.2 will then directly lead us to introduce and describe the properties of a Fourier–Laplace-type integral transform $\tilde{F}(\zeta, \zeta'; t, \lambda_t)$ of $F(\zeta, \zeta'; t, \cos \Theta_t)$ which interpolates analytically in an appropriate way the set of (off-shell) t -channel partial-waves:

$$f_\ell(\zeta, \zeta', t) = \omega_{d-1} \int_{-1}^{+1} P_\ell^{(d)}(\cos \Theta_t) F(\zeta, \zeta'; t, \cos \Theta_t) [\sin \Theta_t]^{d-3} d \cos \Theta_t \quad (4.2)$$

in a half-plane of the complex variable λ_t . In Eq.(4.2), the functions $P_\ell^{(d)}$ are the “ultraspherical Legendre polynomials” considered in [26]⁸ (chapter 1 §2), which reduce to $\cos \ell \Theta_t$ for $d = 2$ and to the Legendre polynomials P_ℓ for $d = 3$; they are given (for $d \geq 3$) by the following integral representation (see Eq.(III.18) of [25c]):

$$P_\ell^{(d)}(\cos t) = \frac{\omega_{d-2}}{\omega_{d-1}} \int_0^\pi (\cos t + i \sin t \cos \phi)^\ell (\sin \phi)^{d-3} d\phi. \quad (4.3)$$

In (4.2) and (4.3), ω_{d-1} denotes the area of the sphere S_{d-2} .

In §4.4, it is shown that the previous property of analytic interpolation of the f_ℓ in the variable λ_t is indeed equivalent to the property of analytic continuation of the Euclidean four-point function into the Lorentz-foliation of $\hat{\Omega}_K$: more precisely, this structure is characterized by *kernels of the Euclidean sphere-foliation of $\hat{\mathcal{E}}_K$ which are analytically continued into perikernels*.

4.1 Fourier-Laplace transformation on cut-domains of the complexified hyperbola $X_1^{(c)}$

On the complex hyperbola $X_1^{(c)} = (z^{(0)} = -i \sin \theta, z^{(1)} = \cos \theta, \theta = u + iv)$, one considers the domain $D = X_1^{(c)} \setminus (\Sigma_+^{(c)} \cup \Sigma_-^{(c)})$ (Fig.2), whose representation in the θ -plane is the periodic cut-plane $\Pi = \mathbb{C} \setminus (\sigma_+ \cup \sigma_-)$. The cuts σ_+, σ_- are of the form (3.16), (3.17) (with $v_s = v_+, v_u = v_-$) and the corresponding subsets $\Sigma_+^{(c)}, \Sigma_-^{(c)}$ of $X_1^{(c)}$ are given (as in (2.30) and (2.31)) by:

$$\Sigma_\pm^{(c)} = \left\{ z = (z^{(0)}, z^{(1)}) \in X_1^{(c)}; \pm z^{(1)} \in [\cosh v_\pm, +\infty[\right\} \quad (4.4)$$

Note that the circle $\mathbb{S}_1 = \{z = (iy_0, x_1); y_0^2 + x_1^2 = 1; y_0, x_1 \text{ real}\}$ of $X_1^{(c)}$, represented by the periodic u -axis in Π , is contained in the domain D .

An invariant perikernel $\mathcal{K}(z, z')$ on $X_1^{(c)}$ is identified with a function $\mathcal{F}(z) = \mathcal{K}(z, z_0)$ (where $z_0 = (0, 1)$) holomorphic in the domain D of $X_1^{(c)}$ and depending only on the variable $z^{(1)} = \cos \theta$. Representing \mathcal{F} by the *even*

⁸These polynomials are proportional to the Gegenbauer polynomials C_ℓ^p considered in chapter IX of [27] (see in the latter Eq.(6) of §4.7, which coincides with (4.3) for $p = \frac{d-2}{2}$ up to the normalization constant).

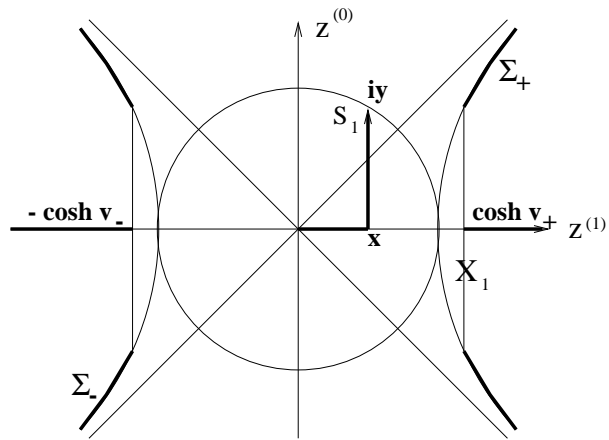

Figure 2

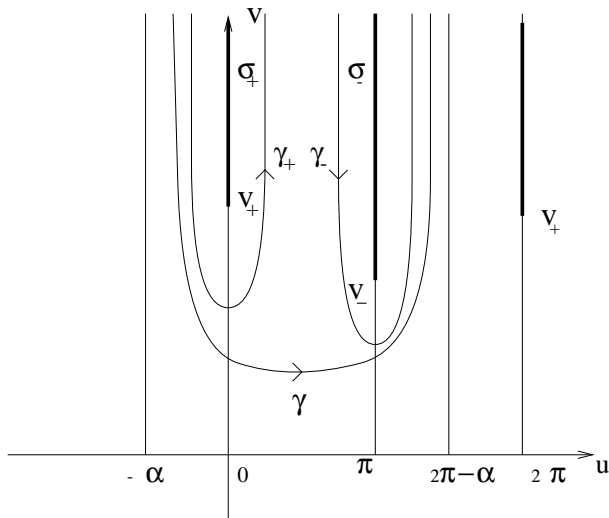

Figure 3

periodic function $f(\theta) = \mathcal{F}(z(\theta))$, holomorphic in the cut-plane Π , one then defines [25a)] the following Fourier–Laplace-type transform $\tilde{F} = \mathcal{L}(f)$:

$$\tilde{F}(\lambda) = \int_{\gamma} e^{i\lambda\theta} f(\theta) d\theta \quad (4.5)$$

with the prescription of Fig.3 for the contour γ . (γ “encloses” the components of σ_+, σ_- inside the half-strip: $v > 0, -\alpha < u < 2\pi - \alpha$, with $0 < \alpha < \pi$).

In view of the choice of γ , this transform is well-defined and holomorphic in a half-plane of the form $\mathbb{C}_+^{(m)} = \{\lambda \in \mathbb{C}; \operatorname{Re} \lambda > m\}$ provided \mathcal{F} is a perikernel of moderate growth satisfying the following bound in D :

$$|\mathcal{F}(z)| \leq \text{cst} (1 + |z^{(1)}|)^m, \quad (4.6)$$

or equivalently provided f satisfies the following one in Π :

$$|f(u + iv)| \leq \text{cst} e^{m|v|}, \quad (4.7)$$

Let us first assume that f admits continuous boundary values (from both sides) on the cuts σ_+ and σ_- and call $\Delta f_+(v), \Delta f_-(v)$ the corresponding jumps of if , which it is sufficient to consider in the upper half-plane ($v \geq 0$) :

$$\Delta f_+(v) = i \lim_{\varepsilon \rightarrow 0} (f(\varepsilon + iv) - f(-\varepsilon + iv)), \quad (4.8)$$

$$\Delta f_-(v) = i \lim_{\varepsilon \rightarrow 0} (f(\pi + \varepsilon + iv) - f(\pi - \varepsilon + iv)) \quad (4.9)$$

Assuming that the bound (4.7) is uniform in Π and therefore applies to the discontinuity functions $\Delta f_+, \Delta f_-$ of if , the Laplace transforms of $\Delta f_+, \Delta f_-$

$$\tilde{F}_{\pm}(\lambda) = \int_0^{\infty} e^{-\lambda v} \Delta f_{\pm}(v) dv \quad (4.10)$$

are holomorphic in $\mathbb{C}_+^{(m)}$. Then applying a simple contour-distortion argument to the integral (4.5) yields the following relations, valid in $\mathbb{C}_+^{(m)}$:

i)

$$\tilde{F}(\lambda) = \tilde{F}_+(\lambda) + e^{i\pi\lambda} \tilde{F}_-(\lambda).$$

This follows from replacing the contour γ by a pair of contours (γ_+, γ_-) enclosing respectively the cuts σ_+, σ_- and then from flattening them (in a folded way) onto the cuts (see Fig.3).

ii)

$$\tilde{F}(\ell) = f_\ell, \text{ for all integers } \ell \text{ such that } \ell > m,$$

$$\text{where } f_\ell = \int_{-\alpha}^{2\pi-\alpha} e^{i\ell u} f(u) du.$$

This follows from choosing $\gamma = \gamma_\alpha$ with support $]-\alpha + i\infty, -\alpha] \cup [-\alpha, 2\pi - \alpha] \cup [2\pi - \alpha, 2\pi - \alpha + i\infty[$, and taking into account the 2π -periodicity of the integrand of (4.5) for $\lambda = \ell$ integer.

We note that the Fourier coefficients f_ℓ of $f(u)$ are associated with the (rotational invariant) kernel $\mathbf{K}(z, z')$ on the “imaginary circle” \mathbb{S}_1 of $X_1^{(c)}$ which is obtained by taking the restriction of the perikernel $\mathcal{K}(z, z')$, namely $\mathbf{K} = \mathcal{K}|_{\mathbb{S}_1 \times \mathbb{S}_1}$ and $f(u) = \mathbf{K}(z, z')$ with $\cos u = -z.z' = y_0 y'_0 + x_1 x'_1$.

We now state in a more detailed form an extension of the previous properties which applies to the case when f (resp. F or \mathcal{K}) admits *distribution-like boundary values (and discontinuities)* on the cuts which border its domain.

Theorem 2 *Let $f(\theta)$ be a (2π -periodic) even holomorphic function in the cut-plane Π (representing an invariant perikernel of moderate growth $\mathcal{K}(z, z')$ on $X_1^{(c)}$) satisfying uniform bounds of the following form (with m and β fixed, $m \in \mathbb{R}$, $\beta \geq 0$):*

$$|f(u + iv)| \leq C \eta^{-\beta} e^{mv}, \quad (4.11)$$

in all the corresponding subsets Π_η^+ ($\eta > 0$) of $\Pi^+ = \Pi \cap \{\theta \in \mathbb{C}; \text{Im } \theta > 0\}$:

$$\begin{aligned} \Pi_\eta^+ = & \Pi^+ \setminus \{\theta \in \mathbb{C}; \theta = u + iv, |u - 2n\pi| < \eta, n \in \mathbb{Z}, v > v_+ - \eta\} \\ & \setminus \{\theta \in \mathbb{C}; \theta = u + iv, |u - (2n - 1)\pi| < \eta, n \in \mathbb{Z}, v > v_- - \eta\} \end{aligned} \quad (4.12)$$

Then,

i) The “discontinuity functions” $\Delta f_+, \Delta f_-$ of f across the cuts σ_+, σ_- are well-defined in the sense of distributions, and admit Laplace-transforms $\tilde{F}_+(\lambda), \tilde{F}_-(\lambda)$ which are holomorphic in $\mathbb{C}_+^{(m)}$ and satisfy uniform bounds of the following form (for all $\varepsilon, \varepsilon' > 0$):

$$\left| \tilde{F}_\pm(\lambda) \right| \leq C_\pm^{(\varepsilon, \varepsilon')} |\lambda - m|^{\beta + \varepsilon'} e^{-[\text{Re } \lambda - (m + \varepsilon)]v_\pm} \quad (4.13)$$

in the corresponding half-planes $\mathbb{C}_+^{(m+\varepsilon)}$.

ii) The transform $\tilde{F} = \mathcal{L}(f)$ of f , namely $\tilde{F}(\lambda) = \int_{\gamma} e^{i\lambda\theta} f(\theta) d\theta$, is holomorphic in $\mathbb{C}_+^{(m)}$ and satisfies the following properties:

a)

$$\tilde{F}(\lambda) = \tilde{F}_+(\lambda) + e^{i\pi\lambda} \tilde{F}_-(\lambda) \quad (4.14)$$

b) for all integers ℓ such that $\ell > m$, the Fourier coefficients of $f|_{\mathbb{R}}$, namely

$$f_{\ell} = \int_{-\alpha}^{2\pi-\alpha} e^{i\ell u} f(u) du, \quad (4.15)$$

are given by the following relations:

$$f_{\ell} = \tilde{F}(\ell) \quad (4.16)$$

Proof: i) The validity of the bounds (4.11) on the function f (which characterize it as a “function of moderate growth” near its boundary set $\sigma_+ \cup \sigma_-$) is equivalent (see e.g. [28]) to the fact that f admits *boundary values in the sense of distributions* on $i\mathbb{R}$ and $\pi + i\mathbb{R}$ (from both sides of each of these lines) and therefore that the discontinuities $\Delta f_+, \Delta f_-$ are defined as distributions with respective supports σ_+, σ_- . We refer the reader to Proposition B.4, for a comprehensive study of holomorphic functions of this type, considered as *derivatives (of integral or non-integral order) of holomorphic functions with continuous boundary values*.

In view of the exponential factor in (4.11), the Laplace transforms $\tilde{F}_+(\lambda), \tilde{F}_-(\lambda)$ of $\Delta f_+, \Delta f_-$ can always be defined as holomorphic functions in $\mathbb{C}_+^{(m)}$ by the following contour integrals:

$$\tilde{F}_+(\lambda) = \int_{\gamma_+} e^{i\lambda\theta} f(\theta) d\theta, \quad (4.17)$$

$$\tilde{F}_-(\lambda) = e^{-i\pi\lambda} \int_{\gamma_-} e^{i\lambda\theta} f(\theta) d\theta = \int_{\gamma_+} e^{i\lambda\theta} f(\theta + \pi) d\theta \quad (4.18)$$

(γ_+, γ_- being chosen as in Fig.3 with $\text{supp}\gamma_- = \{\theta = \pi + \theta', \theta' \in \text{supp}\gamma_+\}$).

When γ_{\pm} is flattened onto σ_{\pm} , the limit of the r.h.s. of (4.17) (resp. (4.18)) can now be seen as the action of the distribution $\Delta f_+(v)$ (resp $\Delta f_-(v)$) on the test-function $e^{-\lambda v}$ (the latter being admissible for $\text{Re } \lambda > m$).

The derivation of the bounds (4.13) on $\tilde{F}_{\pm}(\lambda)$, which relies on a technique of Abel transforms (or primitives of non-integral order) is given in Proposition B.4. The latter must be applied to the functions $f_{m+}(\theta) = e^{im\theta} f(\theta)$ and $f_{m-}(\theta) = e^{im(\theta+\pi)} f(\theta+\pi)$, which (in view of (4.11) and (4.12)) belong to the class $\mathcal{O}^{\beta}(B_a^{(\text{cut})})$ of an appropriate domain $B_a^{(\text{cut})}$ (e.g. $a = \frac{\pi}{2}$) as described in Appendix B (see Fig.B1). The majorization (B.19) then applies to the Laplace transforms $\tilde{F}_{m\pm}$ of $f_{m\pm}$, which are such that $\tilde{F}_{\pm}(\lambda) = \tilde{F}_{m\pm}(\lambda - m)$, thus yielding the desired result (4.13).

ii) The proof of the relations (4.14) and (4.16) relies on the contour-distortion argument presented above in the case where $f(\theta)$ has continuous boundary values.

Remark: In view of Eq (4.14), the relations (4.16) yield:

$$\text{for } \ell \text{ even, } f_{\ell} = \tilde{F}_+(\ell) + \tilde{F}_-(\ell) \quad (4.19)$$

$$\text{for } \ell \text{ odd, } f_{\ell} = \tilde{F}_+(\ell) - \tilde{F}_-(\ell) \quad (4.20)$$

Since the holomorphic functions $\tilde{F}_{\pm}(\lambda)$ satisfy the bounds (4.13), which are in particular dominated by any exponential function $e^{\varepsilon|\lambda|}$ ($\varepsilon > 0$) in $\mathbb{C}_+^{(m)}$, these functions appear respectively as the (unique) Carlsonian interpolations [29] of the corresponding sequences $\{\tilde{F}_{\pm}(\ell); \ell \in \mathbb{N}, \ell > m\}$. However the function $\tilde{F}(\lambda)$ itself (which behaves like $e^{-\pi \text{Im } \lambda}$ in $\mathbb{C}_+^{(m)}$) does not satisfy the Carlsonian property with respect to the sequence $\{f_{\ell}\}$ which it interpolates.

This remark suggests the introduction of the following “symmetrized and antisymmetrized quantities”:

$$(\Delta f^{(s)})(v) = (\Delta f_+)(v) + (\Delta f_-)(v) , \quad (\Delta f^{(a)})(v) = (\Delta f_+)(v) - (\Delta f_-)(v) , \quad (4.21)$$

whose respective Laplace transforms are:

$$\tilde{F}^{(s)}(\lambda) = \tilde{F}_+(\lambda) + \tilde{F}_-(\lambda) , \quad \tilde{F}^{(a)}(\lambda) = \tilde{F}_+(\lambda) - \tilde{F}_-(\lambda) ; \quad (4.22)$$

We can then give the following alternative version of Theorem 2 ii):

Proposition 7: The transform \tilde{F} of f has the following structure:

$$\tilde{F} = e^{i\pi\frac{\lambda}{2}} \left[\cos \frac{\pi\lambda}{2} \tilde{F}^{(s)} - i \sin \frac{\pi\lambda}{2} \tilde{F}^{(a)} \right],$$

$\tilde{F}^{(s)}$ and $\tilde{F}^{(a)}$ being Carlsonian interpolations in the half-plane $\mathbb{C}_+^{(m)}$ of the respective sets of even and odd Fourier coefficients of $f|_{\mathbb{R}}$; namely, one has:

$$\text{for } 2\ell > m, \quad f_{2\ell} = \tilde{F}^{(s)}(2\ell) \quad (4.23)$$

$$\text{for } 2\ell + 1 > m, \quad f_{2\ell+1} = \tilde{F}^{(a)}(2\ell + 1) \quad (4.24)$$

$\tilde{F}_\lambda^{(s)}$ and $\tilde{F}_\lambda^{(a)}$ satisfying bounds of the form (4.13) in $\mathbb{C}_+^{(m)}$.

Inversion formulas:

a) The discontinuities $(\Delta f)_\pm(v)$ (considered as distributions with support in $\{v \geq 0\}$) can be recovered from the corresponding functions $\tilde{F}_\pm(\lambda)$ by the following inverse Fourier formulas (equivalent in view of the Cauchy formula applied to $\tilde{F}_\pm(\lambda)e^{-\lambda v}$ in $\mathbb{C}_+^{(m)}$):

$$\text{(for } v > 0) \quad (\Delta f)_\pm(v) = \frac{1}{\pi} \int_{-\infty}^{+\infty} \tilde{F}_\pm(m + i\nu) \cos[(\nu - im)v] d\nu; \quad (4.25)$$

$$\text{or } (\Delta f)_\pm(v) = \frac{1}{\pi} \int_{-\infty}^{+\infty} \tilde{F}_\pm(m + i\nu) \sin[(\nu - im)v] d\nu; \quad (4.25')$$

(note that under the assumptions of Theorem 2, Eq.(4.25) has to be understood in the sense of tempered distributions)

On the other hand, there exists a well-defined integral representation of the holomorphic function $f(\theta)$ in its domain Π in terms of the Laplace transforms $\tilde{F}_+(\lambda)$, $\tilde{F}_-(\lambda)$ namely (assuming that m is positive)

$$f(\theta) = -\frac{1}{2\pi} \int_{-\infty}^{+\infty} \frac{\tilde{F}_+(m + i\nu) \cos[(m + i\nu)(\theta \pm \pi)]}{\sin \pi(m + i\nu)} d\nu \quad (4.26)$$

$$-\frac{1}{2\pi} \int_{-\infty}^{+\infty} \frac{\tilde{F}_-(m+i\nu) \cos[(m+i\nu)\theta]}{\sin \pi(m+i\nu)} d\nu + \frac{1}{2\pi} \sum_{|\ell|<m} f_\ell \cos \ell\theta$$

In fact, the first term at the r.h.s. of (4.26) can be seen to define a pair of holomorphic functions in the respective strips $0 < u < 2\pi$ and $-2\pi < u < 0$ (corresponding to the choice of the sign $-$ or $+$ in the cosine factor), while the second term defines a holomorphic function in the strip $-\pi < u < \pi$: this follows from the bounds (4.13) on $\tilde{F}_\pm(\lambda)$.

The proof of (4.26) consists in showing that for $\theta = u$ real, it reduces to the Fourier series of $f|_{\mathbb{R}}$, namely:

$$f(u) = \frac{1}{2\pi} \sum_{\ell \in \mathbb{Z}} f_\ell \cos \ell\theta \quad (4.27)$$

As a matter of fact, by using a standard contour distortion argument and re-summation of residues at integral points inside $\mathbb{C}_+^{(m)}$ (known as the Sommerfeld-Watson resummation method [30,31]), one shows that the first two terms at the r.h.s. of Eq.(4.26) are respectively equal to the sums of the series $\frac{1}{\pi} \sum_{\substack{\ell \in \mathbb{N} \\ \ell > m}} \tilde{F}_+(\ell) \cos \ell\theta$ and $\frac{1}{\pi} \sum_{\substack{\ell \in \mathbb{N} \\ \ell > m}} (-1)^\ell \tilde{F}_-(\ell) \cos \ell\theta$, which therefore (in view of Eqs. (4.19), (4.20)) reconstitute the r.h.s. of (4.27).

Remarks:

i) Eq.(4.25') for the discontinuities can also be recovered from (4.26) (taken in the limits $\text{Re } \theta \rightarrow 0$ or π), at first in a formal way, and more rigorously by using the techniques of primitives, presented in Appendix B.

ii) If Eq.(4.26) is used for m integer, its r.h.s. must be understood as the action of the distribution $\lim_{\varepsilon \rightarrow 0, \varepsilon > 0} \frac{1}{\sin \pi(m-\varepsilon+i\nu)}$ on the numerator of the integrand.

4.2 Fourier-Laplace transformation on cut-domains of the complexified hyperboloid $X_{d-1}^{(c)}$, $d > 2$

We present a geometrical treatment of the d -dimensional case ($d > 2$) which is very close in its spirit to the one given above for the case $d = 2$. This treatment (see [25b),c]) provides the connection, via analytic continuation,

between Fourier analysis on the sphere $\mathbb{S}_{d-1} \approx SO(d)/SO(d-1)$ and an appropriate realization of Fourier-Laplace analysis on the unit one-sheeted hyperboloid $X_{d-1} \approx SO_{\circ}(1, d-1)/SO_{\circ}(1, d-2)$.

Analytic continuation takes place on the complexified unit hyperboloid $X_{d-1}^{(c)} = \left\{ z = (z^{(0)}, \dots, z^{(d-1)}) \in \mathbb{C}^d; z^2 \equiv z^{(0)^2} - z^{(1)^2} - \dots - z^{(d-1)^2} = -1 \right\}$, which contains S_{d-1} and X_{d-1} as submanifolds of real type, namely $S_{d-1} = X_{d-1}^{(c)} \cap (i\mathbb{R} \times \mathbb{R}^{d-1})$ and $X_{d-1} = X_{d-1}^{(c)} \cap \mathbb{R}^d$. One then considers classes of functions which enjoy analyticity, power boundedness and invariance properties in the “cut-domain” $D = X_{d-1}^{(c)} \setminus \left(\Sigma_+^{(c)} \cup \Sigma_-^{(c)} \right)$, where $\Sigma_+^{(c)}, \Sigma_-^{(c)}$ are given (as in Eqs (2.30), (2.31)) by:

$$\Sigma_{\pm}^{(c)} = \left\{ z = (z^{(0)}, z^{(1)}, \dots, z^{(d-1)}) \in X_{d-1}^{(c)}; \pm z^{(d-1)} \in [\cosh v_{\pm}, +\infty[\right\} \quad (4.28)$$

More specifically, the functions $\mathcal{F}(z)$ considered are supposed to be invariant under the stabilizer G_{z_0} (isomorphic to $SO_0^{(c)}(1, d-2)$) of the base point $z_0 = (0, \dots, 0, 1)$ and therefore only depend on $z^{(d-1)} = \cos \theta$, so that one can again put $\mathcal{F}(z) = f(\theta)$, with f even, 2π -periodic and holomorphic in the cut-plane $\Pi = \mathbb{C} \setminus (\sigma_+ \cup \sigma_-)$ (Fig.3). The analyticity domain D of these functions \mathcal{F} is the preimage of Π in $X_{d-1}^{(c)}$ (through the mapping $z \rightarrow z^{(d-1)} = \cos \theta \rightarrow \pm \theta$). In particular, the sphere $\mathbb{S}_{d-1}(z^{(0)} = iy^{(0)}, z^{(j)} = x^{(j)}$ real for all $j \neq 0, y^{(0)^2} + x^{(1)^2} + \dots + x^{(d-1)^2} = 1)$ is embedded in D , and projects onto the interval $[-1, +1]$ in the $z^{(d-1)}$ -plane. The cuts σ_+ and σ_- are the images of subsets Σ_+ and Σ_- of X_{d-1} , defined respectively by the conditions $z^{(0)} > 0, z^{(d-1)} \geq \cosh v_+$ and $z^{(0)} < 0, z^{(d-1)} \leq -\cosh v_-$; (see Fig.4). The jumps $\Delta f_+, \Delta f_-$ of f across σ_+, σ_- can now be considered as functions (or distributions) on X_{d-1} (depending only on the coordinate $z^{(d-1)} = \cosh v$ or $-\cosh v$) with supports contained respectively in Σ_+, Σ_- .

Each function $\mathcal{F}(z) = f(\theta)$ also represents an *invariant perikernel* $\mathcal{K}(z, z')$ (such that $\mathcal{K}(gz, gz') = \mathcal{K}(z, z')$ for all g in $SO_0^{(c)}(1, d-1)$, and $\mathcal{K}(z, z_0) = \mathcal{F}(z)$) which is holomorphic in $X_{d-1}^{(c)} \times X_{d-1}^{(c)}$ minus the union of the cuts $\hat{\Sigma}_+^{(c)} = \{(z, z'); z \cdot z' \leq -\cosh v_+\}$ and $\hat{\Sigma}_-^{(c)} = \{(z, z'); z \cdot z' \geq \cosh v_-\}$ (these notations being similar to those used in Theorem 1). The restriction of \mathcal{K} to the sphere \mathbb{S}_{d-1} , namely $\mathbf{K} = \mathcal{K}|_{\mathbb{S}_{d-1} \times \mathbb{S}_{d-1}}$ is an analytic invariant kernel on \mathbb{S}_{d-1} , represented by $\mathcal{F}|_{\mathbb{S}_{d-1}} = f|_{\mathbb{R}} = \mathbf{f}$.

While the Fourier analysis of $\mathcal{K}(z, z')$ on the sphere \mathbb{S}_{d-1} is given [26,27] by the following set of coefficients of the generalized Legendre expansion of

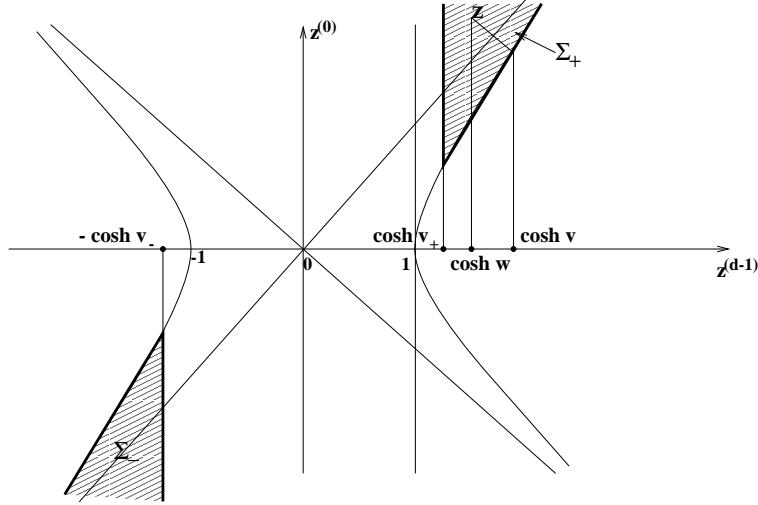

Figure 4

\mathbf{K} involving the polynomials $P_\ell^{(d)}$ (see Eq.(4.3)):

$$f_\ell = \omega_{d-1} \int_0^\pi P_\ell^{(d)}(\cos \theta) \mathbf{f}(\theta) (\sin \theta)^{d-2} d\theta, \quad \ell \geq 0, \quad (4.29)$$

the introduction of Laplace transforms associated with \mathcal{K} along the same line as in the case $d = 2$ (see §4-1) necessitates a special geometrical study. Before presenting the latter, we note that the discontinuities $(\Delta f)_+(v)$, $(\Delta f)_-(v)$ of if represent correspondingly the discontinuities $(\Delta \mathcal{F})_+(z)$, $(\Delta \mathcal{F})_-(z)$ of $i\mathcal{F}(z)$ on the cuts $\Sigma_+^{(c)}$, $\Sigma_-^{(c)}$, which we can consider (after restriction to the real hyperboloid X_{d-1}) as functions (or distributions) with support contained respectively in the regions Σ_+ , Σ_- : these functions (depending only on $z_{d-1} = \cosh v$) also represent *Volterra kernels* $K_+(z, z')$, $K_-(z, z')$ (such that $K_\pm(z, z_0) = \Delta \mathcal{F}_\pm(z)$) on the hyperboloid X_{d-1} , namely kernels with causal support properties on $X_{d-1} \times X_{d-1}$ which are stable by the composition product [24,32] (this structure will be exploited in [14]).

Laplace transformation on X_{d-1} for functions of moderate growth with support Σ_\pm .

Two systems of local coordinates on X_{d-1} , are equally valid in a neighbourhood of the set $\Sigma_+ = \{z \in X_{d-1}; z^{(d-1)} \geq \cosh v_+, z^{(0)} > 0\}$, namely:

a) The polar coordinates:

$$z^{(0)} = \sinh w \cosh \varphi, \quad z^{(d-1)} = \cosh w,$$

$$[\vec{z}] = (z^{(1)}, \dots, z^{(d-2)}) = \sinh w \sinh \varphi [\vec{\alpha}], \quad [\vec{\alpha}] \in S_{d-3} \quad (4.30)$$

b) The horocyclic coordinates:

$$z^{(0)} = \sinh v + \frac{1}{2} \|\vec{x}\|^2 e^v, \quad z^{(d-1)} = \cosh v - \frac{1}{2} \|\vec{x}\|^2 e^v, \\ [\vec{z}] = \vec{x} e^v, \quad \vec{x} \in \mathbb{R}^{d-2} \quad (4.31)$$

The sections $v = \text{cst}$ are paraboloids in the hyperplanes $z^{(0)} + z^{(d-1)} = e^v$, called horocycles.

For classes of functions $F_+(z)$ with support in Σ_+ which are invariant under the stabilizer of z_0 , namely $F_+(z) \equiv F_+[z^{(d-1)}] = f_+(w)$ (supp. $f_+ \subset [v_+, +\infty[$), and which moreover satisfy a bound of the form:

$$|F_+(z)| \leq \text{cst} |z^{(d-1)}|^m \text{ or } |f_+(w)| \leq \text{cst} e^{m|w|}, \quad (4.32)$$

the Laplace transform $\tilde{F}_+(\lambda)$ of F_+ is defined as follows:

$$\tilde{F}_+(\lambda) = \int_{\Sigma_+} e^{-\lambda v} F_+[\cosh w] d\vec{x} dv \quad (4.33)$$

In the latter we have used ‘‘mixed coordinates’’ $v, w, [\vec{x}]$ (see Fig.4); from (4.30), (4.31) one gets:

$$\vec{x} = e^{-v/2} [2(\cosh v - \cosh w)]^{1/2} [\vec{\alpha}], \text{ with } [\vec{\alpha}] \in S_{d-3},$$

which allows one to rewrite Eq.(4.33) as follows (ω_{d-2} being the area of \mathbb{S}_{d-3}):

$$\tilde{F}_+(\lambda) = \omega_{d-2} \int_{v_+}^{\infty} e^{-\lambda v} e^{-(\frac{d-2}{2})v} \mathcal{A}_d f_+(v) dv, \quad (4.34)$$

with

$$\mathcal{A}_d f_+(v) = \int_{v_+}^v f_+(w) [2(\cosh v - \cosh w)]^{\frac{d-4}{2}} \sinh w dw \quad (4.35)$$

It has been proved in [25] that *under the moderate growth condition (4.32) the Laplace transform $\tilde{F}_+(\lambda)$ of $F_+(z)$ is holomorphic in $\mathbb{C}_+^{(m)}$* . This follows from the fact that *provided $m > -1$ the exponential bound (4.32) on F_+ is preserved by the transformation $f_+(w) \rightarrow e^{-\frac{d-2}{2}v} [\mathcal{A}_d f_+](v)$ (see Proposition II-2 of [25b]) for a precise formulation of this statement*.

On the other hand, by introducing the second-kind function $Q_\lambda^{(d)}$ via the integral representation (valid for $w \neq 0$ and $\text{Re } \lambda > -1$)⁹

$$Q_\lambda^{(d)}(\cosh w) = \omega_{d-1}^{-1} \frac{\omega_{d-2}}{(\sinh w)^{d-3}} \int_w^\infty e^{-(\lambda + \frac{d-2}{2})v} [2(\cosh v - \cosh w)]^{\frac{d-4}{2}} dv, \quad (4.36)$$

we obtain (by inverting the integrations in (4.34)) the following alternative expression of $\tilde{F}_+(\lambda)$ in its domain $\mathbb{C}_+^{(m)}$

$$\tilde{F}_+(\lambda) = \omega_{d-1} \int_{v_+}^\infty f_+(w) Q_\lambda^{(d)}(\cosh w) (\sinh w)^{d-2} dw. \quad (4.37)$$

(Note that the previous restriction $m > -1$ can be seen to be produced by the pole of the function $\lambda \rightarrow Q_\lambda^{(d)}(\cosh w)$ at $\lambda = -1$.)

By now replacing w by $w + i\pi$ and v by $v + i\pi$ in (4.30), (4.31), we obtain similar systems of local coordinates which are valid in a neighbourhood of the set $\Sigma_- = \{z \in X_{d-1}; z^{(d-1)} \leq -\cosh v_-, z^{(0)} < 0\}$. Then one can consider similarly the invariant function $F_-(z) \equiv F_- [z^{(d-1)}] = f_-(w)$ with support contained in Σ_- (supp. $f_- \subset [v_-, +\infty[$) and satisfying the growth condition (4.32). This function F_- admits the following Laplace transform which is also holomorphic in $\mathbb{C}_+^{(m)}$:

$$\tilde{F}_-(\lambda) = \int_{\Sigma_-} e^{-\lambda v} F_- [-\cosh w] d\vec{x} dv = \omega_{d-2} \int_{v_-}^\infty e^{-\lambda v} e^{-(\frac{d-2}{2})v} \mathcal{A}_d f_-(v) dv, \quad (4.38)$$

with

$$\mathcal{A}_d f_-(v) = \int_{v_-}^v f_-(w) [2(\cosh v - \cosh w)]^{\frac{d-4}{2}} \sinh w dw, \quad (4.39)$$

⁹We use here a normalization for these functions which is appropriate to our joint consideration of $P_\lambda^{(d)}$ and $Q_\lambda^{(d)}$; for $d = 3$, the discrepancy with the standard normalization of the second-kind Legendre function [36a)] is a factor $\frac{1}{\pi}$.

or equivalently in view of Eq.(4.36):

$$\tilde{F}_-(\lambda) = \omega_{d-1} \int_{v_-}^{\infty} f_-(w) Q_\lambda^{(d)}(\cosh w) (\sinh w)^{d-2} dw \quad (4.40)$$

Laplace transformation on $X_{d-1}^{(c)}$ for holomorphic functions in D with continuous boundary values

With every G_{z_0} -invariant holomorphic function $\mathcal{F}(z) = f(\theta)$ defined in the cut-domain D of $X_{d-1}^{(c)}$ and satisfying moderate growth condition of the form $|\mathcal{F}(z)| \leq \text{cst } |z_{d-1}|^m$ (or $|f(u+iv)| \leq \text{cst } e^{m|v|}$), we shall now associate a Fourier–Laplace-type transform $\tilde{F}(\lambda)$, holomorphic in the half-plane $\mathbb{C}_+^{(m)}$, by a formula similar to (4.34) and (4.38), except that a complex integration contour is used, namely

$$\tilde{F}(\lambda) = \omega_{d-2} \int_{\gamma} e^{i(\lambda + \frac{d-2}{2})\theta} \left(\mathcal{A}_d^{(c)} f \right) (\theta) d\theta; \quad (4.41)$$

here γ is the same contour as for the case $d = 2$ (see Fig.3 and Eq.(4.5)), and the definition of $\mathcal{A}_d^{(c)}$ requires the following procedure. We introduce a decomposition of $f(\theta)$ of the form $f(\theta) = f_+(\theta) + f_-(\theta)$ where f_+ and f_- have the same analyticity and symmetry properties as f , but enjoy the following additional property: f_+ (resp. f_-) admits a *single cut*, namely σ_+ (resp. σ_-) across which its discontinuity coincides with the corresponding one of f , denoted unambiguously by $\Delta f_+(v)$ (resp. $\Delta f_-(v)$). Such a decomposition can be done by considering the representation $\underline{f}(\cos \theta) = f(\theta)$ of f as a holomorphic function \underline{f} in $\mathbb{C} \setminus \{[\cosh v_+, +\infty[\cup]-\infty, -\cosh v_-]\}$ bounded by $\text{cst } |\cos \theta|^m$ and defining $\underline{f}_\pm(\cos \theta) = f_\pm(\theta)$ through appropriate Cauchy integrals involving the respective weights $(\Delta \underline{f})_+(\cosh v)/(\cosh v)^{E(m)+1}$ and $(\Delta \underline{f})_-(\cosh v)/(\cosh v)^{E(m)+1}$ on the corresponding cuts of \underline{f} (i.e. in physical terms by the method of “*subtracted dispersion relations*”). The decomposition is non-unique, but defined up to a polynomial in $\cos \theta$ with degree $E(m)$. We then define:

$$\left(\mathcal{A}_d^{(c)} f \right) (\theta) = \left(\mathcal{A}_{d+}^{(c)} f_+ \right) (\theta) + \left(\mathcal{A}_{d-}^{(c)} f_- \right) (\theta), \quad (4.42)$$

where $\mathcal{A}_{d+}^{(c)}f_+$ and $\mathcal{A}_{d-}^{(c)}f_-$ are respectively defined as holomorphic functions in the periodic cut-planes $\mathbb{C}\setminus\sigma_+$ and $\mathbb{C}\setminus\sigma_-$ by the following integrals:

$$\left(\mathcal{A}_{d+}^{(c)}f_+\right)(\theta) = - \int_{\gamma(\pi,\theta)} f_+(\tau) [2(\cos\theta - \cos\tau)]^{\frac{d-4}{2}} \sin\tau d\tau \quad (4.43)$$

$$\left(\mathcal{A}_{d-}^{(c)}f_-\right)(\theta) = - \int_{\gamma(0,\theta)} f_-(\tau) [2(\cos\theta - \cos\tau)]^{\frac{d-4}{2}} \sin\tau d\tau. \quad (4.44)$$

In the latter, the path $\gamma(\pi, \theta)$ (resp. $\gamma(0, \theta)$) with end-points π and θ (resp. 0 and θ) has to belong to the domain $\mathbb{C}\setminus\sigma_+$ (resp. $\mathbb{C}\setminus\sigma_-$) and the function $[2(\cos\theta - \cos\tau)]^{\frac{d-4}{2}}$ is determined by the condition that it is positive for $\theta = iw, \tau = iw, 0 < w < v$.

Let us first assume that the boundary values of $\mathcal{F}(z) = f(\theta)$ on the cuts $\sum_{\pm}^{(c)}$ (resp. σ_{\pm}) are continuous (from both sides). One then checks that the jumps of $i\mathcal{A}_d^{(c)}f(\theta)$ across the cuts σ_+ and σ_- are respectively equal to $\mathcal{A}_d\Delta f_+(v)$ and $e^{-i\pi(\frac{d-2}{2})}\mathcal{A}_d\Delta f_-(v)$ (in view of Eq.(4.35) and (4.39)). By using the same contour distortion argument as for the case $d = 2$, namely by replacing γ by $\gamma_+ + \gamma_-$, and then flattening γ_+, γ_- on the respective cuts σ_+, σ_- , one can then rewrite the integral at the r.h.s. of (4.41) as:

$$\begin{aligned} & \int_{\gamma_+ + \gamma_-} e^{i(\lambda + \frac{d-2}{2})\theta} \left(\mathcal{A}_d^{(c)}f\right)(\theta) d\theta \\ &= \int_{\gamma_+} e^{i(\lambda + \frac{d-2}{2})\theta} \left(\mathcal{A}_{d+}^{(c)}f_+\right)(\theta) d\theta + \int_{\gamma_-} e^{i(\lambda + \frac{d-2}{2})\theta} \left(\mathcal{A}_{d-}^{(c)}f_-\right)(\theta) d\theta \\ &= \int_{v_+}^{+\infty} e^{-(\lambda + \frac{d-2}{2})v} (\mathcal{A}_d\Delta f_+)(v) dv + e^{i\pi\lambda} \int_{v_-}^{+\infty} e^{-(\lambda + \frac{d-2}{2})v} (\mathcal{A}_d\Delta f_-)(v) dv \end{aligned} \quad (4.45)$$

In view of Eqs.(4.34), (4.38), the latter can be rewritten (as for $d = 2$) :

$$\tilde{F}(\lambda) = \tilde{F}_+(\lambda) + e^{i\pi\lambda}\tilde{F}_-(\lambda) \quad (4.45')$$

where the functions \tilde{F}_+, \tilde{F}_- , holomorphic in $\mathbb{C}_+^{(m)}$ now denote the Laplace transforms of the discontinuities $\Delta f_{+|\Sigma_+}, \Delta f_{-|\Sigma_-}$ taken on the corresponding sets Σ_+, Σ_- according to formulas (4.33), (4.38) (with $F_{\pm} = \Delta f_{\pm|\Sigma_{\pm}}$).

Remark: The Laplace transform $\tilde{F}(\lambda)$ that we have introduced only depends on the function $\mathcal{F}(z)$ through its discontinuities on Σ_+, Σ_- ; it therefore does not depend on the particular decomposition $f = f_+ + f_-$, in spite of the fact that $\mathcal{A}_d^{(c)} f$ actually depends on the latter.

Link with the Fourier expansion on the sphere \mathbb{S}_{d-1} (Froissart–Gribov -type equalities):

For $\lambda = \ell$ integer (with $\ell > m$), we rewrite Eq.(4.41) with the choice of contour $\gamma = \gamma_\alpha$ (as in the case $d = 2$, see Fig.3); by taking the periodicity of $\left(\mathcal{A}_d^{(c)} f\right)(\theta) \cdot e^{i\left(\frac{d-2}{2}\right)\theta}$ into account, this yields:

$$\tilde{F}(\ell) = \omega_{d-2} \int_{-\alpha}^{2\pi-\alpha} e^{i\left(\ell+\frac{d-2}{2}\right)u} \left(\mathcal{A}_d^{(c)} f\right)(u) du \quad (4.46)$$

By choosing $\alpha = \pi$, the latter can be rewritten in view of Eq.(4.42):

$$\tilde{F}(\ell) = \omega_{d-2} \int_{-\pi}^{\pi} e^{i\left(\ell+\frac{d-2}{2}\right)u} \left[\left(\mathcal{A}_{d+}^{(c)} f_+\right)(u) + \left(\mathcal{A}_{d-}^{(c)} f_-\right)(u) \right] du \quad (4.47)$$

Then by applying Eqs. (4.43), (4.44), inverting the order of integrations and using obvious symmetries in the double integrals, one obtains:

$$\omega_{d-2} \int_{-\pi}^{\pi} e^{i\left(\ell+\frac{d-2}{2}\right)u} \left(\mathcal{A}_{d+}^{(c)} f_+\right)(u) du = \quad (4.48)$$

$$\omega_{d-2} \int_0^{\pi} f_+(t) \sin t dt \int_{-t}^t e^{i\left(\ell+\frac{d-2}{2}\right)u} [2(\cos u - \cos t)]^{\frac{d-4}{2}} du$$

and

$$\omega_{d-2} \int_{-\pi}^{\pi} e^{i\left(\ell+\frac{d-2}{2}\right)u} \left(\mathcal{A}_{d-}^{(c)} f_-\right)(u) du = \quad (4.48')$$

$$\omega_{d-2} \int_0^{\pi} f_-(t) \sin t dt \int_t^{2\pi-t} (-i)^{d-2} e^{i\left(\ell+\frac{d-2}{2}\right)u} [2(\cos t - \cos u)]^{\frac{d-4}{2}} du$$

We now use the following integral representations of the ultraspherical Legendre polynomials, which are consequences of the representation (4.3) (see

in [25c)] the derivation of Eqs. (III-25) and (III-25') from (III-18)):

$$\begin{aligned} P_\ell^{(d)}(\cos t) &= \left(\frac{\omega_{d-2}}{\omega_{d-1}}\right) (\sin t)^{-(d-3)} \int_{-t}^t e^{i(\ell+(d-2)/2)u} [2(\cos u - \cos t)]^{\frac{d-4}{2}} du = \\ &(-i)^{d-2} \left(\frac{\omega_{d-2}}{\omega_{d-1}}\right) (\sin t)^{-(d-3)} \int_t^{2\pi-t} e^{i(\ell+(d-2)/2)u} [2(\cos t - \cos u)]^{\frac{d-4}{2}} du. \end{aligned} \quad (4.49)$$

The latter imply that Eqs (4.48) and (4.48') can be rewritten as follows:

$$\omega_{d-2} \int_{-\pi}^{\pi} e^{i(\ell+\frac{d-2}{2})u} \left(\mathcal{A}_{d\pm}^{(c)} f_\pm\right)(u) du = \omega_{d-1} \int_0^{\pi} f_\pm(t) P_\ell^{(d)}(\cos t) (\sin t)^{d-2} dt. \quad (4.50)$$

In view of Eq.(4.50), Eq.(4.47) can now be rewritten

$$\tilde{F}(\ell) = \omega_{d-1} \int_0^{\pi} (f_+(t) + f_-(t)) P_\ell^{(d)}(\cos t) (\sin t)^{d-2} dt, \quad (4.51)$$

and since $f = f_+ + f_-$, by comparing to Eq.(4.29):

$$(\text{for } \ell > m) \quad \tilde{F}(\ell) = f(\ell). \quad (4.52)$$

These *Froissart–Gribov-type equalities* can also be given the following more precise form (in view of Eq.(4.45')):

$$f_\ell = \tilde{F}_+(\ell) + (-1)^\ell \tilde{F}_-(\ell) \quad (4.53)$$

Note that if one calls $f_{\ell\pm}$ the Legendre coefficients of the corresponding functions $f_\pm(\theta) = \mathcal{F}_\pm(z)$ on the sphere \mathbb{S}_{d-1} , it can be easily checked that $\tilde{F}_+(\ell) = f_{\ell+}$ and $(-1)^\ell \tilde{F}_-(\ell) = f_{\ell-}$.

The case of perikernels with distribution-like boundary values:

As in § 4.1 (Theorem 2), we shall now give a detailed version of the previous properties under the assumption that $\mathcal{F}(z) = f(\theta)$ admits distribution-like boundary values (and discontinuities) on the cuts $\Sigma_\pm^{(c)}$ (resp. σ_\pm).

Theorem 3 *Let $\mathcal{F}(z) = f(\theta)$ represent an invariant perikernel of moderate growth on $X_{d-1}^{(c)}$, satisfying uniform bounds of the following form*

$$|f(u + iv)| \leq c \eta^{-\beta} e^{mv} \quad (4.54)$$

in all the subsets Π_η^+ ($\eta > 0$) of Π^+ (see Eq.(4.12)), or equivalently:

$$|\mathcal{F}(z)| \leq C\eta^{-\beta} |z^{(d-1)}|^m \quad (4.54')$$

in the subsets D_η , defined as the preimages of Π_η^+ in D . In (4.54), (4.54'), we assume that $m > -1$ and $\beta \geq 0$.

Then

i) The discontinuities $(\Delta\mathcal{F})_\pm(z) = (\Delta f)_\pm(v)$ of $i\mathcal{F}$ (resp. if) across the cuts $\Sigma_\pm^{(c)}$ (resp. σ_\pm) are well-defined as distributions. They admit Laplace-transforms $\tilde{F}_\pm(\lambda)$ on the hyperboloid X_{d-1} defined for $\text{Re } \lambda > m$ by:

$$\tilde{F}_\pm(\lambda) = \omega_{d-1} \int_{v_\pm}^{+\infty} \Delta f_\pm(v) Q_\lambda^{(d)}(\cosh v) (\sinh v)^{d-2} dv, \quad (4.55)$$

where these integrals are understood as the action of the distributions Δf_\pm on the (admissible) test-functions $Q_\lambda^{(d)}(\cosh v) (\sinh v)^{d-2}$. $\tilde{F}_\pm(\lambda)$ are holomorphic in $\mathbb{C}_+^{(m)}$ and satisfy uniform bounds of the following form (for all $\varepsilon, \varepsilon' > 0$):

$$\left| \tilde{F}_\pm(\lambda) \right| \leq C_\pm^{(\varepsilon, \varepsilon')} |\lambda - m|^{\beta - \frac{d-2}{2} + \varepsilon'} e^{-[\text{Re } \lambda - (m + \varepsilon)]v_\pm} \quad (4.56)$$

in all the corresponding half-planes $\mathbb{C}_+^{(m+\varepsilon)}$.

ii) The Laplace-transform $\tilde{F} = \mathcal{L}_d(\mathcal{F})$ of \mathcal{F} is defined as $\tilde{F} = \mathcal{L}(\hat{f})$, where $\hat{f}(\theta) = \omega_{d-2} e^{i(\frac{d-2}{2}\theta)} (\mathcal{A}_d^{(c)} f)(\theta)$ and \mathcal{L} is the Fourier-Laplace transformation (4.5); $(\mathcal{A}_d^{(c)} f)(\theta)$ is defined by means of formulae (4.42), (4.43), (4.44) involving a decomposition $f = f_+ + f_-$ of f into "single-cut functions" f_+, f_- . This transform $\tilde{F}(\lambda)$ is holomorphic in $\mathbb{C}_+^{(m)}$ and satisfies the following properties:

a)

$$\tilde{F}(\lambda) = \tilde{F}_+(\lambda) + e^{i\pi\lambda} \tilde{F}_-(\lambda) \quad (4.57)$$

b) for all integers ℓ such that $\ell > m$, the Legendre coefficients f_ℓ of $\mathcal{F}|_{\mathbb{S}_{d-1}}$, defined by Eq.(4.29), are given by the following (Froissart–Gribov-type) relations:

$$f_\ell = \tilde{F}(\ell) = \tilde{F}_+(\ell) + (-1)^\ell \tilde{F}_-(\ell) \quad (4.58)$$

c)

$$\tilde{F}(\lambda) = (-i)^{d-2} \omega_{d-1} \int_{\gamma} f(\theta) Q_{\lambda}^{(d)}(\cos \theta) (\sin \theta)^{d-2} d\theta \quad (4.59)$$

Proof:

As in Theorem 2, the validity of bounds of the form (4.54') (resp (4.54)) is equivalent to the existence of distribution boundary values and discontinuities on $\Sigma_{\pm}^{(c)}$ (resp. σ_{\pm}). The corresponding discontinuities Δf_{\pm} , now defined as distributions with support σ_{\pm} , can still be used for introducing a decomposition $f = f_+ + f_-$ of f into “single-cut functions” f_{\pm} by means of Cauchy integrals in the $\cos \theta$ -plane; in the latter, the “weights” $\Delta \underline{f}_{\pm}(\cosh v)/(\cosh v)^{E(m)+1}$ act as distributions on the Cauchy kernel considered as a test-function. The expressions (4.43), (4.44) of $\left(\mathcal{A}_{d\pm}^{(c)} f_{\pm}\right)(\theta)$ then remain well-defined in the corresponding cut-planes $\mathbb{C} \setminus \sigma_{\pm}$ and we can introduce the functions

$$\hat{f}_{\pm}(\theta) = \omega_{d-2} e^{i(\frac{d-2}{2})\theta} \left(\mathcal{A}_{d\pm}^{(c)} f_{\pm}\right)(\theta) \quad (4.60)$$

which allow us to write $\tilde{F} = \mathcal{L}(\hat{f})$, with $\hat{f} = \hat{f}_+ + \hat{f}_-$. The functions \hat{f}_+ , \hat{f}_- and \hat{f} are 2π -periodic and holomorphic in Π^+ and we claim that the assumed bounds (4.54) on f (with $m > -1$ and $\beta \geq 0$) imply that \hat{f} satisfies the assumptions of Theorem 2, namely bounds of the form (4.11) with the same value of m (although not the same value of β). This fact is fully justified in the detailed analysis given below for proving the bounds (4.56); it relies on the interpretation of the transformation $\mathcal{A}_d^{(c)}$ as a *primitive of non-integral order with respect to the variable $\cos \theta$* (see Appendix B, Proposition B.6). The conclusions of Theorem 2 then imply the expression (4.57) of $\tilde{F}(\lambda)$, with

$$\tilde{F}_{\pm}(\lambda) = \int_{v_{\pm}}^{+\infty} \Delta \hat{f}_{\pm}(v) e^{-\lambda v} dv, \quad (4.61)$$

these integrals being (if necessary) understood as the action of the distributions $\Delta \hat{f}_{\pm}$ on the exponential function $e^{-\lambda v}$ (as specified in the proof of Theorem 2). The proof of Eq.(4.58) has already been given above in full generality (see the computation after (4.46)) which is independent of the continuous or distribution-like character of the boundary values of f .

Proof of the bounds (4.56): One applies the results of Proposition B.6 with the following specifications. The holomorphic function $f(\theta)$ of Proposition B.6 plays the role respectively of $f_+(\theta)$ and $f_-(\theta + \pi)$. One then considers the function $\hat{f}_m^{(\alpha)}$ studied in Proposition B.6 for the value $\alpha = \frac{d-2}{2}$. Then, in view of Eq.(4.60), $\hat{f}_m^{(\alpha)}(\theta)$ coincides respectively (up to a constant factor) with $\hat{f}_{m+}(\theta) = e^{im\theta} \hat{f}_+(\theta)$ and $\hat{f}_{m-}(\theta) = e^{im(\theta+\pi)} \hat{f}_-(\theta + \pi)$ and the corresponding Laplace transforms $\tilde{F}_{m\pm}(\lambda)$ of $\hat{f}_{m\pm}(\theta)$ are such that $\tilde{F}_{\pm}(\lambda) = \tilde{F}_{m\pm}(\lambda - m)$. According to the results of Proposition B.6, one is then led to distinguish three cases:

a) $\beta > \frac{d-2}{2}$: in this case, \hat{f}_{m+} and \hat{f}_{m-} belong to the class $\mathcal{O}^{\beta - \frac{d-2}{2}}(B_\pi^{\text{cut}})$. (Note that $\hat{f} = \hat{f}_+ + \hat{f}_-$ then satisfies uniform bounds of the form $|\hat{f}(u + iv)| \leq C\eta^{-(\beta - \frac{d-2}{2})} e^{mv}$ in all the corresponding subsets Π_η^+ ($\eta > 0$) of Π^+).

As in Theorem 2 i), the corresponding majorization (4.56) of $\tilde{F}_{\pm}(\lambda)$ (namely of $\tilde{F}_{m\pm}(\lambda - m)$) then follows from Proposition B.4 iii), formula (B.19), with (in the present case) β replaced by $\beta - \frac{d-2}{2}$.

b) $\beta = \frac{d-2}{2}$: the functions \hat{f}_{m+} and \hat{f}_{m-} belong to $\mathcal{O}^{0*}(B_\pi^{\text{cut}})$, (which then implies that $\hat{f} = \hat{f}_+ + \hat{f}_-$ is bounded by $C |\log \eta| e^{mv}$ in each Π_η^+ ($\eta > 0$)). Proposition B.4 iii) still applies and yields again the corresponding majorization (4.56) (involving the power $|\lambda - m|^{\varepsilon'}$).

c) $\beta < \frac{d-2}{2}$: in this case, $\hat{f}_{m\pm}(\theta)$ admit continuous boundary values; more precisely, Proposition B.5 shows that $\hat{f}_{m\pm}(\theta)$ belongs to the class $\mathcal{O}_{\frac{d-2}{2} - \beta}(B_\pi^{\text{cut}})$; therefore, in view of Proposition B.3, $\tilde{F}_{\pm}(\lambda)$ again satisfy the bound (4.56).

It remains to show that the expressions (4.61) of $\tilde{F}_{\pm}(\lambda)$ imply the corresponding alternative form (4.55). Considering $\tilde{F}_+(\lambda)$, one rewrites (4.61) (as in Theorem 2) as

$$\begin{aligned} \tilde{F}_+(\lambda) &= \int_{\gamma_+} e^{i\lambda\theta} \hat{f}(\theta) d\theta = \int_{\gamma_+} e^{i\lambda\theta} \hat{f}_+(\theta) d\theta, \text{ i.e.} \\ \tilde{F}_+(\lambda) &= \omega_{d-2} \int_{\gamma_+} e^{i(\lambda + \frac{d-2}{2})\theta} \left(\mathcal{A}_{d+}^{(c)} f_+ \right) (\theta) d\theta \end{aligned} \quad (4.62)$$

with $\left(\mathcal{A}_{d+}^{(c)} f_+ \right) (\theta)$ expressed by Eq.(4.43). By choosing γ_+ and $\gamma(\pi, \theta)$ such that, for all θ , $\text{supp. } \gamma(\pi, \theta) \subset \text{supp } \gamma_+$ (as e.g. in Fig.5), one can treat the

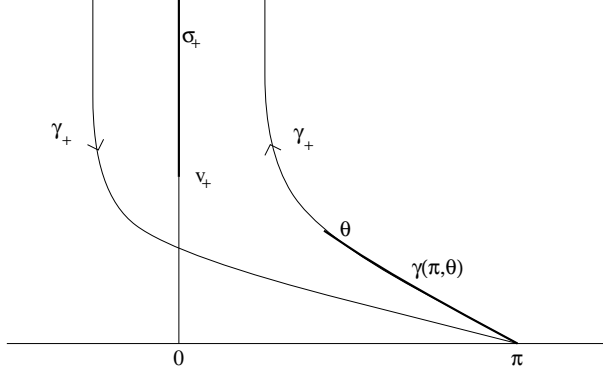

Figure 5

resulting expression for $\tilde{F}_+(\lambda)$ as a double integral (convergent for λ in $\mathbb{C}_+^{(m)}$) in which the order of the integrations can be inverted. This yields:

$$\tilde{F}_+(\lambda) = (-i)^{d-2} \omega_{d-1} \int_{\gamma_+} f_+(\tau) Q_\lambda^{(d)}(\cos \tau) (\sin \tau)^{d-2} d\tau \quad (4.63)$$

Now, by the very definition of boundary values of holomorphic functions in the sense of distributions, the expression (4.63) of $\tilde{F}_+(\lambda)$ can be rewritten in the distribution form (4.55) (by flattening the folded contour γ_+ onto the cut σ_+). A similar argument holds for $\tilde{F}_-(\lambda)$. Moreover, by plugging the expression (4.63) of $\tilde{F}_+(\lambda)$ and the analogous one for $\tilde{F}_-(\lambda)$ into Eq.(4.57) and then noticing that the corresponding integration paths γ_+ and γ_- can be replaced by γ , one obtains the expression (4.59) of $\tilde{F}(\lambda)$ in terms of $f = f_+ + f_-$.

As in the case $d = 2$, one still defines the quantities $\tilde{F}^{(s)}(\lambda), \tilde{F}^{(a)}(\lambda)$ by formula (4.22): they are respectively the Laplace transforms on X_{d-1} of the distributions $\Delta f^{(s)}, \Delta f^{(a)}$ defined (on X_{d-1}) by Eqs.(4.21). One can thus complete the second part of Theorem 3 by the

Proposition 7bis:

The statement of Proposition 7 is valid without modification in the d -dimensional case ($d \geq 3$) apart from the bounds on $\tilde{F}^{(s)}(\lambda), \tilde{F}^{(a)}(\lambda)$ which are now given by the r.h.s. of (4.56).

Inversion formulas:

We shall give formulas which express $\mathcal{F}(z) = f(\theta)$ and its discontinuities $(\Delta\mathcal{F})_{\pm}(z) = (\Delta f)_{\pm}(v)$ in terms of the Laplace transforms $\tilde{F}_{\pm}(\lambda)$ of the latter. The formulas exactly parallel the inversion formulas (4.25), (4.26), (4.27) of the two-dimensional case; they only differ from the latter by the fact that the trigonometric kernel $\cos \lambda\theta$ is replaced by $h_d(\lambda) P_{\lambda}^{(d)}(\cos \theta)$, where $P_{\lambda}^{(d)}$ is the d -dimensional first-kind Legendre function

$$P_{\lambda}^{(d)}(\cos \theta) = 2 \frac{\omega_{d-2}}{\omega_{d-1}} (\sin \theta)^{-(d-3)} \int_0^{\theta} \cos[(\lambda + (d-2)/2)\tau] [2(\cos \tau - \cos \theta)]^{\frac{d-4}{2}} d\tau \quad (4.64)$$

and

$$h_d(\lambda) = \frac{(2\lambda + d - 2)}{(d-2)!} \frac{\Gamma(\lambda + d - 2)}{\Gamma(\lambda + 1)}. \quad (4.65)$$

$P_{\lambda}^{(d)}(\cos \theta)$ is defined as a holomorphic function in the cut plane $\mathbb{C} \setminus]-\infty, -1]$.

The following formula is shown to hold in the open set $0 < |\operatorname{Re} \theta| < \pi$: with the specification $\varepsilon_{\theta} = \operatorname{sgn}(\operatorname{Re} \theta)$

$$\begin{aligned} \mathcal{F}(z) \equiv f(\theta) &= -\frac{1}{2\omega_d} \int_{-\infty}^{+\infty} \frac{\tilde{F}_{+}(m + i\nu) h_d(m + i\nu) P_{m+i\nu}^{(d)}(\cos \theta - \varepsilon_{\theta}\pi)}{\sin \pi(m + i\nu)} d\nu \\ &\quad - \frac{1}{2\omega_d} \int_{-\infty}^{+\infty} \frac{\tilde{F}_{-}(m + i\nu) h_d(m + i\nu) P_{m+i\nu}^{(d)}(\cos \theta)}{\sin \pi(m + i\nu)} d\nu \\ &\quad + \frac{1}{\omega_d} \sum_{0 \leq \ell < m} f_{\ell} h_d(\ell) P_{\ell}^{(d)}(\cos \theta). \end{aligned} \quad (4.66)$$

As in Eq.(4.26), the first term at the r.h.s. of (4.66) defines a pair of holomorphic functions in the respective strips $0 < u < 2\pi$ and $-2\pi < u < 0$ (corresponding to the choice $\varepsilon_{\theta} = +$ or $-$ in the argument of the cosine), while the second term defines a holomorphic function in the strip $-\pi < u < \pi$: this follows from the bounds (4.57) on $\tilde{F}_{\pm}(\lambda)$ and the power behaviour of $P_{m+i\nu}^{(d)}(\cos \theta)$ as $|\nu|^{\frac{d-1}{2}}$ (easily derived from the representation (4.64) of $P_{\lambda}^{(d)}$).

The restriction of \mathcal{F} to the sphere \mathbb{S}_{d-1} , namely $\mathcal{F}_{|\mathbb{S}_{d-1}}(z) = f_{|\mathbb{R}}(\theta)$, is also expressed by the generalized Legendre (or ‘‘partial-wave’’) expansion:

$$f_{|\mathbb{R}}(\theta) = \frac{1}{\omega_d} \sum_{\ell \in \mathbb{N}} f_{\ell} h_d(\ell) P_{\ell}^{(d)}(\cos \theta) \quad (4.67)$$

Finally, the discontinuities $\Delta f_+(v)$ and $\Delta f_-(v)$ of f across the cuts σ_+ and σ_- are given by the following (identical) formulas:

$$(\Delta f)_\pm(v) = \frac{1}{\omega_d} \int_{-\infty}^{+\infty} \tilde{F}_\pm(m+i\nu) h_d(m+i\nu) P_{m+i\nu}^{(d)}(\cosh v) d\nu \quad (4.68)$$

which (in view of the polynomial increase in ν of all factors of the integrand) must be understood in the sense of distributions according to Appendix B.

All these formulas have been established in [25c)] (under assumptions of continuity for the boundary values of \mathcal{F}) in the case where a single cut, namely σ_+ , is present. The proof given in [25c)] applies equally well to the derivation of Eq.(4.66) under the present assumptions; however, for tutorial reasons, we will sketch the derivation of this result which relies on the inversion of the two transformations (4.41) and (4.42),... (4.44). We must treat separately the cases of even and odd dimensions d .

a) d even ($d \geq 4$): the Abel-type transformations (4.43), (4.44) can be inverted as follows:

$$f_\pm(\theta) = \omega_{d-2} \left(-\frac{1}{2\pi} \frac{1}{\sin \theta} \frac{d}{d\theta} \right)^{\frac{d-2}{2}} \left[\left(\mathcal{A}_{d\pm}^{(c)} f_\pm \right) (\theta) \right] \quad (4.69)$$

and the inversion of the Fourier integrals over γ_\pm in (4.45) yields (by taking into account that $f_\ell = f_{\ell+} + f_{\ell-}$):

$$\begin{aligned} \omega_{d-2} \left(\mathcal{A}_d^{(c)} f \right) (\theta) &= \omega_{d-2} \left(\mathcal{A}_{d+}^{(c)} f_+ \right) (\theta) + \omega_{d-2} \left(\mathcal{A}_{d-}^{(c)} f_- \right) (\theta) \\ &= \frac{(-1)^{\frac{d}{2}}}{2\pi} \int_{-\infty}^{\infty} \frac{\tilde{F}_+(m+i\nu) \cos \left[\left(m+i\nu + \frac{d-2}{2} \right) (\theta - \varepsilon_\theta \pi) \right]}{\sin \pi (m+i\nu)} d\nu \\ &\quad - \int_{-\infty}^{\infty} \frac{\tilde{F}_-(m+i\nu) \cos \left(m+i\nu + \frac{d-2}{2} \right) \theta}{\sin \pi (m+i\nu)} d\nu + \\ &\quad + \sum_{-m-d+2 < \ell < m} f_\ell \cos(\ell + (d-2)/2)\theta \end{aligned} \quad (4.70)$$

By applying the differential operator at the r.h.s. of (4.69) to both sides of Eq.(4.70), we then directly obtain Eq.(4.66), thanks to the integral representation (see [25b)] Eq.(II.85)):

$$h_d(\lambda) P_\lambda^{(d)}(\cos \theta) = \frac{2\omega_d}{(2\pi)^{d/2}} \left(-\frac{1}{\sin \theta} \frac{d}{d\theta} \right)^{\frac{d-2}{2}} [\cos(\lambda + (d-2)/2)\theta] \quad (4.71)$$

b) d odd ($d \geq 3$): the Abel inversion formulae (4.69) are replaced by

$$f_+(\theta) = -2\omega_{d-2} \left(-\frac{1}{2\pi} \frac{1}{\sin \theta} \frac{d}{d\theta} \right)^{\frac{d-1}{2}} \int_{\varepsilon_\theta \pi}^\theta \left(\mathcal{A}_{d+}^{(c)} f_+ \right) (\tau) [2(\cos \theta - \cos \tau)]^{-1/2} \sin \tau d\tau \quad (4.72)$$

$$f_-(\theta) = -2\omega_{d-2} \left(-\frac{1}{2\pi} \frac{1}{\sin \theta} \frac{d}{d\theta} \right)^{\frac{d-1}{2}} \int_0^\theta \left(\mathcal{A}_{d-}^{(c)} f_- \right) (\tau) [2(\cos \theta - \cos \tau)]^{-1/2} \sin \tau d\tau \quad (4.73)$$

and correspondingly the inversion of the Fourier integrals in (4.45) yields the following expressions for $\mathcal{A}_{d\pm}^{(c)} f_\pm$ in the open set $\{\theta; 0 < |\operatorname{Re} \theta| < \pi\}$:

$$\begin{aligned} & \omega_{d-2} \left(\mathcal{A}_{d+}^{(c)} f_+ \right) (\theta) = \\ & \frac{i\varepsilon_\theta (-1)^{\frac{d-1}{2}}}{2\pi} \left\{ - \int_{-\infty}^{\infty} \frac{F_+(m+i\nu) \sin \left[\left(m+i\nu + \frac{d-2}{2} \right) (\theta - \varepsilon_\theta \pi) \right]}{\sin \pi (m+i\nu)} d\nu \right. \\ & \quad \left. + \sum_{-m-d+2 < \ell < m} f_{\ell+} \sin[(\ell + (d-2)/2)\theta - \varepsilon_\theta((d-2)/2)\pi] \right\} \quad (4.74) \end{aligned}$$

$$\begin{aligned} \omega_{d-2} \left(\mathcal{A}_{d-}^{(c)} f_- \right) (\theta) &= \frac{i}{2\pi} \left\{ - \int_{-\infty}^{\infty} \frac{\tilde{F}_-(m+i\nu) \sin \left(m+i\nu + \frac{d-2}{2} \right) \theta}{\sin \pi (m+i\nu)} d\nu \right. \\ & \quad \left. + \sum_{-m-d+2 < \ell < m} f_{\ell-} \sin(\ell + (d-2)/2)\theta \right\} \quad (4.75) \end{aligned}$$

By applying the integro-differential operator at the r.h.s. of (4.72) (resp.(4.73)) to both sides of Eq.(4.74) (resp.(4.75)), we then directly obtain Eq.(4.66), thanks to the integral representation (see [25b]) Eq.(II-86)):

$$h_d(\lambda) P_\lambda^{(d)}(\cos \theta) = \frac{4i\omega_d}{(2\pi)^{\frac{d+1}{2}}} \left(\frac{-1}{\sin \theta} \frac{d}{d\theta} \right)^{\frac{d-1}{2}} \int_0^\theta \frac{\sin \left(\lambda + \frac{d-2}{2} \right) \tau \sin \tau}{[2(\cos \theta - \cos \tau)]^{1/2}} d\tau \quad (4.76)$$

For $\theta = u$ real (i.e. $z \in \mathbb{S}_{d-1}$), formula (4.66) can be seen to reduce to the expansion (4.67) by using the same contour distortion argument [30,31] in the λ -plane as in the case $d = 2$ (see Eqs.(4.26), (4.27)); this can be done in two equivalent ways:

i) by proceeding directly with the r.h.s. of (4.66) thanks to the properties of $P_\lambda^{(d)}(\cos \theta)$ as a holomorphic function of λ in the right-hand plane.

ii) by proceeding with the r.h.s. of (4.70) (resp. (4.74), (4.75)) which only involves trigonometric functions and then applying the inverse Abel operator of Eq.(4.69) (resp. (4.72), (4.73)) which will restore the ultraspherical polynomials $h_d(\ell) P_\ell^{(d)}(\cos \theta)$ term by term in the expansion.

Finally, the formulas (4.68) for the discontinuities Δf_\pm are obtainable from (4.66) either directly (thanks to relevant discontinuity formulas for the $P_\lambda^{(d)}(\cos \theta)$ on $]-\infty, -1]$) or by computing the corresponding discontinuities of $(\mathcal{A}_{d\pm}^{(c)} f_\pm)(\theta)$ from their representations (4.70) (resp. (4.74), (4.75)) and then applying the inverse Abel operators of Eq.(4.69) (resp. (4.72) (4.73)). The case of distribution-like discontinuities requires a suitable regularization corresponding to the application of a “cut-off” to $\tilde{F}_\pm(m + i\nu)$.

Remarks:

i) If Eq.(4.66) is used for m integer, its r.h.s. must be understood as the action of the distribution $\lim_{\varepsilon \rightarrow 0, \varepsilon > 0} \frac{1}{\sin \pi(m - \varepsilon + i\nu)}$ on the numerator of the integrand.

ii) We refer to Theorem 4 of [25c)] for the possible use of formula (4.66) in a precise range of negative values of m . However, it is only for $m > -1$ that Eq.(4.66) is exactly the inverse of the transformation (4.55) defined under the assumptions of Theorem 3 (for $m \leq -1$, this transformation can generate poles of $\tilde{F}(\lambda)$ located as those of Q_λ at all the negative integers).

The following complement of Theorem 3 which emphasizes the reciprocal property of the transformation follows from the previous study of the inversion used conjointly with the principle of uniqueness of analytic continuation (it is the adaptation of Theorem 3 of [25c)] to the case with two cuts)

Theorem 4 *Let $\mathbf{K}(z, z')$ be an $SO(d)$ -invariant kernel on the sphere \mathbb{S}_{d-1} with set of Legendre coefficients f_ℓ (defined by Eq.(4.29) in terms of the function $\mathbf{f}(\theta) = \mathbf{F}(z) = \mathbf{K}(z, z_0)$, $z \cdot z_0 = -\cos \theta$). Let us then assume that the sets of even and odd coefficients f_ℓ admit respectively analytic interpolations*

$\tilde{F}^{(s)}(\lambda)$ and $\tilde{F}^{(a)}(\lambda)$ in $\mathbb{C}_+^{(m)}$ satisfying uniform bounds of the form (4.56) with $m > -1$.

Then there exists an invariant perikernel $\mathcal{K}(z, z')$ of moderate growth on $X_{d-1}^{(c)}$ represented by a holomorphic function $\mathcal{F}(z) = \mathcal{K}(z, z_0) = f(\theta)$ satisfying all the assumptions of Theorem 3 such that $\mathcal{K}|_{\mathbb{S}_{d-1} \times \mathbb{S}_{d-1}} = \mathbf{K}$ and correspondingly $f|_{\mathbb{R}} = \mathbf{f}$; moreover, the functions $\tilde{F}^{(s)}(\lambda)$ and $\tilde{F}^{(a)}(\lambda)$ appear respectively as the symmetric and antisymmetric combinations of the Laplace transforms \tilde{F}_\pm of the discontinuities Δf_\pm of f defined by formula (4.55).

4.3 Complex angular momentum analysis of the four-point functions

Starting from the basic postulates of Q.F.T., we have established in Theorem 1 that the four-point function $H([k])$ of any set of scalar fields enjoys a structure of *invariant perikernel* in each submanifold $\hat{\Omega}_{(\zeta, \zeta', K)}$ of the set $\hat{\Omega}_K$ associated with any space-like energy-momentum vector $K = (0, \dots, 0, \sqrt{-t})$, with $t \leq 0$. In particular, we have shown that the temperateness assumption expressed by the bounds (3.1) results in the properties of moderate growth (3.25), (3.26) of these perikernels:

$$\mathcal{K}_{(\zeta, \zeta', K)}(z, z') \equiv H([k]_{(\zeta, \zeta', K)}(z, z')) = \underline{H}_{(\zeta, \zeta', K)}(\cos \Theta_t), \quad (4.77)$$

$$\text{with } \cos \Theta_t = -z \cdot z'.$$

One can therefore apply the results of Theorem 3 to the latter, for which the notations of §4.2 and the identification (4.2) can also be used:

$$\underline{H}_{(\zeta, \zeta', K)}(\cos \Theta_t) = f_{(\zeta, \zeta', K)}(\Theta_t) = F(\zeta, \zeta'; t, \cos \Theta_t) \quad (4.78)$$

As in §4.2 (for $d > 2$) or §4.1 (for $d = 2$), we introduce the discontinuities $(\Delta f_{(\zeta, \zeta', K)})_\pm(v)$ of the function $if_{(\zeta, \zeta', K)}$ across the respective cuts $\sigma_+(v_s), \sigma_-(v_u)$ with thresholds $v_s = v_s(\zeta, \zeta', t), v_u = v_u(\zeta, \zeta', t)$ given by Eqs.(2.23), (2.24). These discontinuities are interpreted as the s - and u -channel “absorptive parts” of F in the submanifold $\hat{\Omega}_{(\zeta, \zeta', K)}$:

$$(\Delta f_{(\zeta, \zeta', K)})_+(v) = \Delta_s F(\zeta, \zeta'; t, \cosh v) \quad (4.79)$$

$$(\Delta f_{(\zeta, \zeta', K)})_-(v) = \Delta_u F(\zeta, \zeta'; t, \cosh v) \quad (4.80)$$

In view of the two possible dimensions of the manifolds $\hat{\Omega}_{(\zeta, \zeta', K)}$, namely $2(d-1)$ for $K \neq 0$ and $2d$ for $K = 0$ (see §2.2 and Theorem 1), the application of Theorem 3 (resp. Theorem 2 for the case $d = 2$) allows one to define correspondingly two different Laplace transforms of $H([k])$. However, by considering the case $K \neq 0$ (i.e. $t < 0$), one obtains *the generic complex angular momentum analysis of $H([k])$* whose results are specified in the following theorem; the peculiarities of the case $K = 0$ will be briefly commented at the end.

Theorem 5 *Let $F(\zeta, \zeta'; t, \cos \Theta_t) \equiv H([k])$ be any four-point function of local scalar fields satisfying bounds of the form (3.25), (3.26) in each section of maximal analyticity (or cut-submanifold) $\hat{\Omega}_{(\zeta, \zeta', K)}^{(\text{cut})}$, with $K^2 = t < 0$, $(\zeta, \zeta') \in \Delta_t \times \Delta_t$. Then there exists a function $\tilde{F}(\zeta, \zeta'; t, \lambda_t)$ which is holomorphic with respect to λ_t in $\mathbb{C}_+^{(m_*)}$ and satisfies the following properties:*

a)

$$\tilde{F} = \tilde{F}_s + e^{i\pi\lambda_t} \tilde{F}_u, \quad (4.81)$$

where, in the general case $d > 2$:

$$\begin{aligned} \tilde{F}_s(\zeta, \zeta'; t, \lambda_t) &= \omega_{d-1} \int_{v_s(\zeta, \zeta', t)}^{+\infty} \Delta_s F(\zeta, \zeta'; t, \cosh v) \\ &Q_{\lambda_t}^{(d)}(\cosh v) (\sinh v)^{d-2} dv, \end{aligned} \quad (4.82)$$

$$\begin{aligned} \tilde{F}_u(\zeta, \zeta'; t, \lambda_t) &= \omega_{d-1} \int_{v_u(\zeta, \zeta', t)}^{+\infty} \Delta_u F(\zeta, \zeta'; t, \cosh v) \\ &Q_{\lambda_t}^{(d)}(\cosh v) (\sinh v)^{d-2} dv. \end{aligned} \quad (4.83)$$

b) \tilde{F}_s and \tilde{F}_u are holomorphic functions of λ_t in $\mathbb{C}_+^{(m_*)}$ which satisfy uniform bounds of the following form:

$$\left| \tilde{F}_{s,u}(\zeta, \zeta'; t, \lambda_t) \right| \leq C_{s,u}^{\varepsilon, \varepsilon'} |\lambda_t - m_*|^{n - \frac{d-2}{2} + \varepsilon'} e^{-[\text{Re } \lambda_t - (m_* + \varepsilon)]v_{s,u}} \quad (4.84)$$

in the corresponding half-planes $\mathbb{C}_+^{(m_* + \varepsilon)}$.

c) for $\ell > m_*$, the off-shell partial-wave functions $f_\ell(\zeta, \zeta', t)$ of F , defined for $\zeta, \zeta' \in \Delta_t \times \Delta_t$, $t < 0$ by Eq.(4.2), are given by the following (Froissart-Gribov-type) relations:

$$f_\ell(\zeta, \zeta', t) = \tilde{F}(\zeta, \zeta'; t, \ell) \quad (4.85)$$

Moreover, the “symmetric and antisymmetric Laplace transforms”¹⁰ $\tilde{F}^{(s)}(\zeta, \zeta'; t, \lambda_t)$ and $\tilde{F}^{(a)}(\zeta, \zeta'; t, \lambda_t)$ defined by

$$\tilde{F}^{(s)} = \tilde{F}_s + \tilde{F}_u, \quad \tilde{F}^{(a)} = \tilde{F}_s - \tilde{F}_u \quad (4.86)$$

are Carlsonian interpolations in $\mathbb{C}_+^{(m_*+\varepsilon)}$ for the respective sets of even and odd partial-waves of F , namely one has:

$$\text{for } 2\ell > m, \quad f_{2\ell}(\zeta, \zeta', t) = \tilde{F}^{(s)}(\zeta, \zeta'; t, 2\ell) \quad (4.87)$$

$$\text{for } 2\ell + 1 > m, \quad f_{2\ell+1}(\zeta, \zeta', t) = \tilde{F}^{(a)}(\zeta, \zeta'; t, 2\ell + 1). \quad (4.88)$$

d) The four-point function F and the absorptive parts $\Delta_s F, \Delta_u F$ are re-obtained in terms of \tilde{F}_s and \tilde{F}_u by the following formulas:

$$\begin{aligned} F(\zeta, \zeta'; t, \cos \Theta_t) = & \\ & -\frac{1}{2\omega_d} \int_{-\infty}^{+\infty} \frac{\tilde{F}_s(\zeta, \zeta'; t, m_* + i\nu) h_d(m_* + i\nu) P_{m_*+i\nu}^{(d)}(\cos(\Theta_t - \varepsilon_{\Theta_t} \pi))}{\sin \pi(m_* + i\nu)} d\nu \\ & -\frac{1}{2\omega_d} \int_{-\infty}^{+\infty} \frac{\tilde{F}_u(\zeta, \zeta'; t, m_* + i\nu) h_d(m_* + i\nu) P_{m_*+i\nu}^{(d)}(\cos \Theta_t)}{\sin \pi(m_* + i\nu)} d\nu \quad (4.89) \\ & +\frac{1}{\omega_d} \sum_{0 \leq \ell < m_*} f_\ell(\zeta, \zeta', t) h_d(\ell) P_\ell^{(d)}(\cos \Theta_t) \end{aligned}$$

$$\begin{aligned} \Delta_{s,u} F(\zeta, \zeta'; t, \cosh v) = & \frac{1}{\omega_d} \int_{-\infty}^{+\infty} \tilde{F}_{s,u}(\zeta, \zeta'; t, m_* + i\nu) h_d(m_* + i\nu) \\ & P_{m_*+i\nu}^{(d)}(\cosh v) d\nu. \quad (4.90) \end{aligned}$$

e) When $[k]$ belongs to the Euclidean region $\hat{\mathcal{E}}_K$, (i.e. for $\cos \Theta_t \in [-1, +1]$), formula (4.89) can be replaced by the partial wave expansion of $H|_{\hat{\mathcal{E}}_K}$, namely:

$$H([k]) = F(\zeta, \zeta'; t, \cos \Theta_t) = \frac{1}{\omega_d} \sum_{0 \leq \ell < \infty} f_\ell(\zeta, \zeta', t) h_d(\ell) P_\ell^{(d)}(\cos \Theta_t), \quad (4.91)$$

¹⁰ Note that when F is the four-point function of a *single* scalar field Φ or of two fields Φ, Φ' in such a way that the t -channel is $(\Phi, \Phi) \rightarrow (\Phi', \Phi')$, one has $\Delta_s F = \Delta_u F$; in such cases $\tilde{F}^{(a)} = 0, f_{2\ell+1} = 0$, and only Eq.(4.87) survives.

f) In the case $d = 2$, all the previous results are valid provided the following replacements are performed:

In Eqs (4.82),(4.83): $\omega_{d-1}Q_{\lambda_t}^{(d)}(\cosh v)$ by $e^{-\lambda_t v}$,

In Eq.(4.89): $\frac{1}{\omega_d}h_d(m_* + i\nu)P_{m_*+i\nu}^{(d)}(\cos \Theta_t)$ by $\frac{1}{\pi} \cos[(m + i\nu)\Theta_t]$,
and similar ones in Eqs (4.90),(4.91).

The proof of properties a) and b) is a direct application of Theorem 3, since the bounds (3.25), (3.26) established in Sec.3 are equivalent in an obvious way to (4.54), (4.54') with the pair (m, β) replaced by (m_*, n) . Property c) follows from Eq(4.58) in Theorem 3 completed by Proposition 7bis. Properties d) and e) directly follow from the inversion formulas (4.66), (4.68) and (4.67) derived after Theorem 3. The case $d = 2$ (property f)) is obtained similarly as an application of Theorem 2 and of the inversion formulas (4.25),(4.26),(4.27).

In the case $K = 0$, it is possible to define *two* Laplace transforms, namely:
a) the function $\tilde{F}(\zeta, \zeta'; 0, \lambda_t)$ obtained as the limit of $\tilde{F}(\zeta, \zeta'; t, \lambda_t)$ (for $(\zeta, \zeta') \in \Delta_0 \times \Delta_0$) when t tends to zero (and satisfying exactly all the formulas of Theorem 3, with $t = 0$),

b) the function $\tilde{F}_0(\zeta, \zeta'; \lambda_t)$ obtained by formulas similar to Eqs (4.81),..., (4.83), with d replaced by $d + 1$ (a complete substitute to Theorem 5 being equally valid).

The connection between these two functions, both defined for $(\zeta, \zeta') \in \Delta_0 \times \Delta_0$ and $\lambda_t \in \mathbb{C}_+^{(m)}$, and the possible exploitation of this connection for the structure of the four-point function $H([k])$ will be treated elsewhere.

Remark

In view of the field-theoretical interpretation of $m_ = \max(m, n)$ and n as degrees of temperateness of the four-point function, the properties obtained in Theorem 5 have only made use of the results of harmonic analysis of Theorem 3 for the case $m \geq 0$. However it may occur that negative values of this parameter, corresponding to extended analyticity or meromorphy properties of the four-point functions in the complex angular momentum plane, be of relevant use in a second step where the "Bethe-Salpeter structure" will be taken into account [14].*

4.4 Analytic continuation of Euclidean field theory and complex angular momentum analysis

In this last subsection, let us forget about the Minkowskian framework of Q.F.T. considered throughout this paper and adopt the viewpoint of Euclidean field theory. The starting point of such a theory is the set of n -point “Schwinger functions”, considered as tempered distributions on the corresponding n -point Euclidean $((d+1)$ -dimensional) space-time, whose Fourier transforms are the n -point Green functions taken in the Euclidean energy-momentum space. In particular, the data which concern the four-point Green function are encoded in the properties of $H_{\mathcal{E}} = H|_{\mathcal{E}}$, where \mathcal{E} is the Euclidean subspace of $M^{(c)}$ introduced in §3.1 (see the Theorem at the end of §3.1). The crucial problem of Euclidean field theory, which is the problem of reconstructing Minkowskian Q.F.T. by analytic continuation of the Schwinger functions, has been solved under a certain set of sufficient conditions called the Osterwalder-Schrader axioms [33,34]. Here we wish to stress the special and unexpected relationship which exists between this problem and the validity of complex angular momentum analysis, as a direct corollary of our Theorem 4.

In fact, from the assumed $SO(d+1)$ -invariance of the theory it follows that the Euclidean four-point function $H_{\mathcal{E}}$ is represented by the function $F(\zeta, \zeta'; t, \cos \Theta_t)$ considered as given on the set $\{(\zeta, \zeta', t, \cos \Theta_t); t < 0, (\zeta, \zeta') \in \Delta_t \times \Delta_t, \cos \Theta_t \in [-1, +1]\}$. It is therefore equivalent to give oneself $H_{\mathcal{E}}$ or the corresponding set of “partial-wave-functions” $\{f_{\ell}(\zeta, \zeta', t), \ell \geq 0\}$ defined by Eq.(4.2) (for $t < 0, (\zeta, \zeta') \in \Delta_t \times \Delta_t$). We can then state:

Theorem 6 *Let $H_{\mathcal{E}}([k]) = F(\zeta, \zeta'; t, \cos \Theta_t)$ be any $SO(d+1)$ -invariant Euclidean four-point function whose sets of even and odd partial-wave functions $f_{\ell}(\zeta, \zeta', t)$ admit Carlsonian analytic interpolations in a given half-plane $\{\lambda_t \in \mathbb{C}_+^{(m)}\}$, denoted respectively by $\tilde{F}^{(s)}(\zeta, \zeta'; t, \lambda_t)$, $\tilde{F}^{(a)}(\zeta, \zeta'; t, \lambda_t)$ and satisfying Eqs (4.87), (4.88) and bounds of the form (4.84) with ¹¹ $v_s = v_u$.*

Then for each vector $K \in \mathbb{R}^{d+1}$, and each unit vector e_0 orthogonal to K fixing the time-direction, the restriction of $H_{\mathcal{E}}$ to $\hat{\mathcal{E}}_K$, admits an analytic continuation in the corresponding cut-manifold $\hat{\Omega}_K^{(cut)} = \hat{\Omega}_K \setminus (\Sigma_s \cup \Sigma_u)$ (represented by the cut $\cos \Theta_t$ -plane, with ζ, ζ' varying in $\Delta_t \times \Delta_t$). This analytic

¹¹for the sake of simplicity

continuation is defined explicitly via formula (4.89), which reduces in $\hat{\mathcal{E}}_K$, to the partial wave expansion (4.91) of $H_{\mathcal{E}}$.

The analytic continuation of $H_{\mathcal{E}}$ in the cut-manifolds $\hat{\Omega}_K^{(cut)}$ (for all K orthogonal to a given e_0) is indeed interpretable as *an analytic continuation which reaches the Minkowskian momentum space* (spanned by the hyperplane orthogonal to e_0 and the vector $-ie_0$) *and moreover generates the “absorptive part structure” with specified mass thresholds.*

APPENDIX A: Analytic completion and propagation of bounds

A property of analytic completion

We recall the following result, first obtained by V. Glaser by a method based on the Cauchy integral, then extended to the case of two polydisks in arbitrary situations by the tube method presented below [35].

Proposition A.1 Let $\mathcal{T}_+ = \{(\eta, \eta') \in \mathbb{C}^2; \text{Im } \eta > 0, \text{Im } \eta' > 0\}$ and $\mathcal{T}_- = \{(\eta, \eta') \in \mathbb{C}^2; \text{Im } \eta < 0, \text{Im } \eta' < 0\}$ and let \mathcal{R} be the “coincidence region”

$$\mathcal{R} = \{(\eta, \eta') \in \mathbb{R}^2; a < \eta < b, a' < \eta' < b'\}.$$

Then the holomorphy envelope of the “edge-of-the-wedge domain” $\Delta = \mathcal{T}_+ \cup \mathcal{T}_- \cup \mathcal{R}$ can be defined as follows: $\mathcal{H}(\Delta) = \bigcup_{0 \leq \alpha \leq \pi} \mathcal{T}_\alpha$, where each domain \mathcal{T}_α is the following polydisk:

$$\mathcal{T}_\alpha = \{(\eta, \eta') \in \mathbb{C}^2; \eta \in \Gamma_{ab}(\alpha), \eta' \in \Gamma_{a'b'}(\alpha)\};$$

$\Gamma_{ab}(\alpha)$ and $\Gamma_{a'b'}(\alpha)$ respectively denote the disks whose bordering circles make the angle α with the real axis and intersect the latter respectively at a, b and a', b' (see Fig A.1);

Proof: Let $\chi = \log \frac{\eta - b}{\eta - a}$, $\chi' = \log \frac{\eta' - b'}{\eta' - a'}$. One easily checks that the images of $\mathcal{T}_+, \mathcal{T}_-$ in the space of variables χ, χ' are the respective tubes:

$$\mathcal{T}_+ = \{(\chi, \chi') \in \mathbb{C}^2; 0 < \text{Im } \chi < \pi, 0 < \text{Im } \chi' < \pi\},$$

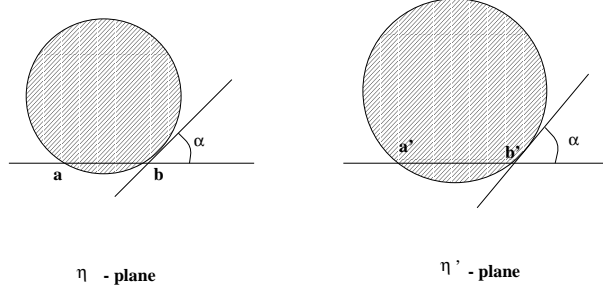

Figure A1

$$T_- = \{(\chi, \chi') \in \mathbb{C}^2; \pi < \text{Im } \chi < 2\pi, \pi < \text{Im } \chi' < 2\pi\},$$

while the image of \mathcal{R} is the set $R = \{(\chi, \chi') \in \mathbb{C}^2, \text{Im } \chi = \pi, \text{Im } \chi' = \pi\}$, which is the common edge to T_+ and T_- .

Then, in view of the tube theorem (applied in the limiting “edge of the wedge situation”, illustrated by Fig A.2), the holomorphy envelope $\mathcal{H}(T_+ \cup T_- \cup R)$ is the convex tube $\hat{T} = \bigcup_{0 \leq \alpha \leq \pi} T_\alpha$ whose basis in $(\text{Im } \chi, \text{Im } \chi')$ -space is represented on Fig A.2. The result of proposition A.1 is readily obtained by taking the inverse image \mathcal{T}_α of each tube T_α in the variables (η, η') .

Corollary A.2: The holomorphy envelope $\mathcal{H}(\Delta)$ contains all the points of the form $(\eta, 0)$, with η varying in the cut-plane $\mathbb{C} \setminus \{\eta \text{ real}; \eta \notin]a, b[\}$.

Proof: These points $(\eta, \eta' = 0)$ have images (χ, χ') such that: $0 < \text{Im } \chi < 2\pi$ and $\text{Im } \chi' = \pi$ and therefore belong to the convex tube \hat{T} (see Fig.A.2).

Propagation of bounds in the analytic completion procedure

We need the following extension of the “maximum modulus principle”.

Proposition A.3:

Let $f(\eta)$ be holomorphic in the domain $\Delta_b = \{\eta \in \mathbb{C}; |\text{Re } \eta| < b, |\text{Im } \eta| < b\}$, and continuous in the closure $\bar{\Delta}_b$ of Δ_b . Let the following majorization hold

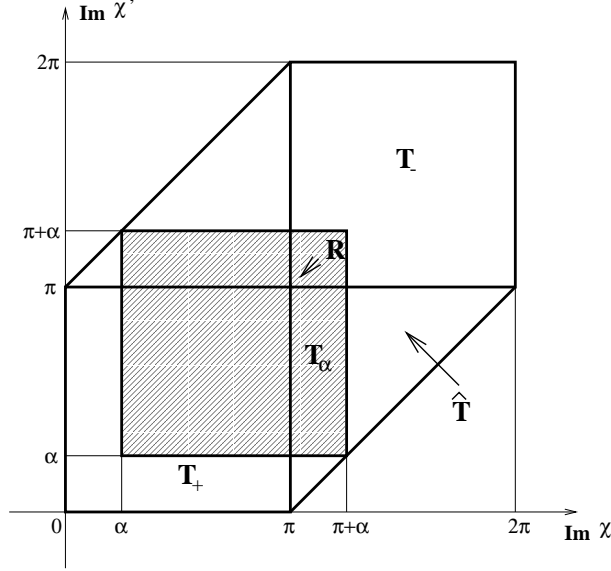

Fig. A.2

in $\bar{\Delta}_b$:

$$|f(\eta)| \leq M |\operatorname{Im} \eta|^{-n}, \quad (\text{A.1})$$

where n is a given positive number and M is a constant.

Then for all β with $-b \leq \beta \leq b$, one has:

$$|f(i\beta)| \leq \sqrt{5}^n M b^{-n} \quad (\text{A.2})$$

Proof:

One considers the function $g(\eta) = (b^2 - \eta^2)^n f(\eta)$, which is also holomorphic in Δ_b and continuous in $\bar{\Delta}_b$. One directly deduces from (A.1) the following uniform majorization for g on the boundary of Δ_b :

$$|g(\eta)| \leq 5^{\frac{n}{2}} M b^n.$$

In view of the maximum modulus principle, this majorization extends to all points in Δ_b ; by writing it at $\eta = i\beta$, one then obtains:

$$|f(i\beta)| = |g(i\beta)|(b^2 + \beta^2)^{-n} \leq 5^{\frac{n}{2}} M \left(\frac{b}{b^2 + \beta^2} \right)^n \leq 5^{\frac{n}{2}} M b^{-n}.$$

APPENDIX B

Primitives and derivatives of non-integral order in a complex domain and Laplace transformation

a being a given positive number, we define in \mathbb{C} the following subset $B_a^{(\text{cut})} = B_a \setminus \sigma$, where $B_a = \{\theta \in \mathbb{C}; \theta = u + iv, |u| < a, v \geq 0\}$ and $\sigma = \{\theta \in \mathbb{C}; \theta = iv, v \geq v_0\}$, $v_0 > 0$ (see Fig.B1).

We then introduce the space of holomorphic functions denoted $\mathcal{O}^\infty(B_a^{(\text{cut})})$ which is generated by

i) all functions $f(\theta)$ holomorphic in $B_a^{(\text{cut})}$ and satisfying bounds of the form

$$|f(u + iv)| \leq C_\eta(v) \quad (\text{B.1})$$

in the corresponding subsets

$$B_a^{(\eta)} = B_a \setminus \{\theta \in \mathbb{C}; \theta = u + iv, |u| < \eta, v > v_0 - \eta\} \quad (\text{B.2})$$

of \mathbb{C} , for all $\eta > 0$. In (B.1), $C_\eta(v)$ denotes an increasing and locally bounded function *with at most power-like behaviour* for v tending to infinity.

ii) the products of functions of the previous type by θ^ρ , with ρ *real* > 0 .

Laplace transforms

Let γ_0 and γ'_0 be two infinite paths with origin 0 in the respective half-strips $u > 0$ and $u < 0$ of B_a , and whose infinite branches are asymptotically parallel to the imaginary axis of the θ -plane. We associate with each function $f(\theta) \in \mathcal{O}^\infty(B_a^{(\text{cut})})$ the Laplace-type transforms:

$$\mathcal{L}_0(f)(\lambda) = \int_{\gamma_0} e^{i\lambda\theta} f(\theta) d\theta, \quad (\text{B.3})$$

$$\mathcal{L}'_0(f)(\lambda) = \int_{\gamma'_0} e^{i\lambda\theta} f(\theta) d\theta. \quad (\text{B.3}')$$

In view of (B.1), the latter are holomorphic in the half-plane $\mathbb{C}_+ = \{\lambda \in \mathbb{C}; \text{Re } \lambda > 0\}$ and admit bounds of the form $c_{\varepsilon,\eta} e^{\eta |\text{Im } \lambda|}$, for all $\varepsilon > 0, \eta > 0$, in the corresponding half-planes $\mathbb{C}_+^{(\varepsilon)} = \{\lambda \in \mathbb{C}; \text{Re } \lambda > \varepsilon\}$ (as it results from a suitable distortion of the paths γ_0, γ'_0 in the integrals (B.3), (B.3')).

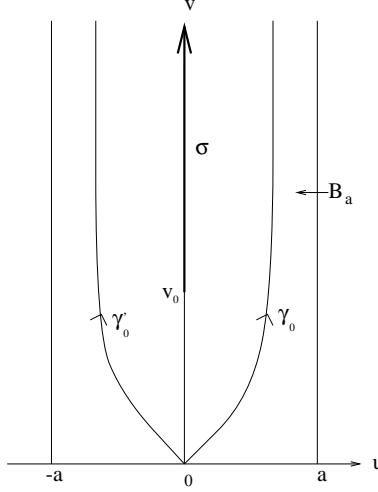

Figure B1

If f has continuous boundary values (from both sides) on σ , the corresponding discontinuity function $\Delta f(v) = i \lim_{\eta \rightarrow 0, \eta > 0} [(f(\eta + iv)) - f(-\eta + iv)]$ admits the Laplace transform:

$$L(\Delta f)(\lambda) = \mathcal{L}_0(f) - \mathcal{L}'_0(f) = \int_{\gamma_0 - \gamma'_0} e^{i\lambda\theta} f(\theta) d\theta = \int_0^\infty e^{-\lambda v} \Delta f(v) dv \quad (\text{B.4})$$

In the general case, we still say that $L(\Delta f)(\lambda) = \mathcal{L}_0(f) - \mathcal{L}'_0(f)$ represents the Laplace-transform of the discontinuity Δf of f , now considered as a hyperfunction with support σ ; $L(\Delta f)(\lambda)$ is holomorphic in \mathbb{C}_+ and such that:

$$|L(\Delta f)(\lambda)| \leq 2c_{\varepsilon, \eta} e^{-(\text{Re } \lambda - \varepsilon)(v_0 - \eta)} e^{\eta |\text{Im } \lambda|} \quad (\text{B.5})$$

in each subset $\mathbb{C}_+^{(\varepsilon)}$ of \mathbb{C}_+ , for all $\eta > 0$.

Primitives of non integral order in the complex domain

For every *real positive* α , we associate with any function $f(\theta)$ of the previous class $\mathcal{O}^\infty(B_a^{(\text{cut})})$ the following function

$$[P_\alpha f](\theta) = \frac{1}{\Gamma(\alpha)} \int_{\gamma(0, \theta)} (\theta - \theta')^{\alpha-1} f(\theta') d\theta', \quad (\text{B.6})$$

where θ varies in $B_a^{(\text{cut})}$ and $\gamma_{(0,\theta)}$ is a path with end-points $0, \theta$, (homotopous to the linear segment $[0, \theta]$) whose support is contained in $B_a^{(\text{cut})}$.

By choosing for $\gamma_{(0,\theta)}$ the linear segment $[0, \theta]$ and making the change of variables $\theta' = \theta t$, with $t \in [0, 1]$ in (B.6), one checks that each function $P_\alpha f$ is the product of the ramified function θ^α (case i)) or more generally $\theta^{\alpha+\rho}$ (case ii)) by a function holomorphic in $B_a^{(\text{cut})}$ and that it also satisfies bounds of the form (B.1) (with functions $C_\eta^\alpha(v) = v^\alpha C_\eta(v)$) and therefore belongs to the class $\mathcal{O}^\infty(B_a^{(\text{cut})})$. The same change of variables also shows that the integral (B.6) reduces to a Riemann–Liouville integral. Therefore, by using the standard properties of the latter (see [36b]), p 181-182), we obtain the following properties of the operators P_α : for all $\alpha, \beta > 0$,

$$P_\alpha \circ P_\beta = P_\beta \circ P_\alpha = P_{\alpha+\beta} \quad (\text{B.7})$$

and for all positive integers n :

$$\left(\frac{d}{d\theta}\right)^n [P_n f](\theta) = f(\theta), \quad (\text{B.8})$$

from which it follows that, for all $\alpha > n$:

$$\left(\frac{d}{d\theta}\right)^n [P_\alpha f](\theta) = [P_{\alpha-n} f](\theta). \quad (\text{B.8a})$$

These equations lead one to call $P_\alpha f$ (for general α) a “primitive of order α of f in the complex domain”.¹²

Derivatives

Since the operations $D_n = \left(\frac{d}{d\theta}\right)^n$ act on the class $\mathcal{O}^\infty(B_a^{(\text{cut})})$ for all integers n , it is natural to extend Eq.(B.8a) to the case $\alpha < n$ and to introduce the derivation D_ν of non-integral order $\nu = n - \alpha$ by the following formula:

$$D_\nu f \equiv D_n P_\alpha f = D_{n+r} P_{\alpha+r} f, \quad (\text{B.8b})$$

in which the last equality holds, in view of (B.7),(B.8), for every integer r such that $\alpha + r > 0$. We then have:

¹²Note that all the primitives $P_\alpha f$ are still well-defined (via Eq. (B.6)) for functions f such that, for some $\varepsilon > 0$, $\theta^{1-\varepsilon} f(\theta) \in \mathcal{O}^\infty(B_a^{(\text{cut})})$.

Proposition B.1

a) For any function $f(\theta)$ in $\mathcal{O}^\infty(B_a^{(\text{cut})})$ and any real positive number ν , the derivative $D_\nu f$ is the product of a function in $\bigcap_{\delta; \delta > 0} \mathcal{O}^\infty(B_{a-\delta}^{(\text{cut})})$ by $\theta^{-\nu}$.

b) Eqs (B.8a),(B.8b) admit the following generalizations, valid for all positive numbers β and ν :

$$D_\beta P_\beta f = f, \quad (\text{B.8c})$$

$$\text{if } \beta > \nu, \quad D_\nu P_\beta = P_{\beta-\nu}, \quad (\text{B.8d})$$

$$\text{if } \beta < \nu, \quad D_\nu P_\beta = D_{\nu-\beta}. \quad (\text{B.8e})$$

c) If the function $f(\theta)$ is holomorphic in $B_a^{(\text{cut})}$, then for all $\alpha > 0$ and for all positive integers n , one has:

$$[D_n P_\alpha f](\theta) - [P_\alpha D_n f](\theta) = \theta^{\alpha-n} \sum_{p=0}^{n-1} [D_p f](0) \frac{\theta^p}{\Gamma(\alpha - n + p + 1)} \quad (\text{B.9})$$

and for all $\rho > 0$:

$$DP_\alpha(\theta^\rho f) = P_\alpha D(\theta^\rho f). \quad (\text{B.9}')$$

Proof:

a) Since $D_\nu f = D_n P_\alpha f$, with $\nu = n - \alpha$, and since $P_\alpha f$ is the product of θ^α by a function in $\mathcal{O}^\infty(B_a^{(\text{cut})})$ (for any $\alpha > 0$ and f in $\mathcal{O}^\infty(B_a^{(\text{cut})})$), the usual derivation D_n yields the analytic structure with the factor $\theta^{-\nu}$ and the Cauchy inequalities imply bounds of the form (B.1) in $B_{a-\delta}^{(\text{cut})}$, for all $\delta > 0$.

b) In view of (B.8b) and (B.7), one can always write: $D_\nu P_\beta = D_n P_{\alpha+\beta}$ with $\nu = n - \alpha$, n integer, Applying Eqs (B.8) or (B.8a) or the definition (B.8b) according to whether $n = \alpha + \beta$ or $n < \alpha + \beta$ or $n > \alpha + \beta$ yields respectively Eqs (B.8c),(B.8d) and (B.8e).

c) If f is holomorphic at the origin, one can apply integration by parts to Eq.(B.6) with f replaced by any derivative $D_p f$ (with $0 \leq p \leq n - 1$); one gets:

$$[P_\alpha D_p f](\theta) = [P_{\alpha+1} D_{p+1} f](\theta) + [D_p f](0) \frac{\theta^\alpha}{\Gamma(\alpha + 1)},$$

and therefore in view of (B.8a):

$$[D_{n-p} P_\alpha D_p f](\theta) = [D_{n-p-1} P_\alpha D_{p+1} f](\theta) + [D_p f](0) \frac{\theta^{\alpha-n+p}}{\Gamma(\alpha - n + p + 1)}.$$

Using the latter recursively with $0 \leq p \leq n-1$ then yields Eq.(B.9). Eq.(B.9') is obtained as (B.9) for $n = 1$, the r.h.s. of (B.9') being still meaningful (see footnote 11) since $\theta^{1-\rho}D(\theta^\rho f)$ belongs to $\mathcal{O}^\infty(B_{a-\delta}^{(\text{cut})})$ (for all $\delta > 0$).

Remark: Property c) extends the usual Taylor expansion (obtained for $\alpha = n$ in Eq.(B.9)). In particular, the holomorphic (ramified) function at the r.h.s. of Eq. (B.9) has no discontinuity across σ ; therefore, $D_n P_\alpha f$ and $P_\alpha D_n f$ have “the same discontinuity” across σ (i.e. represent the same hyperfunction with support σ) which we denote $P_{\alpha-n}\Delta f$ when $n < \alpha$ and $D_{n-\alpha}\Delta f$ when $n > \alpha$. Since $D_n f$ is holomorphic at the origin, $P_\alpha D_n f$ belongs to $\mathcal{O}^\infty(B_{a-\delta}^{(\text{cut})})$ (for all $\delta > 0$). In other words, if f (in $\mathcal{O}^\infty(B_a^{(\text{cut})})$) is holomorphic at the origin, all the hyperfunctions $D_\nu \Delta f$ admit a representative in $\bigcap_{\delta; \delta>0} \mathcal{O}^\infty(B_{a-\delta}^{(\text{cut})})$.

Laplace transforms of the primitives $P_\alpha f$ and derivatives $D_\nu f$:

We first notice that since all the primitives $P_\alpha f$ of a function f in $\mathcal{O}^\infty(B_a^{(\text{cut})})$ remain in the same space, they all admit well-defined Laplace-type transforms $\mathcal{L}_0(P_\alpha f)$, $\mathcal{L}'_0(P_\alpha f)$ (defined via Eqs (B.3), (B.3')). On the contrary, the operations \mathcal{L}_0 and \mathcal{L}'_0 do not act in general on the corresponding derivatives $D_\nu f$, since the latter may contain non-integrable factors θ^ϱ (with $\varrho \leq -1$). However, the Laplace transforms $L(\Delta D_\nu f) \equiv L(D_\nu \Delta f)$ are always well-defined via the following procedure. One uses the fact that for functions f (and $P_\alpha f$) in $\mathcal{O}^\infty(B_a^{(\text{cut})})$, the defining formula (B.4) can be alternatively replaced by $L(\Delta f)(\lambda) = \int_\gamma e^{i\lambda\theta} f(\theta) d\theta$, where γ is a cycle homotopous to $\gamma_0 - \gamma'_0$ in $B_a^{(\text{cut})}$ whose support avoids the origin (i.e. lies in the interior of $B_a^{(\text{cut})}$). Since each derivative $D_\nu f = D_n P_\alpha f$ is holomorphic and of power-like growth at infinity in the interior of $B_a^{(\text{cut})}$, the previous formula applies and defines

$$L(D_\nu \Delta f)(\lambda) = \int_\gamma e^{i\lambda\theta} [D_\nu f](\theta) d\theta \quad (\text{B.10})$$

as a holomorphic function in \mathbb{C}_+ .

The following statement extends to the primitives P_α and derivatives D_ν the usual property of Laplace transforms.

Proposition B.2 For any holomorphic function $f(\theta)$ in the space $\mathcal{O}^\infty(B_a^{(\text{cut})})$ and for the corresponding (hyperfunction) discontinuity Δf , there holds the following property of the Laplace transforms in the half-plane \mathbb{C}_+ :

a) for all $\alpha > 0$,

$$\begin{aligned}\mathcal{L}_0(P_\alpha f)(\lambda) &= e^{\frac{i\pi}{2}\alpha} \lambda^{-\alpha} \mathcal{L}_0(f)(\lambda), & \mathcal{L}'_0(P_\alpha f)(\lambda) &= e^{\frac{i\pi}{2}\alpha} \lambda^{-\alpha} \mathcal{L}'_0(f)(\lambda), \\ L(P_\alpha \Delta f)(\lambda) &= e^{\frac{i\pi}{2}\alpha} \lambda^{-\alpha} L(\Delta f)(\lambda),\end{aligned}\tag{B.11}$$

b) for all $\nu > 0$,

$$L(D_\nu \Delta f)(\lambda) = e^{-\frac{i\pi}{2}\nu} \lambda^\nu L(\Delta f)(\lambda).\tag{B.12}$$

Proof: a) It is sufficient to prove the first equation in (B.11); the r.h.s. of this equation can be written for all $\alpha > 0$:

$$\mathcal{L}_0(P_\alpha f)(\lambda) = \frac{1}{\Gamma(\alpha)} \int_{\gamma_0} e^{i\lambda\theta} d\theta \int_{\gamma_{(0,\theta)}} (\theta - \theta')^{\alpha-1} f(\theta') d\theta' \tag{B.13}$$

For simplicity, we choose γ_0 such that its support is a *convex* (infinite) curve (see Fig.B1) and we specify $\gamma_{(0,\theta)}$ by the condition that its support is contained in the support of γ_0 . For λ in \mathbb{C}_+ , the integral in (B.13) is absolutely convergent and can be rewritten (by inverting the integrations and putting $\theta'' = \theta - \theta'$) :

$$\mathcal{L}_0(P_\alpha f)(\lambda) = \frac{1}{\Gamma(\alpha)} \int_{\gamma_0} e^{i\lambda\theta'} f(\theta') d\theta' \int_{\gamma_0(\theta')} e^{i\lambda\theta''} (\theta'')^{\alpha-1} d\theta'', \tag{B.14}$$

where the support of $\gamma_0(\theta')$ is the set $\{\theta'' \in \mathbb{C}; \theta'' + \theta' \in \text{supp } \gamma_0 \setminus \text{supp } \gamma_{(0,\theta')}\}$. Since this (infinite) path $\gamma_0(\theta')$ is homotopous to $[0, i\infty[$, the subintegral of (B.14) is independent of θ' and equal to $e^{i\frac{\pi}{2}\alpha} \int_0^\infty e^{-\lambda v} v^{\alpha-1} dv = \frac{e^{\frac{i\pi}{2}\alpha} \Gamma(\alpha)}{\lambda^\alpha}$.

b) Let $\nu = n - \alpha$, with $\alpha < n$; in view of (B.10), we have:

$$\begin{aligned}L(D_\nu \Delta f)(\lambda) &= L(D_n P_\alpha \Delta f)(\lambda) = \int_\gamma e^{i\lambda\theta} [D_n(P_\alpha f)](\theta) d\theta \\ &= (-i\lambda)^n \int_\gamma e^{i\lambda\theta} [P_\alpha f](\theta) d\theta = (-i\lambda)^n L(P_\alpha \Delta f)(\lambda).\end{aligned}$$

Eq.(B.12) then readily follows from the latter and from (B.11).

The case of distribution-like boundary values on σ

We shall now restrict our attention to functions of the class $\mathcal{O}^\infty(B_a^{(\text{cut})})$ which are “of moderate growth” near the cut σ . More precisely, we introduce for each real number β , with $\beta \geq 0$, the class $\mathcal{O}^\beta(B_a^{(\text{cut})})$ by the same definition as $\mathcal{O}^\infty(B_a^{(\text{cut})})$, except for the uniform bounds (B.1) which are replaced by:

$$|f(u + iv)| \leq \frac{C(v)}{\eta^\beta}, \quad (\text{B.15})$$

in the corresponding subsets $B_a^{(\eta)}$ of B_a , ($C(v)$ being again a locally bounded function with power-like behaviour for v tending to infinity).

When the bounds (B.15) are replaced by logarithmic bounds of the form:

$$|f(u + iv)| \leq C(v) |\ln \eta|; \quad (\text{B.16})$$

the corresponding class of holomorphic functions $f(\theta)$ is called $\mathcal{O}^{0*}(B_a^{(\text{cut})})$.

We also need to consider functions f of the class $\mathcal{O}^0(B_a^{(\text{cut})})$ which have *continuous boundary values on σ , as well as all their derivatives $D_{\nu'} f$ for all $\nu' < \nu$, ν being a given positive number. If moreover each of these derivatives $D_{\nu'} f$ is the product of a function in $\bigcap_{\delta; \delta > 0} \mathcal{O}^0(B_{a-\delta}^{(\text{cut})})$ by $\theta^{-\nu'}$, we say that f*

belongs to the class $\mathcal{O}_\nu(B_a^{(\text{cut})})$. Functions in these classes satisfy the

Proposition B.3 If f belongs to $\mathcal{O}_\nu(B_a^{(\text{cut})})$, then the Laplace transform $L(\Delta f)$ of the discontinuity Δf of f satisfies uniform bounds of the following form

$$|L(\Delta f)(\lambda)| \leq c_{\varepsilon\varepsilon'} |\lambda|^{-\nu+\varepsilon'} e^{-(\text{Re } \lambda - \varepsilon)v_0} \quad (\text{B.17})$$

in the corresponding half-planes $\mathbb{C}_+^{(\varepsilon)}$, for all $\varepsilon > 0, \varepsilon' > 0$.

Proof: In view of proposition B.2 b), we can write for any $\varepsilon' > 0$:

$$L(D_{\nu-\varepsilon'} \Delta f)(\lambda) = e^{i\frac{\pi}{2}(\varepsilon'-\nu)} \lambda^{\nu-\varepsilon'} L(\Delta f)(\lambda). \quad (\text{B.18})$$

Since $|[D_{\nu-\varepsilon'} f](u + iv)| \leq C(v)$, for $|u| < a - \delta$, $v > \delta$ (with $0 < \delta < v_0$), the expression of $L(D_{\nu-\varepsilon'} \Delta f)(\lambda)$ given by (B.10) (with γ flattened onto σ from both sides) can be uniformly bounded in modulus by $c_{\varepsilon\varepsilon'} e^{-(\text{Re } \lambda - \varepsilon)v_0}$ in any half-plane $\mathbb{C}_+^{(\varepsilon)}$ ($\varepsilon > 0$). This implies the bound (B.17) in view of Eq.(B.18).

We now study the properties of the functions in the classes $\mathcal{O}^\beta(B_a^{(\text{cut})})$, $\beta \geq 0$, and $\mathcal{O}^{0*}(B_a^{(\text{cut})})$ and characterize in a precise way their distribution-like boundary values on the cut σ and their Laplace transforms.

Proposition B.4 Let $f(\theta)$ belong to a class $\mathcal{O}^\beta(B_a^{(\text{cut})})$, with $\beta \geq 0$, or (for $\beta = 0$) to $\mathcal{O}^{0*}(B_a^{(\text{cut})})$. Then

i) The various “primitives” $P_\alpha f$ ($\alpha > 0$) satisfy the following properties:

- a) if $\alpha < \beta$, $P_\alpha f$ belongs to the class $\mathcal{O}^{\beta-\alpha}(B_a^{(\text{cut})})$,
- b) if $\alpha = \beta$, $P_\alpha f$ belongs to the class $\mathcal{O}^{0*}(B_a^{(\text{cut})})$,
- c) if $\alpha > \beta$, $P_\alpha f$ belongs to the class $\mathcal{O}_{\alpha-\beta}(B_a^{(\text{cut})})$;

ii) The boundary values f_+ , f_- of f on $i\mathbb{R}$ from the respective sides $\text{Re } \theta > 0$, $\text{Re } \theta < 0$, and the corresponding discontinuity $\Delta f = i(f_+ - f_-)$ (with support contained in σ) are defined in the sense of distributions and such that

$$f_\pm = D_p F_\pm, \quad \Delta f = D_p \Delta F,$$

with F_\pm continuous on $i\mathbb{R}$, $\text{supp } \Delta F \subset \sigma$ and $p = E(\beta) + 1$;

iii) The Laplace transform $L(\Delta f)$ of the distribution Δf satisfies uniform bounds of the following form (for all $\varepsilon > 0, \varepsilon' > 0$)

$$|L(\Delta f)(\lambda)| \leq c_{\varepsilon\varepsilon'} |\lambda|^{\beta+\varepsilon'} e^{-(\text{Re } \lambda - \varepsilon)v_0} \quad (\text{B.19})$$

in the corresponding half-planes $\mathbb{C}_+^{(\varepsilon)}$.

Proof:

i) For all α ($\alpha > 0$), the expression (B.6) of $[P_\alpha f](\theta)$ can be rewritten with the following choice: $\text{supp } \gamma_{(0,\theta)} = [0, b] \cup [b, b + iv] \cup [b + iv, u + iv]$, where $\theta = u + iv$ and b is a fixed number such that $0 < |b| < a$. As seen below, this choice is suitable for showing that $[P_\alpha f](\theta)$ satisfies bounds of the form (B.15) or (B.16) on the part $u = \pm\eta$, $v \geq v_0 - \eta$ of the border of a given region $B_a^{(\eta)}$ (estimates on the remaining “small” part $|u| < \eta$, $v = v_0 - \eta$ are similar ¹³).

¹³For $|u| < \eta$, $v = v_0 - \eta$, one chooses the path with support $[0, u] \cup [u, u + i(v_0 - \eta)]$, which yields two contributions to (B.6): while the first one is bounded by a constant, the second one is bounded (up to a constant factor) by the same integral as in (B.20) or (B.20') whose dependence on η yields the desired result.

Let us first assume that f belongs to $\mathcal{O}^\beta(B_a^{(\text{cut})})$, with $\beta \geq 0$. In view of (B.15), one readily obtains that the first two contributions to $[P_\alpha f](\theta)$ (given by the integrations on $[0, b]$ and $[b, b + iv]$) admit uniform bounds of the form $c(v)$, where $c(v)$ is locally bounded and power-like behaved for v tending to infinity. The third contribution (given by the interval $[b + iv, u + iv]$) can be majorized by the following expression (written for the case $0 < u = \eta < b$):

$$\frac{1}{\Gamma(\alpha)} C(v) \int_\eta^b (u' - \eta)^{\alpha-1} (u')^{-\beta} du'. \quad (\text{B.20})$$

a) If $\alpha < \beta$, the integral in (B.20) is bounded by $\text{cst } \eta^{-(\beta-\alpha)}$ and therefore $P_\alpha f$ belongs to $\mathcal{O}^{\beta-\alpha}(B_a^{(\text{cut})})$.

b) If $\alpha = \beta$, the integral in (B.20) is bounded by $\text{cst } |\ln \eta|$. This shows that $P_\beta f$ belongs to the class $\mathcal{O}^{0*}(B_a^{(\text{cut})})$.

c) If $\alpha > \beta$, the integral in (B.20) is bounded by a constant and therefore $P_\alpha f$ belongs to $\mathcal{O}^0(B_a^{(\text{cut})})$. In order to show that $P_\alpha f$ admits *continuous* boundary values on σ , one writes $P_\alpha f = P_\varepsilon P_{\alpha-\varepsilon} f$ for a given $\varepsilon > 0$ such that $\alpha - \varepsilon > \beta$. Since $g = P_{\alpha-\varepsilon} f$ is then itself in $\mathcal{O}^0(B_a^{(\text{cut})})$, one is led to apply directly the following result to the expression (B.6) of $[P_\varepsilon g](\theta)$ (with the choice of the linear segment $[0, \theta]$ for $\text{supp } \gamma(0, \theta)$, θ being either in $B_a^{(\text{cut})}$ or on the cut σ): for every $\varepsilon > 0$, the Abel transform $g_\varepsilon(x) = \int_0^x f(y) (x-y)^{\varepsilon-1} dy$ of a locally bounded function f is continuous. Moreover the previous argument holds for every derivative $D_{\nu'}(P_\alpha f)$ such that $\nu' < \alpha - \beta$, since in this case (in view of (B.8d)) $D_{\nu'}(P_\alpha f) = P_{\alpha-\nu'} f$. We have thus proved that $P_\alpha f$ belongs to the class $\mathcal{O}_{\alpha-\beta}(B_a^{(\text{cut})})$.

In order to complete the study of the case c), let us now assume that f belongs to $\mathcal{O}^{0*}(B_a^{(\text{cut})})$; in view of (B.16), the majorization (B.20) on the third contribution to $[P_\alpha f](\theta)$ is now replaced by

$$\frac{1}{\Gamma(\alpha)} C(v) \int_\eta^b (u' - \eta)^{\alpha-1} |\ln u'| du' \quad (\text{B.20}')$$

which is bounded by $\text{cst } C(v)$. This proves that $P_\alpha f$ belongs to $\mathcal{O}^0(B_a^{(\text{cut})})$, and since the result holds for every α' , with $0 < \alpha' < \alpha$, the same argument as above in c) shows that $P_\alpha f$ belongs to the class $\mathcal{O}_\alpha(B_a^{(\text{cut})})$ for all $\alpha > 0$.

ii) If f belongs to a class $\mathcal{O}^\beta(B_a^{(\text{cut})})$, or also (for $\beta = 0$), to $\mathcal{O}^{0*}(B_a^{(\text{cut})})$, let $p = E(\beta) + 1$; it follows from i)c) that the function $F = P_p f$ admits

continuous boundary values F_+, F_- on σ . Then it results from the standard definition of distribution-like boundary values of holomorphic functions that the function $f(\theta) = \left(\frac{d}{d\theta}\right)^p F(\theta)$ admits boundary values on σ which are the corresponding derivatives *in the sense of distributions* $f_{\pm} = \left(\frac{1}{i} \frac{d}{dv}\right)^p F_{\pm}$ denoted $D_p F_{\pm}$. Since $F_{+}[0, v_0[= F_{-}[0, v_0[$, the discontinuity $\Delta F = i(F_+ - F_-)$ of F is a continuous function with support contained in σ , which yields the desired structure for the distribution $\Delta f = D_p \Delta F$.

iii) Let us consider, for any $\varepsilon' > 0$, the Laplace transform $L(P_{\beta+\varepsilon'} \Delta f)$; in view of i)c), $P_{\beta+\varepsilon'} \Delta f$ is a continuous function with support contained in σ and satisfying a bound of the following form:

$$|[P_{\beta+\varepsilon'} \Delta f](v)| \leq C_{\varepsilon'}(v),$$

where $C_{\varepsilon'}(v)$ has power-like behaviour at infinity.

Therefore the corresponding expression of $L(P_{\beta+\varepsilon'} \Delta f)(\lambda)$ given by (B.4) can be uniformly bounded by $c_{\varepsilon'} e^{-(\operatorname{Re} \lambda - \varepsilon)v_0}$ in any half-plane $\mathbb{C}_+^{(\varepsilon)}$ ($\varepsilon > 0$). Since we have (in view of Proposition B.2, Eq.(B.11)):

$$L(\Delta f)(\lambda) = e^{-\frac{i\pi}{2}(\beta+\varepsilon')\lambda^{\beta+\varepsilon'}} L(P_{\beta+\varepsilon'} \Delta f)(\lambda),$$

the majorization (B.19) follows from the previous bound on $L(P_{\beta+\varepsilon'} \Delta f)$.

We now complete the statements of Proposition B.4 i) by considering the action of derivatives D_{ν} of arbitrary order ν .

Proposition B.5

Let $f(\theta)$ belong to a class $\mathcal{O}^{\beta}(B_a^{(\text{cut})})$, with $\beta \geq 0$. Then, for all $\nu > 0$, the product $\theta^{\nu} D_{\nu} f(\theta)$ belongs to the class $\mathcal{O}^{\beta+\nu}(B_{a-\delta}^{(\text{cut})})$ for any $\delta > 0$.

Proof Putting $\nu = n - \alpha$, with n integer and $0 < \alpha < 1$, we can write in view of Eqs (B.9),(B.9'):

$$[D_{\nu} f](\theta) = [D_n P_{\alpha} f](\theta) = [D_{n-1}(P_{\alpha} D f)](\theta) + f(0) \frac{\theta^{-\nu}}{\Gamma(1-\nu)}.$$

Since the second term at the r.h.s. of this equation has no discontinuity across σ , we are led to prove that if f belongs to $\mathcal{O}^{\beta}(B_a^{(\text{cut})})$, then $D_{n-1}(P_{\alpha} D f)$

belongs to $\mathcal{O}^{\beta+\nu}(B_{a-\delta}^{(\text{cut})})$ for any $\delta > 0$. At first, simple estimates based on the Cauchy formula for the derivative of a holomorphic function show that Df belongs to $\mathcal{O}^{\beta+1}(B_{a-\delta}^{(\text{cut})})$ for all $\delta > 0$. Then, since $\alpha < 1 < \beta+1$, the case a) of Proposition B.4 i) applies to $P_\alpha Df$ and implies that this function belongs to the corresponding classes $\mathcal{O}^{\beta+1-\alpha}$; applying now again the Cauchy formula to the derivative D_{n-1} of the previous function implies that $D_{n-1}(P_\alpha Df)$ belongs to $\mathcal{O}^{\beta-\alpha+n}(B_{a-\delta}^{(\text{cut})})$ for all $\delta > 0$.

The rest of this Appendix is devoted to proving the following result which is of direct use for our Theorem 3 (see Sec 4). Although very close to Proposition B.4 i) in its form, this result is technically more sophisticated since its statement involves conjointly primitives \mathbf{P}_α with respect to the complex variable $z = \cos \theta$, together with the previous derivatives D_ν with respect to θ (involved in the definition of the classes $\mathcal{O}_{\alpha-\beta}(B_\pi^{(\text{cut})})$ used again below).

Proposition B.6

Let α, β and m be fixed real numbers such that $\alpha > 0$, $\beta \geq 0$ and $m > -1$. With each function f holomorphic in $B_\pi^{(\text{cut})}$ and such that:

i) f satisfies uniform bounds of the following form

$$|f(\theta)| \leq \frac{C e^{m \text{Im} \theta}}{\eta^\beta}$$

in all the corresponding subsets $B_\pi^{(\eta)}$ of $B_\pi^{(\text{cut})}$,

ii) $f(u) = f(-u)$ for $0 \leq u \leq \pi$,

one associates the following function:

$$\hat{f}_m^{(\alpha)}(\theta) = e^{i(m+\alpha)\theta} \frac{1}{\Gamma(\alpha)} \int_{-1}^{\cos \theta} (\cos \theta - \cos \tau)^{\alpha-1} f(\tau) d \cos \tau, \quad (B.21)$$

where θ varies in $B_\pi^{(\text{cut})}$.

Then

- a) If $\alpha < \beta$, $\hat{f}_m^{(\alpha)}$ belongs to the class $\mathcal{O}^{\beta-\alpha}(B_\pi^{(\text{cut})})$,
- b) If $\alpha = \beta$, $\hat{f}_m^{(\alpha)}$ belongs to the class $\mathcal{O}^{0*}(B_\pi^{(\text{cut})})$,
- c) If $\alpha > \beta$, $\hat{f}_m^{(\alpha)}$ belongs to the class $\mathcal{O}_{\alpha-\beta}(B_\pi^{(\text{cut})})$.

The proof of the latter relies on two auxiliary lemmas, for which we need the following notations. Let $\mathbb{C}_A = \mathbb{C} \setminus \{z \text{ real}; z \geq A\} \setminus \{z \text{ real}; z \leq -1\}$ with $A \geq 1$. For every function $\underline{f}(z)$, holomorphic in \mathbb{C}_A and continuous on the cut $z \leq -1$, and for every $\alpha > 0$, we put

$$[\underline{P}_\alpha \underline{f}](z) = \frac{1}{\Gamma(\alpha)} \int_{-1}^z \underline{f}(z') (z - z')^{\alpha-1} dz'. \quad (\text{B.22})$$

By choosing $A = \cosh v_0$, the cut-plane \mathbb{C}_A appears as the image of the set $B_\pi^{(\text{cut})}$ by the mapping $z = \cos \theta$. Considering the function $f(\theta) = \underline{f}(\cos \theta)$, holomorphic in $B_\pi^{(\text{cut})}$ (and such that $f(u) = f(-u)$ for $-\pi \leq u \leq \pi$), we then also put:

$$[\mathbf{P}_\alpha f](\theta) = [\underline{P}_\alpha \underline{f}](\cos \theta) = -\frac{1}{\Gamma(\alpha)} \int_\pi^\theta (\cos \theta - \cos \tau)^{\alpha-1} f(\tau) \sin \tau d\tau \quad (\text{B.23})$$

Lemma B.7 closely parallels the results of Proposition B.4 i) but it involves primitives \underline{P}_α taken in the cut-plane \mathbb{C}_A and a corresponding new specification of the increase properties of the holomorphic functions considered.

Lemma B.7

Let $\underline{f}(z)$, holomorphic in \mathbb{C}_A and continuous on the cut $z \leq -1$, satisfy uniform bounds of the following form

$$|\underline{f}(z)| \leq \frac{C(1+|z|)^m}{\phi^\beta}, \quad \text{with } m > -1 \text{ and } \beta \geq 0 \quad (\text{B.24})$$

in the corresponding regions (see Fig.B2)

$$\mathbb{C}_A^{(\phi)} = \mathbb{C}_A \setminus \left\{ z \in \mathbb{C}; z = \rho e^{i\psi}, \rho > A\left(1 - \frac{\phi}{\pi}\right), |\psi| < \phi \right\}$$

for all ϕ ($0 < \phi < \pi$).

Then $[\underline{P}_\alpha \underline{f}](z)$ is holomorphic in \mathbb{C}_A and satisfies uniform bounds of the following form for $z \in \mathbb{C}_A^{(\phi)}$:

a) If $\alpha < \beta$,

$$|[\underline{P}_\alpha \underline{f}](z)| \leq \frac{C_\alpha (1+|z|)^{m+\alpha}}{\phi^{\beta-\alpha}} \quad (\text{B.25})$$

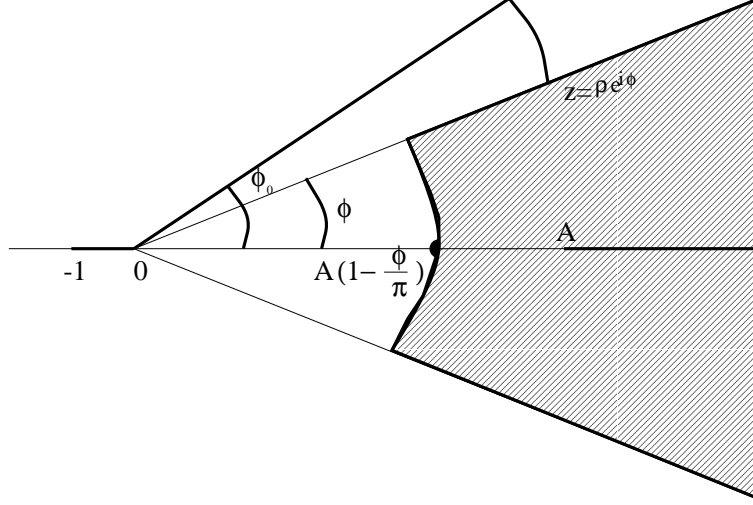

Figure B2

b) If $\alpha = \beta$,

$$|[\underline{P}_\alpha \underline{f}](z)| \leq C_\alpha (1 + |z|)^{m+\alpha} |\ln \phi| \quad (B.26)$$

c) If $\alpha > \beta$,

$$|[\underline{P}_\alpha \underline{f}](z)| \leq C_\alpha (1 + |z|)^{m+\alpha} \quad (B.27)$$

and $[\underline{P}_\alpha \underline{f}](z)$ is continuous in the closure of \mathbb{C}_A (from both sides of the cuts).

Proof: In order to obtain the bounds (B.25)...(B.27), it is sufficient to consider two typical geometrical situations :

i) z is of the form $z = A(1 - \frac{\phi}{\pi})e^{i\psi}$, with $0 \leq |\psi| \leq \phi$; the integration path in (B.22) is then chosen as the union of two linear paths with supports $\{z' \text{ real}; -1 \leq z' \leq 0\}$ and $\{z' \in \mathbb{C}; z' = A(1 - \frac{\phi'}{\pi})e^{i\psi}, \phi \leq \phi' \leq \pi\}$. By using the assumption (B.24), one checks that the first contribution to $[\underline{P}_\alpha \underline{f}](z)$ is bounded by a constant, while the second one is majorized (up to a constant factor) by $\int_\phi^\pi (\phi' - \phi)^{\alpha-1} (\phi')^{-\beta} d\phi'$, which is of the same form as the integral in (B.20). In view of the analysis after (B.20) (cases a), b), c)), we then obtain the corresponding bounds (B.25)...(B.27) (with $|z|^{m+\alpha}$ replaced by a constant).

ii) z is of the form $z = \rho e^{i\phi}$, with $\rho > A(1 - \frac{\phi}{\pi})$; the integration path in (B.22) is then chosen as the union of three paths (see Fig.B2) with respective supports $\{z' \text{ real; } -1 \leq z' \leq 0\}$, $\{z' = \rho' e^{i\phi_0}; 0 \leq \rho' \leq \rho\}$ and $\{z' = \rho e^{i\phi'}; \phi \leq \phi' \leq \phi_0\}$ (ϕ_0 being a fixed angle with $0 < \phi_0 \leq \pi$). In view of (B.24), the corresponding first two contributions to $\underline{P}_\alpha f(z)$ are majorized respectively by $cst|z|^{\alpha-1}$ and $cst|z|^{m+\alpha}$ and therefore (since $m > -1$) both by $cst|z|^{m+\alpha}$. The contribution given by the third path is majorized by $cst|z|^{m+\alpha} \int_\phi^{\phi_0} (\phi' - \phi)^{\alpha-1} (\phi')^{-\beta} d\phi'$. By applying again the results described after Eq.(B.20), we then obtain the majorizations (B.25)...(B.27) in the corresponding cases a), b) and c). Finally the continuity of $\underline{P}_\alpha f$ on σ (from both sides) in case c) is again justified as in Proposition B.4.

Lemma B.8 shows that the identity $h(\theta) = \frac{d}{d\theta} [P_{1-\nu}(P_\nu h)](\theta)$ is replaced by an equally regular operation when P_ν is replaced by \mathbf{P}_ν and intertwining exponentials are added.

Lemma B.8

For every function $h(\theta)$ holomorphic and uniformly bounded in $B_\pi^{(\text{cut})}$ and admitting continuous boundary values on σ , the following transform

$$[K_{\nu,\mu,r}h](\theta) = \frac{d}{d\theta} [P_{1-\nu} (e^{i(r+\mu)\theta} \mathbf{P}_\nu (e^{-i(\mu-\nu)\theta} h))] (\theta)$$

is the product of a function in $\bigcap_{\delta; \delta > 0} \mathcal{O}^0(B_{\pi-\delta}^{(\text{cut})})$ by $\theta^{-\nu}$, and also admits continuous boundary values on σ , provided one has $0 < \nu < 1$, $\mu > \nu - 1$, $r \geq 0$.

Proof:

In view of Eqs (B.6) and (B.23), we have:

$$[K_{\nu,\mu,r}h](\theta) = \frac{-1}{\Gamma(1-\nu)\Gamma(\nu)} \frac{d}{d\theta} \int_0^\theta (\theta - \theta')^{-\nu} e^{i(r+\mu)\theta'} d\theta' \dots$$

$$\dots \left[\int_\pi^{\theta'} (\cos \theta' - \cos \tau)^{\nu-1} e^{-i(\mu-\nu)\tau} h(\tau) \sin \tau d\tau \right] \quad (\text{B.28})$$

which is well-defined for $0 < \nu < 1$ and can be rewritten as a sum of two terms

$$[K_{\nu,\mu,r}h](\theta) = h_1(\theta) + h_2(\theta) \quad (\text{B.29})$$

corresponding to the following splitting of the integral over τ : $\int_{\pi}^{\theta'} = \int_0^{\theta'} + \int_{\pi}^0$. We shall then study h_1 and h_2 separately and prove that they both satisfy the property to be shown for $K_{\nu,\mu,r}h$.

We first treat the term h_1 by inverting the order of the integrations over θ' and τ , which yields:

$$h_1(\theta) = -\frac{d}{d\theta} \int_0^{\theta} \mathcal{K}(\theta, \tau) e^{i(r+\nu)\tau} h(\tau) \sin \tau d\tau, \quad (\text{B.30})$$

where the kernel \mathcal{K} is defined as follows:

$$\mathcal{K}(\theta, \tau) = \frac{1}{\Gamma(1-\nu)\Gamma(\nu)} \int_{\tau}^{\theta} (\theta - \theta')^{-\nu} (\cos \theta' - \cos \tau)^{\nu-1} e^{i(r+\mu)(\theta' - \tau)} d\theta'. \quad (\text{B.31})$$

The validity of Eq (B.30) is submitted to the proof of the regularity of \mathcal{K} given below; in particular, the following alternative to Eq.(B.30) will be justified after checking the regularity of \mathcal{K} on the diagonal:

$$h_1(\theta) = -\mathcal{K}(\theta, \theta) e^{i(r+\nu)\theta} h(\theta) \sin \theta - \int_0^{\theta} \frac{\partial \mathcal{K}}{\partial \theta}(\theta, \tau) e^{i(r+\nu)\tau} h(\tau) \sin \tau d\tau. \quad (\text{B.32})$$

Study of \mathcal{K} : by putting $\theta' = \tau + t(\theta - \tau)$ and passing to the integration variable t ($0 \leq t \leq 1$) in Eq.(B.31), we can rewrite the latter as follows:

$$\mathcal{K}(\theta, \tau) = \frac{1}{\Gamma(1-\nu)\Gamma(\nu)} \int_0^1 \Phi \left(\tau, \frac{t(\theta - \tau)}{2} \right) e^{i(r+\mu)t(\theta - \tau)} (1-t)^{-\nu} t^{\nu-1} dt, \quad (\text{B.33})$$

where:

$$\Phi(\tau, \zeta) = \left[-\frac{\sin \zeta}{\zeta} \sin(\tau + \zeta) \right]^{\nu-1}. \quad (\text{B.34})$$

One immediately obtains that $\mathcal{K}(\theta, \theta) = \Phi(\theta, 0) = (-\sin \theta)^{\nu-1}$, so that the first contribution to $h_1(\theta)$ in Eq.(B.32) is equal to $(-\sin \theta)^{\nu} e^{i(r+\nu)\theta} h(\theta)$. Since h is holomorphic and bounded, this function belongs to $\mathcal{O}^0(B_{\pi}^{\text{cut}})$ (under the assumptions $\nu > 0$ and $r \geq 0$); it also admits continuous boundary values on σ like h . One notices that this contribution is the exact analogue of the reproducing expression $\frac{d}{d\theta} [P_{1-\nu}(P_{\nu}h)](\theta) = h(\theta)$.

The study of the second contribution to Eq.(B.32) relies on the following expression of $\frac{\partial \mathcal{K}}{\partial \theta}$ (deduced from (B.33)):

$$\frac{\partial \mathcal{K}}{\partial \theta}(\theta, \tau) = \frac{1}{\Gamma(1-\nu)\Gamma(\nu)} \dots$$

$$\int_0^1 \left\{ i(r + \mu)\Phi(\tau, \zeta) + \frac{1}{2} \frac{\partial \Phi}{\partial \zeta}(\tau, \zeta) \right\} \Big|_{\zeta = \frac{t(\theta - \tau)}{2}} e^{i(r + \mu)t(\theta - \tau)} (1 - t)^{-\nu} t^\nu dt. \quad (\text{B.35})$$

Since $\nu - 1 < 0$, Eq.(B.34) implies that the expression inside the bracket $\{\dots\}$ in the latter integral is (for each $t \in [0, 1]$) a holomorphic function of τ and θ in the domain $\Delta = \{(\theta, \tau) \in \mathbf{C}^2; \theta \in B_\pi, \tau \in B_\pi, 0 < \text{Im}\tau < \text{Im}\theta\}$ which is uniformly bounded by $cst \tau^{\nu-2} e^{(t\text{Im}(\theta - \tau) + \text{Im}\tau)(\nu-1)}$. up to peaks in $|(\pi \pm \theta)|^{\nu-2}$ near $\theta - \pm\pi$ (their contributions can be factored out in the bounds). It directly follows that, under the conditions $r \geq 0$, $\mu > \nu - 1$, the complete integrand of (B.35) and thereby the kernel $\frac{\partial \mathcal{K}}{\partial \theta}(\theta, \tau)$ are themselves holomorphic and uniformly bounded by $cst \tau^{\nu-2} e^{(\nu-1)\text{Im}\tau}$ in Δ . One then sees (by using again the condition $r \geq 0$) that in the second contribution to the r.h.s. of Eq.(B.32), the integrand is uniformly bounded by $cst \tau^{\nu-1}$; this contribution is therefore holomorphic in $B_\pi^{(\text{cut})}$ (except for a branch-point with behaviour θ^ν at $\theta = 0$), and uniformly bounded there by $cst \theta^\nu$ up to the previous peaks in $cst |\pi \pm \theta|^{\nu-2}$ near $\theta = \pm\pi$. It therefore belongs to $\mathcal{O}^0(B_{\pi-\delta}^{(\text{cut})})$ for all $\delta > 0$. Moreover, since \mathcal{K} is analytic for $\theta = iw$, $\tau = iw$, $0 < w \leq v$, this contribution admits (like h) continuous boundary values on σ . We have thus proved that $h_1(\theta)$ satisfies the desired properties.

The term $h_2(\theta)$ is treated directly by writing (in view of (B.28)):

$$h_2(\theta) = \frac{-1}{\Gamma(1-\nu)\Gamma(\nu)} \frac{d}{d\theta} \int_0^\theta (\theta - \theta')^{-\nu} e^{i(r+\mu)\theta'} \Psi(\theta') d\theta', \quad (\text{B.36})$$

with

$$\Psi(\theta) = - \int_0^\pi (\cos \theta - \cos \tau)^{\nu-1} e^{-i(\mu-\nu)\tau} h(\tau) \sin \tau d\tau. \quad (\text{B.37})$$

In fact, both functions $\Psi(\theta)$ and $\theta \frac{\partial \Psi}{\partial \theta}(\theta)$ are holomorphic in B_π (except for branch-points at $0, \pi$ and $-\pi$) and uniformly bounded by $cst e^{(\nu-1)\text{Im}\theta}$ in this domain, up to peaks in $|(\pi \pm \theta)|^{2\nu-1}$ near $\theta = \pm\pi$. By passing to the integration variable $t = \frac{\theta'}{\theta}$, $0 \leq t \leq 1$, in Eq.(B.36), which allows one to derive with respect to θ under the integral and to factor out $\theta^{-\nu}$, one can make use of the previous bounds. In view of the conditions $r \geq 0$, $\mu > \nu - 1$, one checks that the integral is uniformly bounded in $B_{\pi-\delta}$ and therefore that $\theta^\nu h_2$ belongs to $\mathcal{O}^0(B_{\pi-\delta}^{(\text{cut})})$ for all $\delta > 0$; moreover, h_2 is holomorphic on σ (like Ψ , it has no cut).

Proof of Proposition B.6:

One easily checks that the function $\underline{f}(z)$ defined by $\underline{f}(\cos \theta) = f(\theta)$ is holomorphic in \mathbb{C}_A , with $A = \cosh v_0$, and that it satisfies the assumptions of Lemma B.7. This follows from the fact that the sets $B_\pi^{(\eta)}$ (see Eq.(B.2)) are equivalent to the sets $\mathbb{C}_A^{(\phi)}$ of Lemma B.7 by the mapping $Z : \theta \rightarrow z = \cos \theta$, (in the following sense: $\mathbb{C}_A^{(a\eta)} \subset Z(B_\pi^{(\eta)}) \subset \mathbb{C}_A^{(b\eta)}$ with $0 < a < 1 < b$) and that $a|e^{-i\theta}| < (1 + |z|) < b|e^{-i\theta}|$ (a, b, a and b being fixed numbers).

It then follows from these facts and from the conclusions of Lemma B.7 (formulas (B.25)...(B.27)) that the corresponding functions $\hat{f}_m^{(\alpha)}(\theta) = e^{i(m+\alpha)\theta} (\mathbf{P}_\alpha f)(\theta)$ are holomorphic in $B_\pi^{(\text{cut})}$ and enjoy the following properties:

a) If $\alpha < \beta$, $|\hat{f}_m^{(\alpha)}(\theta)| \leq \frac{C}{\eta^{\beta-\alpha}}$ for $\theta \in B_\pi^{(\eta)}$, which entails that $\hat{f}_m^{(\alpha)} \in \mathcal{O}^{\beta-\alpha}(B_\pi^{(\text{cut})})$,

b) If $\alpha = \beta$, $|\hat{f}_m^{(\alpha)}(\theta)| \leq C|\ln \eta|$ for $\theta \in B_\pi^{(\eta)}$, which entails that $\hat{f}_m^{(\alpha)} \in \mathcal{O}^{0*}(B_\pi^{(\text{cut})})$,

c) If $\alpha > \beta$, $\hat{f}_m^{(\alpha)}$ is bounded and continuous in the closure of $B_\pi^{(\text{cut})}$. In order to establish that $\hat{f}_m^{(\alpha)}$ belongs to the class $\mathcal{O}_{\alpha-\beta}(B_\pi^{(\text{cut})})$, we shall now prove that for all real ν such that $0 < \nu < \alpha - \beta$, the function $D_\nu \hat{f}_m^{(\alpha)}(\theta)$ is the product of $\theta^{-\nu}$ by a holomorphic function belonging to $\mathcal{O}^0(B_{\pi-\delta}^{(\text{cut})})$ for all $\delta > 0$. This will be done in three steps: we first give a proof for the case of ordinary derivatives, i.e. $\nu = r$ integer; then we reduce the proof for a general non-integral value of ν to that of a similar property for the corresponding value $\nu_1 = \nu - E(\nu)$ and finally we show the latter property for all values of ν_1 with $0 < \nu_1 < 1$.

1) $\nu = r$ integer: we claim that a relation of the following form holds:

$$\begin{aligned} [D_r \hat{f}_m^{(\alpha)}](\theta) &\equiv D_r [e^{i(m+\alpha)\theta} (\mathbf{P}_\alpha f)](\theta) \\ &= \sum_{r'=0}^r X^{(r')}(e^{i\theta}) e^{i(m+\alpha-r')\theta} [\mathbf{P}_{\alpha-r'} f](\theta) \\ &= \sum_{r'=0}^r X^{(r')}(e^{i\theta}) \hat{f}_m^{(\alpha-r')}(\theta), \end{aligned} \quad (\text{B.38})$$

where each $X^{(r')}$ is a polynomial of degree $2r'$. This relation (which is a variant of Eq.(II.43) of [25b]) is obtained by taking the derivative of order r

with respect to θ in the integral of (B.21): this is justified since $\alpha > \beta + r > r$.

Eq.(B.38) immediately shows that $[D_r \hat{f}_m^{(\alpha)}](\theta)$ is bounded and continuous in the closure of $B_\pi^{(\text{cut})}$, since each of the factors $\hat{f}_m^{(\alpha-r')}$ (where $\alpha-r' > \beta$) and $X^{(r')}(e^{i\theta})$ (with $|e^{i\theta}| = e^{-\nu} < 1$ in $B_\pi^{(\text{cut})}$) satisfies this property individually.

2) for non-integral ν , let $\nu = \nu_1 + r$ with $r = E(\nu) \geq 0$, $0 < \nu_1 < 1$. We apply Eq.(B.9) (which is legitimate since $\hat{f}_m^\alpha(\theta)$ is holomorphic at $\theta = 0$):

$$[D_\nu \hat{f}_m^\alpha](\theta) = [D_{r+1} P_{1-\nu_1} \hat{f}_m^\alpha](\theta) = [D P_{1-\nu_1} D_r \hat{f}_m^\alpha](\theta) + \sum_{p=0}^{r-1} [D_p f](0) \frac{\theta^{p-\nu}}{\Gamma(p-\nu+1)} \quad (\text{B.39})$$

The sum at the r.h.s. of Eq.(B.39) is the product of $\theta^{-\nu}$ by a function in $\mathcal{O}^0(B_\pi^{(\text{cut})})$ (with no cut on σ). In view of Eq.(B.38) we are thus led to show the following property (in which we have put $\alpha' = \alpha - r'$, with $\alpha' \geq \alpha - r > \beta + \nu_1$):

Let $0 < \nu_1 < 1$; then for every α' with $\alpha' > \beta + \nu_1$ and for every r' ($r' \geq 0$), the function $D P_{1-\nu_1} [X^{(r')}(e^{i\theta}) \hat{f}_m^{\alpha'}(\theta)]$ is the product of $\theta^{-\nu_1}$ by a function in $\bigcap_{\delta > 0} \mathcal{O}^0(B_{\pi-\delta}^{(\text{cut})})$ and it admits continuous boundary values on σ .

(When $\nu = \nu_1 < 1$ (i.e. $r = 0$), one just uses the latter for $D P_{1-\nu}[\hat{f}_m^\alpha(\theta)]$).

3) The proof of the previous statement relies in a crucial way on Lemma B.8. In fact, it is sufficient to replace the polynomial $X^{(r')}(e^{i\theta})$ by a typical term $e^{ir\theta}$, $r \geq 0$, and to study the expression:

$$D_{\nu_1} [e^{ir\theta} \hat{f}_m^{\alpha'}(\theta)] = \frac{d}{d\theta} [P_{1-\nu_1} (e^{i(r+m+\alpha')\theta} \mathbf{P}_{\alpha'}(f))] (\theta). \quad (\text{B.40})$$

We can now write $\mathbf{P}_{\alpha'} f = \underline{P}_{\alpha'} \underline{f} = \underline{P}_{\nu_1} \underline{g}$, with $\underline{g} = \underline{P}_{\alpha'-\nu_1} \underline{f}$ and notice that, since $\alpha' - \nu_1 > \beta$, Lemma B.7 c) implies that one can put $\underline{g}(\cos \theta) = e^{-i(m+\alpha'-\nu_1)\theta} h(\theta)$, with h holomorphic and uniformly bounded in $B_\pi^{(\text{cut})}$, and admitting continuous boundary values on σ . Eq.(B.40) then becomes:

$$\begin{aligned} D_{\nu_1} [e^{ir\theta} \hat{f}_m^{\alpha'}(\theta)] &= \frac{d}{d\theta} [P_{1-\nu_1} (e^{i(r+m+\alpha')\theta} \mathbf{P}_{\nu_1}(e^{-i(m+\alpha'-\nu_1)\theta} h))] (\theta). \\ &= K_{\nu_1, m+\alpha', r} h(\theta) \end{aligned} \quad (\text{B.41})$$

Since $\alpha' > \nu_1$ and $m > -1$, the assumptions of Lemma B.8 are satisfied and the announced result follows, which ends the proof of Proposition B.6.

ACKNOWLEDGEMENTS

We are very grateful to the Italian *Istituto Nazionale di Fisica Nucleare (I.N.F.N.)*, *Sezione di Genova*, for its financial support to one of us (J.B.) during the elaboration of this research project.

REFERENCES

- [1] J.R. FORSHAW and D.A. ROSS, “QCD and the Pomeron”, Cambridge University Press, 1997.
- [2] V.S. FADIN, E.A. KURAEV and L.N. LIPATOV, *Phys. Lett.B* **60** (1975) p. 50; I.I. BALITSKY and L.N. LIPATOV, *Sov. J. Nucl. Phys.* **28** (1978) p. 822.
- [3] M.C. BERGÈRE and C. GILAIN, “Regge-pole behaviour in ϕ^3 -field theory”, *J. Math. Phys.* **19** (1978) p. 1495-1512; M.C. BERGÈRE and C. DE CALAN, “Regge-pole behaviour from perturbative scalar field theories”, *Phys. Rev.* **D 20** (1979) p. 2047-2067.
- [4] R.K. ELLIS, W.J. STIRLING and B.R. WEBBER “QCD and Collider Physics”, Cambridge University Press, 1996.
- [5] A. DONNACHIE and P.V. LANDSHOFF, *Z. für Phys.C* **61**, (1994) p.139.
- [6] H.M. NUSSENZWEIG, “Diffraction effects in semi-classical Physics”, Cambridge University Press, 1992.
- [7] V. DE ALFARO and T. REGGE, “Potential Scattering”, North Holland, 1965.
- [8] R.G. NEWTON, “The complex j -plane”, W.A. Benjamin, 1964.
- [9] P.D.B. COLLINS, “Introduction to Regge theory and High Energy Physics”, Cambridge University Press, 1977.
- [10] J. BROS and G.A. VIANO, “Complex angular momentum in axiomatic quantum field theory”, in *Rigorous methods in particle physics*, S.Ciulli, F. Scheck, W. Thirring Eds. (*Springer tracts in Mod. Phys.* **119** (1990)) p.53-76.
- [11] M. FROISSART, “Asymptotic behaviour and subtractions in the Mandelstam representation”, *Phys. Rev.* **23** (1961) p. 1053-1057.
- [12] V.N. GRIBOV, “Partial waves with complex angular momenta and the asymptotic behaviour of the scattering amplitude”, *J. Exp. Theor Phys.* **14** (1962) p. 1395.
- [13] H. EPSTEIN, “Some Analytic Properties of Scattering Amplitudes in

- Quantum Field Theory”, in *Axiomatic Field Theory*, M. Chrétien and S. Deser Eds, Gordon and Breach, New York, 1966, p.3-133.
- [14] J. BROS and G.A. VIANO, in preparation.
- [15] R. OMNES, “Démonstration des relations de dispersion” in *Relations de dispersion et particules élémentaires*, C. De Witt and R. Omnes Eds, Hermann, Paris, 1960, p.317-385.
- [16] A. MARTIN, *Nuovo Cimento* **42** (1965) p.930 and **44** (1966) p.1219.
- [17] O. STEINMANN, *Helv. Phys. Acta* **33** (1960) p.257.
- [18] D. RUELLE, *Nuovo Cimento* **19** (1961) p.356 and Thesis, Zürich, 1959.
- [19] H. ARAKI, *J. Math. Phys.* **2** (1961) p.163.
- [20] H. EPSTEIN, V. GLASER, R. STORA, “General properties of the n -point functions in local quantum field theory” in *Structural Analysis of Collision Amplitudes*, R. Balian and D. Iagolnitzer Eds, North-Holland, Amsterdam, 1976, p.7-93.
- [21] O. STEINMANN, *Commun. Math. Phys.* **10** (1968) p.245.
- [22] A.S. WIGHTMAN, “Analytic functions of several complex variables” in *Relations de dispersion et particules élémentaires*, C. De Witt and R. Omnes Eds, Hermann, Paris, 1960, p.227-315.
- [23] J. BROS, H. EPSTEIN and V. GLASER, “Some rigorous analyticity properties of the four-point function in momentum space”, *Nuovo Cimento* **31** (1964) p.1265-1302.
- [24] J. BROS and G.A. VIANO, “Connection between the algebra of kernels on the sphere and the Volterra algebra on the one-sheeted hyperboloid: holomorphic perikernels”, *Bull. Soc. Math. France* **120** (1992) p.169-225.
- [25] J. BROS and G.A. VIANO, “Connection between the harmonic analysis on the sphere and the harmonic analysis on the one-sheeted hyperboloid: an analytic continuation viewpoint”, *Forum Math.* a) **8** (1996) p.621-658, b) **8** (1996) p.659-722, c) **9** (1997) p.165-191.
- [26] J. FARAUT, “Analyse Harmonique et Fonctions Spéciales”, *Ecole d’été d’Analyse Harmonique de Tunis*, 1984.
- [27] N.Ja. VILENKIN, “Special Functions and the Theory of Group Representations”, *Amer. Math. Soc. Transl.* **22**, Providence R.I., 1968.
- [28] R.F. STREATER and A.S. WIGHTMAN, “PCT, Spin and Statistics and all that”, W.A. Benjamin, New York, 1964.
- [29] R.P. BOAS, “Entire Functions”, Academic Press, New York, 1954.

- [30] A. SOMMERFELD, “Partial Differential Equations in Physics”, Academic Press, New York, 1949.
- [31] G.N. WATSON, “The diffraction of electric waves by the earth” *Proc. Roy. Soc.*, London, **95** (1918) p.83-99.
- [32] J. FARAUT and G.A. VIANO, “Volterra algebra and the Bethe-Salpeter equation” *J. Math. Phys.* **27** (1986) p.840-848.
- [33] K. OSTERWALDER, R. SCHRADER, *Commun. Math. Phys.* **33** (1973) p.83 and **42** (1975) p.281.
- [34] V. GLASER, *Commun. Math. Phys.* **37** (1974) p.257.
- [35] J. BROS and V. GLASER, “L’enveloppe d’holomorphie de l’union de deux polycercles”, mimeographed report, Saclay 1961.
- [36] A. ERDÉLYI, W. MAGNUS, F. OBERHETTINGER, F.G. TRICOMI, a) “Higher Transcendental Functions”, Vol.1, McGraw-Hill, New-York, 1953, b) “Tables of Integral Transforms”, Vol.2, McGraw-Hill, New-York, 1954.