

Luigi Pilo

**Chern-Simons Field Theory
and
Invariants of 3-Manifolds**

TESI DI PERFEZIONAMENTO

SCUOLA NORMALE SUPERIORE

PISA - 1997

Contents

1	The action principle and observables	7
1.1	Perturbative quantization	7
1.2	Composite Wilson line operators	11
1.3	Chern-Simons theory on the 3-sphere	13
2	Properties of the observables	17
2.1	Discrete Symmetries	17
2.2	Tensor algebra	18
2.3	Satellite relations	19
2.4	Calculation rules	22
2.5	Connected sum	26
3	SU(2) and SU(3) Examples	29
3.1	SU(2)	29
3.2	SU(3)	29
3.2.1	Computing the link polynomials	32
3.2.2	Values of the unknot	38
3.2.3	Values of the Hopf link	39
4	Reduced tensor algebra	45
4.1	Physically inequivalent representations	45
4.2	Reduced tensor algebra for SU(3)	49
4.2.1	Zeroes of the unknot	49
4.2.2	Null elements	51
4.2.3	Reduced tensor algebra for $k \geq 3$	54
4.2.4	Reduced tensor algebra for $k = 1$	58
4.2.5	Reduced tensor algebra for $k = 2$	61
4.3	Reduced tensor algebra for SU(2)	62
4.3.1	Reduced tensor algebra for $k \geq 2$	62
4.3.2	Reduced tensor algebra for $k = 1$	64
5	Dehn's surgery	65
5.1	Introduction	65
5.2	Knots in a torus	65
5.3	The mapping class group of the torus	67
5.4	Solid torus	67
5.5	Dehn's surgery	70

6	Surgery in Chern-Simons field theory	75
6.1	Elementary surgeries	75
6.2	Elementary surgery operators for low values of k	77
6.3	General expression for elementary surgery operators	78
6.4	Surgery rules	80
6.5	General properties	83
6.6	Examples	87
6.6.1	The manifold $S^2 \times S^1$	87
6.6.2	Lens spaces and Poincaré manifold	91
6.6.3	Manifolds $\Sigma_g \times S^1$	93
6.7	Properties of the Surgery	96
7	A three-manifold invariant	103
7.1	Introduction	103
7.2	Definition of the invariant	103
7.3	Examples	104
7.4	Properties of the CS 3-manifold invariant	106
7.4.1	Introduction	106
7.4.2	Lens Spaces	106
7.4.3	The $SU(2)$ case	107
7.4.4	The $SU(3)$ case	113
7.4.5	Discussion	114
8	Three-dimensional field theory vs two-dimensional conformal field theory	115
8.1	Introduction	115
8.2	Fusion algebra and reduced tensor algebra	116
8.3	Modular group	117
8.4	Punctured Riemann surfaces	120
8.5	Dimensions of the physical state spaces	124
8.6	Discussion	128
9	Conclusion	131
A	The Wess-Zumino functional	133
A.1	Behaviour under smooth deformation	133
A.2	Composition of maps	134
A.3	Normalization: $G = SU(2)$	134
B	Elements of knot theory	137
B.1	Ambient and regular isotopy	137
B.2	Link invariants	140
B.3	Artin braid group	141
C	Miscellaneous results	145
C.1	The $SU(3)$ Hopf matrix is non singular	145
C.2	On the $SU(3)$ reduced tensor algebra structure constants	146
C.3	Normalization of surgery operator for $SU(2)$, $k \geq 2$	147
C.4	Normalization of surgery operator for $SU(3)$, $k \geq 3$	148
C.5	The value of $I(\Sigma_g \times S^1)$	149
C.6	Proof of (7.63)	150

D	Conformal field theory in two dimensions	153
D.1	Introduction	153
D.2	Conformal invariance	153
D.3	Conformal Ward identities	155
D.4	Operator product expansion	156
D.5	Central charge	157
D.6	Virasoro algebra	159
D.7	The Hilbert space	160
D.8	Operator algebra and conformal blocks	161
D.9	Fusion rules	163
D.10	Wess-Zumino-Witten model	164
D.10.1	The Kac-Moody algebra	165
D.10.2	The Sugawara construction	166
D.10.3	Primary fields and integrable representations	167
D.11	Modular invariance	169
D.12	Witten's approach to Chern-Simons theory	171
E	Numerical results	177

Introduction

In the last decade the research field under the name of topological quantum field theory (TQT) has undergone an impressive growth, since the early works by Schwarz [1] on the Abelian Chern-Simons theory and Witten [2, 3, 10] a huge number of models has appeared in the literature (see [4, 5] for an extensive list of references). The adjective topological, deserved by all these models, stems from the goal they have been designed for: the representation and possibly the computation of topological and/or differential invariants of a suitable space by using quantum field theory. For instance, the correlation functions of gauge invariant observables in the Chern-Simons theory studied in this thesis, represent topological invariants of knots, and the modified partition function gives a topological invariant for the three-manifold \mathcal{M} in which the theory is defined. The suggestion that quantum field theory might be useful to understand recent results on four-dimensional manifolds obtained by Donaldson [8] and on knot theory [9] obtained by Jones, was put forward by Atiyah and Schwarz [6, 7] as a challenge for the theoretical physics community. Witten in [3, 10] showed that those suggestions were viable and he produced two paradigmatic examples of topological quantum field theory.

We shall focus our attention on the topological quantum field theory introduced by Witten in [10], namely the three-dimensional Chern-Simons field theory. Differently from Witten's original approach, we shall adopt a fully three-dimensional point of view; no result from two-dimensional conformal field theory will be used. It turns out that the basic principles of quantum field theory, together with symmetry considerations are stringent enough to solve Chern-Simons theory (CS) in any closed connected and orientable three-manifold. It is worth to stress that the solution presented here can be provided with a completely rigorous formulation. The mathematical foundation of our work relies on Atiyah's axiomatic approach to topological quantum field theory [11] and in particular on the realization of these axioms studied by Turaev [12]. Indeed, as a matter of fact, the link invariants and the three-manifold invariants defined in terms of CS correlation functions coincide with the "quantum invariants" considered in [12].

From the point of view of a theoretical physicist the CS model is just a "strange" gauge theory with a huge number of symmetries which constrain the dynamics. Actually, the constraints are so strong that there is no room for standard "physical" excitations and, as a consequence, there is no dynamics at all. Moreover, the symmetries plus some "numerical" input from perturbation theory allow to solve the theory in \mathbb{R}^3 and in S^3 . Remarkably, the same happens in any closed, connected and orientable three-manifold \mathcal{M} . The crucial fact is that one can represent the effect of the non-trivial topology of \mathcal{M} on the expectation value $\langle W \rangle_{\mathcal{M}}$ of an observable W as a symmetry transformation on the corresponding expectation value in S^3 . Producing the solution of the theory in \mathcal{M} amounts to finding the operator $W(\mathcal{L})$ whose insertion $\langle W(\mathcal{L}) W \rangle_{S^3}$ gives the correlation function $\langle W \rangle_{\mathcal{M}}$ in \mathcal{M} . It turns out that this leads to an implementation of Dehn's surgery at the level of CS gauge invariant correlation functions in S^3 which can be used to solve the theory in any closed, connected and orientable three-manifold. From topology it is known that any closed, connected and orientable three-manifold can be obtained from S^3 by using Dehn's surgery, which consists in a finite sequence of elementary surgery operations corresponding to cut a solid torus from S^3 and glue it back by using a suitable homeomorphism.

The goal of this thesis is two-fold: study the general properties of the surgery construction for a generic compact and semi-simple gauge group G as a first instance, and, as a second instance, show how powerful the three-dimensional point of view is for practical computations. By Turaev's or Witten's approaches only the case $G = SU(2)$ has been considered extensively; actually one of the original aspects of this work is a complete study of the case $G = SU(3)$. Other original results concern the general construction of the surgery operator under suitable conditions on the gauge group G , the derivation of some well known properties of rational conformal field theory in two dimensions by using three-dimensional CS theory, and finally a preliminary investigation on the relation between the fundamental group $\pi_1(\mathcal{M})$ and the three-manifold invariant defined by using

CS theory.

For the reader's convenience we shall outline the contents of this thesis. The first two chapters contain preliminary material. In chapter 1, CS perturbation theory in \mathbb{R}^3 is reviewed; the observables of the theory, namely Wilson lines, are defined as quantum composite operators and this leads to the concept of framed knots in \mathbb{R}^3 . The successive step is the study of CS theory in S^3 ; it is shown that all the results obtained in \mathbb{R}^3 are still valid, provided one restricts the CS coupling constant k to integers values as a consequence of the gauge invariance constraint. In chapter 2, the notion of tensor algebra is introduced and one of the most remarkable properties of CS observables is discussed: the satellite relations. In the last section of chapter 2, some useful calculation rules are summarized. With chapter 3 begins the original part of the work; the explicit solution of the theory in S^3 with the gauge group $G = SU(3)$ is given, many examples are also worked out in detail. Chapter 4 is devoted to the reduced tensor algebra, which encodes all the information on the physical irreducible representations of the gauge group G . After a general definition of the reduced tensor algebra, the case $G = SU(3)$ is studied with full details. In addition, for completeness, also the construction of the reduced tensor algebra for $G = SU(2)$, already known in the literature, is presented. Chapter 5 contains a quick introduction to Dehn's surgery in preparation to chapter 6, in which the surgery construction in the CS theory is introduced. When the reduced tensor algebra is regular (this notion is defined in chapter 4) the general form for the surgery operator is produced and the surgery rules are given. As examples the manifolds $S^2 \times S^2$, $\Sigma_g \times S^1$ and the Poincaré sphere with $G = SU(3)$ are considered. Some general properties of the surgery operator are also proved. Chapter 7 is devoted to the construction of a non-trivial three-manifold invariant from the CS partition function. After some example, the relation between the fundamental group and the CS invariant is investigated. It is proved that, when $G = SU(2)$, the absolute value of the non-vanishing CS three-manifold invariant for the lens spaces $L_{p/r}$ depends only on the fundamental group of $L_{p/r}$; numerical evidence for the case $G = SU(3)$ is also given. In the last chapter, the relation between two-dimensional conformal field theory and three-dimensional CS theory is discussed. Appendix D contains a brief introduction to conformal field theory and a review of the original Witten's approach to CS theory.

Chapter 1

The action principle and observables

1.1 Perturbative quantization

The field theory model which we are interested in is defined by the action [10]

$$S_{CS} = \frac{k}{4\pi} \int_{\mathbb{R}^3} \text{Tr} \left(A \wedge dA + \frac{2}{3} i A \wedge A \wedge A \right) . \quad (1.1)$$

Eq.(1.1) defines a gauge theory for the compact and simple group G ; the fundamental field is the connection 1-form

$$A = A_\mu dx^\mu, \quad A_\mu = A_\mu^a T_a .$$

The generators of the gauge group G in some definite representation ρ are associated with the Hermitian matrices $\{T^a\}$

$$\left[T^a, T^b \right] = i f_c^{ab} T^c \quad a, b, c = 1, \dots, n \quad n = \dim(\text{Lie } G) . \quad (1.2)$$

We use the following representation independent normalization

$$\text{Tr} \left(T^a T^b \right) = \frac{1}{2} \delta^{ab} ; \quad (1.3)$$

the trace Tr_ρ in the representation ρ is related to Tr by

$$\text{Tr} = \frac{1}{4 \mathcal{X}(\rho)} \text{Tr}_\rho , \quad (1.4)$$

where $\mathcal{X}(\rho)$ is the Dynkin index of ρ . In a local coordinate basis the action takes the form

$$S_{CS} = \frac{k}{4\pi} \int_{\mathbb{R}^3} d^3x \epsilon^{\mu\nu\rho} \text{Tr} \left(A_\mu \partial_\nu A_\rho + i \frac{2}{3} A_\mu A_\nu A_\rho \right) . \quad (1.5)$$

It is important to point out that, in order to define the classical theory, no metric structure in \mathbb{R}^3 is required.

Let us consider a gauge transformation on A

$$A \rightarrow A' = U^{-1} A U - i U^{-1} dU , \quad (1.6)$$

where $U : \mathbb{R}^3 \rightarrow G$ is a G valued function in \mathbb{R}^3 . Differently from standard gauge theories like QED or QCD, the CS action is not gauge invariant, indeed

$$S_{CS}[A] \rightarrow S_{CS}[A'] = S_{CS}[A] + 2\pi k \Gamma_{\mathbb{R}^3}[U] , \quad (1.7)$$

where the Wess-Zumino functional Γ_M is defined in any orientable 3-manifold M as

$$\begin{aligned}\Gamma_M[U] &= \frac{k}{24\pi^2} \int_M \Omega \quad , \\ \Omega &= \text{Tr} [(U^{-1}dU) \wedge (U^{-1}dU) (U^{-1}dU)] \quad .\end{aligned}\quad (1.8)$$

In appendix A it is shown that $\Gamma_M[U]$ is invariant under a small deformation of U

$$\Gamma_M[U + \delta U] = \Gamma_M[U] \quad . \quad (1.9)$$

Therefore, the CS action in \mathbb{R}^3 is invariant under infinitesimal gauge transformations.

The gauge invariance of the CS action is crucial to quantize the model in \mathbb{R}^3 ; actually one can use [14, 15] the well experimented methods of BRS perturbative quantization [13]. As usual, the first step is the gauge fixing; to carry out this task a metric on \mathbb{R}^3 is needed. A simple and practical choice is the following

$$g_{\mu\nu} = \delta_{\mu\nu} \quad \mu, \nu = 1, 2, 3 \quad . \quad (1.10)$$

The gauge fixing condition is the covariant (Lorenz) gauge

$$G(A) = \partial^\mu A_\mu = 0 \quad . \quad (1.11)$$

To avoid the over-counting of gauge equivalent configurations, the generating functional Z is defined following the Faddev-Popov ansatz

$$\begin{aligned}Z[J, \eta, \bar{\eta}] &= \int D[A, \bar{c}, c] e^{iS_{CS}[A] + 2idx \int \text{tr}(J^\mu A_\mu + \bar{c}\eta + \bar{\eta}c)} \\ &e^{\frac{ik}{4\pi} \int dx dy \bar{c}^a(x) \frac{\delta G^a}{\delta \omega^b}(x, y) c^b(y)} \delta[G^a] \quad .\end{aligned}\quad (1.12)$$

We have introduced the sources for the gauge field A and for the ghost fields \bar{c}, c

$$\bar{c} = \bar{c}^a T_a, \quad c = c^a T_a, \quad \eta = \eta^a T_a, \quad \bar{\eta} = \bar{\eta}^a T_a \quad . \quad (1.13)$$

By using

$$\delta[G] = \int D[B] \exp\left(-i\frac{k}{4\pi} \int dx B^a(x) G^a(x)\right) \quad , \quad (1.14)$$

and eq.(1.12) one gets

$$Z[J, \eta, \bar{\eta}] = \int D[A, \bar{c}, c] \exp\left\{iS_{tot}[A, B, \bar{c}, c] + 2i \int dx \text{tr}(J^\mu A_\mu + \bar{c}\eta + \bar{\eta}c)\right\} \quad , \quad (1.15)$$

where

$$\begin{aligned}S_{tot} &= S_{CS} - \frac{k}{4\pi} \int dx B^a(x) \partial^\mu A_{a\mu} + \frac{k}{4\pi} \int dx dy \bar{c}_a(x) \frac{\delta G^a}{\delta \omega^c}(x, y) c^c(y) \\ &= S_{CS} + S_{g.f.} \quad .\end{aligned}\quad (1.16)$$

The operator $\frac{\delta G^a}{\delta \omega^c}$ represents the variation of G^a under an infinitesimal gauge transformation

$$A_\mu^a \rightarrow A_\mu^a + \partial_\mu \omega^a - A_\mu^b \omega^c f_{bc}^a \quad , \quad (1.17)$$

with

$$U(x) = \exp(i\omega), \quad \omega = \omega^a T_a \quad . \quad (1.18)$$

In particular, with the gauge choice (1.11) we have [14]

$$S_{tot} = S_{CS} + \frac{k}{4\pi} \int dx A_\mu^a \partial^\mu B_a - \frac{k}{4\pi} \int dx \partial^\mu \bar{c}_a(x) (D_\mu)^{ad} c_d \quad . \quad (1.19)$$

The covariant derivative $(D_\mu)^{ad}$ in the adjoint representation is defined as

$$(D_\mu)^{ad} = \delta^{ad} \partial_\mu - f_c^{ad} A_\mu^c \quad . \quad (1.20)$$

The total action S_{tot} in the Landau gauge comprising the classical action, the gauge-fixing term and ghost contribution is given by equation (1.19).

The total action S_{tot} is invariant under the following BRS transformations

$$\begin{aligned} s(A_\mu^a) &= (D_\mu c)^a \\ s(c^a) &= -\frac{1}{2}[c, c]^a \\ s(\bar{c}^a) &= B^a \\ s(B^a) &= 0 \quad . \end{aligned} \quad (1.21)$$

The CS theory is renormalizable by power counting; the beta function and the anomalous dimensions of the elementary fields are vanishing [16] to all orders in perturbation theory. The only free parameter of the model is the renormalized coupling constant k which is fixed by the normalization conditions. Let $\Gamma[A, B, \bar{c}, c]$ be the effective action of the theory. Since there are no gauge anomalies in three dimensions, one can always construct an effective action $\Gamma[A, B, \bar{c}, c]$ which, in the limit in which the regularization cutoffs are removed, is BRS invariant. BRS invariance will be used to fix the normalization of the fields; indeed, as a function of the renormalized fields $\Gamma[A, B, \bar{c}, c]$ must satisfy the Slavnov-Taylor identity

$$\left\{ s(A_\mu^a) \frac{\delta}{\delta A_\mu^a} + s(B) \frac{\delta}{\delta B} + s(c) \frac{\delta}{\delta c} + s(\bar{c}) \frac{\delta}{\delta \bar{c}} \right\} \Gamma[A, B, \bar{c}, c] = 0 \quad . \quad (1.22)$$

In eq.(1.22), the appropriate normalization for the composite operators is understood. The effective action admits an expansion in powers of the fields, of course; let us consider for instance the terms $\Gamma^{(2)}[A_\mu]$ and $\Gamma^{(3)}[A_\mu]$ of this expansion which are quadratic and cubic in the field A_μ ,

$$\Gamma^{(2)}[A_\mu] = \int d^3x d^3y G_{ab}^{\mu\nu}(x, y) A_\mu^a(x, y) A_\nu^b(y) \quad , \quad (1.23)$$

$$\Gamma^{(3)}[A_\mu] = \int d^3x d^3y d^3z H_{abc}^{\mu\nu\rho}(x, y, z) A_\mu^a(x) A_\nu^b(y) A_\rho^c(z) \quad . \quad (1.24)$$

The BRS invariance (1.22) implies that the exact two-point function $G_{ab}^{\mu\nu}(x, y)$ is related to the three-point proper vertex $H_{abc}^{\mu\nu\rho}(x, y, z)$ by

$$\partial_\mu^x H_{abc}^{\mu\nu\rho}(x, y, z) = \frac{2}{3} f_{ab}^d G_{dc}^{\nu\rho}(x, z) \delta^3(x - y) \quad . \quad (1.25)$$

Our normalization of the fields is fixed by eq.(1.21); equivalently, our normalization of the elementary vector field A_μ is determined by eq.(1.25). Let us now fix the normalization condition for k . As shown in [16], the exact two-point function $G_{ab}^{\mu\nu}(x, y)$ has the form

$$G_{ab}^{\mu\nu}(x, y) = Z \epsilon^{\mu\rho\nu} \partial_\rho^x \delta^3(x - y) \delta_{ab} \quad , \quad (1.26)$$

where Z is a real parameter. The parameter Z which is computed in perturbation theory is a function of the “bare” coupling constant k_0 . The functional dependence of Z on k_0 depends on the regularization prescriptions and/or by adding finite local counter-terms at each order of the loop expansion. The value of the physical coupling constant is also called the renormalized coupling constant and is usually determined in terms of the effective action Γ of the theory. We shall follow the standard field theory procedure and the value of the renormalized coupling constant k of the CS theory will be fixed by

$$k = 8\pi Z \quad , \quad (1.27)$$

where Z enters the exact two-point function (1.26). With the field normalization (1.25), eq.(1.27) represents the normalization condition for k .

Condition (1.27) gives a good definition of the renormalized coupling constant k because eq.(1.27) it is in agreement with the classical expression (1.19) of the action. Consequently, when the correlation functions of the fields are expressed in terms of k , the equations which follow from the action principle are satisfied. Conversely, for the renormalized correlation functions the action principle is valid only if the coupling constant k satisfies condition (1.27).

All the results that we shall derive are consequences of the action principle based on the functional (1.19); the expectation values of the gauge invariant observables will be expressed in terms of the physical coupling constant k .

A remarkable property of the quantum CS theory is that, according to eq.(1.26), the two-point function does not receive radiative corrections; therefore, the full (dressed) propagator coincides with the free one

$$\langle A_\mu^a(x) A_\nu^b(y) \rangle = \frac{i}{k} \delta^{ab} \epsilon_{\mu\nu\rho} \frac{(x-y)^\rho}{|x-y|^3} \quad . \quad (1.28)$$

The function defined by the propagator, integrated along two oriented, closed and non-intersecting paths C_1 and C_2 in \mathbb{R}^3 , must represent an invariant of ambient isotopy for a two-component link. The invariant associated with the expression (1.28) is simply the linking number [17] of C_1 and C_2 ,

$$\text{lk}(C_1, C_2) = \frac{1}{4\pi} \oint_{C_1} dx^\mu \oint_{C_2} dy^\nu \epsilon_{\mu\nu\rho} \frac{(x-y)^\rho}{|x-y|^3} \quad . \quad (1.29)$$

The classical CS action was defined without referring to any metric structure in \mathbb{R}^3 . In addition, infinitesimal gauge invariance implies that S_{CS} is also invariant under an infinitesimal diffeomorphism of \mathbb{R}^3 : $x^\mu \rightarrow x^\mu + \epsilon v^\mu$, generated by the vector field v . The “general covariance” property of S_{CS} is remarkable because is achieved only with the differential structure of \mathbb{R}^3 . However, we have seen that in order to gauge fix the theory an “external” metric is required. The question is: “Does the external metric break general covariance?”. In order to answer this question, let us compute the symmetric energy momentum tensor associated with the total action (1.19). By definition we get [14]

$$\begin{aligned} T_{\mu\nu} = & -\frac{1}{2} \frac{1}{\sqrt{g}} \frac{\delta S_{tot}}{\delta g^{\mu\nu}} = -\frac{k}{4\pi} \left[A_{(\mu}^a \partial_{\nu)} B_a - g_{\mu\nu} A_\rho^a \partial^\rho A_a \right. \\ & \left. - \partial_{(\mu} \bar{c}^a (D_{\nu)} c)_a + g_{\mu\nu} \partial^\rho \bar{c}^a (D^\rho c)_a \right] \quad . \end{aligned} \quad (1.30)$$

The operator Q , generating the BRS transformation in the Hilbert space of the theory, is defined in such a way that its action on a field ϕ is the following

$$[Q, \phi] = s(\phi) \quad . \quad (1.31)$$

From eq.(1.30) and eq.(1.31) it follows that $T_{\mu\nu}$ is Q -exact; indeed

$$T_{\mu\nu} = [Q, \Theta_{\mu\nu}] \quad , \quad (1.32)$$

where

$$\Theta_{\mu\nu} = \partial_{\{\mu} \bar{c}_a A_{\nu\}}^a - g_{\mu\nu} \partial^\rho \bar{c}_a A_\rho^a \quad . \quad (1.33)$$

The physical states of a gauge theory are those annihilated by the BRS charge, i.e.

$$Q |f\rangle = 0 \quad . \quad (1.34)$$

As a consequence of eq.(1.34), the expectation values of the energy momentum tensor on physical states vanish

$$\langle f' | T_{\mu\nu} | f \rangle = 0 \quad . \quad (1.35)$$

Actually, the BRS symmetry of the theory guarantees that the external metric required to gauge fix the theory is immaterial when physical states are considered. Thus, invariance under infinitesimal diffeomorphisms of \mathbb{R}^3 is preserved also at the quantum level.

1.2 Composite Wilson line operators

Let C be an oriented knot in \mathbb{R}^3 and ρ an irreducible representation of the gauge group G . The Wilson line $W(C; \rho)$ is defined as

$$W(C; \rho) = \text{Tr P exp} \left[i \oint_C A_\mu^a(x) T_{(\rho)}^a dx^\mu \right] \quad , \quad (1.36)$$

where the path-ordering is introduced according to the orientation of C and $\{T_{(\rho)}^a\}$ are the generators of G in the representation ρ . The behaviour of $W(C; \rho)$ under a gauge transformation is the following

$$P \exp \oint_\gamma \tilde{A} \xrightarrow{\text{Gauge}} U(P_1) \left[P \exp \oint_\gamma \tilde{A} \right] U^{-1}(P_2) \quad , \quad (1.37)$$

where P_1, P_2 are the initial and final points of the curve γ . From eq.(1.37), it follows that $W(C; \rho)$ is gauge invariant.

In the framework of quantum CS theory, the object defined by eq.(1.36) gives rise to a composite operator, consequently, a suitable definition of the Wilson line must be provided. In other words one has to specify the operative procedure used to compute the expectation values of this operator at any given order of the perturbative expansion of the theory. There is only one known procedure which preserves general covariance: a framing for the closed curve C , which enters the definition of the Wilson line, must be introduced [18, 19]. Let us start from the ‘‘classical’’ expression for the Wilson line

$$W_{\text{classic}}(C, \rho) = \left[1 + \int_0^1 A_\mu(x(s)) \frac{dx^\mu}{ds} ds - \int_0^1 ds \int_0^s ds A_\mu(x(s_1)) A_\nu(x(s)) \frac{dx^\mu}{ds_1} \frac{dx^\nu}{ds} + \dots \right] \quad (1.38)$$

$0 \leq 1 \leq s,$

with knot C parameterized by $x^\mu(s)$. The framing prescription for the Wilson line is defined in terms of the framing contour C_f given by

$$y^\mu(s) = x^\mu(s) + \epsilon n^\mu(s) \quad \epsilon > 0 \quad n^2 = 1 \quad . \quad (1.39)$$

The vector field n^μ is chosen to be orthogonal to the tangent vector of C , i.e. $n^\mu \dot{x}^\nu \delta_{\mu\nu} = 0$. For each oriented knot C , we shall introduce a framing C_f . The framed Wilson line is defined in the following way. In eq.(1.38), each term of the type

$$[\dot{x}^{\mu_i}(s_i) A_{\mu_i}(x(s_i))] \quad , \quad (1.40)$$

is replaced by

$$[\dot{x}^{\mu_i}(s_i) A_{\mu_i}(x(s_i))]_f = \{[\dot{x}^{\mu_i}(s_i) + \epsilon_i \dot{n}^{\mu_i}(s_i)] A_{\mu_i}(x(s_i) + \epsilon_i n(s_i))\} \quad . \quad (1.41)$$

The non-negative real numbers $\{\epsilon_i \quad i = 1, 2, \dots\}$ are chosen in such a way that $\epsilon_i \neq \epsilon_j \quad \forall i, j$. The composed Wilson line operators $W(C; \rho)$ associated with a link C with colour ρ is defined by replacing C by its framed analog C_{Framed} , by taking the vacuum expectation value and, finally, by letting ϵ_i go to zero

$$E(C; \rho) = \lim_{\{\epsilon\} \rightarrow 0} \langle W(C_{Framed}; \rho) \rangle \quad . \quad (1.42)$$

The framing C_f of C is completely determined, up to smooth deformations of C and C_f in the ambient space \mathbb{R}^3 , by the linking number $\text{lk}(C, C_f)$ of C and C_f . When the linking number of C and C_f is vanishing, C_f is called a preferred framing for C . Given an oriented framed knot C in \mathbb{R}^3 and an irreducible representation ρ of G , the associated Wilson line operator $W(C; \rho)$ is well defined and is gauge invariant. We shall often call ρ the colour of C .

Let us now consider a framed, oriented and coloured link L in \mathbb{R}^3 with m components $\{C_1, C_2, \dots, C_m\}$. Let the colour of each component C_i of L be specified by an irreducible representation ρ_i of G . The Wilson line operator $W(L)$ associated with L is simply the product of the Wilson operators defined for the single components

$$W(L) = W(C_1; \rho_1) W(C_2; \rho_2) \cdots W(C_m; \rho_m) \quad . \quad (1.43)$$

The set of expectation values

$$E(L) = \langle W(L) \rangle \Big|_{\mathbb{R}^3} = \frac{\langle 0 | W(L) | 0 \rangle \Big|_{\mathbb{R}^3}}{\langle 0 | 0 \rangle \Big|_{\mathbb{R}^3}} \quad , \quad (1.44)$$

which are defined for all the possible links $\{L\}$ which are framed, oriented and coloured, is the set of the gauge invariant observables which we are interested in.

The Wilson line operators (1.43) are defined for links which are contained inside some finite and closed domain of \mathbb{R}^3 . For this kind of observables, the vacuum expectation values can be computed by means of the standard BRS quantization procedure which is based on the action (1.19). In \mathbb{R}^3 there is no constraint to be imposed on the value of the coupling constant k ; thus, perturbation theory is well defined because the expansion parameter λ , given by

$$\lambda = (2\pi/k) \quad , \quad (1.45)$$

is a free parameter and the expectation values $E(L)$ are well defined for arbitrary values of λ . This is why we chose \mathbb{R}^3 as starting manifold; in fact, all the perturbative aspects of the CS model refer to the theory defined in \mathbb{R}^3 .

For any given link L in \mathbb{R}^3 , the expectation value (1.44) admits an expansion in powers of λ ; each term of this expansion can be computed by means of ordinary perturbation theory. In order to verify that the observable $E(L)$ is well defined, let us consider for instance the first three terms of this expansion. Let us consider the unknot U (simple circle) in \mathbb{R}^3 with framing U_f and with colour given by the irreducible representation ρ of $SU(3)$. The first three terms of the λ -expansion of the vacuum expectation value of the associated Wilson line operator $W(U, U_f; \rho)$ have been computed [18] by means of ordinary Feynman diagrams; the result is

$$\begin{aligned} \langle W(U, U_f; \rho) \rangle|_{\mathbb{R}^3} &= (\dim \rho) \left[1 - i\lambda Q(\rho) \text{lk}(U, U_f) \right. \\ &\quad \left. - \frac{1}{2}\lambda^2 Q^2(\rho) (\text{lk}(U, U_f))^2 - \frac{1}{4}\lambda^2 Q(\rho) \right] + O(\lambda^3) \quad , \end{aligned} \quad (1.46)$$

where $Q(\rho)$ is the value of the quadratic Casimir operator in the representation ρ ,

$$T_{(\rho)}^a T_{(\rho)}^a = Q(\rho) \cdot \mathbb{I} \quad . \quad (1.47)$$

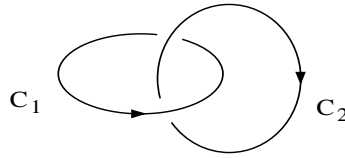

Figure 1.1

Let us now consider the Hopf link in \mathbb{R}^3 in which the two components C_1 and C_2 are oriented as it is shown in Fig.1.1. Let C_1 and C_2 have framings C_{1f} and C_{2f} respectively. When the colours of C_1 and C_2 are given by the irreducible representations ρ and ρ' of $SU(3)$, one finds [18]

$$\begin{aligned} \langle W(C_1, C_{1f}; \rho) W(C_2, C_{2f}; \rho') \rangle|_{\mathbb{R}^3} &= (\dim \rho) (\dim \rho') \\ &\left[1 - i\lambda Q(\rho) \text{lk}(C_1, C_{1f}) - i\lambda Q(\rho') \text{lk}(C_2, C_{2f}) \right. \\ &\quad - \frac{1}{2}\lambda^2 Q^2(\rho) (\text{lk}(C_1, C_{1f}))^2 - \frac{1}{2}\lambda^2 Q^2(\rho') (\text{lk}(C_2, C_{2f}))^2 \\ &\quad \left. - \frac{1}{4}\lambda^2 Q(\rho) - \frac{1}{4}\lambda^2 Q(\rho') - \frac{1}{4}\lambda^2 Q(\rho) Q(\rho') \right] + O(\lambda^3) \quad . \end{aligned} \quad (1.48)$$

In conclusion, perturbation theory is well defined in \mathbb{R}^3 and the expectation values of the observables, which are defined by the framing procedure, represent ambient isotopy invariants of framed, oriented and coloured links in \mathbb{R}^3 .

1.3 Chern-Simons theory on the 3-sphere

In order to study the theory in S^3 , we need to discuss the non-invariance of S_{CS} under “large”, i.e. non-shrinkable to the identity, gauge transformations. Let us introduce the concept of degree of map. Given a differentiable map $f : N \rightarrow M$, with N and M closed, connected and orientable manifolds of dimension n , the degree $Dgr_y[f]$ of f is defined as [20]

$$Dgr_y[f] = \sum_{x_0 \in f^{-1}(y)} sgn \det \left(\frac{\partial f}{\partial x} \Big|_{x_0} \right) \quad , \quad (1.49)$$

where $y \in M$ is a regular point. The degree is an integer and satisfies the following properties

1. $Dgr_y[f]$ does not depend on the regular point y chosen.
2. If f_1 and f_2 are homotopic maps then

$$Dgr[f_1] = Dgr[f_2] \quad . \quad (1.50)$$

If f_1 and f_2 are homotopic, one can continuously deform f_1 to f_2 . Roughly speaking, $Dgr[f]$ measures the number of times that N winds M . The degree admits the following integral representation

$$\int_N f^* \omega = Dgr[f] \int_M \omega \quad , \quad (1.51)$$

where ω is a n -form on M , and $f^*\omega$ is the n -form f -related with ω , i.e. $f^*\omega$ is the pull-back of ω .

Let us consider first the case when the gauge group G is $SU(2)$ and the manifold M where the theory is defined is S^3 . The group $SU(2)$ is homeomorphic to S^3 . Thus, a gauge transformation U can be viewed as a map $U : S^3 \rightarrow S^3$. By using the relation (1.51) in the expression for the Wess-Zumino functional, we get

$$\begin{aligned} \Gamma[U] &= \int_{S^3} \Omega = D[U] \int_G \omega = m \int_{S^3} \omega = mC \\ \Omega &= \varphi^* \omega, \quad m = Dgr[U] \quad , \end{aligned} \quad (1.52)$$

where C is a constant. One can verify by direct calculation (see appendix A) that

$$\Gamma[U] = m \quad . \quad (1.53)$$

The integer n labels the elements of $\pi_3(SU(2))$, indeed $\pi_3(SU(2)) = \mathbb{Z}$. The multiplication law in $\pi_3(G)$ is expressed in terms of $\Gamma[U]$ as (see appendix A)

$$\Gamma[U^{(1)} \cdot U^{(2)}] = \Gamma[U^{(1)}] + \Gamma[U^{(2)}] \quad . \quad (1.54)$$

If $U^{(1)}$ represents the generator of \mathbb{Z} , one gets

$$\Gamma[U^{(m)}] = \Gamma[U^{(1)} \dots U^{(1)}] = m \Gamma[U^{(1)}] \Rightarrow C = \Gamma[U^{(1)}] \quad . \quad (1.55)$$

Let us now extend the previous result to a generic compact and simple group G . The crucial fact for our purpose is the following theorem due to Bott [21].

Theorem 1.1

Given a continuous map f from S^3 into a simple and compact Lie group G , there exists a map f' from S^3 into $SU(2) \subset G$ homotopic to f .

With the help of Theorem 1.1, eq.(1.53) can be extended to any compact simple Lie group G . Thus, it follows that the CS theory action in S^3 with a simple and compact gauge group transforms under a gauge transformation according to

$$S_{CS} \rightarrow S_{CS} + 2\pi k m \quad , \quad (1.56)$$

where n is an integer. As a result, the gauge invariance of $\exp(iS_{CS})$ in S^3 constrains k to be an integer [22].

From a topological point of view, one can represent S^3 as \mathbb{R}^3 with the points at infinity identified. As in \mathbb{R}^3 , any link L in S^3 is contained in a three ball B^3 . Thus links in S^3 and in \mathbb{R}^3 share the same topological properties. Let us now consider the CS quantum field theory in S^3 ; being S^3 and \mathbb{R}^3 locally the same, the theory in S^3 exhibits the same ultraviolet behavior as the corresponding theory in \mathbb{R}^3 . All the general properties of the expectation values of the observables in \mathbb{R}^3 are also valid in S^3 . A change in the value of the coupling constant k does not modify the structure of the link polynomials $E(L)$, it only modifies the numerical value of λ . Now, in order to preserve gauge invariance, the coupling constant k is not a free parameter as in \mathbb{R}^3 , but it must be an integer. Given the expectation value $E(L)_{\mathbb{R}^3}$ of a Wilson line operator $W(L)$ in \mathbb{R}^3 , the corresponding expectation value $E(L)_{S^3}$ in S^3 can be obtained simply by taking k integer

$$\langle W(L) \rangle_{S^3} = \langle W(L) \rangle_{\mathbb{R}^3} \quad k \text{ integer} \quad . \quad (1.57)$$

We shall fix the orientation of S^3 by adopting the usual right-handed rule to compute linking numbers (see appendix B). Clearly, a modification of the orientation of S^3 is equivalent to replace k with $-k$ in the action (1.1). Moreover, the value $k = 0$ must be excluded because, when $k = 0$, the action (1.1) vanishes and thus a meaningful CS theory does not exist. Consequently, we may assume that k is positive. Therefore, the relevant values of k that we need to consider are

$$k = \text{integer} \quad , \quad k = \text{positive} \quad . \quad (1.58)$$

Note that also in a generic three-manifold M , which is closed connected and orientable, k is no more a free parameter; gauge invariance under large gauge transformations in M implies [10] that k must take certain integer values. Consequently, ordinary perturbation theory in M is expected to be (in general) ill-defined. Our way to solve the quantum CS theory in a generic manifold M consists of three steps. Firstly, we will solve the theory in \mathbb{R}^3 , where ordinary perturbation theory is reliable and defines the theory unambiguously. Secondly, by taking into account the behavior of the action under large gauge transformations, we will extend the results obtained in \mathbb{R}^3 to the case of the three-sphere S^3 . Finally, we will use the symmetry properties of the topological theory to solve the model in a generic three-manifold M . In this context, the relevant symmetry we will need to consider is related to twist homeomorphisms of solid tori.

Chapter 2

Properties of the observables

2.1 Discrete Symmetries

Let ρ be a representation of G ; the generic element $U \in G$ in the representation ρ can be written as

$$U_\rho = \exp(iT_a[\rho]\theta^a) \quad . \quad (2.1)$$

The complex conjugate of U_ρ^* gives a new representation ρ^* of G ,

$$U_{\rho^*} = U_\rho^* = \exp(-iT_a[\rho]^*\theta^a) \quad . \quad (2.2)$$

From Eq.(2.2), it follows that the generators $T_a[\rho^*]$ in the representation ρ^* are given by $-T_a[\rho]^*$. For a compact group any finite dimensional representation is equivalent to a unitary representation. Thus, without loss of generality, we shall consider only unitary representations of G , i.e. $T_a[\rho]^\dagger = T_a[\rho]$.

Let $W(C; \rho)$ be a Wilson line associated with the knot C and with colour ρ

$$W(C; \rho) = \text{Tr} P \exp \left(i \int_C T_a[\rho] A_\mu^a dx^\mu \right) \quad . \quad (2.3)$$

As a first example of discrete symmetry, we shall study the behavior of $W(C; \rho)$ under the replacement of ρ with ρ^* . By definition we have

$$W(C; \rho^*) = \text{Tr} P \exp \left(-i \int_C T_a[\rho^*] A_\mu^a dx^\mu \right) = \text{Tr} P \exp \left(-i \int_C T[\rho]_a^t A_\mu^a dx^\mu \right) \quad . \quad (2.4)$$

It is not difficult to show by direct inspection that one can replace $T[\rho]_a^t$ by $T[\rho]_a$ in (2.4) simply by reversing the orientation of C and by introducing an overall minus sign in the exponent, i.e.

$$W(C; \rho^*) = \text{Tr} P \exp \left(i \int_{C^{-1}} T[\rho]_a A_\mu^a dx^\mu \right) \quad , \quad (2.5)$$

where C^{-1} denotes the knot obtained from C by reversing its orientation. As result we get [19]

$$W(C; \rho^*) = W(C^{-1}; \rho) \quad . \quad (2.6)$$

The extension of (2.6) to a generic link L is straightforward

$$E(C_1^{-1}, \dots, C_m^{-1}; \rho_1, \dots, \rho_m) = E(C_1, \dots, C_m; \rho_1^*, \dots, \rho_m^*) \quad . \quad (2.7)$$

Clearly the distinction between a representation ρ and its complex conjugate is a matter of convention; as a consequence, given a link L with components $\{C_1, \dots, C_m\}$ with colours $\{\rho_1, \dots, \rho_m\}$,

the expectation value of the associated observable should be invariant under the replacement of $\{\rho_1, \dots, \rho_m\}$ with $\{\rho_1^*, \dots, \rho_m^*\}$. More explicitly

$$E(C_1, \dots, C_m; \rho_1, \dots, \rho_m) = E(C_1, \dots, C_m; \rho_1^*, \dots, \rho_m^*) \quad . \quad (2.8)$$

From equations (2.8) and (2.7) one gets

$$E(C_1, \dots, C_m; \rho_1, \dots, \rho_m) = E(C_1^{-1}, \dots, C_m^{-1}; \rho_1, \dots, \rho_m) \quad . \quad (2.9)$$

Equation (2.9) shows that for the expectation value of $W(L)$, only the relative orientation of the L components is relevant. When a representation ρ is real, i.e. $\rho \sim \rho^*$, one can find a non-singular matrix V such that

$$T[\rho]_a^* = -VT[\rho]_a V^{-1} \quad . \quad (2.10)$$

By using $\exp(VBV^{-1}) = V \exp(B)V^{-1}$ and the cyclicity of the trace one obtains [19]

$$W(C; \rho^*) = W(C; \rho) = W(C^{-1}; \rho) \quad . \quad (2.11)$$

Equation (2.11) implies that when $W(L)$ is associated with real representations, the regular isotopy invariant $E(L)$ does not depend on the orientation of its components $\{C_1, \dots, C_m\}$.

Another useful property can be deduced by taking the complex conjugation of the expectation value $E(L)$ of $W(L)$. By using the path integral representation of $E(L)$ it follows

$$E^*(L) = \int D[A, B, \bar{c}, c] \exp(-iS_{tot}) W^*(C_1, \dots, C_m; \rho_1, \dots, \rho_m) \quad . \quad (2.12)$$

On the other hand, from equation (2.7)

$$\begin{aligned} & W^*(C_1, \dots, C_m; \rho_1, \dots, \rho_m) \\ &= W(C_1, \dots, C_m; \rho_1^*, \dots, \rho_m^*) = W(C_1^{-1}, \dots, C_m^{-1}; \rho_1, \dots, \rho_m) \quad . \end{aligned} \quad (2.13)$$

The change in sign of $S_{eff.}$ is equivalent to reversing the orientation of R^3 (S^3), or to changing k into $-k$. Putting all the pieces together one gets [19]

$$E^*(L, -k) = E(L^{-1}, k) \quad . \quad (2.14)$$

2.2 Tensor algebra

Let \mathcal{R}_G be the set of representations of a compact and simple Lie group G . If $\rho_1, \rho_2 \in \mathcal{R}_G$, then also $\rho_1 \oplus \rho_2 \in \mathcal{R}_G$ and $\rho_1 \otimes \rho_2 \in \mathcal{R}_G$. As a consequence \mathcal{R}_G is actually a ring. \mathcal{R}_G can be extended to an associative and commutative algebra \mathcal{T} over the field \mathbb{C} of the complex numbers [30]. The product between two elements χ_1 and χ_2 of \mathcal{T} will be denoted by $\chi_1 \chi_2$ and the identity element of \mathcal{T} corresponding to the trivial representation of G by $\chi[1]$. The structure constants of \mathcal{T} are determined by the number of irreducible representations contained in the tensor product of two given representations. To be more precise, for each irreducible representation ρ of the gauge group, we shall introduce an element $\chi[\rho] \in \mathcal{T}$; the set $\{\chi[\rho]\}$ of all these elements, which are defined for all the inequivalent irreducible representations, is the set which contains the elements of the standard basis of \mathcal{T} . The structure constants of \mathcal{T} are given by

$$\chi[\rho_1] \chi[\rho_2] = \sum_{\rho} F_{\rho_1, \rho_2, \rho} \chi[\rho] \quad , \quad (2.15)$$

where $F_{\rho_1, \rho_2, \rho}$ is the multiplicity of the irreducible representation ρ which is contained in the decomposition of the tensor product $\rho_1 \otimes \rho_2$. If $\rho \notin \rho_1 \otimes \rho_2$, then the corresponding coefficient

$F_{\rho_1, \rho_2, \rho}$ is vanishing. In the standard basis of \mathcal{T} , the structure constants take non-negative integer values. The symmetry properties of $\{F_{\rho_1, \rho_2, \rho}\}$ are fixed by the simple Lie algebra structure of the gauge group; namely, one has

$$F_{\rho_1, \rho_2, \rho} = F_{\rho_2, \rho_1, \rho} \quad , \quad (2.16)$$

$$F_{\rho_1, \rho_2, \rho} = F_{\rho_1^*, \rho_2^*, \rho^*} \quad , \quad (2.17)$$

and

$$F_{\rho_1, \rho_2, \rho} = F_{\rho_1^*, \rho, \rho_2} \quad , \quad (2.18)$$

where ρ^* is the complex conjugate representation associated with the irreducible representation ρ .

Let the finite-dimensional representation ρ be associated with the framed and oriented knot C . The Wilson line operator $W(C; \rho)$ is also well defined when ρ is not irreducible. Indeed, in this case we can decompose ρ into a direct sum of its irreducible components and, since $W(C; \rho)$ is the trace of the quantum holonomy, $W(C; \rho)$ can accordingly be written as a sum of the Wilson line operators defined for these irreducible components. Consequently, for fixed knot C , $E(C)$ can be understood as a linear function on the representation ring of the gauge group. Given a link L with m components, the expectation value $E(L)$ in $\mathbb{R}^3(S^3)$ can be understood [30] as a multi-linear function on $\mathcal{T}^{\otimes m}$

$$E : \overbrace{\mathcal{T} \otimes \cdots \otimes \mathcal{T}}^m \rightarrow \mathbb{C} \quad . \quad (2.19)$$

Indeed, let $\chi = \sum_i d(i) \chi_i$ be a generic element of \mathcal{T} , the linear extension of $E(C; \chi_i)$ into \mathcal{T} is defined as

$$E(C; \chi) = \sum_i d(i) E(C; \chi_i) \quad , \quad (2.20)$$

where C is a generic knot. The case of $W(L)$ is similar: given a link L with m components $\{C_1, \dots, C_m\}$, the expectation value $E(L)$, for fixed L is a multi-linear functional on $\mathcal{T}^{\otimes m} = \overbrace{\mathcal{T} \otimes \cdots \otimes \mathcal{T}}^m$ defined as

$$E(L; \chi^{(1)}, \dots, \chi^{(m)}) = \prod_{a=1}^m \sum_{j_a} d_a(j_a) \chi_{j_a} E(L; \chi_{j_1}, \dots, \chi_{j_m}) \quad , \quad (2.21)$$

where

$$\chi^{(a)} = \sum_{j_a} d_a(j_a) \chi_{j_a} \quad a = 1, \dots, m \quad (2.22)$$

is the colour of the a th component of L .

2.3 Satellite relations

Let us consider an oriented framed knot C and the set $\{W(C; \rho)\}$ of the associated Wilson line operators which are defined for all the possible inequivalent irreducible representations $\{\rho\}$ of the gauge group. The set $\{W(C; \rho)\}$ is a complete set of gauge invariant observables associated with the knot C [31]. This means that, if $\mathcal{O}(C)$ is a metric-independent gauge invariant observable of

the CS theory which is defined in terms of the vector fields $A_\mu^a(x)$ and $\mathcal{O}(C)$ is associated with the knot C , then $\mathcal{O}(C)$ can always be written as

$$\mathcal{O}(C) = \sum_{\rho} \xi(\rho) W(C; \rho) = \sum_{\rho} \xi(\rho) W(C; \chi[\rho]) \quad , \quad (2.23)$$

where $\{\xi(\rho)\}$ are numerical (complex) coefficients. With a given choice of the framing of C , the coefficients $\{\xi(\rho)\}$ are fixed and characterize the observable $\mathcal{O}(C)$. Any function, which is defined on the equivalence classes of conjugate elements of a compact and simple group, admits a linear decomposition in terms of the characters of the group, of course [32]. Eq.(2.23) is the analogue of this decomposition for the gauge invariant observables which are associated with the knot C .

Eq.(2.23) can be used to derive the generalized satellite relations which [31] are satisfied by $E(L)$. Let V be a solid torus standardly embedded in S^3 ; the oriented core of V will be denoted by K and its preferred framing by K_f . Consider now the oriented and framed component C of a link L in S^3 ; let C_f be the framing of C . A tubular neighborhood N of C is a solid torus embedded in S^3 whose core is C . The two solid tori V and N are homeomorphic; we shall denote by h^\diamond the homeomorphism $h^\diamond : V \rightarrow N$ which has the properties

$$h^\diamond(K) = C \quad , \quad \text{and} \quad h^\diamond(K_f) = C_f \quad . \quad (2.24)$$

Up to an ambient isotopy, the homeomorphism h^\diamond is unique and is determined by the orientation and by the framing of the link component C .

One can imagine that the framed component C of L is the image $h^\diamond(K)$ of the framed knot $K \subset V$ under the homeomorphism h^\diamond . Starting from the link L , we shall now construct a new link L' ; L' is obtained by replacing the component C of L by the image $h^\diamond(P)$ of a given (oriented and framed) link P in V . The link L' is called a generalized satellite of L ; the link L is a companion of L' and $P \subset V$ is called the pattern link.

Suppose now that L' is a generalized satellite of L defined in terms of a given pattern link P . Furthermore, suppose that an irreducible representation of the gauge group has been assigned to each component of P . We would like to know how the expectation value $E(L')$ is connected with $E(L)$; the precise relation between $E(L')$ and $E(L)$ is called a generalized satellite relation. Remember that L' has been obtained from L by replacing the framed component C with the image $h^\diamond(P)$ of the pattern link P . By definition, P belongs to the solid torus V and $W(P)$, which denotes the product of the Wilson line operators associated with P , represents a gauge invariant observable defined in V . Since the CS model is a topological field theory, the thickness of V is totally irrelevant. In the limit in which this thickness goes to zero, the solid torus V degenerates to a simple circle: the core K of V . Thus, $W(P)$ can be understood as a gauge invariant observable associated with the knot K . Consequently, $W(P)$ admits an expansion of the type shown in eq.(2.23)

$$W(P) = \sum_{\rho} \xi(\rho) W(K; \chi[\rho]) \quad . \quad (2.25)$$

The complex coefficients $\{\xi(\rho)\}$, appearing in eq.(2.25), depend on the pattern link P and on the representations assigned to its components. The composite Wilson line operators $\{W(K, \chi[\rho])\}$ are defined for the framed knot K (which has preferred framing). Let us introduce the element χ ,

$$\chi = \sum_{\rho} \xi(\rho) \chi[\rho] \quad , \quad (2.26)$$

of the tensor algebra \mathcal{T} . Then, eq.(2.25) can simply be written as

$$W(P) = W(K; \chi) \quad . \quad (2.27)$$

At this stage, from the defining conditions (4.8) of h^\diamond , it follows immediately [19] that

$$E(L') = E(L; \text{ with the component } C \text{ of } L \text{ associated with } \chi) \quad . \quad (2.28)$$

This equation is a consequence of two basic symmetry properties of the CS theory. Firstly, gauge invariance implies that the non-Abelian “electric” flux associated with a meridinal disc of a solid torus must be conserved. Secondly, general covariance implies that this flux can always be imagined to be concentrated on a single knot which coincides with the core of the solid torus.

The satellite relation (2.28) represents one of the main properties of the expectation values $\{E(L)\}$. The ξ -coefficients, appearing in eq.(2.25), can be determined by using several different methods; some of them have been presented in Ref.[3,4].

Let us consider a particular example of satellite relation which will be used frequently in the following sections. We shall consider a particular pattern link B in the solid torus V . Since the complement of a tubular neighborhood M of the circle U in S^3 is a solid torus standardly embedded in S^3 , we can take $V = S^3 - \dot{M}$, where \dot{M} is the interior of M . Consequently, we shall represent B in the complement of U in S^3 . The pattern link B , in which we are interested, is the two component framed and oriented link shown in Fig.2.1; each component of B has preferred framing.

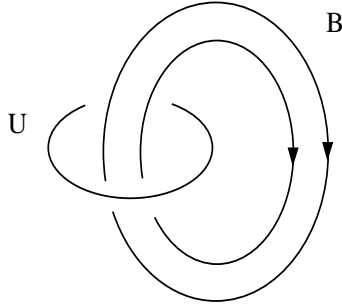

Figure 2.1

Let ρ_1 and ρ_2 be the irreducible representations which are assigned to the two components C_1 and C_2 of B ; we shall derive the explicit form the coefficient ξ_ρ appearing in the decomposition (2.25). By definition C_1 e C_2 have preferred framing i.e.

$$\chi(C_1, C_{1f}) = \chi(C_2, C_{2f}) = \chi(C_1, C_2) = 0 \quad . \quad (2.29)$$

In the limit in which the “distance” between C_1 and C_2 goes to zero, because of (2.29), the knot C_2 cannot be distinguished from the framing C_{1f} of C_1 . Thus in this limit we can replace the two Wilson lines $W(C_1, \rho_1)$ and $W(C_2, \rho_2)$ with a single Wilson line $W(K, \rho')$, with K is a knot ambient isotopic to C_1 (see figure 2.2).

In particular one can identify K with the core of the solid torus V in which the pattern link B is contained. In order to determine $\rho' \in \mathcal{T}$, we note that the representation of G associated with $W(K)$ is contained in $\rho_1 \otimes \rho_2$. Indeed

$$tr(\rho_1) tr(\rho_2) = tr(\rho_1 \otimes \rho_2) \quad . \quad (2.30)$$

In conclusion the element ρ' has to be identified with $\chi[\rho_1]\chi[\rho_2]$, thus one gets

$$\begin{aligned} W(B; \chi[\rho_1], \chi[\rho_2]) &= W(K; \chi[\rho_1]\chi[\rho_2]) \\ &= \sum_{\rho} F_{\rho_1, \rho_2, \rho} W(K; \chi[\rho]) \quad . \end{aligned} \quad (2.31)$$

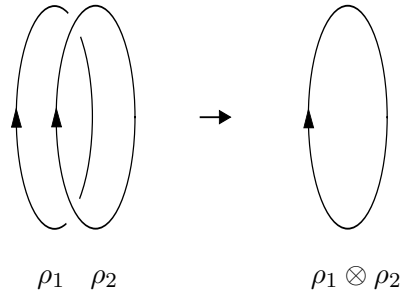

Figure 2.2

where K is the framed core of V which has preferred framing and is oriented as the components of B , see Fig.2.3. In eq.(2.31) one can easily recognize the structure constants of \mathcal{T} .

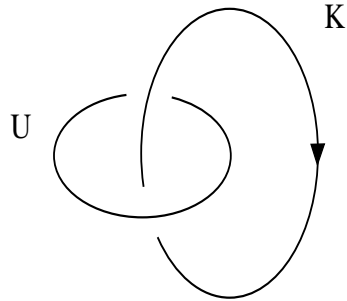

Figure 2.3

Thus, for the satellites constructed with the pattern link B , eq.(2.28) takes the form

$$\begin{aligned}
 E(L') &= E(h^\diamond(B), C', \dots; \chi[\rho_1], \chi[\rho_2], \chi[\rho'], \dots) \\
 &= E(C, C', \dots; \chi[\rho_1] \chi[\rho_2], \chi[\rho'], \dots) \\
 &= \sum_{\rho} F_{\rho_1, \rho_2, \rho} E(C, C', \dots; \chi[\rho], \chi[\rho'], \dots) \quad . \quad (2.32)
 \end{aligned}$$

2.4 Calculation rules

Topological field theories are rigid in the sense that, due to the presence of a large symmetry, the expectation values of the observables are strongly constrained. These constraints can be put in the form of consistency relations that the observables must satisfy. In the case of Chern-Simons theory, the consistency relations are stringent enough to determine uniquely the values of the observables. In other words, Chern-Simons theory is exactly solvable. In this section we shall give a few rules [19, 31] that will permit us to solve the theory.

(1) Projection decomposition

As we shown in appendix B, link diagrams can be understood as closures of braids.

Let us consider the configuration corresponding to two parallel strings associated with the irre-

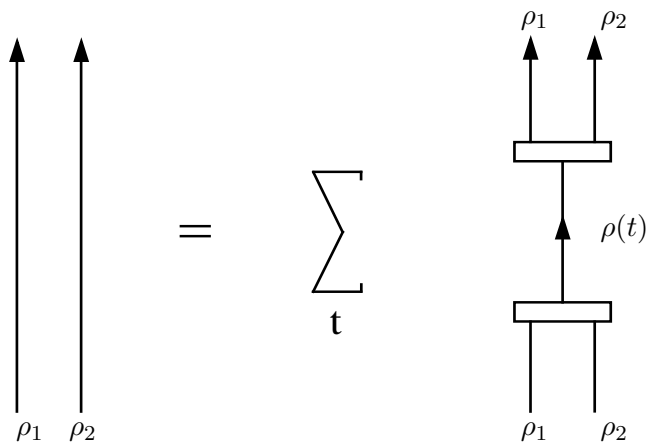

Figure 2.4

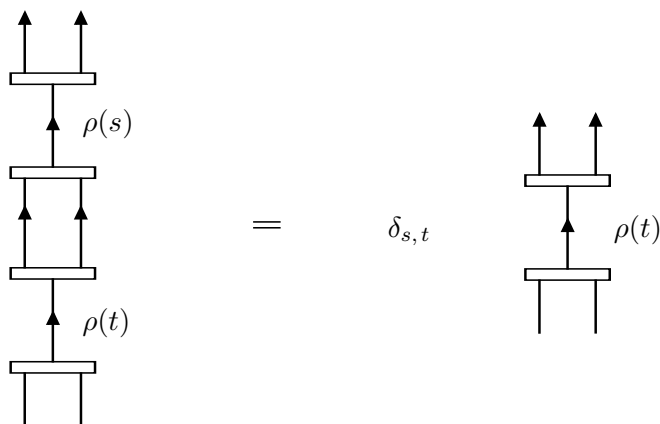

Figure 2.5

ducible representation ρ_1 and ρ_2 of G satisfying

$$\rho_1 \otimes \rho_2 = \sum_t \rho(t) \quad . \quad (2.33)$$

The projection decomposition rule involves a local modification of the link diagram obtained by introducing a set of orthogonal projectors as shown in Fig.2.4. By means of the projection decomposition rule, the various irreducible representations entering (2.33) are single out. The orthogonality property of the projectors is expressed by the relation shown in Fig.2.5.

(2) Crossing

The Chern-Simons field theory can be quantized by using the canonical formalism rather than then the covariant BRS method. Although the method of canonical quantization is not viable in the calculation of expectation values of observables, it can be profitably used in the study of Chern-Simons monodromies. The configuration space \mathbb{R}^3 is sliced in space-like surfaces, in any slice the equal-time canonical commutation relations are imposed.

The state Ψ , corresponding to a configuration with two strings piercing the surface $t = 0$ and associated with the irreducible representations ρ_1, ρ_2 , is interpreted as the introduction in the

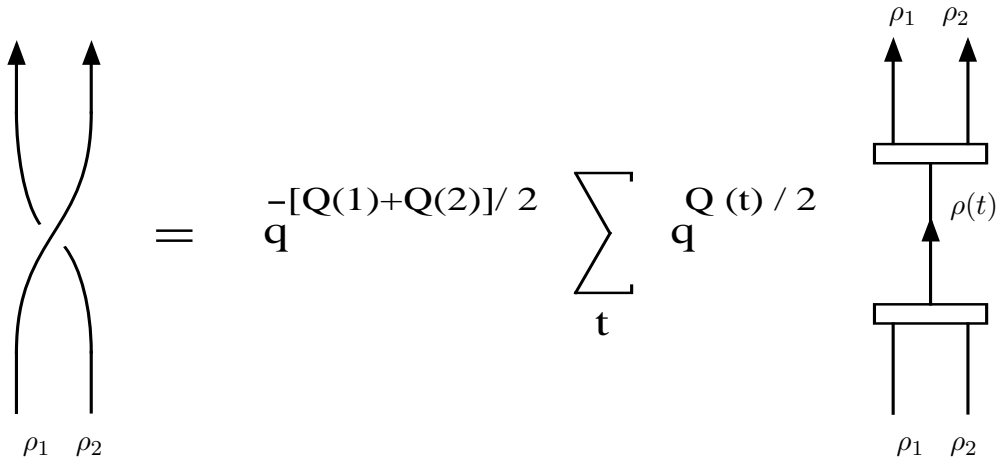

Figure 2.6

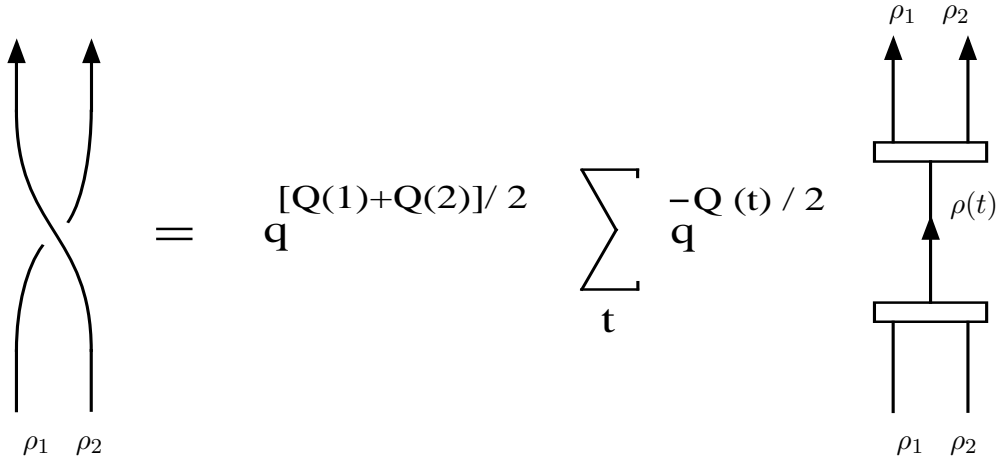

Figure 2.7

vacuum state of two static sources with quantum numbers ρ_1 and ρ_2 . The problem of how the state Ψ changes when the sources are exchanged can be analyzed by using the canonical quantization in the Schroedinger representation for the field. If the new state after the exchange is denoted by Ψ' , one obtains

$$\Psi' = M \Psi \quad ; \tag{2.34}$$

for notation simplicity all indices have been suppressed. The matrix M that encodes the braiding properties of Chern-Simons theory is given by [29]

$$M = \Pi_{12} q^{T_{(\rho_1)}^a \otimes T_{(\rho_2)}^a} \quad , \tag{2.35}$$

where Π_{12} is the permutation operator of the two sources and

$$q = e^{-i2\pi/k} \tag{2.36}$$

is the so-called deformation parameter. Eq.(2.35), together with the projection decomposition rule and the identity

$$T_{(\rho_1)}^a \otimes T_{(\rho_2)}^a = \frac{1}{2} [Q(\rho_1 \otimes \rho_2) - Q(\rho_1) - Q(\rho_2)] \mathbf{1} \otimes \mathbf{1} \tag{2.37}$$

lead to the crossing rule shown in Fig.2.6 and in Fig.2.7.

(3) Twisting

This rule refers to the behavior of a braid under a Markov move of type 2 (see App.B) and is summarized in Fig.2.8

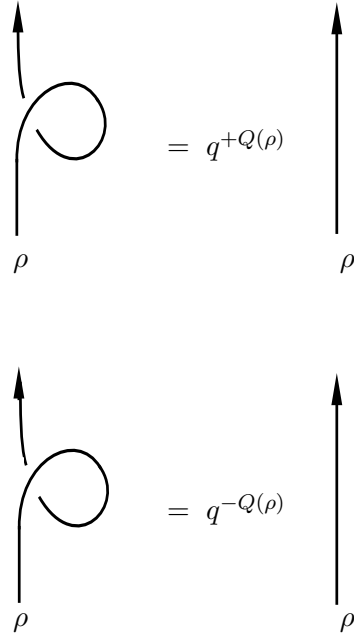

Figure 2.8

The value $q^{\pm Q(\rho)}$ of the twist variable $\alpha(\rho)$ fits the perturbative analysis given in [18]. In addition, it can be shown [31] that is the only value with the right classical limit ($\alpha \rightarrow 1$ when $k \rightarrow \infty$) and compatible with the satellite relations and with expression (2.35) for the braid matrix.

(4) Projection compatibility

This rule expressed by Fig.2.9 sets the natural compatibility between the satellite relation (2.32) and the projectors introduced by rule 1. Note that when rules 1 and 2 are used in a link diagram its character is altered due to the presence of projectors. Relations between link diagrams in which projectors are present cannot be used directly to obtain relations involving expectation values of observables. The point is that projectors must be eliminated in favor of some suitable combination of strings. Rule (4) plays a key to eliminate projectors from a link diagram.

(5) Factorization

If the link $L \subset \mathbb{R}^3(S^3)$ is the distant (disjoint) union of the links L_1 and L_2 , we shall write $L = L_1 \cup L_2$; general covariance implies [19] that

$$E(L_1 \cup L_2) = E(L_1) E(L_2) \quad . \quad (2.38)$$

Let us consider an example. The Hopf link shown in Fig.1.1 can be obtained from the closure of the braid shown in Fig.2.10. In order to compute the expectation value of a Wilson line $W(C_1, C_1; \rho_1, \rho_2)$ associated with the Hopf link (by using the crossing rule) one can replace the over-crossing configurations in the braid of Fig.2.10 by means of projectors. After that, the orthogonality property (see Fig.2.5) can be used to eliminate one of two projectors. As final step, the projection compatibility

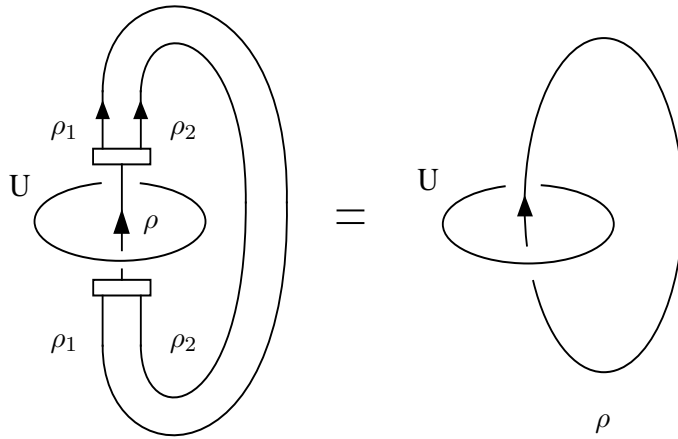

Figure 2.9

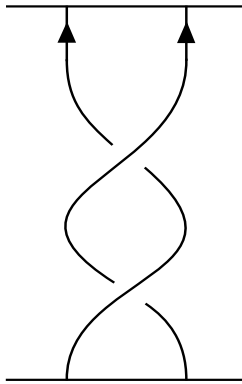

Figure 2.10

is used in order to obtain a standard link diagram. The result is

$$H[\rho_1, \rho_2] = q^{-[Q(\rho_1)+Q(\rho_2)]} \sum_{\rho_t \in \rho_1 \otimes \rho_2} q^{Q(\rho_t)} E_0[\rho_t] \quad . \quad (2.39)$$

Thus, by using the calculation rules the expectation values of the observables corresponding to the Hopf link can be expressed in terms of the observables associated with the unknot, i.e. a knot ambient isotopic to the standard circle in \mathbb{R}^3 .

2.5 Connected sum

Let us consider the connected sum of links. Suppose that L_1 and L_2 are two disjoint links in S^3 and that the oriented components $C \in L_1$ and $C' \in L_2$ are associated with the irreducible representation ρ of the gauge group. Starting from the distant union $L_1 \cup L_2$, one can construct a new link which is called the connected sum of L_1 and L_2 . Inside some fixed three-ball in S^3 , the two components C

and C' are cut and glued together as shown in Figure 2.4. The resulting new link is the connected sum $L_1 \# L_2[\rho]$ of L_1 and L_2 which has been obtained by acting on two link components with colour given by the irreducible representation ρ .

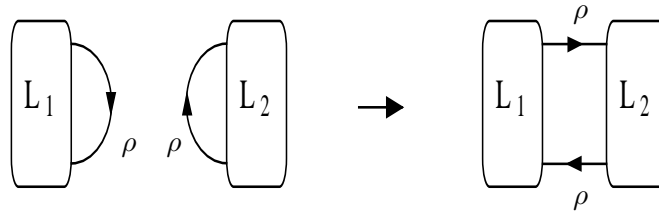

Figure 2.11

The expectation values for the connected sums of links satisfy the relation [19]

$$E(L_1 \# L_2[\rho]) = \frac{E(L_1) E(L_2)}{E_0[\rho]}, \quad (2.40)$$

where $E_0[\rho]$ is the expectation value of the Wilson line operator associated with the unknot (circle) in S^3 with preferred framing and with colour given by the irreducible representation ρ of G .

Chapter 3

SU(2) and SU(3) Examples

3.1 SU(2)

For future convenience, in this section we shall collect the values of the unknot and of the Hopf link when the gauge group is $G = SU(2)$. Detailed proofs of can be found in [19, 31].

Any irreducible and finite dimensional representation of $SU(2)$ can be parametrized by a single label J with $2J \in \mathbb{N}$. The value of the quadratic Casimir operator $Q(J)$ in the representation J is

$$Q(J) = J(J + 1) \quad , \quad (3.1)$$

the dimension $D(J)$ of the irreducible representation J is

$$D(J) = 2J + 1 \quad . \quad (3.2)$$

The value of the unknot $E_0[J]$ in the representation J is [19]

$$E_0[J] = \frac{q^{(2J+1)/2} - q^{-(2J+1)/2}}{q^{1/2} - q^{-1/2}} = \frac{\sin[(2J + 1)\pi/k]}{\sin(\pi/k)} \quad . \quad (3.3)$$

Finally, the expectation value of the Hopf link with colours $\chi[J_1]$ and $\chi[J_2]$ is given by [19]

$$H[J_1, J_2] = \frac{q^{(2J_1+1)(2J_2+1)/2} - q^{-(2J_1+1)(2J_2+1)/2}}{\sin(\pi/k)} \quad . \quad (3.4)$$

3.2 SU(3)

The satellite relation (2.32) will play a crucial role in our construction. In fact, we will use systematically the pattern link B , shown in Fig.2.1, to construct satellites. We shall define a recursive procedure in order to replace each link component, which is associated with a higher dimensional representations of $SU(3)$, with a suitable cabled component. In order to introduce the cabling procedure, however, we need to discuss some basic properties of the representation ring of $SU(3)$.

We shall use Dynkin labels to denote the irreducible representations of $SU(3)$. For each couple of non-negative integers (m, n) , the associated irreducible representation corresponds to the highest weight μ given by

$$\mu = m \mu^{(1)} + n \mu^{(2)} \quad , \quad (3.5)$$

where $\mu^{(1)}$ and $\mu^{(2)}$ are the fundamental weights of $SU(3)$. Thus, $(0, 0)$ is the trivial representation, $(1, 0)$ denotes the fundamental representation $\mathbf{3}$ and $(0, 1)$ its complex conjugate $\mathbf{3}^*$. The representation (m, n) has dimension

$$D(m, n) = \frac{(m+1)(n+1)(m+n+2)}{2} \quad , \quad (3.6)$$

and the value $Q(m, n)$ of the corresponding quadratic Casimir operator is given by

$$Q(m, n) = \frac{m^2 + n^2 + mn + 3(m + n)}{3} . \quad (3.7)$$

Given two representations (m, n) and (a, b) , the decomposition of the tensor product $(m, n) \otimes (a, b)$ into a sum of irreducible components can be obtained, for instance, by means of the standard Young tableaux method. The following relations will be useful for our discussion.

For $m \geq 1$ and $n \geq 1$, one has

$$(m, n) \otimes (1, 0) = (m + 1, n) \oplus (m - 1, n + 1) \oplus (m, n - 1) , \quad (3.8)$$

$$(m, n) \otimes (0, 1) = (m, n + 1) \oplus (m + 1, n - 1) \oplus (m - 1, n) . \quad (3.9)$$

For $m \geq 1$, one obtains

$$(m, 0) \otimes (1, 0) = (m + 1, 0) \oplus (m - 1, 1) , \quad (3.10)$$

$$(m, 0) \otimes (0, 1) = (m, 1) \oplus (m - 1, 0) . \quad (3.11)$$

Finally, for $n \geq 1$, one gets

$$(0, n) \otimes (1, 0) = (1, n) \oplus (0, n - 1) , \quad (3.12)$$

$$(0, n) \otimes (0, 1) = (0, n + 1) \oplus (1, n - 1) . \quad (3.13)$$

Unlike the case of the group $SU(2)$, an explicit formula which gives the decomposition of the tensor product $(m, n) \otimes (a, b)$, for arbitrary representations (m, n) and (a, b) of $SU(3)$, is not known. Thus, for $SU(3)$ one has to analyze, in general, each single tensor product separately. Even if the structure of the $SU(3)$ tensor algebra \mathcal{T} cannot be displayed in compact form, we will show how to derive the relevant properties of \mathcal{T} and of its associated reduced tensor algebra $\mathcal{T}_{(k)}$. In fact, in order to study the properties of the tensor algebra, we only need to consider the relations (3.8)-(3.13).

Let us denote by R the representation ring of $SU(3)$ and by $\mathcal{P}(y, \bar{y})$ the ring of (finite) polynomials in the two variables y and \bar{y} with integer coefficients. We shall now show that R admits a faithful representation in $\mathcal{P}(y, \bar{y})$. This is a standard result of the theory of simple Lie algebras and its validity is based on the fact that the Lie algebra associated with $SU(3)$ has rank two, of course. Here, we shall just recall the main arguments of the proof in order to illustrate how the recursive use of eqs.(3.8)-(3.13) determines the structure of R and, therefore, the structure of \mathcal{T} [33].

Each irreducible representation of $SU(3)$ is associated with an element of R ; the set of the elements which correspond to all the inequivalent irreducible representations of $SU(3)$ is called the standard basis of \mathcal{T} . R is a commutative ring with identity; consequently, for each element (m, n) of the standard basis, we only need to give the corresponding representative $[m, n]$ in $\mathcal{P}(y, \bar{y})$. On the one hand, the ring R is generated by the two elements associated with the fundamental weights of $SU(3)$ plus the identity. On the other hand, $\mathcal{P}(y, \bar{y})$ is generated by the two elements y and \bar{y} plus the identity. Thus, the starting point is the obvious correspondence

$$(0, 0) \longleftrightarrow [0, 0] = 1 , \quad (3.14)$$

$$(1, 0) \longleftrightarrow [1, 0] = y , \quad (3.15)$$

$$(0, 1) \longleftrightarrow [0, 1] = \bar{y} . \quad (3.16)$$

Now, we need to find the representative $[m, n] \in \mathcal{P}(y, \bar{y})$ of a generic representation (m, n) . Let us consider firstly the set of representations of the type $(m, 0)$ with $m > 1$. From eq.(3.10), one finds

$$[2, 0] = [1, 0] \cdot [1, 0] - [0, 1] \quad . \quad (5.13)$$

Therefore,

$$[2, 0] = y^2 - \bar{y} \quad . \quad (5.14)$$

In general, eqs.(3.10) and (3.11) imply that

$$[m + 2, 0] = [m - 1, 0] + [m + 1, 0] \cdot [1, 0] - [m, 0] \cdot [0, 1] \quad . \quad (3.17)$$

Equation (3.17) must hold for any $m \geq 1$ and gives a recursive relation for the elements $\{[m, 0]\}$. Since we already know $[2, 0]$, $[1, 0]$, $[0, 1]$ and $[0, 0]$, this recursive relation determines $[m, 0]$, for arbitrary m , uniquely. For example, one finds

$$[3, 0] = y^3 - 2y\bar{y} + 1 \quad , \quad (3.18)$$

$$[4, 0] = y^4 - 3y^2\bar{y} + \bar{y}^2 + 2y \quad . \quad (3.19)$$

The same argument, based on eqs.(3.12) and (3.13), can be used to find the polynomials $\{[0, n]\}$ associated with the representations $\{(0, n)\}$, of course. Equivalently, since $(0, m)$ is the complex conjugate of $(m, 0)$, the polynomial $[0, m]$ can be obtained from $[m, 0]$ simply by exchanging y with \bar{y} and vice versa. Therefore, at this stage, all the polynomials of the type $\{[m, 0]\}$ and $\{[0, n]\}$ are uniquely determined for arbitrary m and n .

From eq.(3.11), one obtains

$$[m, 1] = [m, 0] \cdot [0, 1] - [m - 1, 0] \quad . \quad (3.20)$$

This equation, which holds for any $m \geq 1$, permits us to find all the polynomials of the type $\{[m, 1]\}$. Similarly, eq.(3.12) defines the recursive relation

$$[1, n] = [0, n] \cdot [1, 0] - [0, n - 1] \quad , \quad (3.21)$$

which uniquely fixes the polynomials $\{[1, n]\}$ for arbitrary n . Finally, let us consider a generic representation (m, n) ; the associated polynomial $[m, n] \in \mathcal{P}(y, \bar{y})$ can be determined, for instance, by using a recursive procedure in the values of the index n . Indeed, eq.(3.8) gives

$$[m, n + 1] = [m, n] \cdot [0, 1] - [m + 1, n - 1] - [m - 1, n] \quad . \quad (3.22)$$

Assume, by induction, that the polynomials $\{[m, n]\}$ are known for arbitrary m and for $n \leq n_0$. Then, eq.(3.22) can be used to find $[m, n_0 + 1]$. On the other hand, $[m, 0]$ and $[m, 1]$ are known; therefore, eq.(3.22) permits us to find $[m, n]$ for generic values of m and n .

To sum up, the representation ring R of $SU(3)$ can conveniently be described by $\mathcal{P}(y, \bar{y})$; we have also proved that the polynomial $[m, n]$, which is associated with the generic representation (m, n) , is uniquely determined by the relations (3.8)-(3.13) [33]. A few examples of representative polynomials are in order:

$$[0, 2] = \bar{y}^2 - y \quad , \quad [1, 1] = y\bar{y} - 1 \quad , \quad (3.23)$$

$$[2, 1] = y^2\bar{y} - \bar{y}^2 - y \quad , \quad (3.24)$$

$$[3, 1] = y^3\bar{y} - 2y\bar{y}^2 - y^2 + 2\bar{y} \quad , \quad (3.25)$$

$$[2, 2] = y^2 \bar{y}^2 - y^3 - y \bar{y}^3 \quad . \quad (3.26)$$

In general, one finds

$$[m, n] = \sum_{i+j \leq m+n} a_{ij} y^i \bar{y}^j \quad , \quad (3.27)$$

where $\{a_{ij}\}$ are integer numbers and $a_{mn} = 1$. The given representation of R in $\mathcal{P}(y, \bar{y})$ is particularly convenient for our purposes. Indeed, each polynomial (3.27) provides the explicit connection between the elements of the standard basis of \mathcal{T} and the elements of the new basis defined in terms of the powers of $(1, 0)$ and $(0, 1)$, which correspond to the monomials $\{y^i \bar{y}^j\}$. To be more precise, let us denote by $\chi[m, n]$ the element of the standard basis of \mathcal{T} which is associated with the representation (m, n) of $SU(3)$. Eq.(3.27) implies that

$$\chi[m, n] = \sum_{i+j \leq m+n} a_{ij} (\chi[1, 0])^i (\chi[0, 1])^j \quad , \quad (3.28)$$

where the coefficients $\{a_{ij}\}$ appearing in eq.(3.28) coincide with the coefficients $\{a_{ij}\}$ entering eq.(3.27).

3.2.1 Computing the link polynomials

The quantum CS field theory is exactly solvable because, with a finite number of operations, one can find the exact expression of $E(L)$ for a generic link L . As we have already mentioned, $E(L)$ can easily be computed by using the rules introduced in [19, 31] and are in agreement with the results obtained in perturbation theory, of course.

In order to compute $E(L)$, one can use standard cabling; this method consists of two steps. Firstly, we shall give the rules for the computation of a generic link when each link component has colour specified by the fundamental representation of $SU(3)$. Secondly, we shall introduce a recursive procedure, which is based on the use of the satellite relation (2.32), to compute the link invariants when the colours of the link components are arbitrary [33].

Theorem 3.1

Let L be a link diagram with components $\{C_1, C_2, \dots, C_n\}$ in which each component is oriented and has a colour given by the fundamental representation $\mathbf{3}$ of $SU(3)$. The associated expectation value,

$$E(L) = E(C_1, C_2, \dots, C_n; \mathbf{3}, \mathbf{3}, \dots, \mathbf{3}) \quad , \quad (3.29)$$

is uniquely determined by

1. *regular isotopy invariance;*
2. *covariance under an elementary modification of the writhe;*
3. *skein relation;*
4. *value of the unknot with zero writhe.*

This theorem has been proved in [31]. Given link diagram L ; let us modify the writhe $w(C)$ of a single component C according to $w(C) \rightarrow w'(C) = w(C) \pm 1$. Let us denote by $L^{(\pm)}$ the new link diagram which has been obtained from L according to the above procedure. Then, point (2) means that [19]

$$E(L^{(\pm)}) = q^{\pm 4/3} E(L) \quad . \quad (3.30)$$

The skein relation mentioned in point (3) is given by [19]

$$q^{1/6} E(L_+) - q^{-1/6} E(L_-) = [q^{1/2} - q^{-1/2}] E(L_0) \quad , \quad (3.31)$$

where the configurations L_{\pm} and L_0 are shown in Fig.3.1.

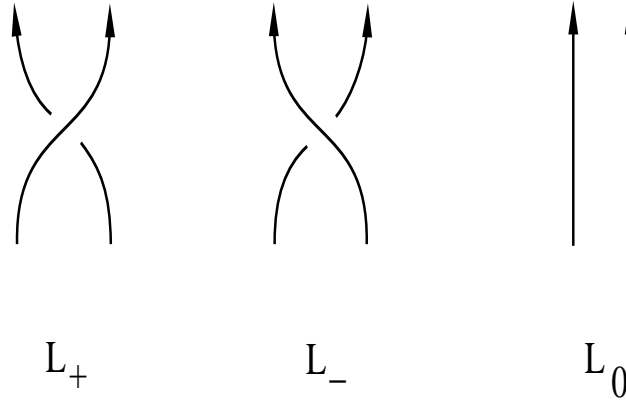

Figure 3.1

Finally, the normalization of $E(L)$ is fixed by the value $E(U_0; \mathbf{3})$ of the unknot U_0 with writhe equal to zero. This value cannot be chosen arbitrarily but is uniquely fixed [2] by the field theory. For the gauge group $SU(3)$, the value of the unknot is [19]

$$E(U_0; \mathbf{3}) = E_0[\mathbf{3}] = q + 1 + q^{-1} \quad ; \quad (3.32)$$

the general expression for the unknot will be derived in the next section section
 One of the consequences of Theorem 3.1 is the following:

Property 3.1 *For any framed, oriented and coloured link L with colours given by the fundamental representation $\mathbf{3}$ of $SU(3)$, the associated expectation value $E(L)$ is a finite Laurent polynomial in the variable x given by*

$$x = q^{1/3} \quad . \quad (3.33)$$

Proof The value (3.32) of the unknot with zero writhe is a finite Laurent polynomial in x and, because of eq.(6.3), the value of the unknot with arbitrary writhe also belongs to $Z[x^{\pm 1}]$. By means of the skein relation (3.31) and of eqs.(3.30) and (3.32), one obtains that, for the distant union of an arbitrary number of unknots, the associated invariant belongs to $Z[x^{\pm 1}]$. This result is in perfect agreement with property (2.38), of course. Now, by using the skein relation recursively, $E(L)$ can be written as a finite linear combination of the invariants associated with the the distant union of unknots in which each unknot may have a nontrivial writhe. Thus, we only need to prove that the coefficients, entering this linear combination, belong to $Z[x^{\pm 1}]$. Let us consider the standard ascending method [34] to construct $E(L)$. This recursive method is based on the observation that

any given link diagram can be transformed into a distant union of unknots provided some over-crossings are exchanged for under-crossings or vice versa. At each step of this recursive procedure, the skein relation (6.4) can be written in the form

$$E(L_+) = q^{-1/3} E(L_-) + \left[q^{1/3} - q^{-2/3} \right] E(L_0) \quad , \quad (3.34)$$

or

$$E(L_-) = q^{1/3} E(L_+) - \left[q^{2/3} - q^{-1/3} \right] E(L_0) \quad . \quad (3.35)$$

Since all the coefficients appearing in eqs.(3.34) and (3.35) belong to $Z[x^{\pm 1}]$, the inductive ascending procedure permits us to express $E(L)$ as a linear combination of the values of the unknots in which all the coefficients entering this linear combination belong to $Z[x^{\pm 1}]$. Therefore, Property 3. 1 is proved. \square

At this stage, we are able to compute $E(L)$ when the link components have colours which are given by the trivial representation, or the fundamental representation $\mathbf{3}$ or its complex conjugate $\mathbf{3}^*$. Indeed, each component associated with the trivial representation can be eliminated and each oriented component, associated with $\mathbf{3}^*$, is equivalent to the same component with opposite orientation associated with $\mathbf{3}$. Consequently, by means of Theorem 3.1, we can easily compute $E(L)$.

Let us now consider the case in which the colours of the link components correspond to generic representations $\{(m, n)\}$ of $SU(3)$. In order to compute the expectation value of the associated Wilson line operator, one can use standard cabling. This method is based on the satellite relations and on eq.(3.28). Suppose that a given link component is characterized by an irreducible representation (m, n) of $SU(3)$ which is different from $(0, 0)$, $(1, 0)$ and $(0, 1)$. In this case, this component will be replaced by the image under h^\diamond of an appropriate linear combination of pattern links. We conclude this section by recalling that several properties of the link polynomials defined by Theorems 3.1 and 3.2 have been discussed in Ref.[4]. In particular, the computation of $E(L)$ can be simplified by means of the rules introduced in [2]; for example, instead of using standard cabling, $H[\rho_1; \rho_2]$ can be determined by means of eq.(8.13). It should be noted that the covariance property of $E(L)$ under an elementary modification of the writhe can be expressed in the following general form. Let L be an oriented link diagram in which the component C has writhe $w(C)$ and colour $\chi[m, n]$. Consider now the new link diagram $L^{(\pm)}$ which has been obtained from L by means of an elementary modification of the writhe of C :

$$w(C) \rightarrow w'(C) = w(C) \pm 1 \quad . \quad (3.36)$$

By using the twisting calculation rule of Chapter 2, one has

$$E(L^{(\pm)}) = q^{\pm Q(m, n)} E(L) \quad , \quad (3.37)$$

where $Q(m, n)$ is the value of the quadratic Casimir operator in the irreducible representation (m, n) of $SU(3)$.

Pattern links are chosen to have all their components associated with $(1, 0)$, or $(0, 1)$, or $(0, 0)$. Such pattern links always exist and are determined precisely by eq.(3.28). When all the link components which are associated with higher dimensional representations of $SU(3)$ have been substituted, one gets a linear combination of satellites in which all the link components have colours $(1, 0)$, or $(0, 1)$ or $(0, 0)$ and, by means of Theorem 3.1, one can finally compute the expectation value of the observable. We shall now give the details of this construction.

Let us denote by $B(ij)$ the pattern link shown in Fig.3.2; $B(ij)$ is defined in the solid torus which coincides with the complement of the circle U in S^3 . The link $B(ij)$ has $i + j$ oriented components and each component has preferred framing. The satellite of a knot constructed with the pattern

link $B(ij)$ is called a cabled knot. Let us assume that i components of $B(ij)$ have colour $\chi[1, 0]$ and j components have colour $\chi[0, 1]$; we shall denote by $W(B(ij))$ the product of the associated Wilson line operators. According to eq.(2.25), $W(B(ij))$ admits an expansion of the type

$$W(B(ij)) = \sum_{\rho} \xi(\rho) W(K; \chi[\rho]) \quad , \quad (3.38)$$

where K is the core of the solid torus (with preferred framing), shown in Fig.2.3. The coefficients $\{\xi(\rho)\}$ entering eq.(3.38) can be determined by using eq.(2.31) recursively. So, these coefficients are uniquely determined by the structure constants of the tensor algebra \mathcal{T} . Consequently, if the element $\chi[m, n]$ admits the presentation shown in eq.(3.28), one obtains

$$W(K; \chi[m, n]) = \sum_{i+j \leq m+n} a_{ij} W(B(ij); \chi[1, 0], \dots, \chi[0, 1], \dots) \quad . \quad (3.39)$$

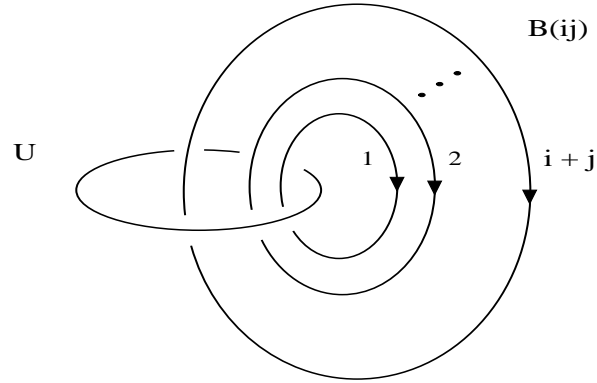

Figure 3.2

Now, let C be a generic component of a link with colour $\chi[m, n]$. As we have already mentioned, the oriented and framed component C can be understood to be the image $h^\diamond(K)$ of the oriented and framed knot K (with colour $\chi[m, n]$) under the homeomorphism h^\diamond defined in section 2.3. Consequently, eq.(3.39) implies that C can be replaced by a linear combination of cabled components according to

$$C \text{ with colour } [m, n] \longleftrightarrow \sum_{i+j \leq m+n} a_{ij} h^\diamond(B(ij)) \quad . \quad (3.40)$$

Equation (3.40) gives the desired relation which is satisfied by the CS expectation values of the observables; each link component, which is associated with a higher dimensional representation of $SU(3)$, is equivalent to a certain linear combination of cabled components which have colours given by the fundamental representation $\mathbf{3}$ or $\mathbf{3}^*$. The coefficients $\{a_{ij}\}$ entering this linear combination are determined by the structure constants of the tensor algebra of the gauge group and are integer numbers.

Theorem 3.2

Let L be an oriented link diagram in which an irreducible representation of $SU(3)$ is attached to each component. The associated expectation value $E(L)$ can be computed

by means of standard cabling. $E(L)$ represents a regular isotopy invariant of oriented coloured link diagrams; moreover, $E(L) \in Z[x^{\pm 1}]$.

Proof According to the standard cabling procedure, each link component which is associated with a higher dimensional representation of $SU(3)$ can be replaced by the combination of cabled components shown in eq.(3.40). Consequently, $E(L)$ can be written as a sum of satellites in which all the components have colours given by the trivial representation, or the representation $\mathbf{3}$ or its complex conjugate $\mathbf{3}^*$. Theorem 3.1 then implies that $E(L)$ is a regular isotopy invariant of oriented and coloured link diagrams. Finally, since the coefficients $\{a_{ij}\}$ entering eq.(6.11) are integer numbers, $E(L)$ is a linear combination with integer coefficients of the invariants defined in Theorem 3.1. Therefore, according to Property 3.1, $E(L)$ belongs to $Z[x^{\pm 1}]$. \square

Theorems 3.1 and 3.2 are the reconstruction theorems which determine the expectation values of the observables of the non-Abelian $SU(3)$ CS theory in \mathbb{R}^3 . Let us consider a few examples of link polynomials. We shall denote by $E_0[m, n]$ the value of the unknot with preferred framing and with colour $\chi[m, n]$. One has

$$E_0[2, 0] = E_0[0, 2] = (1 + q^{-2}) \frac{(1 - q^3)}{(1 - q)} , \quad (3.41)$$

$$E_0[1, 1] = (1 + q)^2 (1 + q^{-2}) , \quad (3.42)$$

$$E_0[4, 1] = E_0[1, 4] = \frac{(q^{-5} - 1)(1 - q^7)}{(1 - q)^2} . \quad (3.43)$$

For the right-handed trefoil 3_1 (with vertical framing convention), shown in Fig.3.3, one finds

$$E(3_1; \chi[1, 0]) = (q + 1 + q^{-1})(q^2 + 1 - q^{-2}) , \quad (3.44)$$

$$E(3_1; \chi[2, 0]) = \frac{(1 + q^{-2})(1 - q^3)}{(1 - q)} [q^6 + q^3 + q^2 - q - q^{-2} - q^{-3} + q^{-5}] . \quad (3.45)$$

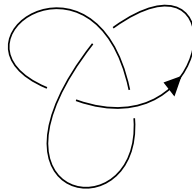

Figure 3.3

The figure-eight knot 4_1 is shown in Fig.3.4; one gets

$$E(4_1; \chi[1, 0]) = q^4 + q^3 - 1 + q^{-3} + q^{-4} , \quad (3.46)$$

$$\begin{aligned}
E(4_1; \chi[2, 0]) &= q^{-10} (1 + q^{18}) \frac{(1 - q^3)}{(1 - q)} \\
&\quad - q^{-7} (1 + q^{11}) \frac{(1 - q^4)}{(1 - q)} + q^{-2} (1 + q^2) (1 + q)^2 \quad . \quad (3.47)
\end{aligned}$$

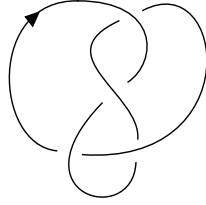

Figure 3.4

For the knot 5_1 , shown in Fig.3.5, one obtains

$$E(5_1, \chi[1, 0]) = \frac{(1 - q^3)(1 + q^2 - q^{-4})}{(1 - q)} q^{-1/3} \quad , \quad (3.48)$$

$$\begin{aligned}
E(5_1; \chi[2, 0]) &= \frac{(1 - q^3)(1 + q^2)}{(1 - q)} q^{-31/3} \\
&\quad + \frac{(1 - q^3)(1 - q^5)}{(1 - q)^2} \left[\frac{(1 + q^3)}{(1 + q)} - q^{-9} \right] q^{8/3} \quad . \quad (3.49)
\end{aligned}$$

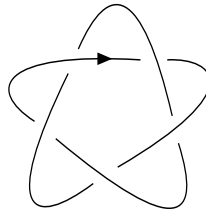

Figure 3.5

Finally, for the Whitehead link 5_2^1 , shown in Fig.3.6, one finds

$$\begin{aligned}
E(5_2^1; \chi[2, 0], \chi[1, 0]) &= \frac{(1 + q^2)(1 - q^3)}{(1 - q)} q^{-1/3} \\
&\quad + \frac{(1 - q^6)}{(1 - q)} [1 - q^2 + 2q^4 - q^6] (1 + q^2) q^{-19/3} \quad . \quad (3.50)
\end{aligned}$$

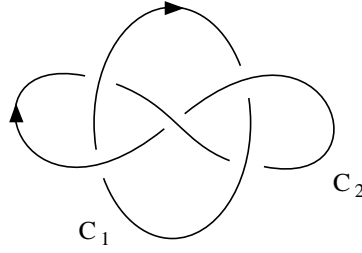

Figure 3.6

3.2.2 Values of the unknot

In this section we shall compute $E_0[m, n]$, which is the CS expectation value of the Wilson line operator associated with the unknot in \mathbb{R}^3 (with preferred framing) with colour $\chi[m, n]$ [33]. Our purpose is to produce the expression of $E_0[m, n]$ for arbitrary m and n . In studying the properties of the link polynomials, the values of the unknot play an important role. Indeed, in section 2.3 we have seen that, because of general covariance, any coloured link contained inside a solid torus determines a certain colour state associated with the core of the solid torus. Since the unknot is the companion of any link, the values of the unknot represent the basic building blocks of the link polynomials. In order to determine the structure of the reduced tensor algebra $\mathcal{T}_{(k)}$, we shall use the results of this section.

In section 2.3 we have given the rules for the computation of a generic coloured link. Thus, for fixed values of m and n , the computation of $E_0[m, n]$ is straightforward. The only nontrivial task is to find the general dependence of $E_0[m, n]$ on the integers m and n . In order to solve this problem, we shall use the symmetry properties of the CS theory and the recursive relations (3.8)-(3.13).

Let us denote by C the oriented unknot in \mathbb{R}^3 with preferred framing and colour $\chi[m, n]$. Clearly, the orientation of C can be modified by means of an ambient isotopy transformation. Since a modification of the orientation of C is equivalent to replace $\chi[m, n]$ with $\chi[n, m]$, one has

$$E_0[m, n] = E_0[n, m] \quad . \quad (3.51)$$

Let us now consider the distant union of two oriented unknots C_1 and C_2 (both with preferred framing) in \mathbb{R}^3 . Suppose that C_1 has colour $\chi[\rho_1]$ and C_2 has colour $\chi[\rho_2]$. Eq.(2.38) and the satellite relation (2.32) imply that

$$E_0[\rho_1] E_0[\rho_2] = \sum_{\rho} F_{\rho_1, \rho_2, \rho} E_0[\rho] \quad , \quad (3.52)$$

where $\{F_{\rho_1, \rho_2, \rho}\}$ are the structure constants of the tensor algebra \mathcal{T} :

$$\chi[\rho_1] \chi[\rho_2] = \sum_{\rho} F_{\rho_1, \rho_2, \rho} \chi[\rho] \quad . \quad (3.53)$$

Eq.(3.52) shows that the set $\{E_0[m, n]\}$ of the possible values of the unknot gives a representation in $Z[x^{\pm 1}]$ of the representation ring of the group. Consequently, one can use the relations (3.8)-(3.13) to find the values of the unknot. In fact, the recursive argument that we presented in section 3.2.1 determines the value of $E_0[m, n]$ uniquely. The result is summarized by the following theorem [33].

Theorem 3.3 *The expectation value $E_0[m, n]$ of the unknot in \mathbb{R}^3 with preferred framing and colour $\chi[m, n]$ is given by*

$$E_0[m, n] = q^{-(m+n)} \frac{(1 - q^{m+1})(1 - q^{n+1})(1 - q^{m+n+2})}{(1 + q)(1 - q)^3} . \quad (3.54)$$

Proof Clearly, eq.(3.54) gives the correct value of the unknot for the representations $(0, 0)$, $(1, 0)$ and $(0, 1)$. Moreover, one can easily verify that expression (3.54) satisfies the recursive relations (3.8)-(3.13). Consequently, eq.(3.54) represents the unique solution of the recursive relations with the correct initial data. Therefore, eq.(3.54) gives the values of the unknot in the CS theory. \square

In agreement with eq.(3.51), the value of $E_0[m, n]$ shown in equation (3.54) is symmetric in the indices m and n . Since the deformation parameter q is given by $q = \exp(-i2\pi/k)$, the expression (3.54) admits a Taylor expansion in powers of $\lambda = (2\pi/k)$ around $\lambda = 0$. Each term of this expansion represents the value of the corresponding Feynman diagrams found in perturbation theory. Let us now verify that the expression (3.8) is really in agreement with the perturbative result (1.46). From eq.(3.54) one gets

$$E_0[m, n] = \frac{(m+1)(n+1)(m+n+2)}{2} \left[1 - \frac{\lambda^2}{12}(m^2 + n^2 + mn + 3m + 3n) \right] + O(\lambda^3) . \quad (3.55)$$

By taking into account eqs.(3.6) and (3.7), one finds that this expression coincides precisely with the perturbative result (1.46). \square

Equation (3.54) shows that $E_0[m, n]$ is actually a finite Laurent polynomial in the deformation parameter q . Indeed, the factor $(1 + q)(1 - q)^3$ in the denominator of the expression (3.54) cancels out the roots of the numerator at $q = -1$ and $q = 1$. The dependence of $E_0[m, n]$ on the CS coupling constant k can be explicitly displayed by writing the expression (3.54) in the equivalent form

$$E_0[m, n] = \frac{1}{2} \frac{\sin[\pi(m+1)/k] \sin[\pi(n+1)/k] \sin[\pi(m+n+2)/k]}{\cos[\pi/k] \sin^3[\pi/k]} . \quad (3.56)$$

3.2.3 Values of the Hopf link

As we have already mentioned, we shall use Dehn's surgery on S^3 to solve the quantum CS theory in a generic three-manifold M . To be more precise, we shall use the operator surgery method (see Chap.5-6) to compute the expectation values of the observables in M by means of the observables in S^3 . One of the basic ingredients in the construction of the surgery operators is the so-called Hopf matrix. Let us now recall why the expectation value of the Hopf link plays a crucial role in solving the topological field theory.

Dehn's surgery method essentially consists [23] of removing and sewing solid tori in S^3 ; thus, we need to consider the properties of the CS expectation values which are related to the different embeddings of solid tori in S^3 . Actually, because of the so-called Fundamental Theorem [23], we really need to consider solid tori standardly embedded in S^3 . Let us consider a solid torus N standardly embedded in S^3 ; clearly, its boundary $\partial N \in S^3$ is a two-dimensional torus. Now, the crucial point to be noted is that ∂N is actually the boundary of two solid tori which are both standardly embedded in S^3 . The first solid torus is N , of course; the second solid torus is $S^3 - \dot{N}$, where \dot{N} is the interior of N .

In conclusion, a solid torus N standardly embedded in S^3 really defines two solid tori: N itself and its complement in S^3 . Suppose now that a certain coloured link L_1 is present in N and another coloured link L_2 is contained in $S^3 - \dot{N}$; we would like to study the properties of the associated expectation value $\langle W(L_1)W(L_2) \rangle$. The symmetry properties of the CS expectation values, that we have introduced in chapter 2 are valid also in the three-sphere S^3 . In particular, the generalized satellite relations permit us to find, for each link contained inside a solid torus, the corresponding colour state associated with the core of the solid torus. Consequently, $\langle W(L_1)W(L_2) \rangle$ can be expressed in terms of the values of the Hopf link whose two oriented components represent the cores of the two solid tori N and $S^3 - \dot{N}$.

To sum up, the values of the Hopf link give us the pairing between the colour states which are associated with two complementary solid tori standardly embedded in S^3 . For this reason, the values of the Hopf link are the fundamental ingredients in the construction of the surgery operators and, together with the satellite relations, characterize the topological properties of the quantum CS field theory completely. Thus, our strategy is to produce the values of the Hopf link in S^3 . Since the CS expectation values in S^3 coincide with the expectation values in \mathbb{R}^3 with the constraint that k is an integer, we only need to determine the values of the Hopf link in \mathbb{R}^3 .

Let us consider the Hopf link in \mathbb{R}^3 whose two oriented components $\{C_1, C_2\}$, shown in Fig.3.7, have preferred framings. Let C_1 have colour $\chi[m, n]$ and C_2 have colour $\chi[a, b]$. We are interested in the associated expectation value

$$H[(m, n); (a, b)] = \langle W(C_1; \chi[m, n]) W(C_2; \chi[a, b]) \rangle \Big|_{\mathbb{R}^3} \quad . \quad (3.57)$$

By means of an ambient isotopy, the components C_1 and C_2 of the Hopf link of Fig.3.7 can be exchanged; consequently, one has

$$H[(m, n); (a, b)] = H[(a, b); (m, n)] \quad . \quad (3.58)$$

As we have mentioned in sect.4, $E(L)$ is invariant under a global ‘‘charge conjugation’’ transformation which consists of substituting each irreducible representation ρ for its complex conjugate ρ^* . Therefore, one finds

$$H[(m, n); (a, b)] = H[(n, m); (b, a)] \quad . \quad (3.59)$$

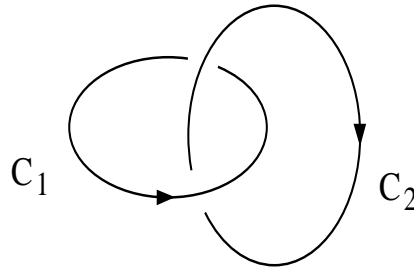

Figure 3.7

For fixed values of (m, n) and (a, b) , $H[(m, n); (a, b)]$ can easily be computed by means of the rules specified by the reconstruction theorems. The general dependence of $H[(m, n); (a, b)]$ on the irreducible representations (m, n) and (a, b) is summarized by the following theorem.

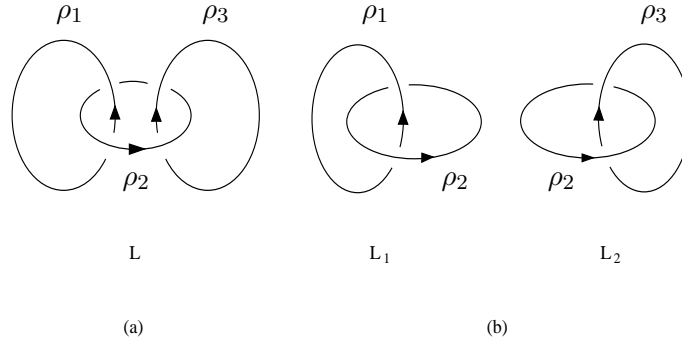

Figure 3.8

Theorem 3.4

The expectation value $H[m, n; a, b]$ of the Hopf link in \mathbb{R}^3 is given by

$$\begin{aligned}
 H[(m, n); (a, b)] &= q^{-[(m+n)(a+b+3)+(m+3)b+(n+3)a]/3} \cdot \frac{1}{(1-q)^3(1+q)} \cdot \\
 &\left[1 + q^{(n+1)(a+b+2)+(m+1)(b+1)} + q^{(m+1)(a+b+2)+(n+1)(a+1)} \right. \\
 &\quad \left. - q^{(m+1)(b+1)} - q^{(n+1)(a+1)} - q^{(m+n+2)(a+b+2)} \right] . \quad (3.60)
 \end{aligned}$$

Proof In order to prove the validity of eq.(3.60), we shall follow the same strategy as was adopted in the case of the unknot. Namely, we shall use equations (3.8)-(3.13) which, combined with the satellite relations and the formula (2.40) for the connected sums of links, permit us to find recursive relations for the values $H[(m, n); (a, b)]$. Then, one can verify that the expression (3.60) satisfies these recursive defining relations and gives the correct values of the initial data. Thus, eq.(3.60) represents the unique solution of the recursive relations which is consistent with the initial values. The algebraic part of the proof is more complicated than in the case of the unknot, of course.

Let us consider the link L shown in Fig.3.8a. On the one hand, the link L is a satellite of the Hopf link; therefore, by using the satellite formula (2.32), one obtains

$$E(L; \chi[\rho_1], \chi[\rho_2], \chi[\rho_3]) = H[\rho_2; \rho_1 \otimes \rho_3] . \quad (3.61)$$

On the other hand, L is the connected sum of the two Hopf links shown in Fig.3.8b. Thus, according to eq.(2.40), one has (when ρ_2 is irreducible)

$$H[\rho_2; \rho_1 \otimes \rho_3] = \frac{H[\rho_1; \rho_2] H[\rho_2; \rho_3]}{E_0[\rho_2]} . \quad (3.62)$$

Now, by setting $\rho_1 = (m, n)$, $\rho_3 = (1, 0)$ and $\rho_2 = (a, b)$, from eq.(3.62) we have

$$\begin{aligned}
 \frac{H[(m, n); (a, b)] H[(1, 0); (a, b)]}{E_0[a, b]} &= H[(m+1, n); (a, b)] + \\
 &+ H[(m-1, n+1); (a, b)] + H[(m, n-1); (a, b)] . \quad (3.63)
 \end{aligned}$$

In the same way, if we set $\rho_1 = (m-1, n)$, $\rho_3 = (0, 1)$ and $\rho_2 = (a, b)$, we obtain

$$\begin{aligned}
 \frac{H[(m-1, n); (a, b)] H[(0, 1); (a, b)]}{E_0[a, b]} &= H[(m-1, n); (a, b)] + \\
 &+ H[(m, n-1); (a, b)] + H[(m-2, n); (a, b)] . \quad (3.64)
 \end{aligned}$$

Subtracting equations (3.63) and (3.64), we arrive at the promised recursive relation

$$\begin{aligned} H[(m+1, n); (a, b)] &= H[(m, n); (a, b)] H[(1, 0); (a, b)] E_0^{-1}[a, b] \\ &- H[(m-1, n); (a, b)] H[(0, 1); (a, b)] E_0^{-1}[a, b] + H[(m-2, n); (a, b)] \quad . \end{aligned} \quad (3.65)$$

Similarly, by using eq.(3.59), we find

$$\begin{aligned} H[(m, n+1); (a, b)] &= H[(m, n); (a, b)] H[(0, 1); (a, b)] E_0^{-1}[a, b] \\ &- H[(m, n-1); (a, b)] H[(1, 0); (a, b)] E_0^{-1}[a, b] + H[(m, n-2); (a, b)] \quad . \end{aligned} \quad (3.66)$$

By using equations (3.65) and (3.66) recursively, one can determine the value of $H[(m, n); (a, b)]$ for $m, n \geq 2$ in terms of the initial values

$$\begin{aligned} &H[(0, 0); (a, b)] \\ &H[(1, 0); (a, b)] \\ &H[(2, 0); (a, b)] \\ &H[(1, 1); (a, b)] \\ &H[(2, 1); (a, b)] \\ &H[(2, 2); (a, b)] \quad . \end{aligned} \quad (3.67)$$

Since any link component with colour $\chi[0, 0]$ can be eliminated, we have

$$H[(0, 0); (a, b)] = E_0[a, b] \quad . \quad (3.68)$$

The remaining values of the initial data can easily be calculated by using Theorems 3.1 and 3.2 The result is [33]

$$\begin{aligned} H[(1, 0); (a, b)] &= q^{-(1+\frac{5b}{3}+\frac{4a}{3})} \frac{(1-q^{1+b})(1-q^{1+a})(1-q^{2+a+b})}{(1-q)^3(1+q)} \\ &\quad \left(1+q^{1+b}+q^{2+a+b}\right) \quad . \end{aligned} \quad (3.69)$$

$$\begin{aligned} H[(2, 0); (a, b)] &= \frac{(1+q^{1+b}+q^{2+2b}+q^{2+a+b}+q^{2(2+a+b)}+q^{3+2b+a})}{(1-q)^3(1+q)} \\ &\quad q^{-(2+\frac{7b}{3}+\frac{5a}{3})} (1-q^{1+b})(1-q^{1+a})(1-q^{2+a+b}) \quad . \end{aligned} \quad (3.70)$$

$$\begin{aligned} H[(1, 1); (a, b)] &= \frac{(1-q^{1+b})(1-q^{1+a})(1-q^{2+a+b})(1+q^{1+b})(1+q^{1+a})}{(1-q)^3(1+q)} \\ &\quad \left(1+q^{2+a+b}\right) q^{-2(1+a+b)} \quad . \end{aligned} \quad (3.71)$$

$$\begin{aligned} H[(2, 1); (a, b)] &= \frac{q^{-(3+\frac{8b}{3}+\frac{7a}{3})} (1-q^{1+m})(1-q^{1+n})(1-q^{2+a+b})}{(1-q)^3(1+q)} \\ &\quad (1+q^{1+b}+q^{2+2b}+q^{1+a}+2q^{2+b+a}+ \\ &\quad +2q^{3+2b+a}+q^{4+3b+a}+q^{3+b+2a}+2q^{4+2b+2a}+q^{5+3b+2a}+ \\ &\quad +q^{5+2b+3a}+q^{6+3b+3a}) \quad . \end{aligned} \quad (3.72)$$

$$\begin{aligned}
H[(2,2); (a,b)] &= \frac{q^{-(4+3b+3a)} (1 - q^{1+b}) (1 - q^{1+a}) (1 - q^{2+a+b})}{(1 - q)^3(1 + q)} \\
& (1 + q^{1+b} + q^{2+2b} + q^{1+a} + 2q^{2+a+b} + 2q^{3+2b+a} + q^{4+3b+a} + q^{2+2a} + \\
& + 3q^{4+2b+2a} + 2q^{5+3b+2a} + q^{6+4b+2a} + q^{4+b+3a} + 2q^{5+2b+3a} + 2q^{6+3b+3a} + \\
& + q^{7+4b+3a} + q^{6+2b+4a} + q^{7+3b+4a} + q^{8+4b+4a} + 2q^{3+b+2a}) . \tag{3.73}
\end{aligned}$$

Equations (3.65) and (3.66) together with the initial data (3.67) determine the values of the Hopf link uniquely. Now, one can verify [33, 35] that expression (3.60) satisfies the recursive relations (3.65) and (3.66). Moreover, for (m, n) equal to $(0,0)$, $(1,0)$, $(2,0)$, $(1,1)$, $(2,1)$, and $(2,2)$, eq.(3.60) reproduces the correct initial values. Consequently, eq.(3.60) represents the values of the Hopf link in the CS theory. \square

The value of the Hopf link shown in eq.(3.60) satisfies the symmetry properties (3.58) and (3.59). As usual, expression (8.4) admits a Taylor expansion in powers of $\lambda = (2\pi/k)$ around $\lambda = 0$. One can verify that the first three terms of this expansion agree with the perturbative result (1.48).

Chapter 4

Reduced tensor algebra

4.1 Physically inequivalent representations

The Wilson line operators $\{W(L)\}$ associated with all the possible links in S^3 form a complete set of gauge invariant observables in the CS theory. Each link component is coloured with an irreducible representation of the gauge group G . The labels, which are used to distinguish the inequivalent irreducible representations of the gauge group, can be understood as gauge-invariant quantum numbers assigned to the link components. In fact, as a linear space, the tensor algebra \mathcal{T} can be interpreted as a (gauge-invariant) state space. This space is infinite dimensional since there are an infinite number of inequivalent irreducible representations of G . When k is generic, different elements of the standard basis of \mathcal{T} represent physically inequivalent (gauge-invariant) states associated with a knot (or a solid torus). This means that any two different elements of \mathcal{T} can be distinguished by the values of the observables.

When $M = S^3$, we have seen in chapter 1 that gauge invariance implies that k must be a non vanishing integer. Since k multiplies the whole Lagrangian, a modification of the orientation of S^3 is equivalent to change the sign of k ; consequently, we only need to consider the case in which k is a positive integer. For fixed integer k , two different elements of \mathcal{T} do not necessarily correspond to different values of the observables. In order to determine the relevant quantum numbers associated with a knot when k is a fixed integer, we shall introduce an equivalence relation between the elements of the tensor algebra. Two elements χ and χ' of \mathcal{T} are physically equivalent [33] if the following equation

$$\begin{aligned} \langle W(C; \chi) W(C_1; \chi_1) \cdots W(C_n; \chi_n) \rangle \Big|_{S^3} &= \\ &= \langle W(C; \chi') W(C_1; \chi_1) \cdots W(C_n; \chi_n) \rangle \Big|_{S^3} \end{aligned} \quad (4.1)$$

holds (with fixed k) for any link L with components $\{C, C_1, \dots, C_n\}$ and for arbitrary $\{\chi_1, \dots, \chi_n\}$. This equivalence relation between two elements of \mathcal{T} will be denoted by $\chi \sim \chi'$. Note that our definition of physical equivalence has a real physical meaning. Indeed, all the properties of any gauge theory are determined by the set of the gauge invariant observables exclusively. Thus if $\chi \sim \chi'$, equation (4.1) shows that there is no experiment which can distinguish χ from χ' . For fixed integer k , we shall decompose \mathcal{T} into classes of physically equivalent elements; this classes will be denoted by ψ . The resulting set of these classes has an algebra structure inherited from \mathcal{T} and is called the reduced tensor algebra $\mathcal{T}_{(k)}$.

In order to determine the reduced tensor algebra we need the following property of CS observables [33].

Property 4.1

For any framed, oriented and coloured link L , in which one link component

has colour χ , the associated expectation value $E(L)$ takes the form

$$E(L) = E_0[\chi] \mathcal{F}(L) \quad , \quad (4.2)$$

where $\mathcal{F}(L)$ is a finite Laurent polynomial in the variable $x = q^{\frac{1}{s}}$, with s integer.

Proof. Consider the connected sum $L_1 \# L_2$ in which the two links L_1 and L_2 are copies of the link L ; in other words, L_1 and L_2 are separately ambient isotopic with the framed link L . Let the connected sum $L_1 \# L_2$ be obtained from L_1 and L_2 by acting on the link component associated with χ . Then, from eq.(2.40) it follows that

$$E(L_1 \# L_2) = \frac{E(L) E(L)}{E_0[\chi]} \quad . \quad (4.3)$$

In general, one can show $E(L) \in Z[x^{\pm 1}]$ [31] for any unitary group. For instance, in chapter 3, we have seen that when $G = SU(3)$, $x = q^{1/3}$. One can factorize the maximal power of x^{-1} in $E(L)$ and write

$$E(L) = x^{-a} \mathcal{P}(x) \quad , \quad (4.4)$$

where a is a non negative integer and $\mathcal{P}(x)$ is an ordinary finite polynomial in x with integer coefficients. Similarly, one has

$$E_0[\chi] = x^{-b} \mathcal{P}_0(x) \quad , \quad (4.5)$$

where b is a positive integer and \mathcal{P}_0 is a polynomial in x with integer coefficients. For instance, when $G = SU(3)$ and $\chi \equiv \chi[m, n]$, as shown in eq.(3.54), one has $b = 3(m + n)$. It should be noted that $\mathcal{P}_0(x)$ is not vanishing for $x = 0$. By using eqs.(4.4) and (4.5), eq.(4.3) takes the form

$$E(L_1 \# L_2) = x^{-(2a-b)} \frac{\mathcal{P}(x) \mathcal{P}(x)}{\mathcal{P}_0(x)} \quad . \quad (4.6)$$

Since $E(L_1 \# L_2) \in Z[x^{\pm 1}]$, eq.(4.6) implies that all the roots of the polynomial $\mathcal{P}_0(x)$ must also be roots of the product $\mathcal{P}(x) \mathcal{P}(x)$. A priori, there are now two possibilities:

1. $\mathcal{P}(x)/\mathcal{P}_0(x)$ is an ordinary polynomial in x ;
2. $\mathcal{P}(x)/\mathcal{P}_0(x)$ is not a polynomial in x .

In case (1), \mathcal{P} can be divided by \mathcal{P}_0 and one has

$$\mathcal{P}(x) = \mathcal{P}_0(x) \mathcal{G}(x) \quad , \quad (4.7)$$

where $\mathcal{G}(x)$ is a polynomial in x . Consequently, from eq.(4.4) one obtains

$$E(L) = E_0[\chi] x^{-a+b} \mathcal{G}(x) \quad . \quad (4.8)$$

Therefore, in case (1) one finds that eq.(4.2) is satisfied with $\mathcal{F}(L) = x^{-a+b} \mathcal{G}(x)$.

In order to complete the proof, we shall now show that possibility (2) is never realized; the point is that possibility (2) is not consistent with the connected sum formula (2.40). Indeed, if $\mathcal{P}(x)/\mathcal{P}_0(x)$ is not a polynomial, then it has a pole $(x - x_0)^{-\beta}$ of a certain fixed order β . Since $\mathcal{P}(x)$ multiplied by $\mathcal{P}(x)/\mathcal{P}_0(x)$ is a polynomial, this pole must be canceled by a root of $\mathcal{P}(x)$. Let us now consider the link L_N which coincides with the connected sum of N copies of the link L , as shown in Fig.4.1. Equation (2.40) gives

$$E(L_N) = E(L) \left(\frac{E(L)}{E_0[\chi]} \right)^{N-1} \quad , \quad (4.9)$$

which can be written as

$$E(L_N) = x^{-[Na-(N-1)b]} \mathcal{P}(x) \left(\frac{\mathcal{P}(x)}{\mathcal{P}_0(x)} \right)^{N-1} . \quad (4.10)$$

The same argument that we have used before now implies that $\mathcal{P}(x)$ must eliminate the pole $(x - x_0)^{-(N-1)\beta}$. Since N can be chosen to be arbitrarily large, the cancelation mechanism of the pole cannot take place because $\mathcal{P}(x)$ is a polynomial. Thus, possibility (2) is excluded and property 4.1 is proved. \square

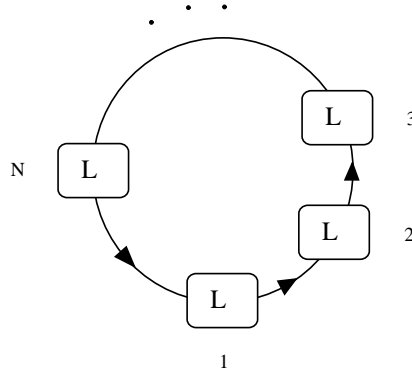

Figure 4.1

For fixed integer k , one can introduce the set $I_{(k)}$ of elements of \mathcal{T} which are characterized by the following property; $\zeta \in I_{(k)}$ if the equation

$$\langle W(C; \zeta) W(C_1; \chi_1) \cdots W(C_m; \chi_m) \rangle \Big|_{S^3} = 0 \quad , \quad (4.11)$$

holds for any link L in S^3 with components $\{C, C_1, \dots, C_m\}$ and for arbitrary colour states $\{\chi_1, \dots, \chi_m\} \subset \mathcal{T}$. In other words, $I_{(k)}$ is the set of elements of \mathcal{T} which are physically equivalent to zero. The following property is satisfied

Property 4.2 *The set $I_{(k)}$ is an ideal of \mathcal{T}*

Proof Let $\chi_1 \in I_{(k)}$ and $\chi \in \mathcal{T}$. In order to prove property 4.2, we need to show that $\chi' = \chi\chi_1 \in I_{(k)}$. Let us consider a link L whose component C has colour χ' and the link L' obtained from L by replacing C with $h^\diamond(B)$, where B is the pattern link shown in figure 2.1. By using the satellite formula 2.32 one obtains

$$E(L) = E(\cdots, h^\diamond(B), \cdots; \cdots, \chi, \chi_1, \cdots) \quad . \quad (4.12)$$

Property 4.2 follows by using property 4.1 in eq.(4.12). Indeed

$$E(L) = E(\cdots, h^\diamond(B), \cdots; \cdots, \chi, \chi_1, \cdots) = E_0[\chi]\mathcal{P}(x) = 0 \quad . \quad (4.13)$$

\square

By definition, the elements $\{\Psi\}$ of the reduced tensor algebra $\mathcal{T}_{(k)}$ are the classes of physically inequivalent elements; these coincide with the elements of \mathcal{T} modulo the ideal $I_{(k)}$. In other words, the reduced tensor algebra $\mathcal{T}_{(k)}$ can be represented by as

$$\mathcal{T}_{(k)} = \mathcal{T}/I_{(k)} \quad . \quad (4.14)$$

Thus, the problem of finding $\mathcal{T}_{(k)}$ is equivalent to the determination of $I_{(k)}$.

The reduced tensor algebra represents the minimal set of the fundamental quantum numbers which will be used, for fixed integer k , to colour the link components. Indeed, because of Property 4.2, each element of $I_{(k)}$ is physically equivalent to the null element of \mathcal{T}_k .

As a linear space, $\mathcal{T}_{(k)}$ admits a basis of physically inequivalent vectors $\{\psi[i], i \in \mathcal{D}\}$, where \mathcal{D} is contained in the set of the natural numbers. Since $\mathcal{T}_{(k)}$ is an algebra, one obtains

$$\psi[i] \psi[j] = N_{ijm} \psi[m] \quad ; \quad (4.15)$$

the numbers $\{N_{ijm}\}$ are called the structure constants of $\mathcal{T}_{(k)}$. It is very useful to choose the elements $\{\psi[i]\}$ in such a way that each $\psi[i]$ represents the equivalence class of an irreducible representation of G up to a multiplicative factor. With this choice, the connected sum formula (2.40) is still valid with $\psi[i]$ playing the role of the irreducible representation ρ . Note that the unit in \mathcal{T} corresponds to the one-dimensional trivial representation of G . The unit in $\mathcal{T}_{(k)}$ will be denoted by $\psi[1]$; $\psi[1]$ is the class defined by the trivial representation.

For fixed integer k , the decomposition (2.27) can be rewritten as

$$\mathcal{O}(V) = \sum_i \xi(i) W(C; \psi[i]) \quad . \quad (4.16)$$

Since $\mathcal{T}_{(k)} = \mathcal{T} / I_{(k)}$ and \mathcal{T} is a commutative algebra, the structure constants $\{N_{ijm}\}$ satisfy

$$N_{ijm} = N_{jim} \quad . \quad (4.17)$$

The tensor algebra \mathcal{T} admits a natural involution represented by complex conjugation, $*$: $\mathcal{T} \rightarrow \mathcal{T}$. Explicitly, $\chi[\rho] \xrightarrow{*} \chi[\rho^*]$. The ideal $I_{(k)}$ is stable under the $*$ automorphism of \mathcal{T} . Indeed, if $\eta \in I_{(k)}$ one has

$$\langle W(C; \eta) W(C_1; \chi_1) \cdots W(C_n; \chi_n) \rangle \Big|_{S^3} = 0 \quad , \quad (4.18)$$

for any choice of $\{\chi_1, \chi_2, \dots, \chi_n\} \in \mathcal{T}$ and for any link $L = \{C, C_1, \dots, C_n\}$. On the other hand, if C has colour η^* one finds

$$\begin{aligned} & \langle W(C; \eta^*) W(C_1; \chi_1) \cdots W(C_n; \chi_n) \rangle \Big|_{S^3} = \\ & = \langle W(C^{-1}; \eta) W(C_1; \chi_1) \cdots W(C_n; \chi_n) \rangle \Big|_{S^3} = 0 \quad , \end{aligned} \quad (4.19)$$

where C^{-1} denotes the knot C with reversed orientation. Therefore, η^* also belongs to $I_{(k)}$. The action of $*$ on the elements $\{\psi[i]\}$ of $\mathcal{T}_{(k)}$ is denoted by $\psi[i] \xrightarrow{*} \psi[i^*]$.

Since $F_{\rho_1 \rho_2 \rho} = F_{\rho_1^* \rho_2^* \rho^*}$, one can always choose the elements $\{\psi[i]\}$ of the standard basis of $\mathcal{T}_{(k)}$ in such way that

$$N_{ijm} = N_{i^* j^* m^*} \quad . \quad (4.20)$$

Eq.(4.20) is a consequence of the fact that $*$ is an automorphism of $\mathcal{T}_{(k)}$. The reduced tensor algebra $\mathcal{T}_{(k)}$ is called regular if the following properties are fulfilled [36]:

- (i) $\mathcal{T}_{(k)}$ is of finite order D ;
(ii) the structure constants defined by the elements of the standard basis satisfy

$$N_{ijm} = N_{i^*mj} \quad ; \quad (4.21)$$

- (iii) with respect to the the standard basis $\{\psi[i] \ , \ i = 1, 2 \cdots D\}$, one has

$$\lambda_+ = \sum_{i=1}^D q^{Q(i)} E_0^2[i] \neq 0 \quad . \quad (4.22)$$

In equation (4.22), $Q(i)$ denotes the value of the quadratic Casimir operator associated with an element of the class $\psi[i]$ and $E_0[i]$ is the value of the unknot in S^3 with preferred framing and colour $\psi[i]$.

When the reduced tensor algebra is regular, equation (4.21) implies that

$$N_{ij1} = N_{i^*1j} = \delta_{i^*j} = \delta_{ij^*} \quad ; \quad (4.23)$$

$$N_{ijm^*} = N_{imj^*} = N_{jmi^*} \quad . \quad (4.24)$$

The meaning of equation (4.23) is clear: in the decomposition of the product $\psi[i]\psi[j]$ the unit element $\psi[1]$ appears if and only if $\psi[i^*] = \psi[j]$.

In the next sections we shall construct explicitly the reduced tensor algebra when $G = SU(2)$ and $G = SU(3)$, in both cases, $\mathcal{T}_{(k)}$ turns out to be of regular type. There are strong indications that this is true also for any unitary group. The reason why we have introduced this definition is that, when $\mathcal{T}_{(k)}$ is of regular type, an operator realization of Dehn's surgery exists, see Chap.6 and [36]. The operator surgery method will permit us to solve the CS theory in a generic three-manifold M . For our purposes, the existence of the surgery operator is crucial; so, we shall assume that $\mathcal{T}_{(k)}$ is regular. This seems to be a reasonable assumption which can be checked directly for any concrete choice of G .

It should be noted that the reduced tensor algebra $\mathcal{T}_{(k)}$ has a twofold origin. On the one hand, the algebraic structure of $\mathcal{T}_{(k)}$ is inherited from the tensor algebra of the gauge group. On the other hand, the ideal $I_{(k)}$ which must be factorized encodes several features of the CS field theory:

- (1) the ideal depends on the gauge group, of course;
- (2) the ideal depends on the value of k ;
- (3) the ideal strongly depends on the values of the observables of the CS theory. Indeed, the physical equivalence relation (4.1) involves all the observables of the model.

Let us consider the set $\mathcal{A} \subset \mathcal{R}_G$ characterized by the following property

$$\rho \in \mathcal{A} \Rightarrow E_0[\rho] = 0 \quad . \quad (4.25)$$

One can also consider \mathcal{A} as contained in \mathcal{T} ; indeed, by using Property 4.1, it is evident that $\mathcal{A} \subset I_{(k)}$. Because the knowledge of $I_{(k)}$ is equivalent to the knowledge of \mathcal{T}_k , our first step in the construction of \mathcal{T}_k will be the study of the set \mathcal{A} .

4.2 Reduced tensor algebra for $SU(3)$

4.2.1 Zeroes of the unknot

For fixed integer k , the value of the unknot $E_0[m, n]$ may vanish for certain values of m and n . In this section, we shall consider the set \mathcal{A} of elements $\{\chi[m, n]\}$ for which the associated value $E_0[m, n]$ is vanishing. As we have seen, \mathcal{A} plays a crucial role in construction of the reduced tensor algebra.

Let us first consider the case in which $k \geq 3$. From eq.(3.56) it follows that $E_0[m, n]$ vanishes when one of the following conditions is satisfied

1. $m = ka - 1$,
2. $n = kb - 1$,
3. $m + n = kc - 2$,

where a, b and c are integers. Let us represent the irreducible representations $\{(m, n)\}$ by the points of a two-dimensional square lattice. The elements of \mathcal{A} determine a regular structure on this lattice. The zeroes described in point (1) lie on vertical lines which are equally spaced; those described in point (2) lie on (equally spaced) horizontal lines and the zeroes in point (3) correspond to diagonal lines. The pattern of the zeroes is shown in Fig.4.2.

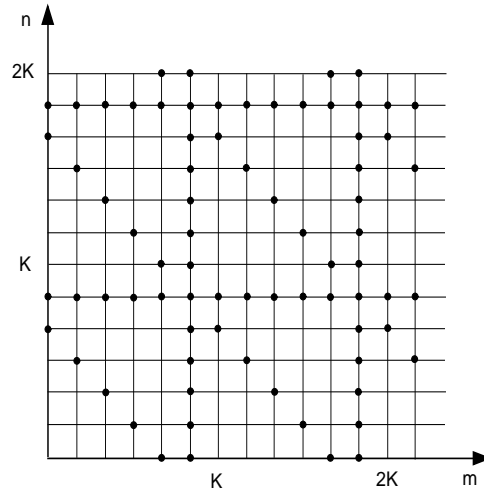

Figure 4.2

The region of the plane delimited by the two axes $m = 0, n = 0$ and the diagonal line $m + n = k - 2$ does not contain zeroes of the unknot and will be denoted by Δ_k . The region Δ_k is called the fundamental domain; we will show that the classes represented by the points in Δ_k form a complete basis of $\mathcal{T}_{(k)}$.

When $k = 2$, eq.(3.56) gives

$$\lim_{k \rightarrow 2} E_0[m, n] = \begin{cases} 0 & \text{for } m \text{ and } n \text{ odd;} \\ -(n + 1)/2 & \text{for } n \text{ odd and } m \text{ even;} \\ -(m + 1)/2 & \text{for } m \text{ odd and } n \text{ even;} \\ -(m + n + 2)/2 & \text{for } m \text{ and } n \text{ even.} \end{cases} \tag{4.26}$$

Finally, for $k = 1$ one has

$$\lim_{k \rightarrow 1} E_0[m, n] = \frac{1}{2}(m + 1)(n + 1)(m + n + 2) = D(m, n) \quad . \tag{4.27}$$

It should be noted that the cases in which $k = 2$ and $k = 1$ present certain peculiarities with respect to the general situation that one has for $k \geq 3$. Consequently, in the construction of the reduced tensor algebra we will need to distinguish the cases $k = 1, k = 2$ and $k \geq 3$.

4.2.2 Null elements

In this section we shall prove that, when $k \geq 3$, all the elements of \mathcal{A} are generated [35, 33] by two fundamental nontrivial “null elements”.

Property 4.3 For $k \geq 3$, each element $\chi[m, n]$ of \mathcal{A} can be written in the form

$$\chi[m, n] = \zeta_1 \chi_1 + \zeta_2 \chi_2 \quad , \quad (4.28)$$

where

$$\zeta_1 = \chi[k - 2, 0] \quad , \quad (4.29)$$

$$\zeta_2 = \chi[k - 1, 0] \quad , \quad (4.30)$$

and the elements χ_1 and χ_2 belong to the representation ring of $SU(3)$.

Proof It is easy to verify that all the elements of \mathcal{R} which can be written as in eq.(4.28) form an ideal of \mathcal{R} denoted by $\mathcal{B}(\zeta_1, \zeta_2)$. We need to prove that each element of \mathcal{A} belongs to $\mathcal{B}(\zeta_1, \zeta_2)$. In order to do this, we shall use the tensor product decompositions

$$(m, n) \otimes (1, 0) = (m + 1, n) \oplus (m - 1, n + 1) \oplus (m, n - 1) \quad , \quad (4.31)$$

$$(m, n) \otimes (0, 1) = (m, n + 1) \oplus (m + 1, n - 1) \oplus (m - 1, n) \quad . \quad (4.32)$$

Let us recall that the elements of \mathcal{A} correspond to the points on diagonal, horizontal and vertical lines of the square lattice introduced in the previous section. First of all, we use eqs.(4.31) and (4.32) to prove that if three elements of $\mathcal{B}(\zeta_1, \zeta_2)$ are represented by three consecutive points in a diagonal line, then all the remaining points of the diagonal belong to $\mathcal{B}(\zeta_1, \zeta_2)$. Indeed, setting $m \rightarrow m + 1$, $n \rightarrow n - 1$ in eqs.(4.31)-(4.32) and subtracting them, we have

$$\begin{aligned} & \chi[m, n] \chi[1, 0] - \chi[m + 1, n - 1] \chi[0, 1] = \\ & = \chi[m - 1, n + 1] - \chi[m + 2, n - 2] \quad . \end{aligned} \quad (4.33)$$

Thus, if $\chi[m - 1, n + 1]$, $\chi[m, n]$ and $\chi[m + 1, n - 1]$ belong to $\mathcal{B}(\zeta_1, \zeta_2)$, eq.(4.33) implies that $\chi[m + 2, n - 2]$ also belongs to $\mathcal{B}(\zeta_1, \zeta_2)$ (see Fig.4.3).

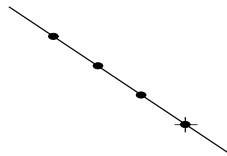

Figure 4.3

With the substitution $m \rightarrow m - 1$ and $n \rightarrow n - 1$ in eq.(4.33), we conclude that $\chi[m - 2, n + 2]$ also belongs to $\mathcal{B}(\zeta_1, \zeta_2)$, as shown in Fig.4.4.

Clearly, all the remaining points on the diagonal can be obtained by induction. The same argument can be used to prove that the presence of three consecutive elements of $\mathcal{B}(\zeta_1, \zeta_2)$ in a vertical (or

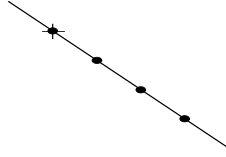

Figure 4.4

horizontal line) implies that all the remaining points of the line are also elements of $\mathcal{B}(\zeta_1, \zeta_2)$. For a vertical line the relevant formula is:

$$\begin{aligned} \chi[m, n] \chi[1, 0] - \chi[m, n+1] \chi[0, 1] &= \\ = \chi[m, n-1] - \chi[m, n+2] \quad , \end{aligned} \quad (4.34)$$

whereas for an horizontal line the recursive formula is

$$\begin{aligned} \chi[m, n] \chi[1, 0] - \chi[m-1, n] \chi[0, 1] &= \\ = \chi[m+1, n] - \chi[m-2, n] \quad . \end{aligned} \quad (4.35)$$

Now we are ready to express all the elements of \mathcal{A} in terms of ζ_1 and ζ_2 . Let us consider the elements of the “first” diagonal $m+n = k-2$ (see figure 4.2); the fundamental null vector $\zeta_1 = \chi[k-2, 0]$ corresponds to the crossing point of the diagonal with the m -axis. From equation

$$\zeta_1 \chi[1, 0] = \zeta_2 + \chi[k-3, 1] \quad , \quad (4.36)$$

it follows that $\chi[k-3, 1]$, which belongs to \mathcal{A} , also belongs to $\mathcal{B}(\zeta_1, \zeta_2)$. The following equation

$$\chi[k-3, 1] \chi[1, 0] - \zeta_1 \chi[0, 1] = \chi[k-4, 2] \quad , \quad (4.37)$$

implies that $\chi[k-4, 2] \in \mathcal{B}(\zeta_1, \zeta_2)$. At this stage, we have shown that three elements of \mathcal{A} , which are represented by three consecutive points on the first diagonal line, belong to $\mathcal{B}(\zeta_1, \zeta_2)$. Consequently, all the points of this diagonal line belong to $\mathcal{B}(\zeta_1, \zeta_2)$. In other words, the elements of \mathcal{A} corresponding to the points of the first diagonal line (see Fig.4.2) are also elements of $\mathcal{B}(\zeta_1, \zeta_2)$.

Let us consider now the points lying on the first vertical line $m = k-1$. The first base point is $\zeta_2 = \chi[k-1, 0]$. The second point can be obtained by using:

$$\begin{aligned} \zeta_2 \chi[0, 1] &= \chi[k-1, 1] + \zeta_1 \quad , \\ \Rightarrow \chi[k-1, 1] &\in \mathcal{B}(\zeta_1, \zeta_2) \quad . \end{aligned} \quad (4.38)$$

The third point can be expressed in terms of ζ_1 and ζ_2 according to

$$\begin{aligned} \chi[k-1, 1] \chi[0, 1] &= \chi[k-1, 2] + \chi[k, 0] + \chi[k-2, 1] \quad , \\ \zeta_2 \chi[1, 0] &= \chi[k, 0] + \chi[k-2, 1] \quad , \\ \Rightarrow \chi[k-1, 2] &= \chi[k-1, 1] \chi[0, 1] - \zeta_2 \chi[1, 0] \in \mathcal{B}(\zeta_1, \zeta_2) \quad . \end{aligned} \quad (4.39)$$

Since $\chi[k-1, 0]$, $\chi[k-1, 1]$ and $\chi[k-1, 2]$ belong to $\mathcal{B}(\zeta_1, \zeta_2)$, all the points of the vertical line $(k-1, n)$ belong to $\mathcal{B}(\zeta_1, \zeta_2)$.

We now examine the first horizontal line $n = k-1$; for the first point we have

$$\begin{aligned} \chi[0, k-2] \chi[0, 1] &= \chi[0, k-1] + \chi[1, k-3] \quad , \\ \Rightarrow \chi[0, k-1] &\in \mathcal{B}(\zeta_1, \zeta_2) \quad . \end{aligned} \quad (4.40)$$

The second point can be expressed as

$$\begin{aligned}\chi[0, k-1] \chi[1, 0] &= \chi[1, k-1] + \chi[0, k-2] \quad , \\ \Rightarrow \chi[1, k-1] &\in \mathcal{B}(\zeta_1, \zeta_2) \quad .\end{aligned}\tag{4.41}$$

For the third point we get

$$\begin{aligned}\chi[1, k-1] \chi[1, 0] &= \chi[1, k-2] + \chi[0, k-2] + \chi[2, k-1] \quad , \\ \chi[0, k-1] \chi[0, 1] &= \chi[1, k-2] + \chi[0, k-2] \quad , \\ \Rightarrow \chi[2, k-1] &= \chi[1, k-1] \chi[1, 0] - \chi[0, k-1] \chi[0, 1] \in \mathcal{B}(\zeta_1, \zeta_2) \quad .\end{aligned}\tag{4.42}$$

At this stage, by using eq.(4.35) recursively, we find that all the points of the first horizontal line belong to $\mathcal{B}(\zeta_1, \zeta_2)$.

To sum up, in this first step we have shown that the elements of \mathcal{A} which correspond to the points of the first diagonal, vertical and horizontal lines belong to $\mathcal{B}(\zeta_1, \zeta_2)$.

In the second step, we consider all the remaining diagonal and horizontal lines. Let us start with the base points of the second diagonal line. The element given by $\chi[k-1, k-1]$ lies on the first horizontal line, therefore it belongs to $\mathcal{B}(\zeta_1, \zeta_2)$. The second base point corresponds to $\chi[k, k-2]$; indeed,

$$\begin{aligned}\chi[k-1, k-2] \chi[1, 0] &= \chi[k, k-2] + \chi[k-2, k-1] + \chi[k-1, k-3] \quad , \\ \Rightarrow \chi[k, k-2] &= \chi[k-1, k-2] \chi[1, 0] - \chi[k-2, k-1] \\ &\quad - \chi[k-1, k-3] \in \mathcal{B}(\zeta_1, \zeta_2) \quad .\end{aligned}\tag{4.43}$$

For the last element, we have

$$\begin{aligned}\chi[k-2, k-1] \chi[0, 1] &= \chi[k-2, k] + \chi[k-1, k-2] + \chi[k-3, k-1] \quad , \\ \Rightarrow \chi[k-2, k] &\in \mathcal{B}(\zeta_1, \zeta_2) \quad .\end{aligned}\tag{4.44}$$

By using eq.(4.33) recursively, one can complete the second diagonal line. The same argument that we have presented before can be used to analyze all diagonal and horizontal lines. Indeed, since all the points of the second diagonal belong to $\mathcal{B}(\zeta_1, \zeta_2)$, we can construct the second horizontal line as we did for the first. Then, we can construct the third diagonal line and so on. It is clear that this recursive procedure shows that all the points on the diagonal and horizontal lines belong to $\mathcal{B}(\zeta_1, \zeta_2)$.

In the third and final step, we consider the vertical lines. Three base points for the second vertical line can be obtained by exploring the crossing between the third diagonal and the first horizontal lines. The first element is

$$\begin{aligned}\chi[2k-1, k-1] \chi[1, 0] &= \chi[2k, k-1] + \chi[2k-2, k] + \chi[2k-1, k-2] \quad , \\ \Rightarrow \chi[2k-1, k-2] &\in \mathcal{B}(\zeta_1, \zeta_2) \quad .\end{aligned}\tag{4.45}$$

For the second element, we take

$$\begin{aligned}\chi[2k-1, k-2] \chi[1, 0] &= \chi[2k, k-2] + \chi[2k-2, k-1] + \chi[2k-1, k-3] \quad , \\ \Rightarrow \chi[2k-1, k-2] &\in \mathcal{B}(\zeta_1, \zeta_2) \quad .\end{aligned}\tag{4.46}$$

The third element, which corresponds to $\chi[2k-1, k-1]$, belongs to the first horizontal line. Therefore, by using eq.(4.34), we can complete the second vertical line. Repeating the same argument at every crossing point between the first horizontal line and the diagonal lines, all the vertical lines can be constructed.

In conclusion, all the elements of \mathcal{A} belong to $\mathcal{B}(\zeta_1, \zeta_2)$ or, in other words, can be written in the form shown in eq.(4.28). Consequently, Property 4.3 is proved. \square

4.2.3 Reduced tensor algebra for $k \geq 3$

In this section we will determine the structure of the reduced tensor algebra $\mathcal{T}_{(k)}$ for $k \geq 3$. Let L be a coloured and framed link in S^3 with components $\{C, C', \dots\}$ in which the component C has colour $\eta \in \mathcal{T}$. If (for fixed integer k) $\eta = \chi[m, n] \in \mathcal{A}$, Property 4.1 implies that $\langle W(L) \rangle|_{S^3} = 0$ for any link L . As we have already mentioned, this means that $\eta = \chi[m, n] \in \mathcal{A}$ is physically equivalent to the null element.

Property 4.4 *If the component C of a link L has colour $\eta = \chi_1 \chi_2$ with $\chi_1 \in \mathcal{A}$ and $\chi_2 \in \mathcal{T}$, one has*

$$\langle W(L) \rangle|_{S^3} = 0 \quad (4.47)$$

Proof. By using the satellite formula (2.32), the expectation value of $W(L)$ can be expressed as

$$\begin{aligned} \langle W(L) \rangle|_{S^3} &\equiv \langle W(C, C', \dots; \chi_1 \chi_2, \chi' \dots) \rangle|_{S^3} = \\ &= \langle W(h^\diamond(B), C', \dots; \chi_1, \chi_2, \chi' \dots) \rangle|_{S^3} \equiv \langle W(L') \rangle|_{S^3} , \end{aligned} \quad (4.48)$$

where h^\diamond is the homeomorphism defined in section 2.2 and B is the two-component pattern link shown in Fig.2.3. In eq.(4.48), L' denotes the satellite which has been obtained from L by replacing the component C with the image $h^\diamond(B)$ of the pattern link. Note that L' has two components which have colours χ_1 and χ_2 . Therefore, if $\chi_1 \in \mathcal{A}$, by using Property 4.1 one has $\langle W(L') \rangle|_{S^3} = 0$ and, consequently, $\langle W(L) \rangle|_{S^3} = 0$. \square

We shall now determine the ideal $I_{(k)}$. Clearly, Property 4.1 implies that any element η of the form $\eta = \chi_1 \chi_2$, with $\chi_1 \in \mathcal{A}$ and $\chi_2 \in \mathcal{T}$, belongs to $I_{(k)}$. Since any element of \mathcal{A} is of the form (4.28), it is natural to expect that each element ζ of $I_{(k)}$ can be expressed in the form

$$\zeta = \zeta_1 \chi + \zeta_2 \chi' , \quad (4.49)$$

where χ and χ' belong to \mathcal{T} . We will prove that this is indeed the case; in other words, for fixed integer $k \geq 3$, $I_{(k)}$ is the ideal generated by the two null vectors ζ_1 and ζ_2 shown in eqs.(4.29) and (4.30). The proof essentially consists of two steps. Firstly, assuming that each element of $I_{(k)}$ is of the form (4.49), we shall determine the corresponding set $\mathcal{T}_{(k)}$ of equivalence classes. Secondly, we will show that this set is physically irreducible; i.e. $\Psi \sim 0$ implies $\Psi \equiv 0$.

We shall now give three basic rules which connect, for fixed integer $k \geq 3$, physically equivalent elements of \mathcal{T} . Let us recall that each element $\chi[m, n]$ of the standard basis of \mathcal{T} is represented by a point in the square lattice shown in Fig.4.2. Furthermore, the elements of \mathcal{A} are organized in diagonal, vertical and horizontal lines in the same lattice. To each line is associated [35, 33] a correspondence rule.

Rule 1

Let us consider the element $\chi[m, n]$. Suppose that, for some nonnegative integer p , $\chi[m - p, n]$ belongs to \mathcal{A} and is represented by a point on a diagonal line; then

$$\chi[m, n] \sim -\chi[m - p, n - p] . \quad (4.50)$$

Proof When $p = 1$, one has

$$0 \sim \chi[m - 1, n] \chi[1, 0] = \chi[m, n] + \chi[m - 2, n + 1] + \chi[m - 1, n - 1] . \quad (4.51)$$

Since $\chi[m-2, n+1]$ is represented by a point on the diagonal which is determined by $\chi[m-1, n]$, $\chi[m-2, n+1]$ belongs to \mathcal{A} and then $\chi[m-2, n+1] \sim 0$. Therefore, eq.(4.51) gives

$$\chi[m, n] \sim -\chi[m-1, n-1] \quad , \quad (4.52)$$

which shows that eq.(4.50) is satisfied for $p = 1$. We now proceed by induction. Let us assume that eq.(4.50) is valid for $p \leq \bar{p}$. We consider the following decompositions

$$\chi[m, n] \chi[1, 0] = \chi[m+1, n] + \chi[m-1, n+1] + \chi[m, n-1] \quad , \quad (4.53)$$

$$\chi[m-\bar{p}, n-\bar{p}] \chi[1, 0] = \chi[m-\bar{p}+1, n-\bar{p}] + \chi[m-\bar{p}-1, n-\bar{p}+1] + \chi[m-\bar{p}, n-\bar{p}-1] \quad . \quad (4.54)$$

By the induction hypothesis, one has

$$\begin{aligned} \chi[m, n] &\sim -\chi[m-\bar{p}, n-\bar{p}] \quad , \\ \chi[m-1, n+1] &\sim -\chi[m-1-\bar{p}, n+1-\bar{p}] \quad , \\ \chi[m, n-1] &\sim -\chi[m-(\bar{p}-1), n-1-(\bar{p}-1)] \quad . \end{aligned} \quad (4.55)$$

Therefore, by adding eqs.(4.53) and (4.54) and by using (4.55), one finds

$$\chi[m+1, n] \sim -\chi[m+1-(\bar{p}+1), n-(\bar{p}+1)] \quad . \quad (4.56)$$

Eq.(4.56) shows that eq.(4.50) holds also for $p = \bar{p} + 1$; this concludes the proof. \square

Rule 2 *Let us consider the element $\chi[m, n]$. Suppose that, for some nonnegative integer p , $\chi[m-p, n]$ belongs to \mathcal{A} and is represented by a point on a vertical line; then*

$$\chi[m, n] \sim -\chi[m-2p, n+p] \quad . \quad (4.57)$$

Proof When $p = 1$, one has

$$0 \sim \chi[m-1, n] \chi[1, 0] = \chi[m, n] + \chi[m-2, n+1] + \chi[m-1, n-1] \quad . \quad (4.58)$$

Since $\chi[m-1, n-1]$ is represented by a point on the vertical line which is determined by $\chi[m-1, n]$, $\chi[m-1, n-1]$ belongs to \mathcal{A} and then $\chi[m-1, n-1] \sim 0$. Therefore, eq.(4.58) gives

$$\chi[m, n] \sim -\chi[m-2, n+1] \quad , \quad (4.59)$$

which shows that eq.(4.57) is satisfied for $p = 1$. We now proceed by induction. Let us assume that eq.(4.57) is valid for $p \leq \bar{p}$. We consider the following decompositions

$$\chi[m, n] \chi[1, 0] = \chi[m+1, n] + \chi[m-1, n+1] + \chi[m, n-1] \quad , \quad (4.60)$$

$$\begin{aligned} \chi[m-2\bar{p}, n+\bar{p}] \chi[1, 0] &= \chi[m-2\bar{p}+1, n+\bar{p}] + \\ &+ \chi[m-2\bar{p}-1, n+\bar{p}+1] + \chi[m-2\bar{p}, n+\bar{p}-1] \quad . \end{aligned} \quad (4.61)$$

By the induction hypothesis, one has

$$\begin{aligned} \chi[m, n] &\sim -\chi[m-2\bar{p}, n+\bar{p}] \quad , \\ \chi[m-1, n+1] &\sim -\chi[m-1-2(\bar{p}-1), n+1+(\bar{p}-1)] \quad , \\ \chi[m, n-1] &\sim -\chi[m-2\bar{p}, n-1-\bar{p}] \quad . \end{aligned} \quad (4.62)$$

Therefore, by adding eqs.(4.60) and (4.61) and by using (4.62), one finds

$$\chi[m+1, n] \sim -\chi[m+1-2(\bar{p}+1), n+(\bar{p}+1)] \quad . \quad (4.63)$$

Eq.(4.63) shows that eq.(4.57) holds also for $p = \bar{p} + 1$. \square

Rule 3

Let us consider the element $\chi[m, n]$. Suppose that, for some nonnegative integer p , $\chi[m, n-p]$ belongs to \mathcal{A} and is represented by a point on a horizontal line; then

$$\chi[m, n] \sim -\chi[m+p, n-2p] \quad . \quad (4.64)$$

Proof The proof of eq.(4.64) is based on the same algebraic manipulations as those used in the proof of Rules 1 and 2. \square

The equivalence relations described by Rules 1, 2 and 3 are shown in Fig.4.5. These rules must be used to connect points of the physical region ($m \geq 0$ and $n \geq 0$) of the square lattice. The points of the physical region of the lattice describe all the irreducible representations $\{(m, n)\}$ of $SU(3)$ which label the elements $\{\chi[m, n]\}$ of the standard basis of \mathcal{T} .

For fixed integer $k \geq 3$, let us consider a generic element $\chi[m, n]$. If $\chi[m, n]$ belongs to \mathcal{A} , then $\chi[m, n] \sim 0$. If $\chi[m, n] \notin \mathcal{A}$, by using Rules 1, 2 and 3 recursively, it is easy to see that $\chi[m, n]$ is physically equivalent (with a well determined sign) to an element $\chi[a, b]$ represented by a point in the fundamental domain Δ_k . The points of Δ_k have coordinates (a, b) characterized by

$$\Delta_k \equiv \{(a, b)\} \quad \text{with} \quad \left\{ \begin{array}{l} 0 \leq a < k-2 \\ 0 \leq b < -a+k-2 \end{array} \right. \quad . \quad (4.65)$$

We shall denote by $\Psi[a, b]$ the class associated with the irreducible representation (a, b) of $SU(3)$ with the point $(a, b) \in \Delta_k$. A generic element χ of \mathcal{T} admits a linear decomposition in terms of the elements of the standard basis of \mathcal{T}

$$\chi = \sum_{m, n} \xi(m, n) \chi[m, n] \quad . \quad (4.66)$$

Let Ψ be the class of physical equivalent elements associated with χ . Since the class corresponding to each $\chi[m, n]$ is the trivial class or a class $\Psi[a, b]$ with $(a, b) \in \Delta_k$, from eq.(4.66) it follows that

$$\Psi = \sum_{(a, b) \in \Delta_k} \xi'(a, b) \Psi[a, b] \quad , \quad (4.67)$$

where $\{\xi'(a, b)\}$ are linear combinations of the coefficients $\{\xi(a, b)\}$.

To sum up [33], assuming that for $k \geq 3$ each element of $I_{(k)}$ has the form (4.49), eq.(4.67) shows that the elements of \mathcal{T} modulo the ideal $I_{(k)}$ admits a linear decomposition in terms of the classes $\{\Psi[a, b]\}$ with $(a, b) \in \Delta_k$. Therefore, $\{\Psi[a, b]\}$ form a basis of $\mathcal{T}_{(k)}$ that we call the standard basis. It remains to be verified that $\mathcal{T}_{(k)}$, defined above, is physically irreducible. This means that if the element $\Psi_* \in \mathcal{T}_{(k)}$ is physically equivalent to zero $\Psi_* \sim 0$, then $\Psi_* = 0$. The proof is very simple. Let us consider the Hopf link in which one component has colour Ψ_* and the other component has colour given by a generic element Ψ of $\mathcal{T}_{(k)}$. If $\Psi_* \sim 0$, the associated expectation value vanishes

$$\langle W(C_1; \Psi_*) W(C_2; \Psi) \rangle \Big|_{S^3} = 0 \quad . \quad (4.68)$$

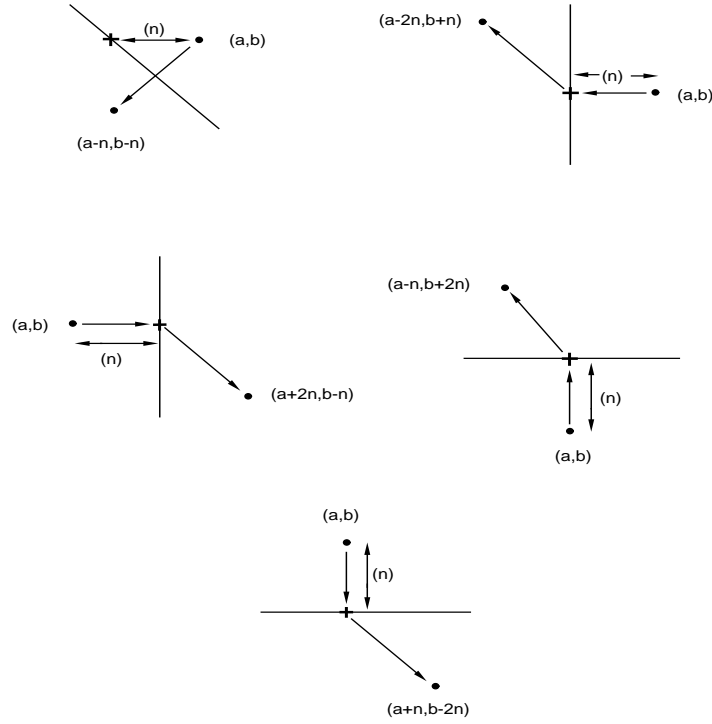

Figure 4.5

Let us expand Ψ_* as in (4.67),

$$\Psi_* = \sum_{(m,n) \in \Delta_k} \xi_*(m,n) \Psi[m,n] \quad . \quad (4.69)$$

Since eq.(4.68) holds for arbitrary Ψ , eq.(4.68) implies that, for any $(a,b) \in \Delta_k$, one has

$$\sum_{(m,n) \in \Delta_k} \xi_*(m,n) H[(m,n), (a,b)] = 0 \quad . \quad (4.70)$$

The complex numbers $\{H[(m,n), (a,b)]\}$, for $(m,n) \in \Delta_k$ and $(a,b) \in \Delta_k$, can be understood as the matrix elements of the Hopf matrix H . As shown in Appendix C, the Hopf matrix H for $G = SU(3)$ is invertible; therefore, eq.(4.70) implies that

$$\xi_*(m,n) = 0 \quad , \quad \text{for any } (m,n) \in \Delta_k \quad . \quad (4.71)$$

This shows that $\Psi_* = 0$. In conclusion, the results of this section are summarized by the following theorem [33].

Theorem 4.1

For fixed integer $k \geq 3$, the reduced tensor algebra $\mathcal{T}_{(k)}$ coincides with the classes of elements of \mathcal{T} modulo the ideal $I_{(k)}$ generated by the non-trivial null vectors ζ_1 and ζ_2 defined in sect.4.3.2.

Finally we note that, as a linear space, $\mathcal{T}_{(k)}$ has dimension which is equal to the number of representative points on the square lattice which belong to the fundamental domain Δ_k . Consequently,

for fixed $k \geq 3$, the reduced tensor algebra $\mathcal{T}_{(k)}$ is of order $(k - 1)(k - 2)/2$. When $k = 3$, the order of $\mathcal{T}_{(3)}$ is equal to unity; in this case, the fundamental domain Δ_3 contains a single point with coordinates $(0,0)$. This means that, for $k = 3$, there is only one class of physically equivalent states; this class can be represented by $\chi[0, 0]$.

We note that according to the definition given in Sect.4.1, the reduced tensor algebra $\mathcal{T}_{(k)}$, with $k \geq 3$ is regular. Indeed, the only non trivial property to be verified is (4.21), the proof can be found in App.C.2.

4.2.4 Reduced tensor algebra for $k = 1$

In this section we compute the reduced tensor algebra for $k = 1$. Since $E_0[m, n]$ does not vanish when $k = 1$ (see eq.(4.27)), in the construction of the reduced tensor algebra $\mathcal{T}_{(1)}$ one finds a situation which is quite different from the case $k \geq 3$. Clearly, when $k = 1$ we cannot use the same argument that we presented in the previous section; nevertheless, we will show that the expectation value of a generic link L has a beautiful periodicity in the colour state space \mathcal{T} .

In order to find $\mathcal{T}_{(1)}$, we shall produce the explicit expression of $\langle W(L) \rangle|_{\mathcal{S}_3}$ for a generic link L when $k = 1$. As we shall show, we only need to consider the double crossings between two lines of a link diagram. These crossings can be analyzed by using the graphical rules introduced in in chapter 2. Let us consider a part of a link diagram (tangle) which describes a two-string configuration. The no-crossing tangle, representing two parallel lines, can be decomposed as shown in Fig.4.6.

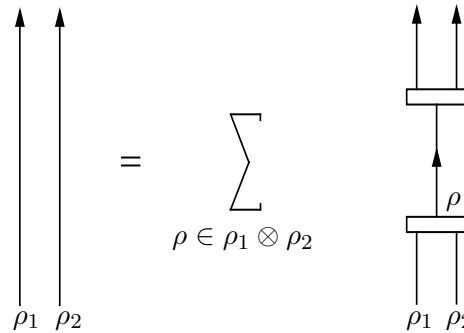

Figure 4.6

The “projectors” appearing on the right-hand side of the relation shown in Fig.4.6 represent skein modules. One can always imagine that the part of the link, which is described by the tangle, is contained inside a solid torus. Each projector simply selects one colour state of the standard basis of \mathcal{T} which flows along the core of this solid torus. The tangle corresponding to a double crossing can be decomposed [19, 31] as shown in Fig.4.7, where the twist variable $\alpha(a, b)$ is given by

$$\alpha(\rho) = \alpha(a, b) = q^{Q(a,b)} \quad . \tag{4.72}$$

When $k = 1$, one has

$$\alpha(a, b) = e^{-\frac{2\pi i}{3}(a^2+b^2+3a+3b+ab)} \quad . \tag{4.73}$$

The algebraic structure of expression (4.73) shows that $\alpha(a, b)$ depends on the values of a and b modulo 3. Let us introduce the triality t_ρ of an irreducible representation $\rho \simeq (a, b)$, defined as

$$t_\rho = a - b \pmod{3} \quad . \tag{4.74}$$

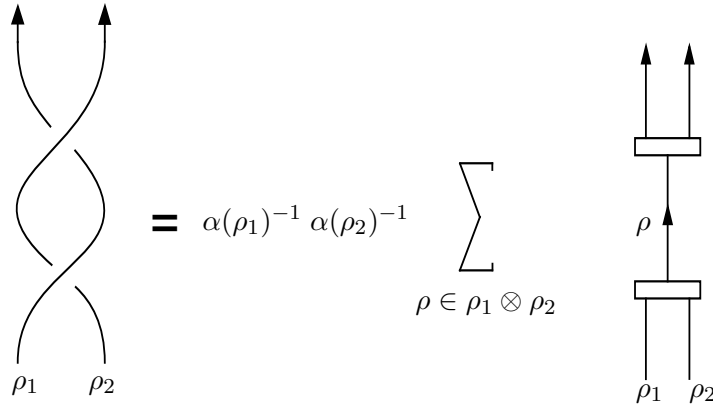

Figure 4.7

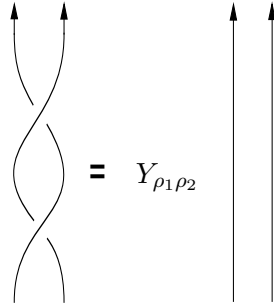

Figure 4.8

In our convention, the possible values taken by t_ρ are $\{-1, 0, 1\}$. The value of α variable is

$$\begin{aligned} \alpha(\rho) &= e^{-\frac{2\pi i}{3}} & \text{if } t_\rho \neq 0, \\ \alpha(\rho) &= 1 & \text{if } t_\rho = 0. \end{aligned} \tag{4.75}$$

Triality is conserved in the sense that all the irreducible representations $\{\rho_i\}$ of $SU(3)$, which enter the decomposition of the tensor product $\rho_1 \otimes \rho_2$, have the same triality:

$$\begin{aligned} \rho_1 \otimes \rho_2 &= \bigoplus_i \rho_i \\ t_{\rho_i} &= t_{\rho_1} + t_{\rho_2} \pmod{3} \quad \forall i \end{aligned} \tag{4.76}$$

Eqs.(4.75) and (4.76) imply that, for $k = 1$, the decomposition illustrated in Fig.13.2 takes the simple form shown in Fig.4.8. The complex coefficient $Y_{\rho_1 \rho_2}$ is given by

$$Y_{\rho_1 \rho_2} = e^{\frac{2\pi i}{3} t_{\rho_1} t_{\rho_2}} \tag{4.77}$$

Double under-crossing can be obtained simply by replacing $Y_{\rho_1 \rho_2}$ with its complex conjugate $Y_{\rho_1 \rho_2}^*$.

Let us now compute the expectation value of a Wilson line operator associated with a generic link L with n coloured components; the colour of the component C_i is given by the irreducible

representation ρ_i . The relation shown in Fig.(4.8) permits us to transform L into a collection of n disjoint knots. Consequently, one finds

$$\begin{aligned} \langle W(C_1, \dots, C_n; \rho_1, \dots, \rho_n) \rangle \Big|_{S^3} &= \\ &= F(t_{\rho_1}, \dots, t_{\rho_n}) \langle W(C_1; \rho_1) \rangle \Big|_{S^3} \cdots \langle W(C_n; \rho_n) \rangle \Big|_{S^3} , \end{aligned} \quad (4.78)$$

where

$$F(t_{\rho_1}, \dots, t_{\rho_n}) = \exp \left[\frac{2\pi i}{3} \sum_{i < j} \text{lk}(C_i, C_j) t_{\rho_i} t_{\rho_j} \right] . \quad (4.79)$$

At this stage, by using the relation of Fig.4.7 and eq.(4.75), we can transform each knot C_i into the unknot. Therefore we have

$$\langle W(C_1, \dots, C_n; \rho_1, \dots, \rho_n) \rangle \Big|_{S^3} = G(t_{\rho_1}, \dots, t_{\rho_n}) \left(\prod_{i=1}^n E_0[\rho_i] \right) , \quad (4.80)$$

with

$$G = \exp \left\{ \frac{-2\pi i}{3} \left[\sum_{i < j} 2 \text{lk}(C_i, C_j) t_{\rho_i} t_{\rho_j} + \sum_i \text{lk}(C_i, C_{i_f}) t_{\rho_i}^2 \right] \right\} . \quad (4.81)$$

At this point, from eq.(4.80) and eq.(4.81) it is clear that the equivalence classes of physically equivalent colour states are characterized only by triality. Therefore, the reduced tensor algebra $\mathcal{T}_{(1)}$ is of order equal to three [35, 33]. The elements of the standard basis of $\mathcal{T}_{(1)}$ are denoted by $\{\Psi[0], \Psi[1], \Psi[-1]\}$; the structure constants are determined by triality conservation

$$\begin{aligned} \Psi[1], \quad \Psi[0] \Psi[-1] &= \Psi[-1] \\ \Psi[1] \Psi[1] &= \Psi[-1], \quad \Psi[1] \Psi[-1] = \Psi[0] \\ \Psi[-1] \Psi[-1] &= \Psi[1] . \end{aligned} \quad (4.82)$$

Since, for $k = 1$, one has $E_0[a, b] = D(a, b)$, each element of \mathcal{T} corresponds to an element of $\mathcal{T}_{(1)}$ according to

$$\chi[a, b] \Rightarrow \begin{cases} D(a, b) \Psi[0] & \text{if } a - b = 0 \pmod{3} \\ D(a, b) \Psi[1] & \text{if } a - b = 1 \pmod{3} \\ D(a, b) \Psi[-1] & \text{if } a - b = -1 \pmod{3} \end{cases} . \quad (4.83)$$

As a check, let us verify that the Hopf matrix, defined in terms of basis elements of $\mathcal{T}_{(1)}$, is non singular. We consider the Hopf link, shown in Fig.8.1, in which each component is characterized by an element of the standard basis $\{\Psi[0], \Psi[1], \Psi[-1]\}$ of $\mathcal{T}_{(1)}$. The expectation value of the associated Wilson line operator is

$$H[\Psi[i], \Psi[j]] = H_{ij} , \quad (4.84)$$

where, according to eqs.(4.80) and (4.81), the 3×3 matrix H is given by

$$H = \begin{pmatrix} 1 & 1 & 1 \\ 1 & e^{\frac{2\pi i}{3}} & e^{\frac{i\pi}{3}} \\ 1 & e^{-\frac{2\pi i}{3}} & e^{\frac{2\pi i}{3}} \end{pmatrix} . \quad (4.85)$$

Since the Hopf matrix H is invertible, the set $\mathcal{T}_{(1)}$ is physically irreducible; this concludes the construction of the reduced tensor algebra for $k = 1$.

4.2.5 Reduced tensor algebra for $k = 2$

When $k = 2$, the value of the unknot is

$$E_0[m, n] \Big|_{k=2} = \begin{cases} 0 & \text{for } m \text{ and } n \text{ odd;} \\ -(n+1)/2 & \text{for } n \text{ odd and } n \text{ even;} \\ -(m+1)/2 & \text{for } m \text{ odd and } n \text{ even;} \\ -(m+n+2)/2 & \text{for } m \text{ and } n \text{ even.} \end{cases} \quad (4.86)$$

Property 2 and eq.(4.86) imply that each irreducible representation $\chi[m, n]$, with m and n odd, is physically equivalent to the null element of $\mathcal{T}_{(2)}$. The set of representations $\{\chi[m, n]\}$ with m and n odd is called \mathcal{A}_2 . The value of the twist variable for $k = 2$ is

$$\alpha(a, b) = (-1)^{a+b+ab} e^{-\frac{i\pi}{3}(a-b)^2} . \quad (4.87)$$

Apart from the irreducible representations physically equivalent to the null element, we find that the value of $\alpha(a, b)$ depends only on triality. More precisely, if the irreducible representation ρ does not belong to \mathcal{A}_2 , we have

$$\begin{aligned} \alpha(\rho) &= e^{\frac{2\pi i}{3}} & \text{if } t_\rho \neq 0 , \\ \alpha(\rho) &= 1 & \text{if } t_\rho = 0 . \end{aligned} \quad (4.88)$$

In analyzing the double crossings, we can ignore the representations contained in \mathcal{A}_2 ; indeed, each projector on a representation of this kind gives a vanishing contribution. Therefore, eq.(4.88) implies that the relation shown in Fig.4.8 is valid also for $k = 2$; we only need to compute the new values of the coefficients $Y_{\rho_1 \rho_2}$. From eq.(4.87) and the relation shown in Fig.13.7, for $k = 2$ one finds

$$Y_{\rho_1 \rho_2} = e^{-\frac{2\pi i}{3} t_{\rho_1} t_{\rho_2}} . \quad (4.89)$$

The same argument that we used in the previous section now gives

$$\langle W(C_1, \dots, C_n; \rho_1, \dots, \rho_n) \rangle_{S_3} = G'(t_{\rho_1}, \dots, t_{\rho_n}) \left(\prod_{i=1}^n E_0[\rho_i] \right) , \quad (4.90)$$

with

$$G' = \exp \left\{ \frac{2\pi i}{3} \left[\sum_{i < j} 2 \text{lk}(C_i, C_j) t_{\rho_i} t_{\rho_j} + \sum_i \text{lk}(C_i, C_{i_f}) t_{\rho_i}^2 \right] \right\} . \quad (4.91)$$

The equivalence classes of physically equivalent colour states are again characterized only by triality. Therefore, the reduced tensor algebra $\mathcal{T}_{(2)}$ is of order equal to three [35, 33]. The elements of the standard basis of $\mathcal{T}_{(2)}$ are denoted by $\{\Psi[0], \Psi[1], \Psi[-1]\}$ with structure constants

$$\begin{aligned} \Psi[0] \Psi[0] &= \Psi[0], & \Psi[0] \Psi[1] &= \Psi[1], & \Psi[0] \Psi[-1] &= \Psi[-1] \\ \Psi[1] \Psi[1] &= \Psi[-1], & \Psi[1] \Psi[-1] &= \Psi[0] \\ \Psi[-1] \Psi[-1] &= \Psi[1] . \end{aligned} \quad (4.92)$$

Each element of \mathcal{T} corresponds to an element of $\mathcal{T}_{(2)}$ according to

$$\chi[a, b] \Rightarrow \begin{cases} E_0[a, b] \Psi[0] & \text{if } a - b = 0 \pmod{3} \\ E_0[a, b] \Psi[1] & \text{if } a - b = 1 \pmod{3} \\ E_0[a, b] \Psi[-1] & \text{if } a - b = -1 \pmod{3} \end{cases} , \quad (4.93)$$

where $E_0[a, b]$ is given in eq.(4.86).

When $k = 2$ the Hopf matrix H , which is defined in terms of basis elements $\{\Psi[0], \Psi[1], \Psi[-1]\}$ of $\mathcal{T}_{(2)}$, is given by

$$H = \begin{pmatrix} 1 & 1 & 1 \\ 1 & e^{-\frac{2\pi i}{3}} & e^{\frac{2\pi i}{3}} \\ 1 & e^{\frac{2\pi i}{3}} & e^{-\frac{2\pi i}{3}} \end{pmatrix} . \quad (4.94)$$

Clearly, the Hopf matrix H is invertible and then $\mathcal{T}_{(2)}$ is physically irreducible.

We note that the reduced tensor algebras $\mathcal{T}_{(1)}$ and $\mathcal{T}_{(2)}$ are isomorphic and coincide with the group algebra of the center Z_3 of $SU(3)$.

4.3 Reduced tensor algebra for $SU(2)$

4.3.1 Reduced tensor algebra for $k \geq 2$

The strategy to construct the reduced tensor algebra when $G = SU(2)$ is similar to the case $G = SU(3)$, however this case is simpler. In this section we shall consider the case $k \geq 2$. From eq.(3.3), it follows that for $k \geq 2$

$$E_0[J] = 0 \quad \text{with } J = \frac{nk - 1}{2} \quad n \in \mathbb{Z}^+, n \geq 1 . \quad (4.95)$$

Thus, $\chi[J] \in I_{(k)}$ when J is of the form $J = (nk - 1)/2$, with $n \in \mathbb{Z}^+$, $n \geq 1$. The lowest value J_0 of J for which (4.95) is satisfied is

$$J_0 = \frac{k - 1}{2} . \quad (4.96)$$

By using the well known property of the tensor product decomposition into irreducible representations of $SU(2)$, it is quite easy to show that $I_{(k)}$ is generated by $\chi[J_0]$ for $k \geq 2$. Indeed, the following property holds.

Property 4.4

Let $\chi[J]$ be such that $\chi[J - d] \sim 0$ with $d = n/2 \quad n \in \mathbb{N}$, i.e. $\chi[J - d]$ is

physically equivalent to the null element; then we have

$$\chi[J] \sim -\chi[J - 2d] . \quad (4.97)$$

Proof

We prove (4.97) by induction. Let us consider the following decomposition of representations

$$\chi[J - 1] \chi[1] = \chi[J] + \chi[J - 1] + \chi[J - 2] . \quad (4.98)$$

When $d = 1$, by the hypothesis it follows that $\chi[J - 1] \sim 0$, thus eq.(4.98) implies

$$\chi[J] \sim -\chi[J - 1] . \quad (4.99)$$

Similarly, when $d = 1/2$, by using the decomposition

$$\chi[J - 1/2] \chi[1/2] = \chi[J] + \chi[J - 1] , \quad (4.100)$$

and the hypothesis $\chi[J - 1/2] \sim 0$, it follows that

$$\chi[J] \sim -\chi[J - 1] . \quad (4.101)$$

Eqs.(4.100) and (4.101) show that property 4.4 holds when $d = 1, 1/2$. Now suppose that property 4.4 is true for a fixed d , we shall show that is also true for $d + 1$ and $d + 1/2$. Let us consider the following decompositions

$$\chi[J] \chi[1] = \chi[J + 1] = \chi[J] + \chi[J - 1] \quad , \quad (4.102)$$

$$\chi[J - 2d] \chi[1] = \chi[J - 2d + 1] + \chi[J - 2d] + \chi[J - 2d - 1] \quad . \quad (4.103)$$

By the induction hypothesis

$$\chi[J] \sim -\chi[J - 2d], \quad \chi[J - 1] \sim -\chi[J - 2d + 1] \quad . \quad (4.104)$$

Therefore, by adding eqs.(4.102) and (4.103) and by using eq.(4.104), one gets

$$\chi[J + 1] \sim -\chi[J - 2d - 1] \quad . \quad (4.105)$$

Eq.(4.105) shows that property 4.4 holds also for $d + 1$. Finally, let us consider the decompositions

$$\chi[J] \chi[1/2] = \chi[J + 1/2] + \chi[J - 1/2] \quad , \quad (4.106)$$

$$\chi[J - 2d] \chi[1/2] = \chi[J - 2d + 1/2] + \chi[J - 2d - 1/2] \quad . \quad (4.107)$$

By the hypothesis on has

$$\chi[J] \sim -\chi[J - 2d], \quad \chi[J - 1/2] \sim \chi[J - 2d + 1/2] \quad . \quad (4.108)$$

By adding eqs.(4.106) and (4.107) and by using eq.(4.108), it follows

$$\chi[J + 1/2] \sim -\chi[J - 2d - 1/2] \quad . \quad (4.109)$$

Eq.(4.109) shows that property 4.4 holds also for $d + 1/2$. \square

Property 4.4 determines the reduced tensor algebra completely. Let us introduce the “fundamental” domain Δ_k defined as

$$\Delta_k = \left\{ J \text{ such that } 0 \leq J < J_0 = \frac{k-1}{2} \right\} \quad . \quad (4.110)$$

Given $\chi[J] \in \mathcal{T}_k$, by using property 4.4 recursively, one can show that either $\chi[J]$ is equivalent to an element of the fundamental domain or is physically equivalent to the null element. Indeed, for any J , one can find $n \in \mathbb{N}$ such that

$$J = nJ_0 + \tilde{J} \quad , \quad (4.111)$$

with $\tilde{J} \in \Delta_k$. In particular from eq.(4.111) and property 4.4 it follows that, when $\chi[J] \not\sim 0$, on has

$$\chi[J] \sim (-1)^n \chi[\tilde{J}] \quad . \quad (4.112)$$

Because any element $\chi \in \mathcal{T}_k$ can be decomposed as

$$\chi = \sum_J \xi(J) \chi[J] \quad , \quad (4.113)$$

from eq.(4.112), it follows that the standard basis of \mathcal{T}_k for $k \geq 2$ is the following

$$\left\{ \Psi[J] \quad \text{with} \quad \frac{k}{2} - 1 \geq J \geq 0 \right\} \quad . \quad (4.114)$$

In particular, any element $\Psi[J]$ of the standard basis admits as a representative an irreducible representation $\chi[J]$; the equivalence relation is the following

$$\Psi[J] \Leftrightarrow \chi[J], \quad \text{with} \quad \frac{k}{2} - 1 \geq J \geq 0 \quad . \quad (4.115)$$

It follows from (4.114) that, for $k \geq 2$, \mathcal{T}_k is of order $(k - 1)$. This results was originally obtained in [19].

4.3.2 Reduced tensor algebra for $k = 1$

In this section we shall consider the special case $k = 1$. From the general expression (3.3), it follows that $E_0[J]$ never vanishes when $k = 1$. Indeed

$$\lim_{k \rightarrow 1} E_0[J] = (-1)^{2J} (2J + 1) \quad . \quad (4.116)$$

When $k = 1$ the deformation parameter is very simple $q(1) = q(1)^{-1} = 1$. Starting from this fact one can derive [31] a general expression for the expectation value of a link L with components $\{C_1, \dots, C_m\}$ and colours $\{\chi[J_1], \dots, \chi[J_m]\}$; one has

$$E(L) = \left(\prod_{i=1}^m E_0[J_i] \right) \exp \left[\frac{i\pi}{2} \left(\sum_a \mathcal{W}(C_a) + 2 \sum_{a < b} \text{lk}(C_a, C_b) \right) \right] \quad . \quad (4.117)$$

Eq.(4.117) shows that there are only two physically independent classes, thus the reduced tensor algebra \mathcal{T}_2 is of order two. Let us introduce the two elements $\Psi[0]$ and $\Psi[1/2]$ of the standard basis of \mathcal{T}_2 . The structure constants are the following

$$\begin{aligned} \Psi[0] \Psi[0] &= \Psi[0], & \Psi[0] \Psi[1/2] &= \Psi[1/2], \\ \Psi[1/2] \Psi[1/2] &= \Psi[0] \quad . \end{aligned} \quad (4.118)$$

As a consequence of (4.118), \mathcal{T}_2 is isomorphic with the group algebra of the center of $SU(2)$, Z_2 . Given $\chi[J] \in \mathcal{T}$, it can be associated with an element of the standard basis of \mathcal{T}_2 . Explicitly

$$\begin{aligned} \chi[J] &\Rightarrow (2J + 1)\Psi[0] && \text{for } J \text{ integer} \quad ; \\ \chi[J] &\Rightarrow (2J + 1)\Psi[1/2] && \text{for } J \text{ not integer} \quad . \end{aligned} \quad (4.119)$$

Chapter 5

Dehn's surgery

5.1 Introduction

In this chapter we shall describe a powerful method which permits to construct every closed, connected and orientable 3-manifold starting from the reference 3-manifold S^3 . We recall that a manifold is called closed when it is compact and without boundary. This technique, pioneered by Dehn, is based on a finite number surgery operations. The single operations consist in cutting from S^3 a solid torus $N = D^2 \times S^1$ and then in sewing back N to $S^3 - N$ by identifying their boundaries with an appropriate homeomorphism h . Dehn's surgery will be the key ingredient in solving Chern-Simons field theory in any closed, connected and orientable 3-manifold; it turns out that the surgery instructions in S^3 admit a realization as symmetry transformations on the observables of the Chern-Simons theory in S^3 .

In order to introduce Dehn's surgery, it is worth to recall some mathematical results concerning torus topology.

5.2 Knots in a torus

The two-dimensional torus T^2 is a manifold homeomorphic with $S^1 \times S^1$. A useful coordinates system on T^2 is the following

$$\left(e^{i\theta_1}, e^{i\theta_2} \right) \equiv (\theta_1, \theta_2) \quad 0 \leq \theta_i \leq 2\pi \quad i = 1, 2 \quad . \quad (5.1)$$

The fundamental group of T^2 is $\pi_1(T^2) = \mathbb{Z} \oplus \mathbb{Z}$ [23]. Any element $g \in \pi_1(T^2)$ can be decomposed as

$$g = \gamma_L^a \oplus \gamma_M^b \quad a, b \in \mathbb{Z} \quad , \quad (5.2)$$

where γ_L and γ_M are the generators of $\pi_1(T^2)$, respectively the standard longitude and the standard meridian of T^2 ; they corresponds to the following oriented curves in T^2

$$\begin{aligned} \gamma_L &= \left(e^{i\theta}, 1 \right) & 0 \leq \theta \leq 2\pi \\ \gamma_M &= \left(1, e^{i\theta} \right) & 0 \leq \theta \leq 2\pi \quad . \end{aligned} \quad (5.3)$$

The standard longitude and the standard meridian are shown in Figure 5.1.

Roughly speaking, if one pictures T^2 as the surface of a doughnut, γ_L winds the hole one time and γ_M winds the interior one time. Clearly, neither γ_L nor γ_M can be continuously shrunk to a point; moreover, γ_L cannot be continuously deformed to γ_M .

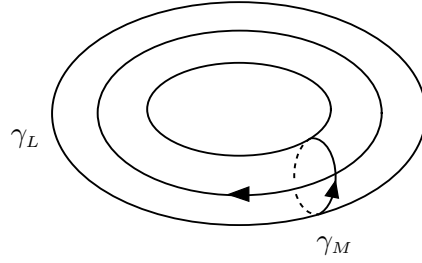

Figure 5.1

In general, given a continuous map $f : S^1 \rightarrow T^2$, its homotopy class $[f]$ is represented by two integers with sign [23]; that is

$$[f] = \gamma_L^a \oplus \gamma_M^b \equiv (a, b) \quad . \quad (5.4)$$

Is not difficult to show that if K is a knot in T^2 and

$$[K] = (a, b) \quad , \quad (5.5)$$

then a, b must be coprime. It also can be shown that a knot K in T^2 is essential, i.e. homotopically non-trivial, if and only if $[K] \neq (0, 0)$.

Let us introduce two important self-homeomorphisms of T^2 [23]. The longitudinal twist is defined as

$$h_L(e^{i\theta_1}, e^{i\theta_2}) = (e^{i(\theta_1+\theta_2)}, e^{i\theta_2}) \quad . \quad (5.6)$$

The meridinal twist is defined as

$$h_M(e^{i\theta_1}, e^{i\theta_2}) = (e^{i\theta_1}, e^{i(\theta_1+\theta_2)}) \quad . \quad (5.7)$$

Clearly, the corresponding inverse maps will be given by

$$\begin{aligned} h_L^{-1}(e^{i\theta_1}, e^{i\theta_2}) &= (e^{i(\theta_1-\theta_2)}, e^{i\theta_2}) \quad , \\ h_M^{-1}(e^{i\theta_1}, e^{i\theta_2}) &= (e^{i\theta_1}, e^{i(\theta_2-\theta_1)}) \quad . \end{aligned} \quad (5.8)$$

The effects of the longitudinal and meridinal twists on the homotopy class of a map $f : S^1 \rightarrow T^2$ can be easily derived

$$\begin{aligned} [f]_{h_L} &= h_L^*(\gamma_L^a \oplus \gamma_M^b) = \gamma_L^{(a+b)} \oplus \gamma_M^b \quad , \\ [f]_{h_M} &= \gamma_L^a \oplus \gamma_M^{(a+b)} \quad , \\ [f]_{h_L^{-1}} &= \gamma_L^{(a-b)} \oplus \gamma_M^b \quad , \\ [f]_{h_M^{-1}} &= \gamma_L^a \oplus \gamma_M^{(b-a)} \quad . \end{aligned} \quad (5.9)$$

The action of h_L, h_M on $[f]$ is represented by 2×2 matrices

$$\begin{aligned} (a, b) \xrightarrow{h_L} (a, b)_{h_L} &= (a, b) \begin{pmatrix} 1 & 0 \\ 1 & 1 \end{pmatrix}, & (a, b)_{h_L^{-1}} &= (a, b) \begin{pmatrix} 1 & 0 \\ -1 & 1 \end{pmatrix}, \\ (a, b) \xrightarrow{h_M} (a, b)_{h_M} &= (a, b) \begin{pmatrix} 1 & 1 \\ 0 & 1 \end{pmatrix}, & (a, b)_{h_M^{-1}} &= (a, b) \begin{pmatrix} 1 & -1 \\ 0 & 1 \end{pmatrix}. \end{aligned} \quad (5.10)$$

The standard longitude can be mapped into the standard meridian by a sequence of twists

$$\begin{aligned} (0, 1) &= h_L^{*-1} h_M^* (1, 0), \\ h_L &\rightarrow h_M = h_L^{-1} h_M. \end{aligned} \quad (5.11)$$

The ambient isotopic class of a knot in T^2 is determined by its homotopy class as stated by the following theorem: [23]

Theorem 5.1 *Given two knots $J, K \in T^2$, they are ambient isotopic if and only if $[J] = \pm[K]$.*

5.3 The mapping class group of the torus

Given a manifold M , the group of self-homeomorphisms, modulo an ambient isotopy, is called the mapping class group of M . Let us consider the case $M = T^2$. Any homeomorphism $h : T^2 \rightarrow T^2$ acts naturally on the elements of $\pi_1(T^2)$ represented by (a, b) as

$$(a, b) \xrightarrow{h^*} (a, b)_h = h^* \quad (5.12)$$

As we have seen, h^* can be represented by 2×2 matrix whose elements belong to \mathbb{Z} , i.e $h^* \in GL(2, \mathbb{Z})$. On the other hand, because also $h^{-1*} = h^{*-1}$ must be in $GL(2, \mathbb{Z})$, it follows that $\det(h^*) = \pm 1$. Any element of $GL(2, \mathbb{Z})$ can be written as a product of the following matrices

$$h_M^* = \begin{pmatrix} 1 & 1 \\ 0 & 1 \end{pmatrix}, \quad h_L^* = \begin{pmatrix} 1 & 0 \\ 1 & 1 \end{pmatrix}, \quad h_C^* = \begin{pmatrix} 0 & 1 \\ 1 & 0 \end{pmatrix}. \quad (5.13)$$

The map $*$ gives a homomorphism between the group of self-homeomorphisms $\text{Aut}(T^2)$ of T^2 and $GL(2, \mathbb{Z})$

$$\text{Aut}(T^2) \xrightarrow{*} GL(2, \mathbb{Z})_* \quad (5.14)$$

The map $*$ is surjective and its kernel is non-trivial and consists of the elements of $\text{Aut}(T^2)$ homotopically equivalent to the identity map; these elements corresponds under $*$ to the identity matrix in $GL(2, \mathbb{Z})$ [23]. When all the elements of $\text{Aut}(T^2)$ homotopically equivalent to the identity map are identified, the kernel of $*$ become trivial, and the group of $\text{Aut}(T^2)$, modulo ambient isotopy, is isomorphic with $GL(2, \mathbb{Z})_*$. Conversely, the maps homotopically equivalent to the identity corresponds under $*$ to the identity matrix in $GL(2, \mathbb{Z})$ [23]. Thus, the group of $\text{Aut}(T^2)$, modulo an ambient isotopy, is isomorphic with $GL(2, \mathbb{Z})$. In other words the mapping class group of T^2 is isomorphic with $GL(2, \mathbb{Z})$.

5.4 Solid torus

Solid tori are the basic objects in Dehn's surgery. A solid torus V is a 3-manifold homeomorphic with $S^1 \times D^2$; its boundary is a torus. The fundamental group of V is \mathbb{Z} . In $S^1 \times D^2$, the standard

meridian of T^2 becomes homotopically trivial, only the standard longitude survives as a generator of $\pi_1(V)$. A point p in $S^1 \times D^2$ can be represented by the triple

$$\begin{aligned} p &\equiv \left(e^{i\theta_1}, \rho e^{i\theta_2} \right) \quad ; \\ 0 &\leq \theta_1, \theta_2 \leq 2\pi \quad . \end{aligned} \quad (5.15)$$

where ρ and θ_2 are standard polar coordinates on the complex plane and D^2 is embedded in it. A meridian μ is a simple closed curve which is essential in ∂V but homotopically trivial in V . A longitude λ is a simple closed curve in V which intersect a meridian transversally. The actual realization of topology of a solid torus V is described by a homeomorphism $h_{fr} : S^1 \times D^2 \rightarrow V$ called framing of V [23]. Given a framing h_{fr} , a longitude λ is naturally identified: the simple closed curve in $\partial V = T^2$

$$\lambda = h_{fr}(l) \quad , \quad (5.16)$$

where $l \subset S^1 \times D^2$ is the curve defined as

$$l = \left\{ \left(e^{i\theta_1}, 1 \right) ; \quad 0 \leq \theta_1 \leq 2\pi \right\} \quad . \quad (5.17)$$

Clearly, the definition of a longitude make use of the actual realization of the topology of the solid torus as specified by the homeomorphism h . On the contrary, the notion of meridian is intrinsic to V ; indeed, given two meridians of V it can be shown that they are ambient isotopic.

In general, given a knot K in a manifold M , a tubular neighborhood of K is a homeomorphism h_{tub} defined by

$$\begin{aligned} h_{tub} : S^1 \times D^2 &\rightarrow M \quad , \\ h_{tub} (S^1, 1) &= K \subset M \quad . \end{aligned} \quad (5.18)$$

In other words, any knot in M can be imagined as contained in a solid torus V as shown in Fig. 5.3, the embedding of V in M depends on K . The image of the S^1 “component” under h_{tub} , see Eq. (5.18), represents the core of the solid torus V embedded in M and coincides with the knot K as shown in Fig. 5.2.

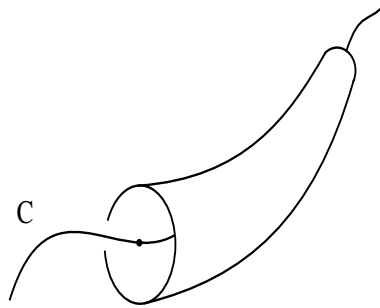

Figure 5.2

Let us consider a knot C in S^3 and its tubular neighborhood $N \subset S^3$. Given a framing h_{fr} of N , h_{fr} defines a framing C_f for C by the “natural” longitude associated with h_{fr} , i.e.

$$C_f = h_{fr}(S^1, 1) \quad . \quad (5.19)$$

Conversely, given a framing C_f of C , as introduced in Chap.1, a framing h_{fr} of the tubular neighborhood N of C is defined. Indeed, once the orientation of C is chosen, the linking number between C and C_f fixes the framing h_{fr} of N up to an ambient isotopy. In particular, when the linking number between C and C_f or between C and $h_{fr}(S^1, 1)$ is vanishing the framing is called preferred. By means of h_{fr} , one can introduce a canonical set of generators for $\pi_1(\partial N)$ called the Rolfsen basis. First of all, an orientation to C is given. The first generator will correspond to longitude λ defined in (5.16), where h_{fr} is a preferred framing of N ; the orientation of λ is induced by C . The second generator will correspond to the meridian

$$\mu = h_{fr}(1, \partial D^2) \quad . \quad (5.20)$$

The orientation of the meridian is chosen in a such way that

$$\text{lk}(\mu, \lambda) = 1 \quad . \quad (5.21)$$

The Rolfsen basis for the tubular neighborhood of an unknot is shown in Fig. 5.3.

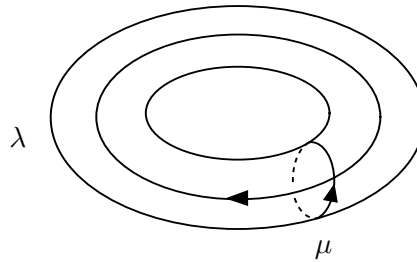

Figure 5.3

Given a solid torus N , a homeomorphism $h : \partial N \rightarrow \partial N$ can be extended to a self homeomorphism $h' : N \rightarrow N$, if and only if the image of a meridian of ∂N under h is still a meridian of ∂N [23]. A homeomorphism H which satisfies this property is represented by an element $h^* \in SL(2, \mathbb{Z})$ of the mapping class group of ∂N , and it is of the form

$$h^* = \begin{pmatrix} 1 & n \\ 0 & 1 \end{pmatrix} \quad n \in \mathbb{Z} \quad . \quad (5.22)$$

Thus, the self-homeomorphisms of ∂V which can be extended as self-homeomorphisms of V are precisely sequences of meridional twists h_M described in Sect. 5.2. The extensions $\tilde{\tau}_+$ and $\tilde{\tau}_-$ of respectively h_M and of its inverse h_M^{-1} on $S^1 \times D^2$ admit the following presentation in terms of the coordinates (5.15)

$$\tau_{\pm} = \tilde{\tau}_{\pm}(e^{i\theta_1}, re^{i\theta_2}) = (e^{i\theta_1}, re^{i(\theta_2 \pm \theta_1)}) \quad . \quad (5.23)$$

Now, let us consider the tubular neighborhood N of a knot C and a preferred framing h_{fr} of N , i.e. $h_{fr} : S^1 \times D^2 \rightarrow N$. The right-handed twist τ_+ and the left-handed twist τ_- on N are obtained by the following composition of homeomorphisms

$$\tau_{\pm} = h_{fr} \cdot \tilde{\tau}_{\pm} \cdot h_{fr}^{-1} \quad . \quad (5.24)$$

In the next section we shall see that τ_{\pm} are crucial in the Dehn's surgery; in particular, a distinguished role is played by the action of τ_{\pm} on the solid torus $S^3 - \dot{N}$ obtained from S^3 by removing the internal points of the tubular neighborhood of an unknot $U \subset S^3$. It should be noted that with respect to N the role of λ and μ in $S^3 - \dot{N}$ are exchanged. Actually, the curve (5.16) is a meridian of $S^3 - \dot{N}$ and the curve (5.20) is a longitude of $S^3 - \dot{N}$. The effect of a right-handed (left-handed) twist on sample knots without framing in $S^3 - \dot{N}$ depicted in Fig. 5.4 is shown in Fig. 5.5 and in Fig. 5.6. The effect of a right-handed twist on the same knots of those of Fig. 5.4, now considered with preferred framing, is shown in Fig. 5.7.

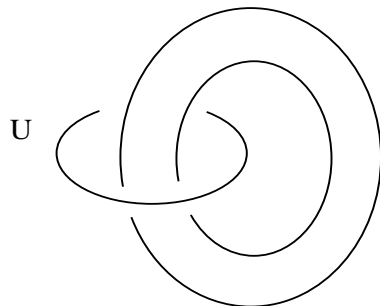

Figure 5.4

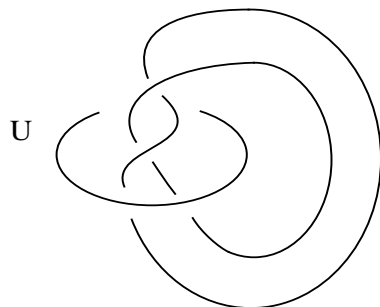

Figure 5.5

In general the effect of τ_{\pm} on the framing of a knot K contained in $S^3 - \dot{N}$ is the following [23]

$$\text{lk}(K', K'_f) = \text{lk}(K, K_f) \pm [\chi(K, U)]^2 \quad , \quad (5.25)$$

where K' and K'_f are the images of K and K_f under τ_{\pm} .

5.5 Dehn's surgery

In this section we recall some basic definitions of surgery on three-manifolds. Let us consider surgery operations in S^3 . A Dehn's surgery performed along a knot \mathcal{Z} in S^3 consists of

- removing the interior \dot{N} , of a tubular neighborhood N of the knot \mathcal{Z} , from S^3 ;
- considering $S^3 - \dot{N}$ and N as distinct spaces whose (distinct) boundaries $\partial(S^3 - \dot{N})$ and ∂N are tori;

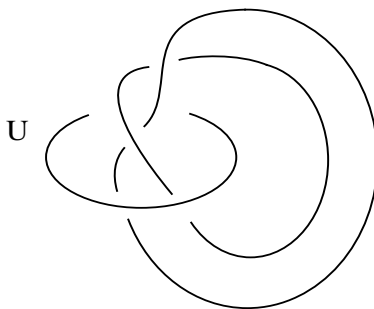

Figure 5.6

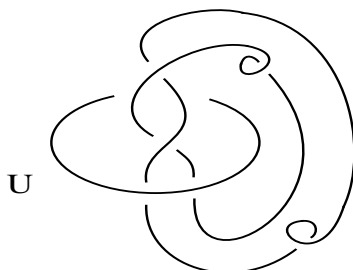

Figure 5.7

- gluing back N and $S^3 - \dot{N}$ by identifying the points on their boundaries ∂N and $\partial(S^3 - \dot{N})$ according to a given homeomorphism $h : \partial N \rightarrow \partial(S^3 - \dot{N})$.

The knot \mathcal{Z} and the “gluing” homeomorphism h completely specify the surgery operation and the resulting manifold is denoted by

$$M = (S^3 - \dot{N}) \bigcup_h N \quad . \quad (5.26)$$

Actually, the manifold (5.26) depends [23], up to homeomorphisms, only upon the homotopy class of $h(\mu)$ in $\partial(S^3 - \dot{N})$, where μ is a meridian of N . The surgery is then characterized by the knot \mathcal{Z} and by a closed curve $Y \in \partial N$ representing $h(\mu)$. The convention, introduced by Rolfsen [23], which is used to codify the surgery instruction is the following. The class $[Y] \in \pi_1(\partial N)$ is written as

$$[Y] = a \cdot [\lambda] + b \cdot [\mu] \quad , \quad (5.27)$$

where the generators λ and μ are the longitude and the meridian of a Rolfsen basis [23, 37] in ∂N . Since Y is a knot in ∂N , the integer coefficients a and b appearing in eq.(2.2) are relatively prime. The ratio

$$r = \frac{b}{a} \quad (5.28)$$

is called the surgery coefficient. In conclusion, the surgery instruction is simply specified by the knot \mathcal{Z} in S^3 and by the rational surgery coefficient r .

The knot \mathcal{Z} , along which surgery is performed, is not oriented and Y also is not oriented. Therefore, in a fixed Rolfsen basis, the coefficients a and b appearing in (5.27) possess an overall ambiguity in their signs, depending on the choice of the orientation of Y . Similarly, for a fixed orientation of Y , a different choice of the Rolfsen basis modifies both signs of the coefficients a and b . This ambiguity does not affect the resulting manifold obtained by surgery and, in fact, this ambiguity disappears in the surgery coefficient r .

When $a = 0$, necessarily $b = \pm 1$ and the surgery coefficient is indicated by $r = \infty$. In this case, Y is a meridian of N . This means that the image, under the gluing homeomorphism h , of the meridian μ of N is ambient isotopic with μ itself. Therefore, the resulting manifold is just S^3 . In conclusion, the surgery instruction specified by an arbitrary knot \mathcal{Z} with surgery coefficient $r = \infty$ corresponds to the identity.

Clearly, the surgery operation of removing and sewing a solid torus can be repeated several times. Therefore, a general surgery instruction consists of an unoriented link \mathcal{L} in S^3 , called the surgery link, with given surgery coefficients $\{r_i\}$ assigned to its components $\{\mathcal{L}_i\}$.

For example, when \mathcal{L} is the unknot with surgery coefficient $r = b/a$, the resulting space is homeomorphic with the lens space $L(b, a)$. In particular, the unknot with surgery coefficient $r = 0$ corresponds to $S^2 \times S^1$. If \mathcal{L} coincides with the Borromean Rings with all the surgery coefficients equal to $+1$, the resulting manifold is the icosahedral space or Poincaré manifold \mathcal{P} . The Borromean Rings with surgery coefficients $r_i = 0$, for $i = 1, 2, 3$, represent $S^1 \times S^1 \times S^1$.

Different surgery instructions do not necessarily correspond to different manifolds. To be more precise, two manifolds associated with different surgery instructions are homeomorphic if and only if the two surgery instructions are related [23, 38] by a finite sequence of Rolfsen moves.

A Rolfsen move of the first type is quite obvious: it states that one can add or eliminate a component of the surgery link \mathcal{L} with surgery coefficient $r = \infty$. A Rolfsen move of the second type describes the effects of an appropriate twist homeomorphism τ_{\pm} acting on a solid torus which contains part of the surgery link. Let \mathcal{L} be a surgery link in which one of its components, say \mathcal{L}_1 , is the unknot with surgery coefficient r_1 . This means that all the remaining components $\{\mathcal{L}_j\}$ (with $j \neq 1$) of \mathcal{L} belong to the complement solid torus \mathcal{V}_1 of \mathcal{L}_1 in S^3 . Under a twist homeomorphism τ_{\pm} of \mathcal{V}_1 , the component \mathcal{L}_1 is not modified, i.e. $\mathcal{L}'_1 = \mathcal{L}_1$. The remaining components $\{\mathcal{L}_j\}$ are transformed under the twist τ_{\pm} , $\tau_{\pm} : \mathcal{L}_j \rightarrow \mathcal{L}'_j$, according to the rules illustrated in the previous section (see also [23]). Furthermore, the surgery coefficients also are modified. One can show [23] that the new surgery coefficients are

$$r'_1 = \frac{1}{(1/r_1) \pm 1} \quad , \quad (5.29)$$

and

$$r'_j = r_j \pm [\text{lk}(\mathcal{L}_j, \mathcal{L}_1)]^2 \quad \text{for } j \neq 1 \quad , \quad (5.30)$$

where $\text{lk}(\mathcal{L}_j, \mathcal{L}_1)$ is the linking number of \mathcal{L}_j and \mathcal{L}_1 . Thus, we have two surgery instructions which are described, respectively, by

- (i) the surgery link \mathcal{L} with surgery coefficients $\{r_i\}$;
- (ii) the surgery link \mathcal{L}' with surgery coefficients $\{r'_i\}$.

The surgery instructions (i) and (ii) are said to be related by a Rolfsen move of the second kind and describe homeomorphic manifolds.

For example, the three surgery instructions shown in Fig.5.8 describe the manifold $S^2 \times S^1$. The first and the second instructions are related by a Rolfsen move of the second kind, whereas the second and the third instructions are related by a Rolfsen move of the first kind.

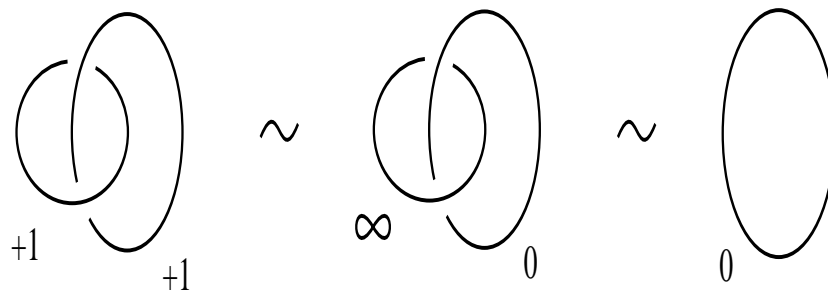

Figure 5.8

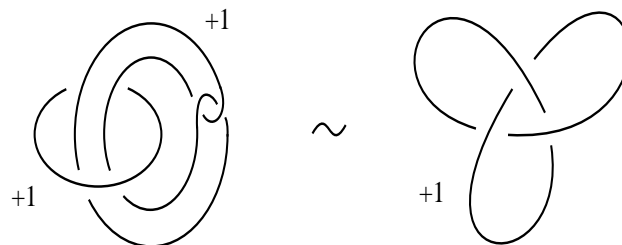

Figure 5.9

The surgery instructions, shown in Fig.2.2, are related by Rolfsen moves and correspond to the Poincaré manifold \mathcal{P} .

Two different surgery instructions, which are related by a finite sequence of Rolfsen moves, are called equivalent. The set of all possible surgery instructions can be decomposed into classes of equivalent instructions and a function defined on these equivalence classes is called a three-manifold invariant.

It should be noted that finite sequences of Rolfsen moves actually correspond to the set of orientation-preserving self-homeomorphisms of a given three-manifold. If we wish to include self-homeomorphisms which are not orientation-preserving, we simply need to add the inversion of S^3 (or mirror-reflection) as an admissible move.

Let M be the manifold described by the surgery link \mathcal{L} . The ambient isotopy class of a given framed oriented link in M will be represented by a framed oriented link L in the complement of \mathcal{L} in S^3 .

Lickorish's (or Fundamental) Theorem [39] states that every closed, orientable and connected three-manifold can be obtained by surgery in S^3 ; moreover one may always find such a surgery

presentation in which the surgery coefficients are all ± 1 and the individual components of the surgery link are unknotted. Let us denote by S_+ and S_- the elementary surgery operations in S^3 corresponding to the instructions described by the unknot U in S^3 with surgery coefficient $r = +1$ and $r = -1$ respectively. The three-manifold obtained according to a single surgery instruction S_+ or S_- is homeomorphic with S^3 . By combining several surgeries S_{\pm} , any three-manifold M can be obtained.

Let us introduce the so-called “honest” surgeries [23, 38, 39]. It is not difficult to prove that one can always find a “honest” surgery presentation of a given three-manifold: this simply means that all the surgery coefficients $\{r_i\}$ are integers. When the ratio r , appearing in eq.(5.28), is an integer, one can take $a = 1$ and $b = r$ in eq.(5.27). In this case, the curve Y is a longitude of N and can be interpreted as a framing of the surgery knot \mathcal{Z} . The linking number $\text{lk}(\mathcal{Z}, Y)$ of \mathcal{Z} and Y is given precisely by the coefficient b , see eq.(5.27), and then

$$\text{lk}(\mathcal{Z}, Y) = r \quad . \quad (5.31)$$

Therefore, a surgery link \mathcal{L} with integer surgery coefficients $\{r_i\}$ can be represented by a framed link \mathcal{L} in which the linking number of the component \mathcal{L}_i and its framing \mathcal{L}_{if} is equal to r_i .

Let us now consider the set of all possible instructions corresponding to “honest” surgeries. Two such different instructions describe homeomorphic manifolds if and only if they are related [4] by a finite sequence of Kirby moves. A Kirby move is the analogue of a Rolfsen move and can be defined as follows. Suppose that one component, say \mathcal{L}_1 , of \mathcal{L} is the unknot with framing \mathcal{L}_{1f} such that $\text{lk}(\mathcal{L}_1, \mathcal{L}_{1f}) = \pm 1$. Then, this component can be eliminated provided that we perform a twist τ_{\mp} on the complement solid torus \mathcal{V}_1 of \mathcal{L}_1 in S^3 . In general, let us consider a Kirby move when a real link L is also present in the manifold M . In this case, the twist τ_{\mp} of solid torus \mathcal{V}_1 clearly acts on all the remaining components of \mathcal{L} and, simultaneously, on the link L .

By using eqs.(5.29) and (5.30), entering the definition of the Rolfsen moves, and the transformation property [23] of framings under twist homeomorphisms, it is easy to prove that the invariance under Kirby moves is in fact equivalent to the invariance under Rolfsen moves.

Chapter 6

Surgery in Chern-Simons field theory

6.1 Elementary surgeries

In order to solve the CS theory in a generic three-manifold \mathcal{M} , we need to compute the expectation values of Wilson line operators in \mathcal{M} . As we have already mentioned, each link in \mathcal{M} can be represented by a link in the complement of \mathcal{L} in S^3 , where \mathcal{L} is a surgery link corresponding to \mathcal{M} . According to Lickorish's Theorem, \mathcal{L} can be taken to be a collection of unknots with surgery coefficients ± 1 . Thus, we only need to consider the effect of a single elementary surgery operation S_+ or S_- .

The surgery instruction associated with S_{\pm} is represented by the unknot U in S^3 with surgery coefficient $r = \pm 1$. From the invariance under Kirby moves, it follows that S_+ (S_-) can be interpreted [37] as the generator of a left-handed twist τ_- (right-handed twist τ_+) in the complement solid torus of U in S^3 . Therefore, for any given framed link L in the complement of U in S^3 , the action of S_{\pm} is given by

$$S_{\pm} : L \rightarrow L^{(\mp)} \quad , \quad (6.1)$$

where $L^{(\mp)}$ is the image of L under a twist homeomorphism τ_{\mp} of the complement solid torus of U in S^3 . So, under surgery S_{\pm} , the observables of the CS theory transform as

$$S_{\pm} : \langle W(L) \rangle |_{S^3} \rightarrow \langle W(L^{(\mp)}) \rangle |_{S^3} \quad . \quad (6.2)$$

At this point, our strategy [37] is to find field theory operators $\widetilde{W}(U; \pm 1)$ which represent the surgery operations S_{\pm} according to

$$\langle W(L^{(\mp)}) \rangle |_{S^3} = \langle W(L) \widetilde{W}(U; \pm 1) \rangle |_{S^3} \Big/ \langle \widetilde{W}(U; \pm 1) \rangle |_{S^3} \quad . \quad (6.3)$$

For the quantum CS field theory in S^3 , with fixed integer k , the physically inequivalent gauge invariant quantum numbers associated with a knot (or a solid torus) are given (see Chap.4) by the elements of the reduced tensor algebra $\mathcal{T}_{(k)}$. Let us denote by $\{\psi_i\}$ the elements of the standard basis of $\mathcal{T}_{(k)}$, where the collective index i runs from 1 to the dimension of the reduced tensor algebra and ψ_1 denotes the identity element in $\mathcal{T}_{(k)}$.

Let us recall (see Chap.2) that any gauge invariant observable $\mathcal{O}(C)$ associated with the knot C admits a decomposition

$$\mathcal{O}(C) = \sum_{\rho} \xi'(\rho) W(C; \chi[\rho]) \quad , \quad (6.4)$$

where $\{\xi'(\rho)\}$ are numerical (complex) coefficients. In equation (6.4), the sum is over the inequivalent irreducible representations of the gauge group. The Wilson line operators, entering eq.(6.4), are defined for the knot C with a given choice of its framing and its orientation. For fixed integer k , different elements $\chi[\rho]$ and $\chi[\rho']$ of the tensor algebra \mathcal{T} do not necessarily represent physically inequivalent colour states. In terms of the physically inequivalent colour states, eq.(6.4) becomes

$$\mathcal{O}(C) = \sum_i \xi(i) W(C; \psi_i) \quad , \quad (6.5)$$

where $\{\psi_i\}$ are the elements of the standard basis of the reduced tensor algebra $\mathcal{T}_{(k)}$ and the coefficients $\{\xi(i)\}$ are linear combinations of $\{\xi'(\rho)\}$. Therefore, the elementary surgery operators $\widetilde{W}(U; \pm 1)$ can be written as

$$\widetilde{W}(U; \pm 1) = \sum_i \phi_{\pm}(i) W(U; \psi_i) \quad , \quad (6.6)$$

where, in our convention, the unknot U has preferred framing and a fixed orientation. Now, our purpose is to determine the coefficients $\{\phi_{\pm}(i)\}$. Let us consider a generic framed L which does not intersect U . This means that L belongs to the complement solid torus \mathcal{V} of U in S^3 . According to eq.(6.5), $W(L)$ can always be written as

$$W(L) = \sum_j \xi(j) W(C; \psi_j) \quad , \quad (6.7)$$

where $W(C; \psi_j)$ is the Wilson operator associated with the oriented core C of \mathcal{V} with preferred framing. Let $L^{(\pm)}$ ($C^{(\pm)}$) be the image of L (C) under a twist homeomorphism τ_{\pm} of \mathcal{V} . From eq.(6.7) it follows that

$$W(L^{(\pm)}) = \sum_j \xi(j) W(C^{(\pm)}; \psi_j) \quad . \quad (6.8)$$

The vacuum expectation value of both sides of this equation gives

$$\langle W(L^{(\pm)}) \rangle_{S^3} = \sum_j \xi(j) q^{\pm Q(j)} E_0[j] \quad , \quad (6.9)$$

where $Q(j)$ is the quadratic Casimir operator of an irreducible representation of $SU(3)$ which belongs to the class ψ_j and $E_0[j]$ is the value of the unknot in S^3 with preferred framing and with colour state ψ_j . Expression (6.9) has been obtained by taking into account the transformation property of the expectation values under a modification of the framing of the link components.

If we denote by λ_{\pm} the expectation value

$$\lambda_{\pm} = \langle \widetilde{W}(U; \pm 1) \rangle_{S^3} \quad , \quad (6.10)$$

equation (6.3) takes the form

$$\begin{aligned} \lambda_{\pm} \sum_j \xi(j) q^{\mp Q(j)} E_0[j] &= \\ &= \sum_j \sum_i \xi(j) \phi_{\pm}(i) \langle W(C; \psi_j) W(U; \psi_i) \rangle_{S^3} \quad , \end{aligned} \quad (6.11)$$

where $\langle W(C; \psi_j) W(U; \psi_i) \rangle_{S^3} = H_{ij}$ is the value of the Hopf link in S^3 with components U and C ; both components U and C of the Hopf link have preferred framings and are coloured by ψ_i and ψ_j respectively.

The coefficients $\{\phi_{\pm}(i)\}$ must be chosen in such a way that eq.(3.3) holds for any link L . This means that eq.(6.11) must hold for arbitrary coefficients $\{\xi(j)\}$. Therefore, for any j , $\{\phi_{\pm}(i)\}$ must satisfy

$$\sum_i \phi_{\pm}(i) H_{ij} = \lambda_{\pm} q^{\mp Q(j)} E_0[j] \quad . \quad (6.12)$$

The values $\{H_{ij}\}$ of the Hopf link are interpreted as the matrix elements of a symmetric matrix H called the Hopf matrix. By definition of the reduced tensor algebra, this matrix is non-singular and the linear system (6.12) determines the coefficients $\{\phi_{\pm}(i)\}$ uniquely up to a multiplicative constant. Before working out the general case, we shall illustrate how to solve eq.(6.12) in some simple cases.

6.2 Elementary surgery operators for low values of k

As examples, in this section we shall solve (6.12) for $G = SU(3)$ and $k = 1, 2$. When $k = 1$, the reduced tensor algebra is of order three (see Sect.4.2.4); the elements of the standard basis of $\mathcal{T}_{(1)}$ are denoted by $\{\Psi[0], \Psi, \Psi[-1]\}$ where $\Psi[0]$ is the unit element. In this case, eq.(6.12) takes the form

$$\begin{pmatrix} 1 & 1 & 1 \\ 1 & e^{\frac{2\pi i}{3}} & e^{\frac{-2\pi i}{3}} \\ 1 & e^{\frac{-2\pi i}{3}} & e^{\frac{2\pi i}{3}} \end{pmatrix} \begin{pmatrix} \phi_{\pm}(0) \\ \phi_{\pm}(1) \\ \phi_{\pm}(-1) \end{pmatrix} = \lambda_{\pm} \begin{pmatrix} 1 \\ e^{\pm 2\pi i/3} \\ e^{\pm 2\pi i/3} \end{pmatrix} \quad . \quad (6.13)$$

The solution of this system is

$$\begin{aligned} \phi_{\pm}(0) &= \pm \frac{i}{\sqrt{3}} \lambda_{\pm} \quad , \\ \phi_{\pm}(-1) &= \phi_{\pm}(1) = \pm \frac{i}{\sqrt{3}} \lambda_{\pm} e^{\mp i 2\pi/3} \quad . \end{aligned} \quad (6.14)$$

The solution of eq.(6.13) depends on the parameter λ_{\pm} linearly; the (non-vanishing) value of λ_{\pm} is free and the vacuum expectation values of the observables will not depend on it. For later convenience, we fix λ_{\pm} to be

$$\lambda_{\pm} = e^{\mp i\pi/2} \quad . \quad (6.15)$$

With this choice, the elementary surgery operators are

$$\widetilde{W}(U; \pm 1) = W(U; \Psi_{\pm}) \quad , \quad (6.16)$$

where U has preferred framing and

$$\Psi_{\pm} = \frac{1}{\sqrt{3}} \left(\Psi[0] + e^{\mp i 2\pi/3} \Psi[1] + e^{\mp i 2\pi/3} \Psi[-1] \right) \quad . \quad (6.17)$$

When $k = 2$, the reduced tensor algebra $\mathcal{T}_{(2)}$ is isomorphic (see Sect.4.2.3) with $\mathcal{T}_{(1)}$ and the Hopf matrix is the complex conjugate of the matrix shown in eq.(6.13). Consequently, one has

$$\begin{aligned} \lambda_{\pm} &= e^{\pm i\pi/2} \quad , \\ \Psi_{\pm} &= \frac{1}{\sqrt{3}} \left(\Psi[0] + e^{\pm i 2\pi/3} \Psi[1] + e^{\pm i 2\pi/3} \Psi[-1] \right) \quad . \end{aligned} \quad (6.18)$$

For $k = 3$, the reduced tensor algebra is of order one; the basis element $\Psi[0, 0]$ can be represented by the element $\chi[0, 0]$ of \mathcal{T} corresponding to the trivial representation of $SU(3)$. When $k = 3$, surgery is realized in a trivial way because the elementary surgery operators coincide with the identity.

When $k = 4$, the reduced tensor algebra $\mathcal{T}_{(4)}$ is of order three with basis elements

$$\psi_1 = \Psi[0,0] \quad , \quad \psi_2 = \Psi[1,0] \quad , \quad \psi_3 = \Psi[0,1] \quad , \quad (6.19)$$

where $\{\Psi[0,0], \Psi[1,0], \Psi[0,1]\}$ correspond (see Sect.4) to the three points of the fundamental domain Δ_4 .

Eq.(6.12) takes the form

$$\begin{pmatrix} 1 & \frac{1}{3} & \frac{1}{3} \\ 1 & e^{\frac{2\pi i}{3}} & e^{-\frac{2\pi i}{3}} \\ 1 & e^{-\frac{2\pi i}{3}} & e^{\frac{2\pi i}{3}} \end{pmatrix} \begin{pmatrix} \phi_{\pm}(1) \\ \phi_{\pm}(2) \\ \phi_{\pm}(3) \end{pmatrix} = \lambda_{\pm} \begin{pmatrix} 1 \\ e^{\pm 2\pi i/3} \\ e^{\pm 2\pi i/3} \end{pmatrix} . \quad (6.20)$$

The solution of eq.(6.20) is

$$\begin{aligned} \lambda_{\pm} &= e^{\mp i\pi/2} \quad , \\ \Psi_{\pm} &= \frac{1}{\sqrt{3}} \left(\psi_1 + e^{\mp i2\pi/3} \psi_2 + e^{\mp i2\pi/3} \psi_3 \right) . \end{aligned} \quad (6.21)$$

It is clear that, for every fixed value of k , the computation of the elementary surgery operators $\widetilde{W}(U; \pm 1)$ is straightforward. The main task of this chapter is to produce the general expression of $\widetilde{W}(U; \pm 1)$ for any value of k . This will be the subject of the next section.

6.3 General expression for elementary surgery operators

In this section we shall determine the general solution of system (6.12), which defines the elementary surgery operators, under the assumption that the reduced tensor algebra associated with the gauge group G is regular (see Sect.4.1).

In order to construct the elementary surgery operators, we need to prove the following Lemma.

Lemma 6.1

Let $\mathcal{F}(i, j)$ be a function on $\mathcal{T}_{(k)} \otimes \mathcal{T}_{(k)}$. Then, one has

$$\sum_i \sum_j N_{imj} \mathcal{F}(i, j) = \sum_j \sum_i N_{jmi} \mathcal{F}(i^*, j^*) . \quad (6.22)$$

Proof. Since $*$ is an automorphism of $\mathcal{T}_{(k)}$ and the index j is summed over the whole algebra, the left-hand-side of eq.(6.22) can be written as

$$\sum_i \sum_j N_{imj} \mathcal{F}(i, j) = \sum_i \sum_j N_{imj^*} \mathcal{F}(i, j^*) . \quad (6.23)$$

By using eq.(2.11), one gets

$$\sum_i \sum_j N_{imj} \mathcal{F}(i, j) = \sum_i \sum_j N_{jmi^*} \mathcal{F}(i, j^*) , \quad (6.24)$$

and, by using again the freedom to replace i with i^* in the sum, we have

$$\sum_i \sum_j N_{imj} \mathcal{F}(i, j) = \sum_j \sum_i N_{jmi} \mathcal{F}(i^*, j^*) , \quad (6.25)$$

which coincides with eq.(6.22). \square

Let us recall that the elementary surgery operators $\widetilde{W}(U; \pm 1)$ are written as

$$\widetilde{W}(U; \pm 1) = \sum_i \phi_{\pm}(i) W(U; \psi_i) \quad , \quad (6.26)$$

where a given orientation has been introduced for the unknot U with preferred framing. The coefficients $\{\phi_{\pm}(i)\}$ are fixed by the following theorem.

Theorem 6.1

When the reduced tensor algebra is regular, the elementary surgery operators are given by eq.(6.26) with

$$\phi_{\pm}(i) = a(k) q^{\pm Q(i)} E_0[i] \quad , \quad (6.27)$$

$$a(k) = \frac{1}{|Z_{(+)}|} \quad ; \quad Z_{(+)} = \sum_i q^{Q(i)} (E_0[i])^2 \quad . \quad (6.28)$$

Moreover, with the normalization choice (6.28), one has

$$\lambda_{\pm} = \langle \widetilde{W}(U; \pm 1) \rangle_{S^3} = e^{\pm i\theta_k} \quad . \quad (6.29)$$

Proof We need to verify that the coefficients shown in eq.(6.27) satisfy equation (6.12). The Hopf matrix H can be written (see Sect.2.3) as

$$H_{ij} = q^{-Q(i)-Q(j)} \sum_m N_{ijm} E_0[m] q^{Q(m)} \quad . \quad (6.30)$$

Therefore, if one inserts the values (6.27) for $\{\phi_{+}(i)\}$ in eq.(6.12), one finds

$$\lambda_{+} q^{-Q(j)} E_0[j] = a(k) \sum_i \sum_m N_{ijm} q^{-Q(j)} q^{Q(m)} E_0[m] E_0[i] \quad . \quad (6.31)$$

Since $E_0[i] = E_0[i^*]$ and $Q(i) = Q(i^*)$, by using Lemma 6.1 we have

$$\lambda_{+} E_0[j] = a(k) \sum_i \sum_m N_{mji} q^{Q(m)} E_0[m] E_0[i] \quad . \quad (6.32)$$

On the other hand, as we have seen in Sect.2.3, the values of the unknot, for fixed integer k , give a representation of $\mathcal{T}_{(k)}$ in \mathbb{R} . Consequently,

$$\sum_i N_{mji} E_0[i] = E_0[m] E_0[j] \quad . \quad (6.33)$$

Thus, equation (6.32) takes the form

$$\lambda_{+} = a(k) \sum_i q^{Q(i)} E_0^2[i] \quad . \quad (6.34)$$

We are free to set $\lambda_{+} = e^{i\theta_k}$ and $a(k)$ real. Actually the numerical values of $\phi_{\pm}(i)$ and $a(k)$ depend on the choice of the gauge group. Therefore, eqs.(6.28) and (6.29) are in agreement with eq.(6.34). Clearly, the coefficients $\{\phi_{-}(i)\}$ and λ_{-} can be obtained by taking the complex conjugate of $\{\phi_{+}(i)\}$ and λ_{+} . \square

Since the Hopf matrix is invertible by definition of the reduced tensor algebra, the coefficients $\{\phi_{\pm}(i)\}$ are uniquely determined by eq.(6.12) up to an overall numerical factor. In this sense, the solution (6.27) is unique. Our normalization choice (6.28) will simplify our subsequent discussion on Kirby moves but has no influence at all on the expectation values of the observables.

As we have mentioned in Sect.5.3, surgery links \mathcal{L} are not oriented. On the other hand, in the definition (6.26) of the elementary surgery operators $\widetilde{W}(U; \pm 1)$ we have introduced an orientation for the unknot U . Since $\widetilde{W}(U; \pm 1)$ represent the elementary surgery operations S_{\pm} , the particular choice of this orientation must be irrelevant; let us now verify that this is really the case. Let us recall that, in general, if the oriented not C has colour ψ_i , a modification of the orientation of C is equivalent to replace ψ_i with ψ_{i^*} (see Sect.2.1). Now, the coefficients $\{\phi_{\pm}(i)\}$ given in eq.(6.27) verify the equality $\phi_{\pm}(i) = \phi_{\pm}(i^*)$. Consequently, if we modify the orientation of the unknot U in eq.(6.26), the associated operators $\widetilde{W}(U; \pm 1)$ are not modified. Thus, the particular choice of the orientation of U in eq.(6.26) is totally irrelevant; as it should be.

6.4 Surgery rules

In this section, we shall give the surgery rules in the quantum CS field theories with gauge groups $G = SU(2)$ and $G = SU(3)$. We shall also discuss the invariance under Kirby moves of the results obtained according to these rules.

As we have shown in Chap.4, for fixed integer k the physically inequivalent colour states associated with a knot are described by the elements of the reduced tensor algebra $\mathcal{T}_{(k)}$. In Chap.4 we have also given, for each integer k , the correspondence rules between the elements of \mathcal{T} and the elements of $\mathcal{T}_{(k)}$. Therefore, for fixed integer k , we only need to consider the complete set of observables consisting of Wilson line operators associated with framed oriented links whose components have colour states given by elements of $\mathcal{T}_{(k)}$.

Let us briefly summarize the results of Sects.6.2 and 6.4. The elementary surgery operators $\widetilde{W}(U; \pm 1)$ are given by

$$\widetilde{W}(U; \pm 1) = W(U; \Psi_{\pm}) \quad , \quad (6.35)$$

where the unknot U has preferred framing and

$$\Psi_{\pm} = a(k) \sum_i q^{\pm Q(i)} E_0[i] \psi_i \quad . \quad (6.36)$$

In eq.(6.36), the sum runs over all the elements of $\mathcal{T}_{(k)}$. The calculation of the explicit values of $a(k)$ and of $\lambda_{\pm} = e^{i\phi}$ is presented in App.C. When the gauge group G is $SU(2)$, a_k is given by [31]

$$a(k) = \begin{cases} 1/\sqrt{2} & k = 1 \\ \sqrt{\frac{2}{k}} \sin(\pi/k) & k \geq 2 \end{cases} ; \quad (6.37)$$

$$e^{i\theta_k} = \begin{cases} \exp(-i\pi/4) & k = 1 \\ \exp[i\pi 3(k-2)/(4k)] & k \geq 2 \end{cases} ; \quad (6.38)$$

whereas, when $G = SU(3)$, one has [33, 36]

$$a(k) = \begin{cases} 1/\sqrt{3} & k = 1, 2 \\ 16 \cos(\pi/k) \sin^3(\pi/k)/(k\sqrt{3}) & k \geq 3 \end{cases} . \quad (6.39)$$

$$e^{i\theta_k} = \begin{cases} \exp(i\pi/2) & k = 1 \\ \exp(-i\pi/2) & k = 2 \\ \exp(-i6\pi/k) & k \geq 3 \end{cases} . \quad (6.40)$$

Eq.(6.12) can be interpreted in the following way. The action of $\widetilde{W}(U; \pm 1)$ on the element ψ_j of the reduced tensor algebra $\mathcal{T}_{(k)}$, associated with the core of the complement solid torus of U in S^3 , is

$$\widetilde{W}(U; \pm 1) : \psi_j \rightarrow e^{\mp i\varphi} q^{\mp Q(j)} \psi_j \quad , \quad (6.41)$$

Eq.(6.41) shows that, apart from the overall phase factor $e^{\pm i\varphi}$, $\widetilde{W}(U; \pm 1)$ are the generators of twist homeomorphisms τ_{\mp} of the complement solid torus of U in S^3 . Since these phase factors are constants (i.e., do not depend on the particular colour state under consideration), their presence in eq.(6.41) is completely harmless. In fact, by introducing the correct vacuum normalization in the expectation values, as shown in eq.(6.3), these phase factors cancel out.

By means of eqs.(6.35)-(6.41), we can now compute explicitly the expectation values of Wilson line operators for the CS theory defined in any orientable, closed and connected three-manifold \mathcal{M} when the gauge group is $SU(2)$ or $SU(3)$. We shall firstly consider the surgery rules in the case in which the surgery instructions have the form specified by the Fundamental Theorem. Then, we shall give the surgery rules corresponding to a generic ‘‘honest’’ surgery.

According to Lickorish’s Theorem, \mathcal{M} has a presentation in terms of Dehn’s surgery in S^3 . Moreover, it is always possible to find a surgery description of \mathcal{M} corresponding to a surgery link \mathcal{L} in which all its components $\{\mathcal{L}_a\}$ (with $1 \leq a \leq p$) are simple circles and have surgery coefficients $\{r_a\}$ equal to $+1$ or -1 .

Since we know how to represent in the field theory the elementary surgery S_{\pm} , associated with each single component of \mathcal{L} , we can construct the operator $\widetilde{W}(\mathcal{L})$ representing the whole surgery. Indeed, for each component \mathcal{L}_a , we shall introduce a preferred framing \mathcal{L}_{af} and consider the operator $\widetilde{W}(\mathcal{L}_a; r_a)$, as defined in eq.(6.35). The field theory operator $\widetilde{W}(\mathcal{L})$, associated with the whole surgery \mathcal{L} , is [37]

$$\widetilde{W}(\mathcal{L}) = \prod_{a=1}^p \widetilde{W}(\mathcal{L}_a; r_a) \quad . \quad (6.42)$$

Let L be a given framed link in \mathcal{M} . As we have already mentioned, the isotopy class of $L \subset \mathcal{M}$ can be described by a link (that we indicate by the same symbol L) in the complement of \mathcal{L} in S^3 .

Following the approach of Sect.6.2, the expectation value $\langle W(L) \rangle|_{\mathcal{M}}$ is defined to be [37]

$$E(L)_{\mathcal{M}} = \langle W(L) \rangle|_{\mathcal{M}} = \frac{\langle W(L) \widetilde{W}(\mathcal{L}) \rangle|_{S^3}}{\langle \widetilde{W}(\mathcal{L}) \rangle|_{S^3}} \quad . \quad (6.43)$$

By means of the surgery rules (6.42) and (6.43), one can compute the expectation values $\{\langle W(L) \rangle|_{\mathcal{M}}\}$ in any orientable, closed connected three-manifold \mathcal{M} . The origin of the expectation value of the surgery operator in the denominator of (6.43) is two fold. Firstly, it provides a natural extension of the link invariant $E(L)_{S^3}$ in \mathcal{M} . From (6.43), it follows that when the link L can be embedded in a three ball $B^3 \subset \mathcal{M}$ then

$$L \subset B^3 \subset \mathcal{M} \Rightarrow E(L)_{\mathcal{M}} = E(L)_{S^3} \quad . \quad (6.44)$$

Indeed, the situation $L \subset B^3 \subset \mathcal{M}$ corresponds to the following factorization of the surgery operator

$$\langle W(L) \widetilde{W}(\mathcal{L}) \rangle|_{S^3} = \langle W(L) \rangle \langle \widetilde{W}(\mathcal{L}) \rangle|_{S^3} \quad . \quad (6.45)$$

Secondly, the presence of $\langle \widetilde{W}(\mathcal{L}) \rangle$ in the denominator, can be understood as the effect of the modification of the vacuum to vacuum Feynman diagrams with respect of S^3 .

In order to discuss the invariance under Kirby moves, it is convenient to give the surgery rules which correspond to ‘‘honest’’ surgeries in general.

Any “honest” surgery is described by a surgery link \mathcal{L} whose components $\{\mathcal{L}_a\}$ have integer surgery coefficients $\{r_a\}$. In this case, each single component \mathcal{L}_a is not necessarily ambient isotopic with a simple circle, of course. For each component \mathcal{L}_a , we shall introduce a framing \mathcal{L}_{af} such that the linking number of \mathcal{L}_a and \mathcal{L}_{af} satisfies

$$\text{lk}(\mathcal{L}_a, \mathcal{L}_{af}) = r_a \quad . \quad (6.46)$$

Then we shall consider the Wilson line operator

$$W(\mathcal{L}_a; \Psi_0) \quad , \quad (6.47)$$

which is associated with the framed component \mathcal{L}_a with framing \mathcal{L}_{af} specified in eq.(6.46). The element Ψ_0 (surgery colour state) is given by

$$\Psi_0 = a(k) \sum_i E_0[i] \psi_i \quad . \quad (6.48)$$

It should be noted that the framing choice (6.46) is different from the preferred framing convention which is used in the definition (6.35). Under a Kirby move, the integer surgery coefficient r_a , associated with a link component \mathcal{L}_a , transforms as the linking number $\text{lk}(\mathcal{L}_a, \mathcal{L}_{af})$. For this reason, the framing choice (6.46) has an intrinsic meaning. The information carried by the integer surgery coefficient r_a is now encoded in the framing of the component \mathcal{L}_a and, consequently, the colour state Ψ_0 of any surgery component is universal.

Theorem 6.2

The surgery operator, corresponding to the “honest” surgery described by $\mathcal{L} = \{\mathcal{L}_a\}$ with integer surgery coefficients $\{r_a\}$ (with $1 \leq a \leq p$), is

$$\widetilde{W}(\mathcal{L}) = \prod_{a=1}^p W(\mathcal{L}_a; \Psi_0) \quad , \quad (6.49)$$

where Ψ_0 is displayed in eq.(6.48). The expectation value $\langle W(L) \rangle_{\mathcal{M}}$ is given by

$$\langle W(L) \rangle_{\mathcal{M}} = \frac{\langle W(L) \widetilde{W}(\mathcal{L}) \rangle_{S^3}}{\langle \widetilde{W}(\mathcal{L}) \rangle_{S^3}} \quad . \quad (6.50)$$

The results obtained according to eq.(6.50) are invariant under Kirby moves.

Proof. By using the covariance properties of the expectation values of the Wilson line operators under a change of framing (see Sect 2.), it is easy to verify that, when all the components $\{\mathcal{L}_a\}$ are simple circles and the surgery coefficients $\{r_a\}$ are equal to +1 or -1, eq.(6.50) coincides with eq.(6.43). In order to prove the consistency of eq.(6.50), we need to demonstrate that the results obtained according to eq.(6.50) are invariant under Kirby moves.

Let \mathcal{L} be the instruction corresponding to a given “honest” surgery. Suppose that one component, say \mathcal{L}_1 , of \mathcal{L} is a simple circle with surgery coefficient $r_1 = \pm 1$. All the remaining components of \mathcal{L} and the given link L belong to the complement solid torus \mathcal{V}_1 of \mathcal{L}_1 in S^3 . As we have stated above, $W(\mathcal{L}_1; \Psi_0)$ is equivalent to $\widetilde{W}(\mathcal{L}_1; \pm 1)$. Consider now the numerator and, separately, the denominator of the expression (6.50). From eq.(6.41) it follows that \mathcal{L}_1 can be eliminated provided that we perform a twist homeomorphism τ_{\mp} of \mathcal{V}_1 and, simultaneously, we multiply by the phase factor $e^{\mp i\varphi}$. This phase factor cancels out in the ratio (6.50); therefore, only the effects of the twist homeomorphism τ_{\mp} are relevant. Under this twist, L is accordingly modified into its homeomorphic image, as it should be. The same happens with the remaining components of \mathcal{L} . It remains to

be verified that the new surgery coefficients $\{r'_b\}$ (with $b \neq 1$) have the correct values displayed in eq.(2.5); as a consequence of the transformation properties of framings under twist homeomorphisms (see Sect 5.4), this is indeed the case.

In conclusion, the results obtained by means of the surgery rules (6.49) and (6.50) are invariant under Kirby moves. On the other hand, with an appropriate sequence of Kirby moves, any “honest” surgery instruction can be transformed into an equivalent surgery instruction of the type specified by the Fundamental Theorem. In this case, expressions (6.50) and (6.43) coincide and this concludes the proof. \square

With our definition of the elements Ψ_{\pm} shown in eq.(6.2), Ψ_- can be obtained from Ψ_+ by means of two elementary changes of framing. This is the main reason for our choice on their normalization.

From the previous discussion on the Kirby moves, it is clear that the presence of the phase factors $e^{\pm i\varphi}$ cannot be avoided. To be more precise, whatever the normalization of Ψ_{\pm} is, the numerator (and, separately, the denominator) of the expression (6.50) is not invariant under Kirby moves. (The ratio (6.50) is invariant under Kirby moves, of course). In other words, a projective representation of the group of twist homeomorphisms of solid tori is realized on the state space of the CS theory.

When $\langle \widetilde{W}(\mathcal{L}) \rangle_{S^3} \neq 0$ the expression (6.12) is well defined. The expectation value $\langle \widetilde{W}(\mathcal{L}) \rangle_{S^3}$ gives information on the three-manifold \mathcal{M} , associated with the surgery link \mathcal{L} in S^3 , and depends on the value of the coupling constant k . For fixed \mathcal{M} , $\langle \widetilde{W}(\mathcal{L}) \rangle_{S^3}$ may vanish when k takes values on a certain set of integers; in this cases, eq.(6.12) is not well defined. Let us recall that, in general, the internal consistency of the quantum CS theory defined in \mathcal{M} puts some restrictions [37] on the possible values of k . It is natural to expect that $\langle \widetilde{W}(\mathcal{L}) \rangle_{S^3}$ vanishes for precisely those values of k for which the quantum CS theory is not well defined in \mathcal{M} .

6.5 General properties

In this section we shall focus our attention on some general aspects of the construction of the elementary surgery operators presented in the previous sections. Moreover, we shall give another derivation of the solution (6.27), (6.28) of (6.12).

Even if the numerical results are different for different gauge groups, the underlying algebraic structure is universal. It is remarkable that this universal structure is not a peculiarity of topological quantum field theory but appears also in all the different approaches [44, 12, 48, 42, 43] to the newly discovered three-manifold invariants. Thus, before considering explicit applications of the surgery rules in the $SU(3)$ CS field theory, we would like to present here some general results concerning the construction of Dehn’s surgery operators.

Let us consider the CS field theory with compact simple Lie group G . For generic values of the coupling constant k , the expectation values of the Wilson line operators are finite Laurent polynomials in a certain power of the deformation parameter $q = \exp(-i2\pi/k)$. By construction, for any fixed link with n components, these expectation values are multi-linear functions on $\mathcal{T}^{\otimes n}$, where \mathcal{T} is the tensor algebra (or complexification of the representation ring) of G . As we have learned in Chapt.4, for fixed integer k , a complete set of gauge invariant observables is represented by the set of Wilson line operators associated with framed oriented links whose components have colour states given by elements of $\mathcal{T}_{(k)}$. In the considered examples where G is a unitary group, $\mathcal{T}_{(k)}$ turns out to be of finite order. It is natural to expect that $\mathcal{T}_{(k)}$ is of finite order also for a generic (simple compact Lie) group G . In what follows, we simply assume that this is indeed the case.

For generic values of k , the generalized satellite relations 2.32 are written in terms of the elements of \mathcal{T} . For fixed integer k , these relations can be expressed in terms of the elements $\{\psi_i\}$ of the standard basis of $\mathcal{T}_{(k)}$. For example, consider the knots C_1 and C_2 in the solid torus V which coincides with the complement of the unknot U in S^3 , as shown in Fig.6.1. Let these knots have

preferred framings and colours ψ_i and ψ_j belonging to $\mathcal{T}_{(k)}$. The product $W(C_1; \psi_i) W(C_2; \psi_j)$ of the associated Wilson line operators admits the decomposition

$$W(C_1; \psi_i) W(C_2; \psi_j) = \sum_m N_{ijm} W(C_1; \psi_m) \quad , \quad (6.51)$$

where $\{N_{ijm}\}$ are the structure constants of $\mathcal{T}_{(k)}$.

At this point, one should construct the surgery operators $\widetilde{W}(U; \pm 1)$ which are determined by eqs.(6.6) and (6.12). Clearly, the Hopf matrix H entering eq.(6.12) depends on G ; nevertheless, we shall show that the solution of eq.(6.12), namely the form of $\widetilde{W}(U; \pm 1)$, does not depend on G . The proof is based exclusively on the topological properties of surgery; in particular, we will not use the structure of the Hopf matrix.

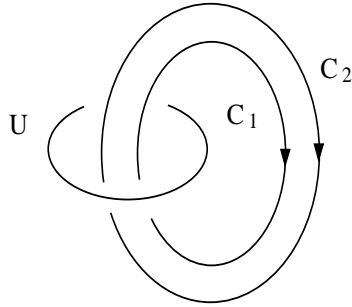

Figure 6.1

Let us consider the set of “honest” surgeries. Each surgery of this kind can be described by a framed unoriented link $\mathcal{L} = \{\mathcal{L}_a\}$ in S^3 ; we use the standard convention in which each surgery coefficient r_a is given by the linking number of the component \mathcal{L}_a and its framing \mathcal{L}_{af} , eq.(6.46). As we have already mentioned, with the choice (6.46) of framing, the surgery operators are characterized by a universal colour state Ψ_0 , see eq.(6.47). The statement that the form of $\widetilde{W}(U; \pm 1)$ does not depend on G is equivalent to the statement that Ψ_0 has the structure given in eq.(6.48).

Theorem 6.3

Let us assume that the reduced tensor algebra $\mathcal{T}_{(k)}$ in the Chern-Simons theory with compact simple Lie gauge group G is regular (see Chapt.4). The surgery operator $\widetilde{W}(\mathcal{L})$, which is associated with the surgery link $\mathcal{L} = \{\mathcal{L}_a\}$ with integer surgery coefficients $\{r_a\}$ and framings specified by eq.(6.46), is given by eq.(6.49) with

$$\Psi_0 = a(k) \sum_i E_0[i] \psi_i \quad , \quad (6.52)$$

where $a(k)$ is a non-vanishing normalization factor.

Proof First of all we note that, in the computation of the expectation values (6.50), the particular value of the normalization factor $a(k)$ is irrelevant. (The natural choice for the value of $a(k)$ will be described in a while.)

Since the element $\Psi_0 \in \mathcal{T}_{(k)}$ does not depend on the particular form of the surgery link $\mathcal{L} \in S^3$, Ψ_0 must be determined by general topological properties of surgery. In order to describe these

properties, we need to disentangle the action of a generic surgery operation, which is defined inside a solid torus V , from the particular embeddings of this solid torus in S^3 . To be more precise, let us represent the solid torus V by the complement of the unknot U in S^3 ; we shall denote by K the framed core of V with preferred framing. Suppose that K represents the surgery instruction corresponding to the “honest” Dehn’s surgery with surgery coefficient $r = 0$. Then, each framed component \mathcal{L}_a of a surgery link \mathcal{L} in S^3 can be understood to be the image $h^\diamond(K)$ of K under the homeomorphism h^\diamond which has been defined in Sect.2.2.

Since the element Ψ_0 does not depend on h^\diamond , in order to find Ψ_0 we only need to consider the surgery operation described by K in V . By definition, this surgery consists of removing a tubular neighbourhood N of K in V and sewing it back in such a way that a meridian of N is mapped into the curve Y which is shown in Fig.6.2.

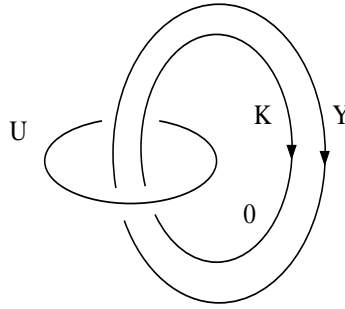

Figure 6.2

Since a meridian of N bounds a disc (standardly embedded in a three-ball), the knot Y shown in Fig.6.2 is really ambient isotopic with the unknot (simple circle) contained inside a three-ball. Clearly, if the knot Y is framed, then Y is ambient isotopic with the unknot with preferred framing. This is the desired property which characterizes completely the surgery operation described by K in V .

Now we would like to represent this surgery by a Wilson line operator $W(K; \Psi_0)$ which is defined for K with preferred framing. As we have already mentioned, a given orientation for K is also introduced, but the final results will not depend on the choice of this orientation. Suppose that a Wilson line operator $W(Y; \psi_j)$ is associated with the knot Y which is oriented and has preferred framing. Since Y is ambient isotopic with the unknot (contained inside a three-ball) with preferred framing, the Wilson line operator $W(Y; \psi_j)$ simply gives the contribution $E_0[j]$. Therefore, the element Ψ_0 must be determined in such a way that, inside the solid torus V , the insertion of $W(Y; \psi_j)$ (with arbitrary ψ_j) is equivalent to the multiplication by $E_0[j]$. We shall now verify that the element Ψ_0 , given in eq.(6.52), has precisely this property.

Let us consider the product $W(K; \Psi_0) W(Y; \psi_j)$ of the two Wilson line operators associated with K and Y inside the solid torus V . By using the decomposition (6.51), one finds

$$W(K; \Psi_0) W(Y; \psi_j) = a(k) \sum_i E_0[i] \sum_m N_{ijm} W(K; \psi_m) \quad , \quad (6.53)$$

and, by means of Lemma 6.1, one obtains

$$W(K; \Psi_0) W(Y; \psi_j) = a(k) \sum_i E_0[i^*] \sum_m N_{mji} W(K; \psi_{m^*}) \quad . \quad (6.54)$$

Since the values of the unknot give a representation of $\mathcal{T}_{(k)}$, the relation (6.33) is valid; moreover, $E_0[i^*] = E_0[i]$. Therefore, eq.(6.54) takes the form

$$\begin{aligned} W(K; \Psi_0) W(Y; \psi_j) &= E_0[j] a(k) \sum_m E_0[m] W(K; \psi_m) \\ &= E_0[j] W(K; \Psi_0) \quad . \end{aligned} \tag{6.55}$$

This equation holds for any $\psi_j \in \mathcal{T}_{(k)}$. Therefore, eq.(6.55) shows that the operator $W(K; \Psi_0)$, with Ψ_0 given in eq.(6.52), represents the surgery operation which is described by the surgery knot K with surgery coefficient $r = 0$.

In order to prove the invariance under Kirby moves, one has to consider the elementary surgery operators $\widetilde{W}(U; \pm 1)$. The operators $\widetilde{W}(U; \pm 1)$ can be obtained from $W(K; \Psi_0)$ by using the satellite relations. Let us consider a satellite of the unknot, with writhe $+1$ in S^3 , which has been obtained by means of the pattern link defined by the two knots K and Y in V . This satellite is shown in Fig.6.3.

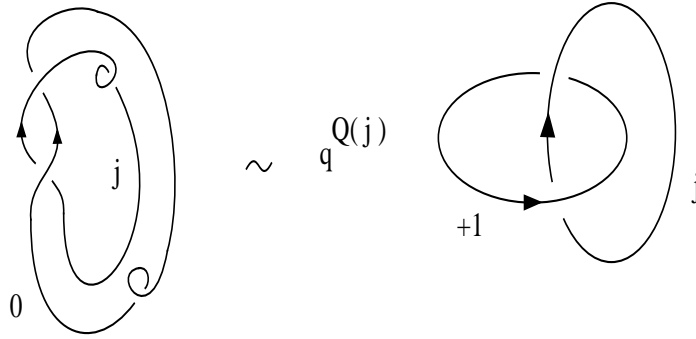

Figure 6.3

According to eq.(6.55), the expectation value of the Wilson line operators associated with the link of Fig.6.3 is equal to $E_0[j] \langle W(U; \Psi_+) \rangle_{|S^3}$. Therefore, by taking into account the behaviour of the expectation values under a change of framing, one obtains

$$a(k) \sum_i q^{Q(i)} E_0[i] H_{ij} = q^{-Q(j)} E_0[j] \left(a(k) \sum_i q^{Q(i)} E_0^2[i] \right) \quad . \tag{6.56}$$

This equation coincides with eq.(6.12) with

$$\phi_+(i) = a(k) q^{Q(i)} E_0[i] \quad , \tag{6.57}$$

$$\lambda_+ = a(k) \sum_i q^{Q(i)} E_0^2[i] \quad . \tag{6.58}$$

Clearly, ϕ_- and λ_- can be obtained from ϕ_+ and λ_+ by taking the complex conjugates. By assumption, $\lambda_+ \neq 0$ and consequently $\lambda_- \neq 0$. Therefore, the invariance under Kirby moves can be proved by using the same argument as presented in Sect.6.2. The natural choice of the normalization

factor $a(k)$ is to require that $a(k) > 0$ and $|\lambda_{\pm}| = 1$. This is the convention that we have adopted in the previous sections. \square

By definition of the reduced tensor algebra, $\mathcal{T}_{(k)}$ is physically irreducible ; this means that if $\psi \in \mathcal{T}_{(k)}$ is physically equivalent to the null vector, then $\psi = 0$. It should be noted that, in the proof of Theorem 6.3, this property of $\mathcal{T}_{(k)}$ has not been used. Theorem 6.3 provides an explicit solution to the problem of the surgery colour state Ψ_0 ; the uniqueness of this solution follows from Theorem 6.4.

Theorem 6.4

Up to a normalization factor, the surgery colour state Ψ_0 is unique.

Proof Suppose that we have found two surgery colour states Ψ_0 and Ψ'_0 in $\mathcal{T}_{(k)}$. Let Ψ_+ and Ψ'_+ be the corresponding colour states associated with the elementary surgery S_+ . Let us fix the normalization of Ψ_+ and Ψ'_+ (and, consequently, of Ψ_0 and Ψ'_0) by imposing that eq.(6.12) takes the form

$$(H \cdot \Psi_+)_i = q^{-Q(i)} E_0[i] = (H \cdot \Psi'_+)_i \quad . \quad (6.59)$$

With this normalization, the colour state $\Psi = \Psi_+ - \Psi'_+$ satisfies

$$H \cdot \Psi = 0 \quad . \quad (6.60)$$

Eq.(6.60) implies that, for any link $L \subset S^3$ in which one of its components C has colour Ψ , one has $\langle W(L) \rangle|_{S^3} = 0$. Indeed, by using the surgery operators, one can find a surgery presentation [23] of $L \subset S^3$ in which C is the unknot with colour Ψ . Of course, the remaining components of L and the surgery link belong to the complement solid torus of C in S^3 . Therefore, by using the generalized satellite relations (see Sect.2.2), $\langle W(L) \rangle|_{S^3}$ can be expressed in terms of the values of the Hopf link in which one of its components has colour Ψ . Consequently, eq.(6.60) implies that $\langle W(L) \rangle|_{S^3} = 0$.

On the other hand, since $\mathcal{T}_{(k)}$ is physically irreducible, one has $\Psi = 0$ and thus $\Psi_+ = \Psi'_+$; this implies that $\Psi_0 = \Psi'_0$. \square

The existence of an operator which represents surgery (Theorems 6.1-2) implies that the Hopf matrix H_{ij} is nonsingular. Indeed, suppose that eq.(6.60) is satisfied with a certain colour state Ψ . By using the method described in the proof of Theorem 6.3, one can conclude that either $\mathcal{T}_{(k)}$ is physically reducible or $\Psi = 0$. Since the reduced tensor algebra $\mathcal{T}_{(k)}$ is (by definition) physically irreducible, one must have $\Psi = 0$; this means that H is nonsingular.

6.6 Examples

In this section we shall describe some concrete examples of computation of observables in manifolds different from S^3 . All the examples are worked out by using $G = SU(3)$ as the gauge group.

6.6.1 The manifold $S^2 \times S^1$

The manifold $S^2 \times S^1$ admits [23] a surgery presentation in which the surgery link is the unknot U with surgery coefficient $r = 0$. The manifold $S^2 \times S^1$ can also be represented by the region of \mathbb{R}^3 delimited by two spherical surfaces which are centered at the origin and have different radii; the points which have the same angular coordinates on the two spheres are identified.

The simplest knot C which is homotopically nontrivial in $S^2 \times S^1$ is shown in Fig.6.4. The link in S^3 shown in Fig.6.4a has two components; one component represents the surgery instruction

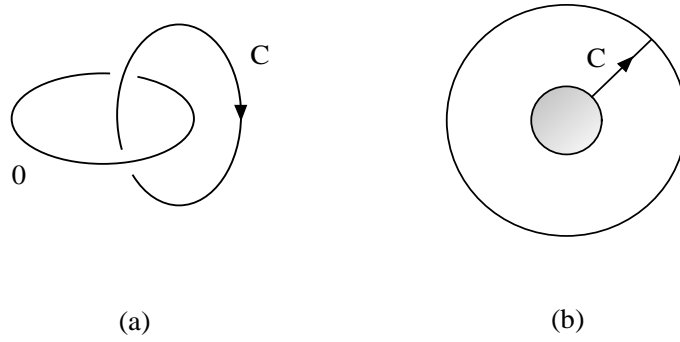

Figure 6.4

corresponding to the Dehn's surgery on S^3 which gives $S^2 \times S^1$. The remaining component, which has preferred framing, describes the knot C . Fig.6.4b gives an equivalent description of C in $S^2 \times S^1$.

Let C have colour ψ_i , the expectation value of the associated Wilson line operator in $S^2 \times S^1$ is given by Theorem 6.2,

$$\langle W(C; \psi_i) \rangle_{S^2 \times S^1} = \frac{\langle W(C; \psi_i) \widetilde{W}(U; \Psi_0) \rangle_{S^3}}{\langle \widetilde{W}(U; \Psi_0) \rangle_{S^3}} . \quad (6.61)$$

On the one hand, one has

$$\langle W(C; \psi_i) \widetilde{W}(U; \Psi_0) \rangle_{S^3} = a(k) \sum_j E_0[j] H_{ji} . \quad (6.62)$$

On the other hand, one gets

$$\langle \widetilde{W}(U; \Psi_0) \rangle_{S^3} = a(k) \sum_j E_0^2[j] . \quad (6.63)$$

As shown in Appendix C, one finds

$$\sum_j E_0^2[j] = \frac{3k^2}{256 \sin^6(\pi/k) \cos^2(\pi/k)} , \quad (6.64)$$

$$\sum_j E_0[j] H_{ji} = \delta_{1i} \left[\frac{3k^2}{256 \sin^6(\pi/k) \cos^2(\pi/k)} \right] , \quad (6.65)$$

where ψ_1 denotes the unit element in $\mathcal{T}_{(k)}$; let us recall that the unit element of $\mathcal{T}_{(k)}$ was indicated by $\Psi[0]$ for $k = 1$ and $k = 2$, and by $\Psi[0, 0]$ for $k \geq 3$. From eqs.(6.64) and (6.65) it follows that

$$\langle W(C; \psi_i) \rangle_{S^2 \times S^1} = \delta_{1i} . \quad (6.66)$$

In the next section we shall show that the result in (6.66) is not peculiar to $SU(3)$ but it holds in general when the reduced tensor algebra is regular. Let us now consider the two components link shown in Fig.6.5; the two components C_1 and C_2 shown in Fig.6.5a have preferred framings

and colours ψ_i and ψ_j respectively. An equivalent description of C_1 and C_2 in $S^2 \times S^1$ is given in Fig.6.5b. By using the satellite formulae (2.32), from eq.(6.66) one obtains

$$\langle W(C_1, C_2; \psi_i, \psi_j) \rangle|_{S^2 \times S^1} = N_{ij1} = \delta_{ij^*} \quad . \quad (6.67)$$

The three components of the link shown in Fig.6.6 have preferred framings and colours ψ_i, ψ_j and ψ_m ; by using the satellite relations one finds

$$\langle W(C_1, C_2, C_3; \psi_i, \psi_j, \psi_m) \rangle|_{S^2 \times S^1} = \sum_n N_{ijn} \delta_{nm^*} = N_{ijm^*} \quad . \quad (6.68)$$

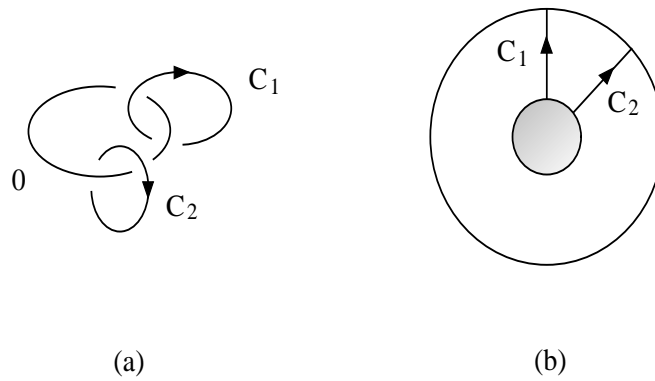

Figure 6.5

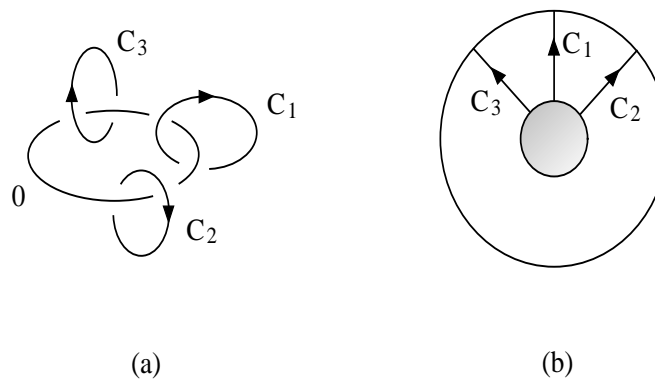

Figure 6.6

The expectation value of the three components link shown in Fig.6.6 provides a direct representation of the structure constants $\{N_{ijm^*}\}$ of the reduced tensor algebra $\mathcal{T}_{(k)}$ of $SU(3)$. Eq.(6.68)

shows that N_{ijm^*} is symmetric under a generic permutation of the indices; this is in agreement with eq.(4.24).

In order to verify the ambient isotopy invariance of the expectation values in $S^2 \times S^1$, let us consider for example the link shown in Fig.6.7a; the components C and K have preferred framing and colours ψ_i and ψ_j respectively. On the one hand, according to the surgery rule (6.50), one obtains

$$\langle W(C; \psi_i) W(K; \psi_j) \rangle |_{S^2 \times S^1} = E_0[j] \delta_{i1} \quad . \quad (6.69)$$

On the other hand, by means of an isotopy in $S^2 \times S^1$ (see Fig.6.7b) one can move the knot K inside a three-ball. Consequently, $W(K; \psi_j)$ gives the contribution $E_0[j]$; thus

$$\begin{aligned} \langle W(C; \psi_i) W(K; \psi_j) \rangle |_{S^2 \times S^1} &= E_0[j] \langle W(C; \psi_i) \rangle |_{S^2 \times S^1} \\ &= E_0[j] \delta_{i1} \quad , \end{aligned} \quad (6.70)$$

in agreement with eq.(6.69).

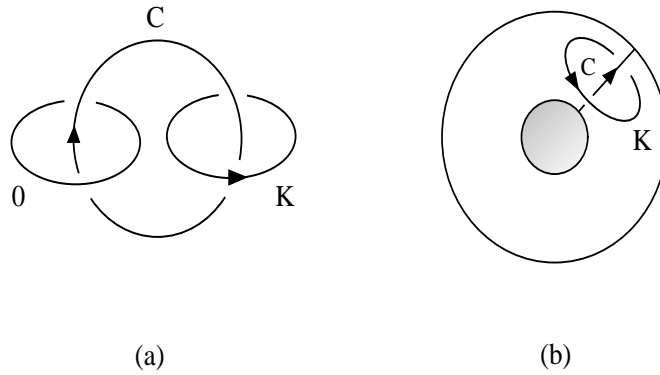

Figure 6.7

The two components C_1 and C_2 of the link shown in Fig.6.8 have preferred framings and colours ψ_i and ψ_j respectively. By using the surgery rules, one can compute the expectation value of the associated Wilson line operators; one gets

$$\langle W(C_1; \psi_i) W(C_2; \psi_j) \rangle |_{S^2 \times S^1} = q^{-2Q(j)} \delta_{ij^*} \quad . \quad (6.71)$$

The result (6.71) can also be derived by using of the invariance under Kirby moves. Indeed, the sequence of Kirby moves shown in Fig.6.9 and eq.(6.67) imply

$$\langle W(C_1; \psi_i) W(C_2; \psi_j) \rangle |_{S^2 \times S^1} = q^{-Q(i)-Q(j)} \delta_{ij^*} \quad . \quad (6.72)$$

The vacuum expectation values of the Wilson line operators in $S^2 \times S^1$ can be obtained by means of a simple general rule. Let us consider the surgery presentation of $S^2 \times S^1$ given by the unknot U in S^3 with surgery coefficient $r = 0$. A generic link in $S^2 \times S^1$ can be represented by a link L in the complement solid torus N of U in S^3 . Within the solid torus N , the associated Wilson line operator $W(L)$ admits the decomposition

$$W(L) = \sum_i \xi_L(i) W(C; \psi_i) \quad , \quad (6.73)$$

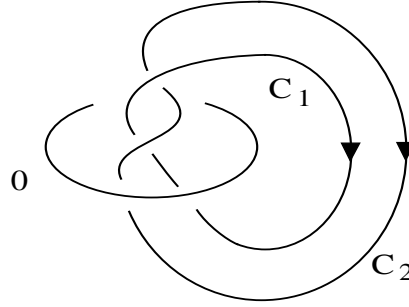

Figure 6.8

where C is the oriented and framed core of N shown in Fig.6.4a. Now, by using eq.(6.66), one finds

$$\langle W(L) \rangle|_{S^2 \times S^1} = \xi_L(1) \quad . \quad (6.74)$$

Since, for any link L , the ξ -coefficients can be determined uniquely (for example, by means of the Hopf matrix), eq.(6.74) gives a compact description of $\langle W(L) \rangle|_{S^2 \times S^1}$.

6.6.2 Lens spaces and Poincaré manifold

The lens space $L(p, 1)$ admits [23] a surgery presentation described by the unknot U with surgery coefficient $r = p$. In order to illustrate the use of the surgery rules, let us consider the case in which $k = 1$. The simplest nontrivial knot C in $L(p, 1)$ is shown in Fig.6.10; let C have preferred framing and colour ψ_i . Let us recall that $\mathcal{T}_{(1)}$ is of order three and the corresponding Hopf matrix is given in eq.(4.85). From the definition of surgery operator, one has

$$\langle W(C; ; \psi_i) \rangle|_{L(p,1)} = \frac{\sum_j q^{pQ(j)} E_0[j] H_{ji}}{\sum_j q^{pQ(j)} E_0^2[j]} \quad . \quad (6.75)$$

$$\langle W(C; ; \psi_i) \rangle|_{L(p,1)} = \begin{cases} 1 & \text{if } \psi_i = \Psi[0] ; \\ (1 - e^{-i2\pi p/3}) (1 + 2e^{-i2\pi p/3})^{-1} & \text{if } \psi_i = \Psi[\pm 1]. \end{cases} \quad (6.76)$$

When $k = 2$, $\langle W(C; ; \psi_i) \rangle|_{L(p,1)}$ can be obtained by taking the complex conjugate on the expression (6.76). As we have already mentioned, the case $k = 3$ is trivial. For $k = 4$, one gets

$$\langle W(C; \psi_i) \rangle|_{L(p,1)} = \begin{cases} 1 & \text{if } \psi_i = \Psi[0] ; \\ (1 - e^{-i2\pi p/3}) (1 + 2e^{-i2\pi p/3})^{-1} & \text{if } \psi_i = \Psi[1, 0] ; \\ (1 - e^{-i2\pi p/3}) (1 + 2e^{-i2\pi p/3})^{-1} & \text{if } \psi_i = \Psi[0, 1] . \end{cases} \quad (6.77)$$

The general expression of $\langle W(L) \rangle|_{L(p,1)}$ can be obtained by using the decomposition (6.73) for $W(L)$, where L belongs to the complement solid torus of U in S^3 . Similarly to the case of the manifold $S^2 \times S^1$, we only need to consider the knot C shown in Fig.6.10 with preferred framing and colour state ψ_i . Let us consider first $\langle W(L) W(U, \Psi_0) \rangle|_{S^3}$, where the unknot U has framing specified by eq.(6.46) with $r = p$. By means of two Kirby moves, the link shown in Fig.6.10 can

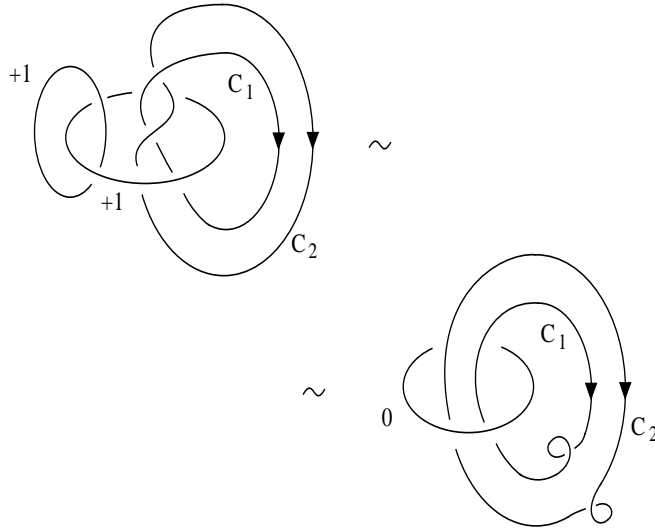

Figure 6.9

be transformed as shown in Fig.6.11. Therefore, by using eq.(6.68) and by taking into account the normalization factor, one finds

$$\langle W(C; \psi_i) W(U, \Psi_0) \rangle_{S^3} = a(k) \sum_{jm} N_{jmi^*} E_0[j] E_0[m] q^{Q(j)} q^{(p-1)Q(m)} q^{-Q(i)} \quad . \quad (6.78)$$

Let us denote by $Z_{(p)}$ the expectation value

$$Z_{(p)} = \langle W(U, \Psi_0) \rangle_{S^3} = a(k) \sum_i q^{pQ(i)} E_0^2[i] \quad . \quad (6.79)$$

For $Z_{(p)} \neq 0$, the expectation value $\langle W(L) \rangle_{L(p,1)}$ is given by

$$\langle W(L) \rangle_{L(p,1)} = Z_{(p)}^{-1} \sum_{jmi} \xi_L(i) N_{jmi^*} E_0[j] E_0[m] q^{Q(j)} q^{(p-1)Q(m)} q^{-Q(i)} \quad . \quad (6.80)$$

The last example of this section is the Poincaré manifold \mathcal{P} . This manifold is a homology sphere but not a homotopy sphere. A surgery presentation of \mathcal{P} is given by the right-handed trefoil knot T in S^3 with surgery coefficient $r = 1$ (and framing specified by eq.(6.46)). The knot $C \subset \mathcal{P}$ shown in Fig.6.11 has preferred framing. For simplicity, we shall concentrate on the case $k = 1$. By using the result (4.80) of Chap.4, one obtains

$$\langle W(C; \psi_i) W(T, \Psi_0) \rangle_{S^3} = \begin{cases} -i & \text{for } \psi_i = \Psi[0] ; \\ (\sqrt{3} + i)/2 & \text{for } \psi_i = \Psi[\pm 1] . \end{cases} \quad (6.81)$$

Therefore,

$$\langle W(C; \psi_i) \rangle_{\mathcal{P}} = \begin{cases} 1 & \text{for } \psi_i = \Psi[0] ; \\ (i\sqrt{3} - 1)/2 & \text{for } \psi_i = \Psi[\pm 1] . \end{cases} \quad (6.82)$$

It is clear that the corresponding expressions for $k = 2$ can be obtained from (6.82) by taking the complex conjugate and the results for $k = 4$ coincide with (6.82). For higher values of k , the computation of $\langle W(L) \rangle_{\mathcal{P}}$ is straightforward.

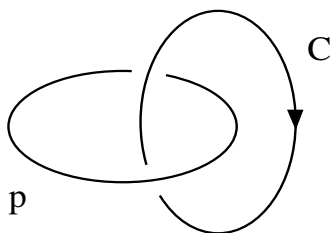

Figure 6.10

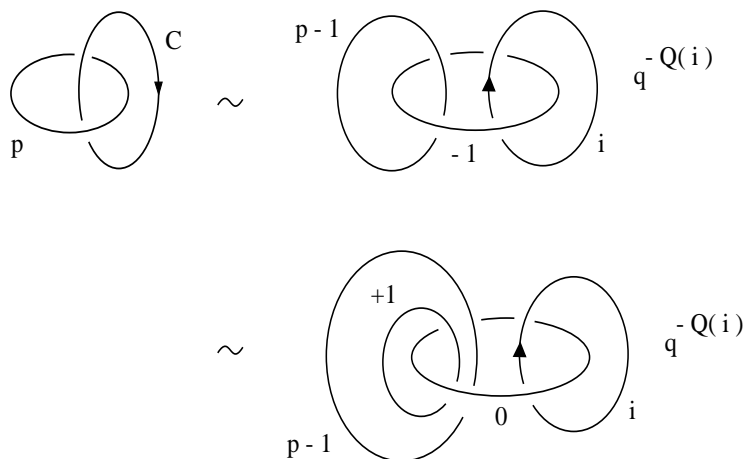

Figure 6.11

6.6.3 Manifolds $\Sigma_g \times S^1$

In this section we shall consider the set of manifolds $\Sigma_g \times S^1$, where Σ_g is a Riemann surface of genus g . Let us denote by $\mathcal{L}(g)$ a surgery link in S^3 corresponding to a surgery presentation of $\Sigma_g \times S^1$. We shall describe firstly how to construct $\mathcal{L}(g)$ for arbitrary g . Then, we shall consider examples of links in $\Sigma_g \times S^1$.

The manifold Σ_g can be obtained from the two-sphere S^2 by adding g handles, of course. Similarly, the 3-manifold $\Sigma_g \times S^1$ can be obtained from $S^2 \times S^1$ by “adding g handles” according to the prescription described in [46]. Consider the link $L(g)$ in S^3 shown in Fig.6.13, where the component U and the g components $\{M_1, \dots, M_g\}$ have preferred framings. The surgery link $\mathcal{L}(g)$ is a satellite of $L(g)$ which is obtained by replacing each component M_i (with $1 \leq i \leq g$) with $h^\diamond(P)$. The homeomorphism h^\diamond has been defined in Sect.2.2. The pattern link P , which is contained in the complement solid torus N of the unknot V in S^3 , is shown in Fig.6.14. The satellite obtained according to this prescription is the link $\mathcal{L}(g)$ in S^3 which has $2g + 1$ components. Each component of $\mathcal{L}(g)$ has preferred framing and, consequently, the associated surgery coefficient is $r = 0$.

For example, the surgery link $\mathcal{L}(1)$ is shown in Fig.6.15; $\mathcal{L}(1)$ is ambient isotopic with the Borromean

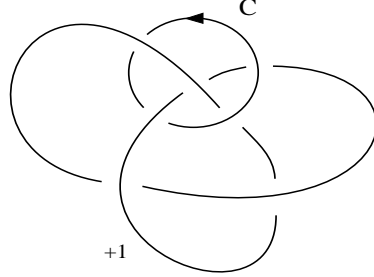

Figure 6.12

rings and corresponds to the manifold $\Sigma_g \times S^1 \equiv T^2 \times S^1$.

Suppose that both components of the pattern link P have colour Ψ_0 . We shall denote by $W(P; \Psi_0, \Psi_0)$ the product of the associated Wilson line operators. Since P is defined in N , $W(P; \Psi_0, \Psi_0)$ is a gauge invariant observable defined inside a solid torus. Consequently it admits a decomposition of the type [33] see Sect.4.

$$W(P; \Psi_0, \Psi_0) = \sum_i \eta(i) W(K; \psi_i) \quad , \quad (6.83)$$

where K is the core of N with preferred framing. One finds

$$\eta(i) = \sum_j E_0^{-1}[j] H_{ji} \quad . \quad (6.84)$$

Details of the derivation of (6.84) will be given in Chap.8. Eq.(6.84) is valid for any group G . Eq.(6.83) gives the decomposition of the surgery operator, which is associated with “one handle”, in terms of a single coloured link component. The above decomposition will be useful in the computation of expectation values of Wilson line operators in $\Sigma_g \times S^1$.

Let consider for example the case $k = 5$; the reduced tensor algebra $\mathcal{T}_{(5)}$ is of order six and the elements of its standard basis are [33]

$$\{ \Psi[0, 0], \Psi[1, 0], \Psi[2, 0], \Psi[0, 1], \Psi[0, 2], \Psi[1, 1] \} \quad . \quad (6.85)$$

The nontrivial structure constants are given by

$$\Psi[1, 0] \Psi[1, 0] = \Psi[2, 0] + \Psi[0, 1] \quad , \quad \Psi[1, 0] \Psi[0, 1] = \Psi[0, 0] + \Psi[1, 1] \quad , \quad (6.86)$$

$$\Psi[1, 0] \Psi[2, 0] = \Psi[1, 1] \quad , \quad \Psi[1, 0] \Psi[0, 2] = \Psi[0, 1] + \Psi[1, 1] \quad , \quad (6.87)$$

$$\Psi[1, 0] \Psi[1, 1] = \Psi[1, 0] + \Psi[0, 2] \quad , \quad \Psi[0, 1] \Psi[0, 1] = \Psi[0, 2] + \Psi[1, 0] \quad , \quad (6.88)$$

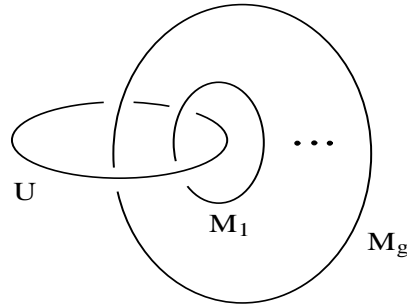

Figure 6.13

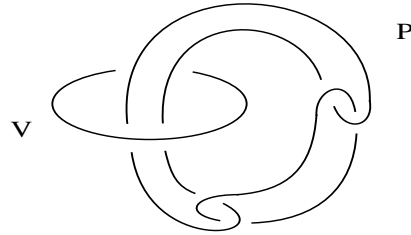

Figure 6.14

$$\Psi[0, 1] \Psi[2, 0] = \Psi[1, 0] + \Psi[1, 1] \quad , \quad \Psi[0, 1] \Psi[0, 2] = \Psi[1, 1] \quad , \quad (6.89)$$

$$\Psi[0, 1] \Psi[1, 1] = \Psi[0, 1] + \Psi[2, 0] \quad , \quad \Psi[2, 0] \Psi[2, 0] = \Psi[0, 2] \quad , \quad (6.90)$$

$$\Psi[0, 2] \Psi[0, 2] = \Psi[2, 0] \quad , \quad \Psi[0, 2] \Psi[1, 1] = \Psi[1, 0] \quad , \quad (6.91)$$

$$\Psi[1, 1] \Psi[1, 1] = \Psi[1, 1] + \Psi[0, 0] \quad . \quad (6.92)$$

The non-vanishing η -coefficients for $k = 5$ are

$$\eta[0, 0] = 6 \quad , \quad \eta[1, 1] = 3 \quad . \quad (6.93)$$

By using the decomposition (6.83), one finds

$$\langle \widetilde{W}(\mathcal{L}(1)) \rangle_{S^3} = 6\sqrt{3(\sqrt{5} + 1)/2} \quad . \quad (6.94)$$

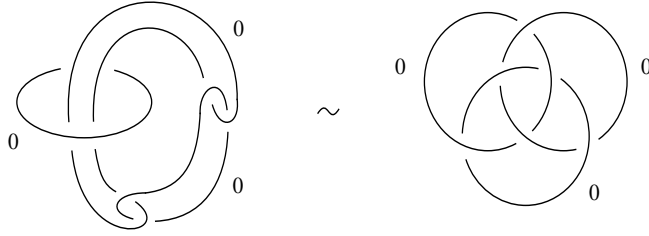

Figure 6.15

Let us now consider the knot $C \subset T^2 \times S^1$ shown in Fig.6.16; when C has preferred framing and colour ψ_i , one gets

$$\langle \widetilde{W}(C; \psi_i) \rangle_{T^2 \times S^1} = \begin{cases} 1 & \text{for } \psi_i = \Psi[0, 0]; \\ 1/2 & \text{for } \psi_i = \Psi[1, 1]. \end{cases} \quad (6.95)$$

In a generic manifold of the type $\Sigma_g \times S^1$, we can interpret S^1 as a compactified “time” interval, Σ_g being the space-like surface. According to this interpretation, the knot $C \subset T^2 \times S^1$ shown in Fig.9.16 describes the static situation in which a single coloured puncture is present in T^2 .

Consider now the static case in which two coloured punctures are present on T^2 . Let C_1 and C_2 be the knots in $T^2 \times S^1$ which describe these two punctures. From eq.(6.93) it follows that

$$\langle \widetilde{W}(C_1; \psi_i) W(C_2; \psi_j) \rangle_{T^2 \times S^1} = \delta_{ij^*} + \frac{1}{2} N_{ij[1,1]} \quad . \quad (6.96)$$

It is clear that eq.(6.96) can easily be generalized to the case in which several punctures are present in T^2 . Indeed, by means of the satellite formulae, we can replace the link associated with these punctures by a single knot. The same method can also be used to analyze the situation in which the genus (number of handles) is greater than one. In fact, according to eq.(10.1), adding one handle is equivalent to the introduction of a puncture with colour $\psi_{(h)} = \sum_i \eta(i) \psi_i$. For example, let us consider $\Sigma_2 \times S^1$ with one puncture having colour ψ_i . By using eqs.(6.93) and (6.93) one obtains

$$\langle \widetilde{W}(C; \psi_i) \rangle_{\Sigma_2 \times S^1} = \delta_{i[0,0]} + \delta_{i[1,1]} \quad . \quad (6.97)$$

6.7 Properties of the Surgery

After we have given some example of calculation of observables of $SU(3)$ CS theory in manifolds different from S^3 , in this section we shall come back to general properties of surgery.

Let us consider the surgery instruction given by the unknot U in S^3 with surgery coefficient $r = 0$. The corresponding surgery operation S_0 in S^3 is the result of the following instructions [23]:

1. fix a tubular neighborhood N of a unknot U and remove the interior \dot{N} of N from S^3 ,
2. consider N and $S^3 - \dot{N}$ as distinct spaces,

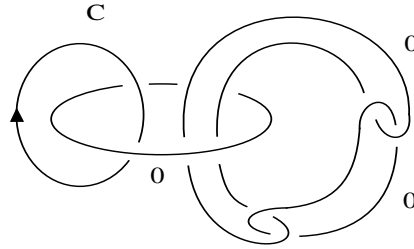

Figure 6.16

3. sew back N with $S^3 - \dot{N}$ by identifying their boundaries according to a homeomorphism $h : \partial N \rightarrow \partial(S^3 - \dot{N})$ which sends a meridian of N into a meridian of $S^3 - \dot{N}$.

The manifold corresponding to the surgery instruction given by the unknot U in S^3 with surgery coefficient $r = 0$ is homeomorphic with $S^2 \times S^1$.

We shall now prove [56] two remarkable properties of the operator corresponding to the S_0 surgery. Let us consider the link in S^3 depicted in Fig.6.17 in which the component U represents a surgery instruction with surgery coefficient $r = 0$. This link gives a surgery description a knot C in $S^2 \times S^1$ with nontrivial homotopy class. For the observable associated with C in $S^2 \times S^1$ the following property holds.

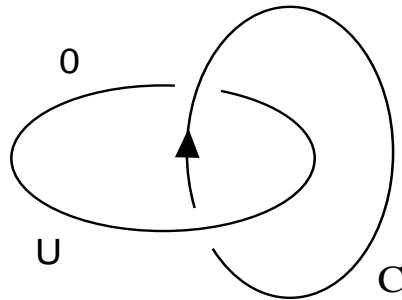

Figure 6.17

Theorem 6.5

The expectation value in $S^2 \times S^1$ of the Wilson line associated with the link C , shown in Fig.6.17, with colour $\psi[j]$ is

$$\langle W(C; \psi[j]) \rangle_{S^2 \times S^1} = \frac{\langle W(U; \Psi_0) W(C; \psi[j]) \rangle_{S^3}}{\langle W(U; \Psi_0) \rangle_{S^3}} = \delta_{1j} \quad , \quad (6.98)$$

where $\psi[1]$ is the class defined by the one dimensional trivial representation.

Proof First of all, since

$$\langle W(U; \Psi_0) \rangle_{S^3} = a(k) \sum_m E_0^2[m] = a(k)^{-1} > 0 \quad , \quad (6.99)$$

by definition of the regular reduced tensor algebra, expression (6.99) is well defined. Let us now consider the expectation value of the Wilson line associated with the link shown in Fig.6.18.

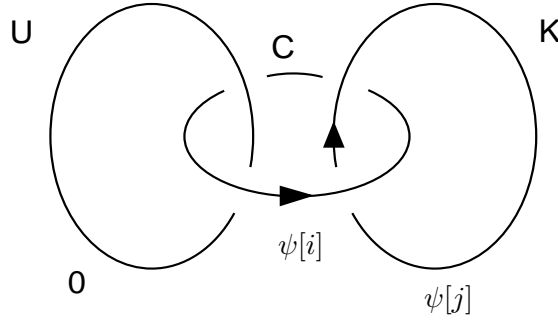

Figure 6.18

On the one hand, by using the definition of the surgery operation S_0 one finds

$$\langle W(U, C, K; \Psi_0, \psi[j], \psi[i]) \rangle_{S^3} = E_0[i] \langle W(U, C; \Psi_0, \psi[j]) \rangle_{S^3} . \quad (6.100)$$

Indeed, since we are dealing with a topological field theory, by means of an isotopy we can move the knot K into the interior of the tubular neighborhood N of U which is involved in the surgery operation S_0 . By using the homeomorphism h entering the definition of S_0 , K becomes homotopically trivial in N and its expectation value factorizes [36] as we have seen in Sect.6.6. On the other hand, by using the connected sum rule one has

$$\langle W(U, C, K; \Psi_0, \psi[j], \psi[i]) \rangle_{S^3} = (E_0[j])^{-1} H[i, j] \langle W(U, C; \Psi_0, \psi[j]) \rangle_{S^3} . \quad (6.101)$$

Since equations (6.100) and (6.101) are both satisfied, by setting

$$\mathcal{Z}(j) = \langle W(U; \Psi_0) W(C; \psi[j]) \rangle_{S^3} \quad , \quad (6.102)$$

one finds

$$(E_0[i] E_0[j] - H[i, j]) \mathcal{Z}(j) = 0 \quad \forall \psi[i], \psi[j] \in \mathcal{T}_{(k)} . \quad (6.103)$$

We now show that eq.(6.103) implies that $\mathcal{Z}(j) = 0 \forall j \neq 1$.

When $\psi[j] = \psi[1]$ the equality (6.103) trivially holds. Indeed $E_0[1] = 1$ and $H[i, 1] = E_0[i]$. Assume now that there is an element $\psi[m]$ of the standard basis, with $\psi[m] \neq \psi[1]$, for which (6.103) is satisfied with $j = m$ and $\mathcal{Z}(m) \neq 0$; we need to prove that, in this case, one gets a contradiction. Indeed, from (6.103) it follows that

$$H[i, m] = E_0[i] E_0[m] \quad \forall \psi[i] \in \mathcal{T}_{(k)} . \quad (6.104)$$

Let us consider a generic link L_φ in S^3 with one of its components A coloured with $\varphi \in \mathcal{T}_{(k)}$. By using the surgery operators, one can find a surgery presentation [23] of $L_\varphi \subset S^3$ in which A is the

unknot with colour φ and the remaining components of L_φ and the surgery link are contained in the complement solid torus of A in S^3 . Let us denote by B the core of the complement solid torus of the unknot A in S^3 . By using the decomposition (4.16), we obtain

$$\langle W(L_\varphi) \rangle|_{S^3} = \sum_i \xi(i) \langle W(A, B; \varphi; \psi[i]) \rangle|_{S^3}. \quad (6.105)$$

The union of knots A and B is simply the Hopf link in S^3 . In general, φ will be a linear combination of the standard basis of $\mathcal{T}_{(k)}$

$$\varphi = \sum_n a_n \psi[n]. \quad (6.106)$$

Thus

$$\langle W(L_\varphi) \rangle|_{S^3} = \sum_{i,n} \xi(i) a_n H[i, n]. \quad (6.107)$$

If we choose φ to be

$$\varphi = \psi[m] - \psi[1] E_0[m]; \quad (6.108)$$

equation (6.107) becomes

$$\begin{aligned} \langle W(L_\varphi; \varphi) \rangle|_{S^3} &= \sum_i \xi(i) (H[i, m] - E_0[m] E_0[i]) \\ &= \sum_i \xi(i) (E_0[m] E_0[i] - E_0[m] E_0[i]) \\ &= 0 \quad . \end{aligned} \quad (6.109)$$

Equation (6.109) means that φ is physically equivalent to the null element. Therefore, φ is the null element because $\mathcal{T}_{(k)}$ is (by definition) physically irreducible. This implies that $\psi[m] = \psi[1]$. Thus, we have reached a contradiction.

At this point, we have shown that

$$\mathcal{Z}(j) = f(k) \delta_{1j}. \quad (6.110)$$

The normalization factor $f(k)$ can easily be obtained from the definition of $\mathcal{Z}(j)$. Indeed

$$f(k) = \mathcal{Z}(j = 1) = \langle W(U, K; \Psi_0, \psi[1]) \rangle|_{S^3} = \langle W(U; \Psi_0) \rangle|_{S^3} = a(k)^{-1}. \quad (6.111)$$

Thus

$$\langle W(C; \psi[i]) \rangle|_{S^2 \times S^1} = \frac{\langle W(U, C; \Psi_0, \psi[i]) \rangle|_{S^3}}{\langle W(U; \Psi_0) \rangle|_{S^3}} = \delta_{1i}. \quad (6.112)$$

□

It should be noted that Theorem 6.5 has a topological origin but is also strictly connected with the peculiar role played by the reduced tensor algebra in the CS theory. Theorem 6.5 can be understood [37] to be a consequence of the conservation of the non-Abelian electric flux originated by a static source in a closed universe described by the 3-manifold $S^2 \times S^1$.

We conclude this section by showing how the structure constants of $\mathcal{T}_{(k)}$ can be expressed in terms of the CS gauge invariant observables. This will permit us to interpret the equations involving $\{N_{ijm}\}$ in terms of relations between observables.

Theorem 6.6

The structure constants of $\mathcal{T}_{(k)}$ can be represented by the expectation value in $S^2 \times S^1$ of the Wilson line operator associated with the three-component link shown in Fig.6.19

$$N_{ijm^*} = \langle W(C_1; \psi[i]) W(C_2; \psi[j]) W(C_3; \psi[m]) \rangle \Big|_{S^2 \times S^1} \quad . \quad (6.113)$$

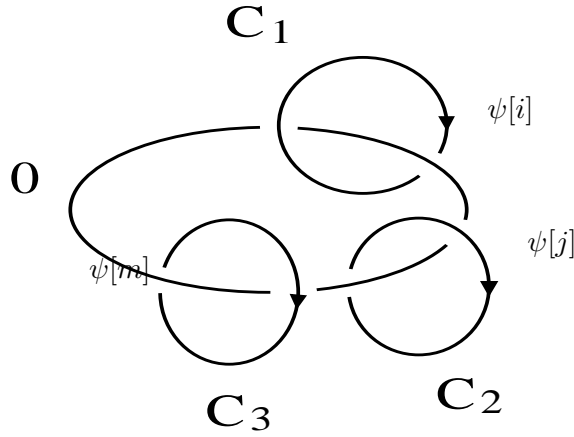

Figure 6.19

Proof

By using the satellite formula (2.32), one obtains

$$\begin{aligned} \langle W(C_1; \psi[i]) W(C_2; \psi[j]) W(C_3; \psi[m]) \rangle \Big|_{S^2 \times S^1} &= \\ &= \langle W(C_1; \psi[i] \psi[j] \psi[m]) \rangle \Big|_{S^2 \times S^1} \\ &= \sum_t N_{ijt} \langle W(C_1; \psi[t] \psi[m]) \rangle \Big|_{S^2 \times S^1} \\ &= \sum_t N_{ijt} N_{tm1} = \sum_t N_{ijt} \delta_{tm^*} \\ &= N_{ijm^*} \quad . \end{aligned} \quad (6.114)$$

□

Equation (6.113) is in agreement with the symmetry properties of the structure constants $\{N_{ijm}\}$ postulated in the definition of a regular reduced tensor algebra.

In Sect.6.4 we have introduced the quantities Z_0 and $Z_{(\pm)}$, which are related with the normalization of the elementary surgery operators

$$Z_0 = \sum_i E_0^2[i] \quad , \quad (6.115)$$

$$Z_{(\pm 1)} = \sum_i q^{\pm Q(i)} E_0^2[i] \quad . \quad (6.116)$$

By definition, one has $Z_{(-1)} = Z_{(+1)}^*$. From the general properties of surgery it follows:

Theorem 6.7 *The quantity Z_0 is related to the Hopf matrix by*

$$(H^2)_{ij} = Z_0 N_{ij\mathbf{1}} \quad . \quad (6.117)$$

Proof By definition we have

$$(H^2)_{ij} = \sum_m H_{im} H_{mj} = \sum_m E_0[m] E_0[m]^{-1} H_{im} H_{mj} \quad . \quad (6.118)$$

By using the connected sum formula (2.40), Eq.(6.118) can be written as

$$(H^2)_{ij} = \sum_m E_0[m] \langle W(C_1, C_2, C_3; \psi[i], \psi[j], \psi[m]) \rangle_{S^3} \quad , \quad (6.119)$$

where C_1, C_2 and C_3 are the components of the link shown in Fig.16.20.

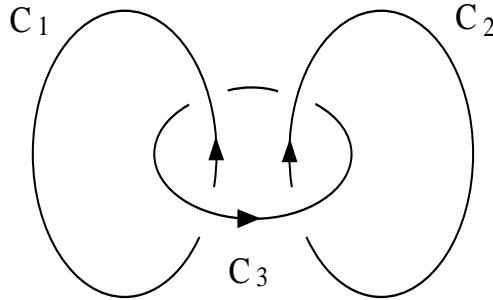

Figure 6.20

The satellite relation (2.32) can be used to eliminate one of the components of the link in Fig.6.20; we obtain

$$(H^2)_{ij} = \sum_{n,m} N_{ijn} E_0[m] H_{mn} = \sum_n a(k)^{-1} \langle W(U; \Psi_0) \rangle_{S^3} N_{ijn} \langle W(U, C; \Psi_0, \psi[n]) \rangle_{S^2 \times S^1} \quad . \quad (6.120)$$

The knots U and C are the components of the link shown in Fig.6.17. From Theorem 6.5, it follows

$$(H^2)_{ij} = a(k)^{-1} \langle W(U; \Psi_0) \rangle_{S^3} N_{ij\mathbf{1}} = Z_0 N_{ij\mathbf{1}} \quad . \quad (6.121)$$

□

By using Theorem 6.6, one can also show that Z_0 and $Z_{(\pm)}$ are not independent. Actually, the following relation exists.

Theorem 6.7 *The complex numbers $Z_0, Z_{(+1)}$ and $Z_{(-1)}$ satisfy*

$$Z_0 = Z_{(+1)} Z_{(-1)} \quad . \quad (6.122)$$

Proof On the one hand, from eq.(6.56) one obtains

$$\sum_{ij} q^{Q(i)} E_0[i] E_0[j] H_{ij} = \sum_{ij} q^{Q(i)} E_0[i] H_{ij} H_{j\mathbf{1}} = \sum_i q^{Q(i)} E_0[i] (H^2)_{i\mathbf{1}} = Z_{(+1)} Z_{(-1)} \quad . \quad (6.123)$$

By using Theorem 6.6, from Eq.(6.123) one gets

$$\sum_i q^{Q(i)} Z_0 E_0[i] N_{i\mathbf{1}\mathbf{1}} = Z_0 = Z_{(+1)} Z_{(-1)} \quad . \quad (6.124)$$

□

When the gauge group is $SU(2)$ or $SU(3)$, from the explicit expressions of H , Z_0 and $Z_{(\pm)}$, the validity of the relations stated in Theorem 6.6 and in Theorem 6.7 can be verified by a direct calculation [31, 36].

Chapter 7

A three-manifold invariant

7.1 Introduction

Given a manifold \mathcal{M} , a topological invariant is a map $f : \mathcal{M} \rightarrow \mathbb{C}$ which assigns to each manifold \mathcal{M} a complex number $I(\mathcal{M})$ in such way that, if \mathcal{M}_1 and \mathcal{M}_2 are homeomorphic, then $I(\mathcal{M}_1) = I(\mathcal{M}_2)$. Roughly speaking, two manifolds \mathcal{M}_1 and \mathcal{M}_2 are homeomorphic if \mathcal{M}_1 can be continuously deformed to \mathcal{M}_2 . For example, the surface of an ellipsoid is homeomorphic with a 2-sphere S^2 ; on the contrary, a torus cannot be continuously deformed to S^2 .

We shall construct a topological invariant of closed, connected and orientable 3-manifolds based on the CS partition function. In the framework of Dehn's surgery, any closed, connected and orientable 3-manifolds corresponds to a class of surgery instructions. By definition, given two sets of surgery instruction contained in the same class, they are related by a sequence of Kirby moves and describe homeomorphic 3-manifolds. Thus, in the framework of Dehn's surgery, topological invariance is translated into invariance under Kirby moves.

7.2 Definition of the invariant

As we have shown in the previous sections, the expectation value $\langle W(L) \rangle_{\mathcal{M}}$ represents a topological invariant of the link L in the three-manifold \mathcal{M} . Our present goal is to construct a topological invariant of the manifold \mathcal{M} itself. In the surgery presentation, each three-manifold \mathcal{M} is characterized by a class of equivalent surgery links in S^3 . Thus, it is natural to look for a manifold invariant [37] which is defined by the expectation value of the Wilson line operators associated with the surgery links $\{\mathcal{L}\}$. Let us consider the partition function $Z(\mathcal{M})$ for the CS theory in the 3-manifold \mathcal{M} defined as

$$Z(\mathcal{M}) = \frac{\langle 0|W(\mathcal{L})|0 \rangle_{S^3}}{\langle 0|0 \rangle_{S^3}} = \langle W(\mathcal{L}) \rangle_{S^3} = \langle 0|0 \rangle_{\mathcal{M}} \quad . \quad (7.1)$$

In the derivation of the surgery rules for the field theory, we have seen that $\langle \widetilde{W}(\mathcal{L}) \rangle_{S^3}$ carries informations on the manifold \mathcal{M} . Unfortunately, $\langle \widetilde{W}(\mathcal{L}) \rangle_{S^3}$ is not invariant under Kirby moves and, consequently, the partition function (7.1) cannot represent a three-manifold invariant. In Sect.6.5 we have shown that, under a Kirby move, $\langle \widetilde{W}(\mathcal{L}) \rangle_{S^3}$ gets multiplied by the phase factor $e^{\pm i\theta_k}$. Therefore, in order to define a topological invariant, we simply need to introduce [44, 12, 48, 42, 43, 41] a multiplicative term which cancels out this phase factor.

Let \mathcal{M} be a (closed, connected and orientable) three-manifold corresponding to the "honest" surgery link \mathcal{L} in S^3 . Let us introduce an orientation for \mathcal{L} and let us denote by $\sigma(\mathcal{L})$ the signature

of the linking matrix L_{ij} associated with \mathcal{L} , i.e

$$L_{ij} = \begin{cases} \text{lk}(C_i, C_j) & \text{for } i \neq j \\ \text{lk}(C_i, C_{if}) & \text{for } i = j \end{cases} . \quad (7.2)$$

Theorem 7.1

The improved partition function

$$I(\mathcal{M}) = \exp[i\theta_k \sigma(\mathcal{L})] \langle \widetilde{W}(\mathcal{L}) \rangle_{S^3} , \quad (7.3)$$

where $\widetilde{W}(\mathcal{L})$ has been defined in Sect.6.5, is invariant under Kirby moves and represents a topological three-manifold invariant of \mathcal{M} .

Proof. Under a Kirby move, $\langle \widetilde{W}(\mathcal{L}) \rangle_{S^3}$ transforms as

$$\langle \widetilde{W}(\mathcal{L}) \rangle_{S^3} \rightarrow e^{\pm i\theta} \langle \widetilde{W}(\mathcal{L}) \rangle_{S^3} , \quad (7.4)$$

whereas the signature $\sigma(\mathcal{L})$ transforms as [42, 43]

$$\sigma(\mathcal{L}) \rightarrow \sigma(\mathcal{L}) \mp 1 . \quad (7.5)$$

Therefore $I(\mathcal{M})$ is invariant under Kirby moves. \square

According to the surgery rules described in Sect.6.5, $I(\mathcal{M})$ can be interpreted [37] as the value of the (improved) partition function of the Chern-Simons field theory in \mathcal{M} . From the definition (7.3), it follows that

$$I(S^3) = 1 . \quad (7.6)$$

Eq.(7.6) shows $I(\mathcal{M})$ is normalized in such way that S^3 plays the role of a reference manifold. In the next section, as examples, we shall give the value of $\mathcal{I}(\mathcal{M})$ for some three-manifolds when the gauge group is $SU(3)$.

7.3 Examples

The manifold $S^2 \times S^1$ admits a surgery presentation described by the unknot with surgery coefficient $r = 0$. In this case, $\sigma(\mathcal{L}) = 0$ and then one gets

$$I(S^2 \times S^1) = \begin{cases} \sqrt{3} & \text{for } k = 1, 2 , \\ (k\sqrt{3}/16) \cos^{-1}(\pi/k) \sin^{-3}(\pi/k) & \text{for } k \geq 3 . \end{cases} \quad (7.7)$$

Let us consider the lens spaces $L(p, 1)$ with $p \geq 2$; a surgery link for these manifolds is the unknot with surgery coefficient $r = p$, the signature of the corresponding linking matrix is equal to $+1$. By using the results of Sect.6.7.2, one has

$k = 1$

$$I(L(p, 1)) = \frac{i}{\sqrt{3}} \left(1 + 2e^{-i\pi p/3} \right) . \quad (7.8)$$

$k = 2$

$$I(L(p, 1)) = \frac{-i}{\sqrt{3}} \left(1 + 2e^{i\pi p/3} \right) . \quad (7.9)$$

$k = 3$

$$I(L(p, 1)) = 1 \quad . \quad (7.10)$$

$k = 4$

$$I(L(p, 1)) = \frac{i}{\sqrt{3}} \left(1 + 2 e^{-i\pi p/3} \right) \quad . \quad (7.11)$$

$k = 5$

$$\mathcal{I}(L(p, 1)) = e^{-i6\pi/5} \sqrt{\frac{2}{3(\sqrt{5}+1)}} \left[1 + 2 e^{i2\pi p/3} \right] \left[1 + \frac{1}{2}(3 + \sqrt{5}) e^{-i6\pi p/5} \right] \quad . \quad (7.12)$$

The Poincaré manifold admits a surgery presentation described by the right-handed trefoil with surgery coefficient $r = 1$ as we have seen in Sect.7.6.3. In 1900, Poincaré conjectured that any 3-manifold having the same homology groups of S^3 (homology spheres) is homeomorphic with S^3 . Soon after, the same Poincaré found a counter-example to his conjecture. Indeed the Poincaré manifold \mathcal{P} is a homology sphere, nevertheless it is not homeomorphic with S^3 , its fundamental group $\pi_1(\mathcal{P})$ being the icosahedral group.

The values of the associated invariant are

$k = 1, 2, 3, 4$

$$I(\mathcal{P}) = 1 \quad . \quad (7.13)$$

$k = 5$

$$I(\mathcal{P}) = \sqrt{\frac{2}{3(\sqrt{5}+1)}} (2 - i\sqrt{3}) \left(\frac{3 + \sqrt{5}}{2} \right) (1 - e^{-i\pi/5}) \quad . \quad (7.14)$$

The manifold $T^2 \times S^1$ corresponds to the surgery link shown in Fig.6.15. From eq.(6.84), it follows that $\eta(1) = \sum_i 1 = \dim \mathcal{T}_{(k)}$. Consequently, one has

$$I(T^2 \times S^1) = \mathcal{I}(S^2 \times S^1) \dim \mathcal{T}_{(k)} \quad . \quad (7.15)$$

Let us now consider the manifold $\Sigma_g \times S^1$; by using the handle decomposition (6.83), we find

$k = 1, 2, 4$

$$I(\Sigma_g \times S^1) = \sqrt{3} 3^g \quad . \quad (7.16)$$

$k = 3$

$$I(\Sigma_g \times S^1) = 1 \quad . \quad (7.17)$$

$k = 5$

$$I(\Sigma_g \times S^1) = \begin{cases} 3^g 5^{g/2} F(g-1) \sqrt{3(\sqrt{5}+1)}/2 & \text{for } g \text{ even;} \\ 3^g 5^{(g-1)/2} [F(g) + F(g-2)] \sqrt{3(\sqrt{5}+1)}/2 & \text{for } g \text{ odd} \end{cases} \quad . \quad (7.18)$$

In eq.(7.18), $F(g)$ denotes the g -th Fibonacci number; i.e. $F(g)$ is defined by $F(g) = F(g-1) + F(g-2)$, with $F(1) = F(2) = 1$. Details on the derivation of eq.(7.18) can be found in Appendix C.

7.4 Properties of the CS 3-manifold invariant

7.4.1 Introduction

The algebraic aspects of the construction of the CS 3-manifold invariant, which is based on the structure of simple Lie groups, are well understood [12, 41, 42, 43, 24, 48, 37]. However, the topological meaning of this invariant is still unclear. Let us recall that the invariant of the 3-manifold $I(\mathcal{M})$ defined by means of the Chern-Simons quantum field theory [57, 37] coincides with the Reshetikhin-Turaev invariant [44, 12]. In general, it is not known how $I(\mathcal{M})$ is related, for instance, to the homotopy class of \mathcal{M} or to the fundamental group of \mathcal{M} . In this section we shall address this issue in the case $\mathcal{M} = L_{p/r}$, where $L(p, r)$ are the lens spaces. In addition we shall formulate the following conjecture [52].

Conjecture: For non-vanishing $I(\mathcal{M})$, the absolute value $|I(\mathcal{M})|$ only depends on the fundamental group $\pi_1(\mathcal{M})$.

In the absence of a general proof, we shall verify the validity of the conjecture for a particular class of manifolds: the lens spaces. There are examples of lens spaces \mathcal{M}_1 and \mathcal{M}_2 with the same fundamental group $\pi_1(\mathcal{M}_1) \simeq \pi_1(\mathcal{M}_2)$ which are not homeomorphic; for all these manifolds, we shall prove that (for non-vanishing invariants) $|I(\mathcal{M}_1)| = |I(\mathcal{M}_2)|$ when $I(\mathcal{M})$ is the invariant associated with the group $SU(2)$. In the case in which the gauge group is $SU(3)$, we will present numerical computations confirming the conjecture. This computation is in agreement with the computer calculations for $SU(2)$ of Freed and Gompf [50] and the expression of the $SU(2)$ invariant obtained by Jeffrey [51]. Differently from [50] and [51], the present approach is based exclusively on the properties of 3-dimensional Chern-Simons quantum field theory.

7.4.2 Lens Spaces

Lens spaces, which are characterized by two integers p and r , will be denoted by $\{L_{p/r}\}$. The fundamental group of $L_{p/r}$ is Z_p . Two lens spaces $L_{p/r}$ and $L_{p'/r'}$ are homeomorphic if and only if $|p| = |p'|$ and $r = \pm r' \pmod{p}$ or $rr' = \pm 1 \pmod{p}$. Thus, we only need [23] to consider the case in which $p > 1$ and $0 < r < p$; moreover, r and p are relatively prime. The lens spaces $L_{p/r}$ and $L_{p'/r'}$ are homotopic if and only if $|p| = |p'|$ and $rr' = \pm$ quadratic residue \pmod{p} . Consequently, one can find examples of lens spaces which are homotopic but are not homeomorphic; for instance, $L_{13/2}$ and $L_{13/5}$. One can also find examples of lens spaces which are not homeomorphic and are not homotopic but have the same fundamental group; for instance, $L_{13/2}$ and $L_{13/3}$.

One possible surgery instruction corresponding to the lens space $L_{p/r}$ is given by the unknot [23] with rational surgery coefficient (p/r) . From this surgery presentation one can derive [23] an ‘‘honest’’ surgery presentation of $L_{p/r}$ by using a continued fraction decomposition of the ratio (p/r)

$$\frac{p}{r} = z_d - \frac{1}{z_{d-1} - \frac{1}{\ddots - \frac{1}{z_1}}}, \quad (7.19)$$

where $\{z_1, z_2, \dots, z_d\}$ are integers. The new surgery link \mathcal{L} corresponding to a ‘‘honest’’ surgery presentation of $L_{p/r}$ is a chain with d linked components, as shown in Figure 6.21, and the integers $\{z_1, z_2, \dots, z_d\}$ are precisely the surgery coefficients.

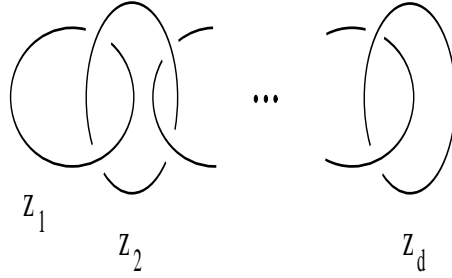

Figure 7.1

According to the definition, the lens space invariant is given by

$$I(L_{p/r}) = e^{i\theta_k \sigma(\mathcal{L})} (a_k)^d \sum_{j_1, \dots, j_d \in \mathcal{T}_k} \prod_{i=1}^d \left(q^{z_i Q(j_i)} \right) \times \\ \times E_0[j_1] \cdots E_0[j_d] E(\mathcal{L}; \psi[j_1], \dots, \psi[j_d]) \quad . \quad (7.20)$$

The link of Figure 6.21 can be understood as the connected sum of $(d-1)$ Hopf links \mathcal{H} , i.e. $\mathcal{L} = \mathcal{H} \# \mathcal{H} \cdots \# \mathcal{H}$. Therefore, by using equation (2.40), expression (7.20) can be written as

$$I(L_{p/r}) = e^{i\theta_k \sigma(\mathcal{L})} (a_k)^d \sum_{j_1, \dots, j_d \in \mathcal{T}_k} q^{(\sum_{i=1}^d z_i Q(j_i))} H_{1j_d} H_{j_d j_{d-1}} \cdots H_{j_2 j_1} H_{j_1 1} \quad . \quad (7.21)$$

Let us introduce the matrices

$$(X)_{ij} = a(k) H_{ij}, \quad (Y)_{ij} = q^{Q(i)} \delta_{ij} \quad . \quad (7.22)$$

As we shall see in the next Chapter, X and Y are associated with the modular group. In terms of the matrices (7.22), one finds [52]

$$I(L_{p/r}) = e^{i\theta_k \sigma(\mathcal{L})} (a_k)^{-1} [F(p/r)]_{11} \quad , \quad (7.23)$$

where $[F(p/r)]_{11}$ is the element corresponding to the first row and the first column of the following matrix

$$F(p/r) = XY^{z_d} XY^{z_{d-1}} X \cdots XY^{z_1} X \quad . \quad (7.24)$$

The invariant $I(L_{p/r})$ given in equation (7.23) is in agreement with the expressions obtained in [50, 51] apart from an overall normalization factor.

7.4.3 The $SU(2)$ case

In this section, we shall compute $I(L_{p/r})$ for the gauge group $G = SU(2)$. Then, we will show that in this case our conjecture is true; i.e. when $I(L_{p/r}) \neq 0$, the absolute value $|I(L_{p/r})|$ only depends on p .

For sake of notational simplicity, in this section, we shall use as label of the elements $\{\psi[j]\}$ of the standard basis of \mathcal{T}_k , for $k \geq 2$, the index j representing the dimension of the irreducible

representation described by $\psi[j]$ and $1 \leq j \leq (k-1)$. Thus, by using the results of Chap.3 and Chap.4 and Chap.6, the matrix elements of X and Y are given by

$$\begin{aligned} (X)_{mn} &= \frac{i}{\sqrt{2k}} \left[\exp\left(-\frac{i\pi mn}{k}\right) - \exp\left(\frac{i\pi mn}{k}\right) \right] ; \\ (Y)_{mn} &= \xi \exp\left(-\frac{i\pi m^2}{2k}\right) \delta_{mn} ; \end{aligned} \quad (7.25)$$

with

$$\xi = \exp(i\pi/2k) . \quad (7.26)$$

When $k = 1$, one has

$$X = \begin{pmatrix} 1 & 1 \\ 1 & -1 \end{pmatrix} , \quad Y = \begin{pmatrix} 1 & 0 \\ 0 & i \end{pmatrix} . \quad (7.27)$$

The algebra \mathcal{T}_1 is isomorphic with \mathcal{T}_3 and it is easy to verify that

$$I_{k=1}(L_{p/r}) = [I_{k=3}(L_{p/r})]^* . \quad (7.28)$$

Therefore, we only need to consider the case $k \geq 2$.

In order to compute $I(L_{p/r})$ [52], we shall derive a recursive relation for the matrix (7.24); the argument that we shall use has been produced by Jeffrey [51] in a slightly different context. In fact, our final result for $I(L_{p/r})$ is essentially in agreement with the formulae obtained by Jeffrey. Since in our approach the invariance under Kirby moves is satisfied, our derivation of $I(L_{p/r})$ proves that the appropriate expressions given in [50, 51] really correspond to the values of a topological invariant of 3-manifolds.

Let us introduce a few definitions; with the ordered set of integers $\{z_1, z_2, \dots, z_d\}$ one can define the following partial continued fraction decompositions

$$\frac{\alpha_t}{\gamma_t} = z_t - \frac{1}{z_{t-1} - \frac{1}{\ddots - \frac{1}{z_1}}} , \quad (7.29)$$

where $1 \leq t \leq d$. The integers α_t and γ_t satisfy the recursive relations

$$\alpha_{m+1} = z_{m+1} \alpha_m - \gamma_m, \quad , \quad \alpha_1 = z_1 \quad , \quad \alpha_0 = 1 \quad ; \quad (7.30)$$

$$\gamma_{m+1} = \alpha_m \quad , \quad \gamma_1 = 1 \quad , \quad (7.31)$$

and, clearly, $\alpha_d/\gamma_d = p/r$. Finally, let F_t be the matrix

$$F_t = XY^{z_t} XY^{z_{t-1}} X \dots XY^{z_1} X \quad ; \quad (7.32)$$

by definition, one has $F_d = F(p/r)$.

Lemma 7.1

The matrix element $(F_t)_{mn}$ is given by

$$(F_t)_{mn} = B_t \sum_{s(m,k,|\alpha_t|)} \left[e^{\frac{i\pi\gamma_t}{2k\alpha_t} \left(s + \frac{n}{\gamma_t}\right)^2} - e^{\frac{i\pi\gamma_t}{2k\alpha_t} \left(s - \frac{n}{\gamma_t}\right)^2} \right] ; \quad (7.33)$$

$$\begin{aligned} B_t &= \frac{(-i)^{t+1}}{\sqrt{2k|\alpha_t|}} \xi^{z_1+z_2+\dots+z_t} \exp\left\{-\frac{i\pi}{4} [\text{sign}(\alpha_0\alpha_1) + \dots + \text{sign}(\alpha_{t-1}\alpha_t)]\right\} \\ &\quad \exp\left\{\frac{i\pi n^2}{2k} \left[\frac{1}{\alpha_0\alpha_1} + \dots + \frac{1}{\alpha_{t-2}\alpha_{t-1}}\right]\right\} ; \end{aligned} \quad (7.34)$$

where $s(m, k, |\alpha_t|)$ stands for the sum over a complete residue system modulo $(2k|\alpha_t|)$ with the additional constraint $s \equiv m \pmod{2k}$.

Proof The proof is based on induction. First of all we need to verify the validity of equations (7.33) and (7.34) when $t = 1$. In this case, from the definition (7.32) one gets

$$(F_1)_{mn} = -\frac{1}{2k} \frac{1}{2} \xi^{z_1} \sum_{s=1}^{2k} e^{-i\pi s^2 z_1 / (2k)} \left[e^{-i\pi s(m+n)/k} - e^{-i\pi s(m-n)/k} + \text{c. c.} \right]. \quad (7.35)$$

Since the sum (7.35) covers twice a complete residue system modulo k , i.e. $1 \leq s \leq 2k$, a multiplicative factor $1/2$ has been introduced in (7.35). The change of variables $s \rightarrow -s$ shows that the last two terms in (7.35) are equal to the first two terms. Therefore, equation (7.35) can be written as

$$(F_1)_{mn} = -\frac{1}{2k} \xi^{z_1} \sum_{s=1}^{2k} e^{-i\pi s^2 z_1 / (2k)} \left[e^{-i\pi s(m+n)/k} - e^{-i\pi s(m-n)/k} \right]. \quad (7.36)$$

At this point, one can use the reciprocity formula (C.32) reported in the appendix and one gets

$$(F_1)_{mn} = \frac{-1}{\sqrt{2k|z_1|}} \xi^{z_1} \exp \left\{ -\frac{i\pi}{4} \text{sign}(\alpha_0 \alpha_1) \right\} \times \\ \times \sum_{v=0}^{|z_1|-1} \left[e^{\frac{i\pi}{2kz_1} (2kv+m+n)^2} - e^{\frac{i\pi}{2kz_1} (2kv+m-n)^2} \right]. \quad (7.37)$$

By introducing the new variable $s = 2kv + m$, one finds that in equation (7.37) the variable s covers a complete residue system modulo $(2k|z_1|)$ with the constraint that $s \equiv m \pmod{2k}$. Therefore, equation (7.37) can be written in the form

$$(F_1)_{mn} = B_1 \sum_{s(m, k, |z_1|)} \left[e^{\frac{i\pi}{2kz_1} (s+n)^2} - e^{\frac{i\pi}{2kz_1} (s-n)^2} \right]. \quad (7.38)$$

This confirms the validity of equation (7.33) when $t = 1$. In order to complete the proof, suppose now that (7.33) is true for a given t ; we shall show that (7.33) is true also in the case $t + 1$. Indeed, one has

$$(F_{t+1})_{mn} = \sum_{v=1}^k (XY^{z_{t+1}})_{mv} (F_t)_{vn}. \quad (7.39)$$

From equation (7.33) one gets

$$(F_{t+1})_{mn} = -B_t \frac{i\xi^{z_{t+1}}}{\sqrt{2k}} \frac{1}{2} \sum_{v=1}^{2k} \sum_{s(v, k, |\alpha_t|)} e^{-\frac{i\pi}{2k} v^2 z_{t+1}} \\ \left[e^{\frac{i\pi\gamma_t}{2k\alpha_t} \left(s - \frac{n}{\gamma_t}\right)^2} e^{-i\pi mv/k} - e^{\frac{i\pi\gamma_t}{2k\alpha_t} \left(s + \frac{n}{\gamma_t}\right)^2} e^{-i\pi mv/k} \right. \\ \left. - e^{\frac{i\pi\gamma_t}{2k\alpha_t} \left(s - \frac{n}{\gamma_t}\right)^2} e^{i\pi mv/k} + e^{\frac{i\pi\gamma_t}{2k\alpha_t} \left(s + \frac{n}{\gamma_t}\right)^2} e^{i\pi mv/k} \right]. \quad (7.40)$$

Again, the last two terms can be omitted provided one introduces a multiplicative factor 2. Moreover, because of the constraint $v = s \pmod{2k}$, one can set $v = s$, thus

$$(F_{t+1})_{mn} = -B_t \frac{i\xi^{z_{t+1}}}{\sqrt{2k}} e^{\frac{i\pi n^2}{2k\alpha_t \gamma_t}} \sum_{s=0}^{2k|\alpha_t|-1} \\ \left\{ e^{-\frac{i\pi}{2k\alpha_t} [\alpha_{t+1} s^2 + 2(\gamma_{t+1} m + n)s]} - e^{-\frac{i\pi}{2k\alpha_t} [\alpha_{t+1} s^2 + 2(\gamma_{t+1} m - n)s]} \right\}. \quad (7.41)$$

By using the reciprocity formula, one obtains the final expression for $(F_{t+1})_{mn}$

$$(F_{t+1})_{mn} = -i B_t \xi^{z_{t+1}} \sqrt{\frac{|\alpha_t|}{|\alpha_{t+1}|}} e^{\left(\frac{i\pi n^2}{2k\alpha_t\alpha_{t+1}}\right)} e^{\frac{-i\pi}{4} \text{sign}(\alpha_t\alpha_{t+1})} \sum_{v=1}^{|\alpha_{t+1}|} \left\{ e^{\frac{i\pi\alpha_t}{2k\alpha_{t+1}} \left(2kv+m+\frac{n}{\alpha_t}\right)^2} - e^{\frac{i\pi\alpha_t}{2k\alpha_{t+1}} \left(2kv+m-\frac{n}{\alpha_t}\right)^2} \right\}. \quad (7.42)$$

In terms of the variable $s = 2kv + m$, equation (7.42) can be rewritten in the form (7.33) and this concludes the proof. \square

From the definition (7.23) and Lemma 7.1 it follows

Theorem 7.2

Let $SU(2)$ be the gauge group, the 3-manifolds invariant $I_k(L_{p/r})$ for $k \geq 2$

is given by

$$I_k(L_{p/r}) = \sum_{s \pmod{p}} \left\{ \exp \left[\frac{i\pi(r+1)^2}{2pkr} \right] \exp \left[\frac{i2\pi}{p} [rks^2 + (r+1)s] \right] - \exp \left[\frac{i\pi(r-1)^2}{2pkr} \right] \exp \left[\frac{i2\pi}{p} [rks^2 + (r-1)s] \right] \right\} \frac{e^{i\theta_k \sigma(\mathcal{L})} B_d}{a_k}. \quad (7.43)$$

Proof According to equation (7.23), the expression for the matrix element $[F(p/r)]_{11}$ has been written by means of a sum over a complete residue system modulo p . \square

As shown in equation (7.43), the expression for $I_k(L_{p/r})$ is rather involved; nevertheless, $|I_k(L_{p/r})|^2$ can be computed explicitly. Let us introduce the modulo- p Kronecker delta symbol defined by

$$\delta_p(x) = \begin{cases} 0 & x \not\equiv 0 \pmod{p} \\ 1 & x \equiv 0 \pmod{p} \end{cases}; \quad (7.44)$$

where p and x are integers. One can easily verify that, for integer n ,

$$\begin{cases} \delta_p(xn) = \delta_p(x) & \text{if } (n, p) = 1 \\ \delta_{pn}(xn) = \delta_p(x) & \end{cases}. \quad (7.45)$$

Finally, we shall denote by $\phi(n)$ the Euler function [53] which is equal to the number of residue classes modulo n which are coprime with n .

Theorem 7.3

The square of the absolute value of $I_k(L_{p/r})$ is given in the following list ;

for $p = 2$

$$|I_k(L_{2/1})|^2 = \left[1 + (-1)^k \right] \frac{\sin^2 [\pi/(2k)]}{\sin^2 [\pi/k]}; \quad (7.46)$$

for $p > 2$ one has :

when p and k are coprime integers, i.e. $(k, p) = 1$,

$$|I_k(L_{p/r})|^2 = \frac{1}{2} [1 - (-1)^p] \frac{\sin^2 [\pi (k^{\phi(p)} - 1)/(kp)]}{\sin^2(\pi/k)} + \frac{1}{2} [1 + (-1)^p] \left[1 + (-1)^{p/2} \right] \frac{\sin^2 [\pi (k^{\phi(p/2)} - 1)/(kp)]}{\sin^2(\pi/k)}; \quad (7.47)$$

when the greatest common divisor of p and k is greater than unity, i.e. $(k, p) = g > 1$ and p/g is odd

$$|I_k(L_{p/r})|^2 = \frac{g}{4 \sin^2(\pi/k)} [\delta_g(r-1) + \delta_g(r+1)] \quad ; \quad (7.48)$$

when $(k, p) = g > 1$ and p/g is even

$$|I_k(L_{p/r})|^2 = \frac{g}{4 \sin^2(\pi/k)} \left\{ \delta_g(r+1) \left[1 + (-1)^{kp/2g^2} (-1)^{(r+1)/g} \right] + \delta_g(r-1) \left[1 + (-1)^{kp/2g^2} (-1)^{(r-1)/g} \right] \right\} \quad . \quad (7.49)$$

Proof From Theorem 7.2 it follows that the square of the absolute value of the lens space invariant is

$$|I_k(L_{p/r})|^2 = a(k)^{-2} (2kp)^{-1} \mathcal{S}(k, p, r) \quad , \quad (7.50)$$

with

$$\begin{aligned} \mathcal{S}(k, p, r) = & \sum_{s, t \pmod{p}} \left\{ \exp \left\{ \frac{i2\pi}{p} [kr(s^2 - t^2) + (r+1)(s-t)] \right\} \right. \\ & - \exp \left(\frac{i2\pi}{kp} \right) \exp \left\{ \frac{i2\pi}{p} [kr(s^2 - t^2) + r(s-t) + s+t] \right\} \\ & - \exp \left(-\frac{i2\pi}{kp} \right) \exp \left\{ \frac{i2\pi}{p} [kr(s^2 - t^2) + r(s-t) - s-t] \right\} \\ & \left. + \exp \left\{ \frac{i2\pi}{p} [kr(s^2 - t^2) + (r-1)(s-t)] \right\} \right\} \quad . \quad (7.51) \end{aligned}$$

The indices s and t run over a complete residue system modulo p . When $p = 2$, each sum contains only two terms and the evaluation of (7.51) is straightforward; the corresponding result is shown in equation (7.46). Let us now consider the case in which $p > 2$. By means of the change of variables $s \rightarrow s+t$, the sum in t becomes a geometric sum and one obtains

$$\begin{aligned} \mathcal{S}(k, p, r) = & p \sum_{s \pmod{p}} \left\{ \exp \left\{ \frac{i2\pi}{p} [krs^2 + (r+1)s] \right\} \delta_p(2krs) \right. \\ & - \exp \left(\frac{i2\pi}{kp} \right) \exp \left\{ \frac{i2\pi}{p} [krs^2 + (r+1)s] \right\} \delta_p(2krs + 2) \\ & - \exp \left(-\frac{i2\pi}{kp} \right) \exp \left\{ \frac{i2\pi}{p} [krs^2 + (r-1)s] \right\} \delta_p(2krs - 2) \\ & \left. + \exp \left\{ \frac{i2\pi}{p} [krs^2 + (r-1)s] \right\} \delta_p(2krs) \right\} \quad . \quad (7.52) \end{aligned}$$

By using properties (7.45), one can determine the values of s which give contribution to (7.52). Let us start with $(k, p) = 1$. Clearly, in this case one has

$$\delta_p(2krs) \neq 0 \Rightarrow \begin{cases} s = p & p \text{ odd} \\ s = p, p/2 & p \text{ even} \end{cases} \quad . \quad (7.53)$$

When $(k, p) = 1$ and p is odd, one gets

$$\delta_p(2krs \mp 2) = \delta_p(krs \mp 1) \quad . \quad (7.54)$$

The delta function gives a non-vanishing contribution if and only if the following congruence is satisfied

$$rks = \pm 1 \pmod{p} \quad . \quad (7.55)$$

The unique solution [53] to (7.55) is given by

$$s = \pm (rk)^{\phi(p)-1} \quad . \quad (7.56)$$

When $(k, p) = 1$ and p is even, one finds two solutions

$$s_1 = \pm (rk)^{\phi(p/2)-1} \quad , \quad s_2 = \pm (rk)^{\phi(p/2)-1} + p/2 \quad . \quad (7.57)$$

Let us now examine the case $(p, k) = g > 1$. We introduce the integer β defined by $p = g\beta$. For β odd, one has

$$\delta_p(2krs) = \delta_\beta(s) \quad . \quad (7.58)$$

Within the residues of a complete system modulo p , the values of s giving non-vanishing contribution are of the form $s = \alpha\beta$ with $1 \leq \alpha \leq g$. When β is even, one gets

$$\delta_p(2krs) = \delta_\beta(2s) = \delta_{\beta/2}(s) \quad . \quad (7.59)$$

The solutions of the associated congruence are

$$s = \alpha \frac{\beta}{2} \quad 1 \leq \alpha \leq 2g \quad . \quad (7.60)$$

When $(k, p) = g > 1$ and p is odd, $\delta_p[2r(ks \pm 1)]$ does not contribute because $rks = \pm 1 \pmod{p}$ has no solutions. On the other hand, if p is even we have

$$\delta_p[(2rks \pm 2)] = \delta_{p/2}(rks \pm 1) \quad . \quad (7.61)$$

The delta function (7.61) is non-vanishing when $(p/2, k) = 1$ and, in this case, the two solutions are $s_1 = \pm (rk)^{\phi(p/2)-1}$ and $s_2 = s_1 + p/2$. This exhausts the analysis of the modulo p Kronecker deltas when $p > 2$.

At this stage, Theorem 7.3 simply follows from the substitution of the values of s for which the various Kronecker deltas modulo p are non vanishing. In the case $(k, p) = 1$ and p odd, the algebraic manipulations are straightforward. When $(k, p) = 1$ and p even, the evaluation of (7.52) needs some care. In this case, one has to deal with factors of the form

$$\exp \left[\frac{i\pi}{b} (a^{\phi(b)} - 1) \right] \quad ; \quad (7.62)$$

with $b > 2$ even and $(a, b) = 1$. In Appendix C.6, it is shown that terms of the type (7.62) are trivial because actually

$$a^{\phi(b)} \equiv 1 \pmod{2b} \quad . \quad (7.63)$$

Finally, the derivation of equations (7.48) and (7.49) is straightforward. \square

Let us now consider the dependence of $|I(L_{p/r})|^2$ on r . As shown in equations (7.48) and (7.49), $|I(L_{p/r})|^2$ depends on r . However, this dependence is rather peculiar: when $I(L_{p/r}) \neq 0$,

$|I(L_{p/r})|^2$ does not depend on r . Indeed, when expression (7.48) is different from zero, its values are given by

$$0 \neq (7.48) = \begin{cases} \sin^{-2}(\pi/k) & \text{for } g = 2; \\ (g/4) \sin^{-2}(\pi/k) & \text{for } g > 2. \end{cases} \quad (7.64)$$

Similarly, when expression (7.49) is different from zero, its value is given by

$$0 \neq (7.49) = \frac{g}{2 \sin^2(\pi/k)}. \quad (7.65)$$

To sum up, when $I(L_{p/r}) \neq 0$, $|I(L_{p/r})|^2$ only depends on p and, therefore, it is a function of the fundamental group $\pi_1(L_{p/r}) = Z_p$. Thus, Theorem 7.3 proves the validity of our conjecture for the lens spaces when the gauge group is $SU(2)$.

7.4.4 The $SU(3)$ case

In this section we shall present numerical computations confirming the validity of our conjecture for lens spaces when the gauge group is $SU(3)$. As in the $SU(2)$ case, the $SU(3)$ Chern-Simons field theory can be solved explicitly in any closed, connected and orientable three-manifold [33, 36]. The general surgery rules for $SU(3)$ and for any integer k have been derived in [36]. In particular, it turns out that

$$I_{k=1}(L_{p/r}) = [I_{k=2}(L_{p/r})]^* = I_{k=4}(L_{p/r}) \quad . \quad (7.66)$$

Therefore, we only need to consider the case $k \geq 3$. For $k \geq 3$, the matrices which give a projective representation of the modular group have the following form

$$X_{(m,n)(a,b)} = \frac{i}{k\sqrt{3}} q^{-2} q^{-[(m+n)(a+b+3)+(m+3)b+(n+3)a]/3} \\ \left[\begin{array}{l} 1 + q^{(n+1)(a+b+2)+(m+1)(b+1)} + q^{(m+1)(a+b+2)+(n+1)(a+1)} \\ - q^{(m+1)(b+1)} - q^{(n+1)(a+1)} - q^{(m+n+2)(a+b+2)} \end{array} \right] ; \quad (7.67)$$

$$Y_{(a,b)(m,n)} = q^{[m^2+n^2+mn+3(m+n)]/3} \delta_{am} \delta_{bn} \quad ; \quad (7.68)$$

$$C_{(a,b)(m,n)} = \delta_{an} \delta_{bm} \quad ; \quad (7.69)$$

where each irreducible representation of $SU(3)$ has been denoted by a couple of nonnegative integers (m, n) (Dynkin labels).

By using equation (7.21), we have computed $I_k(L_{p/r})$ numerically for some examples of lens spaces. In particular, we have worked out the value of the invariant for the lens spaces $L_{p/r}$, with $p \leq 20$ and $3 \leq k \leq 50$. In all these cases, the results are in agreement with our conjecture.

Our calculations have been performed on a Pentium based PC running Linux. For instance, the results of the computations for the cases $L_{8/1}$, $L_{8/3}$, $L_{15/1}$, $L_{15/2}$, $L_{15/4}$ with $3 \leq k \leq 50$ are shown in Tables 1, 2, 3, 4, 5. The spaces $L_{8/1}$ and $L_{8/3}$ are not homotopically equivalent; as shown in Tables 1 and 2, the phase of the invariant distinguishes these two manifolds. The case in which $p = 15$ is more interesting because there are two different spaces belonging to the same homotopy class; $L_{15/1}$ and $L_{15/4}$ are homotopically equivalent and $L_{15/2}$ represents the other homotopy class. The phase of the invariant distinguishes the manifolds of the same homotopy class.

7.4.5 Discussion

In this Section, we have presented some arguments and numerical results supporting the conjecture that, for non-vanishing $I(\mathcal{M})$, the absolute value $|I(\mathcal{M})|$ only depends on the fundamental group $\pi_1(\mathcal{M})$. Since the Turaev-Viro invariant [45] coincides [12] with $|I(\mathcal{M})|^2$, our conjecture gives some hints on the topological interpretation of the Turaev-Viro invariant. For the gauge group $SU(2)$, $|I(\mathcal{M})|^2$ can be understood as the improved partition function of the Euclidean version of (2+1) gravity with positive cosmological constant [54, 55]. In this case, our conjecture suggests that, for instance, the semi-classical limit is uniquely determined by the fundamental group of the universe.

Finally, one may ask for which values of k the equality $I_k(\mathcal{M}) = 0$ is satisfied and what is the meaning of this fact. The complete solution to this problem is not known. From the field theory point of view, gauge invariance of the factor $\exp(iS_{CS})$ (where S_{CS} is the Chern-Simons action) in the functional measure gives nontrivial constraints on the admissible values of k in a given manifold \mathcal{M} . In certain cases one finds that, in correspondence with the “forbidden” values of k , the invariant $I_k(\mathcal{M})$ vanishes. So, it is natural to expect that $I_k(\mathcal{M}) = 0$ is related to a breaking of gauge invariance for large gauge transformations. From the mathematical point of view, $I_k(\mathcal{M}) = 0$ signals the absence of the natural extension of $E(\mathcal{L})$ to an invariant $E_{\mathcal{M}}(\mathcal{L})$ of links in the manifold \mathcal{M} . More precisely, when $I_k(\mathcal{M}) \neq 0$ for fixed integer k , one can define an invariant $E_{\mathcal{M}}(\mathcal{L})$ of oriented, framed and coloured links $\{\mathcal{L} \subset \mathcal{M}\}$ with the following property: if the link \mathcal{L} belongs to a three-ball embedded in \mathcal{M} , then one has $E_{\mathcal{M}}(\mathcal{L}) = E(\mathcal{L})$. The values of the invariant $E_{\mathcal{M}}(\mathcal{L})$ correspond to the vacuum expectation values of the Wilson line operators associated with links in the manifold \mathcal{M} . When $I_k(\mathcal{M}) = 0$, the invariant $E_{\mathcal{M}}(\mathcal{L})$ cannot be constructed; consequently, for these particular values of k , the quantum Chern-Simons field theory is not well defined in \mathcal{M} .

Chapter 8

Three-dimensional field theory vs two-dimensional conformal field theory

8.1 Introduction

In his remarkable paper [57] on quantum field theory and the Jones polynomials, Witten argued how to solve the three-dimensional Chern-Simons (CS) theory by using certain results of two-dimensional conformal field theory (CFT). The basic ingredient entering his construction is the S matrix representing the modular transformation $\tau \rightarrow -1/\tau$ in the WZNW model [58, 59].

Alternatively, one can solve, following the way discussed in the previous chapters, the CS model by using the properties of the quantum field theory which are determined by the three-dimensional action principle. In this second approach, the existing connections between the three-dimensional topological field theory and certain properties of two-dimensional CFT are found a posteriori. In particular, all the relations satisfied by the S matrix admit an interpretation in terms of three-dimensional topology. In this chapter we shall describe the topological origin of these relations.

Let us briefly recall some results obtained in CFT, a more detailed discussion can be found in App.D and in the references contained therein. For simplicity, we shall concentrate on the two-dimensional conformal WZNW model. The fusion rules, which are defined in terms of the OPE of primary fields, are summarized by [60]

$$\phi_i \times \phi_j = \sum_m C_{ij}^m \phi_m \quad . \quad (8.1)$$

Following the notations of Ref. [61], we shall denote by S and T the generators of the modular group acting on the linear space of the characters of the chiral symmetry algebra. Verlinde conjectured [61] that the modular transformation represented by S diagonalizes the the fusion rules,

$$C_{ij}^m = \sum_n \frac{S_i^n S_j^n S_n^{\dagger m}}{S_0^n} \quad . \quad (8.2)$$

The analytic conformal blocks can be considered [62] as holomorphic sections of a vector bundle $V_{g,n}$ over the moduli space of the n -punctured Riemann surface of genus g . As shown by Verlinde in the case $n = 0$, the dimension of $V_{g,0}$ can be expressed as

$$\dim V_{g,0} = \sum_n (S_{n0})^{2(1-g)} \quad . \quad (8.3)$$

This equation can be generalized to the case of punctured Riemann surface; in particular, one has [63]

$$\dim V_{g,1}(i) = \sum_n (S_{n0})^{(1-2g)} S_{in} \quad . \quad (8.4)$$

We shall use three-dimensional quantum field theory arguments exclusively; all the results we shall obtain are consequences of the properties of the vacuum expectation values of the CS observables. Firstly, we shall explain why the fusion algebra of two-dimensional CFT is isomorphic with the algebra defined by the gauge invariant observables of the CS theory. Secondly, we shall derive equations (8.2)-(8.4).

8.2 Fusion algebra and reduced tensor algebra

The analytic correlation functions of primary fields in the conformal WZNW model have monodromy properties described by the Knizhnik-Zamolodchikov equation [59]. The associated braid group representations have been studied in great details; as shown by Kohno [48], these monodromy representations are equivalent to the R -matrix representations defined in terms of the so-called quantum deformations of the simple Lie algebras. On the other hand, the skein relations satisfied by the expectation values of the CS theory can be associated with braid group representations which, again, are equivalent to the R -matrix representations [31]. Thus, the braiding structures which are found in conformal field theory, in the quantum group approach and in the CS theory coincide. In fact, as shown by Drinfeld, the braid representations determined by the quasi-tensor category associated with the quasi-triangular quasi-Hopf algebras are universal [64].

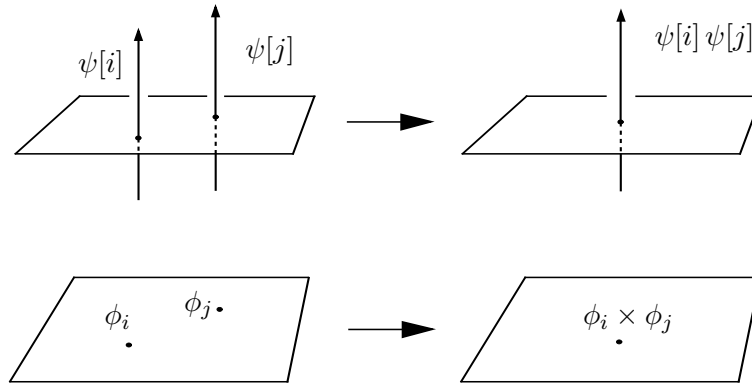

Figure 8.1

As shown in Fig.8.1, the fusion rules of the CFT correspond to the algebraic structure of the satellite relations in the three-dimensional CS theory.

In our context, Drinfeld’s universality theorem implies that the fusion algebra of the $SU(N)_\ell$ WZNW model of level ℓ is isomorphic with the reduced tensor algebra $\mathcal{T}_{(k)}$ of the $SU(N)$ CS theory with $k = \ell + N$. The proof is based on the following considerations. The Knizhnik-Zamolodchikov equation [59] in the WZNW model determines a flat connection of the type considered by Kohno; moreover, the Sugawara form of the energy-momentum tensor implies that the resulting deformation parameter q_W is given by

$$q_W = \exp [-i2\pi/(\ell + N)] \quad . \quad (8.5)$$

The fusion algebra is generated by a primary field ϕ_N associated with the fundamental representation of $SU(N)$; therefore, the monodromy properties of a generic correlator of primary fields are determined by the correlators of ϕ_N . With the value (8.5) of the deformation parameter, the fusion rules close on a finite set of conformal blocks which are labeled by certain irreducible representations of $SU(N)$.

In the $SU(N)$ CS theory, the deformation parameter q is

$$q = \exp(-i2\pi/k) \quad . \quad (8.6)$$

The components of the links are labeled by the irreducible representations of $SU(N)$. In Sect. we have seen that the value of any observable associated with generic representations of $SU(N)$ is uniquely determined by the set of observables associated with the fundamental representation of $SU(N)$. The three-dimensional counterpart of the fusion property of the primary fields is represented by the structure of the satellite relations. By comparing the deformation parameters of the conformal theory and of the CS theory, one finds that they coincide when $k = \ell + N$. With this fixed integer value of k , see Chap.4, the algebraic structures associated with the satellite relations of the CS theory close on a finite set of physically inequivalent representations. These representations identify the equivalence classes belonging to the reduced tensor algebra $\mathcal{T}_{(k)}$. The structure constants of $\mathcal{T}_{(k)}$ characterize the satellite relations and then they correspond to the fusion rules of the conformal theory. Therefore, the fusion algebra of the conformal theory with level ℓ must be isomorphic with the reduced tensor algebra $\mathcal{T}_{(k=\ell+N)}$.

In the case in which the gauge group is $SU(2)$, the equivalence between the structure constants of the reduced tensor algebra $\mathcal{T}_{(k=\ell+2)}$ and the fusion rules of the $SU(2)_\ell$ WZNW model has been established explicitly [30]. When $G = SU(3)$, one can verify that, for any fixed level ℓ , the fusion algebra of the WZNW model is isomorphic with the $SU(3)$ reduced tensor algebra $\mathcal{T}_{(k=\ell+3)}$ [33].

It should be noted that the relation between the two-dimensional WZNW model and the three-dimensional CS theory only concerns the algebraic structure of the monodromies or, equivalently, of the braid group representations. In fact, the physical contents of the two theories are completely different. For example, the Hamiltonian of the WZNW model is not vanishing, whereas the Hamiltonian of the CS theory is vanishing (after gauge fixing, the Hamiltonian of the CS theory is a BRS-variation). Differently from the WZNW model, in the CS theory there are no propagating physical degrees of freedom.

To sum up, the isomorphism between the fusion algebras of the conformal models and the reduced tensor algebras of the CS theory makes clear the role played by the representation ring of the groups in the derivation of the fusion rules. Actually, this isomorphism can also be used to compute the fusion rules.

8.3 Modular group

In this section, we shall show that a projective representation of the modular group is defined on $\mathcal{T}_{(k)}$; we shall also derive the Verlinde formula (8.2). The two $D \times D$ -matrices representing the generators of the modular group will be denoted by $\{X, Y\}$, where X corresponds to the S matrix of the conformal models and Y is the analogue of the T matrix. The X matrix is introduced according to

$$X_{ij} = \frac{H[i, j]}{\langle W(U; \Psi_0) \rangle_{S^3}} = a^{(k)} H[i, j] \quad . \quad (8.7)$$

As we have already mentioned, an elementary $+1$ modification of the framing of a link component with colour $\psi[i]$ is represented in $\mathcal{T}_{(k)}$ by

$$\psi[i] \rightarrow q^{Q^{(i)}} \psi[i] \quad . \quad (8.8)$$

Therefore, we shall define the Y matrix as

$$Y_{ij} = q^{Q(i)} \delta_{ij} \quad . \quad (8.9)$$

Finally, we shall denote by C the “charge conjugation” matrix

$$C_{ij} = \delta_{ij^*} \quad . \quad (8.10)$$

Theorem 8.1

The matrices $\{X, Y, C\}$ satisfy the relations

$$X^2 = C \quad ; \quad (8.11)$$

$$(XY)^3 = e^{-i\theta} C \quad . \quad (8.12)$$

Proof Equation (8.11) follows from Theorem 6.6. Indeed, by setting $m = 1$ in equation (6.113), one finds

$$N_{ij1} = a(k) \langle W(U; \Psi_0) W(C_1; \psi[i]) W(C_2; \psi[j]) \rangle_{S^3} \quad , \quad (8.13)$$

where the link components $\{U, C_1, C_2\}$ are shown in Figure 8.2.

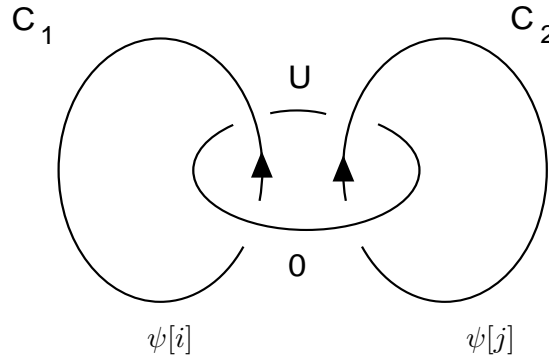

Figure 8.2

By using the connected sum rule, Eq. (8.13) can be rewritten as

$$\begin{aligned} N_{ij1} = \delta_{ij^*} = C_{ij} &= a(k)^2 \sum_m H[i, m] H[m, j] \\ &= (X^2)_{ij} \quad , \end{aligned} \quad (8.14)$$

which shows that eq. (8.11) is satisfied.

In order to prove equation (8.12), let us decompose $(XY)^3$ as

$$(XY)_{ij}^3 = \sum_m (XYX)_{im} (YXY)_{mj} \quad . \quad (8.15)$$

By using the connected sum rule, one can represent $a(k) (XYX)_{im}$ by means of the CS observable associated with the link in S^3 shown in Figure 8.3.

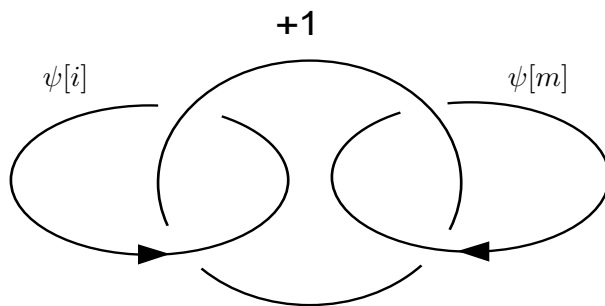

Figure 8.3

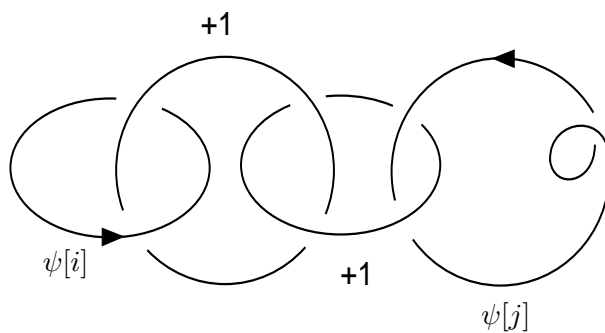

Figure 8.4

From the definitions (8.7) and (8.9) it follows that

$$(YXY)_{mj} = a(k) q^{[Q(m)+Q(j)]} H[m, j] \quad . \quad (8.16)$$

Consequently, the whole matrix $a(k) (XY)_{ij}^3$ can be represented by the expectation value of the observable depicted in Figure 8.4.

From the property of the surgery discussed in Sect.6-2 and Sect.6.5, it follows that the effect produced by the surgery operator associated with the unknot can be represented as in Fig.8.5. Thus, by using the relation shown in Fig.8.5, one finds that the link of Figure 8.4 is equivalent to the link shown in Figure 8.6.

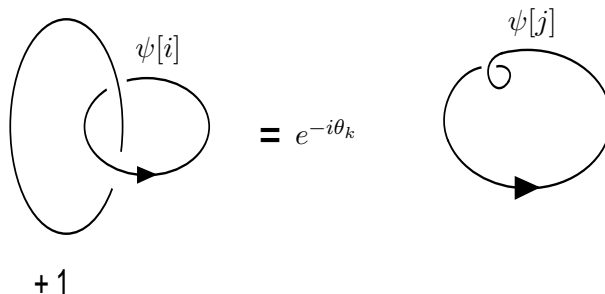

Figure 8.5

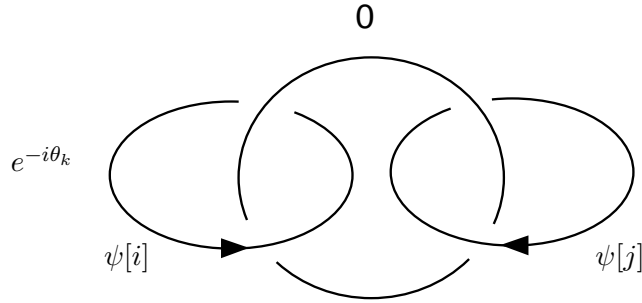

Figure 8.6

At this stage, from the satellite relation (2.32) and Theorem 6.5, it follows that

$$(XY)_{ij}^3 = e^{-i\theta_k} \delta_{ij^*} = e^{-i\theta} C_{ij} \quad ; \tag{8.17}$$

this concludes the proof of equation (8.12). □

By means of the matrices $\{ X , Y , C \}$, which give the projective representation (8.11) and (8.12) of the modular group, one can easily construct a representation of the modular group in agreement with the standard conventions of CFT.

Let us now derive the Verlinde formula (8.2). According to Theorem 6.6, the structure constants $\{ N_{ijm} \}$ of the reduced tensor algebra $\mathcal{T}_{(k)}$ are given by the expectation value in $S^2 \times S^1$ of the CS observable associated with the link components $\{ C_1, C_2, C_3 \}$ shown in Figure 6.19. The whole link of Figure 6.19 is defined in S^3 and has four components because one component represents a surgery instruction; this link can be understood as a (double) connected sum of three Hopf links. Thus, by using the connected sum rule (2.40), one finds

$$N_{ijm^*} = a(k)^2 \sum_n (E_0[n])^{-1} H[i, n] H[j, n] H[m, n] \quad . \tag{8.18}$$

Let us recall that each link component with colour $\psi[1]$ can be eliminated; consequently, one has $H[1, n] = E_0[n]$. By taking into account the definition (8.7) of the X matrix, equation (8.18) can be written as

$$N_{ijm^*} = \sum_n \frac{X_{in} X_{jn} X_{mn}}{X_{1n}} \quad . \tag{8.19}$$

Equation (8.19) coincides with the Verlinde formula (8.2).

8.4 Punctured Riemann surfaces

In order to derive equations (8.3) and (8.4), one needs to find the three-dimensional counterpart of the dimensions of the bundles $V_{g,n}$. The braiding properties of the correlators of primary fields on a Riemann surface Σ_g of genus g coincide with the braiding properties of Wilson line operators associated with links which are defined in the three-manifold $\Sigma_g \times S^1$ and whose components run along the “time” direction determined by the S^1 component of the manifold. By using Dehn’s surgery on S^3 , one can easily produce a surgery presentation of these links in $\Sigma_g \times S^1$. The analogue of $\dim V_{g,0}$ is represented by the CS “partition function” in $\Sigma_g \times S^1$; whereas, $\dim V_{g,n}$ corresponds

to the (properly normalized) expectation value in $\Sigma_g \times S^1$ of the Wilson operator associated with links describing n static punctures on Σ_g . Let us now recall how the manifold $\Sigma_g \times S^1$ can be represented [46] by means of Dehn's surgery on S^3 . Since we wish to consider arbitrary values of the genus g , it is convenient to start with the manifold $S^2 \times S^1 \equiv \Sigma_0 \times S^1$ and give a constructive method to “add handles” to it.

In two dimensions, the Riemann surface Σ_g can be constructed by adding g handles to the sphere S^2 . As shown in Figure 8.7, adding one handle to a Riemann surface is equivalent to introduce two surgery punctures on it. Equivalently, by fusing these two punctures, adding one handle to Σ_g is equivalent to introduce a single surgery puncture on Σ_g .

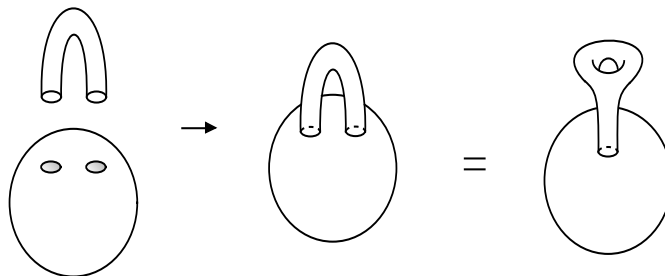

Figure 8.7

Let us now consider the construction of $\Sigma_g \times S^1$ by adding handles in the three-dimensional context. The starting manifold is $S^2 \times S^1$ which corresponds to the surgery link given by the unknot U in S^3 with surgery coefficient $r = 0$. The operation of adding one handle can be represented [46] (in the three-dimensional context) by the introduction of two new surgery components with vanishing surgery coefficients; these two components must be added to the unknot U as shown in Figure 8.8. The surgery link of Figure 8.8 is defined in S^3 and corresponds to manifold $\Sigma_1 \times S^1$.

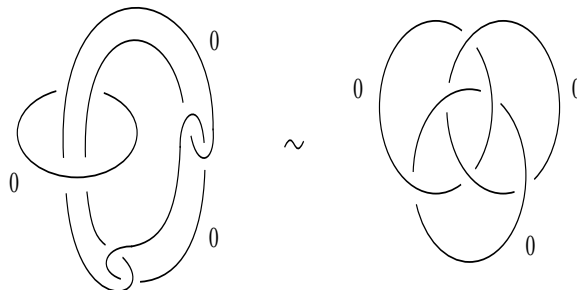

Figure 8.8

For each handle, one has to introduce a copy of the two surgery components (with vanishing surgery coefficients) mentioned before. One can imagine that these two surgery components belong to a solid torus standardly embedded in S^3 ; inside this solid torus, these two components define a link

which will be called P . The two components of P have colour given by Ψ_0 . In agreement with equation (4.16), the Wilson line operator associated with the coloured link P , which belongs to the complement solid torus N of the unknot U in S^3 , can be decomposed as

$$W(P; \Psi_0, \Psi_0) = W(K; \psi_h) \quad , \tag{8.20}$$

where K is the core of N , shown in Figure 8.9, and

$$\psi_h = \sum_i \eta(i) \psi[i] \quad . \tag{8.21}$$

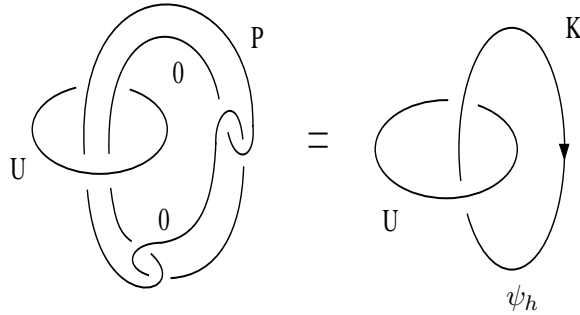

Figure 8.9

The coefficients $\{ \eta(i) \}$ give the decomposition of the surgery operator, which represent one handle, in terms of a single coloured link component. Consequently, adding g handles to $S^2 \times S^1$ is equivalent to adding g new components with colour ψ_h to the unknot with surgery coefficient $r = 0$. The introduction of the surgery operator $W(P; \Psi_0, \Psi_0)$ by means the decomposition (8.20) is the analogue of the introduction (in two dimensions) of a single surgery puncture on S^2 . In order to compute the expectation values of observables in $\Sigma_g \times S^1$, the knowledge of $\{ \eta(i) \}$ is crucial. Quite remarkably, the topological properties of the one handle surgery operator are encoded entirely in the structure constants of $\mathcal{T}_{(k)}$.

Theorem 8.2 *The coefficients $\{ \eta(i) \}$ are given by*

$$\eta(i) = \sum_j N_{jj^*i} \quad . \tag{8.22}$$

Proof Suppose that a Wilson line operator is associated with the component U , shown in Figure 8.9, with colour $\psi[j]$. The expectation value in S^3 of the observable associated with P and U can be expressed as shown in Figure 8.10.

In the last step of Fig. 8.10, we have used the relation between tangles shown in Figure 8.11; this relation can easily be understood by using the following argument.

Let us first consider the tangle on the left-hand-side of Figure 8.11. From Theorem 6.5, we know that the operator associated with the unknot with colour Ψ_0 selects, among all the possible physical

$$\begin{aligned}
 \sum_i \eta(i) H[i, j] &= \text{Diagram 1} \\
 &= \frac{1}{a(k)} \sum_m E_0[m] \text{Diagram 2} \\
 &= \sum_m \text{Diagram 3}
 \end{aligned}$$

Figure 8.10

states running along the core of the solid torus N determined by the complement of the unknot in S^3 , the element $\psi[1]$. The tangle appearing on the right-hand-side of Figure 8.11 (understood as subset of the same solid torus N) contains, as propagating state along the core of the solid torus, only $\psi[1]$. Therefore, the two tangles must be proportional. The normalization constant can be determined by taking the closure of both tangles; the result is shown in Figure 8.11.

From Figure 8.10 and the satellite relation (2.32), it follows that

$$\sum_i \eta(i) H[i, j] = \sum_{m,n} N_{mm^*n} H[n, j] \quad . \quad (8.23)$$

Let us recall that, when the reduced tensor algebra is regular, the Hopf matrix H is invertible and, in particular, from eq.(8.11) one obtains

$$H^{-1}[i, j] = a(k)^2 H[i, j^*] \quad . \quad (8.24)$$

Thus, the solution of the linear system (8.23) is given by eq. (8.22). □

By using the Verlinde formula (8.19) and $X^2 = C$, the η -coefficients can also be expressed as

$$\eta(i) = \sum_n \frac{X_{ni^*}}{X_{1n}} = \sum_n \frac{H[n, i^*]}{E_0[n]} \quad . \quad (8.25)$$

In conclusion, the surgery link in S^3 corresponding to the manifold $\Sigma_g \times S^1$ is shown in Figure 8.12. This link has $(g + 1)$ components; one component is the unknot with surgery coefficient $r = 0$ and the remaining g components, which have colour ψ_h , represent the g handles which must be added to $S^2 \times S^1$.

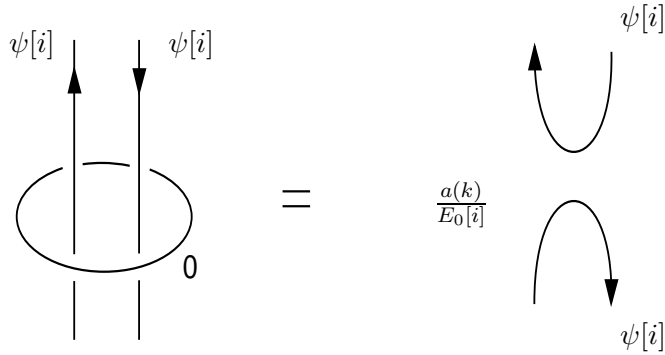

Figure 8.11

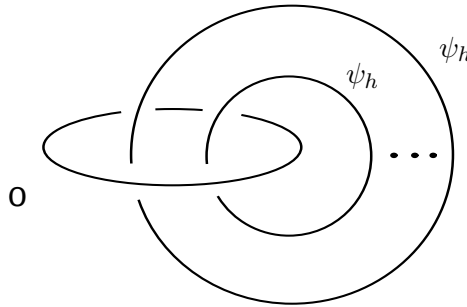

Figure 8.12

8.5 Dimensions of the physical state spaces

Let us consider the CS theory defined in $\Sigma_g \times S^1$; the S^1 component of the manifold can be interpreted as a compactified time-interval. Since the CS Hamiltonian is vanishing on the *physical* state space $\mathcal{H}(g)$ of the theory, the partition function of the CS theory defined in $\Sigma_g \times S^1$ is proportional to the dimension of $\mathcal{H}(g)$. The dimension of $\mathcal{H}(g)$ is equal [46] to the number of independent generalized characters of the corresponding CFT on Σ_g , i.e. $\dim \mathcal{H}(g) = \dim V_{g,0}$. In order to find the proportionality constant between $\dim \mathcal{H}(g)$ and $\mathcal{I}(\Sigma_g \times S^1)$, we note that, as a consequence of Theorem 6.5, one has

$$\dim \mathcal{H}(g = 0) = 1 \quad . \tag{8.26}$$

Therefore, there exists the following relation between $\dim \mathcal{H}(g)$ and the 3-manifold invariant $\mathcal{I}(\Sigma_g \times S^1)$ introduced in Chap.7

$$\begin{aligned} \dim \mathcal{H}(g) &= \frac{\mathcal{I}(\Sigma_g \times S^1)}{\mathcal{I}(S^2 \times S^1)} \\ &= \frac{\langle W(U; \Psi_0) W(C_1; \psi_h) W(C_2; \psi_h) \cdots W(C_g; \psi_h) \rangle_{S^3}}{\langle W(U; \Psi_0) \rangle_{S^3}} \quad . \end{aligned} \tag{8.27}$$

The numerator appearing in eq.(8.27) is the expectation value of the surgery operator describing $\Sigma_g \times S^1$ and the denominator is the expectation value of the surgery operator associated with $S^2 \times S^1$.

We have denoted by $\{C_1, C_2, \dots, C_g\}$ the surgery components, representing the g handles, shown in Figure 8.12.

In order to obtain a general formula for $\dim \mathcal{H}(g)$, we shall now derive a rule which allows us to eliminate the surgery components $\{C_1, C_2, \dots, C_g\}$. Let us consider the Hopf link in S^3 with components U and C . Let the U component be coloured with a generic element $\zeta \in \mathcal{T}_{(k)}$ and the C component with ψ_h . By using the connected sum rule (2.40), we have

$$\begin{aligned}
 \langle W(U, C; \zeta, \psi_h) \rangle|_{S^3} &= \sum_{i,j} H[i^*, j] E_0^{-1}[j] \langle W(U, C; \zeta, \psi[i]) \rangle|_{S^3} \\
 &= \sum_{i,j} \langle W(H\#H; \zeta, \psi[i], \psi[j]) \rangle|_{S^3} E_0[i] E_0^{-1}[j] \\
 &= a(k) \sum_j \langle W(H\#H; \zeta, \Psi_0, \psi[j]) \rangle|_{S^3} E_0^{-1}[j] \\
 &= \langle W(H\#H; \zeta, \Psi_0, \varphi) \rangle|_{S^3} \quad ; \tag{8.28}
 \end{aligned}$$

where $\varphi = a(k) \sum_m E_0^{-1}[m] \psi[m]$. The link $H\#H$ is the connected sum of two Hopf links shown in Figure 8.13.

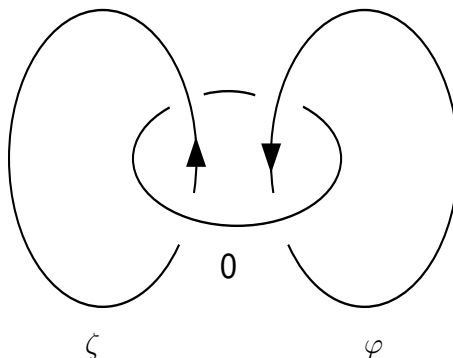

Figure 8.13

Equation (8.28) implies [36]) the relation between tangles shown in Figure 8.14.

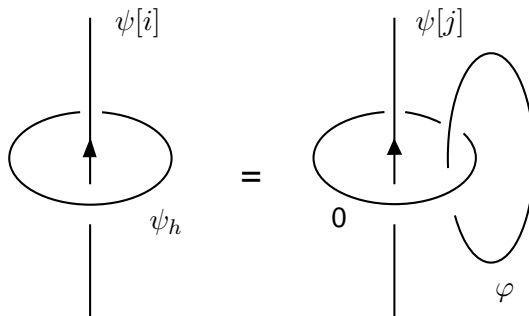

Figure 8.14

On the other hand, the tangle identity of Figure 8.15 also holds [36]

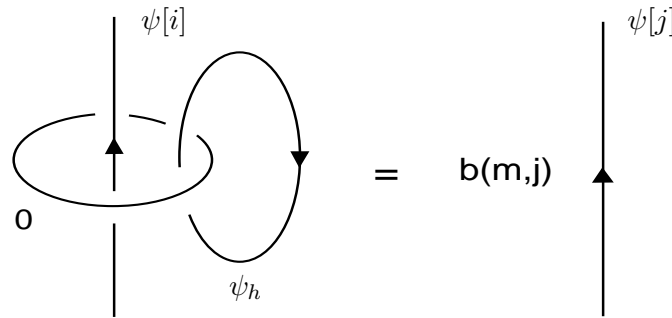

Figure 8.15

The coefficient $b(m, j)$ can be easily determined by closing the tangles shown in Figure 8.15 and by using Theorem 6.5. Thus one gets

$$b(m, j) = a(k) E_0^{-1}[j] \delta_{jm^*} \quad . \tag{8.29}$$

We can now use the decomposition of Figure 8.15 to recast the tangle shown in Figure 8.14 in the form shown in Figure 8.16.

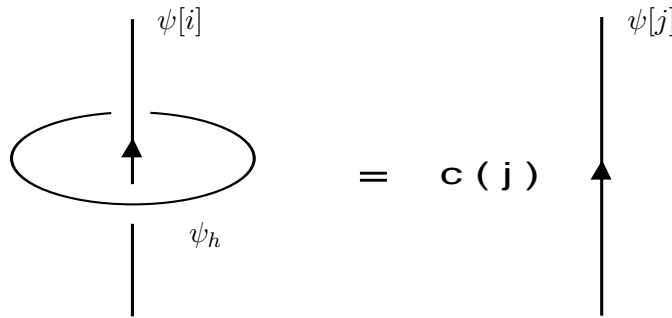

Figure 8.16

The coefficient $c(j)$ which appears in Figure 8.16 is given by

$$c(j) = \frac{a^2(k)}{E_0^2[j]} \quad . \tag{8.30}$$

To sum up, the relation shown in Figure 8.16 means that each link component C_i with colour ψ_h (which is associated with one handle) can be eliminated provided one multiplies the resulting new link with an appropriate factor; if the component C_i is linked with a knot with colour $\psi[j]$, this factor $c(j)$ is given in equation (8.30).

At this point, one can derive the general expression for $\dim \mathcal{H}(g)$; in fact, each component of the surgery link with colour ψ_h (representing one handle) can be eliminated and substituted with

the multiplicative factor $c(j)$. Consequently, from equation (8.27) one finds

$$\begin{aligned}
\dim \mathcal{H}(g) &= \\
&= a^{-2}(k) \sum_j E_0[j] \langle W(U; \psi[j]) W(C_1; \psi_h) W(C_2; \psi_h) \cdots W(C_g; \psi_h) \rangle_{S^3} \\
&= a^{-2}(k) \sum_j E_0[j] \left(\frac{a^2(k)}{E_0^2[j]} \right)^g \langle W(U; \psi[j]) \rangle_{S^3} \\
&= \sum_j \left(\frac{a^2(k)}{E_0^2[j]} \right)^{(g-1)} \\
&= \sum_j X_{1j}^{2(1-g)} \quad .
\end{aligned} \tag{8.31}$$

Equation (8.31) coincides with equation (8.3).

Finally, let us derive equation (8.4). In this case, we must compute [46] the dimension of the physical state space of the CS theory defined in the manifold $\Sigma_g \times S^1$ in the presence of a static puncture on Σ_g . Let us now consider the knot C in $\Sigma_g \times S^1$ shown in Figure 8.17.

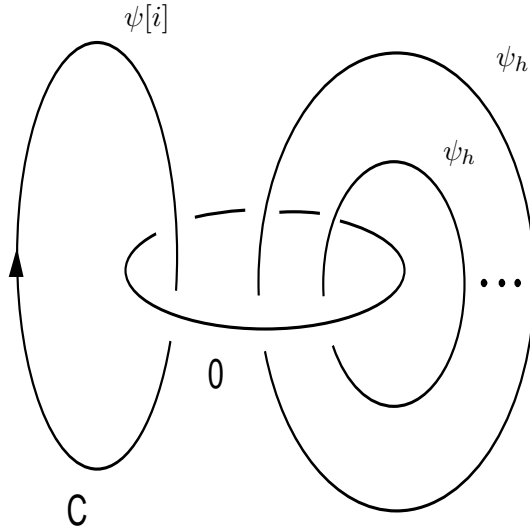

Figure 8.17

From a 2-dimensional point of view, the knot C corresponds to a static puncture on Σ_g . The dimension of the physical state space $\dim \mathcal{H}(g, \psi[i])$ is given by the analogue of equation (8.27), namely

$$\begin{aligned}
\dim \mathcal{H}(g, \psi[i]) &= \\
&= \frac{\langle W(U; \Psi_0) W(C; \psi[i]) W(C_1; \psi_h) W(C_2; \psi_h) \cdots W(C_g; \psi_h) \rangle_{S^3}}{\langle W(U; \Psi_0) \rangle_{S^3}} \quad .
\end{aligned} \tag{8.32}$$

By using the same method illustrated before, one finds

$$\dim \mathcal{H}(g, \psi[i]) = \sum_j X_{1j}^{(1-2g)} X_{ji} \quad , \tag{8.33}$$

which corresponds to equation (4). This concludes our topological derivation of the Verlinde formulae (2)-(4).

The expression appearing in (8.33) can be generalized to the case of n punctures with colours $\{\psi[i_1], \psi[i_2], \dots, \psi[i_n]\}$. Indeed, by using the satellite relation of eq.(2.32), the set of n punctures can be replaced with one puncture with colour ψ given by

$$\psi = \psi[i_1] \psi[i_2] \cdots \psi[i_n] \quad ; \quad (8.34)$$

the element $\psi \in \mathcal{T}_{(k)}$ admits the following decomposition

$$\psi = \sum_m c_m(i_1, \dots, i_n) \psi[m] \quad , \quad (8.35)$$

where the coefficients $\{c_m\}$ are determined by the $\mathcal{T}_{(k)}$ structure constants. Therefore, the dimension of the CS physical state space associated with the manifold $\Sigma_g \times S^1$ in the presence of n static punctures on Σ_g is

$$\begin{aligned} \dim \mathcal{H}(g, \psi[i_1], \dots, \psi[i_n]) &= \sum_m c_m(i_1, \dots, i_n) \dim \mathcal{H}(g, \psi[m]) \\ &= \sum_{m,j} c_m(i_1, \dots, i_n) X_{1j}^{(1-2g)} X_{jm} \quad . \end{aligned} \quad (8.36)$$

8.6 Discussion

In this Chapter we have shown that the fusion rules of conformal field theory and the associated Verlinde formulae admit an interpretation in terms of three-dimensional topology. In our approach, the existing connections between certain aspects of two-dimensional CFT and the topology of three-manifolds have not been assumed; these connections have been derived from the properties of the quantum CS field theory.

The starting point of our analysis has been the three-dimensional CS theory and the existence of a set of link invariants defined on framed, oriented and coloured links in S^3 . As a consequence of general covariance of the CS theory (combined with the framing dependence of the composite Wilson line operators), these link invariants satisfy a certain number of relations. The connected sum rule (9) and the satellite relation (2.32) summarize the relevant properties of the link polynomials.

Because of the satellite relations, an algebra structure is defined in the colour state space associated with the link components. This algebra, called the tensor algebra, is defined by the structure constants of the representation ring of the gauge group. For integer values of the coupling constant k , not all the different colour states are distinguished by the values of the observables. Two different elements of the tensor algebra are called physically equivalent when the values of their associated observables are equal. For fixed integer k , the tensor algebra can be decomposed into classes of physically equivalent elements. In general, the number of linearly independent classes is finite; consequently, the algebra defined by these classes (called the reduced tensor algebra $\mathcal{T}_{(k)}$) is of finite order. Since the braid group representations obtained in CFT and in the CS theory are equivalent, the fusion algebra of certain two-dimensional conformal models is isomorphic with the reduced tensor algebra of the corresponding three-dimensional CS theories.

The fusion rules, which correspond to the structure constants of $\mathcal{T}_{(k)}$, can be represented by means of the expectation values of Wilson line operators in the manifold $S^2 \times S^1$. We have shown that, when the reduced tensor algebra is regular, a projective representation of the modular group is defined on $\mathcal{T}_{(k)}$; the Verlinde formula (2) is then a consequence of the connected sum rule which is satisfied by the expectation values of the CS observables.

The operator surgery method has been used to implement Dehn's surgery in the field theory context. The topological properties of surgery can be expressed in terms of relations between the

expectation values of the CS observables. We have seen that a simple surgery presentation of the manifolds $\{\Sigma_g \times S^1\}$ can be given; in fact, we have derived a general rule for adding handles (in the three-dimensional context) to the manifold $S^2 \times S^1$. We have shown that the surgery operator, associated with one handle, is determined by the structure constants of $\mathcal{T}_{(k)}$; this result has been used to derive equations (8.3) and (8.4). Indeed, by using the operator surgery method, we have computed the dimensions of the physical state spaces of the CS theory defined in $\Sigma_g \times S^1$ and we have proved that the resulting expressions coincide with equations (8.3) and (8.4).

Chapter 9

Conclusion

In this thesis we have studied the Chern-Simons (CS) field theory with a non-Abelian gauge group G . When the theory is defined in S^3 gauge invariance constrains the renormalized coupling constant k to be an integer. As a consequence, there are elements of the tensor algebra \mathcal{T} of G which cannot be distinguished by using the CS observables. We have given the general rules to find the reduced tensor algebra $\mathcal{T}_{(k)}$ of \mathcal{T} , whose elements give the physical inequivalent quantum numbers that characterize uniquely the CS observables. Some general properties of the reduced tensor algebra have been given, and the important notion of regular reduced tensor algebra has been defined.

When $G = SU(3)$ we have produced an explicit expression for the value of the unknot and for the Hopf link, for arbitrary irreducible representations of $SU(3)$. We also have worked out the reduced tensor algebra by giving a set of “equivalence rules” among the elements of the $SU(3)$ tensor algebra. By using this result, we have solved explicitly the CS theory in any closed, connected and orientable three-manifold when the gauge group is $SU(3)$; in addition, many examples have been examined in detail.

When the reduced tensor algebra is regular, we have found the general expression for the surgery operator and we have given the surgery rules to compute a generic observable in any closed, connected and orientable three-manifold; the invariance of the observables under Kirby moves has been proved explicitly.

Starting from the partition function $Z(\mathcal{M})$ of the Chern-Simons field theory, i.e. the sum of the vacuum to vacuum Feynman’s diagrams, one can show that $I(\mathcal{M}) = \exp(i\varphi) Z(\mathcal{M})$, with a suitable choice of the phase φ , is a topological invariant of \mathcal{M} . We have computed the CS topological invariant $I(\mathcal{M})$ for various three-manifolds. Unfortunately, up to now, the topological interpretation of $I(\mathcal{M})$ is not known. Toward this goal, we have investigated the relation between $I(\mathcal{M})$ and the fundamental group $\pi_1(\mathcal{M})$ of \mathcal{M} . In the case $G = SU(2)$, we have proved that when $|I(L_{p/r})| \neq 0$ depends only on $\pi_1(L_{p/r})$; also strong numerical evidence suggesting the same result holds when $G = SU(3)$ has been produced. The generalization of the above result to any three-manifold is an open problem equivalent to proving or disproving the following conjecture: for non-vanishing $I(\mathcal{M})$, the absolute value $|I(\mathcal{M})|$ only depends on the fundamental group $\pi_1(\mathcal{M})$.

The last chapter is devoted to the relation between two-dimensional conformal field theory and three-dimensional Chern-Simons field theory. The point of view usually adopted in the existing literature is reversed. We do not follow the approach pioneered by Witten in which two-dimensional conformal field theory is the key tool in order to compute Chern-Simons observables, on the contrary, the attention is focused on three-dimensional field theory. We have shown that the celebrated results concerning the fusion rules for primary fields obtained by H. Verlinde can be proved by using the general properties of the surgery operator.

In Appendix D we have included a quick review of some basic ideas of two-dimensional conformal field theory, with these tools in hand, a sketch of the original Witten’s solution of Chern-Simons theory has been given. As we have stressed many times, the two approaches are quite different,

both from a theoretical point of view and from the point of view of practical computations. As shown in Appendix D, Witten's approach has a drawback: the relation between the renormalized CS coupling constant k and the level κ of two-dimensional current algebra is ambiguous, indeed, the original Witten's guess is inconsistent. The easiest way to find the correct relation, perhaps the only one, is perturbation theory. On the contrary, the three-dimensional field theoretic approach presented in this thesis is free from ambiguities. Nevertheless, Witten's idea is fascinating, it gives a new insight on the relation between conformal invariance in two dimensions and general covariance in three dimensions, providing a beautiful connection between the WZW model and CS theory. As a matter of fact, the method that we have used in this thesis is really powerful and provides an excellent way to compute the CS observables; in particular, the surgery construction is transparent and many properties can be derived.

Finally let us end with an open problem. Given a 3-manifold there are values of k for which $I_k = 0$; we argued that this problem is related to a breaking of the gauge invariance, however a rule to find the "forbidden" values of k is still missing.

Appendix A

The Wess-Zumino functional

A.1 Behaviour under smooth deformation

In this appendix we shall discuss some useful properties of the Wess-Zumino functional Γ defined as

$$\begin{aligned}\Gamma_M[U] &= \frac{1}{24\pi^2} \int_M \Omega \quad , \\ \Omega &= \text{Tr} [(U^{-1}dU) \wedge (U^{-1}dU) (U^{-1}dU)] \quad ,\end{aligned}\tag{A.1}$$

where M is an orientable 3-manifold and U is a smooth map from M to a compact and simple Lie group G . In addition, we have used a matrix representation of G . We shall first prove the Γ is invariant under a small deformation of the map U , i.e.

$$\Gamma_M[U + \delta U] = \Gamma_M[U] \quad .\tag{A.2}$$

By using the cyclicity of the trace one gets

$$\delta\Gamma_M[U] = \frac{1}{24\pi^2} \int_M 3 \text{Tr} [(U^{-1}d\delta U - U^{-1}\delta U U^{-1}dU) \wedge (U^{-1}dU) \wedge (U^{-1}dU)] \quad .\tag{A.3}$$

Let us note that

$$\begin{aligned}d[U^{-1}\delta U (U^{-1}dU) \wedge (U^{-1}dU)] &= \\ [(U^{-1}d\delta U - U^{-1}(dU)U^{-1}\delta U) \wedge (U^{-1}dU) \wedge (U^{-1}dU)] &\quad ,\end{aligned}\tag{A.4}$$

and

$$\begin{aligned}\text{Tr} [U^{-1}(dU)U^{-1}\delta U \wedge (U^{-1}dU) \wedge (U^{-1}dU)] &= \\ \text{Tr} [U^{-1}\delta U U^{-1}dU \wedge (U^{-1}dU) \wedge (U^{-1}dU)] &\quad .\end{aligned}\tag{A.5}$$

By using equations (A.4) and (A.5), the variation (A.3) of Γ can be written as

$$\delta\Gamma_M[U] = \frac{1}{24\pi^2} \int_M 3 d \text{Tr} [U^{-1}\delta U (U^{-1}dU) \wedge (U^{-1}dU)] \quad .\tag{A.6}$$

Stokes's theorems implies that

$$\delta\Gamma_M[U] = \frac{1}{24\pi^2} \int_{\partial M} 3 \text{Tr} [U^{-1}\delta U (U^{-1}dU) \wedge (U^{-1}dU)] \quad .\tag{A.7}$$

In our case $\partial M = \emptyset$, thus equation (A.7) leads to $\delta\Gamma[U] = 0$.

A.2 Composition of maps

We shall now proof the validity of equation (1.54) in Chapter 1. After a straightforward calculation one obtains

$$\Gamma[UV] = \Gamma[U] + \Gamma[V] + \Delta[U, V] \quad , \quad (\text{A.8})$$

where Δ is given by

$$\Delta[U, V] = \frac{3}{24\pi^2} \int_M \text{Tr} [V^{-1}\Phi(U) \wedge \Phi(U)V \wedge \Phi(V) + V\Phi(V) \wedge \Phi(V)V^{-1} \wedge \Phi(V)] \quad . \quad (\text{A.9})$$

For sake of simplicity we have introduced the Lie algebra valued 1-form $\Phi(U)$ defined as

$$\Phi(U) = U^{-1}dU \quad . \quad (\text{A.10})$$

It should be noted that $\Phi(U)$ is the pull-back of the Maurer-Cartan form on G under the map U . One can easily verify that the 3-form appearing in Δ is exact; indeed one gets

$$[V^{-1}\Phi(U) \wedge \Phi(U)V \wedge \Phi(V) + V\Phi(V) \wedge \Phi(V)V^{-1} \wedge \Phi(V)] = d[U^{-1}dU \wedge dV V^{-1}] \quad . \quad (\text{A.11})$$

By taking into account equation (A.11) and by using Stokes's theorem, equation (A.8) can be written as

$$\Gamma[UV] = \Gamma[U] + \Gamma[V] + \frac{3}{24\pi^2} \int_{\partial M} \text{Tr} [U^{-1}dU \wedge dV^{-1}V] \quad . \quad (\text{A.12})$$

In our case $\partial M = \emptyset$, thus equation (A.12) leads to equation (1.54).

A.3 Normalization: $\mathbf{G} = \mathbf{SU}(2)$

In order to determine the normalization for the Wess-Zumino functional when $M = S^3$, we only need to consider the case $G = SU(2)$. One can represent S^3 as R^3 in which the points on the surface $|\vec{x}|^2 = a$ are identified in the limit $a \rightarrow \infty$. The map U must satisfy the following condition

$$\lim_{|\vec{x}| \rightarrow \infty} U(\vec{x}) = U_\infty \quad . \quad (\text{A.13})$$

The map U can be chosen in the following way

$$U(\vec{x}) = \exp [i \vec{\sigma} \cdot \vec{n} f(|\vec{x}|)] \quad , \quad (\text{A.14})$$

where $\vec{n} = \vec{x}/|\vec{x}|$, $\vec{\sigma} = \{\sigma_1, \sigma_2, \sigma_3\}$ are the Pauli matrices, and f is a smooth function. By using the identity $\vec{\sigma}(\vec{\sigma} \cdot \vec{n}) = \vec{n} \mathbf{1} + i \vec{n} \wedge \vec{\sigma}$, one obtains

$$U^{-1}dU = \left\{ i \frac{\cos(f) \sin(f)}{|\vec{x}|} [\sigma_\mu - n_\mu (\vec{\sigma} \cdot \vec{n})] - (\vec{\sigma} \cdot \vec{n}) f' n_\nu - i \frac{\sin^2(f)}{|\vec{x}|} (\vec{n} \wedge \vec{\sigma})_\mu \right\} dx^\mu \quad , \quad (\text{A.15})$$

where f' is the first derivative of f with the respect to its argument. After a rather tedious calculation we arrive at the following expression for the Wess-Zumino functional

$$\Gamma[U] = \frac{1}{2\pi^2} \int \frac{f' \sin^2(f)}{|\vec{x}|^2} d^3x \quad . \quad (\text{A.16})$$

By introducing the radial coordinate $r = |\vec{x}|$, the integral in (A.16) is easily computed with the help of spherical coordinates. Indeed

$$\Gamma[U] = \frac{2}{\pi} \int_0^\infty \left[\frac{d}{dr} f(r) \right] \sin^2(f) dr = \frac{2}{\pi} \int_{f(0)}^{f(\infty)} \sin^2 y dy \quad . \quad (\text{A.17})$$

The final result is the following

$$\Gamma[U] = \pi^{-1} \left[f(\infty) - f(0) - \frac{1}{2} \sin(2f(\infty)) + \frac{1}{2} \sin(2f(0)) \right] \quad . \quad (\text{A.18})$$

Condition (A.13) implies the constraint

$$\lim_{r \rightarrow \infty} f(r) = m\pi \quad m \in \mathbb{Z} \quad , \quad (\text{A.19})$$

in addition we also need that $f(0) = 0$. These conditions lead to

$$\Gamma[U] = m \quad . \quad (\text{A.20})$$

Appendix B

Elements of knot theory

B.1 Ambient and regular isotopy

In this appendix some basic notions of knot theory are introduced, a more complete treatment can be found in [24, 23].

A knot C in a manifold M is a subset of M homeomorphic with S^1 , i.e. there exists a continuous map f with a continuous inverse, such that $f : C \rightarrow S^1$. A link L in M with m components is a collection of m non intersecting knots in M . In this appendix we shall deal with knots in R^3 or S^3 . For notational simplicity we shall refer to knots in R^3 , it is understood that everything applies also to the S^3 case.

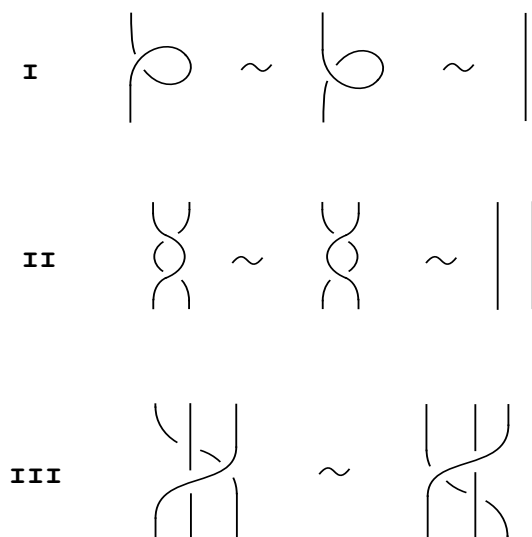

Figure B1

Given two knots C_1 and C_2 , they are ambient isotopic if there exists a homeomorphism h such

that $h(C_1) = C_2$ and in addition h is the end map of the following homotopy

$$\begin{aligned} h_t : \mathbb{R}^3 &\rightarrow \mathbb{R}^3 & t \in [0, 1] &, \\ h_0 &= \text{identity} & , \\ h_1 &= h & . \end{aligned} \tag{B.1}$$

The property of C_1 and C_2 to be ambient isotopic is denoted by $C_1 \equiv C_2$. We shall call C unknot when it is ambient isotopic to a knot having the same homotopy type as a point, i.e. C can be shrunk continuously to a point.

A useful graphical representation of links in \mathbb{R}^3 in terms of diagrams is obtained by projecting the links on a plane. Conventionally, admissible link diagrams contain simple crossings only. By means of link diagrams the ambient isotopic equivalence relation can be reformulated in terms of the Reidemeister moves shown in figure B1.

Given two link diagrams Dl_1 and Dl_2 , they represent ambient isotopic links L_1 and L_2 if and only if one can obtain Dl_1 from Dl_2 by using a finite sequence of Reidemeister moves. For our purposes, we need to consider oriented links. In a link diagram the orientation is introduced by considering oriented strings. The over-crossing L_+ and under-crossing L_- configurations occurring in a allowed link diagram are shown in figure B2.

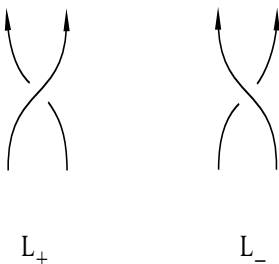

Figure B2

It is worth to point out that Reidemeister move of type I is peculiar. Indeed, differently from types II and III, only a single string is involved. Starting from this consideration, one introduces the notion of regular isotopic links which will play a crucial role in the Chern-Simons theory. Let us consider two link diagrams Dl_1 and Dl_2 . They are regular isotopic if Dl_1 can be obtained from Dl_2 by using a finite sequence of Reidemeister moves of type II and III only.

From the definition, the notion of ambient isotopy admits a clear topological interpretation and it introduces an equivalence relation on the set of links in \mathbb{R}^3 . On the contrary, the notion of regular isotopy is inherited from link diagrams; the question is: “does there exist a geometric interpretation of regular isotopy invariance beyond the link diagram level ? ”

The answer to this question is positive: regular isotopic link diagrams can be interpreted as representing ambient isotopic bands. Indeed, one can imagine to replace the strings composing a link by oriented bands (see figure B3). The topology of the link does not change, however, for each component C_i one needs to specify an additional bit of information: the twist $T(C_i)$. The twist variable $T(C_i)$ represents how many times the band corresponding to C_i is twisted. Clearly, the twist is an ambient isotopy invariant for bands.

In order to complete the connection between ambient isotopic links made of bands and regular link diagrams, we have to specify the twist $T(C)$ of knot C in terms of some regular ambient isotopy

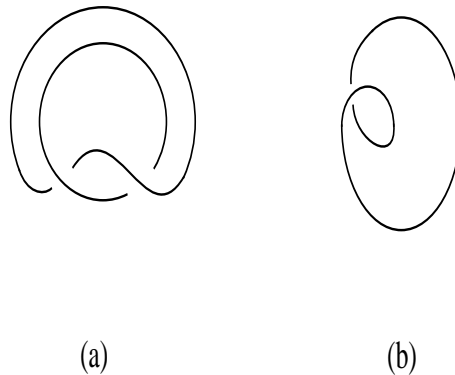

Figure B3

invariant of C . Let us introduce the writhe of the link diagram Dl as

$$\text{WR}(Dl) = \sum_{x \in L} \epsilon(x) \quad , \quad (\text{B.2})$$

where x represents a generic over-crossing or under-crossing in Dl , and

$$\epsilon(L_+) = 1 \quad , \quad \epsilon(L_-) = -1 \quad . \quad (\text{B.3})$$

It is straightforward to verify from the definition (B.2) that the writhe of a link diagram is a regular isotopy invariant. Indeed, the writhe can be written as

$$\text{WR}(Dl) = n_+ - n_- \quad , \quad (\text{B.4})$$

where n_+ and n_- are the number of over-crossings and under-crossings. The relation between the writhe of a link diagram Dl associated with the knot C is prescribed to be

$$\text{WR}(Dl) = T(C) \quad . \quad (\text{B.5})$$

In chapter 1 we have introduced the framing prescription in order to properly define composite Wilson operators. The knot C and its framing C_f can be considered as the boundary of a band, and one can naturally interpret framed links as links made of bands. With the vertical framing convention (B.5), oriented framed links and links made of bands are in one to one correspondence. A representative element of the class of ambient isotopic knots with a framed and oriented knot C is uniquely associated with an element of the class of regular isotopic diagram Dl of C in the following way

$$lk(C, C_f) = \text{WR}(Dl) \quad . \quad (\text{B.6})$$

For sake of simplicity, we shall denote the writhe of an element of the class of regular isotopic link diagrams associated with a framed and oriented knot C simply by $\text{WR}(C)$. In general the linking number between two framed and oriented knots C_1 and C_2 can be expressed as

$$lk(C_1, C_2) = \frac{1}{2} [\text{WR}(L) - \text{WR}(C_1) - \text{WR}(C_2)] \quad , \quad (\text{B.7})$$

where L is the link obtained by the union of C_1 and C_2 . The linking number is an ambient isotopy invariant for oriented knots.

B.2 Link invariants

A link invariant is a function

$$L \xrightarrow{f} f(L) \quad (\text{B.8})$$

which assigns to each link L an object $f(L)$ in such way that, if L_1 and L_2 are ambient isotopic, then $f(L_1) = f(L_2)$. By using a similar definition one can also consider invariants for regular isotopic links. In the previous section, a numerical invariant for ambient isotopic links, the linking number, and a numerical invariant for regular isotopic links, the writhe, have been defined.

The Jones polynomials $V(L; q)$ [9] in the variable $q^{\pm\frac{1}{2}}$ with integer coefficients satisfy the following properties

- i) ambient isotopy invariance;
- ii) $V(C_u; q) = 1$, where C_u is the unknot;
- iii) $qV(L_+) - q^{-1}V(L_-) = \left(q^{\frac{1}{2}} - q^{-\frac{1}{2}}\right)V(L_0)$.

Property iii) is called skein relation; it relates the invariants of skein related links. The links L_+ , L_- and L_0 are skein related if they can be represented by link diagrams which are identical except for a small part contained inside a fixed open disc as shown in figure B4.

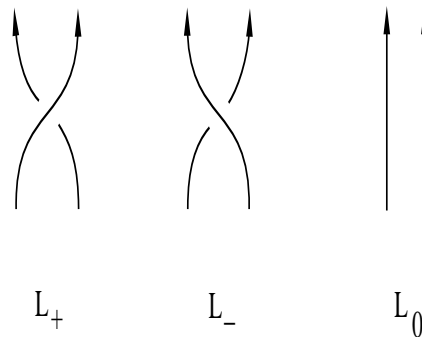

Figure B4

Another polynomial invariant naturally arises in the Chern-Simons field theory: the S polynomial $S(L; \alpha, \beta, z)$, which is essentially a generalization of the Jones polynomial. $S(L; \alpha, \beta, z)$ is defined in the following way [28]

- i) regular isotopy invariance;
- ii) $S(C_u) = 1$;
- iii) $S(L^{(+)}) = \alpha S(L^{(0)})$, $S(L^{(-)}) = \alpha^{-1} S(L^{(0)})$;
- iv) $\beta S(L_+) - \beta^{-1} S(L_-) = z S(L_0)$.

The skein relation corresponding to $L^{(+)}$, $L^{(-)}$ and $L^{(0)}$ is shown in figure B5. Equations iii) and iv) satisfied by S generalize the Skein relation of the Jones polynomials. It should be noted that,

starting from the regular isotopy invariant S , an ambient isotopy invariant \mathcal{S} can be introduced; indeed

$$\mathcal{S}(L; \alpha, \beta, z) = \alpha^{-WR(L)} S(L; \alpha, \beta, z). \tag{B.9}$$

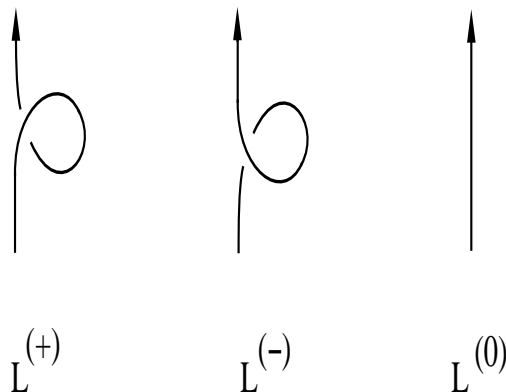

Figure B5

B.3 Artin braid group

The construction and computation of link invariants can be put in an algebraic framework; one of the key ingredients toward this goal is the Artin braid group [26].

The standard presentation of the Artin braid group B_n is given in terms of $(n - 1)$ generators $\{g_1, \dots, g_{n-1}\}$ satisfying the following relations

$$g_i g_j = g_j g_i, \quad |i - j| > 1, \tag{B.10}$$

$$g_i g_{i+1} g_i = g_{i+1} g_i g_{i+1}, \quad i < n - 1. \tag{B.11}$$

A very useful graphical representation of B_n can be provided in terms of n oriented strings. The effect of g_i on the strings is represented by an over-crossing between the i^{th} and $(i + 1)^{\text{th}}$ string originally parallel as shown in Fig.B7a. In the same way the effect of g_i^{-1} is obtained by replacing the over-crossing by an under-crossing. For instance, in Fig.B7b is shown the elements $\sigma = g_2^{-1}g_1$ of B_n . Clearly, the constraints (B.10) and (B.11) are satisfied.

It should be evident that action of g_i, g_i^{-1} and the identity on the strings precisely corresponds to the $L_+, L_-,$ and L_0 admissible configurations encountered in the diagrams describing the projection of a link on a plane. The correspondence can be made more closely by noting that the invariance under Reidemeister moves of type II and III reproduces exactly Eqs (B.10) and (B.11). In other words, the constraints among the generators of B_n are the algebraic statement of regular isotopy invariance. Also Reidemeister moves of type I can be recovered by taking into account the closure of the generic element $\sigma \in B_n$. The closure $\hat{\sigma}$ of $\sigma \in B_n$ is obtained by connecting the end points of the graph associated with σ in an orientation preserving way as shown in Fig.B8.

As results, the graph associated with the closure of an element of B_n corresponds to a link diagram. However, care must be used in the identification between the closure of braids and link

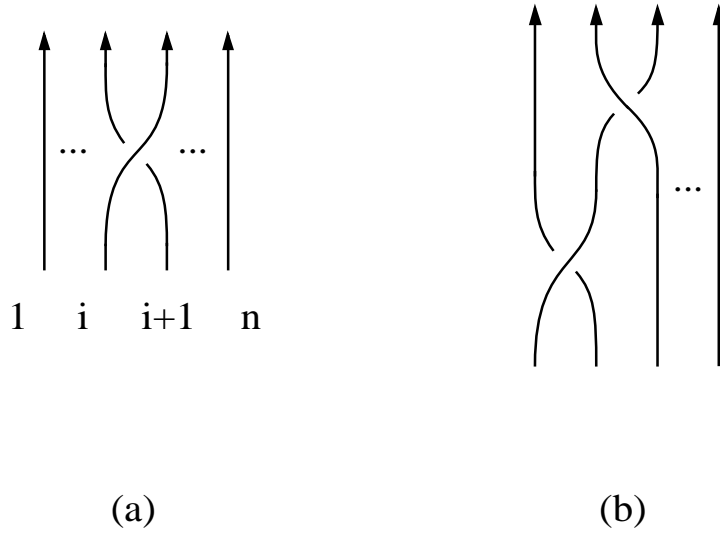

Figure B7

diagrams. Indeed, given two braids $\sigma_1, \sigma_2 \in B_n$ that belong to the same conjugacy class, i.e. there exists $\sigma \in B_n$ such that $\sigma_1 = \sigma^{-1}\sigma_2\sigma$, the corresponding closures $\hat{\sigma}_1$ and $\hat{\sigma}_2$ give link diagrams connected by Reidemeister moves of type II. Therefore, in order to make contact with link invariants, conjugate elements of B_n must be identified. The conjugacy class of an element σ of B_n will be denoted by $\langle \sigma \rangle_n$ and its closure with $\langle \hat{\sigma} \rangle_n$. Clearly, B_n admits a natural inclusion in B_{n+1} . Any link diagram can be obtained as the closure of direct sum $B_\infty = \bigoplus_{i=1}^\infty B_i$ of braid groups, the natural inclusion is understood. By construction, any function defined on the conjugacy class of B_∞ gives rise to a regular isotopy link invariant.

Example

Consider the map $f : B_\infty \rightarrow \mathbb{Z}$ such that

$$f(g_i) = 1 \quad . \tag{B.12}$$

One can verify that the resulting regular isotopy link invariant coincides with the writhe.

When ambient isotopy invariance is concerned, one must provide a way to take into account Reidemeister moves of type I. The key observation is that the closure of $\langle \sigma \rangle_n$ and the closure of $\langle \sigma g_n^\pm \rangle_{n+1}$ correspond actually to link diagrams related by a Reidemeister move of type I. Thus, the correspondence rules between the closure of braids and diagrams of ambient isotopy links can be stated as follows. Given two braids σ_1 and σ_2 , their closures $\hat{\sigma}_1, \hat{\sigma}_2$ are associated with link diagrams corresponding to ambient isotopic links if σ_1 and σ_2 are related by a sequence of Markov moves: M1, M2 [27]

M1) σ_1 and σ_2 are conjugate elements of B_n ,

M2) if $\sigma_1 \in B_n$ then $\sigma_2 = \sigma_1 g_n^{\pm 1} \in B_{n+1}$.

Clearly, any function on B_∞ which is invariant under Markov moves, a Markov trace, defines an ambient isotopy link invariant. The Reshetikhin-Turaev [44, 12] invariant is defined starting from an R-matrix representation of B_n associated with a q-deformation of the universal enveloping algebra of $SU(2)$.

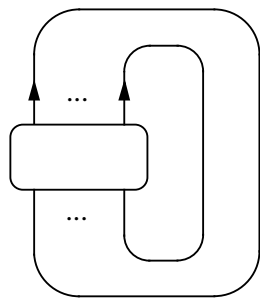

(a)

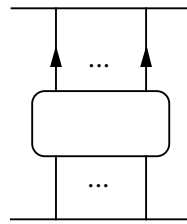

(b)

Figure B8

Appendix C

Miscellaneous results

C.1 The $SU(3)$ Hopf matrix is non singular

For $G = SU(3)$ and for a fixed integer $k \geq 3$, let us consider the values $\{H[(m, n), (a, b)]\}$ of the Hopf link for $(m, n) \in \Delta_k$ and $(a, b) \in \Delta_k$. These complex numbers can be understood as the matrix elements of a symmetric matrix called the Hopf matrix H . The elements of the standard basis of $\mathcal{T}_{(k)}$ are $\{\Psi[a, b]\}$ with $(a, b) \in \Delta_k$; to simplify the notation, we shall denote them simply by $\{\psi_i\}$ with the collective index i running from 1 to the dimension of $\mathcal{T}_{(k)}$. The element ψ_1 corresponds to $\Psi[0, 0]$ and, if ψ_i represents $\Psi[a, b]$, then ψ_{i^*} denotes $\Psi[b, a]$. The matrix elements of H are

$$H_{ij} = H[\psi_i, \psi_j] \quad . \quad (\text{C.1})$$

We shall prove that H is invertible.

First of all, let us evaluate H^2 . By definition, one has

$$(H^2)_{ij} = \sum_l H_{il} H_{lj} \quad . \quad (\text{C.2})$$

By taking into account that the values of the Hopf link are given in eq.(3.60), one finds that expression (C.2) consists of a combination of geometric finite sums. The direct computation of these geometric finite sums gives [35, 36]

$$(H^2)_{ij} = \left[\frac{3k^2}{256 \sin^6(\pi/k) \cos^2(\pi/k)} \right] \delta_{ij^*} \quad . \quad (\text{C.3})$$

This equation shows that the Hopf matrix H is invertible; indeed,

$$(H^{-1})_{ij} = \sum_l \left[\frac{3k^2}{256 \sin^6(\pi/k) \cos^2(\pi/k)} \right]^{-1} H_{il} \delta_{l^*j} \quad . \quad (\text{C.4})$$

A simple consequence of Eq.(C.3) is the following

$$\sum_m H_{1m} H_{mj} = \sum_m E_0[m] H_{mj} = b(k) \delta_{1j^*} \quad , \quad (\text{C.5})$$

where $b(k)$ is defined as

$$b(k) = \left[\frac{3k^2}{256 \sin^6(\pi/k) \cos^2(\pi/k)} \right] \quad . \quad (\text{C.6})$$

C.2 On the $SU(3)$ reduced tensor algebra structure constants

The main purpose of this appendix is to show that the structure constants of the $SU(3)$ reduced tensor algebra verify the relation $N_{ijm} = N_{i^*mj}$.

Let us recall that the elements of the standard basis of $\mathcal{T}_{(k)}$ are denoted by $\{\psi_i\}$, and the unit element of the algebra by ψ_1 .

Property C1

The structure constants of $\mathcal{T}_{(k)}$ verify

$$N_{ij\mathbf{1}} = \delta_{ij^*} = \delta_{i^*j} \quad . \quad (\text{C.7})$$

Proof. When $k = 1$ and $k = 2$, the validity of eq.(C.7) can easily be verified by direct inspection of the expressions given in Sect.4.2.4 and in Sect.4.2.5. Let us concentrate then on the case $k \geq 3$. In Sect.C.1 we have proved that the Hopf matrix H satisfies

$$(H^2)_{ij} = b(k) \delta_{ij^*} \quad . \quad (\text{C.8})$$

Since H_{ij} represents the value of the Hopf link, by using the connected sum formula (2.40), one finds

$$(H^2)_{ij} = \sum_m E_0[m] \langle W(C_1, C_2, C_3; \psi_i, \psi_j, \psi_m) \rangle |_{S^3} \quad , \quad (\text{C.9})$$

where $\{C_1, C_2, C_3\}$ are the three (framed) components of the link shown in Fig.C1. By using the satellite relations (2.32) and eq.(C.8), one obtains

$$(H^2)_{ij} = \sum_{n,m} N_{ijm} E_0[m] H_{mn} \quad . \quad (\text{C.10})$$

Finally, Eqs.(C.10), (C.3) and (C.5) lead to

$$(H^2)_{ij} = b(k) N_{ij\mathbf{1}} = b(k) \delta_{ij^*} \quad , \quad (\text{C.11})$$

which shows that eq.(C.7) is satisfied. \square

Let us introduce the complex valued linear function \mathcal{F} which is defined on the elements $\mathcal{T}_{(k)}$. The action of \mathcal{F} on the elements of the standard basis of $\mathcal{T}_{(k)}$ is defined as

$$\mathcal{F}(\psi_i) = \delta_{\mathbf{1}j} \quad . \quad (\text{C.12})$$

From Property C1, it follows that

$$\mathcal{F}(\psi_i \psi_j) = N_{ij\mathbf{1}} = \delta_{ij^*} \quad . \quad (\text{C.13})$$

Consequently, by means of \mathcal{F} , the structure constants N_{ijm} can be written as

$$\mathcal{F}(\psi_i \psi_j \psi_{m^*}) = \sum_n N_{ijn} \mathcal{F}(\psi_n \psi_{m^*}) = N_{ijm} \quad . \quad (\text{C.14})$$

Since $\mathcal{T}_{(k)}$ is a commutative and associative algebra, one has

$$N_{ijm} = \mathcal{F}(\psi_i \psi_{m^*} \psi_j) = N_{im^*j^*} \quad . \quad (\text{C.15})$$

At this point, one can use the relation $N_{ijm} = N_{i^*j^*m^*}$ (see eq.(2.11) to get the final result

$$N_{ijm} = N_{i^*mj} \quad . \quad (\text{C.16})$$

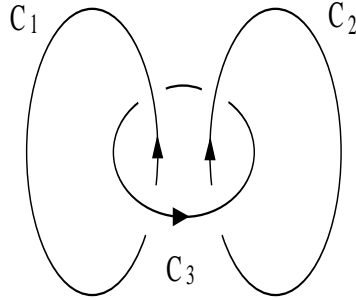

Figure C.1

C.3 Normalization of surgery operator for $SU(2)$, $k \geq 2$

The value of $a(k)$ and θ_k when $G = SU(2)$ is obtained by evaluating the sum

$$Z_{(+)} = \sum_{J=0}^{k/2-1} q^{Q(J)} E_0[J]^2 \quad . \quad (\text{C.17})$$

Alternatively, one can extend the sum over $0 \leq J \leq 2k - 1$ simply by introducing a factor $1/4$, i.e.

$$Z_{(+)} = \frac{1}{4} \sum_{J=0}^{2k-2} q^{Q(J)} E_0[J]^2 \quad . \quad (\text{C.18})$$

Eq.(C.18) is a trivial consequence of Property 4.4. From the expression (3.3) for $E_0[J]$ one gets

$$Z_{(+)} = \frac{q^{-1/4}}{4(q^{1/2} - q^{-1/2})^2} \sum_{s=1}^{4k-1} q^{-1} \left[q^{(s+2)^2/4} + q^{(s-2)^2/4} - 2qq^{s^2/4} \right] \quad , \quad (\text{C.19})$$

with $s = 2J + 1$. A straightforward calculation gives

$$Z_{(+)} = -\frac{q^{-3/4}}{2(q^{1/2} - q^{-1/2})} \sum_{s=1}^{4k-1} q^{s^2/4} \quad . \quad (\text{C.20})$$

Let us now recall the definition of Gauss sum $S(n, m)$ [53]

$$S(n, m) = \sum_{x=0}^{m-1} \exp\left(2\pi i \frac{n}{m} x^2\right) \quad . \quad (\text{C.21})$$

Thus, by using (C.21), Eq.(C.20) can be written as

$$Z_{(+)} = \frac{e^{i3\pi/(2k)}}{4i \sin(\pi/k)} S^*(1, 4k) \quad . \quad (\text{C.22})$$

In particular, when $n = 1$ one has [53]

$$S(1, m) = \begin{cases} (1 + i)\sqrt{m} & \text{if } m \equiv 0 \pmod{4} \\ \sqrt{m} & \text{if } m \equiv 1 \pmod{4} \\ 0 & \text{if } m \equiv 2 \pmod{4} \\ i\sqrt{m} & \text{if } m \equiv 3 \pmod{4} \end{cases} \quad . \quad (\text{C.23})$$

From eq.(C.22) and eq.(C.23) one has

$$Z_{(+)} = \frac{\sqrt{k}}{2} [\sin(\pi/k)]^{-1} e^{-i\frac{\pi}{4k}3(k-2)} . \quad (\text{C.24})$$

On the other hand we have

$$Z_{(+)} = e^{i\theta_k} \frac{1}{a(k)} , \quad (\text{C.25})$$

thus

$$\theta_k = -\frac{\pi}{4k}3(k-2) ; \quad (\text{C.26})$$

$$a(k) = \frac{2}{\sqrt{k}} \sin(\pi/k) . \quad (\text{C.27})$$

C.4 Normalization of surgery operator for $SU(3)$, $k \geq 3$

The value of Z_0 , defined in eq.(6.115), has been computed in Sect.C.1. In this appendix we shall compute Z_{+1} (see eq.(6.116)) when $k \geq 3$. Let us recall that the elements of the standard basis of $\mathcal{T}_{(k)}$ are $\{\Psi[m, n]\}$ where the couples (m, n) label the points of the fundamental domain Δ_k defined in Sect.4.2.3. Since the value of the unknot vanishes on the points which belong to the boundary of Δ_k , eq.(6.116) can be written as

$$Z_{(+)} = \sum_{m=0}^{k-2} \sum_{n=0}^{k-2-m} q^{Q(m,n)} E_0^2[m, n] . \quad (\text{C.28})$$

By using the correspondence rules given in Sect.4.2.3, it is easy to verify that the sum appearing in eq.(C.28) can be extended to the region $0 \leq m \leq (4k-1)$ and $0 \leq n \leq (3k-1)$ provided that we divide by a factor $24 = 4 \times 3 \times 2$. Thus,

$$Z_{(+)} = \frac{1}{24} \sum_{m=0}^{4k-1} \sum_{n=0}^{3k-1} q^{Q(m,n)} E_0^2[m, n] . \quad (\text{C.29})$$

By inserting in expression (C.29) the values $Q(m, n)$ of the quadratic Casimir operator and the values $E_0[m, n]$ of the unknot, one finds [35, 36]

$$\begin{aligned} Z_{(+)} = & \frac{1}{24} \sum_{m=0}^{4k-1} \sum_{n=0}^{3k-1} \left(1 - e^{-i\frac{2\pi}{k}}\right)^{-6} \left(1 + e^{-i\frac{2\pi}{k}}\right)^{-2} \\ & \left\{ e^{-i\frac{2\pi}{3k}[n^2+n(m-3)]} e^{-i\frac{2\pi}{3k}(m^2-3m)} - 2e^{-i\frac{2\pi}{3k}[n^2+mn]} e^{-i\frac{2\pi}{3k}(m^2-3m+3)} \right. \\ & + e^{-i\frac{2\pi}{3k}[n^2+n(m+3)]} e^{-i\frac{2\pi}{3k}(m^2-3m+6)} - 2e^{-i\frac{2\pi}{3k}[n^2+n(m-3)]} e^{-i\frac{2\pi}{3k}(m^2+3)} \\ & + 2e^{-i\frac{2\pi}{3k}[n^2+mn]} e^{-i\frac{2\pi}{3k}(m^2+6)} + 2e^{-i\frac{2\pi}{3k}[n^2+n(m+3)]} e^{-i\frac{2\pi}{3k}(m^2+9)} \\ & - 2e^{-i\frac{2\pi}{3k}[n^2+n(m+6)]} e^{-i\frac{2\pi}{3k}(m^2+12)} + e^{-i\frac{2\pi}{3k}[n^2+n(m-3)]} e^{-i\frac{2\pi}{3k}(m^2+3m+6)} \\ & + 2e^{-i\frac{2\pi}{3k}[n^2+mn]} e^{-i\frac{2\pi}{3k}(m^2+3m+9)} - 6e^{-i\frac{2\pi}{3k}[n^2+n(m+3)]} e^{-i\frac{2\pi}{3k}(m^2+3m+12)} \\ & + 2e^{-i\frac{2\pi}{3k}[n^2+n(m+6)]} e^{-i\frac{2\pi}{3k}(m^2+3m+15)} + e^{-i\frac{2\pi}{3k}[n^2+n(m+9)]} e^{-i\frac{2\pi}{3k}(m^2+3m+18)} \\ & - 2e^{-i\frac{2\pi}{3k}[n^2+mn]} e^{-i\frac{2\pi}{3k}(m^2+6m+12)} + 2e^{-i\frac{2\pi}{3k}[n^2+n(m+3)]} e^{-i\frac{2\pi}{3k}(m^2+6m+15)} \\ & + e^{-i\frac{2\pi}{3k}[n^2+n(m+6)]} e^{-i\frac{2\pi}{3k}(m^2+6m+18)} - 2e^{-i\frac{2\pi}{3k}[n^2+n(m+9)]} e^{-i\frac{2\pi}{3k}(m^2+6m+21)} \\ & + e^{-i\frac{2\pi}{3k}[n^2+n(m+3)]} e^{-i\frac{2\pi}{3k}(m^2+9m+18)} - 2e^{-i\frac{2\pi}{3k}[n^2+n(m+6)]} e^{-i\frac{2\pi}{3k}(m^2+9m+21)} \\ & \left. + e^{-i\frac{2\pi}{3k}[n^2+n(m+9)]} e^{-i\frac{2\pi}{3k}(m^2+9m+24)} \right\} . \quad (\text{C.30}) \end{aligned}$$

The sums appearing in expression (C.30) have the form of generalized double Gauss sums. In order to evaluate this expression, we need to recall a few properties of the Gauss sums.

Let $F(x, y, \alpha)$ be the function (generalized Gauss sum)

$$F(y, \alpha) = \sum_{n=0}^{y-1} e^{-\frac{i2\pi}{y}(n^2 + \alpha n)} \quad , \quad (C.31)$$

where y (with $y > 1$) and α are integers. At this point we can use the reciprocity formula [40] for the generalized Gauss sums

$$\sum_{n=0}^{|c|-1} e^{i\frac{\pi}{c}(an^2 + bn)} = \sqrt{\left|\frac{c}{a}\right|} e^{i\frac{\pi}{4ac}(|ac| - b^2)} \sum_{n=0}^{|a|-1} e^{-i\frac{y\pi}{a}(cn^2 + bn)} \quad , \quad (C.32)$$

where the integers a, b, c satisfy the relations

$$ac \neq 0 \quad , \quad ac + b \text{ is even} \quad . \quad (C.33)$$

With the help of (C.32), one gets

$$F(y, \alpha) = \sqrt{\frac{y}{2}} e^{\frac{i\pi}{4}\left(\frac{2\alpha^2}{y} - 1\right)} \left[1 + e^{\frac{i\pi}{2}(y+2\alpha)} \right] \quad . \quad (C.34)$$

Eq.(C.34) can be used to compute $Z_{(+)}$. Indeed, each term entering expression (C.30) consists of a double generalized Gauss sum. By using eq.(C.34) twice, each term can be evaluated explicitly. The final result is

$$Z_{(+)} = e^{i6\pi/k} \frac{k\sqrt{3}}{16 \cos(\pi/k) \sin^3(\pi/k)} \quad . \quad (C.35)$$

A nontrivial check of eq.(C.35) is the following. The product $Z_{(+)} Z_{(-)} = |Z_{(+)}|^2$ coincides with Z_0 given in eq.(6.115). This means that the result (C.35) is in agreement with Property C2.

C.5 The value of $I(\Sigma_g \times S^1)$

In this section, we give the explicit derivation of eq.(7.17). The manifold $\Sigma_g \times S^1$ can be obtained from $S^2 \times S^1$ by ‘‘adding g handles’’. As we have shown in Sect.6.7.3, each handle admits the decomposition (6.83). When $k = 5$, the non-vanishing values of the η -coefficients are shown in eq.(6.93). Therefore, in order to compute $I(\Sigma_g \times S^1)$, we need to consider the manifold $S^2 \times S^1$ with g punctures on S^2 where each puncture has colour $\Psi_h = 6\Psi[0, 0] + 3\Psi[1, 1]$. We shall decompose the resulting colour state

$$\Psi_{gh} = (\Psi_h)^g = 3^g (\Psi[0, 0] + \Psi[1, 1])^g \quad , \quad (C.36)$$

and, because of Eq.(6.66) or rather by using Theorem 6.5, we need to find the coefficient $\eta_{gh}(0)$ of $\Psi[0, 0]$ in this decomposition. From (6.92) one has

$$\begin{aligned} \Psi[0, 0] \Psi[0, 0] &= \Psi[0, 0] \quad , \quad \Psi[0, 0] \Psi[1, 1] = \Psi[1, 1] \\ \Psi[1, 1] \Psi[1, 1] &= \Psi[0, 0] + \Psi[1, 1] \quad . \end{aligned} \quad (C.37)$$

Therefore, if Ψ_b denotes the state

$$\Psi_b = \Psi[0, 0] + x \Psi[1, 1] \quad , \quad (C.38)$$

where x is a root of the equation $x^2 = x + 1$, one gets (for $n \geq 2$)

$$(\Psi_b)^n = (x + 2)^{n-1} \Psi_b \quad . \quad (\text{C.39})$$

The state $2\Psi[0, 0] + \Psi[1, 1]$ can be written as

$$2\Psi[0, 0] + \Psi[1, 1] = x^{-1} ((2x + 1)\Psi[0, 0] + \Psi_b) \quad . \quad (\text{C.40})$$

Consequently, from Eq.(C.36) it follows that

$$\eta_{gh}(0) = \frac{3^g (2x - 1)^g}{x^g (x + 2)} \left[x + 1 + \left(1 + \frac{x + 2}{2x - 1} \right)^g \right] \quad . \quad (\text{C.41})$$

The two possible values of x are $(1 \pm \sqrt{5})/2$. Therefore, Eq.(C.41) becomes

$$\eta_{gh}(0) = 3^g 5^{(g-1)/2} \left[\left(\frac{\sqrt{5} - 1}{2} \right)^{g-1} + \left(\frac{\sqrt{5} + 1}{2} \right)^{g-1} \right] \quad . \quad (\text{C.42})$$

Since the equation $x^2 = x + 1$ defines the recursive relation

$$x^g = F(g)x + F(g - 1) \quad , \quad (\text{C.43})$$

for the Fibonacci numbers $\{F(g)\}$, the value of the invariant

$$I(\Sigma_g \times S^1) = \eta_{gh}(0) \sqrt{3(\sqrt{5} + 1)/2} \quad (\text{C.44})$$

can be written in the final form

$$I(\Sigma_g \times S^1) = \begin{cases} 3^g 5^{g/2} F(g - 1) \sqrt{3(\sqrt{5} + 1)/2} & \text{for } g \text{ even;} \\ 3^g 5^{(g-1)/2} [F(g) + F(g - 2)] \sqrt{3(\sqrt{5} + 1)/2} & \text{for } g \text{ odd,} \end{cases} \quad (\text{C.45})$$

which is the equation reported in section 7.3.

C.6 Proof of (7.63)

Lemma C2

Let a, b two integers, with $(a, b) = 1$ and $b > 2$ even; one has

$$a^{\phi(b)} \equiv 1 \pmod{2b} \quad . \quad (\text{C.46})$$

Proof The proof consists of two parts: firstly, it is shown by induction that Lemma C2 holds when $b = 2^m$ with $m > 1$ integer. Secondly, equation (C.46) is proved when $b = 2^m c$ with $m \geq 1$ and c odd integer.

Since b is even, a is clearly odd and can be written in the form $a = (2f + 1)$. When b is of the type $b = 2^m$, the condition $b > 2$ implies that $m \geq 2$. Let us now consider the case $m = 2$; one has $\phi(b) = \phi(2^2) = 2$, therefore

$$a^{\phi(b)} = (2f + 1)^2 = 1 + 4f(f + 1) \equiv 1 \pmod{2^3} \quad . \quad (\text{C.47})$$

Thus, Lemma C2 is satisfied when $b = 2^2$. Suppose now that equation (C.46) holds when $b = 2^n$ for a certain n . We need to prove that (C.46) is true also for $b = 2^{(n+1)}$. Indeed, $\phi(2^{n+1}) = 2^n$ and one gets

$$(2f + 1)^{\phi(2^{n+1})} = \left[(2f + 1)^{\phi(2^n)} \right]^2 . \quad (\text{C.48})$$

By using the induction hypothesis

$$(2f + 1)^{\phi(2^n)} = 1 + N 2^{n+1} , \quad (\text{C.49})$$

one finds

$$\left[(2f + 1)^{\phi(2^n)} \right]^2 = 1 + 2^{n+2} N (1 + 2^n N) \equiv 1 \pmod{2^{n+2}} . \quad (\text{C.50})$$

Therefore, equation (C.46) is also satisfied when $b = 2^{(n+1)}$. To sum up, for $m > 1$ and a odd, one has

$$a^{\phi(2^m)} \equiv 1 \pmod{2^{m+1}} . \quad (\text{C.51})$$

Let us now consider the general case in which $b = 2^m c$ with c odd integer. From Euler's Theorem [53] it follows that

$$a^{\phi(b)} \equiv 1 \pmod{b} \Rightarrow a^{\phi(b)} \equiv 1 \pmod{c} . \quad (\text{C.52})$$

On the other hand, $\phi(2^m c) = \phi(2^m) \phi(c)$ and, for $m > 1$, equation (C.51) implies

$$a^{\phi(b)} = a^{\phi(c) \phi(2^m)} \equiv 1 \pmod{2^{m+1}} . \quad (\text{C.53})$$

Since $(2^{m+1}, c) = 1$, from equations (C.52) and (C.53) one gets

$$a^{\phi(b)} \equiv 1 \pmod{2^{m+1} c} \equiv 1 \pmod{2b} . \quad (\text{C.54})$$

Finally, we need to consider the case $b = 2c$. Since $\phi(c)$ is even, one gets

$$a^{\phi(2c)} = [1 + 4f(f+1)]^{\phi(c)/2} \equiv 1 \pmod{2^2} . \quad (\text{C.55})$$

Equations (C.51) and (C.55) imply

$$a^{\phi(2c)} \equiv 1 \pmod{2^2 c} . \quad (\text{C.56})$$

This concludes the proof. \square

Appendix D

Conformal field theory in two dimensions

D.1 Introduction

There is deep connection between Chern-Simons theory in three dimensions and two-dimensional conformal models. The '89 Field medal winning paper by Witten, which drew the attention of both mathematicians and physicists community on CS theory, is based heavily on the properties of the conformal blocks of the Wess-Zumino-Witten model. In this appendix we shall give a brief introduction to some widely used techniques in the study of conformally invariant models in two dimensions; with these tools in hand, we shall review the original Witten's solution of the Chern-Simons theory. This should permit a critical comparison with the alternative method presented in this thesis. Extensive reviews on CFT, with complete references, can be found for example in [65, 66, 67, 68], in particular in this appendix no attempt is made to touch important applications of conformal invariance to statistical mechanics.

D.2 Conformal invariance

Let us consider an n -dimensional manifold with a metric g . A diffeomorphism gives rise to a conformal transformation when

$$g'_{\mu\nu}(x') = e^{f(x)} g_{\mu\nu}(x) \quad , \quad (\text{D.1})$$

where $g'_{\mu\nu}(x')$ is the transformed metric. The infinitesimal form of (D.1) leads to the conformal Killing's equation

$$\nabla_{\mu}\epsilon_{\nu} + \nabla_{\nu}\epsilon_{\mu} = f g_{\mu\nu} \quad , \quad (\text{D.2})$$

the vector field ϵ^{μ} is the generator of the transformation. When g is the flat n -dimensional Euclidean metric η , Eq.(D.2) can easily be solved. The conformal group for n -dimensional Euclidean spacetime is isomorphic to $SO(n+1, 1)$; the $(n+2)(n+1)/2$ generators are associated with the following transformations:

1. rigid translations $x'^{\mu} = x^{\mu} + a^{\mu}$;
2. dilatations $x'^{\mu} = e^{\lambda} x^{\mu}$ with λ constant;
3. Lorentz transformations $x'^{\mu} = \Lambda^{\mu}_{\nu} x^{\nu}$;
4. special conformal transformations $x'^{\mu} = \frac{x^{\mu} - b^{\mu} x^2}{1 - 2b \cdot x + b^2 x^2}$, with b^{μ} a constant vector, and $x^2 = x^{\mu} x^{\nu} \eta_{\mu\nu}$.

Let us consider a Poincaré invariant classical field theory. By definition, the variation of the action under an infinitesimal local translation $x^\mu \rightarrow x^\mu + \epsilon(x)^\mu$ is proportional to the energy-momentum tensor

$$\delta S = \frac{1}{2} \int d^n x T^{\mu\nu} \partial_\mu \epsilon_\nu \quad . \quad (\text{D.3})$$

From the conformal Killing's equation (D.2), it follows that a sufficient condition for a Poincaré invariant theory to be conformal invariant is a traceless energy-momentum tensor. A scale invariant theory can always be provided with a traceless energy-momentum tensor, at least when $n > 2$. What happens when we try to quantize a classical scale invariant theory? At the quantum level one is in trouble from the very beginning, in order to make a quantum field theory meaningful the renormalization procedure must be undertaken. However, no matter which scheme one uses, renormalization spoils the classical scale invariance. Indeed, the values of the renormalized parameters of the theory must be provided at some arbitrary energy scale. The breaking of the scale-invariance in the quantum theory is made explicit by the Callan-Symanzik's equation for the renormalized correlation functions. In general, scale invariance at the quantum level is doomed to fail, however in some particular case there is a way to escape. There exist models for which one can fine tune the parameters in such a way that the beta function vanishes; in other words, the fixed point of the renormalization group in the space of the parameters is selected and scale invariance is recovered. Nevertheless, when $n \neq 2$, conformal invariance doesn't provide too stringent constraints: it enables one to fix the form of the two and three point function. On the contrary, in two dimensions something special happens: it turns out that the conformal group is infinite dimensional, or more precisely, the algebra of the infinitesimal conformal transformations is an infinite dimensional algebra, the celebrated Virasoro algebra.

Let us consider \mathbb{R}^2 equipped with the flat Euclidean metric. It is very useful to use instead of the standard coordinates t, x the following complex coordinates

$$z = t + ix \quad \bar{z} = t - ix \quad . \quad (\text{D.4})$$

Any vector v^μ can be expressed as

$$v^\alpha = (v^z, v^{\bar{z}}), \quad v^z = v^0 + iv^1, v^{\bar{z}} = v^0 - iv^1 \quad . \quad (\text{D.5})$$

In the new coordinates the metric becomes

$$\eta_{\alpha\beta} = \begin{pmatrix} 0 & \frac{1}{2} \\ \frac{1}{2} & 0 \end{pmatrix}, \quad \eta^{\alpha\beta} = \begin{pmatrix} 0 & 2 \\ 2 & 0 \end{pmatrix} \quad \alpha, \beta = z, \bar{z} \quad . \quad (\text{D.6})$$

We shall often use the following differential operators

$$\partial = \frac{1}{2} \left(\frac{\partial}{\partial t} - i \frac{\partial}{\partial x} \right), \quad \bar{\partial} = \frac{1}{2} \left(\frac{\partial}{\partial t} + i \frac{\partial}{\partial x} \right) \quad . \quad (\text{D.7})$$

The conformal Killing's equation for $\eta_{\alpha\beta}$ assumes a simple form

$$\begin{aligned} \bar{\partial}\epsilon &= 0, & \partial\bar{\epsilon} &= 0 \quad , \\ \partial\epsilon + \bar{\partial}\bar{\epsilon} &= -\frac{1}{2}f \quad , \end{aligned} \quad (\text{D.8})$$

with $\epsilon^z = \epsilon$ and $\bar{\epsilon} = \epsilon^{\bar{z}}$. Thus, infinitesimal conformal transformations are generated by holomorphic and anti-holomorphic vector fields. Moreover, consider the transformation

$$z \rightarrow z' = h(z), \quad \bar{z} \rightarrow \bar{z}' = \bar{h}(\bar{z}) \quad ; \quad (\text{D.9})$$

clearly it is a conformal transformation, indeed

$$ds^2 = 2\eta'_{z'\bar{z}'} dz' d\bar{z}' = 2\eta_{z\bar{z}} (\partial h \bar{\partial} \bar{h}) dz d\bar{z} \quad . \quad (\text{D.10})$$

By adding the point at infinity, $\mathbb{R}^2 \cup \{\infty\}$ can be identified with the Riemann sphere, equivalent, from a topological point of view, to S^2 . However, in general the transformations of the form (D.9) cannot be regarded as the finite version of conformal transformations associated with holomorphic and anti-holomorphic vector fields; actually, the only global holomorphic maps of S^2 into S^2 are the Moebius transformations

$$z \rightarrow \frac{az + b}{cz + d} \quad , \quad (\text{D.11})$$

with a, b, c, d are complex numbers satisfying $ad - cb = 1$. Put differently, the group of global holomorphic maps of S^2 is isomorphic with $SL(2, \mathbb{C})/\mathbb{Z}_2$. This result agrees with what we have found in the study of the general n -dimensional case, indeed $SO(3, 1) \sim SL(2, \mathbb{C})/\mathbb{Z}_2$. The existence of an infinite number of infinitesimal conformal transformations constrains severely a conformal invariant local field theory.

D.3 Conformal Ward identities

Let us consider the correlation function of some local operator $\Theta(x_1, \dots, x_n)$

$$\langle \Theta(x_1, \dots, x_n) \rangle = G_n(x_1, \dots, x_n) = \int D[\varphi] e^{-S[\varphi]} \Theta(x_1, \dots, x_n) \quad . \quad (\text{D.12})$$

The action functional $S[\varphi]$, which depends on a set of fields denoted symbolically by φ , is supposed to be invariant under rigid translations. Consider a local infinitesimal translation, i.e. $x^\mu \rightarrow x'^\mu = x^\mu + \epsilon^\mu$, $\varphi'(x) - \varphi(x) = \delta\varphi(x)$. The variation of the action is by definition the following

$$\delta S = -\frac{1}{2\pi} \int d^2x T^\mu{}_\nu \partial_\mu \epsilon^\nu \quad . \quad (\text{D.13})$$

Clearly, because φ is a dummy field in the path integral, the following identity holds

$$\int D[\varphi'] e^{-S[\varphi']} \Theta'(x_1, \dots, x_n) = \int D[\varphi] e^{-S[\varphi]} \Theta(x_1, \dots, x_n) \quad . \quad (\text{D.14})$$

The statement of invariance at the quantum level of the theory corresponds to the freedom in the path integral on the left hand side of eq.(D.14) to integrate over the old field φ instead of φ'

$$\int D[\varphi] e^{-S[\varphi']} \Theta'(x_1, \dots, x_n) = \int D[\varphi] e^{-S[\varphi]} \Theta(x_1, \dots, x_n) \quad . \quad (\text{D.15})$$

Eq.(D.15), in the case of an infinitesimal local translation, leads to

$$\int D[\varphi] e^{-S[\varphi]} \frac{1}{2\pi} \int d^2x T^\mu{}_\nu \partial_\mu \epsilon^\nu \Theta(x_1, \dots, x_n) = -\langle \delta\Theta(x_1, \dots, x_n) \rangle \quad . \quad (\text{D.16})$$

Consider a vector field which is non-vanishing only in a region D , by using the conservation of the energy-momentum tensor and Stokes's theorem, one obtains the following conformal Ward identity

$$\left\langle \frac{1}{2\pi i} \int_C (T \epsilon dz - \bar{T} \bar{\epsilon} d\bar{z}) \Theta(z_1, \dots, z_n; \bar{z}_1, \dots, \bar{z}_n) \right\rangle = \langle \delta\Theta(z_1, \dots, z_n; \bar{z}_1, \dots, \bar{z}_n) \rangle \quad , \quad (\text{D.17})$$

where

$$\begin{aligned} T(z) &= T_{zz}(z), & \bar{T}(\bar{z}) &= T_{\bar{z}\bar{z}}(\bar{z}) \quad , \\ \epsilon(z) &= \epsilon^z(z), & \bar{\epsilon}(\bar{z}) &= \epsilon^{\bar{z}}(\bar{z}) \quad . \end{aligned} \quad (\text{D.18})$$

The curve C , anti-clockwise oriented, bounds the region in which the vector field ϵ^μ is non-vanishing, and also contains the points x_1, \dots, x_n as shown in Fig.D.1. Note that the conservation of the energy-momentum tensor and his property of being traceless are expressed as

$$T^\mu_\mu = 0 \rightarrow T_{z\bar{z}} = T_{\bar{z}z} = 0 \quad , \quad (\text{D.19})$$

$$\partial_\mu T^{\mu\nu} = 0 \rightarrow \bar{\partial}T = 0 \quad \text{and} \quad \partial\bar{T} = 0 \quad . \quad (\text{D.20})$$

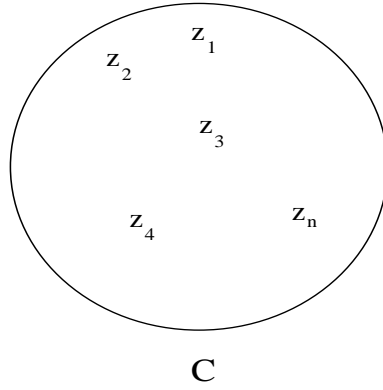

Figure D.1

D.4 Operator product expansion

A distinct role in conformal field theories is played by primary fields. A primary field $\phi(z, \bar{z})$ transforms under $z \rightarrow z'(z)$, $\bar{z} \rightarrow \bar{z}'(\bar{z})$ as

$$\phi(z', \bar{z}') = \left(\frac{dz'}{dz}\right)^{-h} \left(\frac{d\bar{z}'}{d\bar{z}}\right)^{-\bar{h}} \phi(z, \bar{z}) \quad , \quad (\text{D.21})$$

h and \bar{h} are by definition the conformal weights of the primary field ϕ . In particular, for an infinitesimal transformation

$$z'(z) = z + \epsilon(z), \quad \bar{z}'(\bar{z}) = \bar{z} + \bar{\epsilon}(\bar{z}) \quad , \quad (\text{D.22})$$

one gets

$$\delta\phi(z, \bar{z}) = -(\epsilon\partial + h\partial\epsilon)\phi(z, \bar{z}) - (\bar{\epsilon}\bar{\partial} + \bar{h}\bar{\partial}\bar{\epsilon})\phi(z, \bar{z}) \quad . \quad (\text{D.23})$$

Let us consider the consequences of eq.(D.17) for a primary field. By using eq.(D.23), the conformal Ward identity can be written as

$$\frac{1}{2\pi i} \int_{C_w} \langle T\epsilon\phi(w, \bar{w})dz \rangle = \langle (\epsilon\partial + h\partial\epsilon)\phi(w, \bar{w}) \rangle \quad . \quad (\text{D.24})$$

For simplicity, we have written only the holomorphic part, the anti-holomorphic part being completely analogous. As a consequence of Cauchy's theorem, eq.(D.24) determines the singular part, i.e the pole structure, of the product $T(z)\phi(w, \bar{w})$

$$T(z)\phi(w, \bar{w}) \sim \frac{1}{(z-w)}\partial\phi(w, \bar{w}) + \frac{h}{(z-w)^2}\phi(w, \bar{w}) \quad . \quad (\text{D.25})$$

The symbol \sim means that only the singular terms in the operator product expansion (OPE) are shown, on the other hand from eq.(D.24) only these singular terms can be determined. A similar expression is obtained for the OPE of the primary field ϕ with \bar{T}

$$\bar{T}(\bar{z})\phi(w, \bar{w}) \sim \frac{1}{(\bar{z}-\bar{w})}\bar{\partial}\phi(w, \bar{w}) + \frac{\bar{h}}{(\bar{z}-\bar{w})^2}\phi(w, \bar{w}) \quad . \quad (\text{D.26})$$

The consequences of the Ward identity are particular simple when a global conformal transformation is considered: the action is invariant and, in the absence of anomalies, the correlation functions must be conformally invariant

$$\langle \delta\Theta(z_1, \dots, z_n; \bar{z}_1, \dots, \bar{z}_n) \rangle = 0 \quad . \quad (\text{D.27})$$

Eq.(D.27) fixes the form of both the two and three point function for primary fields

$$\begin{aligned} \langle \phi_1(z_1, \bar{z}_1)\phi_2(z_2, \bar{z}_2) \rangle &= \frac{C_{12}}{(z_1-z_2)^{2h}(\bar{z}_1-\bar{z}_2)^{2\bar{h}}} \quad , \\ C_{12} &= \alpha_{12}\delta_{h_1, h_2}\delta_{\bar{h}_1, \bar{h}_2} \quad . \end{aligned} \quad (\text{D.28})$$

Unless the two primary fields have the same conformal weights, the two-point function vanishes; one can also normalize the field in such way that $\alpha_{12} = 1$. For the three-point function one has

$$\begin{aligned} \langle \phi_1(z_1, \bar{z}_1)\phi_2(z_2, \bar{z}_2)\phi_3(z_3, \bar{z}_3) \rangle &= C_{123} \frac{1}{z_{12}^{h_1+h_2-h_3} z_{23}^{h_2+h_3-h_1} z_{13}^{h_1+h_3-h_2}} \\ &\quad \frac{1}{\bar{z}_{12}^{\bar{h}_1+\bar{h}_2-\bar{h}_3} \bar{z}_{23}^{\bar{h}_2+\bar{h}_3-\bar{h}_1} \bar{z}_{13}^{\bar{h}_1+\bar{h}_3-\bar{h}_2}} \quad . \end{aligned} \quad (\text{D.29})$$

D.5 Central charge

As we have seen, the singular part of the OPE of a generic field with the energy-momentum tensor is determined by the behaviour of that field under an infinitesimal conformal transformation. In particular, it is interesting to study the OPE of T with itself.

By setting $\Theta = 1$ in eq.(D.17), it follows that

$$\langle \int_C T(z)\epsilon(z) dz \rangle = 0 \quad . \quad (\text{D.30})$$

In particular, when a global conformal transformation is considered, $\epsilon(z) \sim z^2$ and the curve C can be taken as a circle surrounding the origin with an arbitrary radius. In order that eq.(D.30) holds, one needs that $T(z) \sim z^4$ as $|z| \rightarrow \infty$. Moreover, by using translation and dilatation invariance, one can show that

$$\begin{aligned} \langle T(z)T(0) \rangle &= \frac{c}{2} \frac{1}{z^4} \quad , \\ \langle \bar{T}(\bar{z})\bar{T}(0) \rangle &= \frac{c}{2} \frac{1}{\bar{z}^4} \quad , \end{aligned} \quad (\text{D.31})$$

where c is a constant. From eq.(D.31) and from eq.(D.17), with $\Theta = T(0)$, one has that

$$\frac{1}{2\pi i} \int_C \frac{c}{2} \frac{\epsilon(z)}{z^4} dz = -\langle \delta T(0) \rangle \quad , \quad (\text{D.32})$$

thus

$$\langle \delta T(0) \rangle = -\frac{c}{12} \frac{d^3 \epsilon}{dz^3} \Big|_{z=0} \quad . \quad (\text{D.33})$$

On the one hand the energy-momentum tensor transforms as a primary field with weight 2 under a global conformal transformation, on the other hand eq.(D.33) shows a non primary behaviour under a generic infinitesimal conformal transformation. The minimal assumption, consistent both with eq.(D.33) and with the primary behaviour of $T(z)$ under $SL(2, \mathbb{C})$ is the following

$$\delta T(z) = -\frac{c}{12} \frac{d^3 \epsilon}{dz^3} - 2T(z) \partial \epsilon(z) - \epsilon(z) \partial T(z) \quad . \quad (\text{D.34})$$

The conformal Ward identity and eq.(D.34) lead to the OPE

$$T(z) T(0) \sim \frac{c/2}{z^4} + \frac{2}{z^2} T(0) + \frac{1}{z} \partial T(0) \quad , \quad (\text{D.35})$$

$$\bar{T}(\bar{z}) \bar{T}(0) \sim \frac{c/2}{\bar{z}^4} + \frac{2}{\bar{z}^2} \bar{T}(0) + \frac{1}{\bar{z}} \bar{\partial} \bar{T}(0) \quad . \quad (\text{D.36})$$

Finally, the independent character of the transformations on z and \bar{z} leads to

$$T(z) \bar{T}(0) \sim 0 \quad . \quad (\text{D.37})$$

The constant c in the OPE is the central charge. Eq.(D.33) can be integrated to obtain the behaviour of the energy-momentum tensor under finite transformations, the result is

$$T'(z') = \left(\frac{dz'}{dz} \right)^{-2} \left[T(z) - \frac{c}{12} \{z', z\} \right] \quad . \quad (\text{D.38})$$

Where $\{f(z), z\}$ is the Schwarzian derivative, defined as

$$\{f(z), z\} = \left(\frac{d^3 f}{dz^3} \right)^2 \left(\frac{df}{dz} \right)^{-1} - \frac{3}{2} \left(\frac{d^2 f}{dz^2} \right)^2 \left(\frac{df}{dz} \right)^{-2} \quad . \quad (\text{D.39})$$

One can verify that $\{w(z), z\} = 0$, when

$$w(z) = \frac{az + b}{cz + d} \quad ad - bc = 1 \quad . \quad (\text{D.40})$$

In general, a field transforming as a primary one under a global conformal transformation is called quasi-primary.

As a simple example, one can consider a free scalar field; it is straightforward to verify that $c = 1$; the energy momentum-tensor is defined by considering the normal ordered classical expression. Also the case of a free Majorana fermion can be easily worked out; one finds $c = 1/2$. Because the energy-momentum tensor for non-interacting fields is the sum of the energy-momentum tensors associated with the single fields, the central charge is additive for these models. From a physical point of view, the central charge probes the behaviour of the theory when a macroscopic scale is introduced. As an example, let us consider a theory on \mathbb{R}^2 , and define the energy-momentum tensor such that

$$\langle T(z) \rangle \Big|_{plane} = 0 \quad . \quad (\text{D.41})$$

One can map the complex plane into a cylinder of radius L by the following conformal transformation (note that is not a globally holomorphic map)

$$z \rightarrow w = \frac{L}{2\pi} \ln z \quad . \quad (\text{D.42})$$

By using eq.(D.38), the expectation value of the energy momentum-tensor in the cylinder is given by

$$\langle T(z) \rangle|_{cyl.} = -\frac{c\pi^2}{6L^2} \quad . \quad (\text{D.43})$$

A Casimir energy, proportional to the central charge has come out.

D.6 Virasoro algebra

Up to now we have used the path integral formalism; no operator acting on some Hilbert space has been introduced; in this section we shall fill the gap. In conformal field theory there exists a peculiar way to introduce the canonical formalism: the radial quantization. The idea is to choose as monotonic “time” coordinate on the complex plane simply $\ln|z|$; as a result, the equal time lines will be circles around the origin. Given two bosonic operators $\varphi_1(z_1)$ and $\varphi_2(z_2)$, the radial ordering is naturally defined as

$$\mathcal{R}(\varphi_1(z_1) \varphi_2(z_2)) \begin{cases} \varphi_1(z_1) \varphi_2(z_2) & \text{if } |z_1| > |z_2| \\ \varphi_2(z_2) \varphi_1(z_1) & \text{if } |z_2| > |z_1| \end{cases} \quad . \quad (\text{D.44})$$

If no specified, operators are understood to be radial ordered. The radial quantization is particularly useful because one can represent the commutator between the “charge” operator associated with a symmetry and a local operator as a contour integral. Indeed, define the operator \mathcal{A} as

$$\mathcal{A} = \oint a(z) dz \quad . \quad (\text{D.45})$$

For contour integrals we shall use the following notation: when no specified, the contour surround the origin, otherwise \oint_w denotes a contour integral around the point w . From the definition of radial order and from the holomorphic character of the fields, it follows that

$$[\mathcal{A}, \varphi(w)] = \oint_w a(z) \varphi(w) dz \quad . \quad (\text{D.46})$$

Eq.(D.46) is remarkable; given the charge operator \mathcal{A} , the action of the associated symmetry on a local field is determined only by the singular terms appearing in the OPE between the current from which the charge is derived and the local operator. A key role is played in conformal field theory by the current associated with local conformal symmetries: the energy-momentum tensor. Let us consider the charge

$$Q_\epsilon = \oint \epsilon(z) T(z) dz \quad (\text{D.47})$$

From eq.(D.23) one has

$$\delta\phi(z) = -(\epsilon\partial + h\partial\epsilon)\phi(z) = [Q_\epsilon, \phi(z)] \quad . \quad (\text{D.48})$$

As usual, a similar relation for the anti-holomorphic part is understood. One can Laurent expand $T(z)$ around the origin in terms of modes

$$T(z) = \sum_{n \in \mathbb{Z}} z^{-n-2} L_n \quad , \quad (\text{D.49})$$

$$L_n = \frac{1}{2\pi i} \oint z^{n+1} T(z) dz \quad . \quad (\text{D.50})$$

Similarly for the anti-holomorphic part one has

$$\bar{T}(\bar{z}) = \sum_{n \in \mathbb{Z}} \bar{z}^{-n-2} \bar{L}_n \quad , \quad (\text{D.51})$$

$$\bar{L}_n = \frac{1}{2\pi i} \oint \bar{z}^{n+1} \bar{T}(\bar{z}) d\bar{z} \quad . \quad (\text{D.52})$$

The charge Q_ϵ can be expressed in terms of modes L_n as

$$Q_\epsilon = \sum_{n \in \mathbb{Z}} \epsilon_n L_n \quad , \quad (\text{D.53})$$

with

$$\epsilon(z) = \sum_{n \in \mathbb{Z}} \epsilon_n z^{n+1} \quad . \quad (\text{D.54})$$

By using Eq.(D.35), (D.36) and the mode expansion of the energy momentum tensor, one can easily derive the commutation relations between $\{L_n\}$ and $\{\bar{L}_n\}$. The result is

$$[L_n, L_m] = (n - m) L_{n+m} + \frac{c}{12} n(n^2 - 1) \delta_{n+m,0} \quad , \quad (\text{D.55})$$

$$[\bar{L}_n, \bar{L}_m] = (n - m) \bar{L}_{n+m} + \frac{c}{12} n(n^2 - 1) \delta_{n+m,0} \quad ; \quad (\text{D.56})$$

$$[L_n, \bar{L}_m] = 0 \quad . \quad (\text{D.57})$$

The operators $\{L_n, \bar{L}_m\}$, together with the commutation relations of eq.(D.57), represent a pair of infinite dimensional algebras $Vir \times \bar{Vir}$. The algebra Vir is the Virasoro algebra. The sub-algebra generated by $\{L_{\pm 1}, L_0\}$ is associated with global conformal transformations. In particular L_0 is the generator of dilatations, as one can infer from

$$[L_n, \phi(w, \bar{w})] = h(n+1) w^n \phi(w, \bar{w}) + w^{n+1} \partial \phi(w, \bar{w}) \quad n \geq -1 \quad . \quad (\text{D.58})$$

In the radial quantization, dilatations correspond to “time” translations, thus $L_0 + \bar{L}_0$, apart from an additive constant, plays the role of the Hamiltonian. In particular, if one sets to zero its vacuum expectation in the case of plane geometry, it follows that

$$H = L_0 + \bar{L}_0 - \frac{c}{12} \quad . \quad (\text{D.59})$$

D.7 The Hilbert space

In quantum field theory one postulates the existence of a cyclic vacuum state $|0\rangle$ from which the entire Hilbert space is built up by acting on $|0\rangle$ with local operators. To any primary field $\phi(z, \bar{z})$ one associates an asymptotic “in” state by

$$|\phi\rangle = \lim_{z, \bar{z} \rightarrow 0} \phi(z, \bar{z}) |0\rangle \quad . \quad (\text{D.60})$$

Given a quasi-primary field $\phi(z, \bar{z})$ its Hermitian conjugate is defined as

$$[\phi(z, \bar{z})]^\dagger = \bar{z}^{-2h} z^{-2\bar{h}} \phi(1/\bar{z}, 1/z) \quad . \quad (\text{D.61})$$

The definition (D.61) is chosen in such way that the scalar product $\langle \phi_{out} | \phi_{in} \rangle = \langle 0 | \phi_{in}^\dagger \phi_{in} | 0 \rangle$ is well defined, as one can verify from the explicit form (D.28) for the two-point function.

As we have seen, the algebra $Vir \times \bar{Vir}$ generates the fundamental symmetries of a conformal invariant theory, then it is natural to seek for a Hilbert space carrying a representation of this algebra. First of all, note that the requirement of invariance of the vacuum state under global conformal transformations and that $T(z)|0\rangle$ makes sense (as well as its anti-holomorphic counterpart), lead to

$$L_n |0\rangle = 0, \quad \bar{L}_n |0\rangle = 0 \quad n \geq -1 \quad . \quad (\text{D.62})$$

A highest weight representation of $Vir \times \bar{Vir}$, or more precisely a module, is obtained starting from the highest weight state

$$|h, \bar{h}\rangle = \phi(0, 0) |0\rangle \quad . \quad (\text{D.63})$$

Because the holomorphic and anti-holomorphic parts of the algebra commute, they can be analyzed separately; once a relation involving the holomorphic part is found, the same relation for the anti-holomorphic part holds, for this reason we shall pay attention to the holomorphic part only. From (D.58) it follows that $|h, \bar{h}\rangle$ is an eigenstate with eigenvalue h

$$L_0 |h, \bar{h}\rangle = h |h, \bar{h}\rangle \quad . \quad (\text{D.64})$$

On the other hand, eq.(D.62), together with the Virasoro algebra show that L_{-n} with $n > 0$ act as raising operators. Indeed

$$L_0 L_{-k_1} \cdots L_{-k_n} |h, \bar{h}\rangle = (h + k_1 + \cdots + k_n) |h, \bar{h}\rangle \quad . \quad (\text{D.65})$$

The state $L_{-k_1} \cdots L_{-k_n} |h, \bar{h}\rangle$ is called a descendent of level $N = \sum_i k_n$. Note that, as a consequence of the Virasoro algebra, states at different levels are orthogonal. The subset spanned by $|h, \bar{h}\rangle$ and its descendents is closed under the action of $Vir \times \bar{Vir}$, this subset is called a Verma module. Each Verma module is determined by the central charge c and the conformal weight h, \bar{h} of the primary field corresponding to the highest weight state. The full module is the direct sum of the various Verma modules \mathcal{V} associated with the primary fields of the theory

$$\mathcal{H} = \sum_i \mathcal{V}(c, h_i) \otimes \bar{\mathcal{V}}(c, \bar{h}_i) \quad . \quad (\text{D.66})$$

In general, given $\mathcal{V}(c, h)$, negative norm states can be present. The Verma modules in which all the states have positive norm are called unitary. From a physical point of view, unitary Verma modules are particularly important, in this case \mathcal{H} is a Hilbert space. Necessary conditions for unitary Verma modules are clearly $c \geq 0$ and $h, \bar{h} \geq 0$. In particular, when $0 < c < 1$, a discrete series of unitary Verma modules can be found (minimal models); remarkably, among them one can find well known statistical models like Ising, tricritical Ising, 3 state Potts. One of the crucial property of minimal models, is the existence of states of null norm; we shall see that this fact gives rise to non trivial constraints on the operator algebra.

D.8 Operator algebra and conformal blocks

Descendent states can be obtained from the highest weight state by applying L_{-n} with $n > 0$; it is natural to define the corresponding descendent fields

$$L_{-n} |h, \bar{h}\rangle = L_{-n} \phi(0, 0) |0\rangle = \phi^{(-n)}(0, 0) |0\rangle \quad n > 0 \quad . \quad (\text{D.67})$$

A similar definition can be given for $\phi^{(k_1, \dots, k_n)}$. In general the holomorphic field $(L_n \phi)(w)$ is defined in terms of the mode expansion of $T(z)\phi(w)$ around w

$$T(z)\phi(w) = \sum_{n \in \mathbb{Z}} (z-w)^{-n-2} (L_n \phi)(w) \quad . \quad (\text{D.68})$$

Singular terms can be determined by using the OPE between $T(z)$ and $\phi(w)$, the regular part is given by Taylor expansion. A primary field ϕ , together with all its descendents is called the conformal family of ϕ . An important consequence of OPE is that correlation functions involving descendent fields and primary fields can be expressed in terms of correlation functions of primary fields only. Indeed

$$\langle \phi^{(-k_1)} \dots \phi^{(-k_n)}(w) \phi_1(w_1) \dots \phi_n(w_n) \rangle = \mathcal{D}_{-k_1} \dots \mathcal{D}_{-k_n} \langle \phi(w) \phi_1(w_1) \dots \phi_n(w_n) \rangle \quad , \quad (\text{D.69})$$

where the differential operator \mathcal{D}_{-k_m} is defined as

$$\mathcal{D}_{-k_i} = \sum_{i=1}^m \left[\frac{(m-1)h_i}{(w_i-w)^n} - \frac{1}{(w_i-w)^{n-1}} \partial_{w_i} \right] \quad . \quad (\text{D.70})$$

Eq.(D.69) implies that all the correlation functions of the theory can be worked out from the knowledge of the primary fields correlation functions. Moreover, because the form of the two-point function is completely constrained by global conformal invariance (see eq.(D.28)), when one is able to produce the complete OPE (regular term included) between primary fields, all the correlation functions can be calculated and the theory is solved. The OPE between two primary fields can be written as

$$\phi_i(z, \bar{z}) \phi_j(0, 0) = \sum_p \sum_{\{k, \bar{k}\}} C_{ij}^{p\{k, \bar{k}\}} z^{h_p - h_i - h_j + K} \bar{z}^{\bar{h}_p - \bar{h}_i - \bar{h}_j + \bar{K}} \phi_p^{\{k, \bar{k}\}}(0, 0) \quad , \quad (\text{D.71})$$

where $\phi_p^{\{k, \bar{k}\}}$ represents a generic element of the conformal family of ϕ_p , and $K = \sum_i k_i$, $\bar{K} = \sum_i \bar{k}_i$. The dependence on z, \bar{z} is fixed by global conformal invariance. Given a conformal theory, the set of all OPE's between primary fields gives rise to the so called conformal algebra. As we have seen, the knowledge of the conformal algebra amounts to solve the theory. One can show that

$$C_{ij}^{p\{k, \bar{k}\}} = C_{ij}^p \beta_{ij}^{\{k\}} \bar{\beta}_{ij}^{\{\bar{k}\}} \quad , \quad (\text{D.72})$$

where C_{pij} are the same coefficients appearing in the three point function in eq.(D.29). Moreover, $\beta_{ij}^{\{k\}}$ and $\bar{\beta}_{ij}^{\{\bar{k}\}}$ can be computed from the definition in terms of the conformal weights and the central charge. Thus, the conformal algebra is determined by the coefficients C_{pij} involved in the three-point function.

Clearly, it would be nice to have some constraints on C_{pij} ; with this goal in mind, let us consider the following matrix element

$$G_{34}^{21}(X, \bar{X}) = \langle h_1, \bar{h}_1 | \phi_2(1, 1) \phi_3(X, \bar{X}) | h_4, \bar{h}_4 \rangle \quad . \quad (\text{D.73})$$

The matrix element can be expressed in terms of the four-point function which, by global conformal invariance, depends only on the anharmonic ratios

$$X = \frac{(z_1 - z_2)(z_3 - z_4)}{(z_1 - z_3)(z_2 - z_4)} \quad , \quad \bar{X} = \frac{(\bar{z}_1 - \bar{z}_2)(\bar{z}_3 - \bar{z}_4)}{(\bar{z}_1 - \bar{z}_3)(\bar{z}_2 - \bar{z}_4)} \quad . \quad (\text{D.74})$$

By an $SL(2, \mathbb{Z})$ transformation one can set $z_4 = 0$, $z_1 = \infty$, $z_2 = 1$, thus $z_3 = X$. By using the conformal algebra to contract ϕ_3 with ϕ_2 , one gets

$$G_{34}^{21}(X, \bar{X}) = \sum_p C_{12}^p C_{34}^p \mathcal{A}_{34}^{21}(p|X, \bar{X}) \quad , \quad (\text{D.75})$$

in eq.(D.75) we have defined

$$\mathcal{A}_{34}^{21}(p|X, \bar{X}) = (C_{12}^p)^{-1} X^{h_p - h_3 - h_4} \bar{X}^{\bar{h}_p - \bar{h}_3 - \bar{h}_4} \sum_{\{k, \bar{k}\}} \beta_{34}^{\{k\}} \bar{\beta}_{34}^{\{\bar{k}\}} X^K \bar{X}^{\bar{K}} \langle h_1, \bar{h}_1 | \phi_2(1, 1) \phi_p^{\{k, \bar{k}\}}(0, 0) | 0 \rangle. \quad (\text{D.76})$$

As usual, the holomorphic and anti-holomorphic parts factorize

$$\mathcal{A}_{34}^{21}(p|X, \bar{X}) = \mathcal{F}_{34}^{21}(p|X) \bar{\mathcal{F}}_{34}^{21}(p|\bar{X}) \quad . \quad (\text{D.77})$$

The holomorphic and anti-holomorphic parts of \mathcal{A} are called holomorphic conformal blocks and anti-holomorphic conformal blocks respectively, and they can recursively be calculated by the definition in terms of conformal weights and the central charge. When expressed in terms of conformal blocks, eq.(D.75) becomes

$$G_{34}^{21}(X, \bar{X}) = \sum_p C_{12}^p C_{34}^p \mathcal{F}_{34}^{21}(p|X) \bar{\mathcal{F}}_{34}^{21}(p|\bar{X}) \quad . \quad (\text{D.78})$$

Conformal blocks can be understood as intermediate states entering the decomposition of the four-point function. We note that by using global conformal invariance one can equivalently set $z_2 = 0$, $z_4 = 1$, $z_1 = \infty$, thus $z_3 = 1 - X$, and contract ϕ_3 with ϕ_4 , put differently, the conformal algebra must be associative. One obtains

$$G_{34}^{21}(X, \bar{X}) = G_{32}^{41}(1 - X, 1 - \bar{X}) \quad . \quad (\text{D.79})$$

Eq.(D.79) constrains the conformal algebra, namely C_{ij}^p ; indeed

$$\sum_p C_{nm}^p C_{lk}^p \mathcal{F}_{nm}^{kl}(p|X) \bar{\mathcal{F}}_{nm}^{kl}(p|\bar{X}) = \sum_p C_{nk}^p C_{lm}^p \mathcal{F}_{nk}^{ml}(p|1 - X) \bar{\mathcal{F}}_{nk}^{ml}(p|1 - \bar{X}) \quad . \quad (\text{D.80})$$

Eq.(D.80) shows a crossing symmetry in the decomposition of the four-point function by using the conformal algebra. The program to determine the $\{C_{ij}^p\}$ from Eq.(D.80) is called conformal bootstrap. Whether the bootstrap program is viable in a generic conformal field theory is an open problem, however, notably, it works for minimal models.

D.9 Fusion rules

The fundamental objects entering the OPE between two primary fields are the coefficients $\{C_{ij}^p\}$, they determine which conformal families appear in the decomposition. One can focus the attention on this aspect by defining the fusion coefficients as

$$\mathcal{N}_{ij}^p = \begin{cases} 0 & \text{if } C_{ij}^p = 0 \\ 1 & \text{otherwise} \end{cases} \quad . \quad (\text{D.81})$$

By using the fusion coefficients, the OPE between two primary fields can be represented in a compact way as

$$\phi_i \times \phi_j = \sum_p \mathcal{N}_{ij}^p \phi_p \quad . \quad (\text{D.82})$$

The rule given in Eq.(D.82) is used to define an associative algebra called fusion algebra. In particular, the conformal family corresponding to the unity operator 1 gives rise to trivial fusion rules

$$\mathcal{N}_{i1}^p = \delta_i^p \quad . \quad (\text{D.83})$$

At this level, the crossing symmetry of the conformal algebra translates into the associativity of the fusion algebra, explicitly

$$\sum_p \mathcal{N}_{jm}^p \mathcal{N}_{ip}^n = \sum_s \mathcal{N}_{ij}^s \mathcal{N}_{sm}^n \quad . \quad (\text{D.84})$$

We note that defining the matrix (N_i) by

$$(N_i)_{jm} = \mathcal{N}_{ij}^m \quad , \quad (\text{D.85})$$

eq.(D.84) can be interpreted as

$$N_i \cdot N_j = N_j \cdot N_i \quad , \quad (\text{D.86})$$

the dot denotes the standard matrix multiplication. The set of matrices $\{N_i\}$ is Abelian. As a linear space, $\{N_i\}$, give rise to the regular representation of the fusion algebra by means of Eq.(D.84); the action of N_i on N_j is defined as

$$N_i(N_j) = \sum_s \mathcal{N}_{ij}^s N_s \quad . \quad (\text{D.87})$$

One of the non trivial consequences of the existence of a null vector in a Verma module is a constraint on the possible values of the fusion coefficients.

D.10 Wess-Zumino-Witten model

As an important example of CFT we shall discuss in this section the Wess-Zumino-Witten (WZW) with a compact and simple Lie group G . For our purpose, it turns out that the WZW model is paradigmatic, it has been conjectured that all rational conformal field theories can be obtained from it by the coset construction.

The starting point is a bosonic σ -model with the group manifold of G as the target space; the action is

$$S_\sigma[g] = \frac{1}{4\lambda^2} \int d^2x \text{Tr} (\partial^\mu g^{-1} \partial_\mu g) \quad . \quad (\text{D.88})$$

The field g takes values in G ; the trace is defined as in Chap.1. The action (D.88) is invariant under a local $G \times G$ transformation

$$S_\sigma [h g(x) h'^{-1}] = S_\sigma[g] , \quad h, h' \in G \quad . \quad (\text{D.89})$$

Unfortunately, the classical conformal invariance does not survive at the quantum level; the β -function is different from zero, and the model is asymptotically free. To solve this problem, Witten proposed to add a Wess-Zumino term to S_σ , the new action of the model is

$$S_\sigma[g] - i\kappa \Gamma_{M_3}[\tilde{g}] \quad . \quad (\text{D.90})$$

The boundary Σ of the 3-manifold M_3 is the world sheet of the σ -model; we mainly focus our attention on $\Sigma = S^2$. The field \tilde{g} , living in M_3 , is an extension of g on M_3 . The extension exists

because $\pi_2(G) = 0$, thus the maps $g : S^2 \rightarrow G$ are all homotopically equivalent. Moreover, one can find $g_t : [0, 1] \times S^2 \rightarrow G$ with $g_{t=0} = g$, and $g_{t=1}$ the constant map on S^2 . The extension is defined by taking $M_3 = B^3$, where B^3 is the three ball with $\partial B^3 = S^2$. The extension is not unique; however by taking k integer, the quantum partition function is well defined. This can be understood as follows. The difference between two extensions can be written as

$$\Delta = \Gamma_{M_3} - \Gamma_{M'_3} = \Gamma_M \quad , \quad (\text{D.91})$$

where $\partial M_3 = \partial M'_3 = S^2$, and $M = M_3 \cup M'_3$ is a compact 3-manifold homeomorphic to S^3 . From the analysis of Chap. 1 it follows that $\Gamma_M = m$, where m is an integer. Thus, the quantum theory will be independent by the chosen extension when κ is an integer.

The Wess-Zumino-Witten model is defined by setting $\lambda^2 = 4\pi/\kappa$; this particular value of λ corresponds to the vanishing of the one loop β -function. The WZW action can be written as

$$S_{WZW} = \frac{\kappa}{16\pi} \int d^2x \text{Tr} (\partial^\mu g^{-1} \partial_\mu g) - i\kappa \Gamma[\tilde{g}] \quad . \quad (\text{D.92})$$

As it is shown in App.A, the variation of the Wess-Zumino term is a boundary term; as a result, the variational principle for S_{WZW} is well defined and it leads to the following equations of motion

$$\partial \bar{J}(\bar{z}) = 0 \quad , \quad (\text{D.93})$$

$$\bar{J}(\bar{z}) = \kappa g^{-1} \bar{\partial} g \quad . \quad (\text{D.94})$$

Eq.(D.94) also implies the existence of a conserved holomorphic current:

$$\bar{\partial} J(z) = 0 \quad , \quad (\text{D.95})$$

$$J(z) = -\kappa \partial g g^{-1} \quad . \quad (\text{D.96})$$

D.10.1 The Kac-Moody algebra

The holomorphic and anti-holomorphic currents that appear in the equations of motion are associated with a new invariance of the WZW model. Namely, the global $G \times G$ global invariance of the σ -model is enhanced to

$$g \rightarrow \Omega(z) g \bar{\Omega}^{-1}(\bar{z}) \quad , \quad \Omega(z), \bar{\Omega}(\bar{z}) \in G \quad . \quad (\text{D.97})$$

The invariance of S_{WZW} under the transformation (D.97) can be established by using the Polyakov-Wiegman identity

$$S_{WZW} [gh^{-1}] = S_{WZW} [g] + S_{WZW} [h^{-1}] = \frac{k}{2\pi} \int d^2x \text{Tr} (g^{-1} \bar{\partial} g h^{-1} \partial h) \quad , \quad (\text{D.98})$$

which can be derived from eq.(A.12) in App.A. The invariance (D.97) gives rise to the following Ward identity

$$\left\langle \frac{1}{2\pi i} \left[\oint dz \omega^a(z) J_a(z) + \oint d\bar{z} \bar{\omega}^a(\bar{z}) \bar{J}_a(\bar{z}) \right] \Theta \right\rangle = -\delta_{\omega, \bar{\omega}} \langle \Theta \rangle \quad , \quad (\text{D.99})$$

with

$$\begin{aligned} J(z) &= t_a J^a(z), & \bar{J}(\bar{z}) &= t_a \bar{J}^a(\bar{z}) \quad , \\ \Omega(z) &= 1 + \omega^a(z) t_a + \dots \quad , \\ \bar{\Omega}(\bar{z}) &= 1 + \bar{\omega}^a(\bar{z}) t_a + \dots \quad . \end{aligned} \quad (\text{D.100})$$

In eq.(D.100) we have introduced the generators $\{t_a\}$ of G ; we do not use capital letters in order to avoid confusion with the energy-momentum tensor. Setting in (D.99) $\Theta = J(w)$ or $\Theta = \bar{J}(\bar{z})$, one easily gets the following OPE

$$\begin{aligned} J_a(z) J^b(w) &\sim \frac{\kappa \delta_{ab}}{(z-w)^2} + i f_{ab}^c \frac{J_c(w)}{(z-w)} \quad , \\ \bar{J}_a(\bar{z}) \bar{J}^b(\bar{w}) &\sim \frac{\kappa \delta_{ab}}{(\bar{z}-\bar{w})^2} + i f_{ab}^c \frac{\bar{J}_c(\bar{w})}{(\bar{z}-\bar{w})} \quad , \\ J_a(z) \bar{J}^b(\bar{w}) &\sim 0 \quad . \end{aligned} \tag{D.101}$$

In the operator formalism, the OPE (D.101) translates into the Kac-Moody algebra for the current modes

$$\begin{aligned} [J_n^a, J_m^b] &= i f_{abc} J_{n+m}^c + \kappa n \delta_{ab} \delta_{0, n+m} \quad , \\ [\bar{J}_n^a, \bar{J}_m^b] &= i f_{abc} \bar{J}_{n+m}^c + \kappa n \delta_{ab} \delta_{0, n+m} \quad , \\ [J_n^a, \bar{J}_m^b] &= 0 \quad , \end{aligned} \tag{D.102}$$

with

$$J^a(z) = \sum_{n \in \mathbb{Z}} z^{-1-n} J_n^a, \quad \bar{J}^a(\bar{z}) = \sum_{n \in \mathbb{Z}} \bar{z}^{-1-n} \bar{J}_n^a \quad . \tag{D.103}$$

The currents are associated with a pair of the affine Lie algebras $\hat{g}_\kappa \times \bar{\hat{g}}_\kappa$ at level κ ; \hat{g}_κ is also known as Kac-Moody algebra in the physics literature.

D.10.2 The Sugawara construction

Beside the current algebra, the WZW model is also conformal invariant; to study this aspect one has to define the energy-momentum tensor. From the classical definition one finds that $T(z)$ is proportional to $J^a(z)J^a(z)$. At the quantum level this expression is ill defined; the usual normal ordering procedure fails because the WZW model is not a free theory; moreover the normalization of $T(z)$ is fixed by the OPE, a consistent definition of $T(z)$ must be in agreement eq.(D.35). A suitable definition of $T(z)$ (a parallel analysis can be given for \bar{T}) is the following

$$T(z) = \gamma (J^a J^a)_{reg.}(z) \quad . \tag{D.104}$$

where $(\)_{reg.}$ means that in the OPE only the regular terms must be retained, the constant γ is determined by imposing eq.(D.35) for the energy momentum tensor. In terms of modes, the prescription (D.104) is equivalent to push all the J_n with $n < 0$ to the left of the operators J_m with $m > 0$, this clearly resembles the normal ordering for non interacting field theories. The value of γ is given by

$$\gamma = \frac{1}{2(\kappa + c_v)} \quad , \tag{D.105}$$

where c_v is the value of the quadratic Casimir in the adjoint representation, defined as $f_{acd}f_{bcd} = c_v \delta_{ab}$. The form of the energy-momentum tensor, quadratic in the Kac-Moody currents is known as the Sugawara form. The central charge is given by

$$c = \frac{\kappa D}{\kappa + c_v} \quad , \tag{D.106}$$

where D is the dimension of the Lie algebra. The explicit form of the Virasoro generators is the following

$$L_n = \frac{1}{2(\kappa + c_v)} \left[\sum_{m \leq -1} J_m^a J_{n-m}^a + \sum_{m \geq 0} J_{n-m}^a J_m^a \right] . \quad (\text{D.107})$$

D.10.3 Primary fields and integrable representations

Conformal primary fields are the fundamental objects in CFT; as we have seen, they encode all the wanted information. In the WZW model the situation is slightly different; the fundamental symmetry is contained in the Kac-Moody algebra; since the energy-momentum tensor is expressed in terms of the Kac-Moody currents, it is natural to guess that the notion of primary field is related to the transformation property under the $G(z) \times G(\bar{z})$ symmetry. A WZW primary field $\phi_{\lambda,\mu}(z, \bar{z})$ in the WZW is defined to transform in a covariant way under $G(z) \times G(\bar{z})$, namely

$$\phi_{\lambda,\mu}(z, \bar{z}) \rightarrow \Omega_\lambda \phi_{\lambda,\mu}(z, \bar{z}) \bar{\Omega}_\mu(\bar{z}) \quad , \quad (\text{D.108})$$

λ is the highest weight of the representation $\Omega_\lambda(z)$, and μ is the highest weight of the representation $\bar{\Omega}_\mu(\bar{z})$. Because of the Ward identity (D.99), Eq.(D.108) is equivalent to the following OPE

$$J^a(z) \phi_{\lambda,\mu}(w, \bar{w}) \sim \frac{-t_\lambda^a \phi_{\lambda,\mu}(w, \bar{w})}{(z-w)} \quad , \quad (\text{D.109})$$

$$\bar{J}^a(\bar{z}) \phi_{\lambda,\mu}(w, \bar{w}) \sim \frac{\phi_{\lambda,\mu}(w, \bar{w}) t_\mu^a}{(\bar{z}-\bar{w})} \quad . \quad (\text{D.110})$$

In the previous equation matrix multiplication is understood. In particular the field g is itself WZW primary. We shall see that restricting oneself to finite dimensional representation of G in the definition of WZW primaries is not a limitation. As usual, to each primary field one associates an “in” state

$$|\phi_\lambda\rangle = \phi_\lambda(0) |0\rangle \quad . \quad (\text{D.111})$$

From the OPE (D.110) it is easy to derive the following commutation relations

$$[J_n^a, \phi_\lambda(w)] = -t_\lambda^a \phi_\lambda(w) w^n \quad n \geq 0 \quad . \quad (\text{D.112})$$

Thus, the definition of a primary field in eq.(D.110) can be restated as

$$J_0^a |\phi_\lambda\rangle = -t_\lambda^a \quad , \quad (\text{D.113})$$

$$J_n^a |\phi_\lambda\rangle = 0 \quad n > 0 \quad . \quad (\text{D.114})$$

By using eq.(D.112) and eq.(D.107) it is straightforward to show that a WZW primary is also a Virasoro primary; indeed

$$L_0 |\phi_\lambda\rangle = h_\lambda |\phi_\lambda\rangle, \quad L_n |\phi_\lambda\rangle = 0 \quad n > 0 \quad , \quad (\text{D.115})$$

with

$$h_\lambda = \frac{c_\lambda}{2(\kappa + c_v)} \quad , \quad (\text{D.116})$$

where c_λ is the value of the quadratic Casimir in the representation with highest weight λ . It should be noted that a Virasoro primary is not in general also a WZW primary.

As in the pure Virasoro case, the primary field $\phi_{\lambda,\mu}$ gives rise to a highest weight representation for the affine algebra $\hat{g}_\kappa \times \bar{\hat{g}}_\kappa$, the descendent states (or field) are obtained from $\phi_{\lambda,\mu}$ by applying J_{-n}^a , \bar{J}_{-n}^a and L_{-m} , \bar{L}_{-m} . Given any local field, it can be decomposed in terms of descendants of some primary field, corresponding to the highest weight state of a representation of the affine algebra. By means of Ward identities, by using the same strategy as in eq.(D.69), all correlation functions can be inferred from the knowledge of primary field correlation functions. Beside the invariance under global conformal transformations, that leads to equations of the type (D.28) and (D.29), the WZW model is also invariant under global $G \times G$ transformations, this constraint fixes the two and three point function in terms of conformal weights and the Clebsch-Gordan coefficients of G .

A powerful tool in deriving the operator algebra of the theory is the existence of null vectors in the highest weight representation. This is not new; the Kac analysis of Verma modules has revealed the existence of such vectors for a family of representations with $c < 1$ corresponding to minimal models whose fusion rules can be worked out. In our case, we are interested in the Kac-Moody null vectors. The first example is the following null field

$$\chi(z) = \left(L_{-1} + \frac{1}{\kappa + c_v} J_{-1}^a t_i^a \right) \phi_i \quad , \quad (\text{D.117})$$

where ϕ_i is a primary field. By using the following representation for the insertion of J_{-1}^a :

$$\langle \phi_1(z_1) \cdots J_{-1}^a \phi_i(z_i) \cdots \phi_n(z_n) \rangle = \sum_{j \neq i} \frac{t_j^a}{(z_i - z_j)} \langle \phi_1(z_1) \cdots \phi_n(z_n) \rangle \quad , \quad (\text{D.118})$$

one derives

$$\begin{aligned} \langle \phi_1(z_1) \cdots \chi(z_i) \cdots \phi_n(z_n) \rangle &= 0 \\ &= \left[\partial_{z_i} + \frac{1}{\kappa + c_v} \sum_{j \neq i} \frac{t_i^a \otimes t_j^a}{(z_i - z_j)} \right] \langle \phi_1(z_1) \cdots \phi_n(z_n) \rangle \end{aligned} \quad (\text{D.119})$$

As a result the Knizhnik-Zamolodchikov equation follows

$$\left[\partial_{z_i} + \frac{1}{\kappa + c_v} \sum_{j \neq i} \frac{t_i^a \otimes t_j^a}{(z_i - z_j)} \right] \langle \phi_1(z_1) \cdots \phi_n(z_n) \rangle = 0 \quad . \quad (\text{D.120})$$

Eq.(D.120) is a partial differential equation for primary field correlation functions; although a general solution is not known, for $n = 4$, by using global conformal invariance, it can be reduced to an ordinary differential equation for the four-point function which can be solved in terms of hypergeometric functions. As we have pointed out in Chap.8, the Knizhnik-Zamolodchikov equation encodes the monodromy properties of the correlators related to braid group representation.

Let us now look more closely to affine algebra representations. The crucial property is the existence of a null vector in each integrable representation; this fact gives rise to rather stringent selection rules. Let θ be the highest root of the Lie algebra of G , and

$$[t^\theta, t^{-\theta}] = \frac{2}{(\theta, \theta)} \sum_i \theta_i h_i \equiv h_\theta \quad , \quad (\text{D.121})$$

where $\{h_i\}$ is a Cartan subalgebra of the Lie algebra of G . The elements of the affine algebra: $P_- = J_{-1}^\theta$, $P_+ = J_{+1}^{-\theta}$ and $P_3 = m - J_{+0}^{h_\theta}$ with $m = 2\kappa(\theta, \theta)$, generate an $su(2)$ subalgebra; indeed

$$[P_+, P_-] = P_3, \quad [P_3, P_+] = 2P_+, \quad [P_3, P_-] = -2P_- \quad . \quad (\text{D.122})$$

Thus, any representation of the affine algebra can be decomposed into a sum of representations of $su(2)$. Let $|\lambda\rangle$ be the state of the representation of \hat{g}_k corresponding to the highest weight representation of the primary field ϕ_λ , and $\mathcal{R}_\lambda[su(2)]$ the representation of $su(2)$ containing $|\lambda\rangle$. Because ϕ_λ is a primary field, the quantity $M/2$ defined as

$$P_3 |\lambda\rangle = \left(m - 2 \frac{(\lambda, \theta)}{(\theta, \theta)} \right) |\lambda\rangle \equiv M |\lambda\rangle \quad , \quad (\text{D.123})$$

gives the ‘‘angular momentum’’ content of $\mathcal{R}_\lambda[su(2)]$. The representation of \hat{g}_k , associated with ϕ_λ , is called integrable when $\mathcal{R}_\lambda[su(2)]$ is finite dimensional. A necessary and sufficient condition is that M be an integer. It can be shown that $\mathcal{R}_\lambda[su(2)]$ is irreducible; thus

$$(P_-)^{M+1} |\lambda\rangle = 0 \quad . \quad (\text{D.124})$$

For fixed κ there is a finite number of integrable representations. For each integrable representation there exists a null vector $(P_-)^{M+1} |\lambda\rangle$. It is a remarkable fact that one needs to consider integrable representation only; indeed, consider $\phi_{\lambda_{ni}}$ associated with a non integrable representation of \hat{g}_k , it turns out that

$$\langle \phi_1(z_1) \cdots \phi_{\lambda_{ni}}(z_r) \cdots \phi_n(z_n) \rangle = 0 \quad . \quad (\text{D.125})$$

As a consequence, only integrable representations are relevant from a physical point of view. The existence of the null vector (D.124) also strongly constrains the form of the three point function; one can show that

$$\left(t_1^\theta \right)^{l_1} \left(t_2^\theta \right)^{l_2} \langle \phi_\lambda(z) \phi_1(z_1) \phi_2(z_2) \rangle = 0 \quad \text{for any } l_1 + l_2 \geq M + 1 \quad . \quad (\text{D.126})$$

For example, when $G = SU(2)$, by using Eq.(D.126), the fusion rules can be determined completely.

D.11 Modular invariance

Up to now we have considered CFT on \mathbb{R}^2 , or more precisely on the Riemann sphere. Modular invariance is a tool to study CFT on two dimensional manifold with non trivial topology. Non trivial topologies come in naturally in many applications of CFT; two important examples are: statistical models at criticality with periodic boundary conditions in both directions and string theory.

For concreteness let us study a classical dilatation invariant scalar field theory on a compact, orientable two dimensional manifold Σ_g (a Riemmanian surface of genus g). The action is

$$S[h, \varphi] = \int_{\Sigma_g} d^2 \sqrt{h} h^{\mu\nu} (\partial_\mu \varphi) (\partial_\nu \varphi) \quad , \quad (\text{D.127})$$

where $h_{\mu\nu}$ is the background metric. The topology of Σ_g is specified by its genus g , i.e the number of handles. In two dimensions, locally, the metric can be put in the form $h_{\mu\nu} = \eta_{\mu\nu} \exp 2f(x)$, i.e. any metric on Σ_g is locally conformally equivalent to the standard Euclidean metric. This fact implies that, locally, the action (D.127) coincides with $S[\eta, \varphi]$. Thus, when one is concerned with local aspects, the analysis goes along the same lines as in Sect.A.2; in particular the holomorphic and anti-holomorphic sectors of the theory decouple. It should be noted that at the quantum level gravitational anomalies play an important role. The action (D.127) depends on the gravitational background only through the tensor density $\hat{h}_{\mu\nu} = \sqrt{h} h_{\mu\nu}$; at the quantum level, if one respects diffeomorphism invariance, Weyl invariance is anomalous, and the Weyl anomaly is proportional to

cR , where R is the trace of the Ricci tensor and c is the familiar central charge. Alternatively, one may keep the variable $\hat{h}_{\mu\nu}$ and shift the anomaly into a diffeomorphism anomaly [69]. When Σ is S^2 , the conformal gauge $h_{\mu\nu} = \eta_{\mu\nu} \exp 2f(x)$ exists globally; on the contrary, when $g \geq 1$, the conformal gauge exists only locally. The action (D.127) depends only on the conformal structure of M , moreover a complex structure on M is in one to one correspondence with a conformal structure on M ; as a result we expect, up to an anomalous factor, a dependence of the partition function on Σ_g on a set of parameters that describes the space of inequivalent complex structures on Σ_g , the moduli space. For S^2 the moduli space is trivial, there is only one complex structure. When $g = 1$ (the torus) the moduli space is described by one complex parameter τ subject to the following constraints

$$\begin{aligned} \text{Im}(\tau) &> 0 \quad , \\ \tau' &= \frac{a\tau + b}{c\tau + d} \quad , \quad a, b, c, d, \in \mathbb{Z} \quad ad - bc = 1 \quad , \quad \tau \text{ and } \tau' \text{ identified.} \end{aligned} \quad (\text{D.128})$$

Thus, τ and τ' are identified when they are related by an element of the modular group $PSL(2, \mathbb{Z})$ which is generated by

$$\begin{aligned} t : \tau &\rightarrow \tau + 1 \quad , \\ s : \tau &\rightarrow -\frac{1}{\tau} \quad , \\ \text{with } (st)^3 &= s^2 = 1 \quad . \end{aligned} \quad (\text{D.129})$$

The modular group coincides with the mapping class group of the torus encountered in Chap.5, this is not accidental. The moduli space of the torus is obtained from the Teichmüller space $Tei(\Sigma_1)$ as $Tei(\Sigma_1)/PSL(2, \mathbb{Z})$. The Teichmüller space $Tei(\Sigma_g)$ is defined as the space of metrics of constant curvature on Σ_g , modulo diffeomorphisms connected with the identity. On the torus, the modular group corresponds exactly to those diffeomorphisms not connected with the identity.

The partition function on the torus will be a function of τ , the requirement of conformal invariance on the torus is formulated in terms of modular invariance of the partition function:

$$Z(\tau) = Z(\tau + 1), \quad Z(\tau) = Z(-1/\tau) \quad . \quad (\text{D.130})$$

Differently from the $g = 0$, the holomorphic and anti-holomorphic parts do interact; imposing eq.(D.130) gives non trivial constraints on the spectrum of the theory. We shall consider here the case $g = 1$: the torus topology.

In CFT the partition function admits the following representation

$$Z(\tau) = \text{Tr} \left(q^{L_0 - c/24} \bar{q}^{\bar{L}_0 - c/24} \right) \quad , \quad (\text{D.131})$$

with $q = \exp(2\pi i\tau)$ and $\bar{q} = \exp(-2\pi i\tau^*)$ (q is not to be confused with deformation parameter of CS theory). The trace is taken over the full Hilbert space of the theory. The partition function is related to the formal character associated with a Verma module

$$\chi_{(c,h)}(\tau) = \text{Tr} \left(q^{L_0 - c/24} \right) = \sum_{n=0}^{\infty} \dim(h + n) q^{n+k-c/24} \quad , \quad (\text{D.132})$$

h is the weight of the highest state of the Verma module, and $\dim(h + n)$ is the number of linearly independent states at level n . In the case of a CFT with a current algebra symmetry, eqs. (D.131) and (D.132) still hold, Verma modules are replaced by the modules associated with integrable representations of the affine algebra, and $\chi_{(c,h)}(\tau)$ becomes the formal character of the affine algebra. Thus, as anticipated, modular invariance ties together the holomorphic and anti-holomorphic sectors. The first non trivial example is a free-fermion on a torus. There are two types

of boundary conditions: periodic (Ramond sector) or anti-periodic (Neveu-Schwarz sector); on a torus we have two directions in which boundary conditions have to be imposed, thus we have four sectors: (R,R), (R,NS), (NS,R), (NS,NS). It turns out that there are only two possibilities to satisfy modular invariance: only the (R,R) sector is present (the partition function in this case vanishes), alternatively the sectors (R,NS), (NS,R), (NS,NS) must be present at the same time.

We shall now address the relation between modular invariance and fusion algebra. The characters transform covariantly under modular transformation

$$\begin{aligned}\chi_i(-1/\tau) &= \sum_m \mathcal{S}_{im} \chi_m(\tau) \quad , \\ \chi_i(\tau + 1) &= \sum_m \mathcal{T}_{im} \chi_m(\tau) \quad .\end{aligned}\tag{D.133}$$

Modular invariance permits to prove the so called Verlinde formula

$$\mathcal{N}_{ij}^s = \sum_m \frac{\mathcal{S}_{im} \mathcal{S}_{jm} \mathcal{S}_{mk}^*}{\mathcal{S}_{0m}} \quad .\tag{D.134}$$

The matrices \mathcal{S} and \mathcal{T} satisfies

$$\mathcal{S}^2 = (\mathcal{S}\mathcal{T})^3 = \mathcal{C} \quad ,\tag{D.135}$$

with $\mathcal{C}_{ij} = \delta_{ij}^*$. Thus, in general, the matrices \mathcal{S} , \mathcal{T} acting on the space of characters give rise to a representation of the double covering of the modular group. Notice that Eq.(D.134) can be interpreted as an eigenvalue equation for the action of N_i in the regular representation of the fusion algebra; in this sense the matrix \mathcal{S} diagonalizes the fusion rules. Let us consider what happens to conformal blocks when the topology is non-trivial. Recall that a conformal block essentially describes the intermediate states entering the decomposition of the four-point function (see eq.(D.78)), this concept can be generalized to an arbitrary n-point correlator as describing the intermediate states entering $\langle \phi_1 \cdots \phi_n \rangle$. The generalized conformal block \mathcal{F}^I (I is a collective index) will be a holomorphic function of $n - 3$ variables describing the insertions of the primary fields of the n-point correlator. Let us introduce the vector space V_n of linearly independent n-point conformal blocks. What happens to conformal blocks \mathcal{F}^I on a Riemannian surface? Locally there is no difference; in a small neighbourhood $\mathcal{F}_{lm}^{ij}(X)$ is a holomorphic function; however globally it becomes a section of a bundle. The vector space V_n will in general depend also on the genus of Σ_g in which the CFT is defined; for this purpose we introduce the new notation $V(\Sigma_{g,n})$. The vector space $V(\Sigma_{g,n})$ can be considered as the fiber of a holomorphic vector bundle over the moduli space $M(\Sigma_{g,n})$ of a Riemann surface with n punctures corresponding to the location of the primary fields entering the correlator. In particular the fusion coefficient represents the dimension of $V(\Sigma_{g,n})$ when $n = 3$. Thus, the Verlinde formula can be also interpreted as the computation of $\dim(V(\Sigma_{g,3}))$ in terms of the action of the modular group on the characters.

D.12 Witten's approach to Chern-Simons theory

After this little tour in the realm of CFT, we come back to CS theory, namely to the Witten's original solution given in his 89' paper [10]. The essential tool used by Witten is the relation between two dimensional conformal field theory and three dimensional CS theory; about this topic see also [70].

For reasons that will be clear later, the constant k in the CS action will be denoted by ℓ in this section. Let us consider the CS theory in S^3 ; as shown in Chap.1, ℓ must be an integer. Following Witten, we shall use the following notations

$$Z(\mathcal{M}, C_1, \cdots C_n) = Z(\mathcal{M}, L) = \langle 0|W(C_1, \cdots C_n; \rho_1, \cdots \rho_n)|0\rangle_{\mathcal{M}} \quad ,\tag{D.136}$$

and

$$\langle W(C_1, \dots, C_n; \rho_1, \dots, \rho_n) \rangle_{\mathcal{M}} = \frac{Z(\mathcal{M}, C_1, \dots, C_n)}{Z(\mathcal{M})} \quad (\text{D.137})$$

for the expectation value of n Wilson lines associated with the non-intersecting knots $\{C_1, \dots, C_n\} = L$ in \mathcal{M} with colours ρ_1, \dots, ρ_n . All the knots are framed. We would like to answer the following questions:

- How to compute $Z(S^3, L)$?
- How to compute $Z(\mathcal{M}, L)$?

The crucial observation is that the Hilbert space of the quantum theory is finite dimensional and is isomorphic to $V(\Sigma_{g,n})$ introduced in the previous section. The way to establish this connection is the canonical quantization of CS theory. One can cut the three manifold M along a two dimensional Riemann surface Σ_g , the knots $\{C_i\}$ pierce Σ in n marked points carrying non-Abelian quantum numbers corresponding to the representations $\{\rho_i\}$ of G , thus actually the surface has to be regarded as $\Sigma_{g,n}$. In this picture, \mathcal{M} looks like $\Sigma_{g,n} \times \mathbb{R}$, where \mathbb{R} will be interpreted as the “time” in the canonical framework. The 2+1 splitting of the action is

$$S_{CS} = \frac{\ell}{8\pi} \int dt \int_{\Sigma} d^2x \epsilon^{ij} \text{Tr}(A_i \partial_t A_j + A_0 F_{ij}) \quad . \quad (\text{D.138})$$

The action is quadratic, apart from the non-dynamical field A_0 imposing the constraint

$$F_{ij}^a = 0 \quad . \quad (\text{D.139})$$

For the moment we have ignored the Wilson lines piercing Σ_g which act as sources. The physical phase space (reduced) $Mod(\Sigma)$ is given by the flat connection on Σ , modulo gauge transformations; this space was studied by Atiyah and Bott and they found [71] that it is compact and finite dimensional. The quantization of the compact reduced phase space $Mod(\Sigma)$ is a difficult problem; a solution is available when $Mod(\Sigma)$ has a Kähler structure. One can get a Kähler structure on $Mod(\Sigma)$ by picking an arbitrary complex structure on Σ_g . The quantization of the classical phase space, with the Poisson brackets promoted to commutators, produces a Hilbert space \mathcal{H}_{Σ} which depends on the complex structure picked on Σ_g ; one can show that actually \mathcal{H}_{Σ} can be interpreted as a holomorphic flat vector bundle on the moduli space of Σ_g . Witten’s analysis strongly suggested that actually the Hilbert space \mathcal{H}_{Σ} must be identified with $V(\Sigma_g)$. From a CFT point of view, $V(\Sigma_g)$ is the space of conformal blocks associated with the correlators of the identity conformal family, and $\text{Dim}(V(\Sigma_g)) = 1$. The previous picture can be extended to the case when Wilson lines piercing Σ_g are present, provided that the corresponding representations ρ_i of G give rise to highest weight integrable representations of the underlying affine algebra \hat{g}_{ℓ} ; as consequence, there are restrictions on the quantum numbers for the sources in Σ . From a three dimensional point of view, this is equivalent to the statement of the vanishing $Z(S^3, L)$ when one the $\{\rho_i\}$ corresponds to a non-integrable representation of g_{ℓ} . We have recovered the null elements of the tensor algebra entering the reduced tensor algebra construction of Chap.4. There is a point to be clarified: the relation between ℓ and the renormalized CS coupling constant k , the answer to this question will be clear at the end of the calculation of CS observables using Witten’s approach.

As a first example, let us consider the distant union L of two links L_1 and L_2 in \mathcal{M} . One can cut M along a two sphere S^2 , and imagines it as the connected sum of \mathcal{M}_1 and \mathcal{M}_2 with $\partial\mathcal{M}_1 = \partial\mathcal{M}_2 = S^2$. The two “pieces” \mathcal{M}_1 and \mathcal{M}_2 of \mathcal{M} are chosen in a such way that no component of L pierces S^2 . The Feynman path integral on \mathcal{M} with the link L can interpreted as follows

$$Z(\mathcal{M}, L) = (\eta_1, \eta_2) \quad . \quad (\text{D.140})$$

One first integrates over the fields living in \mathcal{M}_1 with fixed boundary conditions, say ϕ , on $\partial\mathcal{M}_2 = S^2$, the result is the path integral representation for a state η_2 of the Hilbert space \mathcal{H}_{S^2} of the CS theory; the state η_2 will depend L_1 . In the same way, the path integration on \mathcal{M}_2 with the same fixed boundary value ϕ for fields on $\partial\mathcal{M}_1 = S^2$ represents a state on the dual space of \mathcal{H}_{S^2} . Finally, the path integration over the boundary value ϕ simply produces the inner product between η_1 and η_2 on the right hand side of eq.(D.140). In particular, S^3 can be chopped along S^2 , producing a pair of three balls B_1 and B_2 ; thus for the S^3 partition function one has

$$Z(S^3) = (\eta, \eta') \quad . \quad (D.141)$$

From CFT one infers that actually $\text{Dim}(\mathcal{H}_{S^2}) = 1$, and the inner product is trivial; thus, from eqs. (D.140) and (D.141) one has

$$Z(S^3) Z(\mathcal{M}, L) = (\eta, \eta') (\eta_1, \eta_2) = (\eta_1, \eta) (\eta', \eta_2) \quad . \quad (D.142)$$

The right hand side of eq.(D.142) can be understood as the product of the partition function on \mathcal{M}'_1 obtained from \mathcal{M}_1 by gluing B_2 along S^2 with the partition function on \mathcal{M}'_2 obtained from \mathcal{M}_2 by gluing B_1 along S^2 (see Fig.D.2). In other words

$$Z(S^3) Z(\mathcal{M}, L) = Z(\mathcal{M}'_1, L_1) Z(\mathcal{M}'_2, L_2) \quad . \quad (D.143)$$

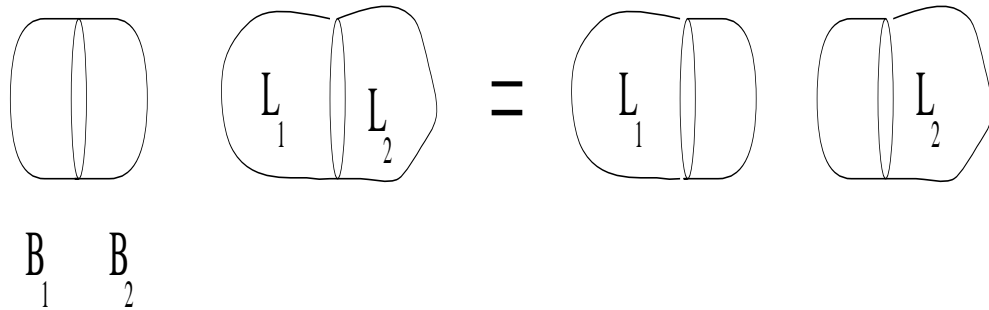

Figure D.2

When $\mathcal{M} = S^3$, eq.(D.143) takes the form

$$\langle W(L) \rangle|_{S^3} = \langle W(L_1) \rangle|_{S^3} \langle W(L_2) \rangle|_{S^3} \quad , \quad (D.144)$$

eq.(D.144) describes exactly the factorization property of Chap.2 (see eq.(2.38)).

The decisive step toward the calculability of CS observables in S^3 is to show that they satisfy a skein relation entering the definition of link invariants (see App.B). Let L_+ be a any link in S^3 , and $G = SU(N)$ the gauge group, with all the components of L associated with the fundamental N -dimensional representation ρ_N of $SU(N)$. Consider a three ball $B \subset S^3$ chosen in a such a way that it contains an elementary over-crossing configuration between two strings of L_+ ; by cutting S^3 along ∂B , $Z(S^3, L_+)$ can be represented as

$$Z(S^3, L_+) = (\chi, \eta_+) \quad . \quad (D.145)$$

The states χ and η_+ belong to the Hilbert space \mathcal{H}_Σ , with Σ a two sphere with four punctures associated with $\rho_N, \rho_N, \rho_N^*, \rho_N^*$. Following the same method, one can consider the states η_0 and η_-

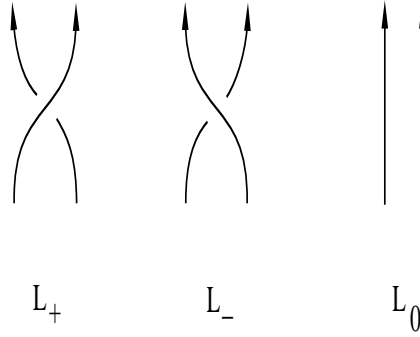

Figure D.3

corresponding to a no-crossing configuration and to an under-crossing configuration in B respectively. In other words, we have chosen three links L_+, L_0, L_- in S^3 that differ only in a region B as shown in Fig.D.3.

The skein relation simply follows from the fact that the states η_+, η_0 and η_- are linear dependent. Indeed, in this case, $\text{Dim}(\mathcal{H}_\Sigma) = 2$; the four-point correlation function $\langle \phi_{\rho_N} \phi_{\rho_N} \phi_{\rho_N}^* \phi_{\rho_N}^* \rangle$ of the WZW model must be invariant under the global group of transformations $SU(N) \times SU(N)$, and the trivial representation appears exactly twice in the tensor product $\rho_N \rho_N \rho_N^* \rho_N^*$. As a result, there exist complex numbers α, β and γ such that

$$\alpha \eta_+ + \beta \eta_0 + \gamma \eta_- = 0 \quad . \quad (\text{D.146})$$

From eq.(D.146) it follows that

$$\langle \alpha W(L_+) \rangle|_{S^3} + \beta \langle W(L_0) \rangle|_{S^3} + \gamma \langle W(L_-) \rangle|_{S^3} = 0, \quad (\text{D.147})$$

which is the promised skein relation. The values of α, β and γ are also provided by the CFT; they can be determined by the monodromy properties of the WZW conformal blocks analyzed in [63] by Moore and Seiberg. The results is

$$\begin{aligned} \alpha &= -w^{N/2} \quad , \\ \beta &= \left(w^{1/2} - w^{-1/2} \right) \quad , \\ \gamma &= -w^{-N/2} \quad , \end{aligned} \quad (\text{D.148})$$

with $w = \exp(2\pi i/(N+\ell))$. It is understood that the links entering the skein relation have preferred framing. By using the skein relation, it is easy to find the value of the Wilson line associated with unknot C

$$\langle W(C, \rho_N) \rangle = -\frac{\alpha + \beta}{\gamma} = \frac{w^{N/2} - w^{-N/2}}{w^{1/2} - w^{-1/2}} \quad . \quad (\text{D.149})$$

The last ingredient is the behaviour of the observables under a change a framing. From the CFT point of view, an elementary change of framing can be interpreted as a the action of an element of the modular group corresponding to a Dehn twist whose action on the space of conformal blocks is known; as result one has

$$\langle W(C_{(1)}, \rho) \rangle = e^{2\pi i h_\rho} \langle W(C, \rho) \rangle \quad . \quad (\text{D.150})$$

The knot C has preferred framing, and h_ρ is the conformal weight of the WZW primary field ϕ_ρ , namely, from eq.(D.116) one has

$$h_\rho = \frac{c_\rho}{2(\ell + c_v)} \quad . \quad (\text{D.151})$$

Finally, let us briefly address the problem of the calculation of $Z(\mathcal{M})$. Consider a surgery presentation of a three manifolds \mathcal{M} consisting of a knot C in S^3 . One cuts from S^3 a solid torus N corresponding to the tubular neighbourhood of C , then the boundaries N and $(S^3 - \dot{N})$ are glued back according to a given homeomorphism. The boundaries: ∂N and $\partial(S^3 - \dot{N})$ are tori, thus the gluing homeomorphism is determined by an element K of the mapping class group of the torus. From the CFT point of view, the action of the mapping class group on the space of conformal blocks $V(\Sigma_{1,0})$ corresponds to a modular transformation. In particular, for a fixed level ℓ , one can pick a basis $\{v_i\}$ on $V(\Sigma_{1,0})$. As studied by Verlinde in [61], the action of K is a linear transformation K_i^j

$$K v_i = K_i^j v_j \quad . \quad (\text{D.152})$$

Because in the starting manifold S^3 there is no Wilson line, the partition function on \mathcal{M} is represented by

$$Z(\mathcal{M}) = K_0^j W(S^3, C \rho_i) \quad . \quad (\text{D.153})$$

In principle, more involved surgeries can be examined, although explicit calculations would be difficult. A comment must be added. From Chap.7 we have already known that $Z(\mathcal{M})$ is not a topological invariant; a suitable phase must be provided. Indeed, the element of the mapping class group is not uniquely determined; given an element u , u and $u \cdot T^m$, with m integer, give the same surgery, in the sense that the resulting manifolds are homeomorphic. This fact produces a phase ambiguity $\exp(-2m\pi ic/24)$ in the partition function. Witten interpreted the present ambiguity as the manifestation of the three manifold framing, materializing the central charge at the three dimensional level. For further discussion see [72, 73].

Looking back at Chap.3 a problem in Witten's solution of CS field theory appears: the expression of the unknot in eq.(D.149) differs from eq.(3.54) in Chap.3. The point is the relation between the level κ of the affine algebra and the Chern-Simons coupling constant ℓ ; Witten sets $\ell = \kappa$. However, when ℓ is identified with the renormalized coupling constant, as Witten implicitly does, the position $\ell = \kappa$ is inconsistent. From the explicit examples produced in this thesis, all in agreement with perturbative calculations, the correct identification is $\ell = \kappa + c_v$; indeed for $SU(N)$ $c_v = N$, and this is the only way to match eq.(3.54) and eq.(D.149). There is also a simple symmetry argument which shows that eq.(3.54) cannot be trusted. Consider a change of the orientation of S^3 , this corresponds in the CS action to send ℓ into $-\ell$. The unknot and its mirror image are ambient isotopic; as a consequence, the value of the unknot must be invariant under $\ell \rightarrow -\ell$. From direct inspection of eq.(D.149), it follows that the only possibility is $\ell = \kappa + c_v$.

Appendix E

Numerical results

k	$L_{8/1}$ I_k	I_k
3	1.000000000 - i 0.000000175	1.000000000
4	-1.000000000 + i 0.000000012	1.000000000
5	-0.499999839 + i 1.538841821	1.618033989
6	-2.000000000 + i 0.000000175	2.000000000
7	-1.000000000 - i 0.000000095	1.000000000
8	-6.828427084 + i 6.828427165	9.656854249
9	-0.499999950 + i 0.866025433	1.000000000
10	-4.236067816 + i 3.077683759	5.236067977
11	-2.073846587 - i 14.423920506	14.572244935
12	-7.464102180 - i 12.928202904	14.928203230
13	-12.373524802 - i 17.926145664	21.781891892
14	18.195669358 + i 0.000000868	18.195669358
15	5.657005398 + i 4.110054701	6.992443043
16	63.431390926 + i 26.274142180	68.657642707
17	6.721172941 + i 2.603796085	7.207906752
18	15.581719525 + i 26.988328071	31.163437478
19	-69.185356387 - i 11.544994773	70.142001987
20	-66.118464248 + i 0.000001734	66.118464248
21	-90.016155013 + i 0.000000715	90.016155013
22	43.367008373 - i 50.048195295	66.223253224
23	22.973052202 - i 3.157573698	23.189036183
24	219.054514271 - i 58.695485329	226.781922164
25	23.000602198 - i 5.905551129	23.746646829
26	84.434763344 + i 44.314782640	95.357376335
27	-185.409752744 + i 67.483626877	197.308936212
28	-161.491033989 + i 77.769978391	179.241523084
29	-214.342425435 + i 99.165358161	236.170369862
30	50.544948881 - i 155.561366312	163.566899299
31	47.834849646 - i 26.550506056	54.709251617
32	443.615385766 - i 296.414325177	533.531688523
33	46.894822945 - i 30.137471278	55.743982582
34	211.662329441 + i 39.566544008	215.328709440
35	-344.610722364 + i 250.374335362	425.962272715
36	-290.376668930 + i 243.654963011	379.059824907
37	-381.345093602 + i 307.914657384	490.138262785
38	27.064369107 - i 326.618342223	327.737732877
39	79.852315000 - i 70.742976321	106.681586554
40	734.287201006 - i 734.287220264	1038.438931957
41	78.053570702 - i 75.119028091	108.329258655
42	408.590935390 - i 0.000001624	408.590935390
43	-545.541472393 + i 565.843251992	785.998781122
44	-452.077098514 + i 521.724781996	690.340822456
45	-590.050989168 + i 655.318028318	881.817377951
46	-39.324647251 - i 574.905929557	576.249299975
47	118.947578576 - i 140.691854636	184.235513433
48	1090.316030520 - i 1420.927547540	1791.039960963
49	116.363242798 - i 145.914887153	186.632147733
50	687.196328608 - i 86.813088226	692.658145364

Table 1

k	$L_{8/3}$ I_k	$ I_k $
3	1.000000000 + i 0.000000000	1.000000000
4	-1.000000000 + i 0.000000000	1.000000000
5	1.309016994 - i 0.951056516	1.618033989
6	-2.000000000 + i 0.000000000	2.000000000
7	-0.623489802 + i 0.781831482	1.000000000
8	0.000000000 + i 0.000000000	0.000000000
9	-0.500000000 + i 0.866025404	1.000000000
10	1.618033989 + i 4.979796570	5.236067977
11	6.053529319 - i 13.255380237	14.572244935
12	-7.464101615 + i 12.928203230	14.928203230
13	7.723965314 - i 20.366422715	21.781891892
14	-16.393731622 + i 7.894805057	18.195669358
15	-2.160783733 + i 6.650208521	6.992443043
16	0.000000000 + i 0.000000000	0.000000000
17	-1.972537314 + i 6.932749548	7.207906752
18	15.581718739 + i 26.988328525	31.163437478
19	17.218843527 - i 67.995675380	70.142001987
20	-20.431729095 + i 62.882396270	66.118464248
21	20.030478885 - i 87.759262069	90.016155013
22	-55.710545730 + i 35.802993757	66.223253224
23	-4.717948848 + i 22.704016336	23.189036183
24	0.000000000 + i 0.000000000	0.000000000
25	-4.449677900 + i 23.326028428	23.746646829
26	54.169163837 + i 78.477582217	95.357376335
27	34.262337211 - i 194.311370120	197.308936212
28	-39.884991120 + i 174.747563877	179.241523084
29	38.208113963 - i 233.059184818	236.170369862
30	-132.328401250 + i 96.142211171	163.566899299
31	-8.284500381 + i 54.078362271	54.709251617
32	0.000000000 + i 0.000000000	0.000000000
33	-7.933195866 + i 55.176589215	55.743982582
34	129.764538515 + i 171.836019661	215.328709440
35	57.178306982 - i 422.107212669	425.962272715
36	-65.823047822 + i 373.301054424	379.059824907
37	62.256293514 - i 486.168356194	490.138262785
38	-258.631121471 + i 201.300681961	327.737732877
39	-12.859044288 + i 105.903757675	106.681586554
40	0.000000000 + i 0.000000000	0.000000000
41	-12.423570453 + i 107.614511930	108.329258655
42	254.752281347 + i 319.449256739	408.590935390
43	85.965636475 - i 781.283554973	785.998781122
44	-98.245742501 + i 683.314148273	690.340822456
45	92.175015400 - i 876.986690089	881.817377951
46	-447.003088251 + i 363.663986140	576.249299975
47	-18.441181139 + i 183.310248618	184.235513433
48	0.000000000 + i 0.000000000	0.000000000
49	-17.920983557 + i 185.769741658	186.632147733
50	441.516918550 + i 533.702273720	692.658145364

Table 2

k	$L_{15/1}$	$ I_k $
3	1.000000000 - i 0.000000175	1.000000000
4	0.000000021 + i 1.732050808	1.732050808
5	-2.665351925 + i 1.936491953	3.294556414
6	3.000000303 + i 3.464101353	4.582575695
7	-0.000000165 + i 1.732050808	1.732050808
8	-1.732050808 + i 0.000000010	1.732050808
9	-0.907604426 - i 11.866568847	11.901226911
10	-5.959909504 - i 18.342712091	19.286669182
11	-17.245203220 + i 14.943053456	22.818673947
12	-11.196152781 - i 8.196151933	13.875544804
13	0.000000084 - i 15.347547346	15.347547346
14	0.000000083 - i 1.732050808	1.732050808
15	-101.423006915 - i 32.954328677	106.642459228
16	-1.224744868 + i 1.224744875	1.732050808
17	-20.645987906 + i 15.591127116	25.871607244
18	-40.127945922 - i 30.808776018	50.590836361
19	65.239497521 - i 83.819706393	106.216454548
20	-115.811330427 - i 84.141852139	143.150674244
21	-53.061367118 - i 135.569663547	145.583798394
22	36.010672960 + i 16.445523443	39.588177633
23	-40.070955963 - i 2.740927872	40.164588848
24	164.290883844 - i 129.064834808	208.923972053
25	274.923532195 - i 34.730921473	277.108616721
26	0.000000762 - i 277.056941014	277.056941014
27	152.288761117 + i 30.720691710	155.356453557
28	-0.000003253 + i 136.433611353	136.433611353
29	-4.270422302 + i 12.674160517	13.374260781
30	485.145409358 + i 667.745345688	825.378649414
31	13.416605095 + i 0.680413518	13.433847358
32	164.960256203 + i 68.328775084	178.551694562
33	-82.729230504 + i 287.059281883	298.742626511
34	-538.981501170 - i 268.380890132	602.104111256
35	-415.659227492 + i 629.696787632	754.513510650
36	-681.771583909 + i 223.335013764	717.419696551
37	101.630605413 - i 150.367371847	181.491395038
38	-59.482939675 + i 173.267881065	183.193828283
39	-279.481438371 - i 847.784737546	892.663898458
40	347.379313920 - i 1069.123643311	1124.143119192
41	-941.842709163 - i 512.157840150	1072.088308877
42	399.545316356 - i 429.453517605	586.572061733
43	390.071778264 + i 279.072428091	479.622155784
44	24.267771316 + i 37.761389387	44.887049949
45	2753.539308039 + i 289.408610795	2768.706568944
46	32.920210846 - i 30.745331135	45.044596443
47	536.002877882 - i 206.437637985	574.382784800
48	394.055675294 + i 817.737030229	907.729985094
49	-1754.712300120 + i 400.501606784	1799.837990828
50	137.556258644 + i 2186.393963508	2190.716843400

Table 3

k	$L_{15/2}$	$ I_k $
3	1.000000000 + i 0.000000000	1.000000000
4	0.000000000 - i 1.732050808	1.732050808
5	0.000000000 + i 0.000000000	0.000000000
6	3.000000000 - i 3.464101615	4.582575695
7	0.000000000 - i 1.732050808	1.732050808
8	1.732050808 + i 0.000000000	1.732050808
9	10.730551990 - i 5.147276559	11.901226911
10	0.000000000 + i 0.000000000	0.000000000
11	-12.336706536 + i 19.196290072	22.818673947
12	-11.196152423 + i 8.196152423	13.875544804
13	14.350206054 - i 5.442315293	15.347547346
14	0.000000000 + i 1.732050808	1.732050808
15	0.000000000 + i 0.000000000	0.000000000
16	1.224744871 - i 1.224744871	1.732050808
17	9.345902508 + i 24.124555285	25.871607244
18	-6.617211192 - i 50.156208387	50.590836361
19	50.553444640 - i 93.414583721	106.216454548
20	0.000000000 + i 0.000000000	0.000000000
21	-53.061366041 + i 135.569663969	145.583798394
22	-11.153278505 + i 37.984578277	39.588177633
23	-29.353726021 - i 27.414466365	40.164588848
24	-164.290886665 - i 129.064831217	208.923972053
25	0.000000000 + i 0.000000000	0.000000000
26	228.013392388 + i 157.386281027	277.056941014
27	56.698638283 + i 144.640561664	155.356453557
28	0.000000000 - i 136.433611353	136.433611353
29	11.816320486 + i 6.264616638	13.374260781
30	0.000000000 + i 0.000000000	0.000000000
31	-1.359079795 - i 13.364922631	13.433847358
32	164.960256101 + i 68.328775330	178.551694562
33	-224.792217910 - i 196.762841162	298.742626511
34	-110.636340119 - i 591.852144574	602.104111256
35	0.000000000 + i 0.000000000	0.000000000
36	147.472006710 + i 702.099015977	717.419696551
37	45.731849880 + i 175.635202563	181.491395038
38	-177.588145856 - i 44.971426177	183.193828283
39	-875.291194999 - i 175.254556482	892.663898458
40	0.000000000 + i 0.000000000	0.000000000
41	1052.478012596 + i 204.116082250	1072.088308877
42	399.545318063 + i 429.453516017	586.572061733
43	-171.335849479 - i 447.974819607	479.622155784
44	44.430164502 + i 6.388093254	44.887049949
45	0.000000000 + i 0.000000000	0.000000000
46	-17.945816315 - i 41.315412930	45.044596443
47	571.498128245 + i 57.493242102	574.382784800
48	-817.737034535 - i 394.055666358	907.729985094
49	-780.920437266 - i 1621.597997004	1799.837990828
50	0.000000000 + i 0.000000000	0.000000000

Table 4

k	$L_{15/4}$ I_k	$ I_k $
3	1.000000000 + i 0.000000000	1.000000000
4	0.000000000 + i 1.732050808	1.732050808
5	-1.018073921 - i 3.133309346	3.294556414
6	3.000000000 + i 3.464101615	4.582575695
7	-0.751508681 - i 1.560523855	1.732050808
8	-1.732050808 + i 0.000000000	1.732050808
9	10.730551990 + i 5.147276559	11.901226911
10	-15.603243133 - i 11.336419711	19.286669182
11	17.245203123 + i 14.943053568	22.818673947
12	-11.196152423 - i 8.196152423	13.875544804
13	3.672908488 + i 14.901575513	15.347547346
14	-1.688624678 + i 0.385417563	1.732050808
15	0.000000000 + i 0.000000000	0.000000000
16	-1.224744871 + i 1.224744871	1.732050808
17	-17.429589094 - i 19.119348456	25.871607244
18	-6.617211192 + i 50.156208387	50.590836361
19	0.000000000 - i 106.216454548	106.216454548
20	-44.235991098 + i 136.144381552	143.150674244
21	72.909410760 - i 126.011349400	145.583798394
22	-36.010673013 + i 16.445523326	39.588177633
23	-10.836276386 + i 38.675176941	40.164588848
24	164.290886665 - i 129.064831217	208.923972053
25	-257.649075864 + i 102.010485575	277.108616721
26	275.036883975 - i 33.395523912	277.056941014
27	-153.611719961 + i 23.217819719	155.356453557
28	106.668092622 + i 85.064965309	136.433611353
29	-9.197471902 + i 9.709653035	13.374260781
30	0.000000000 + i 0.000000000	0.000000000
31	-4.021598499 + i 12.817761129	13.433847358
32	-164.960256101 - i 68.328775330	178.551694562
33	85.599713692 + i 286.216431937	298.742626511
34	-217.505092368 - i 561.445362956	602.104111256
35	33.851120653 + i 753.753765751	754.513510650
36	147.472006710 - i 702.099015977	717.419696551
37	-136.240563896 + i 119.906777214	181.491395038
38	0.000000000 + i 183.193828283	183.193828283
39	538.949599873 - i 711.605343156	892.663898458
40	-909.450887536 + i 660.754746927	1124.143119192
41	1008.985242455 - i 362.383943545	1072.088308877
42	-546.310790198 + i 213.568031595	586.572061733
43	426.548198677 + i 219.303548819	479.622155784
44	-24.267771377 + i 37.761389348	44.887049949
45	0.000000000 + i 0.000000000	0.000000000
46	-6.133571758 + i 44.625048641	45.044596443
47	-558.735830232 - i 133.153503483	574.382784800
48	394.055666358 + i 817.737034536	907.729985094
49	-883.212092863 - i 1568.232505801	1799.837990828
50	410.499402001 + i 2151.913225229	2190.716843400

Table 5

Bibliography

- [1] A.S. Schwarz, *Lett. Math. Phys.* 2 (1978) 247.
- [2] E. Witten, *J. Diff. Geom.* 17 (1982) 661.
- [3] E. Witten, *Comm. Math. Phys.* 117 (1988) 353.
- [4] D. Birmingham, M. Blau, M. Rakowski and G. Thompson, *Phys. Rep.* 4 & 5 (1991) 129.
- [5] R. Dijkgraaf, *Les Houches lectures on fields, strings and duality*, hep-th/9703136.
- [6] M.F. Atiyah, *New invariants of three- and four-dimensional manifolds*, in *The mathematical heritage of Hermann Weyl*, Proc. Symp. Pure Math. 48, ed. R. Wells; Amer. Math. Soc., 1988.
- [7] A.S. Schwarz, *New topological invariants arising in the theory of quantized fields* in Abstracts of the International Topological Conference, Baku 1997.
- [8] S. Donaldson, *J. Diff. Geom.* 18 (1983) 269.
- [9] V.F.R. Jones, *Bull. Amer. Math. Soc.* 12 (1985) 103;
Ann. Math 126 (1987) 335.
- [10] E. Witten, *Comm. Math. Phys.* 121 (1989) 351.
- [11] M.F. Atiyah, *Pubbl. Math. I.H.E.S.* 68 (1988) 175.
- [12] V.G. Turaev, *Quantum invariants of 3-manifolds*, Walter de Gruyter Studies in Mathematics 18 (Berlin 1994).
- [13] C. Becchi, A. Rouet and R. Stora, *Comm. Math. Phys.* 42 (1975) 127; *Ann. Phys. (NY)* 98,287 (1976).
- [14] E. Guadagnini, M. Martellini and M. Mintchev, *Phys. Lett. B* 227 (1989) 111.
- [15] L. Alvarez-Gaumè, J.M.F. Labastida and A.V. Ramallo, *Nucl. Phys. B* 334 (1990) 103.
- [16] F. Delduc, O. Piguet, C. Lucchesi and S.P. Sorella, *Nucl. Phys. B* 346 (1990) 313.
- [17] A.M. Polyakov, *Mod. Phys. Lett. A* 3 (1988) 325.
- [18] E. Guadagnini, M. Martellini and M. Mintchev, *Nucl. Phys. B* 330 (1990) 575.
- [19] E. Guadagnini, *Int. Journ. Mod. Phys. A* 7 (1992) 877.
- [20] Y. Choquet-Bruhat, C. DeWitt-Morette and M. Dillard-Bleick, *Analysis, Manifolds and Physics, part 1*; North-Holland, 1989.
- [21] R. Bott, *Bull. Soc. Math. France*, 84 (1956) 251.

- [22] G.V. Dunne, R. Jackiw and C.A. Trugenberger, *Ann. Phys.* 194 (1989) 197.
- [23] D. Rolfsen, *Knots and Links*, Publish or Perish, 1976.
- [24] L.H. Kauffman, *On Knots*, Princeton Univ. Press, 1987.
- [25] W.H. Thomson, *Trans. R. Soc. Edin.* 25 (1869) 217.
- [26] E. Artin, *Ann. of Math.* 48 (1947) 101
- [27] J Birman, *Braids, Links and Mapping Class Group*, *Ann. Math. Stud.* 82 (1974);
Can. J. Math. 28 (1976) 264.
- [28] P. Cotta-Ramusino, E. Guadagnini, M. Martellini and M. Mintchev, *Nucl. Phys.* B330 (1990) 557.
- [29] E. Guadagnini, M. Martellini and M. Mintchev, *Nucl. Phys.* B336 (1990) 581;
Nucl. Phys. B18 (Proc. Suppl.) (1990) 121.
- [30] E. Guadagnini, *Phys. Lett. B* 260 (1991) 353.
- [31] E. Guadagnini, *The Link Invariant of the Chern-Simons Field Theory, De Gruyter Exposition in Mathematics*, Vol. 10 (de Gruyter, Berlin, 1992).
- [32] E. Seiler, *Gauge Theories as a Problem of Constructive Quantum Field Theory and Statistical Mechanics*; *Lecture Notes in Physics N. 159*, Springer-Verlag 1982.
- [33] E. Guadagnini and L. Pilo, *J. Geom. Phys.* 14 (1994) 236.
- [34] W.B.R. Lickorish and K.C. Millet, *Topology* 26 (1987) 107.
- [35] L. Pilo, *Teoria di Chern-Simons con gruppo di gauge $SU(3)$ ed invarianti di 3-varietà*, Thesis (1993).
- [36] E. Guadagnini and L. Pilo, *J. Geom. Phys.* 14 (1994) 365;
Phys. Lett. B 319 (1993) 139.
- [37] E. Guadagnini, *Nucl. Phys.* B375 (1992) 381;
E. Guadagnini and S. Panicucci, *Nucl. Phys.* B388 (1992) 159.
- [38] R. Kirby *Invent. Math.* 45 (1978) 35;
R. Fenn and C. Rourke, *Topology* 18 (1979) 1;
D. Rolfsen, *Pacific J. Math.* 110 (1984) 377.
- [39] W.B.R. Lickorish, *Ann. Math.* 76 (1962) 531.
- [40] C.L. Sigel, *Nachr. Akad. Wiss. Göttingen Math. Phys. Kl.* 1 (1960) 1.
- [41] R. Kirby and P. Melvin, *Invent. Math.* 105 (1991) 473.
- [42] W.B.R. Lickorish, *Pacific J. Math.* 149 (1991) 337.
- [43] H.R. Morton and P.M. Strickland, *Satellites and Surgery Invariants*, in *Knots 90*, edit. A. Kawachi, (Walter de Gruyter, Berlin 1992).
- [44] N.Y. Reshetikhin and V.G. Turaev, *Invent. Math.* 103 (1991) 547.

- [45] V.G. Turaev and O.Y. Viro, *Topology* 31 (1992) 865.
- [46] E. Guadagnini, *Nucl. Phys.* B404 (1993) 385.
- [47] L.H. Kauffman and L.L. Sostenes *Temperley-Lieb recoupling theory and invariants of 3-manifolds*, Princeton University Press (Princeton, 1994).
- [48] T. Kohno, *Topology* 31 (1992) 203.
- [49] T. Kohno, *Ann. Inst. Fourier, Grenoble* 37 (1987) 139.
- [50] D.S. Freed and R.E. Gompf, *Commun. Math. Phys.* 14X (1991) 79.
- [51] L. C. Jeffrey, *Commun. Math Phys.* 147 (1992) 563
- [52] E. Guadagnini and L. Pilo, hep-th 9612090, to be published in *Comm. Math. Phys.*
- [53] Hua Loo-Keng, *Introduction to number theory*, Springer-Verlag (New York, 1982).
- [54] F. Archer and R. Williams, *Phys. Lett. B* 273 (1991) 438.
- [55] E. Guadagnini and P. Tomassini, *Phys. Lett. B* 336 (1994) 330.
- [56] E. Guadagnini and L. Pilo, *Nucl. Phys.* B433, 597 (1995).
- [57] E. Witten, *Commun. Math. Phys.* 121 (1989) 351.
- [58] S.P. Novikov, *Usp. Mat. Nauk* 37 (1982) 3;
A.M. Polyakov and P.B. Wiegmann, *Phys. Lett.* B131 (1983) 121;
E. Witten, *Commun. Math. Phys.* 92 (1984) 455.
- [59] V.G. Knizhnik and A.B. Zamolodchikov, *Nucl. Phys.* B247 (1984) 83.
- [60] A.A. Belavin, A.M. Polyakov, A.B. Zamolodchikov *Nucl. Phys.* B241 (1984) 333.
- [61] E. Verlinde, *Nucl. Phys.* B300 (1988) 360.
- [62] D. Friedan and S.H. Shenker, *Nucl. Phys.* B281 (1987) 509.
- [63] G. Moore and N. Seiberg, *Commun. Math. Phys.* 123 (1989) 177.
- [64] V.G. Drinfeld, *Quasi-Hopf Algebras and Knizhnik-Zamolodchikov Equations*, in *Problems of Modern Quantum Field Theory*, ed. A.A. Belavin, A.V. Klyuk and A.B. Zamolodchikov (Springer-Verlag, 1990).
- [65] P. Di Francesco, P. Mathieu and D. Senechal, *Conformal Field Theory*, Springer-Verlag, 1997.
- [66] C. Itzykson and J.-M. Drouffe, *Statistical Field Theory* Vol.2, Cambridge University Press.
- [67] P. Ginsparg, *Applied Conformal Field Theory*, in *Les Houches, session XLIX, 1988, Fields, strings and critical phenomena*, Eds. E. Brèzin and J. Zinn-Justin, Elsevier 1989.
- [68] J.L. Cardy, *Conformal Invariance and Statistical Mechanics*, in *Les Houches, session XLIX, 1988, Fields, strings and critical phenomena*, Eds. E. Brèzin and J. Zinn-Justin, Elsevier 1989.
- [69] E. Guadagnini, *Phys. Rev.* D38 (1988) 2482.

- [70] J. Frohlich and C. King Comm. Math. Phys. 126 (1989) 167 ;
Int. Jour. Mod. Phys. A4 (1989) 5321.
- [71] M.F. Atiyah and R. Bott, Phil. Trans. R. Soc. Lond. A308 (1982) 523.
- [72] E. Witten, *The central charge in three dimensions*, IASSNS-HEP-89/38, June, 1989.
- [73] M.F Atiyah, Topology 29 (1990) 1.