

Perturbative renormalization and infrared finiteness in the Wilson renormalization group: the massless scalar case*

M. Bonini, M. D'Attanasio and G. Marchesini

Dipartimento di Fisica, Università di Parma and
INFN, Gruppo Collegato di Parma, Italy

Abstract

A new proof of perturbative renormalizability and infrared finiteness for a scalar massless theory is obtained from a formulation of renormalized field theory based on the Wilson renormalization group. The loop expansion of the renormalized Green functions is deduced from the Polchinski equation of renormalization group. The resulting Feynman graphs are organized in such a way that the loop momenta are ordered. It is then possible to analyse their ultraviolet and infrared behaviours by iterative methods. The necessary subtractions and the corresponding counterterms are automatically generated in the process of fixing the physical conditions for the “relevant” vertices at the normalization point. The proof of perturbative renormalizability and infrared finiteness is simply based on dimensional arguments and does not require the usual analysis of topological properties of Feynman graphs.

*Research supported in part by MURST, Italy

1 Introduction

In perturbation theory renormalization requires a cumbersome analysis of Feynman graph divergences and the exploitation of topological properties in graph theory [1]. The origin of this complication is technical and due to the overlapping divergence problem which arises in the procedure of generating in a systematic way all appropriate subtractions. This difficulty seems rather artificial since renormalization is based on simple and general properties [2] such as dimensional analysis and the breaking of scale invariance in interacting theories. The perturbative study of finiteness of the vertex functions in a massless theory [3] brings a similar surprise. Also in this case the reason for the finiteness is simple and general, but in perturbation theory the analysis turns out to be rather complex [4].

The deep physical meaning of renormalization can be appreciated in the formulation due to Wilson [5]-[8]. One introduces a momentum cutoff Λ , considers the effective Lagrangian obtained by integrating the fields with frequencies above Λ and requires that the physical measures below such a scale are independent of Λ . It is then natural to explore whether it is possible to deduce from this formulation a proof of perturbative renormalizability which avoids the usual cumbersome analysis of overlapping divergences. This program has been successfully carried out by Polchinski [6]. From his formulation it is possible to deduce the perturbative expansion and he was able to give a proof of perturbative renormalizability for a scalar theory. One does not need to control the detailed momentum dependence of the effective couplings, thus the proof is based on simple dimensional analysis. However also this proof is technically quite laborious and the physical features are not transparent. Moreover, although the proof is perturbative, Green functions and Feynman graphs are never directly involved, thus no connection with the usual analysis of perturbative renormalization can be made.

In this paper we use the renormalization group equation of Ref. [6] to obtain an alternative proof of perturbative renormalizability for a scalar field theory. Also in this case the proof is based on simple dimensional analysis but in all steps we have an explicit connection to Feynman graphs. Since power counting enters also in the infrared finiteness of the Green functions at non exceptional momenta, we use similar methods to obtain a perturbative proof of this feature in a massless theory.

We start by observing that the effective vertices satisfying the renormalization group equations of Ref. [6] correspond to the cutoff-Green functions of the theory in which the parameter Λ plays the role of an infrared cutoff in the propagators. Thus the effective vertices evaluated at $\Lambda = 0$ correspond to the renormalized Green functions. The physical couplings, *i.e.* the couplings with non negative dimensions such as the mass, the wave function normalization, the four point coupling, are fixed at the physical point $\Lambda = 0$. In this way the renormalization group equations define in a constructive way the renormalized quantum field theory. This fact has been discussed also in Ref. [8]-[10].

We prove the renormalizability of the scalar theory by showing that by fixing the physical couplings at $\Lambda = 0$ one generates, order by order in perturbation theory, the necessary subtractions which make finite any Green function. The analysis of the ultraviolet behaviour of Feynman graphs does not require any complicated technical step so that the role of simple dimensional counting and the origin of the needed subtractions are clear. As

in [6], we avoid the study of overlapping divergences. Although we still refer to Feynman graphs we do not need a detailed knowledge of their momentum dependence. Solving by iteration the renormalization group equation, we find that the Green functions are given as sum of contributions of Feynman diagrams in which the various virtual momenta are ordered. This allows us to control the ultraviolet behaviour by iterative methods.

In the same way we study the finiteness of the Green functions for non exceptional momenta. The perturbative analysis here is simpler since there is no need to control the subtractions. Due to the fact that the loop momenta are ordered, we need to analyse only the infrared behaviour of the softest momentum.

The paper is organized as follows. In Section 2 we rederive the renormalization group flow of Ref. [6]. We show that the solution at $\Lambda = 0$ is the effective action of the theory, deduce the perturbative expansion and perform some one and two loop calculations. In Sections 3 and 4 we describe the proof by induction of perturbative renormalizability and infrared finiteness. Section 5 contains some remarks and conclusions. In the Appendix we describe in this context the beta function.

2 Renormalization group flow

We consider a four dimensional massless scalar field theory with a four point coupling g at the scale μ , *i.e.* with the two and four point vertex functions satisfying the conditions

$$\Gamma_2(0) = 0, \quad \frac{d\Gamma_2(p^2)}{dp^2}\Big|_{p^2=\mu^2} = 1, \quad \Gamma_4(\bar{p}_1, \bar{p}_2, \bar{p}_3, \bar{p}_4) = g, \quad (1)$$

where \bar{p}_i are the momenta at the symmetric point

$$\bar{p}_i \bar{p}_j = \mu^2 (\delta_{ij} - \frac{1}{4}). \quad (2)$$

The generating functional of Euclidean Green functions is

$$Z[j] = e^{W[j]} = \int \mathcal{D}\phi \exp \left\{ -\frac{1}{2} \int \frac{d^4 p}{(2\pi)^4} \phi(p) D^{-1}(p) \phi(-p) - S_{int}[\phi] + \int \frac{d^4 p}{(2\pi)^4} \phi(p) j(-p) \right\}, \quad (3)$$

where $D(p) = 1/p^2$ is the free propagator of the massless theory and $S^{int}[\phi]$ is the self interaction

$$S^{int}[\phi] = \frac{1}{2} \int \frac{d^4 p}{(2\pi)^4} [\gamma_2^{(B)} p^2 + \gamma_3^{(B)}] \phi(p) \phi(-p) + \frac{\gamma_4^{(B)}}{4!} \int d^4 x \Phi^4(x), \quad (4)$$

with $\phi(p)$ the momentum representation of the field $\Phi(x)$. Feynman graphs generated by (3) and (4) have ultraviolet divergences, which can be regularized by assuming that the fields have frequencies bounded by an ultraviolet cutoff Λ_0 ($p^2 < \Lambda_0^2$) or, equivalently, that the propagator $D(p)$ vanishes for $p^2 > \Lambda_0^2$. The parameters $\gamma_2^{(B)}$ and $\gamma_4^{(B)}$ are dimensionless, $\gamma_3^{(B)}$ has the dimensions of a square mass, and they are fixed by the physical conditions (1).

2.1 Derivation of the evolution equation

The evolution equation which is the basis for the present treatment is derived as follows. We consider the functionals $Z[j; \Lambda]$ and $W[j; \Lambda]$ obtained from (3) in which we replace $D(p)$ by the cutoff propagator

$$D(p) \Rightarrow D_{\Lambda, \Lambda_0}(p) = \frac{K_{\Lambda, \Lambda_0}(p)}{p^2}, \quad (5)$$

with $K_{\Lambda, \Lambda_0}(p) = 1$ in the region $\Lambda^2 \lesssim p^2 \lesssim \Lambda_0^2$ and rapidly vanishing outside. As one takes the limit $\Lambda \rightarrow 0$, the cutoff Green functions generated from $W[j; \Lambda]$ tend, at least perturbatively, to the physical ones, *i.e.* we have $W[j; \Lambda] = W[j]$ for $\Lambda \rightarrow 0$.

The functional $Z[j; \Lambda]$ can be computed from the following evolution equation

$$\Lambda \frac{\partial}{\partial \Lambda} Z[j; \Lambda] = -\frac{1}{2} \int \frac{d^4 q}{(2\pi)^4} \frac{\Lambda \partial D_{\Lambda, \Lambda_0}^{-1}(q)}{\partial \Lambda} (2\pi)^8 \frac{\delta^2 Z[j; \Lambda]}{\delta j(q) \delta j(-q)}, \quad (6)$$

obtained by differentiating (3) with the propagator $D_{\Lambda, \Lambda_0}(p)$. As we will discuss in detail later, the boundary conditions are determined by requiring that the vertex functions satisfy the normalization conditions (1) at $\Lambda = 0$, and the form (4) at $\Lambda = \Lambda_0$. Since we are interested in the limit $\Lambda_0 \rightarrow \infty$, in these functionals we do not write explicitly the dependence on the ultraviolet cutoff. Notice that the inverse cutoff propagator entering in (6) is cancelled by corresponding propagators in the external legs of the Green functions. Although inverse cutoff propagators cancel, in this section we shall assume a cutoff function different from zero everywhere but rapidly vanishing outside the range (Λ, Λ_0) .

The present treatment is related to the Wilson renormalization formalism. Actually, Eq. (6) is equivalent to the renormalization group equation of Ref. [6]. To clarify this relation recall that in the Wilson formulation one integrates (3) over the fields with frequency larger than Λ to obtain a new action $S_\Lambda[\phi_\Lambda, j]$ and Eq. (3) becomes

$$Z[j] = e^{W[j]} = \int \mathcal{D}\phi_\Lambda \exp \{ -S_\Lambda[\phi_\Lambda, j] \},$$

where $\phi_\Lambda(p)$ are the soft fields with frequency smaller than Λ . Obviously $Z[j]$ does not depend on Λ , and this is the basis of Wilson renormalization group. In particular we can take Λ small. If we consider sources $j(p)$ with frequencies larger than Λ , the integration over ϕ_Λ generates only virtual loops with soft momenta $p^2 < \Lambda^2$. Since the theory is infrared finite (at least perturbatively, see Section 4), these contributions vanish for $\Lambda \rightarrow 0$ and in this limit we can ignore the ϕ_Λ dependence in the new action and we can write

$$S_\Lambda[\phi_\Lambda, j] \simeq S_\Lambda[0, j] = -W[j; \Lambda] \rightarrow -W[j].$$

The two functionals $S_\Lambda[0, j]$ and $-W[j; \Lambda]$ are equal, since to use the cutoff propagator $D_{\Lambda, \Lambda_0}(p)$ is equivalent to integrate only over fields with frequencies larger than Λ . In the framework of renormalization group, it is more typical to consider sources with frequencies softer than Λ and compute $S_\Lambda[\phi_\Lambda, 0]$ which is the action at the scale Λ . It is easy to show that $S_\Lambda[\phi_\Lambda, 0] = S_\Lambda[0, j]$ with $\phi_\Lambda(p) = D_{\Lambda, \Lambda_0}(p)j(p)$. This explains why the Polchinski equation for $S_\Lambda[\phi_\Lambda, 0]$ is the same as the evolution equation for $W[j; \Lambda]$ obtained from (6) provided one identifies $\phi_\Lambda(p)$ with $D_{\Lambda, \Lambda_0}(p)j(p)$. The fact that $S_\Lambda[\phi_\Lambda, 0]$ generates cutoff Green functions with amputated external propagators has been observed also in Refs. [8]-[10].

2.2 Evolution equation for the vertex functions

To study the renormalizability and the infrared finiteness of this theory it is more convenient to consider the proper vertices $\Gamma_{2n}(p_1, \dots, p_{2n})$ (see Fig. 1a) and their generating functional

$$\Gamma[\psi] = \sum_{n=1} \frac{1}{(2n)!} \int \prod_{i=1}^{2n} \frac{d^4 p_i}{(2\pi)^4} \psi(p_i) \Gamma_{2n}(p_1, \dots, p_{2n}) (2\pi)^4 \delta^4\left(\sum_{i=1}^{2n} p_i\right),$$

which is related to $W[j]$ by the Legendre transformation

$$\Gamma[\psi] = -W[j] + W[0] + \int \frac{d^4 p}{(2\pi)^4} j(p) \psi(-p), \quad (2\pi)^4 \frac{\delta \Gamma}{\delta \psi(-p)} = j(p).$$

In the same way we introduce the cutoff effective action $\Gamma[\psi; \Lambda]$ as Legendre transformation of $W[j; \Lambda]$. Taking into account that

$$\Lambda \frac{\partial}{\partial \Lambda} \Gamma[\psi; \Lambda] = -\Lambda \frac{\partial}{\partial \Lambda} W[j; \Lambda] + \Lambda \frac{\partial}{\partial \Lambda} W[0; \Lambda],$$

the evolution equation for the cutoff effective action is given by

$$\begin{aligned} \Lambda \frac{\partial}{\partial \Lambda} \left\{ \Gamma[\psi; \Lambda] - \frac{1}{2} \int \frac{d^4 p}{(2\pi)^4} D_{\Lambda, \Lambda_0}^{-1}(p) \psi(p) \psi(-p) \right\} \\ = \frac{1}{2} \int \frac{d^4 q}{(2\pi)^4} \frac{\Lambda \partial D_{\Lambda, \Lambda_0}^{-1}(q)}{\partial \Lambda} (2\pi)^8 \frac{\delta^2 W[j; \Lambda]}{\delta j(q) \delta j(-q)} + \Lambda \frac{\partial}{\partial \Lambda} W[0; \Lambda]. \end{aligned} \quad (7)$$

The functional in the integrand is the inverse of $\delta^2 \Gamma[\psi] / \delta \psi(q) \delta \psi(q')$

$$\delta^4(q + q') = (2\pi)^8 \int d^4 q'' \frac{\delta^2 \Gamma[\psi]}{\delta \psi(q) \delta \psi(q'')} \frac{\delta^2 W[j]}{\delta j(-q'') \delta j(q')}, \quad (8)$$

and is obtained as follows. First we isolate the two point function contribution in the two functionals

$$\begin{aligned} (2\pi)^8 \frac{\delta^2 \Gamma[\psi]}{\delta \psi(q) \delta \psi(q')} &= (2\pi)^4 \delta^4(q + q') \Gamma_2(q; \Lambda) + \Gamma_2^{int}[q, q', \psi], \\ (2\pi)^8 \frac{\delta^2 W[j; \Lambda]}{\delta j(q) \delta j(q')} &= (2\pi)^4 \delta^4(q + q') \frac{1}{\Gamma_2(q; \Lambda)} + W_2^{int}[q, q', j]. \end{aligned} \quad (9)$$

Notice that the two point function contribution in the second equation cancels the constant term $\Lambda \partial W[0; \Lambda] / \partial \Lambda$ in (7). Then, from (8) we obtain W_2^{int} as functional of $\psi(p)$

$$W_2^{int}[q, q', j] = -\frac{1}{\Gamma_2(q; \Lambda)} \bar{\Gamma}[q, q', \psi] \frac{1}{\Gamma_2(q'; \Lambda)},$$

where the auxiliary functional $\bar{\Gamma}$ satisfies the equation

$$\bar{\Gamma}[q, q', \psi] = \Gamma_2^{int}[q, q', \psi] - \int \frac{d^4 q''}{(2\pi)^4} \Gamma_2^{int}[q, -q'', \psi] \frac{1}{\Gamma_2(q''; \Lambda)} \bar{\Gamma}[q'', q', \psi]. \quad (10)$$

By expanding this equation we obtain the auxiliary vertices $\bar{\Gamma}_{2n+2}(q, p_1, \dots, p_{2n}, q'; \Lambda)$ (see Fig. 1b) in terms of the proper vertices. For $n = 1$ we find

$$\bar{\Gamma}_4(q, p_1, p_2, q'; \Lambda) = \Gamma_4(q, p_1, p_2, q'; \Lambda),$$

and in general (see Fig. 2)

$$\begin{aligned} \bar{\Gamma}_{2n+2}(q, p_1, \dots, p_{2n}, q'; \Lambda) &= \Gamma_{2n+2}(q, p_1, \dots, p_{2n}, q'; \Lambda) \\ &- \sum \Gamma_{2k+2}(q, p_{i_1}, \dots, p_{i_{2k}}, -Q; \Lambda) \frac{1}{\Gamma_2(Q; \Lambda)} \bar{\Gamma}_{2n-2k+2}(Q, p_{i_{2k+1}}, \dots, p_{i_{2n}}, q'; \Lambda) \end{aligned} \quad (11)$$

where $Q = q + p_{i_1} + \dots + p_{i_{2k}}$ and the sum is over $k = 1 \dots n-1$ and over the $\binom{2n}{2k}$ combinations of $(i_1 \dots i_{2n})$.

In conclusion the evolution equation for the functional $\Gamma[\psi]$ is

$$\begin{aligned} \Lambda \frac{\partial}{\partial \Lambda} \left\{ \Gamma[\psi; \Lambda] - \frac{1}{2} \int \frac{d^4 p}{(2\pi)^4} D_{\Lambda, \Lambda_0}^{-1}(p) \psi(p) \psi(-p) \right\} \\ = -\frac{1}{2} \int \frac{d^4 q}{(2\pi)^4} \frac{\Lambda \partial D_{\Lambda, \Lambda_0}^{-1}(q)}{\partial \Lambda} \left[\frac{1}{\Gamma_2(q; \Lambda)} \right]^2 \bar{\Gamma}[q, -q, \psi]. \end{aligned}$$

After isolating the interaction part of the two point function

$$\Gamma_2(p; \Lambda) = D_{\Lambda, \Lambda_0}^{-1}(p) + \Sigma(p; \Lambda),$$

the evolution equation for the proper vertices are

$$\Lambda \frac{\partial}{\partial \Lambda} \Sigma(q; \Lambda) = \frac{1}{2} \int \frac{d^4 q}{(2\pi)^4} \frac{S(q; \Lambda)}{q^2} \Gamma_4(q, p, -p, -q; \Lambda), \quad (12a)$$

and

$$\Lambda \frac{\partial}{\partial \Lambda} \Gamma_{2n}(p_1, \dots, p_{2n}; \Lambda) = \frac{1}{2} \int \frac{d^4 q}{(2\pi)^4} \frac{S(q; \Lambda)}{q^2} \bar{\Gamma}_{2n+2}(q, p_1, \dots, p_{2n}, -q; \Lambda), \quad (12b)$$

where $S(q; \Lambda)$ is given by

$$\frac{S(q; \Lambda)}{q^2} \equiv \frac{\Lambda \partial D_{\Lambda, \Lambda_0}(q)}{\partial \Lambda} \left[\frac{1}{1 + D_{\Lambda, \Lambda_0}(q) \Sigma(q; \Lambda)} \right]^2. \quad (13)$$

These equations involve in the right hand side vertices at the infrared cutoff Λ with a pair of exceptional momenta q and $-q$. For $\Lambda \rightarrow 0$ these vertices become singular since we are dealing with a massless theory. In a next Section we analyse this limit and show that Eq. (12) allows one to obtain vertex functions Γ_{2n} with non exceptional momenta which are finite for $\Lambda \rightarrow 0$, order by order in perturbation theory.

2.3 Physical couplings and boundary conditions

In the study of renormalization we should control the quantities with non negative momentum dimension, *i.e.* the “relevant” couplings. Dimensional analysis gives

$$\Gamma_{2n} \sim \bar{\Gamma}_{2n} \sim \Lambda^{4-2n}.$$

Thus the “relevant” couplings are

$$\gamma_2(\Lambda) = \frac{d\Sigma(p^2; \Lambda)}{dp^2} \Big|_{p^2=\mu^2}, \quad \gamma_3(\Lambda) = \Sigma(0; \Lambda), \quad \gamma_4(\Lambda) = \Gamma_4(\bar{p}_1, \bar{p}_2, \bar{p}_3, \bar{p}_4; \Lambda),$$

and correspond, for $\Lambda = 0$, to the physical couplings introduced in (1). We then isolate the relevant couplings in the two and four point vertices

$$\begin{aligned} \Sigma(p^2; \Lambda) &= p^2 \gamma_2(\Lambda) + \gamma_3(\Lambda) + \Delta_2(p^2; \Lambda), \\ \Gamma_4(p_1, p_2, p_3, p_4; \Lambda) &= \gamma_4(\Lambda) + \Delta_4(p_1, p_2, p_3, p_4; \Lambda), \end{aligned} \quad (14)$$

where $\Delta_2(0; \Lambda) = 0$, $\partial\Delta_2(p^2; \Lambda)/\partial p^2 = 0$ at $p^2 = \mu^2$, and $\Delta_4(\{\bar{p}_i\}; \Lambda) = 0$ at the symmetric point (2). From dimensional analysis we have

$$\begin{aligned} \gamma_2 \sim \gamma_4 \sim (\Lambda)^0, \quad \gamma_3 \sim (\Lambda)^2, \\ \Delta_2 \sim \Delta_4 \sim (\Lambda)^{-2}. \end{aligned}$$

Notice that in $\Delta_2(p^2; \Lambda)$ four powers of momentum are absorbed by the p -dependence required by the two conditions at $p^2 = 0$ and $p^2 = \mu^2$. Similarly in Δ_4 two powers of momentum are absorbed by the p_i -dependence required by the condition at the symmetric point.

To obtain the vertex functions from the evolution equation (12) we need the boundary conditions. For the relevant couplings $\gamma_i(\Lambda)$ they are defined at the physical value $\Lambda = 0$ by the conditions (1)

$$\gamma_2(\Lambda = 0) = 0, \quad \gamma_3(\Lambda = 0) = 0, \quad \gamma_4(\Lambda = 0) = g. \quad (15a)$$

The physical requirement we have to set on the remaining vertex functions is that they are irrelevant when the ultraviolet cutoff Λ_0 is set to infinity. The simplest choice is to set all these “irrelevant” vertices to zero at $\Lambda = \Lambda_0$

$$\Delta_2(p^2; \Lambda_0) = 0, \quad \Delta_4(p_1, p_2, p_3, p_4; \Lambda_0) = 0, \quad \Gamma_{2n}(p_1, \dots, p_{2n}; \Lambda_0) = 0, \quad n \geq 3. \quad (15b)$$

With these conditions the functional $\Gamma[\psi; \Lambda]$ has the form of the action in (4) with $\gamma_i^{(B)}$ given by the relevant couplings γ_i evaluated at $\Lambda = \Lambda_0$. The bare coupling constant is then $g^{(B)} = \gamma_4^{(B)} / (1 + \gamma_2^{(B)})^2$.

The evolution equations (12) with the boundary conditions (15), can be converted into a set of integral equations. For the three relevant couplings γ_i the boundary conditions (15a) give

$$\begin{aligned} \gamma_2(\Lambda) &= \frac{1}{2} \int \frac{d^4 q}{(2\pi)^4} \int_0^\Lambda \frac{d\lambda}{\lambda} \frac{S(q; \lambda)}{q^2} \frac{\partial}{\partial p^2} \Gamma_4(q, p, -p, -q; \lambda) \Big|_{p^2=\mu^2}, \\ \gamma_3(\Lambda) &= \frac{1}{2} \int \frac{d^4 q}{(2\pi)^4} \int_0^\Lambda \frac{d\lambda}{\lambda} \frac{S(q; \lambda)}{q^2} \Gamma_4(q, 0, 0, -q; \lambda), \\ \gamma_4(\Lambda) &= g + \frac{1}{2} \int \frac{d^4 q}{(2\pi)^4} \int_0^\Lambda \frac{d\lambda}{\lambda} \frac{S(q; \lambda)}{q^2} \bar{\Gamma}_6(q, \bar{p}_1, \dots, \bar{p}_4, -q; \lambda). \end{aligned} \quad (16)$$

For the other vertices, the boundary conditions (15b) give

$$\begin{aligned}
\Gamma_{2n}(p_1 \dots p_{2n}; \Lambda) &= -\frac{1}{2} \int \frac{d^4 q}{(2\pi)^4} \int_{\Lambda}^{\Lambda_0} \frac{d\lambda}{\lambda} \frac{S(q; \lambda)}{q^2} \bar{\Gamma}_{2n+2}(q, p_1, \dots, p_{2n}, -q; \lambda), \\
\Delta_2(p; \Lambda) &= -\frac{1}{2} \int \frac{d^4 q}{(2\pi)^4} \int_{\Lambda}^{\Lambda_0} \frac{d\lambda}{\lambda} \frac{S(q; \lambda)}{q^2} \Delta\Gamma_4(q, p, -p, -q; \lambda), \\
\Delta_4(p_1 \dots p_4; \Lambda) &= -\frac{1}{2} \int \frac{d^4 q}{(2\pi)^4} \int_{\Lambda}^{\Lambda_0} \frac{d\lambda}{\lambda} \frac{S(q; \lambda)}{q^2} \Delta\bar{\Gamma}_6(q, p_1, \dots, p_4, -q; \lambda),
\end{aligned} \tag{17}$$

where $n > 2$ in the first equation. The subtracted vertices $\Delta\Gamma_4$ and $\Delta\bar{\Gamma}_6$ are defined by

$$\begin{aligned}
\Delta\Gamma_4(q, p, -p, -q; \lambda) &\equiv \Gamma_4(q, p, -p, -q; \lambda) - \Gamma_4(q, 0, 0, -q; \lambda) \\
&\quad - p^2 \frac{\partial}{\partial p'^2} \Gamma_4(q, p', -p', -q; \lambda)|_{p'^2=\mu^2}, \\
\Delta\bar{\Gamma}_6(q, p_1, \dots, p_4, -q; \lambda) &\equiv \bar{\Gamma}_6(q, p_1, \dots, p_4, -q; \lambda) - \bar{\Gamma}_6(q, \bar{p}_1, \dots, \bar{p}_4, -q; \lambda).
\end{aligned} \tag{18}$$

The subtractions in $\Delta\Gamma_4$ and $\Delta\bar{\Gamma}_6$ are a consequence of isolating in eq. (14) the relevant couplings in the two and four vertices and of the different boundary conditions (15). As we expect they provide the necessary subtractions to make finite the vertex functions for $\Lambda_0 \rightarrow \infty$ at any order in perturbation theory.

We should notice the different role of boundary conditions for the relevant couplings at $\Lambda = 0$ and of the irrelevant vertices at $\Lambda = \Lambda_0 \rightarrow \infty$. For the relevant couplings this implies that the q -integration is bounded above by Λ . This is crucial for obtaining a finite result since, as expected from dimensional counting, the integrands grow with q^2 . The bare couplings, obtained by setting $\Lambda = \Lambda_0$, are therefore growing with Λ_0 and give the counterterms of the Lagrangian (4) in terms of the physical coupling g . For the other vertices the q -integration is bounded above by the ultraviolet cutoff Λ_0 . To show that the theory is renormalizable, one must prove that for $q^2 \rightarrow \infty$ the vertices in the integrands in (17) are sufficiently vanishing to allow one to take $\Lambda_0 \rightarrow \infty$.

For a sharp cutoff Eq. (13) can be written

$$\frac{S(q; \lambda)}{q^2} = -\frac{1}{\lambda} \delta(\lambda - \sqrt{q^2}) s(\lambda), \quad s(\lambda) = \left[\frac{1}{1 + \frac{1}{\lambda^2} \Sigma(\lambda; \lambda)} \right]^2, \tag{19}$$

which is independent of Λ_0 .

2.4 Loop expansion

By solving iteratively Eqs. (16) and (17) one obtains the loop expansion. Here we compute the first terms for $\Lambda_0 \rightarrow \infty$ so that the cutoff propagator is simply

$$D_{\Lambda}(q) = K_{\Lambda}(q)/q^2,$$

where $K_{\Lambda}(q) = 1$ for $q^2 \geq \Lambda^2$ and vanishes for $q^2 < \Lambda^2$. It will be clear that the limit $\Lambda \rightarrow 0$ can be taken only for non exceptional momenta. The starting point is the zero loop order in which the only non vanishing vertex is

$$\gamma_4^{(0)}(\Lambda) = g,$$

and the auxiliary vertices with $n \geq 2$ are given by (see Fig. 3)

$$\bar{\Gamma}_{2n+2}^{(0)}(q, p_1, \dots, p_{2n}, q'; \Lambda) = -(-g)^n \sum_{perm} \prod_{k=1}^{n-1} D_\Lambda \left(q + \sum_{\ell=1}^{2k} p_{i_\ell} \right), \quad (20)$$

where the sum is over $(2n)!/2^n$ terms obtained from the permutations of $(p_{i_1}, \dots, p_{i_{2n}})$ and the symmetry of the four point coupling.

1. One loop vertices.

The only non vanishing contribution for the two point function is

$$\gamma_3^{(1)}(\Lambda) = \frac{1}{2}g \int \frac{d^4q}{(2\pi)^4} \Delta_\Lambda(q) = -\frac{1}{32\pi^2}g\Lambda^2,$$

where

$$\Delta_\Lambda(q) = D_\Lambda(q) - D_0(q) = -\frac{1}{q^2}\theta(\Lambda^2 - q^2).$$

From (20) one obtains

$$\gamma_4^{(1)}(\Lambda) = -\frac{3}{2}g^2 \int \frac{d^4q}{(2\pi)^4} \{D_\Lambda(q)D_\Lambda(q + \bar{p}) - D_0(q)D_0(q + \bar{p})\},$$

where $\bar{p} = \bar{p}_i + \bar{p}_j$, $i \neq j$, and we used the symmetry of the subtraction point (2). For large Λ the range of integration is bounded by $q^2 \lesssim \Lambda^2$ and we get

$$\gamma_4^{(1)}(\Lambda) \simeq \frac{3}{16\pi^2}g^2 \ln(\Lambda/\mu), \quad \mu \ll \Lambda.$$

For small Λ we have

$$\gamma_4^{(1)}(\Lambda) \sim \Lambda^2 \quad \Lambda \ll \mu.$$

The remaining part Δ_4 of the four point vertex is obtained in a similar way

$$\begin{aligned} \Delta_4^{(1)}(p_1, \dots, p_4; \Lambda) &= -\frac{1}{2}g^2 \int \frac{d^4q}{(2\pi)^4} D_\Lambda(q) \\ &\times \{D_\Lambda(q + p_1 + p_2) + \dots - 3D_\Lambda(q + \bar{p})\}, \end{aligned}$$

where the dots stand for the other two terms with p_2 replaced by p_3 and p_4 . Due to the subtractions the integration is convergent for $q^2 \rightarrow \infty$. For large infrared cutoff this integral vanishes as μ^2/Λ^2 and P^2/Λ^2 with P a combination of external momenta. The physical value is obtained at $\Lambda = 0$ and one has

$$\Gamma_4^{(1)}(p_1, \dots, p_4) = \frac{1}{32\pi^2}g^2 \left\{ \ln\left[\frac{(p_1 + p_2)^2}{\mu^2}\right] + \dots \right\}. \quad (21)$$

In the Appendix we use this results to obtain, in this formulation, the one loop beta function.

For the vertices $\Gamma_{2n}^{(1)}$ with $n \geq 2$ we have

$$\Gamma_{2n}^{(1)}(p_1, \dots, p_{2n}; \Lambda) = -\frac{(-g)^n}{2n} \int \frac{d^4q}{(2\pi)^4} D_\Lambda(q) \sum_{perm} \prod_{k=1}^{n-1} D_\Lambda \left(q + \sum_{\ell=1}^{2k} p_{i_\ell} \right). \quad (22)$$

The integral is convergent for large q^2 . At the physical value $\Lambda = 0$ these vertex functions become singular for vanishing momenta. However it is known [11] that the effective potential obtained by summing the vertex functions for vanishing momenta is infrared finite. We rederive here the one loop effective potential $V(\psi)$ in order to illustrate in this framework the role of the regularization and the physical conditions in (1). Apart from a volume factor, $V(\psi)$ is given by $\Gamma[\psi]$ obtained with the source $\psi(p) = (2\pi)^4 \delta^4(p)\psi$. For non vanishing Λ we get

$$V(\psi) = \frac{1}{2}\gamma_3^{(1)}\psi^2 + \frac{1}{4!}(g + \gamma_4^{(1)})\psi^4 - \frac{1}{2} \int \frac{d^4q}{(2\pi)^4} \Theta(q^2 - \Lambda^2) \left\{ \sum_{n=2}^{\infty} \frac{1}{n} \left(\frac{-g\psi^2}{2q^2} \right)^n - \frac{(g\psi^2)^2}{8q^2(q + \bar{p})^2} \right\}.$$

The various terms diverge at $q = 0$ for $\Lambda = 0$. However, performing the sum and then taking $\Lambda = 0$, we have

$$V(\psi) = \frac{g}{4!}\psi^4 + \frac{1}{2} \int \frac{d^4q}{(2\pi)^4} \left\{ \ln \left(1 + \frac{g\psi^2}{2q^2} \right) - \frac{g\psi^2}{2q^2} + \frac{(g\psi^2)^2}{8q^2(q + \bar{p})^2} \right\}.$$

This expression does not have any infrared singularity for $q = 0$ and the integral is convergent at large q (see Ref. [11]).

2. Two loop propagator.

By using the previous results we find

$$\begin{aligned} \Gamma_2^{(2)}(p; \Lambda) &= \Gamma_2^{(2)}(p; 0) - \frac{g^2}{3!} \int \frac{d^4q}{(2\pi)^4} \Delta_\Lambda(q) \int \frac{d^4q'}{(2\pi)^4} \left\{ \Delta_\Lambda(q') \Delta_\Lambda(q + q' + p) \right. \\ &\quad \left. + \frac{3}{2} \left[D_\Lambda^2(q') + 2D_0(q')D_\Lambda(q + q' + p) - 3D_0(q')D_0(q + q' - \bar{p}) \right] \right\}. \end{aligned} \quad (23)$$

The q -integration is bounded by the factor $\Delta_\Lambda(q)$ which gives $q^2 \leq \Lambda^2$. The q' -integration for the first term in the curly bracket is also bounded by Λ . For the second term the q' -integration is convergent because of subtractions. The value of $\Gamma_2^{(2)}(p; 0)$ is given by

$$\Gamma_2^{(2)}(p, 0) = -\frac{g^2}{3!} \int \frac{d^4q}{(2\pi)^4} \int \frac{d^4q'}{(2\pi)^4} \frac{1}{q^2 q'^2} \left[\frac{1}{(q + q' + p)^2} - \frac{1}{(q + q')^2} - p^2 \frac{\partial}{\partial p'^2} \frac{1}{(q + q' + p')^2} \right]$$

where $p'^2 = \mu^2$ and the integrations are convergent due to the subtractions.

3 Perturbative renormalizability

In this section we prove that the theory is perturbative renormalizable, namely that in (17) we can set $\Lambda_0 \rightarrow \infty$. As shown before, the loop expansion is obtained by iterating Eqs. (16) and (17). From the vertices $\Gamma_{2n}^{(\ell)}$ one constructs the integrands at the loop ℓ which give the next loop vertices upon q -integration. The convergence of the integrals giving $\Gamma_{2n}^{(\ell+1)}$ will be ensured by dimensional counting, while the one for Δ_2 and Δ_4 will require the subtractions in $\Delta\Gamma_4$ and $\Delta\bar{\Gamma}_6$ given in (18). The convenient way to represent the subtracted vertices $\Delta\Gamma_4$ and $\Delta\bar{\Gamma}_6$ is by Taylor expansion as for the Bogoliubov R operators.

Since we are interested in the large λ behaviour we use the expansion around vanishing momenta. We need to consider only even derivatives since odd derivative terms vanish for symmetry either directly or after integration. The subtracted vertex $\Delta\bar{\Gamma}_6$ is obtained considering the expansion

$$\begin{aligned} \bar{\Gamma}_6(q, p_1, \dots, p_4, -q; \lambda) &= \bar{\Gamma}_6(q, 0, \dots, 0, -q; \lambda) \\ &+ \int_0^1 dx (1-x) \left(\sum_{i=1}^3 p_i \cdot \partial'_{i,4} \right)^2 \bar{\Gamma}_6(q, p'_1, \dots, p'_4, -q; \lambda) \Big|_{p'_i=xp_i} \end{aligned} \quad (24a)$$

where $\partial'_{i,4} = \partial/\partial p'_i - \partial/\partial p'_4$. The first term, which is the most singular contribution, is cancelled in the subtracted quantity $\Delta\bar{\Gamma}_6$. For $\Delta\Gamma_4$ we need to consider the expansion up to four derivatives

$$\begin{aligned} \Delta\Gamma_4(q, p, -p, -q; \lambda) &= \frac{1}{3!} \int_0^1 dx (1-x)^3 (p \cdot \partial')^4 \Gamma_4(q, p', -p', -q; \lambda) \Big|_{p'=xp} \\ &- \frac{1}{2} (p \cdot \partial')^2 \{ \Gamma_4(q, p', -p', -q; \lambda) \Big|_{p'^2=\mu^2} - \Gamma_4(q, p', -p', -q; \lambda) \Big|_{p'=0} \} \end{aligned} \quad (24b)$$

where $\partial' = \partial/\partial p'$. Notice that also the second term can be expressed by the fourth derivative of Γ_4 . Similarly the integrand for γ_2 can be expressed in terms of the second derivative of Γ_4 with respect to the momentum components.

In order to prove that the theory is perturbatively renormalizable we have to analyse the behaviour for large λ of the vertices in the integrands and show that the integration over λ is convergent for $\lambda \rightarrow \infty$ (the convergence of the integrals for $\lambda \rightarrow 0$ will be discussed in the next section). In this analysis we are not interested in the detailed dependence of the vertices on the external momenta, except for the fact that the integration momentum is fixed at $q^2 = \lambda^2$ (see (19)). To prove perturbative renormalizability it will be sufficient, as in [6], to bound the large λ behaviour of the vertices in which all external momenta do not exceed the cutoff. We then introduce the following functions which depend only on λ

$$|f_{2n}|_\lambda \equiv \text{Max}_{p_i^2 < c\lambda^2} |f_{2n}(p_1, \dots, p_{2n}; \lambda)| \quad (25)$$

where c is some numerical constant and $f(p_1, \dots, p_n; \lambda)$ is Γ_{2n} , $\bar{\Gamma}_{2n+2}$ or one of their derivatives. Iterating (16) and (17) in which we set $\Lambda_0 \rightarrow \infty$, we obtain the following bounds. For the relevant couplings

$$\gamma_2^{(\ell+1)}(\Lambda) \lesssim \int_0^{\Lambda^2} d\lambda^2 s^{(\ell-\ell')}(\lambda) |\partial^2 \Gamma_4^{(\ell')}|_\lambda, \quad (26a)$$

$$\gamma_3^{(\ell+1)}(\Lambda) \lesssim \int_0^{\Lambda^2} d\lambda^2 s^{(\ell-\ell')}(\lambda) |\Gamma_4^{(\ell')}|_\lambda, \quad (26b)$$

$$\gamma_4^{(\ell+1)}(\Lambda) \lesssim \int_0^{\Lambda^2} d\lambda^2 s^{(\ell-\ell')}(\lambda) |\bar{\Gamma}_6^{(\ell')}|_\lambda. \quad (26c)$$

For the irrelevant vertices

$$|\Gamma_{2n}^{(\ell+1)}|_\Lambda \lesssim \int_{\Lambda^2}^\infty d\lambda^2 s^{(\ell-\ell')}(\lambda) |\bar{\Gamma}_{2n+2}^{(\ell')}|_\lambda, \quad (27a)$$

$$|\Delta_2^{(\ell+1)}|_\Lambda \lesssim \Lambda^4 \int_{\Lambda^2}^\infty d\lambda^2 s^{(\ell-\ell')}(\lambda) |\partial^4 \Gamma_4^{(\ell')}|_\lambda, \quad (27b)$$

$$|\Delta_4^{(\ell+1)}|_\Lambda \lesssim \Lambda^2 \int_{\Lambda^2}^\infty d\lambda^2 s^{(\ell-\ell')}(\lambda) |\partial^2 \bar{\Gamma}_6^{(\ell')}|_\lambda. \quad (27c)$$

For the derivatives of vertices

$$|\partial^m \Gamma_{2n}^{(\ell+1)}|_\Lambda \lesssim \int_{\Lambda^2}^\infty d\lambda^2 s^{(\ell-\ell')}(\lambda) |\partial^m \bar{\Gamma}_{2n+2}^{(\ell')}|_\lambda, \quad (28a)$$

$$|\partial^m \Delta_2^{(\ell+1)}|_\Lambda \lesssim \Lambda^4 \int_{\Lambda^2}^\infty d\lambda^2 s^{(\ell-\ell')}(\lambda) |\partial^{m+4} \Delta_4^{(\ell')}|_\lambda, \quad (28b)$$

$$|\partial^m \Delta_4^{(\ell+1)}|_\Lambda \lesssim \Lambda^2 \int_{\Lambda^2}^\infty d\lambda^2 s^{(\ell-\ell')}(\lambda) |\partial^{m+2} \bar{\Gamma}_6^{(\ell')}|_\lambda. \quad (28c)$$

where ∂^m stands for m partial derivatives with respect to momentum components and the factors Λ^2 and Λ^4 in front of integrals come by maximizing the p^2 or p^4 factors in (24a) and (24b) respectively. Actually ∂^m in (28b)-(28c) could also act on these p factors. As we will show in the following all these contributions are of the same order.

We now prove by induction that the theory is perturbatively renormalizable, namely that the integrals in (27) and (28) are convergent for $\lambda \rightarrow \infty$. By using the majorization in (26)-(28), as one can expect, the proof becomes very simple.

1) *Assumptions at the loop ℓ .*

The assumptions we make are simply given by dimensional counting except for logarithmic corrections and they involve the nine quantities above.

a) Relevant couplings ($T = \log(\Lambda/\mu)$)

$$\gamma_2^{(\ell)}(\Lambda) = \mathcal{O}(T^{\ell-1}), \quad \gamma_3^{(\ell)}(\Lambda) = \mathcal{O}(\Lambda^2 T^{\ell-1}), \quad \gamma_4^{(\ell)}(\Lambda) = \mathcal{O}(T^\ell). \quad (29)$$

b) Irrelevant vertices

$$|\Gamma_{2n}^{(\ell)}|_\Lambda = \mathcal{O}(\Lambda^{4-2n} T^{\ell-1}), \quad |\Delta_2^{(\ell)}|_\Lambda = \mathcal{O}(\Lambda^2 T^{\ell-2}), \quad |\Delta_4^{(\ell)}|_\Lambda = \mathcal{O}(T^{\ell-1}), \quad (30)$$

c) Derivative vertices

$$|\partial^m \Gamma_{2n}^{(\ell)}|_\Lambda = \mathcal{O}(\Lambda^{4-2n-m} T^{\ell-1}), \quad |\partial^m \Delta_2^{(\ell)}|_\Lambda = \mathcal{O}(\Lambda^{2-m} T^{\ell-2}), \quad |\partial^m \Delta_4^{(\ell)}|_\Lambda = \mathcal{O}(\Lambda^{-m} T^{\ell-1}). \quad (31)$$

These assumptions are satisfied for $\ell = 0$ and 1.

2) *Iteration to the loop $\ell + 1$.*

Notice that the powers of Λ in (29)-(31) are independent of the number of loops since they are dictated by dimensional counting. For the relevant (irrelevant) couplings the integrands increase (decrease) with λ thus the integrals are dominated by the upper (lower) limit $\lambda = \Lambda$. For the irrelevant couplings we can therefore take the limit $\Lambda_0 \rightarrow \infty$, removing the ultraviolet cutoff. It is simple to see that the integrals in (26)-(28) reproduce at loop $\ell + 1$ the same dimensional counting behaviours. This is just what is needed to prove the perturbative renormalizability, since logarithmic corrections cannot change the power counting at any finite order. Actually it is relatively simple to control also the powers of T and in the following we show that the behaviours (29)-(31) are reproduced by the iteration.

Before discussing the large Λ behaviours at the $\ell + 1$ loop we derive from (29)-(31) some intermediate results for the integrands at loop ℓ .

a) From the two point function and (19) we have

$$s^{(\ell)}(\lambda) \sim t^{\ell-1},$$

where $t \equiv \log(\lambda/\mu)$.

b) The leading term of the auxiliary vertices $\bar{\Gamma}_{2n+2}$ is given by the contribution of Fig. 4 in which only four point vertices are involved

$$|\bar{\Gamma}_{2n+2}^{(\ell)}|_{\lambda} \sim \lambda^{2-2n} \prod_1^n \gamma_4^{(\ell_i)}(\lambda) \sim \lambda^{2-2n} t^{\ell},$$

where $\sum \ell_i = \ell$ and we have a factor λ^{-2} for each internal propagator. All other contributions coming from higher vertices and from loop corrections in the intermediate propagators give the same power in λ^2 but a lower power in t .

c) The leading term of the derivatives of the auxiliary vertices is again obtained from the contribution of Fig. 4 in which the derivatives act on the internal propagators

$$|\partial^m \bar{\Gamma}_{2n+2}^{(\ell)}|_{\lambda} \sim \lambda^{2-2n-m} t^{\ell}.$$

Again, the contributions from derivatives of higher vertices or from loop corrections of internal propagators give lower powers of t .

By using these results in (26)-(28) we reproduce at $\ell + 1$ loop order the behaviours in (29)-(31) In all cases we have $\ell' = \ell$; *i.e.* loop corrections of the propagator in $s(\lambda)$ are not contributing to the leading terms.

4 Infrared behaviour

In this section we show that for the massless scalar theory, the vertex functions at non exceptional momenta are finite order by order in perturbation theory. Namely we prove that the integration over q in (16) and (17) is convergent at the lower limit when we take $\Lambda \rightarrow 0$. As in the case of renormalizability, this is shown by induction on the number of loops.

The integrands in (16) and (17) are given by vertices with one pair $(q, -q)$ of exceptional momenta. Thus, by iteration, one introduces vertices with any number of pairs of exceptional momenta. In general we say that a pair of momenta p_i and p_j in $\Gamma_{2n}(\{p_i\}; \Lambda)$ is exceptional if $p_i + p_j = \mathcal{O}(\Lambda)$. In the following we add an index to the vertex functions to identify the number of pairs of exceptional momenta. We write

$$\Gamma_{2n,s}(\{p_i\}; \Lambda) \equiv \Gamma_{2n}(\{p_i\}; \Lambda), \quad \text{for} \quad (p_{i_1} + p_{i_2}), \dots, (p_{i_{2s-1}} + p_{i_{2s}}) = \mathcal{O}(\Lambda).$$

where $s = 0, \dots, n - 1$. For $s = n - 1$ all pairs of momenta are exceptional. Therefore we denote by $\Gamma_{2n,0}$ the vertices without exceptional momenta. Similar notation will be used for the auxiliary vertices $\bar{\Gamma}_{2n+2,s+1}$ with $s + 1$ pairs of exceptional momenta.

1) *Assumptions at the loop ℓ*

For $\Lambda \rightarrow 0$ we assume the following behaviours

$$\Gamma_{2n,0}^{(\ell)}(\Lambda) \rightarrow \text{finite}, \quad (32a)$$

$$\Gamma_{2n,1}^{(\ell)}(p_1, \dots, p_{2n}; \Lambda) = \mathcal{O}(T^\ell), \quad (32b)$$

$$\Gamma_{2n,s}^{(\ell)}(p_1, \dots, p_{2n}; \Lambda) = \mathcal{O}(\Lambda^{2-2s} T^{\ell-1}) \quad s = 2 \dots n-1, \quad (32c)$$

$$\Gamma_2^{(\ell)}(p; \Lambda) = \mathcal{O}(\Lambda^2 T^{\ell-1}) \quad \text{for } p^2 = \mathcal{O}(\Lambda^2), \quad (32d)$$

$$\frac{\partial}{\partial p_\mu} \Gamma_{2n,n-1}^{(\ell)}(p, -p, p_1, \dots, p_{2n-2}; \Lambda) = \mathcal{O}(\Lambda^{4-2n} T^{\ell-1} \frac{p_\mu + P_\mu}{\Lambda^2}), \quad (32e)$$

where $T = \ln(\Lambda/\mu)$. The first equation states the most important result. In (32e) all momenta are of order Λ and P_μ stands for any combination of p_i 's. These assumptions are satisfied for $\ell = 0$ and 1 (see Subsection 2.3).

2) Iteration at loop $\ell + 1$

Before discussing the $\Lambda \rightarrow 0$ behaviour at loop $\ell + 1$ we derive from (32) some intermediate results for the vertices at loop ℓ entering in the integrands of (16) and (17)

a) From the two point function we have

$$s^{(\ell)}(\lambda) = \mathcal{O}(t^{\ell-1}), \quad (33)$$

where $t = \log(\lambda/\mu)$.

b) For the four point function we have

$$\frac{\partial}{\partial p^2} \Gamma_{4,1}^{(\ell)}(q, p, -p, -q; \lambda)|_{p^2=\mu^2, q^2=\lambda^2} = \mathcal{O}(t^\ell),$$

$$\Delta \Gamma_4^{(\ell)}(q, p, -p, -q; \lambda)|_{q^2=\lambda^2} = \mathcal{O}(t^\ell).$$

The first equation is obtained from (32b) observing that the derivative is evaluated at non vanishing momentum, while the second is obtained from the behaviour of the single terms in the subtracted vertex $\Delta \Gamma_4$. Actually there are cancellations giving a less singular behaviour, but we do not need to analyse them.

c) For the auxiliary vertices with $s = 0$ we have

$$\bar{\Gamma}_{2n+2,1}^{(\ell)}(q, p_1, \dots, p_{2n}, -q; \lambda)|_{q^2=\lambda^2} \sim \Gamma_{2n+2,1}^{(\ell)}(\lambda) \sim t^\ell. \quad (34)$$

This behaviour is given by the first contribution of Fig. 2. Since only the pair $(q, -q)$ is exceptional, the other terms involve vertices with non exceptional momenta which are finite.

d) For the auxiliary vertices with $s > 0$ we have

$$\bar{\Gamma}_{2n+2,s+1}^{(\ell)}(q, p_1, \dots, p_{2n}, -q; \lambda)|_{q^2=\lambda^2} \sim \lambda^{-2s} t^\ell, \quad s \geq 1. \quad (35)$$

This behaviour is obtained by taking the largest number of internal propagators at momentum $q^2 = \lambda^2$. This is given by the contribution of Fig. 5 in which the s pairs of exceptional

momenta among the p_i 's are emitted in the four point functions to the left (or right). In this way we have s internal propagators at momentum $q^2 = \lambda^2$ giving the factor λ^{-2s} in (35). Loop corrections to the internal propagators give non leading logarithmic powers.

e) For the derivatives of the auxiliary vertices with all exceptional momenta we have

$$\frac{\partial}{\partial p_\mu} \bar{\Gamma}_{2n+2,n}^{(\ell)}(q, p, -p, p_1 \cdots p_{2n-2}, -q; \lambda) = \mathcal{O}(\lambda^{4-2n} t^\ell \frac{p_\mu + q_\mu + P_\mu}{\lambda^4}), \quad n > 1. \quad (36)$$

This behaviour is given by the graphs of Fig. 6. Here P_μ is a combination of p_i 's and the derivative acts on a propagator connecting the two vertices with p or $-p$ incoming. All other contributions with higher vertices, with loop corrections in the propagators or with the derivatives acting on vertices lead to lower powers of t .

We now deduce the $\Lambda \rightarrow 0$ behaviour of the $\ell + 1$ vertices.

a) For the two point function we find

$$\begin{aligned} \gamma_2^{(\ell+1)}(\Lambda) &= \mathcal{O}(\Lambda^2 T^\ell) \rightarrow 0, \\ \gamma_3^{(\ell+1)}(\Lambda) &= \mathcal{O}(\Lambda^2 T^\ell) \rightarrow 0, \\ \Delta_2^{(\ell+1)}(p; \Lambda) &= \mathcal{O}(\Lambda^0). \end{aligned}$$

One can show that the behaviour for $\gamma_2^{(\ell+1)}$ can be improved to $\Lambda^2 T^{\ell-2}$. These results show that $\Gamma_2^{(\ell+1)}$ is finite for $\Lambda \rightarrow 0$, thus verifying the main assumption in (32a) for the case $n = 1$.

To study the behaviour of $\Delta_2^{(\ell+1)}$ for $p^2 = \mathcal{O}(\Lambda^2)$ we use the Taylor expansion

$$\begin{aligned} \Delta_2^{(\ell+1)}(p; \Lambda) &= \frac{1}{2} \int_\Lambda \frac{d^4 q}{(2\pi)^4} \frac{s^{(\ell-\ell')}(\lambda)}{q^2} \\ &\times \int_0^1 dx (p \cdot \partial') \Gamma_{4,1}^{(\ell')} (q, p', -p', -q; \lambda) |_{\lambda^2=q^2, p'=xp} = \mathcal{O}(p^2 T^\ell). \end{aligned} \quad (37)$$

This proves (32d) at loop $\ell + 1$. All these behaviours are obtained by ignoring loop corrections in $s(\lambda)$ since they would give lower powers of T .

b) For the four point function at non exceptional momenta we obtain from (34)

$$\gamma_4^{(\ell+1)}(\Lambda) = \mathcal{O}(\Lambda^2 T^\ell) \rightarrow 0, \quad \Delta_4^{(\ell+1)}(p_1, \cdots, p_4; \Lambda) = \mathcal{O}(\Lambda^0), \quad (38)$$

where again for the leading terms we do not have contributions from loop corrections in $s(\lambda)$.

For $\Gamma_{2n,0}^{(\ell+1)}$ with $n > 2$ we obtain from (34)

$$\Gamma_{2n,0}^{(\ell+1)}(p_1, \cdots, p_{2n}; \Lambda) = \mathcal{O}(\Lambda^0). \quad (39)$$

We conclude from (38)-(39) that all physical vertices at $\Lambda = 0$ and non exceptional momenta are finite. Moreover, as required by the condition $\gamma_4(0) = g$, the relevant coupling $\gamma_4^{(\ell+1)}(\Lambda)$ vanishes at $\Lambda = 0$. This verifies at loop $\ell + 1$ the main assumption (32a).

c) For the vertices with pairs of exceptional momenta we prove (32b)-(32c) at the $\ell + 1$ loop order by using the result in (35).

d) For the vertices with all exceptional momenta we prove (32e) at the $\ell + 1$ loop order. For $n = 1$ this is simply obtained by taking the derivative of Eq. (37) with respect to p_μ . For $n > 1$ this can be done by writing

$$\begin{aligned} & \frac{\partial}{\partial p_\mu} \Gamma_{2n,n-1}^{(\ell+1)}(p, -p, p_1, \dots, p_{2n-2}; \Lambda) \\ &= \frac{1}{2} \int_\Lambda \frac{d^4 q}{(2\pi)^4} \frac{s^{(\ell-\ell')}(\lambda)}{q^2} \frac{\partial}{\partial p_\mu} \bar{\Gamma}_{2n+2,n}^{(\ell')}(q, p, -p, p_1, \dots, p_{2n-2}, -q; \lambda) \Big|_{\lambda^2=q^2} \end{aligned}$$

and using (36).

5 Final comments

We have used the renormalization group technique to obtain in a constructive way equations for the renormalized vertices of a scalar massless theory. The loop expansion is derived from the iterative solution of these equations and is an expansion in the physical coupling g . In this approach subtractions come from the fact that we isolated (see Eq. (14)) in the two and four point functions the three relevant vertices $\gamma_i(\Lambda)$ for which we have to impose the boundary conditions (1) at the physical value $\Lambda = 0$. This procedure allows us to generate in a systematic way the subtracted vertices $\Delta\Gamma_4$ and $\Delta\bar{\Gamma}_6$ in (18) which, after integration, give Δ_2 and Δ_4 , the “irrelevant” part of the two and four point function. These subtracted vertices and the corresponding counterterms obtained from $\gamma_i(\Lambda)$ evaluated at $\Lambda = \Lambda_0$, can be expanded in the physical coupling g . This procedure of constructing the subtracted vertices is very similar to the one of Bogoliubov R -operators [1] but it seems to be based on a more physical ground. Once the subtracted vertices are identified, the proof of renormalizability depends only on dimensional counting.

In this formulation the simplifications of the analysis of the ultraviolet and infrared behaviour of the integrands of Feynman graphs is based on the fact that, at a given loop $\ell + 1$, the momentum q in (16) and (17) sets the cutoff for the vertices at the previous loop. The difference between relevant and irrelevant couplings is in the range of q -integrations with respect to the cutoff Λ . We have then that the vertices are given by combinations of Feynman graphs in which the internal loop momenta are ordered. This ordering depends on whether we are generating a relevant or irrelevant vertex. It is clear that once we have an ordering in the momenta, the asymptotic behaviour of Feynman graphs contributions can be studied by iterative procedure.

Acknowledgements

We have benefited greatly from discussions with C. Becchi and G. Korchemsky.

Appendix

We discuss in the present formulation the role of the subtraction point μ and deduce the beta function (see also Ref. [12]). Denote by $\Gamma_{2n}(g, \mu) = \Gamma_{2n}(p_1, \dots, p_{2n}; g, \mu)$ the vertices defined by (16) and (17) which satisfy the physical conditions (1) with coupling g at the scale μ . We assume the theory renormalizable and infrared finite so we set $\Lambda = 0$ and $\Lambda_0 \rightarrow \infty$. Therefore μ is the only dimensional parameter, apart for the external momenta. However physical measurements should not depend on the specific value of μ . Consider the vertices $\Gamma_{2n}(g', \mu')$ with coupling g' at a new scale μ' . The request that the two sets of vertices $\Gamma_{2n}(g, \mu)$ and $\Gamma_{2n}(g', \mu')$ describe the same theory implies that the corresponding effective actions $\Gamma[\psi; g, \mu]$ and $\Gamma[\psi'; g', \mu']$ are equal, where the two fields ψ and ψ' are related by a rescaling, $\psi'(p) = \sqrt{Z_2}\psi(p)$. This implies that the two sets of vertices are related by

$$\Gamma_{2n}(g', \mu') = Z_2^{-n}\Gamma_{2n}(g, \mu).$$

Notice that the evolution equations (12) are invariant with respect to this rescaling, provided we rescale also the propagator $D_{\Lambda, \Lambda_0}(p)$ accordingly. This implies, as usual, that Z_2 is fixed only by the physical condition (1). To obtain Z_2 we use the decomposition (14)

$$\Gamma_2(p; g, \mu) = p^2 + \Delta_2(p; g, \mu),$$

where

$$\Delta_2(0; g, \mu) = 0, \quad \frac{\partial}{\partial p^2}\Delta_2(p; g, \mu)|_{p^2=\mu^2} = 0,$$

as required by the physical conditions (1). We use the corresponding decomposition and normalization for the vertex $\Gamma_2(p; g', \mu')$. The renormalization function Z_2 is obtained by expanding $Z_2\Gamma_2(p; g', \mu') = \Gamma_2(p; g, \mu)$ at $p^2 = \mu^2$ or $p^2 = \mu'^2$. We find

$$Z_2 = 1 + a_2(\mu'; g, \mu) = \frac{1}{1 + a_2(\mu; g', \mu')},$$

where a_2 is the dimensionless quantity

$$a_2(\mu'; g, \mu) \equiv \frac{\partial}{\partial p^2}\Delta_2(p; g, \mu)|_{p^2=\mu'^2}.$$

Similarly we use the decomposition (14) for the four point function

$$\Gamma_4(p_1, \dots, p_4; g, \mu) = g + \Delta_4(p_1, \dots, p_4; g, \mu),$$

where $\Delta_4(\bar{p}_1, \dots, \bar{p}_4; g, \mu) = 0$ at the symmetric point in (2). Again we use the corresponding decomposition and normalization for the vertex $\Gamma_4(p_1, \dots, p_4; g', \mu')$. Introducing the dimensionless quantity

$$a_4(\mu'; g, \mu) \equiv \Delta_4(\bar{p}'_1, \dots, \bar{p}'_4; g, \mu), \quad \bar{p}'_i \bar{p}'_j = \mu'^2(\delta_{ij} - \frac{1}{4}),$$

from $Z_2^2\Gamma_4(g', \mu') = \Gamma_4(g, \mu)$ we obtain the renormalization group relation

$$g' = \frac{g + a_4(\mu'; g, \mu)}{(1 + a_2(\mu'; g, \mu))^2}.$$

The beta function is obtained by considering an infinitesimal scale change and is given by

$$\beta(g) = \mu' \frac{\partial}{\partial \mu'} \{a_4(\mu'; g, \mu) - 2g a_2(\mu'; g, \mu)\} |_{\mu'=\mu}.$$

Since the theory is renormalizable and infrared finite, the two quantities $a_i(\mu'; g, \mu)$ are functions of g and the ratio μ'/μ , thus and the beta function depends only on g . At the one loop order we find $a_2^{(1)}$ independent of μ' and the beta function is obtained only from $a_4^{(1)}$ given in (21). We find

$$\beta^{(1)}(g) = \frac{3}{32\pi^2} g^2 \mu' \frac{\partial}{\partial \mu'} \ln \frac{\mu'^2}{\mu^2} = \frac{3}{16\pi^2} g^2,$$

which is the usual one loop result.

References

- [1] N.N. Bogoliubov and D. Shirkov, Introduction to the theory of quantized fields, Wiley Interscience, New York; for a recent review see: V. Rivasseau, From perturbative to constructive renormalization, Princeton University press, Princeton 1991.
- [2] See for a review S. Coleman, in Proc. of Erice 1973 Eleventh Course, ed. A. Zichichi, Academic Press, New York, 1975.
- [3] T. Kinoshita, J. Math. Phys. 3 (1962) 650; T.D. Lee and M. Nauenberg, Phys. Rev. B 133 (1964) 1549.
- [4] E.C. Poggio and H.R. Quinn, Phys. Rev. D 14 (1976) 578.
- [5] K.G. Wilson, Phys. Rev. B 4 (1971) 3174,3184; K.G. Wilson and J.G. Kogut, Phys. Rep. 12 (1974) 75.
- [6] J. Polchinski, Nucl. Phys. B231 (1984) 269.
- [7] G. Gallavotti, Rev. Mod. Phys. 57 (1985) 471.
- [8] C. Becchi, Lectures on the renormalization of gauge theories, in: Relativity, groups and topology II (Les Houches 1983) Eds. B.S. DeWitt and R. Stora (Elsevier Science Pub. 1984); C. Becchi, On the construction of renormalized quantum field theory using renormalization group techniques, Lectures notes of the 1991 Italian doctoral school in Parma, Genova preprint.
- [9] L. Girardello, private communication.
- [10] G. Keller, C. Kopper and M. Salmhofer, Perturbative renormalization and effective Lagrangians in Φ_4^4 , MPI preprint, MPI-PAE/PTh 65/90.
- [11] S. Coleman and E. Weinberg, Phys. Rev. D 7 (1973) 1888.
- [12] J. Hughes and J. Liu, Nucl. Phys. B307 (1988) 183.

Figure Captions

- Figure 1: (a) Vertices $\Gamma_{2n}(p_1, \dots, p_{2n})$ and
(b) auxiliary vertices $\bar{\Gamma}_{2n+2}(q, p_1, \dots, p_{2n}, q')$.
- Figure 2: Graphical representation of the equation (11) defining the auxiliary vertices $\bar{\Gamma}_{2n+2}(q, p_1, \dots, p_{2n}, q')$.
- Figure 3: Graphical representation of the auxiliary vertices at zero loop.
- Figure 4: Graphical representation of the leading contribution of auxiliary vertices for $\Lambda \rightarrow \infty$.
- Figure 5: The leading contribution for $\Lambda \rightarrow 0$ of auxiliary vertices in which the pairs of momenta in the four point functions are exceptional.
- Figure 6: The leading contribution for $\Lambda \rightarrow 0$ of derivatives of auxiliary vertices in which all momenta are exceptional.

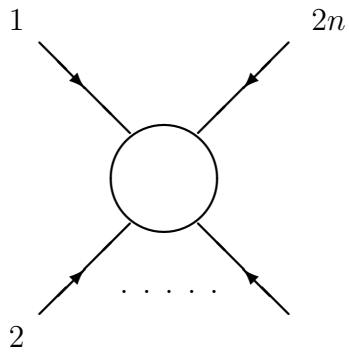

Fig. 1a

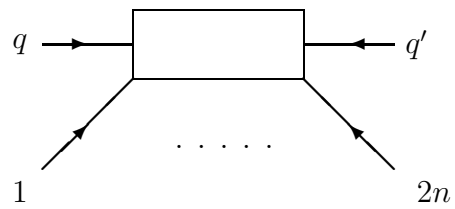

Fig. 1b

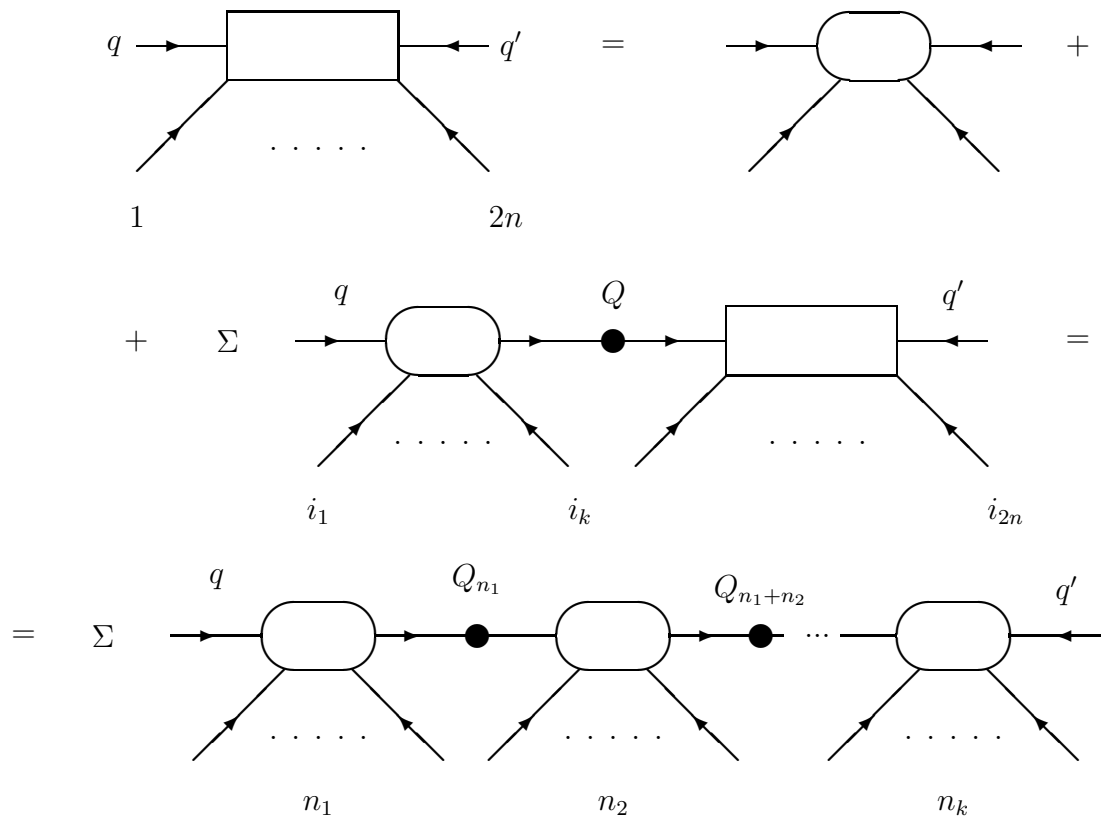

Fig. 2

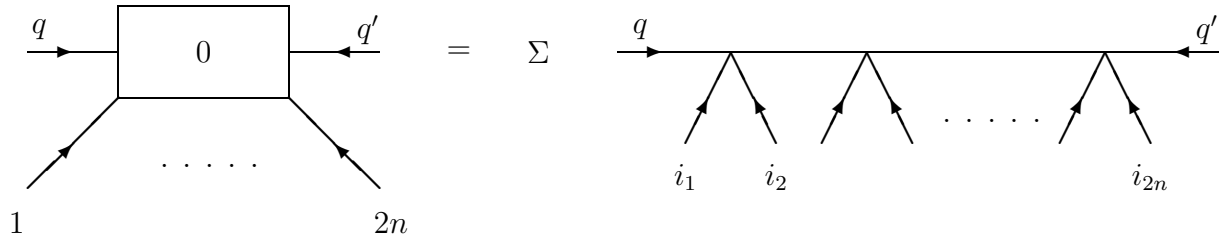

Fig. 3

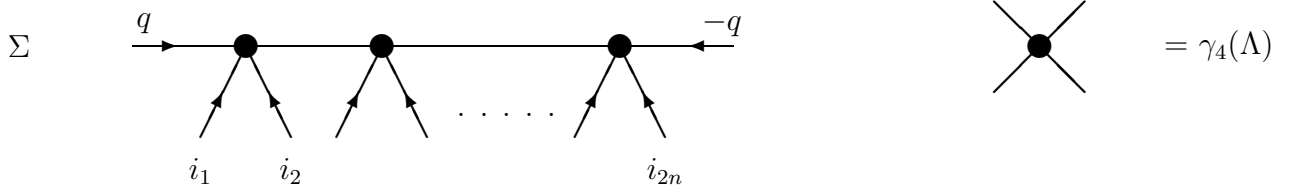

Fig. 4

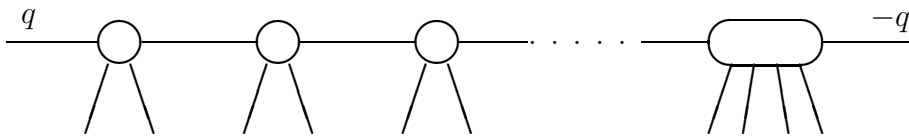

Fig. 5

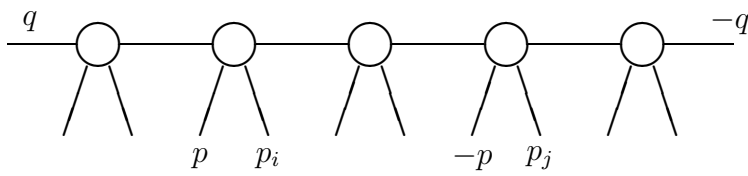

Fig. 6