

Localization and Gluing of Topological Amplitudes

Duiliu-Emanuel Diaconescu[‡] and Bogdan Florea[#]

*Department of Physics and Astronomy, Rutgers University,
Piscataway, NJ 08855-0849, USA*

We develop a gluing algorithm for Gromov-Witten invariants of toric Calabi-Yau threefolds based on localization and gluing graphs. The main building block of this algorithm is a generating function of cubic Hodge integrals of special form. We conjecture a precise relation between this generating function and the topological vertex at fractional framing.

September 2003

[‡] duiliu@physics.rutgers.edu

[#] florea@physics.rutgers.edu

1. Introduction

A gluing algorithm for topological amplitudes on toric Calabi-Yau threefolds has been recently constructed in [2]. This algorithm is based on gluing topological vertices derived from large N duality and Chern-Simons theory. Previous work on the subject can be found in [1,4,5,6,11,12]. In this paper we develop a parallel enumerative algorithm relying on localization and gluing of graphs. The main building block of this construction is a generating functional of cubic Hodge integrals, which is related to the topological vertex of [2].

The paper is structured as follows. Section two is a review of local Gromov-Witten invariants associated to noncompact toric threefolds, localization and graphs. In section three we develop an algorithm for cutting and pasting of graphs from a pure combinatoric point of view. A concrete geometric implementation of this algorithm is presented in section four. The unit block can be formally written as a topological open string partition function for three lagrangian cycles in \mathbb{C}^3 . Applying open string localization [10,13,19], we obtain a generating function for cubic Hodge integrals. Section five is devoted to a detailed comparison of this function with the topological vertex of [2]. We conjecture that the two expressions agree provided that the topological vertex is evaluated at fractional framing. A special case of this conjecture corresponding to a vertex with two trivial representations has been recently proved in [21,22,25]. We present strong numerical evidence for the general case by direct computations, but the proof is an open problem. Some technical details are included in two appendixes.

Acknowledgments. We are very grateful to Antonella Grassi for collaboration at an early stage of this project, especially for invaluable help with the graph combinatorics in section three. We would also like to thank Mina Aganagic, Sheldon Katz, Amir Kashani-Poor, Melissa Liu, Marcos Mariño and Cumrun Vafa for helpful discussions and Carel Faber for kindly sending us the Maple implementation of the algorithm [7]. The work of D.-E.D. has been partially supported by DOE grant DOE-DE-FG02-96ER40959 and by an Alfred P. Sloan foundation fellowship. The work of B.F. has been partially supported by DOE grant DOE-DE-FG02-96ER40959. We would also like to acknowledge the hospitality of KITP Santa Barbara where part of this work has been done.

2. Localization and Graphs

Let X be a smooth projective Calabi-Yau threefold. The Gromov-Witten invariants of X are defined in terms of intersection theory on the moduli space of stable maps $\overline{M}_{g,0}(X, \beta)$ with fixed homology class $\beta \in H_2(X)$. More specifically, the moduli space $\overline{M}_{g,0}(X, \beta)$ has a special structure – perfect obstruction theory – which produces a virtual fundamental cycle of expected dimension $[\overline{M}_{g,0}(X, \beta)]^{vir} \in A_0(\overline{M}_{g,0}(X, \beta))$. One defines the Gromov-Witten potential $F_X(g_s, q)$ as a formal series

$$F_X(g_s, q) = \sum_{g=0}^{\infty} \sum_{\beta \in H_2(X)} C_{g,\beta} q^\beta \quad (2.1)$$

where

$$C_{g,\beta} = \int_{[\overline{M}_{g,0}(X, \beta)]^{vir}} 1. \quad (2.2)$$

Here q^β is a formal multisymbol satisfying $q^{\beta+\beta'} = q^\beta q^{\beta'}$.

2.1. Local Gromov-Witten Invariants

In this paper we are mainly interested in noncompact toric Calabi-Yau threefolds X . The previous definition has to be refined since the moduli space $\overline{M}_{g,0}(X, \beta)$ is in principle ill-defined. Let \overline{X} be a projective completion of X so that the divisor at infinity $D = \overline{X} \setminus X$ is reduced with normal crossings. Then there is a well-defined moduli space $\overline{M}_{g,0}(\overline{X}, D, \beta)$ of relative stable maps to the pair (\overline{X}, D) with multiplicity zero along D . Moreover, this moduli space has a well-defined perfect obstruction theory and a virtual fundamental cycle $[\overline{M}_{g,0}(\overline{X}, D, \beta)]^{vir}$ [17,18]. For a class $\beta \in H_2(X)$, this moduli space may contain closed connected components parameterizing maps supported away from D . We will denote the union of all these components by $\overline{M}_{g,0}(X, \beta)$. The virtual cycle $[\overline{M}_{g,0}(\overline{X}, D, \beta)]^{vir}$ induces a virtual cycle of expected dimension on $\overline{M}_{g,0}(X, \beta)$ by functoriality. Therefore we can define local Gromov-Witten invariants as in the compact case, taking into account the new meaning of $\overline{M}_{g,0}(X, \beta)$. Note that $\overline{M}_{g,0}(X, \beta)$ may be empty, in which case $C_{g,\beta} = 0$.

To clarify this definition, let us consider some examples. First take X to be the total space of the canonical bundle K_S over a toric Fano surface S , and let β be a curve class in the zero section. The completion can be taken to be $\overline{X} \simeq \mathbb{P}(\mathcal{O}_S \oplus \mathcal{O}_S(K_S))$. In this case $\overline{M}_{g,0}(X, \beta) \simeq \overline{M}_{g,0}(S, \beta)$, and we could have adopted this as a definition of the moduli space. However, there are more general cases when such a direct approach is not possible. Consider for example the threefold defined by the toric diagram below.

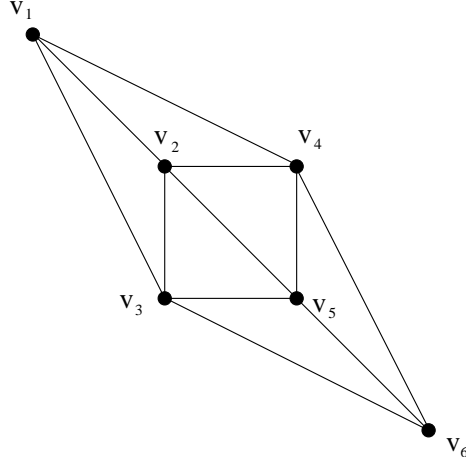

Fig. 1: A section in the toric fan of a local Calabi-Yau threefold X .

There are two compact divisors on X , S_1, S_2 , both isomorphic to the Hirzebruch surface \mathbb{F}_1 , which intersect along a $(-1, -1)$ curve. Any curve C lying on $S_1 \cup S_2$ cannot be deformed in the normal directions, since both S_1, S_2 are Fano. Therefore any map $f : \Sigma \rightarrow X$ with $f_*[\Sigma] = [C]$ is supported away from the divisor at infinity. One could try to define local invariants in terms of maps to the singular divisor $S_1 \cup S_2$, but this approach would be quite involved. It is more convenient to use the construction explained in the previous paragraph, in which case the target space X is smooth.

2.2. Localization

Since X is toric, it admits a torus action $T \times X \rightarrow X$ which induces an action on the moduli space $\overline{M}_{g,0}(X, \beta)$. Then the local Gromov-Witten invariants can be computed by localization [9]. To recall the essential aspects, the virtual cycle $[\overline{M}_{g,0}(X, \beta)]^{vir}$ induces a virtual cycle $[\Xi]^{vir}$ on each component Ξ of the fixed locus. Moreover, one can construct a virtual normal bundle N_{Ξ}^{vir} to each fixed locus. The localization formula reads

$$C_{g,\beta} = \sum_{\Xi \subset \overline{M}_{g,0}(X,\beta)} \int_{[\Xi]^{vir}} \frac{1}{e_T(N_{\Xi}^{vir})} \quad (2.3)$$

where e_T denotes the equivariant Euler class.

The fixed loci in the moduli space of stable maps can be indexed by graphs according to [14]. Since this construction will play an important role in the paper, let us recall the basic elements. Let $\{P_r\}$, $r = 1, \dots, N$ denote the fixed points of the torus action on X . Any two fixed points are joined by a T -invariant rational curve C_{rs} . The configuration of

invariant curves forms a graph Γ whose vertices are in 1 – 1 correspondence with the fixed points P_r and edges in 1 – 1 correspondence with curves C_{rs} . Note that at most three edges can meet at any vertex. Some examples are represented below.

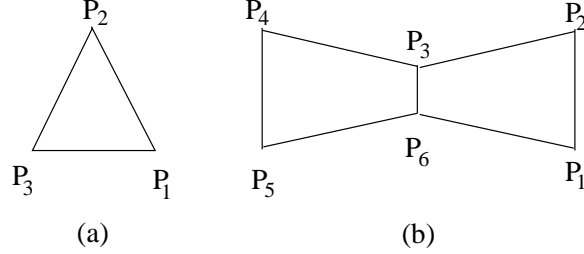

Fig. 2: The graph Γ for a) $\mathcal{O}(-3) \rightarrow \mathbb{P}^2$ and b) the toric Calabi-Yau threefold represented in fig. 1.

The fixed maps $f : \Sigma \rightarrow X$ have a special structure. The image of f is contained in the configuration of invariant curves $\cup_{r,s} C_{rs}$. $f^{-1}(C_{rs})$ consists of finitely many irreducible components of Σ which are smooth rational curves. The restriction of f to such a component must be a Galois cover. $f^{-1}(P_s)$ consists of finitely many prestable curves on Σ possibly of higher genus. Note that higher genus components mapping onto some C_{rs} are not allowed; all higher genus components must be collapsed to fixed points.

To any irreducible component Ξ of the fixed locus we can associate a connected graph Υ as follows. Let $f : \Sigma \rightarrow X$ denote a map in Ξ .

i) The vertices $v \in V(\Upsilon)$ represent prestable curves $\Sigma_v \subset \Sigma$ mapping to some fixed point P_i . Each vertex is marked by two numbers (k_v, g_v) , where $k_v \in \{1, 2, \dots, N\}$ is defined by $f(\Sigma_v) = P_{k_v}$, and g_v is the arithmetic genus of Σ_v . Note that Σ_v may be a point.

ii) The edges $e \in E(\Upsilon)$ correspond to irreducible rational components of Σ mapped onto C_{rs} for some (r, s) . Each edge is marked by an integer d_e representing the degree of the Galois cover $f|_{\Sigma_e} : \Sigma_e \rightarrow C_{rs}$.

Let us define a flag [14] to be a pair $(v, e) \in V(\Upsilon) \times E(\Upsilon)$ so that $v \in e$. For a given $v \in V(\Upsilon)$ we define the valence of v , $val(v)$ to be the number of flags (v, e) . We will also denote by $F(\Upsilon)$ the set of flags of Υ and by $F_v(\Upsilon)$ the set flags with given vertex v . Geometrically, $val(v)$ counts the number of rational components Σ_e which intersect a given prestable curve Σ_v . Each flag determines a marked point $p_{(v,e)} \in \Sigma_v$, so that $(\Sigma_v, p_{(v,e)})$ is a prestable curve of genus g_v with $val(v)$ marked points.

According to [14], the set of all fixed loci Ξ is in one to one correspondence with (equivalence classes of) graphs Υ subject to the following conditions

- 1) If $e \in E(\Upsilon)$ is an edge connecting two vertices u, v , then $k_u \neq k_v$.
- 2) $1 - \chi(\Upsilon) + \sum_{v \in V(\Upsilon)} g_v = g$, where g_v is the arithmetic genus of the component Σ_v , and $\chi(\Upsilon)$ is the Euler characteristic of Υ , $\chi(\Upsilon) = |V(\Upsilon)| - |E(\Upsilon)|$.
- 3) $\sum_{e \in E(\Upsilon)} d_e f_*[\Sigma_e] = \beta$.
- 4) For all $v \in V(\Upsilon)$, $(\Sigma_v, p_{(v,e)})$ is a stable marked curve.

Note that the last condition gives rise to some special cases, namely $(g_v, \text{val}(v)) = (0, 1), (0, 2)$. If $(g_v, \text{val}(v)) = (0, 1)$, $\Sigma_v = p_v$ is a smooth point of Σ . If $(g_v, \text{val}(v)) = (0, 2)$, $\Sigma_v = p_v$ is a node of Σ lying at the intersection of two components $\Sigma_{e_1(v)}, \Sigma_{e_2(v)}$.

Next, let us outline the computation of the local contribution $\int_{[\Xi]^{vir}} \frac{1}{e_T(N_{\Xi}^{vir})}$ for a fixed component Ξ with associated graph Υ . Given the structure of an arbitrary fixed map, the fixed locus Ξ is isomorphic to a quotient of $\prod_{v \in V(\Upsilon)} \overline{M}_{g_v, \text{val}(v)}$ by a finite group $G(\Upsilon)$. The finite group admits a presentation

$$1 \longrightarrow \prod_{e \in E(\Upsilon)} \mathbb{Z}/d_e \longrightarrow G(\Upsilon) \longrightarrow \text{Aut}(\Upsilon) \longrightarrow 1 \quad (2.4)$$

where $\text{Aut}(\Upsilon)$ is the automorphism group of the graph.

The main tool is the tangent obstruction complex of a map $f : \Sigma \rightarrow X$, which encodes the local structure of the moduli space near the point (Σ, f) . We have

$$0 \longrightarrow \text{Aut}(\Sigma) \longrightarrow H^0(\Sigma, f^*T_X) \longrightarrow \mathbb{T}^1 \longrightarrow \text{Def}(\Sigma) \longrightarrow H^1(\Sigma, f^*T_X) \longrightarrow \mathbb{T}^2 \longrightarrow 0 \quad (2.5)$$

where $\mathbb{T}^1, \mathbb{T}^2$ are the infinitesimal deformation and respectively obstruction space of a map (Σ, f) . $\text{Aut}(\Sigma), \text{Def}(\Sigma)$ denote the infinitesimal automorphism and respectively deformation groups of the domain Σ . Note that if (f, Σ) represents a point in Ξ , there is an induced T -action on the complex (2.5).

According to [9], the fixed part of (2.5) under the torus action determines the virtual cycle $[\Xi]^{vir}$ while the moving part determines the normal bundle N_{Ξ}^{vir} . Moreover the induced virtual class coincides with the ordinary fundamental class of Ξ regarded as an orbispace. The integrand $\frac{1}{e_T(N_{\Xi}^{vir})}$ can be computed in terms of the graph Υ using the normalization exact sequence

$$0 \longrightarrow f^*T_X \longrightarrow \bigoplus_{e \in E(\Upsilon)} f_e^*T_X \oplus \bigoplus_{v \in V(\Upsilon)} f_v^*T_X \longrightarrow \bigoplus_{v \in V(\Upsilon)} (T_{P_{k_v}}X)^{\text{val}(v)} \longrightarrow 0. \quad (2.6)$$

Note that the terms of this sequence form sheaves over the fixed locus Ξ which may not be in general locally free. For localization computations we only need the equivariant K-theory classes of these sheaves which will be denoted by $[\]$.

The associated long exact sequence of (2.6) reads

$$\begin{aligned}
0 \longrightarrow H^0(\Sigma, f^*T_X) &\longrightarrow \bigoplus_{e \in E(\Gamma)} H^0(\Sigma_e, f_e^*T_X) \oplus \bigoplus_{v \in V(\Gamma)} T_{P_{k_v}}X \longrightarrow \bigoplus_{v \in V(\Gamma)} (T_{P_{k_v}}X)^{\text{val}(v)} \\
&\longrightarrow H^1(\Sigma, f^*T_X) \longrightarrow \bigoplus_{e \in E(\Gamma)} H^1(\Sigma_e, f_e^*T_X) \oplus \bigoplus_{v \in V(\Gamma)} H^1(\Sigma_v, \mathcal{O}_{\Sigma_v}) \otimes T_{P_{k_v}}X \longrightarrow 0.
\end{aligned} \tag{2.7}$$

This yields

$$\begin{aligned}
[N_{\Xi}^{\text{vir}}] &= \sum_{e \in E(\Upsilon)} ([H^0(\Sigma_e, f_e^*T_X)^m] - [H^1(\Sigma_e, f_e^*T_X)^m]) \\
&\quad - \sum_{v \in V(\Upsilon)} ([H^1(\Sigma_v, \mathcal{O}_{\Sigma_v}) \otimes T_{P_{k_v}}X] + (\text{val}(v) - 1)[T_{P_{k_v}}X]) \\
&\quad + [\text{Def}(\Sigma)^m] - [\text{Aut}(\Sigma)^m].
\end{aligned} \tag{2.8}$$

The moving part of the automorphism group consists of holomorphic vector fields on the horizontal components Σ_e which vanish at the nodes of Σ lying on Σ_e . We can write

$$[\text{Aut}(\Sigma)^m] = \sum_{e \in E(\Upsilon)} [H^0(\Sigma_e, T_{\Sigma_e})^m] - \sum_{(v,e) \in F(\Upsilon), \text{val}(v) \geq 2} [T_{p_{(v,e)}}\Sigma_e]. \tag{2.9}$$

The moving infinitesimal deformations of Σ are deformations of the nodes lying at least on one edge component

$$\begin{aligned}
[\text{Def}(\Sigma)^m] &= \sum_{(v,e) \in F(\Upsilon), (g_v, \text{val}(v)) \neq (0,1), (0,2)} [T_{p_{(v,e)}}\Sigma_e \otimes T_{p_{(v,e)}}\Sigma_v] \\
&\quad + \sum_{(v,e) \in F(\Upsilon), (g_v, \text{val}(v)) = (0,2)} [T_{p_v}\Sigma_{e_1(v)} \otimes T_{p_v}\Sigma_{e_2(v)}].
\end{aligned} \tag{2.10}$$

Collecting the facts, it follows that the local contribution of the fixed locus Ξ can be written as

$$\begin{aligned}
\int_{[\Xi]^{\text{vir}}} \frac{1}{e_T(N_{\Xi}^{\text{vir}})} &= \frac{1}{|\text{Aut}(\Upsilon)| \prod_{e \in E(\Upsilon)} d_e} \prod_{e \in E(\Upsilon)} F(e) \prod_{v \in V(\Upsilon), (g_v, \text{val}(v)) = (0,2)} G(v) \\
&\quad \times \prod_{v \in V(\Upsilon), (g_v, \text{val}(v)) \neq (0,1), (0,2)} \int_{(\overline{M}_{g_v, \text{val}(v)})_T} H(v)
\end{aligned} \tag{2.11}$$

where

$$\begin{aligned}
F(e) &= \frac{e_T(H^1(\Sigma_e, f_e^* T_X)^m) e_T(H^0(\Sigma_e, T_{\Sigma_e})^m)}{e_T(H^0(\Sigma_e, f_e^* T_X)^m)} \\
G(v) &= \frac{e_T(T_{P_{k_v}} X)}{e_T(T_{p_v} \Sigma_{e_1(v)}) e_T(T_{p_v} \Sigma_{e_2(v)}) (e_T(T_{p_v} \Sigma_{e_1(v)}) + e_T(T_{p_v} \Sigma_{e_2(v)}))} \\
H(v) &= \frac{e_T(H^1(\Sigma_v, \mathcal{O}_{\Sigma_v}) \otimes T_{P_{k_v}} X)}{\prod_{(v,e) \in F_v(\Upsilon)} [e_T(T_{p(v,e)} \Sigma_e) (e_T(T_{p(v,e)} \Sigma_e) + e_T(T_{p(v,e)} \Sigma_v))] } \\
&= \frac{e_T(\mathbb{E}_v^\vee \otimes T_{P_{k_v}} X)}{\prod_{(v,e) \in F_v(\Upsilon)} [e_T(T_{p(v,e)} \Sigma_e) (e_T(T_{p(v,e)} \Sigma_e) - \psi_{p(v,e)})]}.
\end{aligned} \tag{2.12}$$

In the last equation \mathbb{E}_v is the Hodge bundle on the Deligne-Mumford moduli space $\overline{M}_{g_v, \text{val}(v)}$ and $\psi_{p(v,e)}$ are Mumford classes associated to the marked points $\{p(v,e)\}$.

To conclude this section, note that the Gromov-Witten potential (2.1) can be written as a sum over marked graphs Υ satisfying condition (1) above equation (2.4). For each such graph we define the genus $g(\Upsilon) = 2 - \chi(\Upsilon) + \sum_{v \in V(\Upsilon)} g_v$ and the homology class $\beta(\Upsilon) = \sum_{e \in \Upsilon} d_e f_{e^*} [\Sigma_e]$. Then we have

$$F_X(g_s, q) = \sum_{\Upsilon} \frac{1}{|\text{Aut}(\Upsilon)| \prod_{e \in E(\Upsilon)} d_e} C(\Upsilon) g_s^{2g(\Upsilon) - 2} q^{\beta(\Upsilon)}. \tag{2.13}$$

Note that $F_X(g_s, q)$ depends only on the marked graph Γ , hence we can alternatively denote it by $F_\Gamma(g_s, q)$.

We can further reformulate (2.13) by noting that the data $k_v, v \in V(\Upsilon)$ is equivalent to a map of graphs $\phi : \Upsilon \rightarrow \Gamma$. Therefore a marked graph Υ can be alternatively thought as a pair $(\tilde{\Upsilon}, \phi)$ where $(\tilde{\Upsilon})$ obtained from Υ by deleting the markings k_v , and $\phi : \tilde{\Upsilon} \rightarrow \Gamma$ is a map of graphs. Condition (1) above (2.4) is replaced by

$$(1') \phi(u) \neq \phi(v) \text{ for any two distinct vertices } u, v \in V(\tilde{\Upsilon}).$$

In the following we will use the notation (Υ, ϕ) for such a pair.

3. Gluing Algorithm – Combinatorics

Our goal is to find a gluing formula for the Gromov-Witten invariants of X based on a decomposition of the graph Γ into smaller units. The main idea is to construct suitable generating functional for each such unit so that the full Gromov-Witten potential can be obtained by gluing these local data. In this section we will discuss purely combinatoric aspects of this algorithm. A geometric realization will be presented in the next section.

To review our setup, we are given a graph Γ satisfying the following conditions

- i)* There are no edges starting and ending at the same vertex.
- ii)* Any two distinct vertices are joined by at most one edge.
- iii)* At most three edges can meet at any given vertex.

We will denote the vertices of Γ by $P \in V(\Gamma)$ and the edges by $C \in E(\Gamma)$. To any such graph we attach a formal series of the form

$$F_\Gamma(g_s, q) = \sum_{(\Upsilon, \phi)} \frac{1}{|\text{Aut}(\Upsilon, \phi)| \prod_{e \in E(\Upsilon)} d_e} C(\Upsilon, \phi) g_s^{2g(\Upsilon)-2} q^{\beta(\Upsilon, \phi)} \quad (3.1)$$

with coefficients $C(\Upsilon, \phi) \in \mathcal{K}_T$ where we sum over (equivalence classes of) pairs (Υ, ϕ) as above satisfying (1'). Here we define $\beta(\Upsilon, \phi)$ to be a formal linear combination of edges of Γ , $\beta(\Upsilon, \phi) = \sum_{e \in E(\Upsilon)} d_e \phi(e)$. $q = (q_1, \dots, q_{|E(\Gamma)|})$ is a multisymbol associated to the edges of Γ , and $q^{\beta(\Upsilon, \phi)} = \prod_{e \in E(\Upsilon)} q_{\phi(e)}^{d_e}$.

We decompose Γ into subgraphs, by specifying a collection of points Q_α , $\alpha = 1, \dots, M$ lying on distinct edges $C_1 \dots, C_M$ of Γ . No two points should lie on the same edge. Suppose we choose these points so that Γ is divided into several disconnected components Γ_I . The resulting graphs have more structure than the original graph Γ . A typical graph Γ_I has two types of vertices: old vertices inherited from Γ , and new univalent vertices resulting from the decomposition. We will also refer to old and new vertices as inner $V_i(\Gamma)$ and respectively outer $V_o(\Gamma)$ vertices. The edges of Γ_I can also be classified in inner edges $E_i(\Gamma)$ – which do not contain outer vertices – and outer edges $E_o(\Gamma)$ – which contain an outer vertex. Note that there is a unique outer edge C_Q passing through each outer vertex Q . These graphs will be referred to as relative graphs.

The decomposition of Γ induces a similar decomposition of pairs (Υ, ϕ) . The points in the inverse image $\phi^{-1}(\{Q_\alpha\})$ divide Υ into disconnected graphs Υ_I which map to Γ_I for each I . As before, a typical graph Υ_I has more structure than the original graph Υ . The decomposition gives rise to a collection of new univalent vertices in addition to the ordinary vertices inherited from Υ . Moreover, the edges and ordinary vertices of Υ_I inherit marking data from Υ . The new vertices are unmarked. The new univalent vertices will be called outer vertices. The ordinary vertices will be referred to as inner vertices. An edge containing an outer vertex will be called outer edge. We denote by $V_{i,o}(\Upsilon_I)$, $E_{i,o}(\Upsilon_I)$ the set of inner/outer vertices and respectively edges. We also obtain a map of graphs $\phi_I : \Upsilon_I \rightarrow \Gamma_I$ which maps the distinguished vertices of Υ_I to univalent vertices of Γ_I . To

introduce some more terminology, we call the graphs Υ closed graphs while Υ_I will be called truncated graphs.

Now, it is clear that all disconnected truncated graphs can be obtained by cutting closed graphs, and conversely, any closed graph can be obtained by gluing truncated graphs. We would like to use this idea in order to reconstruct the formal series (3.1) from data associated to the graphs Γ_I . For each Γ_I we need construct a formal series with coefficients in \mathcal{K}_T by summing over equivalence classes of pairs (Υ_I, ϕ_I) . In order to write down such an expression we need to introduce some more notation. Given a pair (Υ_I, ϕ_I) we define the genus

$$g(\Upsilon_I) = 1 - |V_i(\Upsilon_I)| + |E_i(\Upsilon_I)| + \sum_{v \in V_i(\Upsilon_I)} g_v. \quad (3.2)$$

and we denote by $h(\Upsilon_I) = |V_o(\Upsilon_I)|$ the number of outer vertices. For each univalent vertex of Γ_I , $Q \in V_o(\Gamma_I)$ we define a degree vector $\mathbf{k}_Q^I(\Upsilon_I, \phi_I) = (k_{Q,1}^I, k_{Q,2}^I, \dots)$ so that $k_{Q,m}^I$ is the number of outer edges of Υ_I projecting onto the outer ray C_Q with degree m . $\mathbf{k}_Q^I(\Upsilon_I, \phi_I)$ is an infinite vector with finitely many nonzero entries. Next, we have to introduce some formal variables keeping track of all this data. Let $q_I = (q_1^I, \dots, q_{|E_i(\Gamma_I)|}^I)$ and $\tilde{q}_I = (\tilde{q}_1^I, \dots, \tilde{q}_{|E_o(\Gamma_I)|}^I)$ associated to the inner and respectively outer edges of Γ . We define

$$\beta(\Upsilon_I, \phi_I) = \sum_{e \in E_i(\Upsilon_I)} d_e^I \phi_I(e), \quad \tilde{\beta}(\Upsilon_I, \phi_I) = \sum_{e \in E_o(\Upsilon_I)} d_e^J \phi_I(e) \quad (3.3)$$

and

$$q_I^{\beta(\Upsilon_I, \phi_I)} = \prod_{e \in E_i(\Upsilon_I)} (q_{\phi_I(e)}^I)^{d_e^I}, \quad \tilde{q}_I^{\tilde{\beta}(\Upsilon_I, \phi_I)} = \prod_{e \in E_o(\Upsilon_I)} (\tilde{q}_{\phi_I(e)}^I)^{d_e^I}. \quad (3.4)$$

We also introduce formal variables $y_I = (y_{Q,m}^I)_{m=1, \dots, \infty, Q \in V_o(\Gamma_I)}$ and set

$$y_I^{\mathbf{k}^I(\Upsilon_I, \phi_I)} = \prod_{Q \in V_i(\Gamma_I)} \prod_{m=1}^{\infty} (y_{Q,m}^I)^{k_{Q,m}^I}. \quad (3.5)$$

Then the formal series associated to Γ_I takes the form

$$\begin{aligned} & Z_{\Gamma_I}(g_s, q_I, \tilde{q}_I, y_I) \\ &= \sum_{(\Upsilon_I, \phi_I)} \frac{C(\Upsilon_I, \phi_I)}{|\text{Aut}(\Upsilon_I, \phi_I)| \prod_{e \in E(\Upsilon_I)} d_e^I} g_s^{2g(\Upsilon_I) - 2 + h(\Upsilon_I)} q_I^{\beta(\Upsilon_I, \phi_I)} \tilde{q}_I^{\tilde{\beta}(\Upsilon_I, \phi_I)} y_I^{\mathbf{k}^I(\Upsilon_I, \phi_I)} \end{aligned} \quad (3.6)$$

where the coefficients $C(\Upsilon_I, \phi_I) \in \mathcal{K}_T$. Note that here we sum over all disconnected marked graphs Υ_I , as opposed to (3.1) where we sum over connected graphs.

Now suppose we are given two relative graphs Γ_I, Γ_J . Choose a subset of outer vertices of Γ_I , $S_I \subset V_o(\Gamma_I)$, and a subset $S_J \subset V_o(\Gamma_J)$ so that $S_I \simeq S_J$. We glue Γ_I and Γ_J by choosing a bijection $\psi : S_I \rightarrow S_J$, obtaining a relative graph Γ_{IJ} with outer vertices $V_o(\Gamma_{IJ}) = (V_o(\Gamma_I) \setminus S_I) \cup (V_o(\Gamma_J) \setminus S_J)$ and outer edges $E_o(\Gamma_{IJ}) = (E_o(\Gamma_I) \setminus E_I) \cup (E_o(\Gamma_J) \setminus E_J)$ (S_I, S_J can be equally well regarded as subsets of $E_o(\Gamma_I), E_o(\Gamma_J)$.) The inner vertices of Γ_{IJ} are the union $V_i(\Gamma_{IJ}) = V_i(\Gamma_I) \cup V_i(\Gamma_J)$. The inner edges of Γ_{IJ} are given by $E_i(\Gamma_{IJ}) = E_i(\Gamma_I) \cup E_i(\Gamma_J) \cup S$, where S denotes the set of inner edges of Γ_{IJ} obtained by gluing outer edges of Γ_I, Γ_J ; $S \simeq S_I \simeq S_J$. To Γ_{IJ} we associate a series

$$\begin{aligned} & Z_{\Gamma_{IJ}}(g_s, q_{IJ}, \tilde{q}_{IJ}, y_{IJ}) \\ &= \sum_{(\Upsilon_{IJ}, \phi_{IJ})} \frac{C(\Upsilon_{IJ}, \phi_{IJ})}{|\text{Aut}(\Upsilon_{IJ}, \phi_{IJ})| \prod_{e \in E(\Upsilon_{IJ})} d_e^{IJ}} g_s^{2g(\Upsilon_{IJ}) - 2 + h(\Upsilon_{IJ})} q_{IJ}^{\beta(\Upsilon_{IJ}, \phi_{IJ})} \tilde{q}_{IJ}^{\tilde{w}(\Upsilon_{IJ}, \phi_{IJ})} y_{IJ}^{\mathbf{k}^{IJ}(\Upsilon_{IJ}, \phi_{IJ})} \end{aligned} \quad (3.7)$$

defined as above. The formal variables $q_{IJ}, \tilde{q}_{IJ}, y_{IJ}$ are defined in terms of q_I, \tilde{q}_I, y_I and q_J, \tilde{q}_J, y_J as follows

$$q_e^{IJ} = \begin{cases} q_e^I, & \text{if } e \in E_i(\Gamma_I) \\ q_e^J, & \text{if } e \in E_i(\Gamma_J) \\ \tilde{q}_e^I \tilde{q}_e^J, & \text{if } e \in S \end{cases} \quad \tilde{q}_e^{IJ} = \begin{cases} \tilde{q}_e^I, & \text{if } e \in E_o(\Gamma_I) \setminus S_I \\ \tilde{q}_e^J, & \text{if } e \in E_o(\Gamma_J) \setminus S_J \end{cases} \quad y_Q^{IJ} = \begin{cases} y_Q^I, & \text{if } Q \in V_o(\Gamma_I) \setminus S_I \\ y_Q^J, & \text{if } Q \in V_o(\Gamma_J) \setminus S_J \end{cases}. \quad (3.8)$$

We would like to represent (3.7) as a pairing of the form

$$Z_{\Gamma_{IJ}}(g_s, q_{IJ}, \tilde{q}_{IJ}, y_{IJ}) = \langle Z_{\Gamma_I}(g_s, q_I, \tilde{q}_I, y_I), Z_{\Gamma_J}(g_s, q_J, \tilde{q}_J, y_J) \rangle. \quad (3.9)$$

based on gluing of pairs $(\Upsilon_I, \phi_I), (\Upsilon_J, \phi_J)$. Suppose $(Q, \psi(Q)) \in S_I \times S_J$ are two outer vertices of Γ_I, Γ_J identified in the gluing process. We denote by $C_Q^I, C_{\psi(Q)}^J$ the corresponding outer edges of Γ_I, Γ_J . A pair of truncated graphs $(\Upsilon_I, \phi_I), (\Upsilon_J, \phi_J)$ can be glued if and only if the degrees of all outer edges of Υ_I projecting onto C_Q^I match the degrees of all outer edges of Υ_J projecting onto $C_{\psi(Q)}^J$. Therefore two pairs (Υ_I, ϕ_I) and (Υ_J, ϕ_J) can be glued to form a pair $(\Upsilon_{IJ}, \phi_{IJ})$ if and only if

$$\mathbf{k}_Q^I = \mathbf{k}_{\psi(Q)}^J \quad \forall Q \in S_I. \quad (3.10)$$

Note that if this conditions is satisfied, one can identify any outer edge of Υ_I projecting to C_Q^I to an outer edge of Υ_J projecting to $C_{\psi(Q)}^J$ as long as the degrees are equal. This gives rise to (finitely) many different gluing combinations which may result in principle in different graphs Υ_{IJ} . In fact, is not hard to work out the degeneracy of each pair $(\Upsilon_{IJ}, \phi_{IJ})$ obtained by gluing a fixed pair $(\Upsilon_I, \phi_I), (\Upsilon_J, \phi_J)$. By construction, we have a canonical embedding of groups

$$\text{Aut}(\Upsilon_{IJ}, \phi_{IJ}) \hookrightarrow \text{Aut}(\Upsilon_I, \phi_I) \times \text{Aut}(\Upsilon_J, \phi_J). \quad (3.11)$$

Given a particular gluing of the pairs $(\Upsilon_I, \phi_I), (\Upsilon_J, \phi_J)$ one can obtain another gluing compatible with $(\Upsilon_{IJ}, \phi_{IJ})$ by separately acting with elements of $\text{Aut}(\Upsilon_I, \phi_I), \text{Aut}(\Upsilon_J, \phi_J)$ on each pair. Apparently this gives rise to $|\text{Aut}(\Upsilon_I, \phi_I)| |\text{Aut}(\Upsilon_J, \phi_J)|$ gluing patterns resulting in the same pair $(\Upsilon_{IJ}, \phi_{IJ})$. However, two of these patterns are equivalent if they are related by an element of $\text{Aut}(\Upsilon_{IJ}, \phi_{IJ})$ which acts simultaneously on the pairs $(\Upsilon_I, \phi_I), (\Upsilon_J, \phi_J)$ through the embedding (3.11). Therefore the degeneracy of $(\Upsilon_{IJ}, \phi_{IJ})$ is

$$\frac{|\text{Aut}(\Upsilon_I, \phi_I)| |\text{Aut}(\Upsilon_J, \phi_J)|}{|\text{Aut}(\Upsilon_{IJ}, \phi_{IJ})|} \quad (3.12)$$

Moreover, since the number of all possible gluing patterns of two fixed pairs $(\Upsilon_I, \phi_I), (\Upsilon_J, \phi_J)$ is $\prod_{Q \in S_I} \prod_{m=1}^{\infty} (k_{Q,m}^I)!$ we have the following formula

$$\prod_{Q \in S_I} \prod_{m=1}^{\infty} (k_{Q,m}^I)! = \sum_{(\Upsilon_{IJ}, \phi_{IJ})} \frac{|\text{Aut}(\Upsilon_I, \phi_I)| |\text{Aut}(\Upsilon_J, \phi_J)|}{|\text{Aut}(\Upsilon_{IJ}, \phi_{IJ})|} \quad (3.13)$$

where the sum is over all pairs $(\Upsilon_{IJ}, \phi_{IJ})$ obtained by gluing $(\Upsilon_I, \phi_I), (\Upsilon_J, \phi_J)$. Since this argument is perhaps too abstract, some concrete examples may be clarifying at this point. It suffices to consider a very simple situation in which Γ is a graph with two vertices, which is the case for example if X is the total space of $\mathcal{O}(-1) \oplus \mathcal{O}(-1) \rightarrow \mathbb{P}^1$. We divide Γ into two relative graphs by cutting the edge joining the two vertices as shown below.

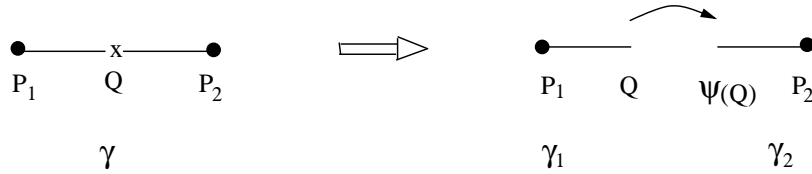

Fig. 3: Decomposition of the graph Γ associated to $\mathcal{O}(-1) \oplus \mathcal{O}(-1) \rightarrow \mathbb{P}^1$.

We consider two examples of gluing graphs represented in fig. 4 and fig. 5 below. In both cases, we draw the pair $(\Upsilon_I, \phi_I), (\Upsilon_J, \phi_J)$ on the top row and all possible gluing patterns resulting in graphs $(\Upsilon_{IJ}, \phi_{IJ})$ on the second row.

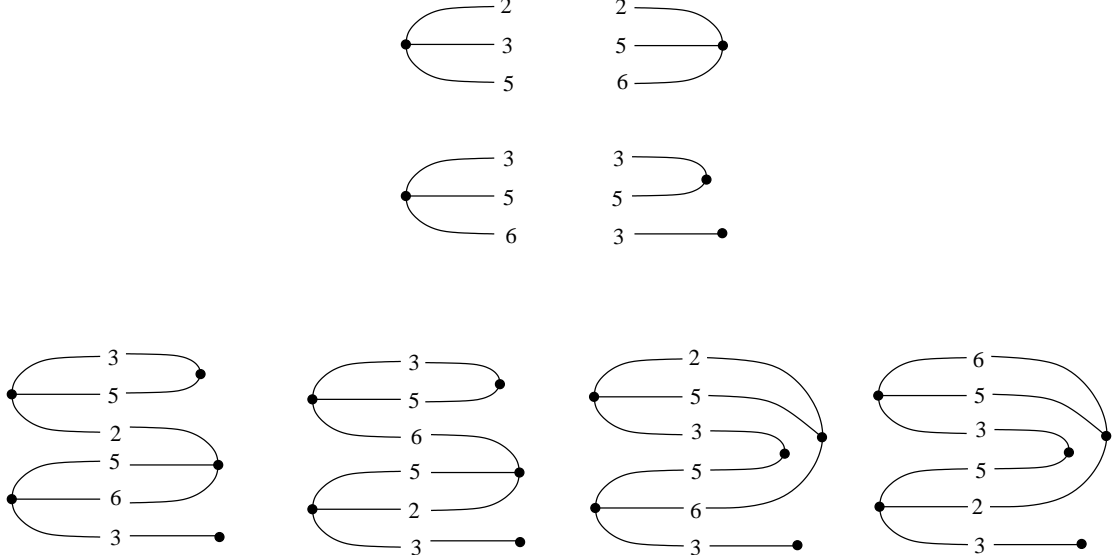

Fig. 4: First gluing example.

In fig. 4 we have $\mathbf{k}_Q^1(\Upsilon_1, \phi_1) = (0, 1, 2, 0, 2, 1, 0, 0, \dots)$, hence $\prod_{m=1}^{\infty} (k_{Q,m}^1)! = 2! \times 2! = 4$. $\text{Aut}(\Upsilon_1, \phi_1) = \{1\}$, $\text{Aut}(\Upsilon_2, \phi_2) = \{1\}$. There are four distinct gluing patterns, each resulting in a connected closed string graph with trivial automorphism group. Therefore formula (3.13) holds. For the pair in fig. 5 we have $k_{Q,m}^1 = (0, 0, 2, 0, 0, 0, 3, 0, \dots)$, hence $\prod_{m=1}^{\infty} (k_{Q,m}^1)! = 2! \times 3! = 12$. $\text{Aut}(\Upsilon_1, \phi_1) \simeq \text{Aut}(\Upsilon_2, \phi_2) \simeq \mathcal{S}_2 \times \mathcal{S}_2$. There are two distinct gluing patterns resulting in disconnected graphs with automorphism groups \mathcal{S}_2 and respectively $\mathcal{S}_2 \times \mathcal{S}_2$. Again the formula (3.13) holds. If the condition (3.10) is satisfied, one can easily show that

$$\begin{aligned}
2g(\Upsilon_{IJ}) - 2 + h(\Upsilon_{IJ}) &= 2g(\Upsilon_I) - 2 + h(\Upsilon_I) + 2g(\Upsilon_J) - 2 + h(\Upsilon_J) \\
\beta_{IJ}(\Upsilon_{IJ}, \phi_{IJ}) &= \beta_I(\Upsilon_I, \phi_I) + \beta_J(\Upsilon_J, \phi_J) + \sum_{e \in S} d_e \phi_{IJ}(e) \\
\tilde{\beta}_{IJ}(\Upsilon_{IJ}, \phi_{IJ}) &= \tilde{\beta}_I(\Upsilon_I, \phi_I) + \tilde{\beta}_J(\Upsilon_J, \phi_J) - \sum_{e \in S_I} d_e \phi_I(e) - \sum_{e \in S_J} d_e \phi_J(e) \\
\mathbf{k}_Q^{IJ}(\Upsilon_{IJ}, \phi_{IJ}) &= \begin{cases} \mathbf{k}_Q^I(\Upsilon_I, \phi_I), & \text{if } Q \in V_o(\Gamma_I) \setminus S_I \\ \mathbf{k}_Q^J(\Upsilon_J, \phi_J), & \text{if } Q \in V_o(\Gamma_J) \setminus S_J. \end{cases}
\end{aligned} \tag{3.14}$$

Using (3.8) and (3.9) we find that the relation (3.14) imply

$$\begin{aligned}
g_s^{2g(\Upsilon_{IJ})-2+h(\Upsilon_{IJ})} &= g_s^{2g(\Upsilon_I)-2+h(\Upsilon_I)} g_s^{2g(\Upsilon_J)-2+h(\Upsilon_J)} \\
q_{IJ}^{\beta(\Upsilon_{IJ}, \phi_{IJ})} \tilde{q}_{IJ}^{\tilde{\beta}(\Upsilon_{IJ}, \phi_{IJ})} &= q_I^{\beta(\Upsilon_I, \phi_I)} \tilde{q}_I^{\tilde{\beta}(\Upsilon_I, \phi_I)} q_J^{\beta(\Upsilon_J, \phi_J)} \tilde{q}_J^{\tilde{\beta}(\Upsilon_J, \phi_J)}
\end{aligned} \tag{3.15}$$

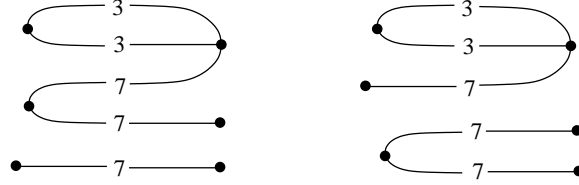
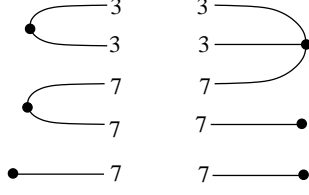

Fig. 5: Second gluing example.

We define a formal pairing on y -variables by

$$\begin{aligned}
\langle y_I^{\mathbf{k}^I(\Upsilon_I, \phi_I)}, y_J^{\mathbf{k}^J(\Upsilon_J, \phi_J)} \rangle &= N(\mathbf{k}_{S_I}^I(\Upsilon_I, \phi_I)) \prod_{Q \in V_o(\Gamma_I) \setminus S_I} \prod_{m=1}^{\infty} (y_{Q,m}^I)^{k_{Q,m}^I} \prod_{Q \in V_o(\Gamma_J) \setminus S_J} \\
&\quad \times \prod_{m=1}^{\infty} (y_{Q,m}^J)^{k_{Q,m}^J} \prod_{Q \in S_I} \left(\prod_{m=1}^{\infty} m^{k_{Q,m}^I} (k_{Q,m}^I)! \right) \delta(k_{Q,m}^I, k_{\psi(Q),m}^J) \\
&= N(\mathbf{k}_{S_I}^I(\Upsilon_I, \phi_I)) y_{IJ}^{\mathbf{k}_{IJ}(\Upsilon_{IJ}, \phi_{IJ})} \prod_{Q \in S_I} \left(\prod_{m=1}^{\infty} m^{k_{Q,m}^I} (k_{Q,m}^I)! \right) \delta(\mathbf{k}_Q^I(\Upsilon_I, \phi_I), \mathbf{k}_{\psi(Q)}^J(\Upsilon_J, \phi_J)).
\end{aligned} \tag{3.16}$$

where $N(\mathbf{k}_{S_I}^I(\Upsilon_I, \phi_I))$ is a phase factor depending only on the winding vectors of the outer edges which take part in the gluing process $\mathbf{k}_{S_I}^I(\Upsilon_I, \phi_I) = (\mathbf{k}_Q^I(\Upsilon_I, \phi_i))_{Q \in S_I}$. The pairing is linear with respect to the other variables. The phase factor does not have a combinatoric explanation. It has to be included for geometric reasons explained in the next section. Using (3.15) and (3.16) we can compute the right hand side of (3.9)

$$\begin{aligned}
&\langle Z_{\Gamma_I}(g_s, q_I, \tilde{q}_I, y_I), Z_{\Gamma_J}(g_s, q_J, \tilde{q}_J, y_J) \rangle \\
&= \sum_{(\Upsilon_I, \phi_I)} \sum_{(\Upsilon_J, \phi_J)} C(\Upsilon_I, \phi_I) C(\Upsilon_J, \phi_J) g_s^{2g(\Upsilon_{IJ}) - 2 + h(\Upsilon_{IJ})} q_{IJ}^{\beta(\Upsilon_{IJ}, \phi_{IJ})} \tilde{q}_{IJ}^{\tilde{\beta}(\Upsilon_{IJ}, \phi_{IJ})} y_{IJ}^{\mathbf{k}_{IJ}(\Upsilon_{IJ}, \phi_{IJ})} \\
&\quad \times \frac{\prod_{Q \in S_I} \left(\prod_{m=1}^{\infty} m^{k_{Q,m}^I} (k_{Q,m}^I)! \right)}{|\text{Aut}(\Upsilon_I, \phi_I)| \left(\prod_{e \in E(\Upsilon_I)} d_e^I \right) |\text{Aut}(\Upsilon_J, \phi_J)| \left(\prod_{e \in E(\Upsilon_J)} d_e^J \right)} \delta(\mathbf{k}_Q^I(\Upsilon_I, \phi_I), \mathbf{k}_{\psi(Q)}^J(\Upsilon_J, \phi_J)).
\end{aligned} \tag{3.17}$$

The δ -symbol in the right hand side projects the sum onto pairs of graphs (Υ_I, ϕ_I) , (Υ_J, ϕ_J) satisfying the gluing condition (3.10). In order for the right hand side of (3.17) to agree with (3.7), the coefficients $C(\Upsilon_I, \phi_I)$, $C(\Upsilon_J, \phi_J)$ must satisfy the gluing condition

$$C(\Upsilon_I, \phi_I)C(\Upsilon_J, \phi_J) = N(\mathbf{k}_{S_I}^I(\Upsilon_I, \phi_I))^*C(\Upsilon_{IJ}, \phi_{IJ}) \quad (3.18)$$

for any pair (Υ_I, ϕ_I) , (Υ_J, ϕ_J) satisfying (3.10), and for any pair $(\Upsilon_{IJ}, \phi_{IJ})$ obtained by gluing (Υ_I, ϕ_I) , (Υ_J, ϕ_J) . Obviously, this condition is not of combinatoric nature. The coefficients in question must be specified by a particular geometric implementation of the gluing algorithm, which will be discussed in the next section. Here we will assume (3.18) to be satisfied, and show that the pairing (3.17) produces the expected result (3.7). Note that

$$\frac{\prod_{Q \in S_I} \left(\prod_{m=1}^{\infty} m^{k_{Q,m}^I} \right)}{\left(\prod_{e \in E(\Upsilon_I)} d_e^I \right) \left(\prod_{e \in E(\Upsilon_J)} d_e^J \right)} = \frac{1}{\prod_{e \in E(\Upsilon_{IJ})} d_e^{IJ}}. \quad (3.19)$$

This follows from the definition of $\mathbf{k}_Q^I(\Upsilon_I, \phi_I)$, using the gluing condition (3.10).

Using (3.13), (3.18) and (3.19), in the right hand side of (3.17) we find

$$\begin{aligned} & \langle Z_{\Gamma_I}(g_s, q_I, \tilde{q}_I, y_I), Z_{\Gamma_J}(g_s, q_J, \tilde{q}_J, y_J) \rangle \\ &= \sum_{(\Upsilon_{IJ}, \phi_{IJ})} \frac{C(\Upsilon_{IJ}, \phi_{IJ})}{|\text{Aut}(\Upsilon_{IJ}, \phi_{IJ})| \prod_{e \in E(\Upsilon_{IJ})} d_e^{IJ}} g_s^{2g(\Upsilon_{IJ})-2+h(\Upsilon_{IJ})} q_{IJ}^{\beta(\Upsilon_{IJ}, \phi_{IJ})} \tilde{q}_{IJ}^{\tilde{w}(\Upsilon_{IJ}, \phi_{IJ})} y_{IJ}^{\mathbf{k}^{IJ}(\Upsilon_{IJ}, \phi_{IJ})} \end{aligned} \quad (3.20)$$

which is the expected result (3.7). This is our main gluing formula.

We would like to apply this gluing algorithm to the Gromov-Witten potential (3.1) which is a sum over connected graphs (Υ, ϕ) . One can construct a generating functional for disconnected graphs by taking the exponential of (2.13). It is a standard fact that $Z_{\Gamma}(g_s, q) = \exp(F_{\Gamma}(g_s, q))$ can be written as a sum over disconnected graphs

$$Z_{\Gamma}(g_s, q) = \sum_{(\Upsilon, \phi)} \frac{1}{|\text{Aut}(\Upsilon, \phi)| \prod_{e \in E(\Upsilon)} d_e} C(\Upsilon, \phi) g_s^{2g(\Upsilon)-2} q^{\beta(\Upsilon, \phi)}. \quad (3.21)$$

One could use any decomposition of Γ into relative graphs Γ_I . In particular we can cut Γ along each edge, obtaining a collection of graphs Γ_P labeled by vertices P of Γ . Each Γ_P has a inner vertex P and three outer vertices. These graphs will be simply called vertices. The main problem is finding a natural geometric construction for the coefficients $C(\Upsilon_P, \phi_P)$ associated to Γ_P satisfying the gluing conditions (3.18). This is the subject of the next section.

4. Gluing Algorithm – Geometry

This section consists of a geometric realization of the gluing algorithm. We consider a decomposition of Γ induced by intersecting the invariant curves C_{rs} with (noncompact) lagrangian cycles L_{rs} along circles S_{rs} ; S_{rs} divides C_{rs} into two discs with common boundary. To each circle S_{rs} we can associate a point Q_{rs} on the corresponding edge of Γ . The points Q_{rs} divide Γ into vertices as discussed in the last paragraph of the previous section. Each vertex represents a collection of (at most) three discs D_i , $i = 1, 2, 3$ in \mathbb{C}^3 with common origin. The boundaries of the discs are contained in three lagrangian cycles L_i , $i = 1, 2, 3$. Some vertices correspond to configurations of two or one discs, depending of the geometry. Those are special cases of the trivalent vertex.

The main problem is finding a geometric construction for the generating functional (3.6) so that the coefficients $C(\Upsilon_I, \phi_I)$ satisfy the gluing condition (3.18). A natural solution to this problem is suggested by string theory. One can wrap topological D-branes on the above lagrangian cycles, obtaining an open-closed topological string theory. Using the properties of this theory, one should be able to glue open string amplitudes obtaining closed string amplitudes. Therefore our generating functional should be the open string free energy associated to a collection of three lagrangian cycles in \mathbb{C}^3 as above. The main problem at this point is that there is no complete mathematical formalism for open string Gromov-Witten invariants. We can approach the problem from the point of view of large N duality and Chern-Simons theory as in [15,26], or from an enumerative point of view as in [10,13,19,20,24]. The first approach has been implemented in [2], resulting in a gluing algorithm based on topological vertices. A topological vertex is the open string partition function of three lagrangian cycles in \mathbb{C}^3 as predicted by large N duality. Vertices can be naturally glued using a pairing very similar to (3.16).

In this section we will take the second approach, constructing an open string generating functional based on heuristic localization computations as in [10,13,19,24]. The resulting expression can be written as a sum over open string graphs, as explained below, therefore it is tailor made for our construction. We will compare it in detail to the topological vertex in the next section.

Let us start with some basic facts. The open string Gromov-Witten invariants count virtual numbers of maps $f : \Sigma \rightarrow \mathbb{C}^3$, $f(\partial\Sigma) \subset L$ of fixed topological type, where Σ is a genus g Riemann surface with h boundary components. The h boundary components are naturally divided into three groups, which are mapped to L_1, L_2 and respectively L_3 .

We will denote by $h_1, h_2, h_3, h_1 + h_2 + h_3 = h$ the number of components in each group. We will also introduce three different sets of indices $1 \leq a_i \leq h_i, i = 1, 2, 3$ in order to label the components in each group. The topological type of the map f is determined by three positive integers (d_1, d_2, d_3) representing the degrees with respect to the three discs and three sets of winding numbers $n_{a_i}^i \geq 0, a_i = 1, \dots, h_i, i = 1, 2, 3$. In order to construct the generating functional, we introduce formal symbols $\tilde{q}_1, \tilde{q}_2, \tilde{q}_3$ keeping track of the degrees and the formal variables $z_i = (z_{i,a_i})_{a_i=1, \dots, \infty}, i = 1, 2, 3$ keeping track of the winding numbers.

$$F_\Lambda(g_s, q_i, z_i) = \sum_{g=0}^{\infty} \sum_{h=1}^{\infty} \sum_{d_i, n_{a_i}^i} g_s^{2g-2+h} C_{g, h_i}(d_i | n_{a_i}^i) \prod_{i=1}^3 \tilde{q}_i^{d_i} \prod_{a_i=1}^{h_i} z_{i, a_i}^{n_{a_i}^i}. \quad (4.1)$$

Note that $C_{g, h_i}(d_i | n_{a_i}^i) = 0$ unless $d_i = \sum_{a_i=1}^{h_i} n_{a_i}^i$. This expression can be written in a more concise form if we introduce the winding vectors $\mathbf{k}_i = (k_{i,m})_{m=1, \dots, \infty}$. Each vector has finitely many nonzero entry which count the number of boundary components of Σ mapping to each lagrangian cycle with given winding number. More precisely $k^{i,m}$ represents the number of boundary components mapping to L_i with winding number m . Note that we have $h_i = \sum_{m=1}^{\infty} k_{i,m} \equiv |\mathbf{k}_i|, d_i = \sum_{m=1}^{\infty} m k_{i,m} \equiv l(\mathbf{k}_i)$. The coefficients $C_{g, h_i}(d_i | n_{a_i}^i)$ are invariant under permutations of boundary components mapping to the same cycle L_i , hence they depend only on the \mathbf{k}^i . We can rewrite (4.1) as

$$F_\Lambda(g_s, q_i, y_i) = \sum_{g=0}^{\infty} g_s^{2g-2} \sum_{\mathbf{k}^i} C_g(\mathbf{k}_i) \prod_{i=1}^3 g_s^{|\mathbf{k}_i|} q_i^{l(\mathbf{k}_i)} \prod_{i=1}^3 y_i^{\mathbf{k}_i} \quad (4.2)$$

where $y_i^{\mathbf{k}_i} = \prod_{m=1}^{\infty} y_{i,m}^{k_{i,m}}$. We have replaced the formal variables z_i by new formal variables $y_i = (y_{i,m})_{m=1, \dots, \infty}$ which keep track of the winding vectors \mathbf{k}_i .

So far open string Gromov-Witten invariants have been rigorously constructed for a single disc in \mathbb{C}^3 [20] equipped with a torus action. There is an alternative computational definition [13] based on a heuristic application of the localization theorem of [9] to open string maps. Although not entirely rigorous, the second approach has been tested in many physical situations with very good results [4,5,6,10,13,19,24]. We will apply the same technique in order to construct the generating functional (4.2).

Given a circle action $T \times \mathbb{C}^3 \rightarrow \mathbb{C}^3$ preserving L , one can compute $C_{g, h_i}(d_i | n_{a_i}^i)$ by localization. The fixed open string maps can be labeled by graphs [10] by analogy with the closed string analysis of the previous section. The domain of a typical open string map

is a union $\Sigma_{g,h} = \Sigma_g^0 \cup \cup_{i=1}^3 \cup_{a_i=1}^{h_i} \Delta_{a_i}^i$ where Σ_0 is a closed prestable curve and $\Delta_{a_i}^i$ discs attached to Σ_g^0 at the marked points $p_{a_i}^i$. The data $(\Sigma_g^0, p_{a_i}^i)$ must form a stable marked curve. The map $f : \Sigma \rightarrow \mathbb{C}^3$ collapses Σ_g^0 to the origin $P = \{x_1 = x_2 = x_3 = 0\}$ and maps each $\Delta_{a_i}^i$ to D_i with degree $n_{a_i}^i$. There are some special cases when Σ_g^0 is a point, which have to be treated separately (see appendix A.)

Each fixed map is labeled by an open string graph with h rays attached to a single vertex v . The vertex represents Σ_0 , hence it is marked by the arithmetic genus g_v . The rays represent the discs $\Delta_{a_i}^i$, therefore they are marked by pairs $(i, n_{a_i}^i)$. We will denote such marked graphs by Λ . The generating functional (4.2) can be written as a sum over open string graphs

$$F_\Lambda(g_s, q_i, y_i) = \sum_{\Lambda} g_s^{2g(\Lambda)-2+h(\Lambda)} \frac{1}{|\text{Aut}(\Lambda)| \prod_{i=1}^3 \prod_{a_i=1}^{h_i} n_{a_i}^i} C(\Lambda) \prod_{i=1}^3 q_i^{l_i(\Lambda)} \prod_{i=1}^3 y_i^{\mathbf{k}^i} \quad (4.3)$$

where the notation is self-explanatory. For any graph Λ we define $g(\Lambda), h(\Lambda), \mathbf{k}^i(\Lambda)$ to be the genus, number of rays and respectively i -th winding vector of the corresponding fixed map; $l_i(\Lambda) = l(\mathbf{k}^i(\Lambda))$. The open string graphs are truncated graphs associated to the decomposition of Γ in vertices, according to the terminology of the previous section. The data of the map ϕ is encoded in the markings of the rays. The sum over graphs (4.3) is the local potential (3.6) associated to a trivalent vertex. The coefficients $C(\Lambda)$, or, equivalently, $C_{g,h_i}(d_i | n_{a_i}^i)$ are evaluated in appendix A. In the remaining part of this section we will show that they satisfy the gluing conditions (3.18).

4.1. Gluing Conditions

Let us consider a pair of trivalent vertices Γ_r, Γ_s in the decomposition of Γ which are glued to form a relative graph Γ_{rs} as in fig. 6. The edge joining the two vertices corresponds to an invariant curve C_{rs} on X . Let $(-a, -2+a)$, $a \in \mathbb{Z}$ denote the type of C_{rs} .

Consider two arbitrary open string graphs Λ_r, Λ_s projecting to Γ_r, Γ_s which satisfy the gluing condition $\kappa_1^r = \kappa_1^s$. Let Λ_{rs} be a new open string graph projecting to Γ_{rs} corresponding to an arbitrary gluing pattern of Λ_r, Λ_s . Here we want to prove the relation $C(\Lambda_{rs}) = N(\mathbf{k}_{Q_{r1}}^r(\Lambda_r)) C(\Lambda_r) C(\Lambda_s)$, where $N(\mathbf{k}_{Q_{r1}}^r(\Lambda_r))$ is a phase factor. This is an essential condition for the gluing algorithm.

Open string graphs can be evaluated using localization by analogy with closed string graphs. The open string coefficients have the following form

$$\begin{aligned}
C(\Lambda_I) = & \prod_{e_I \in E(\Lambda_I)} F_I(e_I) \prod_{v_I \in V_i(\Lambda_I), (g_{v_I}, \text{val}(v_I)) = (0,2)} G_I(v_I) \\
& \times \prod_{v_I \in V_i(\Lambda_I), (g_{v_I}, \text{val}(v_I)) \neq (0,1), (0,2)} \int_{(\overline{M}_{g_{v_I}, \text{val}(v_I)})^T} H_r(v_r)
\end{aligned} \tag{4.4}$$

where the index I takes values $I = r, s, rs$, and $F_I(e_I)$, $G_I(v_I)$, $H_I(v_I)$ are edge and respectively vertex factors. The explicit expressions are computed in appendix A.

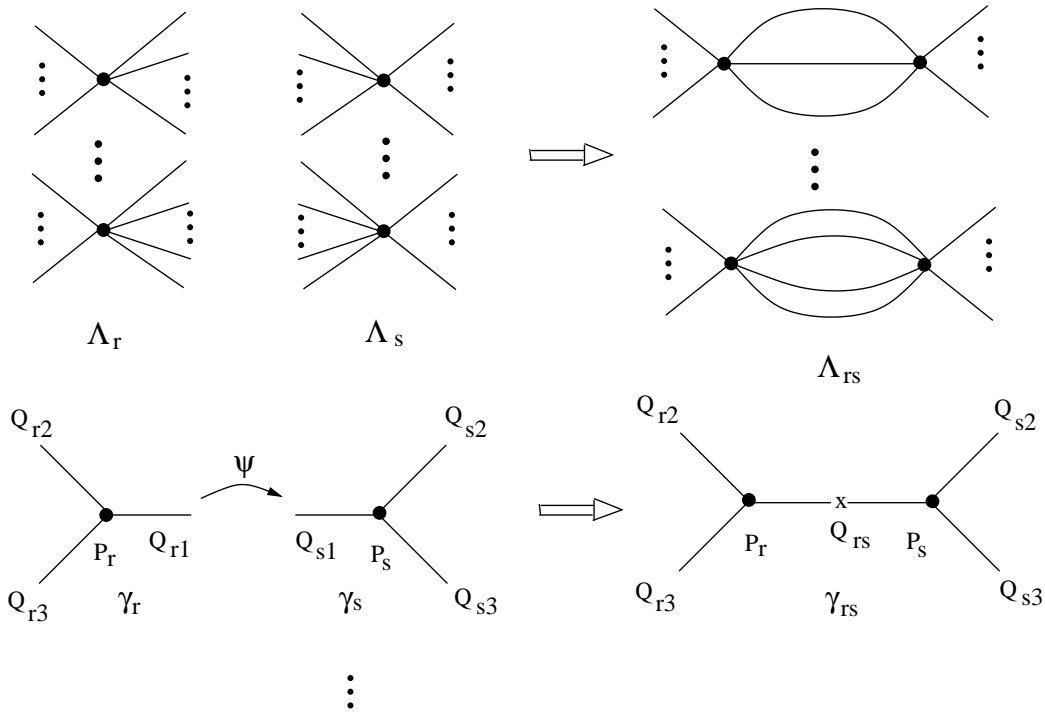

Fig. 6: Gluing open string graphs.

In order to simplify the notation, let us write $C(\Lambda_{r,s,rs}) = C_e(\Lambda_{r,s,rs})C_v(\Lambda_{r,s,rs})$ separating the edge and the vertex factors. Note that the set of inner vertices of Λ_{rs} is $V_i(\Lambda_{rs}) = V_i(\Lambda_r) \cup V_i(\Lambda_s)$. Moreover, the vertex factors $G_{r,s,rs}(v_{r,s,rs})$, $H_{r,s,rs}(v_{r,s,rs})$ are combinations of Hodge and Mumford classes determined by the marking data and the valence attached to a particular vertex. Since any inner vertex of Λ_{rs} comes from an inner vertex in either Λ_r or Λ_s , it follows that

$$C_v(\Lambda_r)C_v(\Lambda_s) = C_v(\Lambda_{rs}). \tag{4.5}$$

This leaves the edge factors. We have two types of edges. The outer edges associated to the univalent vertices $Q_{r2}, Q_{r3}, Q_{s2}, Q_{s3}$ are preserved by the gluing together with their markings. Therefore the corresponding edge factors remain trivially unchanged. The interesting edges are those associated to the univalent vertices Q_{r1}, Q_{s1} which are identified in the gluing process. Geometrically, this corresponds to gluing two discs D_{r1}, D_{s1} along their boundaries, obtaining the smooth rational curve C_{rs} . Before the gluing we have two products $C_{e1}(\Lambda_r), C_{e1}(\Lambda_s)$ of open string edge factors. After the gluing we have a product $C_{e1}(\Lambda_{rs})$ of closed string edge factors. All three products have the same number of factors, one for each edge of Λ_{rs} projecting to C_{rs} . Therefore the proof of the gluing conditions reduces to proving that

$$F_{e_r}(\Lambda_r)F_{e_s}(\Lambda_s) = F_{e_{rs}}(\Lambda_{rs}) \quad (4.6)$$

for any pair of edges e_r, e_s glued in the process. The edges e_r, e_s correspond to two T -fixed open string maps $f_{r,s} : \Delta_{r,s} \rightarrow D_{1r,1s}$ with the same degree $d_r = d_s = d$. The edge e_{rs} represents a T -fixed closed string map $f_{rs} : \Sigma_{rs} \simeq \mathbb{P}^1 \rightarrow C_{rs}$ of degree d . Recall that we denote by L_{rs} the lagrangian cycle which intersects C_{rs} along the common boundary of D_{1r}, D_{1s} . A routine computation (see appendix B) shows that

$$F_{rs}(e_{rs}) = (-1)^{1+d(a-2)} F_r(e_r) F_s(e_s). \quad (4.7)$$

Therefore we conclude that

$$C(\Lambda_r)C(\Lambda_s) = \prod_{m=1}^{\infty} (-1)^{1+m(a-2)k_{Q_{r1},m}^r} C(\Lambda_{rs}) \quad (4.8)$$

This is the required gluing condition (3.18), in which the phase factor is a sign depending only on the winding vector $\mathbf{k}_{Q_{r1}}^r(\Lambda_r) = \mathbf{k}_{Q_{s1}}^s(\Lambda_s)$.

5. Topological Vertex: Localization versus Chern-Simons

In this section we compare the open string free energy (4.1) with the topological vertex of [2]. The topological vertex is a generating functional for topological open string amplitudes derived from large N duality. Each lagrangian cycle L_i carries a flat unitary gauge field A_i . We denote by V_i its holonomy around the boundary of the disc D_i . Then the topological vertex is given by the following expression [2]

$$Z = \sum_{\mathbf{k}^1, \mathbf{k}^2, \mathbf{k}^3} C_{\mathbf{k}^1 \mathbf{k}^2 \mathbf{k}^3}^{n_1 n_2 n_3} \prod_{i=1}^3 \frac{1}{z_{\mathbf{k}^i}} \text{Tr}_{\mathbf{k}^i} V_i, \quad (5.1)$$

where \mathbf{k}^i are winding vectors, $z_{\mathbf{k}} = \prod_j k_j! j^{k_j}$ and $\text{Tr}_{\mathbf{k}} V = \prod_{j=1}^{\infty} (\text{Tr} V^j)^{k_j}$ and n_1, n_2, n_3 are the framing of the three legs of the vertex. The free energy derived from (5.1) is to be compared with the results from localization (see Appendix A.) For the computation of the necessary Hodge integrals we have used Faber's Maple code [7]. Below we list the coefficients of several terms with $h = 3, g \leq 2$ in the expansion of the free energy.

$$i)(\text{Tr} V_1)^3$$

Vertex result:

$$\begin{aligned} & \frac{ig}{6} n_1^2 (n_1 + 1)^2 - \frac{ig^3}{144} n_1^2 (n_1 + 1)^2 (8n_1^2 + 8n_1 - 9) + \frac{ig^5}{11520} n_1^2 (n_1 + 1)^2 [8n_1(n_1 + 1)(13n_1^2 \\ & + 13n_1 - 34) + 189]. \end{aligned} \quad (5.2)$$

Localization result:

$$\begin{aligned} & ig \frac{\rho_2^2 \rho_3^2}{6\rho_1^4} - ig^3 \frac{\rho_2^2 \rho_3^2}{144\rho_1^6} [9\rho_1(\rho_2 + \rho_3) - 8\rho_2\rho_3] + ig^5 \frac{\rho_2^2 \rho_3^2}{11520\rho_1^8} [-26\rho_1^3(\rho_2 + \rho_3) + 163\rho_1^2(\rho_2 + \rho_3)^2 \\ & - 272\rho_1\rho_2\rho_3(\rho_2 + \rho_3) + 104\rho_2^2\rho_3^2]. \end{aligned} \quad (5.3)$$

$$ii)(\text{Tr} V_1)^2 \text{Tr} V_2$$

Vertex result:

$$\begin{aligned} & \frac{ig}{2} (n_1 + 1)^2 - \frac{ig^3}{48} (n_1 + 1)^2 (2n_1^2 + 4n_1 + 1) + \frac{ig^5}{11520} (n_1 + 1)^2 [4n_1(n_1 + 2)(2n_1 + 1) \\ & \times (2n_1 + 3) + 3]. \end{aligned} \quad (5.4)$$

Localization result:

$$\begin{aligned} & ig \frac{\rho_3^2}{2\rho_1^2} - ig^3 \frac{\rho_3^2}{48\rho_1^4\rho_2} [\rho_1^3 + \rho_1^2(4\rho_2 + \rho_3) + 2\rho_1(2\rho_2^2 + \rho_2\rho_3) - 2\rho_2^2\rho_3] + \frac{ig^5}{11520} \cdot \frac{\rho_3^2}{\rho_1^6\rho_2^2} [\rho_1^6 + 2\rho_1^5 \\ & \times (19\rho_2 + 5\rho_3) + \rho_1^4(112\rho_2^2 + 58\rho_2\rho_3 + 5\rho_3^4) + 4\rho_1^3\rho_2(41\rho_2^2 + 24\rho_2\rho_3 + 5\rho_3^2) + 4\rho_1^2\rho_2^2(23\rho_2 \\ & + 2\rho_3) + 8\rho_1\rho_2^3\rho_3(11\rho_2 + 7\rho_3) + 16\rho_2^4\rho_3^2]. \end{aligned} \quad (5.5)$$

$$iii)(\text{Tr} V_1)^2 \text{Tr} V_2^2$$

Vertex result:

$$\begin{aligned} & \frac{ig}{2} [n_1^2 n_2 + n_1(2n_2 - 1) + 2n_2 - 1] - \frac{ig^3}{24} [n_1^4 n_2 + 2n_1^3(2n_2 - 1) + n_1^2(2n_2^3 + 11n_2 - 6) \\ & + 2n_1(2n_2^3 - 3n_2^2 + 7n_2 - 3) + 4n_2^3 - 6n_2^2 + 6n_2 - 2] + \frac{ig^5}{1440} [2n_1^6 n_2 + 6n_1^5(2n_2 - 1) + 5n_1^4 \\ & \times (2n_2^3 + 11n_2 - 6) + 20n_1^3(2n_2^3 - 3n_2^2 + 7n_2 - 3) + n_1^2(6n_2^5 + 110n_2^3 - 180n_2^2 + 183n_2 \\ & + 18)]. \end{aligned} \quad (5.6)$$

$$-60) + 2n_1(6n_2^5 - 15n_2^4 + 70n_2^3 - 90n_2^2 + 59n_2 - 15) + 6(2n_2^5 - 5n_2^4 + 10n_2^3 - 10n_2^2 + 5n_2 - 1)].$$

Localization result:

$$\begin{aligned} & ig \frac{\rho_3^2(2\rho_3 + \rho_2)}{2\rho_1^2\rho_2} - ig^3 \frac{\rho_3^2(2\rho_3 + \rho_2)}{24\rho_1^4\rho_2^3} [2\rho_1^3(\rho_2 - \rho_3) + 2\rho_1^2\rho_2(2\rho_2 - \rho_3) + 2\rho_1\rho_2^3 - \rho_2^3\rho_3] + ig^5 \\ & \times \frac{\rho_3^2(2\rho_3 + \rho_2)}{2880\rho_1^6\rho_2^5} [4\rho_1^6(2\rho_2 - 3\rho_3)(3\rho_2 - \rho_3) + 4\rho_1^5\rho_2(23\rho_2^2 - 32\rho_2\rho_3 + \rho_3^2) + 4\rho_1^4\rho_2^2(33\rho_2^2 \\ & - 32\rho_2\rho_3 - 6\rho_3^2) + \rho_1^3\rho_2^3(87\rho_2^2 - 73\rho_2\rho_3 + 16\rho_3^2) + \rho_1^2\rho_2^4(23\rho_2 - 19\rho_3)(\rho_2 - \rho_3) - 2\rho_1\rho_2^5\rho_3 \\ & \times (11\rho_2 + 3\rho_3) + 4\rho_2^6\rho_3^2]. \end{aligned} \quad (5.7)$$

$$iv) \text{Tr}V_1 \text{Tr}V_2 \text{Tr}V_3$$

Vertex result:

$$ig - \frac{ig^3}{24} + \frac{ig^5}{1920}. \quad (5.8)$$

Localization result:

$$\begin{aligned} & ig - \frac{ig^3}{24\rho_1\rho_2\rho_3} [\rho_1^2(\rho_2 + \rho_3) + \rho_1(\rho_2^2 + 4\rho_2\rho_3 + \rho_3^2) + \rho_2\rho_3(\rho_2 + \rho_3)] + \frac{ig^5}{5760\rho_1^2\rho_2^2\rho_3^2} \\ & \times [5\rho_1^4(\rho_2 + \rho_3)^2 + 2\rho_1^3(5\rho_2^3 + 24\rho_2^2\rho_3 + 24\rho_2\rho_3^2 + 5\rho_3^3) + \rho_1^2(5\rho_2^4 + 48\rho_2^3\rho_3 + 102\rho_2^2\rho_3^2 \\ & + 48\rho_2\rho_3^3 + 5\rho_3^4) + 2\rho_1\rho_2\rho_3(5\rho_2^3 + 24\rho_2^2\rho_3 + 24\rho_2\rho_3^2 + 5\rho_3^3) + 5\rho_2^2\rho_3^2(\rho_2 + \rho_3)^2]. \end{aligned} \quad (5.9)$$

$$v) \text{Tr}V_1^2 \text{Tr}V_2 \text{Tr}V_3$$

Vertex result:

$$ig(2n_1 + 1) - \frac{ig}{6}(2n_1 + 1)(n_1^2 + n_1 + 1) + \frac{ig^5}{120}(2n_1 + 1)[n_1(n_1 + 1)(n_1^2 + n_1 + 3) + 1]. \quad (5.10)$$

Localization result:

$$\begin{aligned} & ig \frac{\rho_1 + 2\rho_2}{\rho_1} - ig^3 \frac{\rho_1 + 2\rho_2}{24\rho_1^3\rho_2\rho_3} [\rho_1^3(\rho_2 + \rho_3) + \rho_1^2(\rho_2^2 + 6\rho_2\rho_3 + \rho_3^2) - 4\rho_2^2\rho_3^2] + ig^5 \frac{\rho_1 + 2\rho_2}{5760\rho_1^5\rho_2^2\rho_3^2} \\ & \times [\rho_1^6(\rho_2 + \rho_3)^2 + 2\rho_1^5(\rho_2 + \rho_3)(5\rho_2^2 + 29\rho_2\rho_3 + 5\rho_3^2) + \rho_1^4(5\rho_2^4 + 58\rho_2^3\rho_3 + 186\rho_2^2\rho_3^2 + 58\rho_2\rho_3^3 \\ & + 5\rho_3^4) - 40\rho_1^3\rho_2^2\rho_3^2(\rho_2 + \rho_3) - 8\rho_1^2\rho_2^2\rho_3^2(9\rho_2^2 + 46\rho_2\rho_3 + 9\rho_3^2) - 80\rho_1\rho_2^3\rho_3^3(\rho_2 + \rho_3) + 48\rho_2^4\rho_3^4]. \end{aligned} \quad (5.11)$$

$$vi) \text{Tr}V_1^2 \text{Tr}V_2^2 \text{Tr}V_3$$

Vertex result:

$$\begin{aligned}
& ig(n_1 + 2n_2 + 3n_1n_2) - \frac{ig^3}{24} [4n_1^3(3n_2 + 1) + 24n_1^2n_2 + 3n_1(4n_2^3 + 4n_2^2 + 19n_2 + 1) + 2n_2 \\
& \times (4n_2^2 + 15)] + \frac{ig^5}{1920} [16n_1^5(3n_2 + 1) + 160n_1^4n_2 + 40n_1^3(4n_2^3 + 4n_2^2 + 19n_2 + 1) + 80n_1^2n_2 \\
& \times (4n_2^2 + 15) + n_1(48n_2^5 + 80n_2^4 + 760n_2^3 + 120n_2^2 + 1167n_2 + 5) + 32n_2^5 + 400n_2^3 + 410n_2)].
\end{aligned} \tag{5.12}$$

Localization result:

$$\begin{aligned}
& ig \frac{(2\rho_2 + \rho_1)(2\rho_3 + \rho_2)}{\rho_1\rho_2} - ig^3 \frac{(2\rho_2 + \rho_1)(2\rho_3 + \rho_2)}{24\rho_1^3\rho_2^3\rho_3} [\rho_1^3(\rho_2^2 - 4\rho_3^2) + \rho_1^2\rho_2(\rho_2^2 + 8\rho_2\rho_3 - 4\rho_3^2) \\
& - 4\rho_1\rho_2^2\rho_3^2 - 4\rho_2^3\rho_3^2] + ig^5 \frac{(2\rho_2 + \rho_1)(2\rho_3 + \rho_2)}{24\rho_1^5\rho_2^5\rho_3^2} [\rho_1^6(5\rho_2^4 - 72\rho_2^2\rho_3^2 - 80\rho_2\rho_3^3 + 48\rho_3^4) + \rho_1^5\rho_2 \\
& \times (10\rho_2^4 + 78\rho_2^3\rho_3 - 80\rho_2^2\rho_3^2 - 576\rho_2\rho_3^3 + 16\rho_3^4) + \rho_1^4\rho_2^2(5\rho_2^4 + 78\rho_2^3\rho_3 + 240\rho_2^2\rho_3^2 - 400\rho_2\rho_3^3 \\
& + 168\rho_3^4) - 80\rho_1^3\rho_2^3\rho_3^2(\rho_2^2 + 5\rho_2\rho_3 - 4\rho_3^2) - 8\rho_1^2\rho_2^4\rho_3^2(9\rho_2^2 + 72\rho_2\rho_3 - 16\rho_3^2) - 16\rho_1\rho_2^5\rho_3^3(5\rho_2 \\
& - r_3) + 48\rho_2^6\rho_3^4].
\end{aligned} \tag{5.13}$$

$$vii) \text{Tr}V_1^2 \text{Tr}V_2^2 \text{Tr}V_3^2$$

Vertex result:

$$\begin{aligned}
& ig[2n_1(2n_2n_3 + n_2 + n_3) + 2n_2n_3 - 1] - \frac{ig^3}{6} [2n_1^3(2n_2n_3 + n_2 + n_3) + 3n_1^2(2n_2n_3 - 1) \\
& + n_1(4n_2^3n_3 + 2n_2^3 + 6n_2^2n_3 + 4n_2n_3^3 + 6n_2n_3^2 + 40n_2n_3 + 13n_2 + 2n_3^3 + 13n_3) + 2n_2^3n_3 \\
& - 3n_2^2 + 2n_2n_3^3 + 13n_2n_3 - 3n_3^2 - 4] + \frac{ig^5}{360} [6n_1^5(2n_2n_3 + n_2 + n_3) + 15n_1^4(2n_2n_3 - 1) \\
& + 10n_1^3(4n_2^3n_3 + 2n_2^3 + 6n_2^2n_3 + 4n_2n_3^3 + 6n_2n_3^2 + 40n_2n_3 + 13n_2 + 2n_3^3 + 13n_3) + 30n_1^2 \\
& \times (2n_2^3n_3 - 3n_2^2 + 2n_2n_3^3 + 13n_2n_3 - 3n_3^2 - 4) + n_1(12n_2^5n_3 + 6n_2^5 + 30n_2^4n_3 + 40n_2^3n_3^3 \\
& + 60n_2^3n_3^2 + 400n_2^3n_3 + 130n_2^3 + 60n_2^2n_3^3 + 390n_2^2n_3 + 12n_2n_3^5 + 30n_2n_3^4 + 400n_2n_3^3 \\
& + 390n_2n_3^2 + 1266n_2n_3 + 299n_2 + 6n_3^5 + 130n_3^3 + 299n_3) + 6n_2^5n_3 - 15n_2^4 + 20n_2^3n_3^3 \\
& + 130n_2^3n_3 - 90n_2^2n_3^2 - 120n_2^2 + 6n_2n_3^5 + 130n_2n_3^3 + 299n_2n_3 - 15n_3^4 - 120n_3^2 - 48].
\end{aligned} \tag{5.14}$$

Localization result:

$$\begin{aligned}
& ig \frac{(2\rho_1 + \rho_3)(2\rho_2 + \rho_1)(2\rho_3 + \rho_2)}{\rho_1\rho_2\rho_3} + ig^3 \frac{(2\rho_1 + \rho_3)(2\rho_2 + \rho_1)(2\rho_3 + \rho_2)}{6\rho_1^3\rho_2^3\rho_3^3} [\rho_1^3(\rho_2^3 + \rho_2^2\rho_3 \\
& + \rho_2\rho_3^2 + \rho_3^3) + \rho_1^2(\rho_2^3\rho_3 - 2\rho_2^2\rho_3^2 + \rho_2\rho_3^3) + \rho_1(\rho_2^3\rho_3^2 + \rho_2^2\rho_3^3) + \rho_2^3\rho_3^3] + ig^5 \frac{2\rho_1 + \rho_3}{360\rho_1^5\rho_2^5\rho_3^5} \\
& \times (2\rho_2 + \rho_1)(2\rho_3 + \rho_2) [\rho_1^6(\rho_2 + \rho_3)^2(3\rho_2^4 - 5\rho_2^3\rho_3 + 15\rho_2^2\rho_3^2 - 5\rho_2\rho_3^3 + 3\rho_3^4) + \rho_1^5\rho_2\rho_3
\end{aligned}$$

$$\begin{aligned}
& \times (\rho_2 + \rho_3)(\rho_2^4 - 41\rho_2^3\rho_3 + 36\rho_2^2\rho_3^2 - 41\rho_2\rho_3^3 + \rho_3^4) + \rho_1^4\rho_2^2\rho_3^2(8\rho_2^4 - 5\rho_2^3\rho_3 + 54\rho_2^2\rho_3^2 \\
& - 5\rho_2\rho_3^3 + 8\rho_3^4) + 5\rho_1^3\rho_2^3\rho_3^3(\rho_2 + \rho_3)(4\rho_2^2 - 5\rho_2\rho_3 + 4\rho_3^2) + 8\rho_1^2\rho_2^4\rho_3^4(\rho_2^2 - 5\rho_2\rho_3 + \rho_3^2) \\
& + \rho_1\rho_2^5\rho_3^5(\rho_2 + \rho_3) + 3\rho_2^6\rho_3^6].
\end{aligned} \tag{5.15}$$

Using the condition $\rho_1 + \rho_2 + \rho_3 = 0$ derived in appendix A below, we find a complete agreement between the two expansions provided that the framing variables n_i are related to the torus weights by

$$n_1 = \frac{\rho_2}{\rho_1}, \quad n_2 = \frac{\rho_3}{\rho_2}, \quad n_3 = \frac{\rho_1}{\rho_3}. \tag{5.16}$$

It is easy to check that there is not choice of the torus weights rendering all n_i integral. This may seem puzzling at first since the framing variables are traditionally integral in Chern-Simons theory. A first deviation from this rule was noticed in [6] in the context of large N duality. Given the large N duality origin of the topological vertex, the present result is not surprising. As pointed out in [6], in order to obtain a consistent coupling of Chern-Simons theory and open string instanton corrections, the framing should be thought of as a formal variable. Then all Chern-Simons expressions must be formally expanded as power series of these variables. The same strategy has been applied in this section, with very good results. We have also checked several terms with $h = 4, g \leq 2$ and found agreement between the Chern-Simons and localization computations. In the light of this numerical evidence, we conjecture that the two generating functionals must agree to all orders. This result has been proved in [21,22,25] for a univalent vertex. The trivalent vertex is an open problem.

Appendix A. Open String Localization

Here we compute the generating functional (4.1) using open string localization. Let (x_1, x_2, x_3) be coordinates on \mathbb{C}^3 , and let

$$x_1 \longrightarrow e^{-i\rho_1\phi}x_1, \quad x_2 \longrightarrow e^{-i\rho_2\phi}x_2, \quad x_3 \longrightarrow e^{-i\rho_3\phi}x_3 \tag{A.1}$$

be an S^1 action. The lagrangian cycles L_i are defined by the following equations

$$\begin{aligned}
L_1 : & \quad |x_1| = 1, & x_2 &= \bar{x}_3\bar{x}_1 \\
L_2 : & \quad |x_2| = 1, & x_3 &= \bar{x}_1\bar{x}_2 \\
L_3 : & \quad |x_3| = 1, & x_1 &= \bar{x}_2\bar{x}_3.
\end{aligned} \tag{A.2}$$

The S^1 action (A.1) preserves $L = L_1 \cup L_2 \cup L_3$ if the weights (ρ_1, ρ_2, ρ_3) satisfy

$$\rho_1 + \rho_2 + \rho_3 = 0. \quad (\text{A.3})$$

The three S^1 -invariant discs ending on L are given by

$$\begin{aligned} D_1 : \quad & 0 \leq |x_1| \leq 1, & x_2 = x_3 = 0 \\ D_2 : \quad & 0 \leq |x_2| \leq 1, & x_3 = x_1 = 0 \\ D_3 : \quad & 0 \leq |x_3| \leq 1, & x_1 = x_2 = 0. \end{aligned} \quad (\text{A.4})$$

Let us describe the structure of an S^1 invariant map $f : \Sigma_{g,h} \rightarrow X$ with lagrangian boundary conditions on L . The map $f : \Sigma_{g,h} \rightarrow X$ is constrained by stability and S^1 invariance. We give a complete classification of all maps satisfying these two conditions, proceeding on a case by case basis.

By S^1 invariance, f must map $\Sigma_{g,h}$ onto the union of three discs $D_1 \cup D_2 \cup D_3$. In the generic case, the domain must be a nodal bordered Riemann surface, consisting of a closed surface Σ_g^0 and three sets of discs $\Delta_{a_i}^i$, $i = 1, 2, 3$ which are mapped to D_1, D_2 and respectively D_3 . For future reference we will denote by t_{ia_i} a coordinate on $\Delta_{a_i}^i$ centered at the origin. The discs are attached to Σ_g^0 by identifying the origins $t_{ia_i} = 0$ to the marked points $p_{a_i}^i \in \Sigma_g^0$, so that we obtain a connected surface. The closed curve Σ_g^0 is mapped to the common origin P of D_1, D_2, D_3 . Stability further requires $(\Sigma_g^0, p_{a_i}^i)$ to be a stable marked curve. We obtain several cases which should be spelled out in detail.

i) $(g, h) = (0, 1)$ In this case, the domain is a single disc, which can be mapped to D_1, D_2 or D_3 . We have to distinguish accordingly three subcases

$$\begin{aligned} a) \quad & (g, h_i) = (0, 1, 0, 0), \quad (d_i | n_{a_i}^i) = (d_1, 0, 0 | d_1, 0, 0) & f : \Delta_1^1 \rightarrow D_1, \quad x_1 = t_{11}^{d_1} \\ b) \quad & (g, h_i) = (0, 0, 1, 0), \quad (d_i | n_{a_i}^i) = (0, d_2, 0 | 0, d_2, 0) & f : \Delta_1^2 \rightarrow D_2, \quad x_2 = t_{21}^{d_2} \\ c) \quad & (g, h_i) = (0, 0, 0, 1), \quad (d_i | n_{a_i}^i) = (0, 0, d_3 | 0, 0, d_3) & f : \Delta_1^3 \rightarrow D_3, \quad x_3 = t_{31}^{d_3}. \end{aligned} \quad (\text{A.5})$$

The automorphism group is $\text{Aut}(f) \simeq \mathbb{Z}/d_i$ where $i = 1, 2, 3$.

ii) $(g, h) = (0, 2)$ The domain is a nodal (or pinched) annulus consisting of two discs with common origin. The two discs can be mapped either to the same disc D_i in X or to

two different discs D_i, D_j , $i \neq j$. This yields again several subcases

$$\begin{aligned}
a) \quad (g, h_i) &= (0, 2, 0, 0), \quad (d_i | n_{a_i}^i) = (d_1, 0, 0 | n_1^1, n_2^1, 0, 0) & f : \Delta_1^1 \cup \Delta_2^1 &\longrightarrow D_1, \\
& & x_1 &= t_{11}^{n_1^1} = t_{12}^{n_2^1} \\
b) \quad (g, h_i) &= (0, 0, 2, 0), \quad (d_i | n_{a_i}^i) = (0, d_2, 0 | 0, n_1^2, n_2^2, 0) & f : \Delta_1^2 \cup \Delta_2^2 &\longrightarrow D_2, \\
& & x_2 &= t_{21}^{n_1^2} = t_{22}^{n_2^2} \\
c) \quad (g, h_i) &= (0, 0, 0, 2), \quad (d_i | n_{a_i}^i) = (d_1, 0, 0 | 0, 0, n_1^3, n_2^3) & f : \Delta_1^3 \cup \Delta_2^3 &\longrightarrow D_3, \\
& & x_3 &= t_{31}^{n_1^3} = t_{32}^{n_2^3} \\
d) \quad (g, h_i) &= (0, 1, 1, 0), \quad (d_i | n_{a_i}^i) = (d_1, d_2, 0 | d_1, d_2, 0) & f : \Delta_1^1 \cup \Delta_1^2 &\longrightarrow D_1 \cup D_2, \\
& & x_1 &= t_{11}^{d_1}, x_2 = t_{21}^{d_2} \\
e) \quad (g, h_i) &= (0, 1, 0, 1), \quad (d_i | n_{a_i}^i) = (d_1, 0, d_3 | d_1, 0, d_3) & f : \Delta_1^1 \cup \Delta_1^3 &\longrightarrow D_1 \cup D_3, \\
& & x_1 &= t_{11}^{d_1}, x_3 = t_{31}^{d_3} \\
f) \quad (g, h_i) &= (0, 0, 1, 1), \quad (d_i | n_{a_i}^i) = (0, d_2, d_3 | 0, d_2, d_3) & f : \Delta_1^2 \cup \Delta_1^3 &\longrightarrow D_2 \cup D_3, \\
& & x_2 &= t_{21}^{d_2}, x_3 = t_{31}^{d_3}.
\end{aligned} \tag{A.6}$$

In the subcases (a), (b) and (c) the automorphism group is

$$\text{Aut}(f) = \begin{cases} \mathbb{Z}_{n_1^i} \times \mathbb{Z}_{n_2^i}, & i = 1, 2, 3 & \text{for } n_1^i \neq n_2^i \\ \mathbb{Z}_{n_1^i} \times \mathbb{Z}_{n_2^i} \times \mathbb{Z}/2, & i = 1, 2, 3 & \text{for } n_1^i = n_2^i \end{cases} \tag{A.7}$$

where the $\mathbb{Z}/2$ factor in the second line is generated by a permutation of the two components of the domain. This is an automorphism if and only if $n_1^i = n_2^i$. For the remaining three cases, the automorphism group is

$$\text{Aut}(f) = \mathbb{Z}/d_i \times \mathbb{Z}/d_{i+1} \tag{A.8}$$

with the convention that $3 + 1$ is identified with 1. Note that in this case, permuting the two components of the domain does not give rise to an automorphism even if $d_i = d_{i+1}$ for some $i = 1, 2, 3$. To conclude the classification of all possible fixed loci, we have one more case which has been briefly mentioned earlier, namely the generic case

iii) $(g, h) \neq (0, 1), (0, 2)$. The fixed map has the following form

$$f : \Sigma_g^0 \cup \left(\bigcup_{a_1=1}^{h_1} \Delta_{a_1}^1 \right) \cup \left(\bigcup_{a_2=1}^{h_2} \Delta_{a_2}^2 \right) \cup \left(\bigcup_{a_3=1}^{h_3} \Delta_{a_3}^1 \right) \longrightarrow D_1 \cup D_2 \cup D_3 \tag{A.9}$$

where $f(\Sigma_g^0) = P$ is a point, and

$$\begin{aligned}
x_1 &= t_{11}^{n_1^1} = \dots = t_{1h_1}^{n_{h_1}^1} \\
x_2 &= t_{21}^{n_1^2} = \dots = t_{2h_2}^{n_{h_2}^2} \\
x_3 &= t_{31}^{n_1^3} = \dots = t_{3h_3}^{n_{h_3}^3}.
\end{aligned} \tag{A.10}$$

The marked Riemann surface $(\Sigma_g^0, p_{a_i}^i)$ must be a stable Deligne-Mumford curve. In this case the automorphism group is a product between

$$G = \prod_{i=1}^3 \prod_{a_i=1}^{h_i} \mathbb{Z}/n_{a_i}^i \quad (\text{A.11})$$

and a subgroup

$$\mathcal{P}_1 \times \mathcal{P}_2 \times \mathcal{P}_3 \subset \mathcal{S}_{h_1} \times \mathcal{S}_{h_2} \times \mathcal{S}_{h_3} \quad (\text{A.12})$$

where \mathcal{P}_i permutes the marked points $\{p_{a_i}^i\}$ preserving the winding numbers $n_{a_i}^i$, $i = 1, 2, 3$. In terms of the winding vectors \mathbf{k}_i , we have

$$\mathcal{P}_i \simeq \prod_{m=1}^{\infty} \mathcal{S}_{\mathbf{k}_i, m}. \quad (\text{A.13})$$

Note that in all cases, the maps are fixed under the T action provided that T acts on the disc $\Delta_{a_i}^i$ as follows

$$t_{ia_i} \longrightarrow e^{-i\phi\rho_i/n_{a_i}^i} t_{ia_i}. \quad (\text{A.14})$$

The coefficients $C_{g,h_1,h_2,h_3}(d_i|n_{a_i}^i)$ are computed by evaluating the contributions of the fixed points $(i) - (iii)$ to the virtual fundamental class. As usual with open string localization computations, the result is a homogeneous rational function of (ρ_1, ρ_2, ρ_3) of degree zero. In the cases $(i) - (ii)$ above, the fixed locus in question is a point, therefore we have

$$C_{g,h_1,h_2,h_3}(d_i|n_{a_i}^i) = \frac{1}{|\text{Aut}(f)|} \int_{pt_{S^1}} \frac{e(\mathbb{T}^2)}{e(\mathbb{T}^1)}. \quad (\text{A.15})$$

Here $e(\mathbb{T}^{1,2})$ denote the equivariant Euler classes of the terms in the tangent obstruction complex restricted to the fixed locus, and the integral represents equivariant integration along the fibers the map $pt_{S^1} \longrightarrow BS^1$. For the third case, we have similarly

$$C_{g,h_1,h_2,h_3}(d_i|n_{a_i}^i) = \frac{1}{|\text{Aut}(f)|} \int_{[M_{g,h}]_{S^1}} \frac{e(\mathbb{T}^2)}{e(\mathbb{T}^1)}. \quad (\text{A.16})$$

Next, we evaluate the contributions of the fixed points listed above starting with the generic case. Let $f_{\partial} : \Sigma_{g,h} \longrightarrow L$ denote the restriction of $f : \Sigma_{g,h} \longrightarrow X$ to the boundary of $\Sigma_{g,h}$. The pair $(f^*T_X, f_{\partial}^*T_L)$ forms a Riemann-Hilbert bundle on $(\Sigma_{g,h}, \partial\Sigma_{g,h})$ and we will denote by \mathcal{T}_X the associated sheaf of germs of holomorphic sections. For future reference, we will denote by $\mathcal{T}_{X_{a_i}^i}$ the restriction of \mathcal{T}_X to the disc $\Delta_{a_i}^i$. For simplicity, we will also

denote the domain of f by Σ , dropping the indices (g, h) . The closed surface Σ_g^0 will be similarly denoted by Σ^0 , and the restriction $f|_{\Sigma^0} \equiv f^0$.

The tangent-obstruction complex reads

$$0 \longrightarrow \text{Aut}(\Sigma) \longrightarrow H^0(\Sigma, \mathcal{T}_X) \longrightarrow \mathbb{T}^1 \longrightarrow \text{Def}(\Sigma) \longrightarrow H^1(\Sigma, \mathcal{T}_X) \longrightarrow \mathbb{T}^2 \longrightarrow 0. \quad (\text{A.17})$$

We denote the terms in this complex by B_1, \dots, B_6 and the moving parts under the S^1 action by B_1^m, \dots, B_6^m . Then (A.16) becomes

$$C_{g, h_1, h_2, h_3}(d_i | n_{a_i}^i) = \frac{1}{|\text{Aut}(f)|} \int_{[\overline{M}_{g, h}]_{S^1}} \frac{e(B_1^m) e(B_5^m)}{e(B_2^m) e(B_4^m)}. \quad (\text{A.18})$$

We have

$$\frac{e(B_1^m)}{e(B_4^m)} = \frac{1}{e(\text{Def}(\Sigma)^m)} \quad (\text{A.19})$$

since $\text{Aut}(\Sigma)$ is generated in this case by $t_{ia_i} \partial_{t_{ia_i}}$ which are fixed by the S^1 action. The moving part of $\text{Def}(\Sigma)^m$ is generated by deformations of the nodes, that is

$$\text{Def}(\Sigma)^m \simeq \bigoplus_{i=1}^3 \bigoplus_{a_i=1}^{h_i} T_{p_{a_i}^i} \Sigma^0 \otimes T_0 \Delta_{a_i}^i. \quad (\text{A.20})$$

This yields

$$e(\text{Def}(\Sigma)^m) = \prod_{i=1}^3 \prod_{a_i=1}^{h_i} \left(\frac{\rho_i}{n_{a_i}^i} H - \psi_{ia_i} \right) \quad (\text{A.21})$$

where H is the generator of $H^*(BS^1)$ and $\psi_{ia_i} \in H^*(\overline{M}_{g, h})$ are the Mumford classes associated to the marked points $p_{a_i}^i$ for $a_i = 1, \dots, h_i$, $i = 1, 2, 3$. The other Euler classes in (A.16) can be evaluated using a (partial) normalization exact sequence

$$0 \longrightarrow \mathcal{T}_X \longrightarrow f_0^* \mathcal{T}_X \oplus \bigoplus_{i=1}^3 \bigoplus_{a_i=1}^{h_i} \mathcal{T}_{X a_i}^i \longrightarrow \bigoplus_{i=1}^3 \bigoplus_{a_i=1}^{h_i} (T_X)_P \longrightarrow 0. \quad (\text{A.22})$$

The associated long exact sequence reads

$$\begin{aligned} 0 \longrightarrow H^0(\Sigma, \mathcal{T}_X) \longrightarrow H^0(\Sigma^0, f_0^* \mathcal{T}_X) \oplus \bigoplus_{i=1}^3 \bigoplus_{a_i=1}^{h_i} H^0(\Delta_{a_i}^i, \mathcal{T}_{X a_i}^i) \longrightarrow \bigoplus_{i=1}^3 \bigoplus_{a_i=1}^{h_i} (T_X)_P \\ \longrightarrow H^1(\Sigma, \mathcal{T}_X) \longrightarrow H^1(\Sigma^0, f_0^* \mathcal{T}_X) \oplus \bigoplus_{i=1}^3 \bigoplus_{a_i=1}^{h_i} H^1(\Delta_{a_i}^i, \mathcal{T}_{X a_i}^i) \longrightarrow 0. \end{aligned} \quad (\text{A.23})$$

We denote the terms in the complex (A.23) by F_1, \dots, F_5 . Then we have

$$\frac{e(B_5^m)}{e(B_2^m)} = \frac{e(F_5^m) e(F_3^m)}{e(F_2^m)}. \quad (\text{A.24})$$

In principle we have all the elements needed for the evaluation of the r.h.s. of (A.24) except the cohomology groups $H^{0,1}(\Delta_{a_i}^i, \mathcal{T}_{X_{a_i}}^i)$. These groups can be computed as in [13,19] or [5] obtaining the following expressions

$$\begin{aligned} H^0(\Delta_{a_i}^i, \mathcal{T}_{X_{a_i}}^i) &\simeq (\rho_i) \oplus \left(\frac{n_{a_i}^i - 1}{n_{a_i}^i} \rho_i \right) \oplus \dots \oplus \left(\frac{1}{n_{a_i}^i} \rho_i \right) \oplus (0)_{\mathbb{R}} \\ H^1(\Delta_{a_i}^i, \mathcal{T}_{X_{a_i}}^i) &\simeq \left(\rho_{i+1} + \frac{1}{n_{a_i}^i} \rho_i \right) \oplus \left(\rho_{i+1} + \frac{2}{n_{a_i}^i} \rho_i \right) \oplus \dots \oplus \left(\rho_{i+1} + \frac{n_{a_i}^i - 1}{n_{a_i}^i} \rho_i \right), \end{aligned} \quad (\text{A.25})$$

where ρ_{3+1} should be identified with ρ_1 . Now we can finish our Euler class computation

$$e(F_2^m) = H^{d+3} \prod_{i=1}^3 (\rho_i)^{d_i+1} \prod_{a_i=1}^{h_i} \frac{(n_{a_i}^i - 1)!}{(n_{a_i}^i)^{n_{a_i}^i - 1}} \quad (\text{A.26})$$

$$e(F_5^m) = H^{d-h} \prod_{i=1}^3 c_g(\mathbb{E}^*(\rho_i H)) \prod_{a_i=1}^{h_i} \prod_{l=1}^{n_{a_i}^i - 1} \left(\rho_{i+1} + \frac{l}{n_{a_i}^i} \right) \quad (\text{A.27})$$

$$e(F_3^m) = H^{3h} \prod_{i=1}^3 \rho_i^h. \quad (\text{A.28})$$

Collecting all intermediate results, we are left with

$$\begin{aligned} C_{g,h_1,h_2,h_3}(d_i | n_{a_i}^i) &= \frac{1}{|\text{Aut}(f)|} \int_{[\overline{M}_{g,h}]_{S^1}} \frac{e(B_1^m) e(B_5^m)}{e(B_2^m) e(B_4^m)} \\ &= \frac{1}{|\mathcal{P}|} \frac{(\rho_1 \rho_2 \rho_3)^{h-1}}{\rho_1^{d_1} \rho_2^{d_2} \rho_3^{d_3}} \prod_{i=1}^3 \prod_{a_i=1}^{h_i} \frac{\prod_{l=1}^{n_{a_i}^i - 1} (n_{a_i}^i \rho_{i+1} + l \rho_i)}{(n_{a_i}^i - 1)!} \\ &\times \int_{[\overline{M}_{g,h}]_{S^1}} \frac{H^{2h-3} \prod_{i=1}^3 c_g(\mathbb{E}^*(\rho_i H))}{\prod_{i=1}^3 \prod_{a_i=1}^{h_i} (\rho_i H - n_{a_i}^i \psi_{i a_i})}. \end{aligned} \quad (\text{A.29})$$

This represents the contribution of a generic fixed locus with $(g, h) \neq (0, 1), (0, 2)$ to the virtual fundamental class. Next we evaluate the contributions of the fixed loci for the special cases (i) – (ii).

In cases (ia) – (ic), the domain is a single disc Δ_1^i and $f : \Delta_1^i \rightarrow D_i$ is a Galois cover of degree d_i . Using the same conventions and notations as above, we have

$$\frac{e(B_5^m)}{e(B_2^m)} = \frac{H^{-1}}{\rho_i^{d_i}} \prod_{l=1}^{d_i-1} \frac{(d_i \rho_{i+1} + l \rho_i)}{(d_i - 1)!} \quad (\text{A.30})$$

$$\frac{e(B_1^m)}{e(B_4^m)} = H \frac{\rho_i}{d_i}. \quad (\text{A.31})$$

The last equation follows from the fact that for a disc $\text{Def}(\Delta_1^i)^m$ is trivial, while $\text{Aut}(\Delta_1^i)^m$ is generated by $\partial_{t_{i1}}$, which has weight $\frac{\rho_i}{d_i}$. Taking into account the automorphism group, we obtain

$$\begin{aligned} C_{0,1}(d_1, 0, 0|d_1, 0, 0) &= \frac{1}{d_1^2} \frac{1}{\rho_1^{d_1-1}} \frac{\prod_{l=1}^{d_1-1} (d_1 \rho_2 + l \rho_1)}{(d_1 - 1)!} \\ C_{0,1}(0, d_2, 0|0, d_2, 0) &= \frac{1}{d_2^2} \frac{1}{\rho_2^{d_2-1}} \frac{\prod_{l=1}^{d_2-1} (d_2 \rho_3 + l \rho_2)}{(d_2 - 1)!} \\ C_{0,1}(0, 0, d_3|0, 0, d_3) &= \frac{1}{d_3^2} \frac{1}{\rho_3^{d_3-1}} \frac{\prod_{l=1}^{d_3-1} (d_3 \rho_1 + l \rho_3)}{(d_3 - 1)!}. \end{aligned} \quad (\text{A.32})$$

Next we consider case (ii). In the first three subcases (iia) – (iic) the domain of f is a nodal cylinder Σ whose components are mapped in an invariant manner to the same disc in the target space X . It suffices to do the computations for (iia), since the remaining two cases are entirely analogous. We have to use a normalization sequence similar to (A.22), except that the closed curve Σ_g^0 is absent. Therefore we have

$$0 \longrightarrow \mathcal{T}_X \longrightarrow \mathcal{T}_{X_1}^1 \oplus \mathcal{T}_{X_1}^2 \longrightarrow (T_X)_P \longrightarrow 0 \quad (\text{A.33})$$

which yields the following long exact sequence

$$\begin{aligned} 0 \longrightarrow H^0(\Sigma, \mathcal{T}_X) \longrightarrow H^0(\Delta_1^1, \mathcal{T}_{X_1}^1) \oplus H^0(\Delta_1^2, \mathcal{T}_{X_1}^2) \longrightarrow (T_X)_P \longrightarrow H^1(\Sigma, \mathcal{T}_X) \\ \longrightarrow H^1(\Delta_1^1, \mathcal{T}_{X_1}^1) \oplus H^1(\Delta_1^2, \mathcal{T}_{X_1}^2) \longrightarrow 0 \end{aligned} \quad (\text{A.34})$$

whose terms will be denoted by F_1, \dots, F_5 as before. Then we can compute

$$\begin{aligned} \frac{e(B_5^m)}{e(B_2^m)} &= \frac{e(F_5^m) e(F_3^m)}{e(F_2^m)} \\ &= \rho_1 \rho_2 \rho_3 H \frac{\prod_{l=1}^{n_1^1-1} (n_1^1 \rho_2 + l \rho_1) \prod_{l=1}^{n_2^1-1} (n_2^1 \rho_2 + l \rho_1)}{\rho_1^{d_1} (n_1^1 - 1)! (n_2^1 - 1)!}. \end{aligned} \quad (\text{A.35})$$

The remaining factors are

$$\frac{e(B_1^m)}{e(B_4^m)} = \frac{1}{e(\text{Def}(\Sigma)^m)} = \frac{n_1^1 n_2^1}{n_1^1 + n_2^1} (\rho_1 H)^{-1} \quad (\text{A.36})$$

since $\text{Aut}(\Sigma)^m$ is trivial, and $\text{Def}(\Sigma)^m$ is generated by deformations of the node

$$\text{Def}(\Sigma)^m \simeq T_0 \Delta_1^1 \otimes T_0 \Delta_2^1. \quad (\text{A.37})$$

Substituting these expressions in (A.15), we obtain the following result

$$\begin{aligned}
C_{0,2}(d_1, 0, 0|n_1^1, n_2^1, 0, 0) &= \frac{1}{|\text{Aut}(f)|} \int_{pt_{S^1}} \frac{e(B_1^m)e(B_5^m)}{e(B_2^m)e(B_4^m)} \\
&= \frac{1}{|\mathcal{P}|} \frac{\rho_1 \rho_2 \rho_3}{\rho_1^{d_1+1}} \frac{\prod_{l=1}^{n_1^1-1} (n_1^1 \rho_2 + l \rho_1) \prod_{l=1}^{n_2^1-1} (n_2^1 \rho_2 + l \rho_1)}{(n_1^1 - 1)!(n_2^1 - 1)!(n_1^1 + n_2^1)}. \tag{A.38}
\end{aligned}$$

The results for (iib) and (iic) can be obtained by permuting the weights and the winding numbers

$$\begin{aligned}
C_{0,2}(0, d_2, 0|0, n_1^2, n_2^2, 0) &= \frac{1}{|\mathcal{P}|} \frac{\rho_1 \rho_2 \rho_3}{\rho_2^{d_2+1}} \frac{\prod_{l=1}^{n_1^2-1} (n_1^2 \rho_3 + l \rho_2) \prod_{l=1}^{n_2^2-1} (n_2^2 \rho_3 + l \rho_2)}{(n_1^2 - 1)!(n_2^2 - 1)!(n_1^2 + n_2^2)} \\
C_{0,2}(0, 0, d_3|0, 0, n_1^3, n_2^3) &= \frac{1}{|\mathcal{P}|} \frac{\rho_1 \rho_2 \rho_3}{\rho_3^{d_3+1}} \frac{\prod_{l=1}^{n_1^3-1} (n_1^3 \rho_1 + l \rho_3) \prod_{l=1}^{n_2^3-1} (n_2^3 \rho_1 + l \rho_3)}{(n_1^3 - 1)!(n_2^3 - 1)!(n_1^3 + n_2^3)}. \tag{A.39}
\end{aligned}$$

This leaves us with subcases (iie) – (iif). Again, it suffices to do the computations only for (iie). We have a map $f : \Delta_1^1 \cup \Delta_1^2 \rightarrow D_1 \cup D_2$ which is a Galois cover of D_1 and respectively D_2 when restricted to the components Δ_1^1, Δ_1^2 . In this case the normalization exact sequence is

$$0 \rightarrow \mathcal{T}_X \rightarrow \mathcal{T}_{X_1}^1 \oplus \mathcal{T}_{X_1}^2 \rightarrow (T_X)_P \rightarrow 0. \tag{A.40}$$

The associated long exact sequence reads

$$\begin{aligned}
0 \rightarrow H^0(\Sigma, \mathcal{T}_X) \rightarrow H^0(\Delta_1^1, \mathcal{T}_{X_1}^1) \oplus H^0(\Delta_1^2, \mathcal{T}_{X_1}^2) \rightarrow (T_X)_P \rightarrow H^1(\Sigma, \mathcal{T}_X) \\
\rightarrow H^1(\Delta_1^1, \mathcal{T}_{X_1}^1) \oplus H^1(\Delta_1^2, \mathcal{T}_{X_1}^2) \rightarrow 0. \tag{A.41}
\end{aligned}$$

Repeating the previous steps, this yields

$$\frac{e(B_5^m)}{e(B_2^m)} = H \frac{\rho_1 \rho_2 \rho_3}{\rho_1^{d_1} \rho_2^{d_2}} \frac{\prod_{l=1}^{d_1-1} (d_1 \rho_2 + l \rho_1) \prod_{l=1}^{d_2-1} (d_2 \rho_3 + l \rho_2)}{(d_1 - 1)!(d_2 - 1)!}. \tag{A.42}$$

Moreover, the moving part of $\text{Def}(\Sigma)$ is generated again by deformations of the node

$$\text{Def}(\Sigma)^m \simeq T_0(\Delta_1^1) \otimes T_0(\Delta_1^2), \tag{A.43}$$

which yields

$$\frac{e(B_1^m)}{e(B_4^m)} = \frac{d_1 d_2}{d_2 \rho_1 + d_1 \rho_2} H^{-1}. \tag{A.44}$$

Collecting all results we obtain the following expression

$$C_{0,2}(d_1, d_2, 0|d_1, d_2, 0) = \frac{\rho_1 \rho_2 \rho_3}{(d_2 \rho_1 + d_1 \rho_2) \rho_1^{d_1} \rho_2^{d_2}} \frac{\prod_{l=1}^{d_1-1} (d_1 \rho_2 + l \rho_1) \prod_{l=1}^{d_2-1} (d_2 \rho_3 + l \rho_2)}{(d_1 - 1)! (d_2 - 1)!}. \quad (\text{A.45})$$

For the remaining two cases, we can obtain the result by permuting the weights in (A.45)

$$\begin{aligned} C_{0,2}(0, d_2, d_3|0, d_2, d_3) &= \frac{\rho_1 \rho_2 \rho_3}{(d_3 \rho_2 + d_2 \rho_3) \rho_2^{d_2} \rho_3^{d_3}} \frac{\prod_{l=1}^{d_2-1} (d_2 \rho_3 + l \rho_2) \prod_{l=1}^{d_3-1} (d_3 \rho_1 + l \rho_3)}{(d_2 - 1)! (d_3 - 1)!} \\ C_{0,2}(d_1, 0, d_3|d_1, 0, d_3) &= \frac{\rho_1 \rho_2 \rho_3}{(d_1 \rho_3 + d_3 \rho_1) \rho_3^{d_3} \rho_1^{d_1}} \frac{\prod_{l=1}^{d_3-1} (d_3 \rho_1 + l \rho_3) \prod_{l=1}^{d_1-1} (d_1 \rho_2 + l \rho_1)}{(d_3 - 1)! (d_1 - 1)!}. \end{aligned} \quad (\text{A.46})$$

To summarize this subsection, let us collect the results for $C_{g,h_i}(d_i|n_{a_i}^i)$

$$\begin{aligned} C_{0,1}(d_1, 0, 0|d_1, 0, 0) &= \frac{1}{d_1^2} \frac{1}{\rho_1^{d_1-1}} \frac{\prod_{l=1}^{d_1-1} (d_1 \rho_2 + l \rho_1)}{(d_1 - 1)!} \\ C_{0,1}(0, d_2, 0|0, d_2, 0) &= \frac{1}{d_2^2} \frac{1}{\rho_2^{d_2-1}} \frac{\prod_{l=1}^{d_2-1} (d_2 \rho_3 + l \rho_2)}{(d_2 - 1)!} \\ C_{0,1}(0, 0, d_3|0, 0, d_3) &= \frac{1}{d_3^2} \frac{1}{\rho_3^{d_3-1}} \frac{\prod_{l=1}^{d_3-1} (d_3 \rho_1 + l \rho_3)}{(d_3 - 1)!} \\ C_{0,2}(d_1, 0, 0|n_1^1, n_2^1, 0, 0) &= \frac{1}{|\mathcal{P}|} \frac{\rho_1 \rho_2 \rho_3}{\rho_1^{d_1+1}} \frac{\prod_{l=1}^{n_1^1-1} (n_1^1 \rho_2 + l \rho_1) \prod_{l=1}^{n_2^1-1} (n_2^1 \rho_2 + l \rho_1)}{(n_1^1 - 1)! (n_2^1 - 1)! (n_1^1 + n_2^1)} \\ C_{0,2}(0, d_2, 0|0, n_1^2, n_2^2, 0) &= \frac{1}{|\mathcal{P}|} \frac{\rho_1 \rho_2 \rho_3}{\rho_2^{d_2+1}} \frac{\prod_{l=1}^{n_1^2-1} (n_1^2 \rho_3 + l \rho_2) \prod_{l=1}^{n_2^2-1} (n_2^2 \rho_3 + l \rho_2)}{(n_1^2 - 1)! (n_2^2 - 1)! (n_1^2 + n_2^2)} \\ C_{0,2}(0, 0, d_3|0, 0, n_1^3, n_2^3) &= \frac{1}{|\mathcal{P}|} \frac{\rho_1 \rho_2 \rho_3}{\rho_3^{d_3+1}} \frac{\prod_{l=1}^{n_1^3-1} (n_1^3 \rho_1 + l \rho_3) \prod_{l=1}^{n_2^3-1} (n_2^3 \rho_1 + l \rho_3)}{(n_1^3 - 1)! (n_2^3 - 1)! (n_1^3 + n_2^3)} \\ C_{0,2}(d_1, d_2, 0|d_1, d_2, 0) &= \frac{\rho_1 \rho_2 \rho_3}{(d_2 \rho_1 + d_1 \rho_2) \rho_1^{d_1} \rho_2^{d_2}} \frac{\prod_{l=1}^{d_1-1} (d_1 \rho_2 + l \rho_1) \prod_{l=1}^{d_2-1} (d_2 \rho_3 + l \rho_2)}{(d_1 - 1)! (d_2 - 1)!} \\ C_{0,2}(0, d_2, d_3|0, d_2, d_3) &= \frac{\rho_1 \rho_2 \rho_3}{(d_3 \rho_2 + d_2 \rho_3) \rho_2^{d_2} \rho_3^{d_3}} \frac{\prod_{l=1}^{d_2-1} (d_2 \rho_3 + l \rho_2) \prod_{l=1}^{d_3-1} (d_3 \rho_1 + l \rho_3)}{(d_2 - 1)! (d_3 - 1)!} \\ C_{0,2}(d_1, 0, d_3|d_1, 0, d_3) &= \frac{\rho_1 \rho_2 \rho_3}{(d_1 \rho_3 + d_3 \rho_1) \rho_3^{d_3} \rho_1^{d_1}} \frac{\prod_{l=1}^{d_3-1} (d_3 \rho_1 + l \rho_3) \prod_{l=1}^{d_1-1} (d_1 \rho_2 + l \rho_1)}{(d_3 - 1)! (d_1 - 1)!} \\ C_{g,h_1,h_2,h_3}(d_i|n_{a_i}^i) &= \frac{1}{|\mathcal{P}|} \frac{(\rho_1 \rho_2 \rho_3)^{h-1}}{\rho_1^{d_1} \rho_2^{d_2} \rho_3^{d_3}} \prod_{i=1}^3 \prod_{a_i=1}^{h_i} \frac{\prod_{l=1}^{n_{a_i}^i-1} (n_{a_i}^i \rho_{i+1} + l \rho_i)}{(n_{a_i}^i - 1)!} \\ &\times \int_{[\overline{M}_{g,h}]_{S^1}} \frac{H^{2h-3} \prod_{i=1}^3 c_g(\mathbb{E}^*(\rho_i H))}{\prod_{i=1}^3 \prod_{a_i=1}^{h_i} (\rho_i H - n_{a_i}^i \psi_{i a_i})}. \end{aligned} \quad (\text{A.47})$$

Appendix B. The Gluing Condition for Open String Graphs

In this appendix we prove the gluing formula (4.6) for an arbitrary invariant curve C_{rs} of type $(-a, -2+a)$. Let \mathcal{U} be an open neighborhood of C_{rs} in X which can be covered by two smooth coordinate patches $\mathcal{U}_r, \mathcal{U}_s$ with coordinates (x_1, x_2, x_3) and (y_1, y_2, y_3) . The local coordinates are chosen so that (x_1, y_1) are affine coordinates on \mathbb{P}^1 , while (x_2, x_3) and respectively (y_2, y_3) are normal coordinates in the two patches. Therefore the transition functions are

$$y_1 = \frac{1}{x_1}, \quad y_2 = x_1^a x_2, \quad y_3 = x_1^{-2+a} x_3. \quad (\text{B.1})$$

In terms of local coordinates, the torus action reads

$$\begin{aligned} x_1 &\longrightarrow e^{-i\rho_1\phi} x_1, & x_2 &\longrightarrow e^{-i\rho_2\phi} x_2, & x_3 &\longrightarrow e^{-i\rho_3\phi} x_3, \\ y_1 &\longrightarrow e^{i\rho_1\phi} y_1, & y_2 &\longrightarrow e^{-i(a\rho_1+\rho_2)\phi} y_2, & y_3 &\longrightarrow e^{-i((-2+a)\rho_1+\rho_3)\phi} y_3. \end{aligned} \quad (\text{B.2})$$

Note that the local form of the action in the patch \mathcal{U}_2 is determined by the local action in \mathcal{U}_1 and the transitions functions (B.1). We denote by

$$P_r : \quad x_1 = x_2 = x_3 = 0, \quad P_s : \quad y_1 = y_2 = y_3 = 0 \quad (\text{B.3})$$

the fixed points of the torus action.

There are five lagrangian cycles in $\mathcal{U}_{rs} = \mathcal{U}_r \cup \mathcal{U}_s$ given by

$$\begin{aligned} L_{r1} : \quad |x_1| = 1, \quad x_2 = \bar{x}_3 \bar{x}_1, & \quad L_{s1} : \quad |y_1| = 1, \quad y_2 = \bar{y}_3 \bar{y}_1 \\ L_{r2} : \quad |x_2| = 1, \quad x_3 = \bar{x}_1 \bar{x}_2, & \quad L_{s2} : \quad |y_2| = 1, \quad y_3 = \bar{y}_1 \bar{y}_2 \\ L_{r3} : \quad |x_3| = 1, \quad x_1 = \bar{x}_2 \bar{x}_3, & \quad L_{s3} : \quad |y_3| = 1, \quad y_1 = \bar{y}_2 \bar{y}_3. \end{aligned} \quad (\text{B.4})$$

Note however that $L_{r1} = L_{s1}$ are identical cycles. This can be seen using the transition functions (B.1). We also have six discs ending on the lagrangian cycles. For the present purposes we will consider only two of them

$$\begin{aligned} D_{r1} : \quad 0 \leq |x_1| \leq 1, \quad x_2 = x_3 = 0 \\ D_{s1} : \quad 0 \leq |y_1| \leq 1, \quad y_2 = y_3 = 0. \end{aligned} \quad (\text{B.5})$$

We consider open string fixed maps

$$f_r : \Delta_r \longrightarrow D_{r1}, \quad f_s : \Delta_s \longrightarrow D_{s1} \quad (\text{B.6})$$

of the same degree n which yield a degree n closed string map

$$f_{rs} : \Sigma_{rs} \longrightarrow C_{rs} \quad (\text{B.7})$$

by gluing. We denote by $\mathcal{T}_{X_r}, \mathcal{T}_{X_s}$ the corresponding Riemann-Hilbert bundles on Δ_r, Δ_s as in appendix A. The edge factors are

$$\begin{aligned} F_r(e_r) &= \frac{e(H^1(\Delta_r, \mathcal{T}_{X_r})^m) e(\text{Aut}(\Delta_r)^m)}{e(H^0(\Delta_r, \mathcal{T}_{X_r})^m)} \\ F_s(e_s) &= \frac{e(H^1(\Delta_s, \mathcal{T}_{X_s})^m) e(\text{Aut}(\Delta_s)^m)}{e(H^0(\Delta_s, \mathcal{T}_{X_s})^m)} \\ F_{rs}(e_{rs}) &= \frac{e(H^1(\Sigma_{rs}, f_{rs}^* T_X)^m) e(\text{Aut}(\Sigma_{rs})^m)}{e(H^0(\Sigma_{rs}, f_{rs}^* T_X)^m)}. \end{aligned} \quad (\text{B.8})$$

Let us compute the equivariant Euler classes in (B.8). For discs we can copy the results of the previous section (eqn.(A.25)) taking into account the local form of the S^1 action (B.2)

$$\begin{aligned} \frac{e(H^1(\Delta_r, \mathcal{T}_{X_r})^m)}{e(H^0(\Delta_r, \mathcal{T}_{X_r})^m)} &= H^{-1} \frac{\prod_{k=1}^{n-1} (n\rho_2 + k\rho_1)}{\rho_1^n (n-1)!} \\ \frac{e(H^1(\Delta_s, \mathcal{T}_{X_s})^m)}{e(H^0(\Delta_s, \mathcal{T}_{X_s})^m)} &= H^{-1} \frac{\prod_{k=1}^{n-1} (n(a\rho_1 + \rho_2) - k\rho_1)}{(-\rho_1)^n (n-1)!}. \end{aligned} \quad (\text{B.9})$$

In order to compute the edge factor for $f_{rs} : \Sigma_{rs} \longrightarrow X$ we have to use the short exact sequence of the image

$$0 \longrightarrow T_{C_{rs}} \longrightarrow T_X|_{C_{rs}} \longrightarrow N_{C_{rs}/X} \longrightarrow 0. \quad (\text{B.10})$$

This induces a short exact sequence on the domain¹

$$0 \longrightarrow f_{rs}^* T_{C_{rs}} \longrightarrow f_{rs}^* T_X \longrightarrow f_{rs}^* N_{C_{rs}/X} \longrightarrow 0. \quad (\text{B.11})$$

The associated long exact sequence reads

$$\begin{aligned} 0 \longrightarrow H^0(\Sigma_{rs}, f_{rs}^* T_{C_{rs}}) \longrightarrow H^0(\Sigma_{rs}, f_{rs}^* T_X) \longrightarrow H^0(\Sigma_{rs}, f_{rs}^* N_{C_{rs}/X}) \longrightarrow \\ \longrightarrow H^1(\Sigma_{rs}, f_{rs}^* T_{C_{rs}}) \longrightarrow H^1(\Sigma_{rs}, f_{rs}^* T_X) \longrightarrow H^1(\Sigma_{rs}, f_{rs}^* N_{C_{rs}/X}) \longrightarrow 0 \end{aligned} \quad (\text{B.12})$$

which shows that

$$\frac{e(H^1(\Sigma_{rs}, f_{rs}^* T_X)^m)}{e(H^0(\Sigma_{rs}, f_{rs}^* T_X)^m)} = \frac{e(H^1(\Sigma_{rs}, f_{rs}^* T_{C_{rs}})^m) e(H^1(\Sigma_{rs}, f_{rs}^* N_{C_{rs}/X})^m)}{e(H^0(\Sigma_{rs}, f_{rs}^* T_{C_{rs}})^m) e(H^0(\Sigma_{rs}, f_{rs}^* N_{C_{rs}/X})^m)}. \quad (\text{B.13})$$

¹ In order for the first and last term to make sense, we have to think of f_{rs} as a map to C_{rs} instead of X . This is a slight abuse of notation.

Now let us compute the cohomology groups. Recall that $T_{C_{rs}} \simeq \mathcal{O}(2)$ and $N_{C_{rs}/X} \simeq \mathcal{O}(-a) \oplus \mathcal{O}(a-2)$. Without loss of generality, we can assume $a \geq 1$. Then we have

$$\begin{aligned} H^0(\Sigma_{rs}, f_{rs}^* T_{C_{rs}}) &\simeq H^0(\mathbb{P}^1, \mathcal{O}(2n)) \\ H^0(\Sigma, f_{rs}^* N_{C_{rs}/X}) &\simeq H^0(\mathbb{P}^1, \mathcal{O}(-an) \oplus \mathcal{O}((a-2)n)). \end{aligned} \quad (\text{B.14})$$

Moreover, using Kodaira-Serre duality

$$\begin{aligned} H^1(\Sigma_{rs}, f_{rs}^* T_{C_{rs}}) &\simeq H^0(\Sigma_{rs}, f_{rs}^*(T_{C_{rs}}^* \otimes \omega_{\Sigma_{rs}})^*) \simeq H^0(\mathbb{P}^1, \mathcal{O}(-2-2n))^* = 0 \\ H^1(\Sigma_{rs}, f_{rs}^* N_{C_{rs}/X}) &\simeq H^0(\Sigma_{rs}, f_{rs}^*(N_{C_{rs}/X}^* \otimes \omega_{\Sigma_{rs}})^*) \simeq H^0(\mathbb{P}^1, \mathcal{O}(an-2) \oplus \mathcal{O}((2-a)n-2))^*. \end{aligned} \quad (\text{B.15})$$

We can write down explicit generators as follows

$$\begin{aligned} H^0(\Sigma_{rs}, f_{rs}^* T_{C_{rs}}) &: \quad \partial_{x_1}, t\partial_{x_1}, \dots, t^{2n}\partial_{x_1} \\ H^0(\Sigma_{rs}, f_{rs}^* N_{C_{rs}/X}) &: \quad \begin{cases} 0, & \text{if } a = 1 \\ \partial_{x_3}, t\partial_{x_3}, \dots, t^{(a-2)n}\partial_{x_3} & \text{if } a \geq 2 \end{cases} \\ H^1(\Sigma_{rs}, f_{rs}^* N_{C_{rs}/X})^* &: \quad \begin{cases} dx_2 dt, tdx_2 dt, \dots, t^{n-2} dx_2 dt, & \text{if } a = 1 \\ dx_3 dt, tdx_3 dt, \dots, t^{n-2} dx_3 dt \\ dx_2 dt, tdx_2 dt, \dots, t^{an-2} dx_2 dt & \text{if } a \geq 2. \end{cases} \end{aligned} \quad (\text{B.16})$$

where t is an affine coordinate of Σ so that $f : \Sigma \rightarrow C$ is locally given by $x_1 = t^n$. In terms of representations of S^1 , we have

$$\begin{aligned} H^0(\Sigma_{rs}, f_{rs}^* T_{C_{rs}}) &\simeq \bigoplus_{k=-n}^n \left(\frac{k}{n} \rho_1 \right) \\ H^0(\Sigma_{rs}, f_{rs}^* N_{C_{rs}/X}) &\simeq \begin{cases} 0, & \text{if } a = 1 \\ \bigoplus_{k=0}^{n(a-2)} \left(\rho_3 - \frac{k}{n} \rho_1 \right), & \text{if } a \geq 2 \end{cases} \\ H^1(\Sigma_{rs}, f_{rs}^* N_{C_{rs}/X}) &\simeq \begin{cases} \bigoplus_{k=1}^{n-1} \left(\rho_2 + \frac{k}{n} \rho_1 \right) \oplus \bigoplus_{k=1}^{n-1} \left(\rho_3 + \frac{k}{n} \rho_1 \right), & \text{if } a = 1 \\ \bigoplus_{k=1}^{an-2} \left(\rho_2 + \frac{k}{n} \rho_1 \right), & \text{if } a \geq 2. \end{cases} \end{aligned} \quad (\text{B.17})$$

Now we can finish the computation of the edge factors (B.13). We will consider the cases $a = 1$ and $a \geq 2$ separately

$$\begin{aligned} a = 1 : \quad & \frac{e(H^1(\Sigma_{rs}, f_{rs}^* T_X)^m)}{e(H^0(\Sigma, f_{rs}^* T_X)^m)} = H^{-2} \frac{\prod_{k=1}^{n-1} (n\rho_2 + k\rho_1) \prod_{k=1}^{n-1} (n\rho_3 + k\rho_1)}{\rho_1^n (-\rho_1)^n ((n-1)!)^2} \\ a \geq 2 : \quad & \frac{e(H^1(\Sigma_{rs}, f_{rs}^* T_X)^m)}{e(H^0(\Sigma_{rs}, f_{rs}^* T_X)^m)} = H^{-2} \frac{\prod_{k=1}^{an-2} (n\rho_2 + k\rho_1)}{\rho_1^n (-\rho_1)^n ((n-1)!)^2 \prod_{n=0}^{n(a-2)} (n\rho_3 - k\rho_1)}. \end{aligned} \quad (\text{B.18})$$

Before comparing (B.9) and (B.18) one has to remember that the weights ρ_i , $i = 1, 2, 3$ are supposed to satisfy the condition $\rho_1 + \rho_2 + \rho_3 = 0$ in order to preserve the lagrangian

cycles. Using this condition, we can rewrite the expressions in (B.18) as functions of ρ_1, ρ_2 only

$$\begin{aligned}
a = 1 : \quad & \frac{e(H^1(\Sigma_{rs}, f_{rs}^* T_X)^m)}{e(H^0(\Sigma_{rs}, f_{rs}^* T_X)^m)} = (-1)^{n-1} H^{-2} \frac{\prod_{k=1}^{n-1} (n\rho_2 + k\rho_1) \prod_{k=1}^{n-1} (n\rho_2 + (n-k)\rho_1)}{\rho_1^n (-\rho_1)^n ((n-1)!)^2} \\
a \geq 2 : \quad & \frac{e(H^1(\Sigma_{rs}, f_{rs}^* T_X)^m)}{e(H^0(\Sigma_{rs}, f_{rs}^* T_X)^m)} = (-1)^{1+n(a-2)} H^{-2} \frac{\prod_{k=1}^{n-1} (n\rho_2 + k\rho_1) \prod_{k=1}^{n-1} (n\rho_2 + (na-k)\rho_1)}{\rho_1^n (-\rho_1)^n ((n-1)!)^2}.
\end{aligned} \tag{B.19}$$

Therefore we can conclude that

$$\frac{e(H^1(\Sigma_{rs}, f_{rs}^* T_X)^m)}{e(H^0(\Sigma_{rs}, f_{rs}^* T_X)^m)} = (-1)^{1+n(a-2)} \frac{e(H^1(\Delta_r, \mathcal{T}_{Xr})^m)}{e(H^0(\Delta_r, \mathcal{T}_{Xr})^m)} \frac{e(H^1(\Delta_s, \mathcal{T}_{Xs})^m)}{e(H^0(\Delta_s, \mathcal{T}_{Xs})^m)} \tag{B.20}$$

for all a . The last element we need is a similar formula for the contributions of the automorphism groups. One can easily check that

$$e(\text{Aut}(\Sigma_{rs})^m) = e(\text{Aut}(\Delta_r)^m) e(\text{Aut}(\Delta_s)^m). \tag{B.21}$$

References

- [1] M. Aganagic, M. Mariño and C. Vafa, “All Loop Topological String Amplitudes from Chern-Simons Theory”, hep-th/0206164.
- [2] M. Aganagic, A. Klemm, M. Marino and C. Vafa, “The Topological Vertex”, hep-th/0305132.
- [3] K. Behrend and B. Fantechi, “The Intrinsic Normal Cone”, *Invent. Math.* **128** (1997) 45.
- [4] D.-E. Diaconescu, B. Florea and A. Grassi, “Geometric Transitions and Open String Instantons”, *ATMP* **6** (2002) 619, hep-th/0205234.
- [5] D.-E. Diaconescu, B. Florea and A. Grassi, “Geometric Transitions, del Pezzo Surfaces and Open String Instantons”, *ATMP* **6** (2002) 643, hep-th/0206163.
- [6] D.-E. Diaconescu and B. Florea, “Large N Duality for Compact Calabi-Yau Threefolds”, hep-th/0302076.
- [7] C. Faber, “Algorithms for Computing Intersection Numbers on Moduli Spaces of Curves, with an Application to the Class of the Locus of Jacobians”, in *New Trends in Algebraic Geometry*, Cambridge Univ. Press., 1999, alg-geom/9706006.
- [8] R. Gopakumar and C. Vafa, “On the Gauge Theory/Geometry Correspondence”, *ATMP* **3** (1999) 1415, hep-th/9811131.
- [9] T. Graber and R. Pandharipande, “Localization of Virtual Classes”, *Invent. Math.* **135** (1999) 487, math.AG/9708001.
- [10] T. Graber and E. Zaslow, “Open String Gromov-Witten Invariants: Calculations and a Mirror ‘Theorem’ ”, hep-th/0109075.
- [11] A. Iqbal, “All Genus Topological String Amplitudes and 5-brane Webs as Feynman Diagrams”, hep-th/0207114.
- [12] A. Iqbal and A.-K. Kashani-Poor, “ $SU(N)$ Geometries and Topological String Amplitudes”, hep-th/0306032.
- [13] S. Katz and C.-C. M. Liu, “Enumerative Geometry of Stable Maps with Lagrangian Boundary Conditions and Multiple Covers of the Disc”, *ATMP* **5** (2001) 1, math.AG/0103074.
- [14] M. Kontsevich, “Enumeration of Rational Curves via Torus Actions”, in *The Moduli Space of Curves*, 335-368, *Progr. Math.* **129**, Birkhäuser Boston, MA, 1995.
- [15] J.M.F. Labastida, M. Mariño and C. Vafa, “Knots, Links and Branes at Large N ”, *JHEP* **11** (2000) 007, hep-th/0010102.
- [16] J. Li and G. Tian, “Virtual Moduli Cycles and Gromov-Witten Invariants of Algebraic Varieties”, *J. Amer. Math. Soc.* **11** (1998) 119.
- [17] J. Li, “A Degeneration of Stable Morphisms and Relative Stable Morphisms”, math.AG/0009097.
- [18] J. Li, “A Degeneration Formula of GW-invariants”, math.AG/0110113.

- [19] J. Li and Y.S. Song, “Open String Instantons and Relative Stable Morphisms”, *ATMP* **5** (2002) 67, hep-th/0103100.
- [20] C.-C. M. Liu, “Moduli of J -Holomorphic Curves with Lagrangian Boundary Conditions and Open Gromov-Witten Invariants for an S^1 -Equivariant Pair”, math.SG/0210257.
- [21] C.-C. M. Liu, K. Liu and J. Zhou, “On a Proof of a Conjecture of Mariño-Vafa on Hodge Integrals”, math.AG/0306257.
- [22] C.-C. M. Liu, K. Liu and J. Zhou, “A Proof of a Conjecture of Mariño-Vafa on Hodge Integrals”, math.AG/0306434.
- [23] M. Mariño and C. Vafa, “Framed Knots at Large N ”, hep-th/0108064.
- [24] P. Mayr, “Summing up Open String Instantons and $\mathcal{N} = 1$ String Amplitudes”, hep-th/0203237.
- [25] A. Okounkov and R. Pandharipande, “Hodge Integrals and Invariants of the Unknot”, math.AG/0307209.
- [26] H. Ooguri and C. Vafa, “Knot Invariants and Topological Strings”, *Nucl. Phys. B* **577** (2000) 419, hep-th/9912123.