

Double Beta Decay and Dark Matter Search - Window to New Physics now, and in future (GENIUS)

H.V. Klapdor-Kleingrothaus

Max-Planck-Institut für Kernphysik
P.O.Box 10 39 80, D-69029 Heidelberg, Germany

Abstract. Nuclear double beta decay provides an extraordinarily broad potential to search for beyond Standard Model physics, probing already now the TeV scale, on which new physics should manifest itself. These possibilities are reviewed here.

First, the results of present generation experiments are presented. The most sensitive one of them – the Heidelberg-Moscow experiment in the Gran Sasso – probes the electron mass now in the sub eV region and will reach a limit of ~ 0.1 eV in a few years. Basing to a large extent on the theoretical work of the Heidelberg Double Beta Group in the last two years, results are obtained also for SUSY models (R-parity breaking, sneutrino mass), leptoquarks (leptoquark-Higgs coupling), compositeness, right-handed W boson mass and others. These results are comfortably competitive to corresponding results from high-energy accelerators like TEVATRON, HERA, etc.

Second, future perspectives of $\beta\beta$ research are discussed. A new Heidelberg experimental proposal (GENIUS) is presented which would allow to increase the sensitivity for Majorana neutrino masses from the present level of at best 0.1 eV down to 0.01 or even 0.001 eV. Its physical potential would be a breakthrough into the multi-TeV range for many beyond standard models. Its sensitivity for neutrino oscillation parameters would be larger than of all present terrestrial neutrino oscillation experiments and of those planned for the future. It could probe directly the atmospheric neutrino problem and even the large angle solution of the solar neutrino problem. It would further, already in a first

step, cover almost the full MSSM parameter space for prediction of neutralinos as cold dark matter, making the experiment competitive to LHC in the search for supersymmetry.

1. Introduction – Motivation for the search for double beta decay – and a future perspective: GENIUS

Double beta decay yields – besides proton decay – the most promising possibilities to probe beyond standard model physics beyond accelerator energy scales. Propagator physics has to replace direct observations. That this method is very effective, is obvious from important earlier research work and has been stressed, e.g. by [Rub96], etc.. Examples are the properties of W and Z bosons derived from neutral weak currents and β -decay, and the top mass deduced from LEP electroweak radiative corrections.

The potential of double beta decay includes information on the neutrino and sneutrino mass, SUSY models, compositeness, leptoquarks, right-handed W bosons and others (see Table 1). The recent results of the Heidelberg–Moscow experiment, which will be reported here, have demonstrated that $0\nu\beta\beta$ decay probes already now the TeV scale on which new physics should manifest itself according to present theoretical expectations. To give just one example, inverse double beta decay $e^-e^- \rightarrow W^-W^-$ requires an energy of at least 4 TeV for observability, according to present constraints from double beta decay [Bel95]. Similar energies are required to study, e.g. leptoquarks [Buc91, H195, Hir96a, Bav95, Leu94, Cho94, Blü94].

To increase by a major step the present sensitivity for double beta decay and dark matter search, we present here for the first time a new project which would operate one ton of ‘naked’ enriched **G**ermanium detectors in liquid **N**itrogen as shielding in an **U**nderground **S**etup (GENIUS). It would improve the sensitivity from the present potential of at best ~ 0.1 eV to neutrino masses down to 0.01 eV, a ten ton version even to 0.001 eV. The first version would allow to test a $\nu_e \rightarrow \nu_\mu$ explanation of the atmospheric neutrino problem, the second directly the large angle solution of the solar neutrino problem. The sensitivity for neutrino oscillation parameters would be larger than for all present accelerator neutrino oscillation experiments, or those planned for the future. GENIUS would further allow to test the recent hypothesis of a sterile neutrino and the underlying idea of a shadow world (see section 2). Both versions of GENIUS would definitely be a breakthrough into the multi-TeV range for many beyond standard models currently discussed in the literature, and the sensitivity would be comparable or even superior to LHC for various quantities such as

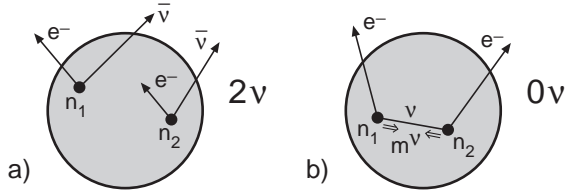

Fig. 1 Schematic representation of 2ν and 0ν double beta decay.

right-handed W-bosons, R-parity violation, leptoquark or compositeness searches.

Another issue of GENIUS is the search for Dark Matter in the universe. The full MSSM parameter space for predictions of neutralinos as cold dark matter could be covered already in a first step of the full experiment using only 100 kg of ^{76}Ge or even natural Ge, making the experiment competitive to LHC in the search for supersymmetry.

2. Double beta decay and particle physics

We present a brief introductory outline of the potential of $\beta\beta$ decay for some representative examples, including some comments on the status of the required nuclear matrix elements. The potential of double beta decay for probing neutrino oscillation parameters will be addressed in section 4.2.

Double beta decay can occur in several decay modes (Figs. 1–3)

$$\frac{A}{Z}X \rightarrow \frac{A}{Z+2}X + 2e^- + 2\bar{\nu}_e \quad (1)$$

$$\frac{A}{Z}X \rightarrow \frac{A}{Z+2}X + 2e^- \quad (2)$$

$$\frac{A}{Z}X \rightarrow \frac{A}{Z+2}X + 2e^- + \phi \quad (3)$$

$$\frac{A}{Z}X \rightarrow \frac{A}{Z+2}X + 2e^- + 2\phi \quad (4)$$

the last three of them violating lepton number conservation by $\Delta L = 2$. Fig. 3 shows the corresponding spectra, for the neutrinoless mode (2) a sharp line at $E = Q_{\beta\beta}$, for the two-neutrino mode and the various Majoron-accompanied modes classified by their spectral index, continuous spectra. Important for particle physics are the decay modes (2)–(4).

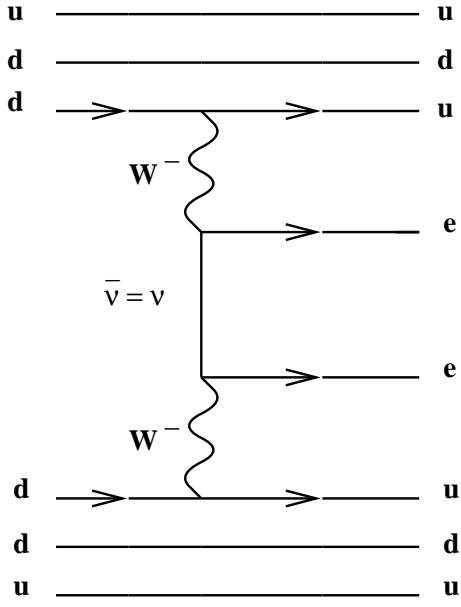

Fig. 2 Feynman graph for neutrinoless double beta decay triggered by exchange of a left-handed light or heavy neutrino

Observable	Restrictions	Topics investigated
0ν :	<u>via ν exchange:</u> Neutrino mass Light Neutrino Heavy Neutrino Right handed weak currents <u>via photino, gluino, zino</u> <u>(gaugino) or sneutrino</u> <u>exchange:</u> R-parity breaking, sneutrino mass <u>via leptoquark exchange</u> leptoquark-Higgs interaction	Beyond the standard model and SU(5) model; early universe, matter-antimatter asymmetry Dark matter L-R -symmetric models (e.g. SO(10)), compositeness V + A interaction, W_R^\pm masses SUSY models: Bounds for parameter space beyond the range of accelerators leptoquark masses and models
$0\nu\chi$:	existence of the Majoron	Mechanism of (B-L) breaking -explicit -spontaneous breaking of the local/global B-L symmetry new Majoron models

Table 1 $\beta\beta$ decay and particle physics

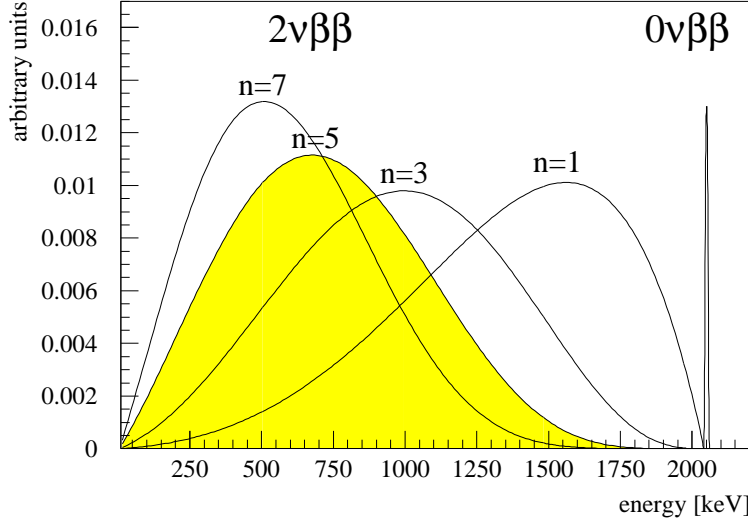

Fig. 3 *Spectral shapes of the different modes of double beta decay, n denotes the spectral index, $n=5$ for $2\nu\beta\beta$ decay (see text)*

The neutrinoless mode (2) needs not be necessarily connected with the exchange of a virtual neutrino or sneutrino. *Any* process violating lepton number can in principle lead to a process with the same signature as usual $0\nu\beta\beta$ decay. It may be triggered by exchange of neutralinos, gluinos, squarks, sleptons, leptoquarks,... (see below and [Päs97]). This gives rise to the broad potential of double beta decay for testing or yielding restrictions on quantities of beyond standard model physics (see Table 1), realized and investigated to a large extent by the Heidelberg Double Beta Group in the last two years. There is, however, a generic relation between the amplitude of $0\nu\beta\beta$ decay and the $(B - L)$ violating Majorana mass of the neutrino. It has been recognized about 15 years ago [Sch81] that if any of these two quantities vanishes, the other one vanishes, too, and vice versa, if one of them is non-zero, the other one also differs from zero. This Schechter-Valle-theorem is valid for any gauge model with spontaneously broken symmetry at the weak scale, independent of the mechanism of $0\nu\beta\beta$ decay. A generalisation of this theorem to supersymmetry has been given recently [Hir97, Hir97a]. This Hirsch-Klapdor-Kleingrothaus-Kovalenko-theorem claims for the neutrino Majorana mass, the $B - L$ violating mass of the sneutrino and neutrinoless double beta decay amplitude: If one of them is non-zero, also the others are non-zero and vice versa, independent of the mechanisms of $0\nu\beta\beta$ decay and (s-)neutrino mass generation. This theorem connects double beta research with new processes potentially observable at future colliders like NLC (next linear collider) [Hir97, Hir97a, Kol97].

2.1. Mass of the (electron) neutrino

The neutrino is one of the best examples for the merging of the different disciplines of micro- and macrophysics. The neutrino plays, by its nature (Majorana or Dirac particle), and its mass, a key role for the structure of modern particle physics theories (GUTs, SUSYs, SUGRAs,...) [Kla95, Kla97, Lan88, Gro90, Moh91, Kla97a, Kla97c]. At the same time it is candidate for non-baryonic hot dark matter in the universe, and the neutrino mass is connected – by the sphaleron effect – to the matter-antimatter asymmetry of the early universe [Kuz90]. Neutrino physics has entered an era of new actuality in connection with several possible indications of physics beyond the standard model (SM) of particle physics: A lack of solar (${}^7\text{Be}$) neutrinos, an atmospheric ν_μ deficit and mixed dark matter models could all be explained simultaneously by non-vanishing neutrino masses. Recent GUT models, for example an extended SO(10) scenario with S_4 horizontal symmetry could explain these observations by requiring degenerate neutrino masses of the order of 1 eV [Lee94, Moh94, Pet94, Ioa94, Fri95, Moh95, Pet96, Val96]. For an overview see [Smi96a]. Such degenerate scenarios are the more general solution of the well-known see-saw mechanism, of which the often discussed strongly hierarchical neutrino mass pattern is just a special solution (see [Moh97]). If the atmospheric neutrino data are excluded but LSND [Ath95, Ath96], HDM and solar neutrino constraints are kept, they could be explained by an inverted mass texture [Raf96, Cal95], where $m_{\nu_e} \simeq m_{\nu_\tau} \simeq 2.4\text{eV} \gg m_{\nu_\mu}$.

This brings double beta decay experiments into some key position, since with some second generation $\beta\beta$ experiments like the HEIDELBERG-MOSCOW experiment using large amounts of enriched $\beta\beta$ -emitter material the predictions of or assumptions in such scenarios can now be tested. If the first of the above scenarios of neutrino mass textures is ruled out by tightening the double beta limit on m_{ν_e} , then the only way to understand *all* neutrino results may require an additional sterile neutrino [Cal93, Pel93], coupling only extremely weakly to the Z-boson. Then the solar neutrino puzzle would be explained by the $\nu_e - \nu_S$ oscillation, and atmospheric neutrino data by $\nu_\mu - \nu_\tau$ oscillations, and the $\nu_{\mu,\tau}$ would constitute the hot dark matter (HDM) of the universe. The request for a light sterile neutrino would naturally lead to the concept of a shadow world [Ber95]. This assumes exact duplication of the Standard Model in both the gauge and the fermion content (the shadow sector), yielding three extra sterile neutrinos ν' , the only interaction connecting known and shadow sector being gravitation. Mixing of the ν and ν' will occur by Planck scale effects. Such a scenario could explain all *four* present indications for non-vanishing neutrino mass [Moh97]. The expectation for the effective neutrino mass (see below) to be seen in double beta decay would be $\langle m_{\nu_e} \rangle \simeq 0.02\text{eV}$ [Moh97a]. Thus it could be checked by the new Genius project (see section

4.2.2). Interestingly in such a scenario the ν'_μ, ν'_τ having masses of ~ 2 keV could act as warm or cold dark matter in the universe [Moh97].

At present neutrinoless double decay is the most sensitive of the various existing methods to determine the mass of the electron neutrino. It further provides a unique possibility of deciding between a Dirac and a Majorana nature of the neutrino. Neutrinoless double beta decay can be triggered by exchange of a light or heavy left-handed Majorana neutrino (Figs. 1,2). For exchange of a heavy *right*-handed neutrino see section 2.3. The propagators in the first and second case show a different m_ν dependence: Fermion propagator $\sim \frac{m}{q^2 - m^2} \Rightarrow$

$$a) \quad m \ll q \rightarrow \sim m \quad \text{'light' neutrino} \quad (5)$$

$$b) \quad m \gg q \rightarrow \sim \frac{1}{m} \quad \text{'heavy' neutrino} \quad (6)$$

The half-life for $0\nu\beta\beta$ decay induced by exchange of a light neutrino is given by [Mut88]

$$\begin{aligned} [T_{1/2}^{0\nu}(0_i^+ \rightarrow 0_f^+)]^{-1} &= C_{mm} \frac{\langle m_\nu \rangle^2}{m_e^2} + C_{\eta\eta} \langle \eta \rangle^2 + C_{\lambda\lambda} \langle \lambda \rangle^2 + C_{m\eta} \frac{m_\nu}{m_e} \\ &+ C_{m\lambda} \langle \lambda \rangle \frac{\langle m_\nu \rangle}{m_e} + C_{\eta\lambda} \langle \eta \rangle \langle \lambda \rangle \end{aligned} \quad (7)$$

or, when neglecting the effect of right-handed weak currents, by

$$[T_{1/2}^{0\nu}(0_i^+ \rightarrow 0_f^+)]^{-1} = C_{mm} \frac{\langle m_\nu \rangle^2}{m_e^2} = (M_{GT}^{0\nu} - M_F^{0\nu})^2 G_1 \frac{\langle m_\nu \rangle^2}{m_e^2} \quad (8)$$

where G_1 denotes the phase space integral, $\langle m_\nu \rangle$ denotes an effective neutrino mass

$$\langle m_\nu \rangle = \sum_i m_i U_{ei}^2, \quad (9)$$

respecting the possibility of the electron neutrino to be a mixed state (mass matrix not diagonal in the flavor space)

$$|\nu_e\rangle = \sum_i U_{ei} |\nu_i\rangle \quad (10)$$

The effective mass $\langle m_\nu \rangle$ could be smaller than m_i for all i for appropriate CP phases of the mixing coefficients U_{ei} [Wol81]. In general not too pathological GUT models yield $m_{\nu_e} = \langle m_{\nu_e} \rangle$ (see [Lan88]).

η, λ describe an admixture of right-handed weak currents, and $M^{0\nu} \equiv M_{GT}^{0\nu} - M_F^{0\nu}$ denote nuclear matrix elements.

Nuclear matrix elements:

A detailed discussion of $\beta\beta$ matrix elements for neutrino induced transitions including the substantial (well-understood) differences in the precision with which 2ν and $0\nu\beta\beta$ rates can be calculated, can be found in [Gro90, Mut88, Mut89, Sta90]. After the major step of recognizing the importance of ground state correlations for the calculation of $\beta\beta$ matrix elements [Kla84, Gro86], in recent years the main groups used the QRPA model for calculation of $M^{0\nu}$. The different groups obtained very similar results for $M^{0\nu}$ when using a realistic nucleon–nucleon interaction [Mut89, Sta90, Tom87], consistent with shell model approaches [Mut91, Hax84], where the latter are possible. Some deviation is found only when a non-realistic nucleon–nucleon interaction is used (e.g. δ force, see [Vog86] and also [Vog96]). Also use of a by far too small configuration space like in recent shell model Monte Carlo (SMMC) calculations [Rad95] can hardly lead to reliable results. On the other hand refinements of the QRPA approach by going to higher order QRPA (see [Sto96, Suh96]) lead only to minor changes for the $0\nu\beta\beta$ ground state transitions. The most recent QRPA calculations including proton–neutron pairing [Sim97] do not fulfill the Ikeda sum rule by 30 %. The calculated matrix elements are (correspondingly ?) about 40 % smaller than earlier calculations fulfilling the sum rule properly [Mut89, Sta90]. The consequences of high-lying GT strength (in the GTGR and in the Δ resonance) have been studied early already [Gro86].

Since the usual QRPA approach does ignore deformation, some larger uncertainty in these approaches may occur in deformed nuclei. This shows up for example in different results obtained for ^{150}Nd by QRPA and by a pseudo SU(3) model as used by [Hir95d]. Calculation of matrix elements of all double beta emitters have been published by [Gro85, Sta90]. Typical uncertainties of calculated $0\nu\beta\beta$ rates originating from the limited knowledge of the particle–particle force, which is the main source of the uncertainty in those nuclei where this QRPA approach is applicable, are shown in [Sta90]. They are of the order of a factor of 2.

2.2. Supersymmetry

Supersymmetry (SUSY) is considered as prime candidate for a theory beyond the standard model, which could overcome some of the most puzzling questions of today’s particle physics (see, e.g. [Hab93, Moh92, Kan97]). Accelerator experiments have hunted for signs of supersymmetric particles so far without success. Lower limits on masses of SUSY particles are at present in the range of 20–100 GeV [PDG96], mainly from experiments at LEP and TEVATRON.

Conservation of R–parity has been imposed ad hoc to the minimal supersymmetric extension of the standard model (MSSM) to ensure baryon number and lepton number conservation. SUSY particles differ then from usual particles not only in their masses but also in R–parity, assigned to be $R_P = 1$ for usual particles and $R_P = -1$ for SUSY particles. This assumption, however, is not guaranteed by supersymmetry or gauge invariance. Generally one can add the following R–parity violating terms to the usual superpotential [Hal84].

$$W_{R_P} = \lambda_{ijk} L_i L_j \bar{E}_k + \lambda'_{ijk} L_i Q_j \bar{D}_k + \lambda'' \bar{U}_i \bar{D}_j \bar{D}_k, \quad (11)$$

where indices i, j, k denote generations. L, Q denote lepton and quark doublet superfields and $\bar{E}, \bar{U}, \bar{D}$ lepton and up, down quark singlet superfields. Terms proportional to λ, λ' violate lepton number, those proportional to λ'' violate baryon number. From proton decay limits it is clear that both types of terms cannot be present at the same time in the superpotential. On the other hand, once the λ'' terms being assumed to be zero, λ and λ' terms are not limited. $0\nu\beta\beta$ decay can occur within the \mathbb{R}_p -MSSM through Feynman graphs such as those of Fig. 4. In lowest order there are altogether six different graphs of this kind. [Hir95, Hir95c, Hir96c]. Attention has, therefore, been focused also on SUSY theories with R–parity violation, in which $0\nu\beta\beta$ decay can proceed by exchange of supersymmetric particles like gluinos, photinos,... Thus $0\nu\beta\beta$ decay can be used to restrict R–parity violating SUSY models [Hir95, Hir96c, Moh91, Hir95c, Moh86]. From these graphs one derives [Hir95] under some assumptions

$$[T_{1/2}^{0\nu}(0^+ \rightarrow 0^+)]^{-1} \sim G_{01} \left(\frac{\lambda_{111}^2}{m_{\tilde{q}, \tilde{e}}^4 m_{\tilde{g}\chi}} M \right)^2 \quad (12)$$

where G_{01} is a phase space factor, $m_{\tilde{q}\tilde{e}\tilde{g}\chi}$ are the masses of supersymmetric particles involved: squarks, selectrons, gluinos, or neutralinos. λ'_{111} is the strength of an R–parity breaking interaction (eq. 11), and M is a nuclear matrix element. For the matrix elements and their calculation see [Hir96c].

It is also worthwhile to notice that $0\nu\beta\beta$ decay is not only sensitive to λ'_{111} . Taking into account the fact that the SUSY partners of the left and right–handed quark states can mix with each other, one can derive limits on different combinations of λ' [Hir96, Moh96a, Bab95]. Graphs allowing such information are as those shown in Fig. 5. The dominant diagram of this type is the one where the exchanged scalar particles are the $\tilde{b} - \tilde{b}^C$ pair. Under some assumptions (e.g. the MSSM mass parameters to be approximately equal to the “effective” SUSY breaking scale Λ_{SUSY}), one obtains [Hir96]

$$\lambda'_{11i} \cdot \lambda'_{1i1} \leq \epsilon'_i \left(\frac{\Lambda_{SUSY}}{100 GeV} \right)^3 \quad (13)$$

and

$$\Delta_n \lambda'_{311} \lambda_{n13} \leq \epsilon \left(\frac{\Lambda_{SUSY}}{100 GeV} \right)^3 \quad (14)$$

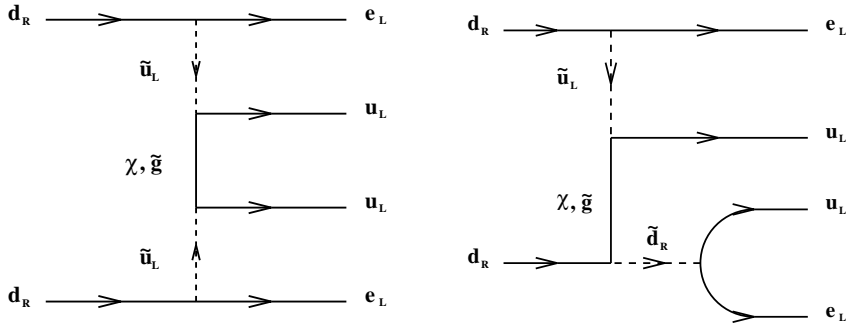

Fig. 4 Examples of Feynman graphs for $0\nu\beta\beta$ decay within R -parity violating supersymmetric models (from [Hir95]).

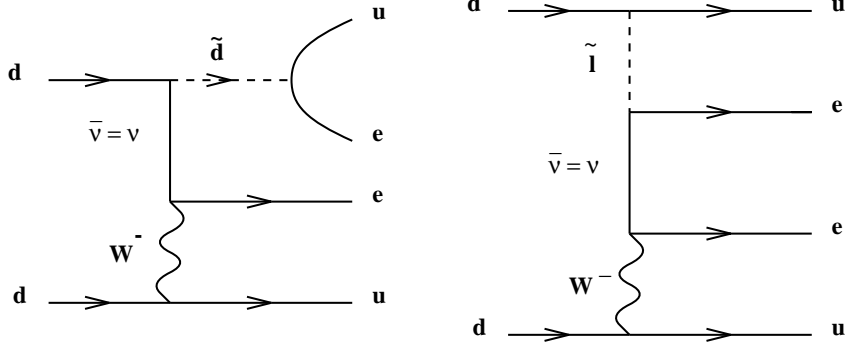

Fig. 5 a) Feynman graph for the mixed SUSY-neutrino exchange mechanism of $0\nu\beta\beta$ decay. R -parity violation occurs through scalar quark exchange. **b)** As figure 1, but for scalar lepton exchange (from [Hir96]).

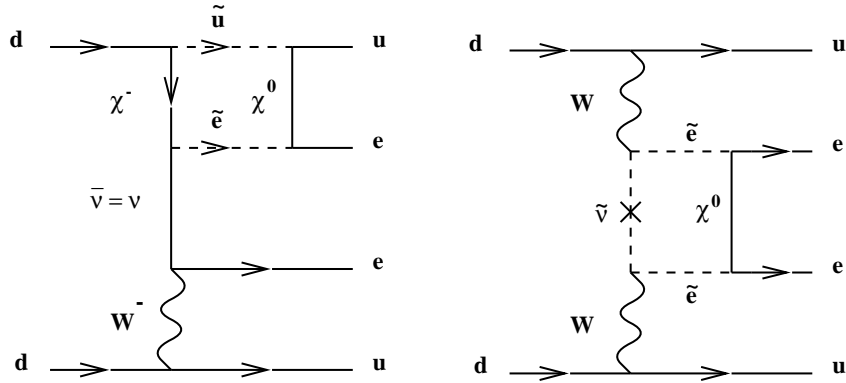

Fig. 6 Examples of R_P conserving SUSY contributions to $0\nu\beta\beta$ decay (from [Hir97a]).

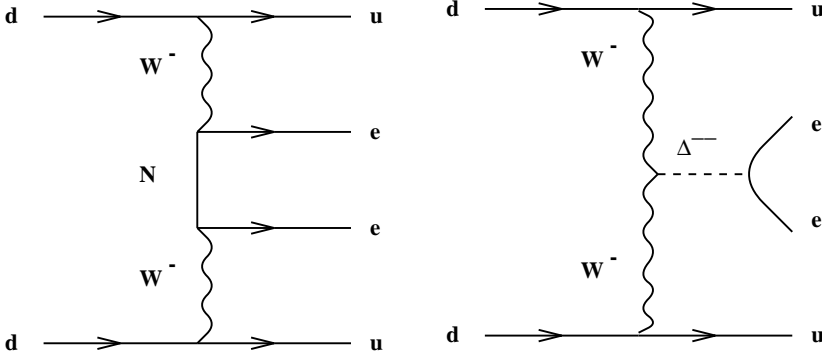

Fig. 7 a) Heavy neutrino exchange contribution to neutrinoless double beta decay in left right symmetric models, and **b)** Feynman graph for the virtual exchange of a doubly-charged Higgs boson, see text (from [Hir96d]).

With the known values of the SM quark and lepton masses follows $\epsilon'_{1,2,3} = 6.4 \cdot 10^{-5}$, $3.2 \cdot 10^{-6}$ and $1.1 \cdot 10^{-7}$, and $\epsilon = 6.5 \cdot 10^{-8}$. For an overview on our knowledge on λ'_{ijk} from other sources we refer to [Kol97a] and [Bha97].

Also R-parity *conserving* softly broken supersymmetry can give contributions to $0\nu\beta\beta$ decay, via the $B - L$ -violating sneutrino mass term, the latter being a generic ingredient of any weak-scale SUSY model with a Majorana neutrino mass [Hir97, Hir97a]. These contributions are realized at the level of box diagrams [Hir97a] (fig. 6). The $0\nu\beta\beta$ half-life for contributions from sneutrino exchange is found to be [Hir97a]

$$[T_{1/2}^{0\nu\beta\beta}]^{-1} = G_{01} \frac{4m_p^2}{G_F^4} \left| \frac{\eta^{SUSY}}{m_{SUSY}^5} M^{SUSY} \right|, \quad (15)$$

where the phase factor G_{01} is tabulated in [Doi85], η^{SUSY} is the effective lepton number violating parameter, which contains the $(B - L)$ violating sneutrino mass \tilde{m}_M and M^{SUSY} is the nuclear matrix element [Hir96d].

2.3. Left-Right symmetric theories – Heavy neutrinos and right-handed W Boson

Heavy *right-handed* neutrinos appear quite naturally in left-right symmetric GUT models. They offer in some natural way via the see-saw mechanism explanation for the small neutrino masses compared to other fermions and can explain also naturally parity violation. However the symmetry breaking scale for the right-handed sector is not fixed by the theory and thus the mass of the right-handed W_R boson and the mixing angle between the mass eigenstates W_1, W_2 are free parameters. $0\nu\beta\beta$ decay taking into

account contributions from both, left- and right-handed neutrinos have been studied theoretically by [Hir96d, Doi93]. The former gives a more general expression for the decay rate than introduced earlier by [Moh86b].

$0\nu\beta\beta$ decay proceeds through the diagram shown in Fig. 7a, where N denotes the heavy right-handed partner of the ordinary neutrino. In order to preserve the unitarity of the cross section in *inverse* $0\nu\beta\beta$ decay, LR models must according to [Riz82] include an additional Higgs triplet. This then gives rise to a second contribution to $0\nu\beta\beta$ decay, shown in Fig. 7b. From the Feynman graphs of Fig. 7 it is obvious that the amplitude will be proportional to [Hir96d]

$$\left(\frac{m_{W_L}}{m_{W_R}}\right)^4 \left(\frac{1}{m_N} + \frac{m_N}{m_{\Delta_R}^2}\right) \quad (16)$$

Eq. (16) and the experimental lower limit of $0\nu\beta\beta$ decay leads to a constraint limit within the 3-dimensional parameter space ($m_{W_R} - m_N - m_{\Delta_R}$). The most conservative (weakest) limit on m_{W_R} is obtained in the limit, where the mass of the Δ^{--} goes to infinity (see section 3 below). If adding information on the vacuum stability, an absolute lower limit on the mass of the right-handed W-boson can be obtained.

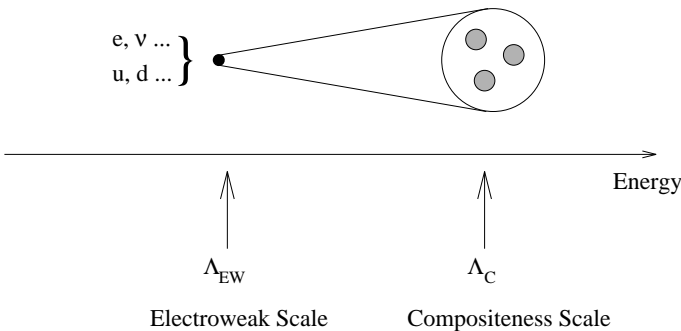

Fig. 8 The idea of compositeness. At a (still unknown) energy scale Λ_C quarks and lepton might show an internal structure

2.4. Compositeness

Although so far there are no experimental signals of a substructure of quarks and leptons, there are speculations that at some higher energy ranges beyond 1 TeV or so there might exist an energy scale Λ_C at which a substructure of quarks and leptons (preons) might become visible [Pan96, Moh92, Sou92](Fig. 8).

The main consequences of compositeness of quarks and leptons are (1) modifications to the gauge boson propagators and the interaction vertices

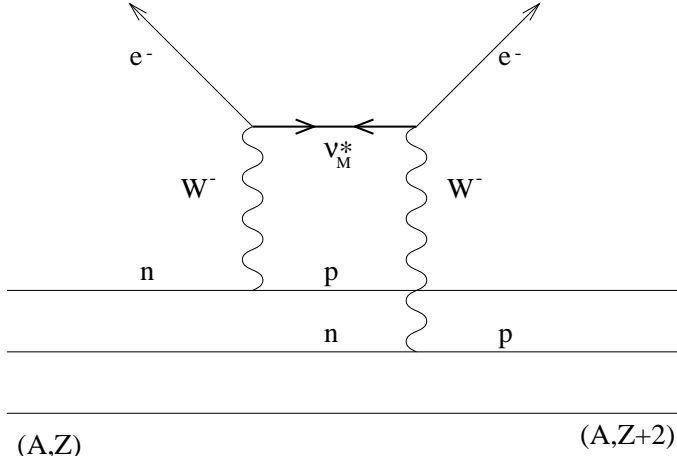

Fig. 9 Neutrinoless double beta decay ($\Delta L = +2$ process) mediated by a composite heavy Majorana neutrino.

with fermions, and additional effective four-fermion interactions through constituent exchange (2) highly massive excited states which couple to the ordinary fermions through gauge interactions. This is discussed in detail in [Pan96]. Lower bounds on the compositeness scale have been deduced from accelerator experiments at LEP [ALE93], Fermilab [CDF91], HERA [H195] and from a theoretical analysis of the effect of contact interactions in the leptonic τ decay [Dia93]. They are all in the range of $\Lambda_C \geq 1.6$ TeV.

The masses of the excited leptons (l^*) and quarks (q^*) should not be lower than the compositeness scale Λ_C . Already in 1982 it was shown [Ren82] that precise measurements of the anomalous magnetic moment of the electron give bounds on the masses of the excited states and thus the compositeness scale.

Limits on the masses of excited leptons from accelerators are $m_{e^*} > 127$ GeV [Adr92], $m_{e^*,\nu^*} > 91$ GeV [ALE92], $m_{\nu^*} > 180$ GeV [Der95, Rau94] $m_{q^*} > 540$ GeV [Abe94].

A possible low energy manifestation of compositeness could be neutrinoless double beta decay, mediated by a composite heavy Majorana neutrino (Fig. 9), which then should be a Majorana particle.

Recent theoretical work shows (see [Pan96, Tak96, Pan97, Tak97]) that the mass bounds for such an excited neutrino which can be derived from double beta decay are at least of the same order of magnitude as those coming from the direct search of excited states in high energy accelerators (see also section 3).

2.5. Majorons

The existence of new bosons, so-called Majorons, can play a significant role in new physics beyond the standard model, in the history of the early universe, in the evolution of stellar objects, in supernovae astrophysics and the solar neutrino problem [Geo81, Fri88, Kla92]. In many theories of physics beyond the standard model neutrinoless double beta decay can occur with the emission of Majorons

$$2n \rightarrow 2p + 2e^- + \phi \quad (17)$$

$$2n \rightarrow 2p + 2e^- + 2\phi. \quad (18)$$

In the classical Majoron model invented by Gelmini and Roncadelli in '81 [Gel81], the Majoron is the Nambu-Goldstone boson associated with the spontaneous breaking of the $B - L$ -symmetry and so generates Majorana masses of neutrinos. This was expected [Geo81] to give a sizeable contribution to double beta decay. It was, however, ruled out, as also the doublet Majoron [Aul82] by LEP [Ste91] since it should contribute the equivalent of two neutrino species to the width of the Z^0 . On the other hand, Majoron models in which the Majoron is an electroweak isospin singlet [Chi81, Ber92] are still viable. The drawback of the singlet Majoron is that it requires a severe finetuning in order to preserve existing bounds on neutrino masses and at the same time get an observable rate for Majoron accompanied $0\nu\beta\beta$ decay.

To avoid such an unnatural fine-tuning in recent years several new Majoron models were proposed [Bur93, Bam95, Car93], where the term Majoron denotes in a more general sense light or massless bosons with couplings to neutrinos.

The main novel features of these "New Majorons" are that they can carry leptonic charge, that they need not be Goldstone bosons and that emission of two Majorons can occur. The latter can be scalar-mediated or fermion-mediated. Table 2 shows some features of the different Majoron models according to [Bam95, Car93]. L denotes the leptonic charge, n the spectral index defining the phase space of the emitting particles, M the nuclear matrix elements. For details we refer to [Päs96, Bur96].

The half-lives are according to [Moh88, Doi85] in some approximation given by

$$[T_{1/2}]^{-1} = |\langle g_\alpha \rangle|^2 \cdot |M_\alpha|^2 \cdot G_{BB_\alpha} \quad (19)$$

for $\beta\beta\phi$ -decays, or

$$[T_{1/2}]^{-1} = |\langle g_\alpha \rangle|^4 \cdot |M_\alpha|^2 \cdot G_{BB_\alpha} \quad (20)$$

for $\beta\beta\phi\phi$ -decays. The index α indicates that effective neutrino-Majoron coupling constants g , matrix elements M and phase spaces G differ for different models.

case	modus	Goldstone boson	L	n	Matrix element
IB	$\beta\beta\phi$	no	0	1	$M_F - M_{GT}$
IC	$\beta\beta\phi$	yes	0	1	$M_F - M_{GT}$
ID	$\beta\beta\phi\phi$	no	0	3	$M_{F\omega^2} - M_{GT\omega^2}$
IE	$\beta\beta\phi\phi$	yes	0	3	$M_{F\omega^2} - M_{GT\omega^2}$
IIB	$\beta\beta\phi$	no	-2	1	$M_F - M_{GT}$
IIC	$\beta\beta\phi$	yes	-2	3	M_{CR}
IID	$\beta\beta\phi\phi$	no	-1	3	$M_{F\omega^2} - M_{GT\omega^2}$
IIE	$\beta\beta\phi\phi$	yes	-1	7	$M_{F\omega^2} - M_{GT\omega^2}$
IIF	$\beta\beta\phi$	Gauge boson	-2	3	M_{CR}

Table 2 Different Majoron models according to [Bam95]. The case IIF corresponds to the model of [Car93].

model	$T_{1/2}(\langle g \rangle = 10^{-4})$	$T_{1/2}(\langle g \rangle = 1)$	$T_{1/2exp}$
IB,IC,IIB	$4 \cdot 10^{22}$	$4 \cdot 10^{14}$	$1.67 \cdot 10^{22}$
ID,IE,IID	10^{38-42}	10^{22-26}	$1.67 \cdot 10^{22}$
IIC,IIF	$2 \cdot 10^{28}$	$2 \cdot 10^{20}$	$1.67 \cdot 10^{22}$
IIE	10^{38-42}	10^{22-26}	$3.37 \cdot 10^{22}$

Table 3 Comparison of half-lives calculated for different $\langle g \rangle$ -values for the new Majoron models with experimental best fit values, see section 3.1 (from [Hir96b])

Nuclear matrix elements:

According to Table 2 there are five different nuclear matrix elements. Of these M_F and M_{GT} are the same which occur in $0\nu\beta\beta$ decay. The other ones and the corresponding phase spaces have been calculated for the first time by [Päs96, Hir96b]. The calculation of the matrix elements show that the new models predict, as consequence of the small matrix elements very large half-lives and that unlikely large coupling constants would be needed to produce observable decay rates (see Table 3).

2.6. Sterile neutrinos

Introduction of sterile neutrinos has been claimed to solve simultaneously the conflict between dark matter neutrinos, LSND and supernova nucleosynthesis [Pel95] and light sterile neutrinos are part of popular neutrino mass textures for understanding the various hints for neutrino oscillations (see section 2.1) and [Moh96, Moh97, Moh97a]. Neutrinoless double beta decay can also investigate several effects of *heavy* sterile neutrinos [Bam95a].

If we assume having a light neutrino with a mass $\ll 1$ eV, mixing with a much heavier ($m \geq 1$ GeV) sterile neutrino can yield under certain

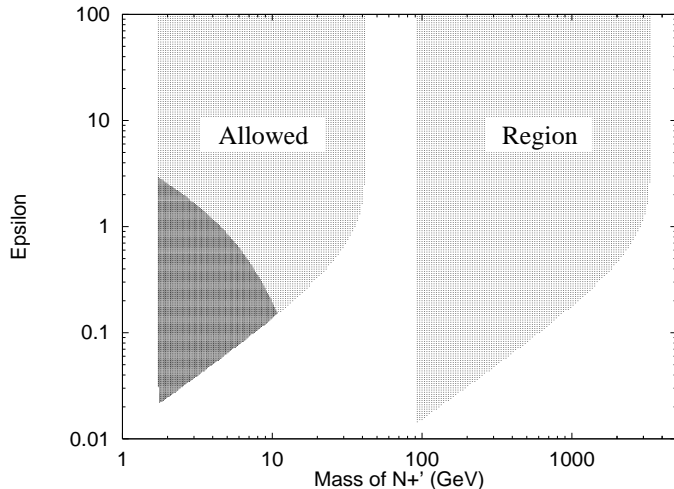

Fig. 10 *Regions of the parameter space ($\epsilon - M_{N'_+}$ plane yielding an observable signal (shaded areas) (from [Bam95a]). Darker area: 'natural' region, lighter shaded: Finetuning needed, to keep m_{ν_e} below 1 eV. $M_{N'_+}$: mass eigenstate, ϵ : strength of lepton number violation in mass matrix*

conditions a detectable signal in current $\beta\beta$ experiments.

In models with two (or more) sterile neutrinos, the sterile neutrinos can mix appreciably even in the limit $m_{\nu_e} \rightarrow 0$ and so can be potentially visible in many processes [Pil93]. Neutrinoless double beta decay proceeds in these models through the virtual exchange of the heavier (i.e. GeV scale or higher) neutrinos. Fig. 10 shows the mass ranges leading to a $0\nu\beta\beta$ signal close to observability (shaded areas).

2.7. Leptoquarks

Interest on leptoquarks (LQ) has been renewed during the last few years since ongoing collider experiments have good prospects for searching these particles [Buc87]. LQs are vector or scalar particles carrying both lepton and baryon numbers and, therefore, have a well distinguished experimental signature. Direct searches of LQs in deep inelastic ep-scattering at HERA [H196] placed lower limits on their mass $M_{LQ} \geq 225 - 275$ GeV, depending on the LQ type and couplings.

In addition to the direct searches on LQs, there are many constraints which can be derived from the study of low-energy processes [Dav94]. Effective 4-fermion interactions, induced by virtual LQ exchange at energies much smaller than their masses, can contribute to atomic parity vi-

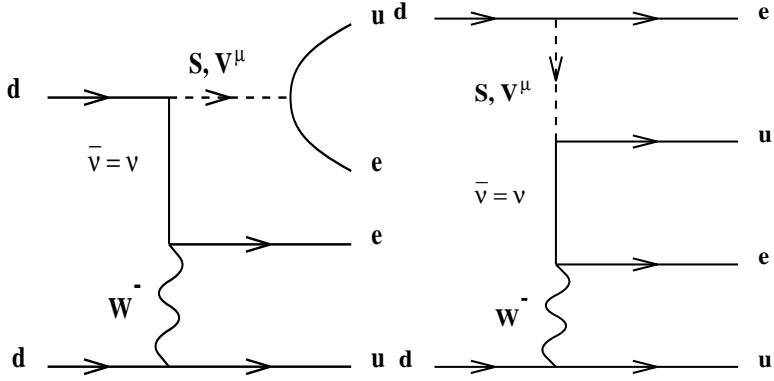

Fig. 11 Examples of Feynman graphs for $0\nu\beta\beta$ decay within LQ models. S and V^μ stand symbolically for scalar and vector LQs, respectively (from [Hir96a]).

olation, flavour-changing neutral current processes, meson decays, meson-antimeson mixing and some rare processes.

To consider LQ phenomenology in a model-independent fashion one usually follows some general principles in constructing the Lagrangian of the LQ interactions with the standard model fields. In order to obey the stringent constraints from (c1) helicity-suppressed $\pi \rightarrow e\nu$ decay, from (c2) FCNC processes and from (c3) proton stability, the following assumptions are commonly adopted: (a1) LQ couplings are chiral, (a2) LQ couplings are generation diagonal, and (a3) there are no diquark couplings.

Recently, however, it has been pointed out [Hir96a] that possible LQ-Higgs interactions spoil assumption (a1): Even if one assumes LQs to be chiral at some high energy scale, LQ-Higgs interactions introduce after electro-weak symmetry breaking mixing between LQ states with different chirality. Since there is no fundamental reason to forbid such LQ-Higgs interactions, it seems difficult to get rid of the unwanted non-chiral interactions in LQ models.

In such LQ models there appear contributions to $0\nu\beta\beta$ decay via the Feynman graphs of Fig. 11. Here, S and V^μ stand symbolically for scalar and vector LQs, respectively. The half-life for $0\nu\beta\beta$ decay arising from leptoquark exchange is given by [Hir96a]

$$T_{1/2}^{0\nu} = |M_{GT}|^2 \frac{2}{G_F^2} [\tilde{C}_1 a^2 + C_4 b_R^2 + 2C_5 b_L^2]. \quad (21)$$

$$\text{with } a = \frac{\epsilon_S}{M_S^2} + \frac{\epsilon_V}{M_V^2}, \quad b_{L,R} = \frac{\alpha_S^{(L,R)}}{M_S^2} + \frac{\alpha_V^{(L,R)}}{M_V^2}, \quad \tilde{C}_1 = C_1 \left(\frac{M_1^{(\nu)}/(m_e R)}{M_{GT} - \alpha_2 M_F} \right)^2.$$

For the definition of the C_n see [Doi85] and for the calculation of the matrix element $\mathcal{M}_1^{(\nu)}$ see [Hir96a]. This allows to deduce information on leptoquark masses and leptoquark–Higgs couplings (see section 3.2).

3. Double Beta Decay Experiments: Present Status and Results

3.1. Present Experimental Status

Fig. 12 shows an overview over measured $0\nu\beta\beta$ half–life limits and deduced mass limits. The largest sensitivity for $0\nu\beta\beta$ decay is obtained at present by active source experiments (source=detector), in particular ^{76}Ge [HM95, HM97, Kla94, Kla97] and ^{136}Xe [Ger96]. The main reason is that large source strengths can be used (simultaneously with high energy resolution), in particular when enriched $\beta\beta$ emitter materials are used. Geochemical experiments, though having contributed important information to double beta decay, have no more future in the sense that their inherent background from $2\nu\beta\beta$ decay cannot be eliminated.

Only a few of the present most sensitive experiments may probe the neutrino mass in the next years into the sub–eV region, the Heidelberg–Moscow experiment being the by far most advanced and most sensitive one, see Fig. 12b. No one of them will pass below $\sim 0.1 - 0.2$ eV (see section 4.1) A detailed discussion of the various experimental possibilities can be found in [Kla95, Kla96, Kla96a]. A useful listing of existing data from the various $\beta\beta$ emitters is given in [Tre95].

3.2. Present limits on beyond standard model parameters

The sharpest limits from $0\nu\beta\beta$ decay are presently coming from the Heidelberg–Moscow experiment [Kla87, HM95, Kla94, HM97, Kla97]. They will be given in the following. With five enriched (86% of ^{76}Ge) detectors of a total mass of 11.5 kg taking data in the Gran Sasso underground laboratory, and with a background of at present 0.07 counts/kg year keV, the experiment has reached its final setup and is now exploring the sub–eV range for the mass of the electron neutrino. Fig. 13 shows the spectrum taken in a measuring time of 31.8 kg y.

Half–life of neutrinoless double beta decay

The deduced half–life limit for $0\nu\beta\beta$ decay is

$$T_{1/2}^{0\nu} > 1.2 \cdot 10^{25} \text{y} \quad (90\%C.L.) \quad (22)$$

$$> 1.9 \cdot 10^{25} \text{y} \quad (68\%C.L.) \quad (23)$$

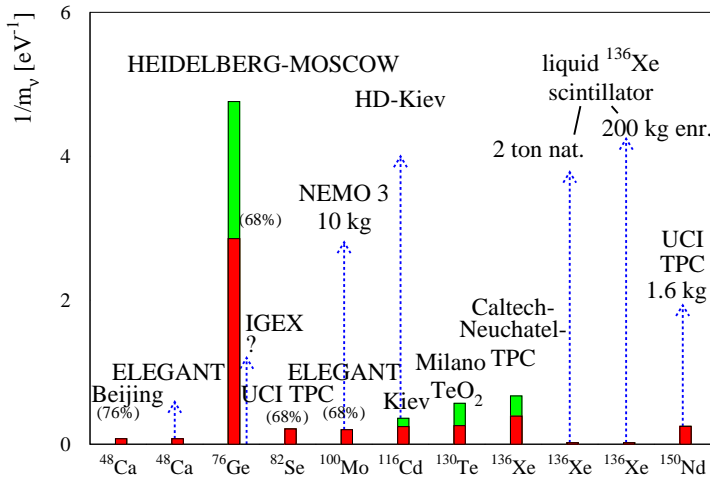
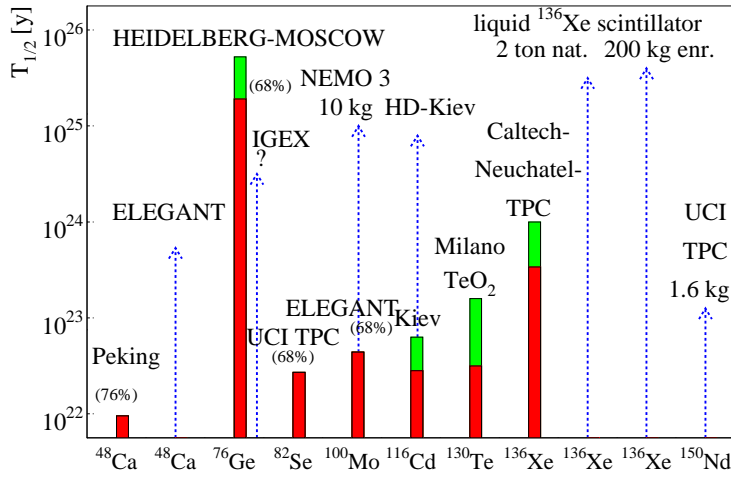

Fig. 12 Present situation, 1996, and expectation for the near future until the year 2000 and beyond, of the most promising $\beta\beta$ -experiments concerning accessible half life (a) and neutrino mass limits (b). The filled bars correspond to the present status, open bars correspond to ‘safe’ expectations for the year 2000 and dashed lines correspond to long-term planned or hypothetical experiments (from [Kla97]).

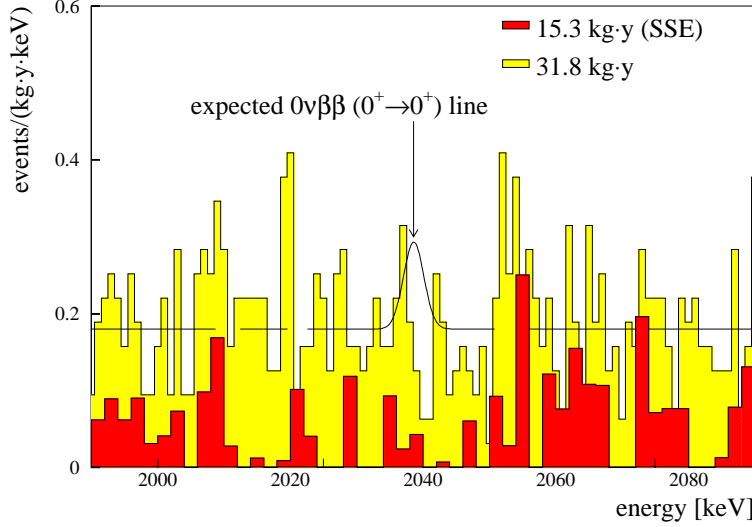

Fig. 13 Integral spectrum in the region of interest after subtraction of the first 200 days of measurement of each detector, leaving 31.8 kg y of measuring time. The solid curve corresponds to the signal excluded with 90% C.L. It corresponds to $T_{1/2}^{0\nu} > 1.2 \cdot 10^{25}$ y. The darkened histogram corresponds to data accumulated meanwhile using a new pulse shape analysis method [Hel96] in a measuring time of 15.3 kg y.

Neutrino mass

Light neutrinos: The deduced upper limit of an (effective) electron neutrino Majorana mass is, with the matrix element from [Sta90]

$$\langle m_\nu \rangle < 0.45 eV \quad (90\% C.L.) \quad (24)$$

$$< 0.35 eV \quad (68\% C.L.) \quad (25)$$

This is the sharpest limit for a Majorana mass of the electron neutrino so far.

Superheavy neutrinos: For a superheavy *left*-handed neutrino we deduce [HM95] exploiting the mass dependence of the matrix element (for the latter

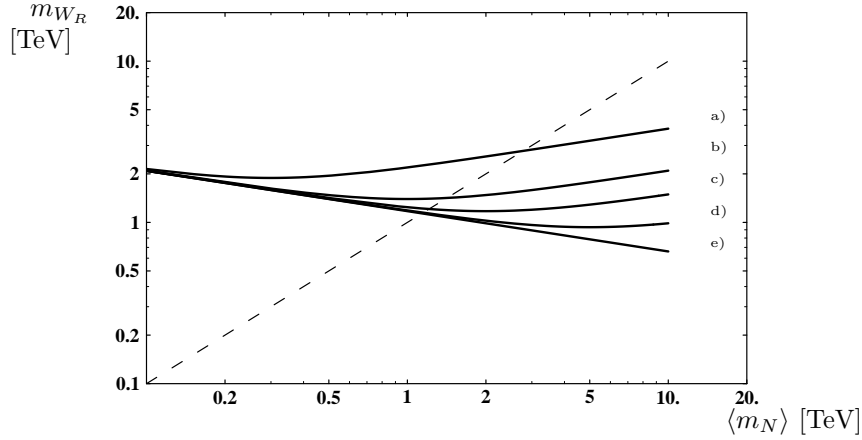

Fig. 14 Limits on the mass of the right-handed W -boson from neutrinoless double beta decay (full lines) and vacuum stability (dashed line). The five full lines correspond to the following masses of the doubly charged higgs, $m_{\Delta^{--}}$: a) 0.3, b) 1.0, c) 2.0, d) 5.0 and e) ∞ [TeV] (from [Hir96d]).

see [Mut89]) a lower limit

$$\langle m_H \rangle \geq 7 \cdot 10^7 GeV \quad (26)$$

For a heavy *right*-handed neutrino the relation obtained to the mass of the right-handed W boson is shown in Fig. 14 (see [Hir96d]).

Right-handed W boson

For the right-handed W boson a lower limit of (Fig. 14)

$$m_{W_R} \geq 1.1 TeV \quad (27)$$

is obtained [Hir96d].

SUSY parameters – R -parity breaking and sneutrino mass

The constraints on the parameters of the minimal supersymmetric standard model with explicit R -parity violation deduced [Hir95, Hir96c, Hir96] from

the $0\nu\beta\beta$ half-life limit are more stringent than those from other low-energy processes and from the largest high energy accelerators (Fig. 15). The limits are

$$\lambda'_{111} \leq 3.9 \cdot 10^{-4} \left(\frac{m_{\tilde{q}}}{100\text{GeV}} \right)^2 \left(\frac{m_{\tilde{g}}}{100\text{GeV}} \right)^{\frac{1}{2}} \quad (28)$$

with $m_{\tilde{q}}$ and $m_{\tilde{g}}$ denoting squark and gluino masses, respectively, and with the assumption $m_{\tilde{d}_R} \simeq m_{\tilde{u}_L}$. This result is important for the discussion of new physics in the connection with the high- Q^2 events seen at HERA. It excludes the possibility of squarks of first generation (of R-parity violating SUSY) being produced in the high- Q^2 events [Cho97, Alt97, Hir97b].

We find further [Hir96]

$$\lambda'_{113}\lambda'_{131} \leq 1.1 \cdot 10^{-7} \quad (29)$$

$$\lambda'_{112}\lambda'_{121} \leq 3.2 \cdot 10^{-6}. \quad (30)$$

For the $(B - L)$ violating sneutrino mass \tilde{m}_M the following limits are obtained [Hir97a]

$$\tilde{m}_M \leq 2 \left(\frac{m_{SUSY}}{100\text{GeV}} \right)^{\frac{3}{2}} \text{GeV}, \quad \chi \simeq \tilde{B} \quad (31)$$

$$\tilde{m}_M \leq 11 \left(\frac{m_{SUSY}}{100\text{GeV}} \right)^{\frac{7}{2}} \text{GeV}, \quad \chi \simeq \tilde{H} \quad (32)$$

for the limiting cases that the lightest neutralino is a pure Bino \tilde{B} , as suggested by the SUSY solution of the dark matter problem [Jun96], or a pure Higgsino. Actual values for \tilde{m}_M for other choices of the neutralino composition should lie in between these two values.

Another way to deduce a limit on the ‘Majorana’ sneutrino mass \tilde{m}_M is to start from the experimental neutrino mass limit, since the sneutrino contributes to the Majorana neutrino mass m_M^ν at the 1-loop level proportional to \tilde{m}_M^2 . This yields under some assumptions [Hir97a]

$$\tilde{m}_{M(i)} \leq (60 - 125) \left(\frac{m_{\nu(i)}^{exp}}{1\text{eV}} \right)^{1/2} \text{MeV} \quad (33)$$

Starting from the mass limit determined for the electron neutrino by $0\nu\beta\beta$ decay this leads to

$$\tilde{m}_{M(e)} \leq 22\text{MeV} \quad (34)$$

This result is somewhat dependent on neutralino masses and mixings. A non-vanishing ‘Majorana’ sneutrino mass would result in new processes at future colliders, like sneutrino-antisneutrino oscillations. Reactions at the Next Linear Collider (NLC) like the SUSY analog to inverse neutrinoless

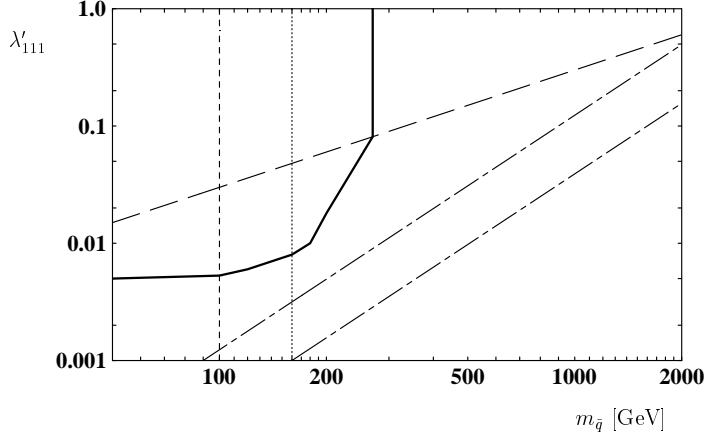

Fig. 15 Comparison of limits on the R -parity violating MSSM parameters from different experiments in the λ'_{111} - $m_{\tilde{g}}$ plane. The dashed line is the limit from charged current universality according to [Bar89]. The vertical line is the limit from the data of Tevatron [Roy92]. The thick full line is the region which might be explored by HERA [But93]. The two dash-dotted lines to the right are the limits obtained from the half-life limit for $0\nu\beta\beta$ decay of ^{76}Ge , for gluino masses of (from left to right) $m_{\tilde{g}} = 1\text{TeV}$ and 100 GeV , respectively. The regions to the upper left of the lines are forbidden. (from [Hir95])

double beta decay $e^-e^- \rightarrow \chi^-\chi^-$ (where χ^- denote charginos) or single sneutrino production, e.g. by $e^-\gamma \rightarrow \tilde{\nu}_e\chi^-$ could give information on the Majorana sneutrino mass, also. This is discussed by [Hir97, Hir97a] and by [Hir97b, Kol97] in these proceedings. A conclusion is that future accelerators can give information on second and third generation sneutrino Majorana masses, but for first generation sneutrinos cannot compete with $0\nu\beta\beta$ -decay.

Compositeness

Evaluation of the $0\nu\beta\beta$ half-life limit assuming exchange of excited Majorana neutrinos ν^* yields for the mass of the excited neutrino a lower bound of [Pan97, Tak97].

$$m_N \geq 3.4m_W \quad (35)$$

for a coupling of order $O(1)$ and $\Lambda_c \simeq m_N$. Here, m_W is the W-boson mass.

Leptoquarks

Assuming that either scalar or vector leptoquarks contribute to $0\nu\beta\beta$ decay, the following constraints on the effective LQ parameters (see section 2.7) can be derived [Hir96a]:

$$\epsilon_I \leq 2.8 \times 10^{-9} \left(\frac{M_I}{100\text{GeV}} \right)^2, \quad (36)$$

$$\alpha_I^{(L)} \leq 3.5 \times 10^{-10} \left(\frac{M_I}{100\text{GeV}} \right)^2, \quad (37)$$

$$\alpha_I^{(R)} \leq 7.9 \times 10^{-8} \left(\frac{M_I}{100\text{GeV}} \right)^2. \quad (38)$$

Here, different effective LQ couplings have been introduced. They are defined as:

$$\begin{aligned} \epsilon_I = 2^{-\eta_I} \left[\lambda_{I_1}^{(L)} \lambda_{\bar{I}_{1/2}}^{(R)} \left(\theta_{43}^I(Q_I^{(1)}) + \eta_I \sqrt{2} \theta_{41}^I(Q_I^{(2)}) \right) \right. \\ \left. - \lambda_{I_0}^{(L)} \lambda_{\bar{I}_{1/2}}^{(R)} \theta_{13}^I(Q_I^{(1)}) \right] \end{aligned} \quad (39)$$

$$\alpha_I^{(L)} = \frac{2}{3 + \eta_I} \lambda_{I_{1/2}}^{(L)} \lambda_{I_1}^{(L)} \theta_{24}^I(Q_I^{(2)}) \quad (40)$$

$$\alpha_I^{(R)} = \frac{2}{3 + \eta_I} \lambda_{I_0}^{(R)} \lambda_{\bar{I}_{1/2}}^{(R)} \theta_{23}^I(Q_I^{(1)}). \quad (41)$$

$\eta_{S,V} = 1, -1$ for scalar and vector LQs. $\theta_{kn}^I(Q)$ is a mixing parameter defined by

$$\theta_{kn}^I(Q) = \sum_l \mathcal{N}_{kl}^{(I)}(Q) \mathcal{N}_{nl}^{(I)}(Q) \left(\frac{M_I}{M_{I_l}(Q)} \right)^2, \quad (42)$$

where $\mathcal{N}^{(I)}(Q)$ are mixing matrix elements which diagonalize the LQ mass matrices for the scalar $I = S$ and vector $I = V$ LQ fields with electric charges $Q = -1/3, -2/3$, for complete definitions see [Hir96a]. Common mass scales M_S of scalar and M_V of vector LQs are introduced for convenience.

Since the LQ mass matrices appearing in $0\nu\beta\beta$ decay are (4×4) matrices [Hir96a], it is difficult to solve their diagonalization in full generality algebraically. However, if one assumes that only one LQ-Higgs coupling is present at a time, the (mathematical) problem is simplified greatly and one can deduce from, for example, eq. (36) that either the LQ-Higgs coupling must be smaller than $\sim 10^{-(4-5)}$ or there can not be any LQ with e.g. couplings of electromagnetic strength with masses below $\sim 250\text{GeV}$.

These bounds from $\beta\beta$ decay are of interest in connection with recently discussed evidence for new physics from HERA [Hew97, Bab97, Kal97, Cho97]. Assuming that actually leptoquarks have been produced at HERA, double beta decay (the Heidelberg–Moscow experiment) would allow to fix the leptoquark–Higgs coupling to a few 10^{-6} [Hir97b]. It may be noted, that after the first consideration of leptoquark–Higgs coupling in [Hir96a] recently Babu et al. [Bab97b] noted that taking into account leptoquark–Higgs coupling reduces the leptoquark mass lower bound deduced by TEVATRON – making it more consistent with the value of 200 GeV required by HERA.

Half-life of $2\nu\beta\beta$ decay

The Heidelberg–Moscow experiment produced for the first time a high statistics $2\nu\beta\beta$ spectrum (~ 20000 counts, to be compared with the 40 counts on which the first detector observation of $2\nu\beta\beta$ decay by [Ell87] (for the decay of ^{82}Se) had to rely. The deduced half-life is [HM97]

$$T_{1/2}^{2\nu} = (1.77_{-0.01}^{+0.01}(\text{stat.})_{-0.11}^{+0.13}(\text{syst.})) \cdot 10^{21}y \quad (43)$$

This result brings $\beta\beta$ research for the first time into the region of ‘normal’ nuclear spectroscopy and allows for the first time statistically reliable investigation of Majoron–accompanied decay modes.

Majoron–accompanied decay

From simultaneous fits of the 2ν spectrum and one selected Majoron mode, experimental limits for the half-lives of the decay modes of the newly introduced Majoron models [Bur96] are given for the first time [Päs96, HM96].

The small matrix elements and phase spaces for these modes [Päs96, Hir96b] already determined that these modes by far cannot be seen in experiments of the present sensitivity if we assume typical values for the neutrino–Majoron coupling constants around $\langle g \rangle = 10^{-4}$ (see table 3).

4. Double Beta Experiments: Future Perspectives – the GENIUS Project

4.1. The known experiments and proposals

Figs. 12a,b show in addition to the present status the future perspectives of the main existing $\beta\beta$ decay experiments and includes some ideas for the future which have been published. The HEIDELBERG–MOSCOW experiment will probe the neutrino mass within 5 years down to the order of 0.1 eV. This limit will be reached taking into account the current background of 0.1 counts/kg y keV in the $0\nu\beta\beta$ region and a further reduction

by digital pulse shape analysis (DPSA) (see [HM97]). The best presently existing limits besides the HEIDELBERG-MOSCOW experiment (filled bars in Fig. 12), have been obtained with the isotopes: ^{48}Ca [You95], ^{82}Se [Ell92], ^{100}Mo [Als89], ^{116}Cd [Dan95], ^{130}Te [Ale94], ^{136}Xe [Vui93] and ^{150}Nd [Moe94]. These and other double beta decay setups presently under construction or partly in operation such as NEMO [NEM94, Bar97], the Gotthard ^{136}Xe TPC experiment [Jör94], the ^{130}Te cryogenic experiment [Ale94], a new ELEGANT ^{48}Ca experiment using 30 g of ^{48}Ca [Kum96], a hypothetical experiment with an improved UCI TPC [Moe94] assumed to use 1.6 kg of ^{136}Xe , etc., will not reach or exceed the ^{76}Ge limits. The goal 0.3 eV aimed at for the year 2004 by the NEMO experiment (see [Piq96, Bar97] and Fig. 12) may even be very optimistic if claims about the effect of proton-neutron pairing on the $0\nu\beta\beta$ nuclear matrix elements by [Pan96b] will turn out to be true, and also if the energy resolution will not be improved considerably (see Fig. 1 in [Tre95]). Therefore, the conclusion given by [Bed97c] concerning the future SUSY potential of NEMO has no serious basis. As pointed out by Raghavan [Rag94], even use of an amount of about 200 kg of enriched ^{136}Xe or 2 tons of natural Xe added to the scintillator of the KAMIOKANDE detector or similar amounts added to BOREXINO (both primarily devoted to solar neutrino investigation) would hardly lead to a sensitivity larger than the present ^{76}Ge experiment. This idea is going to be realized at present by the KAMLAND experiment [Suz97]. An interesting future candidate was for some time a ^{150}Nd bolometer exploiting the relatively large phase space of this nucleus (see [Moe94]). The way outlined by [Moe91] proposing a TPC filled with 1 ton of liquid enriched ^{136}Xe and identification of the daughter by laser fluorescence seems not be feasible in a straight-forward way. However, another way of using liquid ^{136}Xe may be more promising [Cli97].

It is obvious that, from the experiments and proposals, the HEIDELBERG-MOSCOW experiment will give the sharpest limit for the electron neutrino mass for the next decade. It is also obvious from Fig. 12 that *none* of the present experimental approaches, or plans or even vague ideas has a chance to surpass the border of 0.1 eV for the neutrino mass to lower values (see also [Nor97]). At present there is only one way visible to reach the domain of lower neutrino masses, suggested by the author of this report and meanwhile investigated in some detail concerning its experimental realization and physics potential in [Kla97d, Hel97].

4.2. Genius – A Future Large Scale Double Beta and Dark Matter Experiment

The idea of GENIUS is to use a large amount of ‘naked’ enriched GERmanium detectors in liquid NITrogen as shielding in an UndergrounD Setup. Use of 1 (in an extended version 10) tons of enriched ^{76}Ge will

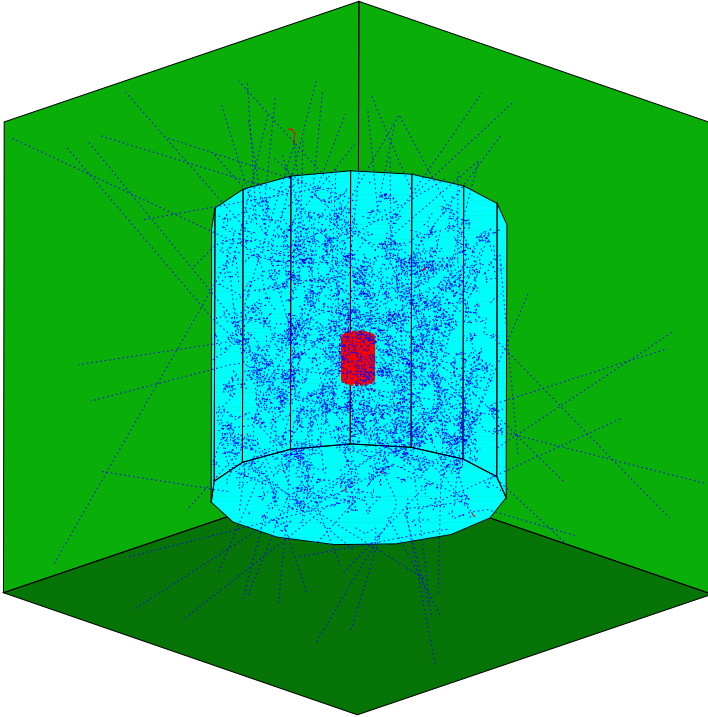

Fig. 16 *Simplified model of the GENIUS experiment: 288 enriched ^{76}Ge detectors with a total of one ton mass in the center of a 9 m high liquid nitrogen tank with 9 m diameter; GEANT Monte Carlo simulation of 1000 2.6 MeV photons randomly distributed in the nitrogen is also shown.*

increase the source strength largely, removing all material from the vicinity of the detectors and shielding by liquid nitrogen will lead to a drastic background reduction compared to the present level. Using Ge detectors in liquid nitrogen has been discussed already earlier [Heu95]. That Ge detectors can be operated in liquid nitrogen has been demonstrated recently in the Heidelberg low level laboratory [Hel97]. The natural site for GENIUS would be the Gran Sasso underground laboratory. The cost of the project would be a minor fraction of detectors prepared for LHC physics as CMS or ATLAS. We give in the next two subsections some results of Monte Carlo simulations of the setup [Hel97] and some estimates of the physics potential [Kla97d].

4.2.1. Realization and Sensitivity of GENIUS A simplified model of GENIUS is shown in Fig. 16 consisting of about 300 enriched ^{76}Ge detectors

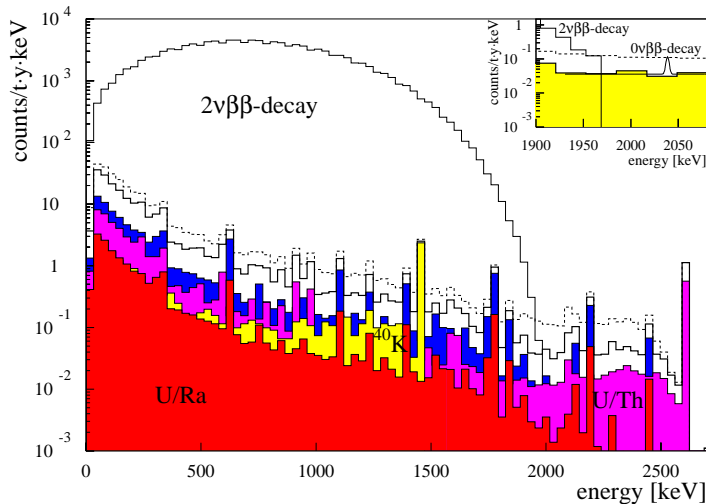

Fig. 17 Monte Carlo simulation of the background of GENIUS. Simulations of U/Ra, U/Th and ^{40}K (shaded), ^{222}Rn (black histogram) activities in the liquid nitrogen; the sum of the activities is shown with anticoincidence between the 288 detectors (thick line) and without (dashed line); the $2\nu\beta\beta$ -decay dominates the spectrum with 4 million events per year. (from [Hel97])

with a total of one ton mass in the center of a 9 m high liquid nitrogen tank with 9 m diameter. Figs. 17, 18 show the results of Monte Carlo simulations, using the CERN GEANT code, of the background [Hel97], starting from purity levels of the nitrogen being in general an order of magnitude less stringent than those already achieved in the CTF for the BOREXINO experiment. The influence of muons penetrating the Gran Sasso rock on the background can be reduced comfortably through coincidences between the Germanium detectors from the muon induced showers. The count rate in the region of interest for neutrinoless double beta decay is 0.04 counts/keV · y · ton (Fig. 17). Below 100 keV the background count rate is about 10 counts/keV · y · ton. Two neutrino double beta decay would dominate the spectrum with $4 \cdot 10^6$ events per year.

Starting from these numbers, a lower half-life limit of

$$T_{1/2}^{0\nu} \geq 5.8 \cdot 10^{27} \quad (68\%C.L.) \quad (44)$$

can be reached within one year of measurement (following the highly conservative procedure for analysis recommended by [PDG94], which has been used also in the derivation of the results given in section 3.2, but is not used in the analysis of several other $\beta\beta$ experiments). This corresponds –

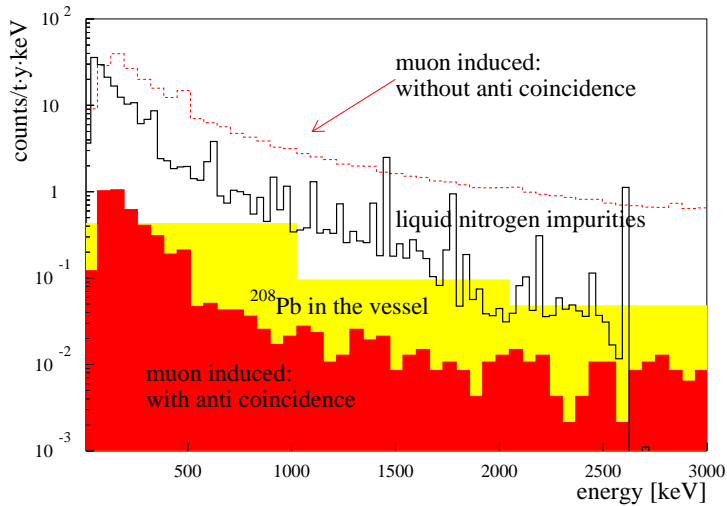

Fig. 18 Background from outside the nitrogen: 200 GeV muons induced events (dashed line) and single hit events (filled histogram); decay of ^{208}Tl in the steel vessel (light shaded histogram) and the background originating from the nitrogen impurities for comparison (thick line) (from [Hel97])

with the matrix elements of [Sta90] – to an upper limit on the neutrino mass of

$$\langle m_\nu \rangle \leq 0.02eV \quad (68\%C.L.) \quad (45)$$

Figure 19 shows the obtainable limits on the neutrino mass in the case of zero background. This assumption might be justified since our assumed impurity concentrations are still more conservative than proved already now for example by Borexino. The final sensitivity of the experiment can be defined by the limit, which would be obtained after 10 years of measurement. For the one ton experiment this would be:

$$T_{1/2}^{0\nu} \geq 6.4 \cdot 10^{28} y \quad (\text{with } 68\% \text{ C.L.}) \quad (46)$$

and

$$\langle m_\nu \rangle \leq 0.006eV \quad (\text{with } 68\% \text{ C.L.}) \quad (47)$$

The ultimate experiment could test the $0\nu\beta\beta$ half life of ^{76}Ge up to a limit of $5.7 \cdot 10^{29}y$ and the neutrino mass down to $2 \cdot 10^{-3}eV$ using 10 tons of enriched Germanium.

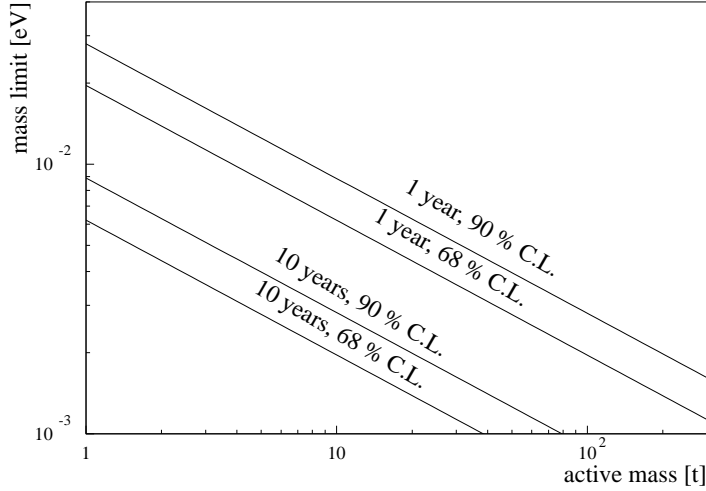

Fig. 19 Mass limits on Majorana neutrino mass after one and ten years measuring time as function of the active detector mass; zero background is assumed (from [Hel97])

4.2.2. The Physics Potential of GENIUS

Neutrino mass textures and neutrino oscillations: GENIUS will allow a large step in sensitivity for probing the neutrino mass. It will allow to probe the neutrino mass down to $10^{-(2-3)}$ eV, and thus surpass the existing neutrino mass experiments by a factor of 50-500. GENIUS will test the structure of the neutrino mass matrix and thereby also neutrino oscillation parameters ¹ superior in sensitivity to the best proposed dedicated terrestrial neutrino oscillation experiments. Even in the first stage GENIUS will confirm or rule out degenerate or inverted neutrino mass scenarios,

¹ The double beta observable, the effective neutrino mass (eq. 10), can be expressed in terms of the usual neutrino oscillation parameters, once an assumption on the ratio of m_1/m_2 is made. E.g., in the simplest two-generation case

$$\langle m_\nu \rangle = |c_{12}^2 m_1 + s_{12}^2 m_2 e^{2i\beta}|, \quad (48)$$

assuming CP conservation, i.e. $e^{2i\beta} = \eta = \pm 1$, and $c_{12}^2 m_1 \ll \eta s_{12}^2 m_2$,

$$\Delta_{m_{12}}^2 \simeq m_2^2 = \frac{4\langle m_\nu \rangle^2}{1 - \sqrt{1 - \sin^2 2\theta}} \quad (49)$$

A little bit more general, keeping corrections of the order (m_1/m_2) one obtains

$$m_2 = \frac{\langle m_\nu \rangle}{\left| \left(\frac{m_1}{m_2} \right) + \frac{1}{2} (1 - \sqrt{1 - \sin^2 2\theta}) \left(\pm 1 - \left(\frac{m_1}{m_2} \right) \right) \right|}. \quad (50)$$

For the general case see [Kla97d].

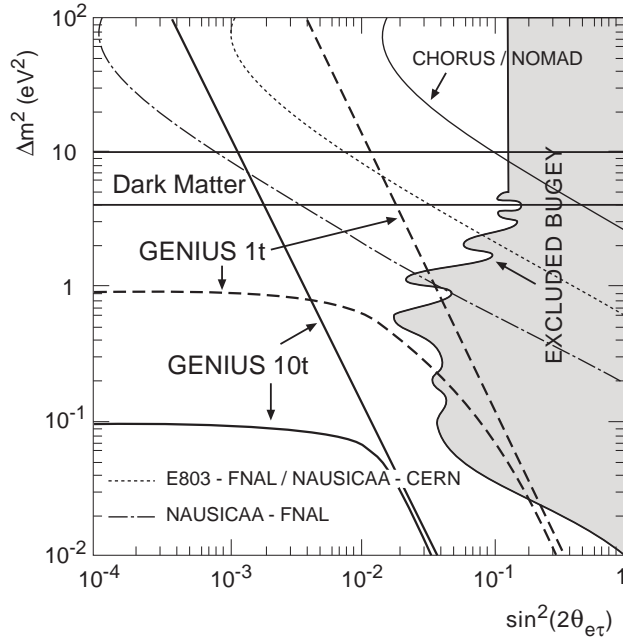

Fig. 20 Current limits and future experimental sensitivity on $\nu_e - \nu_\tau$ oscillations. The shaded area is currently excluded from reactor experiments. The thin line is the estimated sensitivity of the CHORUS/NOMAD experiments. The dotted and dash-dotted thin lines are sensitivity limits of proposed accelerator experiments, NAUSICAA and E803-FNAL [Gon95]. The thick lines show the sensitivity of GENIUS (broken line: 1 t, full line: 10 t), for two examples of mass ratios. The straight lines are for the strongly hierarchical case ($R=0$), while the lines bending to the left assume $R=0.01$. (from [Kla97d])

discussed in the literature as possible solutions of current hints to finite neutrino masses, and also test the $\nu_e \leftrightarrow \nu_\mu$ hypothesis of the atmospheric neutrino problem. If the 10^{-3} eV level is reached, GENIUS will even allow to test the large angle MSW solution of the solar neutrino problem. It will also allow to test the hypothesis of a shadow world underlying introduction of a sterile neutrino mentioned in section 2.1. The figures 20–24 show some examples of this potential. Fig 20 compares the potential of GENIUS with the sensitivity of CHORUS/NOMAD and with the proposed future experiments NAUSICAA–CERN and NAUSICAA–FNAL, looking for $\nu_e \leftrightarrow \nu_\tau$ oscillations, for different assumptions on m_1/m_2 .

Already in the worst case for double beta decay of $m_1/m_2 = 0$ GENIUS

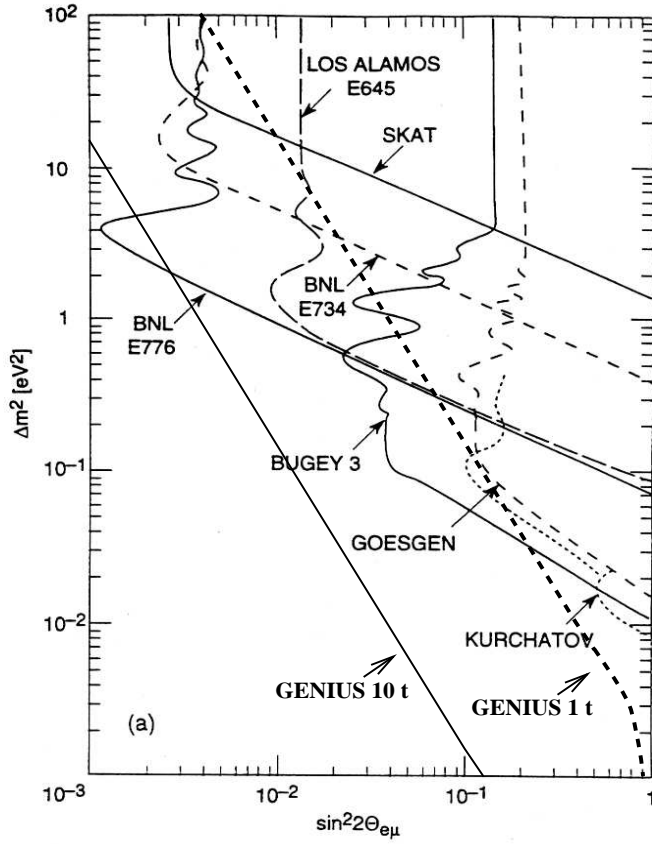

Fig. 21 Current limits on $\nu_e - \nu_\mu$ oscillations. Various existing experimental limits from reactor and accelerator experiments are indicated, as summarized in ref. [Gel95]. In addition, the figure shows the expected sensitivities for GENIUS with 1 ton (thick broken line) and GENIUS with 10 tons (thick, full line) (from [Kla97d])

1 ton is more sensitive than the running CERN experiments. For quasi-degenerate models, for example $R = 0.01$ already, GENIUS 1 ton would be more sensitive than all currently planned future accelerator neutrino experiments.

The situation of $\nu_e \leftrightarrow \nu_\mu$ oscillations (assuming $\sin^2\theta_{13} = 0$) is shown in Fig. 21. The original figure is taken from [Gel95]. While the GENIUS 1 ton sensitivity is sufficient (even in the worst case of $m_{\nu_e} \ll m_{\nu_\mu}$) to extend to smaller values of Δm^2 at large mixing angles, GENIUS 10

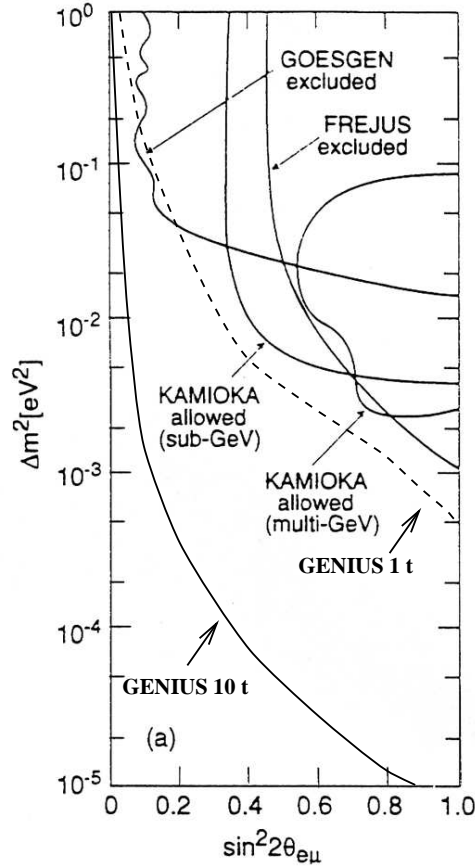

Fig. 22 Oscillation parameters which solve the atmospheric neutrino problem for $\nu_e \leftrightarrow \nu_\mu$ oscillations. In addition the best currently existing reactor constraints are shown. GENIUS would be able to test the atmospheric neutrino problem already with 1 ton, already in the shown, worst strong hierarchy scenario ($m_1/m_2 = 0$) (from [Kla97d]).

ton would have a sensitivity better than all existing or planned oscillation experiments, at least at large $\sin^2 2\theta$. In the quasi-degenerate models GENIUS would be much more sensitive – similar to the cases shown in Fig. 20. Fig. 22 (background from [Gel95]) compares the double beta worst case of strong hierarchy ($m_1/m_2 = 0$), to the KAMIOKANDE allowed range for atmospheric neutrino oscillations. GENIUS 1 ton would already be able to test the $\nu_e \leftrightarrow \nu_\mu$ oscillation hypothesis. Fig. 23 shows the poten-

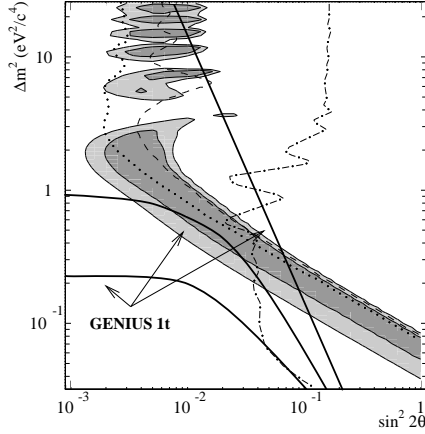

Fig. 23 *LSND compared to the sensitivity of GENIUS 1t for $\eta^{CP} = +1$ and three ratios R_{12} , from top to bottom $R_{12} = 0, 0.01, 0.02$ (from [Kla97d])*

tial of GENIUS for checking the LSND indication for neutrino oscillations (original figure from [Ath96]). Under the assumption $m_1/m_2 \geq 0.02$ and $\eta = 1$, GENIUS 1 ton will be sufficient to find $0\nu\beta\beta$ decay if the LSND result is to be explained in terms of $\nu_e \leftrightarrow \nu_\mu$ oscillations. This might be of particular interest also since the upgraded KARMEN will not completely cover [Dre97] the full allowed LSND range. Fig. 24 shows a summary of currently known constraints on neutrino oscillation parameters (original taken from [Hat94]), but including the $0\nu\beta\beta$ decay sensitivities of GENIUS 1 ton and GENIUS 10 tons, for different assumptions on m_1/m_2 (and for $\eta^{CP} = +1$). It is seen that already GENIUS 1 ton tests all degenerate or quasi-degenerate ($m_1/m_2 \geq \sim 0.01$) neutrino mass models in any range where neutrinos are interesting for cosmology, and also the atmospheric neutrino problem, if it is due to $\nu_e \leftrightarrow \nu_\mu$ oscillations. GENIUS in its 10 ton version would directly test the large angle solution of the solar neutrino problem.

GENIUS and left-right symmetry: If GENIUS is able to reach down to $\langle m_\nu \rangle \leq 0.01$ eV, it would at the same time be sensitive to right-handed W -boson masses up to $m_{W_R} \geq 8$ TeV (for a heavy right-handed neutrino mass of 1 TeV) or $m_{W_R} \geq 5.3$ TeV (at $\langle m_N \rangle = m_{W_R}$). Such a limit would be comparable to the one expected for LHC, see for example [Riz96], which quotes a final sensitivity of something like 5 – 6 TeV. Note, however that in order to obtain such a limit the experiments at LHC need to accumulate about $100fb^{-1}$ of statistics. A 10 ton version of GENIUS could even reach a sensitivity of $m_{W_R} \geq 18$ TeV (for a heavy right-handed neutrino mass of

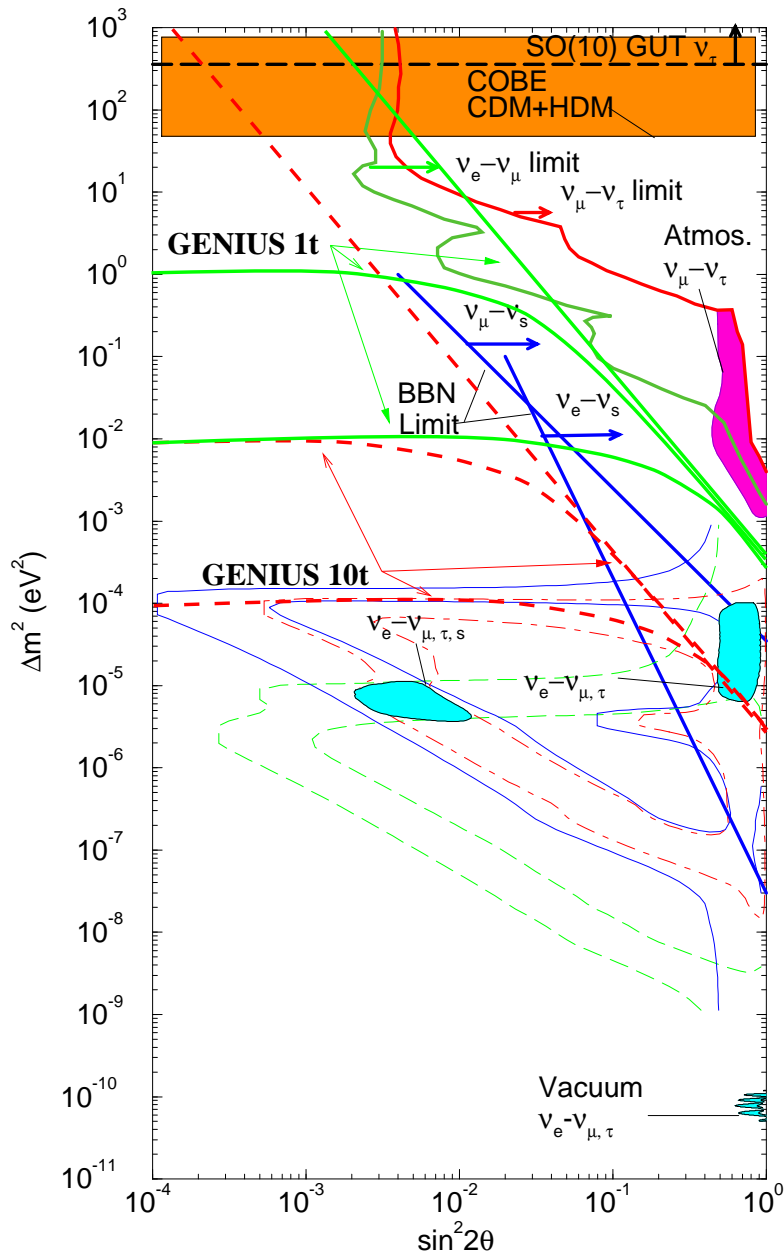

Fig. 24 Summary of currently known constraints on neutrino oscillation parameters. The (background) figure without the $0\nu\beta\beta$ decay constraints can be obtained from <http://dept.physics.upenn.edu/~www/neutrino/solar.html>. Shown are the vacuum and MSW solutions (for two generations of neutrinos) for the solar neutrino problem, the parameter range which would solve the atmospheric neutrino problem and various reactor and accelerator limits on neutrino oscillations. In addition, the mass range in which neutrinos are good hot dark matter candidates is indicated, as well as limits on neutrino oscillations into sterile states from considerations of big bang nucleosynthesis. Finally the thick lines indicate the sensitivity of GENIUS (full lines 1 ton, broken lines 10 ton) to neutrino oscillation parameters for three values of neutrino mass ratios $R = 0, 0.01$ and 0.1 (from top to bottom). The region beyond the lines would be excluded. While already the 1 ton GENIUS would be sufficient to constrain degenerate and quasi-degenerate neutrino mass models, and also would solve the atmospheric neutrino problem if it is due to $\nu_e \leftrightarrow \nu_\mu$ oscillations, the 10 ton version of GENIUS could cover a significant new part of the parameter space, including the large angle MSW solution to the solar neutrino problem, even in the worst case of $R = 0$.

1 TeV) or $m_{W_R} \geq 10.1$ TeV (at $\langle m_N \rangle = m_{W_R}$).

This means that already GENIUS 1 ton could be sufficient to definitely test recent supersymmetric left–right symmetric models having the nice features of solving the strong CP problem without the need for an axion and having automatic R–parity conservation [Kuc95, Moh96].

GENIUS and R_p -violating SUSY: The improvement on the R–parity breaking Yukawa coupling λ'_{111} (see section 2.2) is shown in Fig. 25, which updates Fig. 15. The full line to the right is the expected sensitivity of the LHC – in the limit of large statistics. The three dashed–dotted lines denote (from top to bottom) the current constraint from the Heidelberg–Moscow experiment and the sensitivity of GENIUS 1 ton and GENIUS 10 tons, all for the conservative case of a gluino mass of 1 TeV. If squarks would be heavier than 1 TeV, LHC could not compete with GENIUS. However, for typical squark masses below 1 TeV, LHC could probe smaller couplings. However, one should keep in mind, that LHC can probe squark masses up to 1 TeV only with several years of data taking.

GENIUS and R_p -conserving SUSY: Since the limits on a ‘Majorana–like’ sneutrino mass \tilde{m}_M scale with $(T_{1/2})^{1/4}$, GENIUS 1 ton (or 10 tons) would test ‘Majorana’ sneutrino masses lower by factors of about 7(20), compared with present constraints [Hir97, Hir97a, Hir97b].

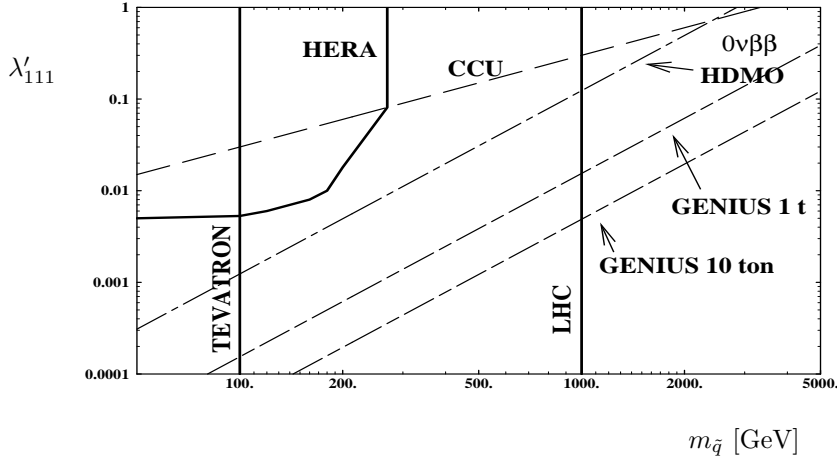

Fig. 25 Comparison of sensitivities of existing and future experiments on R_p SUSY models in the plane $\lambda'_{111} - m_{\bar{q}}$. Note the double logarithmic scale! Shown are the areas currently excluded by the experiments at the TEVATRON, the limit from charged-current universality, denoted by CCU, and the limit from absence of $0\nu\beta\beta$ decay from the Heidelberg-Moscow collaboration ($0\nu\beta\beta$ HDMO). In addition, the estimated sensitivity of HERA and the LHC is compared to the one expected for GENIUS in the 1 ton and the 10 ton version. The figure is essentially an update of Fig. 15.

GENIUS and Leptoquarks: Limits on the lepton-number violating parameters defined in sections 2.7, 3.2 improve as $\sqrt{T_{1/2}}$. This means that for leptoquarks in the range of 200 GeV LQ-Higgs couplings down to (a few) 10^{-8} could be explored. In other words, if leptoquarks interact with the standard model Higgs boson with a coupling of the order $\mathcal{O}(1)$, either $0\nu\beta\beta$ must be found, or LQs must be heavier than (several) 10 TeV.

GENIUS and composite neutrinos GENIUS in the 1(10) ton version would improve the limit on the excited Majorana neutrino mass deduced from the Heidelberg-Moscow experiment (eq. 32) to

$$m_N \gtrsim 1.1(2.3) \text{ TeV} \quad (51)$$

4.2.3. The potential of GENIUS for Cold Dark Matter Search Weakly interacting massive particles (WIMPs) are candidates for the cold dark matter in the universe. The favorite WIMP candidate is the lightest supersymmetric particle, presumably the neutralino. The expected detection rates

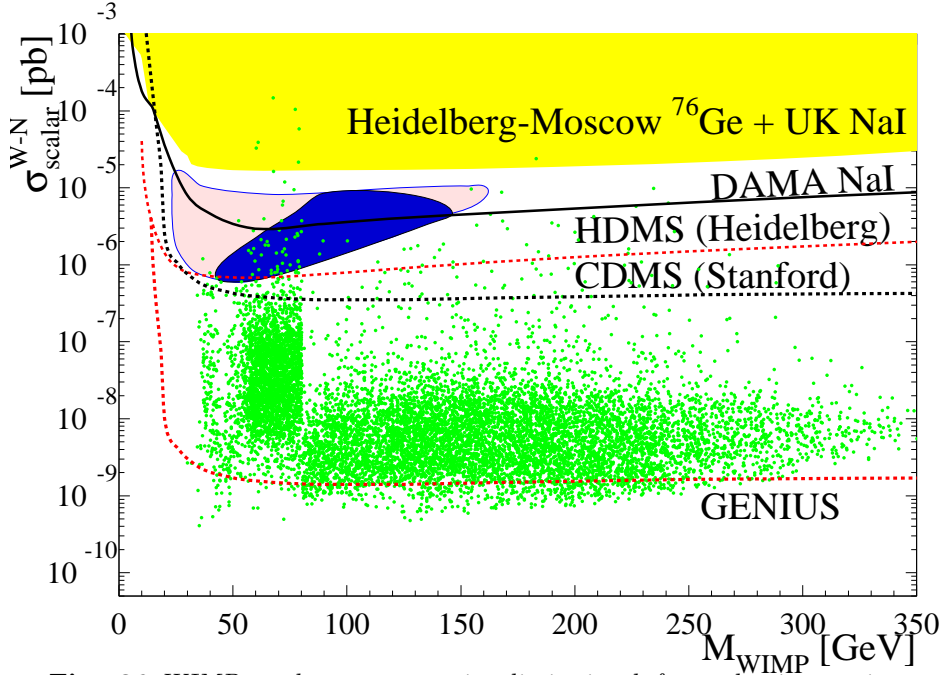

Fig. 26 *WIMP–nucleon cross section limits in pb for scalar interactions as function of the WIMP–mass in GeV (hatched region: excluded by the Heidelberg–Moscow collaboration [HM94] and the UKDMC NaI experiment [Sm96]; solid line: DAMA result for NaI, see [Ber97]). Further shown are sensitivities of experiments under construction (dashed lines for HDMS [Bau97,Kla97e], CDMS [Bar96] and for GENIUS). These limits are compared to theoretical expectations (scatter plot) for WIMP–neutralino cross sections calculated in the MSSM framework with non–universal scalar mass unification [Bed97b]. The 90 % allowed region claimed by [Ber97a] (light filled area), which is further restricted by indirect dark matter searches [Bot97] (dark filled area), could already be easily tested with a 100 kg version of the GENIUS experiment.*

for neutralinos of typically less than one event per day and kg of detector mass [Bed94, Bed97a, Bed97b, Jun96], however, make direct searches for WIMP scattering experimentally a formidable task.

Fig. 26 shows a comparison of existing constraints and future sensitivities of cold dark matter experiments, together with the theoretical expectations for neutralino scattering rates [Bed97b]. Obviously, GENIUS

could easily cover the range of positive evidence for dark matter recently claimed by DAMA [Ber97a, Bot97]. It would also be by far more sensitive than all other dark matter experiments at present under construction or proposed, like the cryogenic experiment CDMS. Furthermore, obviously GENIUS will be the only experiment, which could seriously test the MSSM predictions over the whole SUSY parameter space. In this way, GENIUS could compete even with LHC in the search for SUSY, see for example the discussion in [Bae97].

It is interesting to note, that if WIMP scattering is found by GENIUS it could be used to constrain the amount of R-parity violation within supersymmetric models. The arguments are very simple [Hir97c]. Due to the fact that neutralinos are abundant in the galaxy even today, neutralino decays via R-parity violating operators would have to be highly suppressed.

The details depend, of course, on the neutralino mass and composition. However, finding the neutralino with GENIUS would imply typical limits on R-parity violating couplings of the order of $10^{-(16-20)}$ for any of the λ_{ijk} , λ'_{ijk} or λ''_{ijk} in the superpotential (eq. 11). A positive result of the CDM search at hand, one could thus finally safely conclude that R-parity is conserved.

5. Conclusion

Double beta decay has a broad potential for providing important information on modern particle physics beyond present and future high energy accelerator energies which will be competitive for the next decade and more. This includes SUSY models, compositeness, left-right symmetric models, leptoquarks, and the neutrino and sneutrino mass. Based to a large extent on the theoretical work of the Heidelberg Double Beta group, results have been deduced from the HEIDELBERG-MOSCOW experiment for these topics and have been presented here. For the neutrino mass double beta decay now is particularly pushed into a key position by the recent possible indications of beyond standard model physics from the side of solar and atmospheric neutrinos, dark matter COBE results and others. New classes of GUTs basing on degenerate neutrino mass scenarios which could explain these observations, can be checked by double beta decay in near future. The HEIDELBERG-MOSCOW experiment has reached a leading position among present $\beta\beta$ experiments and as the first of them now yields results in the sub-eV range. We have presented a new idea and proposal of a future double beta experiment (GENIUS) with highly increased sensitivity based on use of 1 ton or more of enriched ‘naked’ ^{76}Ge detectors in liquid nitrogen. This new experiment would be a breakthrough into the multi-TeV range for many beyond standard models. The sensitivity for the neutrino mass would reach down to 0.01 or even 0.001 eV. The experiment would be

competitive to LHC with respect to the mass of a right-handed W boson, in search for R-parity violation and others, and would improve the lepto-quark and compositeness searches by considerable factors. It would probe the Majorana electron sneutrino mass more sensitive than NLC (Next Linear Collider). It would yield constraints on neutrino oscillation parameters far beyond all present terrestrial $\nu_e - \nu_x$ neutrino oscillation experiments and could test directly the atmospheric neutrino problem and the large angle solution of the solar neutrino problem. GENIUS would cover the full SUSY parameter space for prediction of neutralinos as cold dark matter and compete in this way with LHC in the search for supersymmetry. Even if SUSY would be first observed by LHC, it would still be fascinating to verify the existence and properties of neutralino dark matter, which could be achieved by GENIUS. Concluding GENIUS has the ability to provide a major tool for future particle- and astrophysics.

Finally it may be stressed that the technology of producing and using enriched high purity germanium detectors, which have been produced for the first time for the Heidelberg-Moscow experiment, has found meanwhile applications also in pre-GENIUS dark matter search [HM94, Fal94, Kla97e, Bau97] and in high-resolution γ -ray astrophysics, using balloons and satellites [Kla91, Kla94, Bar93, Bar94, Boc94, Kla97b].

References

- [Abe94] F. Abe *et al.* (CDF Collab.), Phys. Rev. Lett. **72** (1994) 3004
- [Adr92] O. Adriani *et al.*, Phys. Lett. **B 288** (1992) 404
- [ALE92] ALEPH Collab., Phys. Rep. 216 (1992) 343
- [ALE93] ALEPH Collab., Z.Phys. **C 59** (1993) 215
- [Ale94] A. Alessandrello *et al.*, Phys. Lett **B 335** (1994) 519
- [Als89] M. Alston-Garnjost *et al.*, Phys. Rev Lett. **71** (1993) 831
- [Alt97] G. Altarelli, J. Ellis, G.F. Giudice, S. Lola, M.L. Mangano, preprint hep-ph/9703276
- [Ath95] C. Athanassopoulos *et al.* (LSND-Collaboration), Phys. Rev. Lett. **75** (1995) 2650 and D. Smith, in [Kla96]
- [Ath96] C. Athanassopoulos *et al.*, LSND collab., Phys. Rev. **C 54** (1996) 2685, Phys. Rev. Lett. **77** (1996) 3082
- [Aul82] C.S. Aulakh and R.N. Mohapatra, Phys. Lett. **B 119** (1982) 136
- [Bab95] K.S. Babu, R.N. Mohapatra, Phys. Rev. Lett. **75** (1995) 2276
- [Bab97] K.S. Babu *et al.*, preprint hep-ph/9703299 (March 1997)
- [Bab97b] K.S. Babu *et al.*, preprint hep-ph/9705414v2 (1997)
- [Bae97] H. Baer, M. Bhrlík, hep-ph/9706509

- [Bam95a] P. Bamert, C.P. Burgess, R.N. Mohapatra, Nucl. Phys. B 438 (1995) 3
- [Bam95] P. Bamert, C.P. Burgess, R.N. Mohapatra, Nucl. Phys. B **449** (1995) 25
- [Bar89] V. Barger, G.F. Giudice, T. Han. Phys.Rev. D **40** (1989) 2987
- [Bar93] S.D. Barthelmy *et al.*, AIP Conf. Proc. 280 (1993) 1166
- [Bar94] S. D. Barthelmy *et al.*, Astrophys. J. **427** (1994) 519
- [Bar96] P.B. Barnes *et al.*, Nucl. Instr. Meth. A **370** (1996) 233
- [Bar97] A.S. Barabash, Proc. NEUTRINO 96, Helsinki, June 1996, World Scientific, Singapore (1997), p. 374
- [Bau97] L. Baudis, J. Hellmig, H.V. Klapdor-Kleingrothaus, A. Müller, F. Petry, Y. Ramachers, H. Strecker, Nucl. Inst. Meth. A **385** (1997) 265
- [Bav95] E. Bayer, M. Leurer, Phys. Rev. D **51** (1995) 260
- [Bed94] V. Bednyakov, H.V. Klapdor-Kleingrothaus, S.G. Kovalenko, Phys. Lett. B **329** (1994) 5 and Phys. Rev. D **50** (1994) 7128
- [Bed97a] V. Bednyakov, H.V. Klapdor-Kleingrothaus, S.G. Kovalenko, Phys. Rev. D **55** (1997) 503
- [Bed97b] V. Bednyakov, H.V. Klapdor-Kleingrothaus, S.G. Kovalenko, Y. Ramachers, Z. Phys. A **357** (1997) 339
- [Bed97c] V. Bednyakov, V.B. Brudanin, S.G. Kovalenko, Ts. D. Vylov, Mod. Phys. Lett A **12** (1997) 233
- [Bel95] G. Belanger, F. Boudjema, D.London, H. Nadeau, Preprint hep-ph/9508317, August 1995
- [Ber92] Z.G. Berezhiani, A. Yu. Smirnov, J.W.F. Valle, Phys.Lett. B **291** (1992) 99
- [Ber95] Z. Berezhiani, R.N. Mohapatra, Phys. Rev. D **52** (1995) 6607
- [Ber97] R. Bernabei *et al.*, Phys. Lett. B **389** (1997) 757
- [Ber97a] R. Bernabei *et al.*, ROM2F/97/33; P. Belli at TAUP, Gran Sasso, Sept. 7 (1997)
- [Bha97] G. Bhattacharyya, in [Kla98]
- [Blü94] J. Blümlein, E. Boos, A. Pukhov, preprint DESY 94-072 (April 1994)
- [Boc94] J. Bockholt, H.V. Klapdor-Kleingrothaus, Nucl. Phys. B (Proc. Suppl.) **35** (1994) 403
- [Bot97] A. Bottino *et al.*, hep-ph/9709292
- [Buc87] W. Buchmüller, R. Rückl and D. Wyler, Phys.Lett. B191 (1987) 442.
- [Buc91] W. Buchmüller and G. Ingelman, Proc. Workshop Physics at HERA, Hamburg, Oct. 29–30 (1991)
- [Bur93] C.P. Burgess, J.M. Cline, Phys. Lett. B **298** (1993) 141; Phys. Rev. D **49** (1994) 5925

- [Bur96] C.P.Burgess, in [Kla96]
- [But93] J. Butterworth, H. Dreiner, Nucl. Phys. **B397** (1993) 3 and H. Dreiner, P. Morawitz, Nucl. Phys. **B428** (1994) 31
- [Cal93] D.O. Caldwell, R.N. Mohapatra, Phys. Rev. **D 48** (1993) 3259
- [Cal95] D.O. Caldwell, R.N. Mohapatra, Phys. Lett. **354** (1995) 371
- [Car93] C.D. Carone, Phys. Lett. **B 308** (1993) 85
- [CDF91] CDF Collab., Phys. Rev. Lett. **67** (1991) 2148
- [Chi81] Y. Chikashige, R.N. Mohapatra and R.D. Peccei, Phys. Lett. **B 98** (1981) 265; Phys. Rev. Lett. **45** (1980) 265
- [Cho94] D. Choudhury, hep-ph/9408250 (1994)
- [Cho97] D. Choudhury, S. Raychaudhuri, preprint hep-ph/9702392
- [Cli97] D. Cline, in: Proceedings of the *International Workshop Dark Matter in Astro- and Particle Physics* (DARK96), Eds. H.V. Klapdor-Kleingrothaus, Y. Ramachers, World Scientific 1997, p. 479
- [Dan95] F. A. Danevich et al., Phys. Lett. **B 344** (1995) 72
- [Dav94] S. Davidson, D. Bailey and A. Campbell, Z.Phys. C61 (1994) 613; M. Leurer, Phys.Rev.Lett. 71 (1993) 1324; Phys.Rev. D50 (1994) 536.
- [Der95] M. Derrick, *et al.* (ZEUS Collab.), Z. Phys. **C 65** (1995) 627
- [Dia93] J.L. Diaz Cruz, O.A. Sampayo, Phys. Lett. **B 306** (1993) 395; Phys. Rev. **D 49** (1994) R2149
- [Doi85] M. Doi, T. Kotani, E.Takasugi, Progr. Theor. Phys. Suppl. **83** (1985) 1
- [Doi93] M. Doi, T. Kotani, Progr. Theor. Phys. 89 (1993) 139
- [Dre97] G. Drexlin, Proc. Internat. School on Neutrino Physics, Erice, Italy, Sept. 1997, to be publ. in Plenum Press
- [Ell87] S.R. Elliot, A.A. Hahn, M.K. Moe, Phys. Rev. Lett. **59** (1987) 1649
- [Ell92] S. R. Elliott et al., Phys. Rev. **C 46** (1992) 1535
- [Fal94] T. Falk, A. Olive, M. Srednicki, Phys. Lett. **B339** (1994) 248
- [Fri88] J.Friemann, H.Haber, K.Freese, Phys. Lett. **B 200** (1988) 115; J. Bahcall, S. Petcov, S. Toshev and J.W.F. Valle, Phys.Lett. **B 181** (1986) 369; Z. Berezhiani and M. Vysotsky, Phys. Lett. **B 199** (1988) 281.
- [Fri95] H. Fritzsch and Zhi-zhong Xing, preprint hep-ph/9509389, Phys. Lett. **B 372** (1996) 265
- [Gel81] G.B. Gelmini and M. Roncadelli, Phys. Lett. **B 99** (1981) 411
- [Gel95] G. Gelmini, E. Roulet, Rep. Progr. Phys. **58**(1995) 1207
- [Geo81] H.M. Georgi, S.L.Glashow and S. Nussinov, Nuc. Phys. **B 193** (1981) 297
- [Ger96] G. Gervasio, in [Kla96]
- [Gon95] M. Gonzalez-Garcia, hep-ph/9510419

- [Gro85] K. Grotz, H. V. Klapdor, Phys. Lett. **B 157** (1985) 242
- [Gro86] K. Grotz, H.V. Klapdor, Nucl. Phys **A 460** (1986) 395
- [Gro90] K. Grotz, H.V. Klapdor, 'The Weak Interaction in Nuclear, Particle and Astrophysics' (Adam Hilger: Bristol, Philadelphia) 1990
- [H195] H1 Collab., Phys. Lett. **B 353** (1995) 578, Z. Phys. **C 64** (1994) 545
- [H196] H1 Collab., S. Aid et al., Phys. Lett. **B 369** (1996) 173
- [Hab93] H. E. Haber, in Proc. on Recent Advances in the Superworld, Houston, April 14-16 (1993), hep-ph/9308209
- [Hal84] L. Hall, M. Suzuki, Nuclear Physics **B 231** (1984) 419
- [Hat94] N. Hata, P. Langacker, Phys. Rev. **D 50** (1994) 632
- [Hax84] W.C. Haxton, G.J. Stephenson, Progr. Part. Nucl. Phys. **12** (1984) 409
- [Hel96] J. Hellmig, PhD Thesis, Univ. of Heidelberg, 1996
- [Hel97] J. Hellmig, H.V. Klapdor-Kleingrothaus, Z. Phys. **A**, in press 1997
- [Hew97] J.L. Hewett, T.G. Rizzo, preprint hep-ph/9703337v3 (May1997)
- [Heu95] G. Heusser, Ann. Rev. Nucl. Part. Sci. **45** (1995) 543
- [Hir95] M. Hirsch, H.V. Klapdor-Kleingrothaus, S.G. Kovalenko, Phys. Rev. Lett. **75** (1995) 17
- [Hir95b] M. Hirsch, H.V. Klapdor-Kleingrothaus, S.G. Kovalenko, in [Kla96]
- [Hir95c] M. Hirsch, H.V. Klapdor-Kleingrothaus, S. Kovalenko, Phys. Lett. **B 352** (1995) 1
- [Hir95d] J. Hirsch, O. Castanos, P.O. Hess, Nucl. Phys. **A 582** (1995) 124
- [Hir96] M. Hirsch, H.V. Klapdor-Kleingrothaus, S.G. Kovalenko, Phys. Lett. **B 372** (1996) 181, Erratum: Phys. Lett. **B381** (1996) 488
- [Hir96a] M. Hirsch, H.V. Klapdor-Kleingrothaus, S.G. Kovalenko, Phys. Lett. **B 378** (1996) 17 and Phys. Rev. **D 54** (1996) R4207
- [Hir96b] M. Hirsch, H. V. Klapdor-Kleingrothaus, S. G. Kovalenko, H. Päs, Phys. Lett. **B 372** (1996) 8
- [Hir96c] M. Hirsch, H.V. Klapdor-Kleingrothaus, S. Kovalenko, Phys. Rev. **D 53** (1996) 1329
- [Hir96d] M. Hirsch, H.V. Klapdor-Kleingrothaus, in [Kla96]; M. Hirsch, H.V. Klapdor-Kleingrothaus, O. Panella, Phys. Lett. **B 374** (1996) 7
- [Hir97] M. Hirsch, H.V. Klapdor-Kleingrothaus, S.G. Kovalenko, Phys. Lett. **B 398** (1997) 311 and **403** (1997) 291
- [Hir97a] M. Hirsch, H.V. Klapdor-Kleingrothaus, S.G. Kovalenko, Phys. Rev. **D** in press, 1997
- [Hir97b] M. Hirsch, H.V. Klapdor-Kleingrothaus, S. Kovalenko, in [Kla98]
- [Hir97c] M. Hirsch, H.V. Klapdor-Kleingrothaus, Proc. Int. Workshop on Dark Matter in Astro- and Particle Physics (DARK96), Heidelberg, Sept. 1996, Eds. H.V. Klapdor-Kleingrothaus and Y. Ramachers (World Scientific, Singapore) 1997, p. 640

- [HM94] HEIDELBERG–MOSCOW collab., Phys. Lett. **B 336** (1994) 141
- [HM95] HEIDELBERG–MOSCOW collab., Phys. Lett. **B 356** (1995) 450
- [HM96] HEIDELBERG–MOSCOW collab., Phys. Rev. **D 54** (1996) 3641,
- [HM97] HEIDELBERG–MOSCOW collab., Phys. Rev. **D 55** (1997) 54 and Phys. Lett. **B 407** (1997) 219
- [Ioa94] A. Ioanissyan, J.W.F. Valle, Phys. Lett **B 322** (1994) 93
- [Jör94] V. Jörgens et al., Nucl. Phys. (Proc. Suppl.) **B 35** (1994) 378
- [Jun96] G. Jungmann, M. Kamionkowski, K. Griest, Phys. Rep. 267 (1996) 195
- [Kal97] J. Kalinowski et al., preprint hep-ph/9703288v2 (March 1997)
- [Kan97] G. Kane, in [Kla98]
- [Kla84] H.V. Klapdor, K. Grotz, Phys.Lett. **B142** (1984) 323
- [Kla87] H.V. Klapdor–Kleingrothaus, MPI–H 1987, proposal
- [Kla91] H.V. Klapdor–Kleingrothaus, Proc. Int. Symposium on γ -Ray Astrophysics, Paris 1990, AIP Conf. Proc. 232 (1991) 464
- [Kla92] H.V. Klapdor–Kleingrothaus, K. Zuber, Phys. Bl. **48** (1992) 1017
- [Kla94] H.V. Klapdor–Kleingrothaus, Progr. Part. Nucl. Phys. **32** (1994)261
- [Kla95] H. V. Klapdor–Kleingrothaus, A. Staudt, Non–Accelerator Particle Physics, IOP Publ., Bristol, Philadelphia, 1995; and Teilchenphysik ohne Beschleuniger, Teubner Verlag, Stuttgart, 1995
- [Kla96] H.V. Klapdor–Kleingrothaus and S. Stoica (Eds.), Proc. *Int. Workshop on Double Beta Decay and Related Topics*, Trento, 24.4.–5.5.95, World Scientific Singapore
- [Kla96a] H.V. Klapdor–Kleingrothaus, in Proc. *Int. Workshop on Double Beta Decay and Related Topics*, Trento, 24.4.–5.5.95, World Scientific Singapore 1996, Ed.: H.V. Klapdor–Kleingrothaus and S. Stoica
- [Kla97] H.V. Klapdor–Kleingrothaus, Invited talk at NEUTRINO 96, Helsinki, June 1996, World Scientific Singapore 1997, p. 317
- [Kla97a] H.V. Klapdor–Kleingrothaus, in Proc. Int. Workshop on Non-Accelerator New Physics (NANP-97), Dubna, Moscow region, Russia, July 7-11, 1997 and in Proc. Int. School on Neutrinos, Erice, Italy, Sept. 1997, to be publ. in Plenum Press
- [Kla97b] H.V. Klapdor–Kleingrothaus, M.I. Kudravnsev, V.G. Stolpovski, S.I. Svertilov, V.F. Melnikov, I. Krivosheina, J. Moscow. Phys. Soc. 7 (1997) 41
- [Kla97c] H.V. Klapdor–Kleingrothaus and K. Zuber, Particle Astrophysics, IOP Publ., Bristol, Philadelphia 1997; and Teilchenastrophysik, Teubner Verlag, Stuttgart, 1997
- [Kla97d] H.V. Klapdor–Kleingrothaus, M. Hirsch, Z. Phys. **A**, in press 1997

- [Kla97e] H.V. Klapdor–Kleingrothaus, Y. Ramachers, in: Proc. Int. Workshop on Dark Matter in Astro– and Particle Physics (DARK96) Sept. 1996, Eds. H.V. Klapdor–Kleingrothaus and Y. Ramachers, Heidelberg, (World Scientific Singapore) 1997, p. 459
- [Kla98] H.V. Klapdor–Kleingrothaus and H. Päs (Eds.), *Beyond the Desert – Accelerator- and Non–Accelerator Approaches*, IOP, Bristol, 1998
- [Kol97] S. Kolb, M. Hirsch, H.V. Klapdor–Kleingrothaus, S. Kovalenko, in [Kla98]
- [Kol97a] S. Kolb, M. Hirsch, H.V. Klapdor–Kleingrothaus, *Phys. Rev. D* **56** (1997) 4161
- [Kuc95] R. Kuchimanchi, R.N. Mohapatra, *Phys. Rev. Lett.* **75** (1995) 3939
- [Kum96] K. Kume (ELEGANT collaboration), in [Kla96]
- [Kuz90] V. Kuzmin, V. Rubakov, M. Shaposhnikov, *Phys. Lett. B* **185** (1985) 36; M. Fukugita, T. Yanagida, *Phys. Rev. D* **42** (1990) 1285; G. Gelmini, T. Yanagida, *Phys. Lett. B* **294** (1992) 53; B. Campbell *et al.*, *Phys. Lett. B* **256** (91) 457
- [Lan88] P.Langacker, in ‘Neutrinos’ (Springer: Heidelberg, New York), 1988, ed. H.V. Klapdor, p. 71
- [Lee94] D.G. Lee, R.N. Mohapatra, *Phys. Lett. B* **329** (1994) 463
- [Leu94] M. Leurer, *Phys. Rev. D* **49** (1994) 333
- [Moe91] M. K. Moe, *Phys. Rev. C* **44** (1991) R931
- [Moe94] M. K. Moe, *Prog. Part. Nucl. Phys.* **32** (1994) 247; *Nucl. Phys. (Proc. Suppl.) B* **38** (1995) 36
- [Moh86] R.N. Mohapatra, *Phys. Rev. D* **34** (1986) 3457
- [Moh86b] R.N. Mohapatra, *Phys. Rev. D* **34** (1986) 909
- [Moh88] R.N. Mohapatra and E. Takasugi, *Phys. Lett. B* **211** (1988) 192
- [Moh91] R.N. Mohapatra, P.B. Pal, ‘Massive Neutrinos in Physics and Astrophysics’ (World Scientific, Singapore) 1991
- [Moh92] R.N. Mohapatra, *Unification and Supersymmetry* (Springer: Heidelberg, New York) 1986 and 1992
- [Moh94] R.N. Mohapatra, *Progr. Part. Nucl. Phys.* **32** (1994) 187
- [Moh95] R.N. Mohapatra, S. Nussinov, *Phys. Lett. B* **346** (1995) 75
- [Moh96] R.N. Mohapatra, A. Rasin, *Phys. Rev. Lett.* **76** (1996) 3490 and *Phys. Rev. D* **54** (1996) 5835
- [Moh96a] R.N. Mohapatra, in [Kla96]
- [Moh97] R. N. Mohapatra, *Proc. Neutrino 96*, Helsinki, 1996, World Scientific Singapore, 1997, p. 290
- [Moh97a] R.N. Mohapatra, *Proc. Int. School on Neutrinos*, Erice, Italy, Sept. 1997, to be publ. in Plenum Press, and priv. comm.

- [Mut88] K. Muto, H.V. Klapdor, in 'Neutrinos (Springer: Heidelberg, New York) 1988, ed. H.V. Klapdor, p. 183
- [Mut89] K. Muto, E. Bender, H.V. Klapdor, Z. Phys. **A 334** (1989) 177,187;
- [Mut91] K. Muto, E. Bender, H.V. Klapdor–Kleingrothaus, Z. Phys **A 339** (1991) 435
- [NEM94] NEMO Collaboration, Nucl. Phys. (Proc. Suppl.) **B 35** (1994) 369
- [Nor97] D. Normile, Science 276 (1997) 1795
- [PDG94] Particle Data Group, Phys. Rev. **D 50** (1994)
- [PDG96] Particle Data Group, Phys. Rev. **D 54** (1996) 1
- [Päs96] H. Päs *et al.*, in [Kla96];
- [Päs97] H. Päs, M. Hirsch, H.V. Klapdor–Kleingrothaus, S.G. Kovalenko, in [Kla98]
- [Pan96] O. Panella, in [Kla96]
- [Pan97] O. Panella, in [Kla98]
- [Pan96b] G. Pantis, F. Simkovic, J.D. Vergados, A. Faessler, Phys. Rev. **C 53** (1996) 695
- [Pel93] J. Peltoniemi, J. Valle, Nucl. Phys. **B 406** (1993) 409
- [Pel95] J.T. Peltoniemi, preprint hep-ph/9506228
- [Pet94] S.T. Petcov, A.Yu. Smirnov, Phys. Lett. **B 322** (1994) 109
- [Pet96] S. Petcov, in [Kla96]
- [Pil93] A. Pilaftsis, Phys. Rev. **D 49** (1993) 2398
- [Piq96] F. Piquemal *et al.*, in [Kla96]
- [Pri95] J.R. Primack, J. Holtzman, A. Klypin, D.O. Caldwell, Phys. Rev. Lett. **74** (1995) 2160
- [Rad95] P.B. Radha *et al.*, preprint nucl-th/9510052 (Oct. 1995)
- [Raf96] G. Raffelt, J. Silk, Phys. Lett. **B 366** (1996) 429
- [Rag94] R. S. Raghavan, Phys. Rev. Lett. **72** (1994) 1411
- [Rau94] F. Raupach (H1 Collab.), Proc. Int. Europhys. Conf. on High En. Phys., Marseille, 1993, Edition Frontieres, Gif–Sur–Yvette, France 1994. Eds J. Carr, M. Perrothet
- [Ren82] F.M. Renard, Phys. Lett. **B 116** (1982) 264
- [Riz82] T.G. Rizzo, Phys. Lett. **B 116** (1982) 23
- [Riz96] T.G. Rizzo, hep/ph/9612440
- [Roy92] D.P. Roy, Phys.Lett. **B 283** (1992) 270
- [Rub96] C. Rubbia, Proc. TAUP 95, Toledo, Sept. 17–21 (1995), Nucl. Phys. **B** (Proc. Supl.) 48 (1996)172
- [Sch81] J. Schechter, J.W.F. Valle, Phys. Rev. **D 25** (1982) 2951

- [Sim96] F. Simkovic et al., Proc. TAUP 95, Toledo, 17–21 Sept. 1995; Nucl. Phys. **B** (Proc. Supplement) 48 (1996) 257
- [Sim97] F. Simkovic *et al.*, Phys. Lett. **B 393** (1997) 267
- [Smi96] P.F. Smith *et al.*, Phys. Lett. **B 379** (1996) 299
- [Smi96a] A. Yu. Smirnov, Proc. Int. Conf. on High Energy Physics, Warsaw 1996, hep-ph/9611465v2 (Dec 1996)
- [Sou92] I.A. D’Souza. C.S. Kalman, Preons, Models of Leptons , Quarks and Gauge bosons as Composite Objects (World Scientific, Singapore) 1992
- [Sta90] A. Staudt, K.Muto, H.V. Klapdor–Kleingrothaus, Europhys. Lett. **13** (1990) 31
- [Ste91] J. Steinberger, Phys. Rep. **203** (1991) 345
- [Sto96] S. Stoica, in [Kla96]
- [Suh96] J. Suhonen, in [Kla96]
- [Suz97] A. Suzuki, priv. comm. 1997, and KAMLAND proposal, (in Japanese)
- [Tak96] E.Takasugi, in [Kla96]
- [Tak97] E. Takasugi, in [Kla98]
- [Tom87] T.Tomoda, A. Faessler, Phys. Lett. **B199** (1987) 475
- [Tre95] V.I. Tretyak, Yu. Zdesenko, At. Data Nucl. Data Tables **61** (1995) 43
- [Val96] J.W.F. Valle, in [Kla96]
- [Vog86] P.Vogel, M.R. Zirnbauer, Phys. Rev. Lett. **57** (1986)3148
- [Vog96] P.Vogel, in [Kla96]
- [Vui93] J.-C. Vuilleumier et al., Phys. Rev. **D 48** (1993) 1009
- [Wol81] L. Wolfenstein, Phys. Lett **107 B** (1981) 77
- [You95] Ke You et al., Phys. Lett. **B 265** (1995) 53