

# Coulomb Blockade and Cotunneling in Single Electron Circuits with On-chip Resistors: Towards the Implementation of R-pump

A. B. Zorin, S. V. Lotkhov, H. Zangerle and J. Niemeyer

*Physikalisch-Technische Bundesanstalt, Bundesallee 100, D-38116 Braunschweig, Germany*

We report on the investigation of Al single electron structures equipped with miniature (8  $\mu\text{m}$  long) on-chip Cr resistors of  $R > R_k = h/e^2 \approx 26 \text{ k}\Omega$ . From the measurement of the Coulomb blockade in single-junction structures we evaluated the self-capacitance of our resistors per unit length,  $c \approx 62 \text{ aF}/\mu\text{m}$ . We demonstrate that the cotunneling current in the transistor samples in the Coulomb blockade regime obeys the power law,  $I \propto V^{3+(R/R_k)}$ , predicted by Odintsov, Bubanja and Schön for a transistor having pure ohmic-resistance leads. The concept of the three-junction single electron pump with on-chip resistors (R-pump) is developed. We demonstrate that the implementation of the R-pump with a relative accuracy of the electron transfer of  $10^{-8}$  is quite feasible with the technology available.

PACS numbers: 73.40.Gk, 73.23.Hk

## I. INTRODUCTION

After the pioneering work by Averin and Likharev [1], predicting the single electron tunneling (SET) effects in current-biased junctions of small intrinsic capacitance, the series of experimental papers on metallic tunnel junction circuits with on-chip resistors was published (see, for example, Refs. [2–6]). The miniature resistors make it possible to realize a high environmental impedance  $|Z(\omega)| \gg R_k \equiv h/e^2 \approx 25.8 \text{ k}\Omega$  in rather wide frequency range. Such an isolation of the tunnel junctions from a power source generally results in an enhancement of the Coulomb blockade in the  $I - V$  curve of a SET device. [7] In particular, a high-ohmic compact resistor  $R$  connected in series with a single tunnel junction ensures that the pronounced Coulomb blockade is observed (see, for example, Ref. [6]). Moreover, a sufficiently large  $R$  allows the coherent SET [1] and Bloch [8] oscillations to be observed [4,9] in these current-biased circuits.

There is still another important advantage of the SET circuits with high-ohmic resistors, which up to date has not been tested in practice. Namely, in the Coulomb blockade state, these circuits can have an extremely low cotunneling current (i.e. the current component associated with coherent tunneling of an electron simultaneously over several junctions [10]). In the process of cotunneling, the electromagnetic environment with large dissipation (a resistor of magnitude  $R > R_k$ ) can absorb a considerable part of the electron energy  $eV$ , which then is distributed over the numerous internal degrees of freedom of this dissipative environment. As a result, the

cotunneling probability is drastically reduced.

The theory of cotunneling in  $N$ -junction arrays with resistors has been developed by Odintsov, *et al.* [11] for  $N = 2$  and generalized by Golubev and Zaikin [12] for  $N \geq 2$ . They showed that at  $T = 0$  the cotunneling contribution to the  $I - V$  curve in the Coulomb blockade regime obeys the power law

$$I \propto V^\eta, \quad \eta = 2(N + z) - 1, \quad (1)$$

with the dimensionless parameter  $z = R/R_k$ . In this paper we report on the first experimental observation of this effect in the normal Al SET structures with compact Cr resistors and discuss its possible impact on the performance characteristics of SET devices and the three-junction SET pump in particular.

## II. EXPERIMENT

### A. Fabrication technique and sample layout

The metallic SET structures were deposited on the thermally oxidized surface ( $\text{SiO}_2$  layer of thickness of ca. 300 nm) of a Si wafer (about 300  $\mu\text{m}$  thick). The tunnel junctions and microstrip resistors were fabricated *in situ* by the shadow evaporation technique [13] through the trilayer mask patterned by e-beam lithography and reactive-ion etching. At three different angles, we then deposited three metal layers: Cr (8-10 nm thick), then Al (30 nm), and, after oxidation, again Al (35 nm). The tunnel junctions had nominal dimensions of 80 nm by 80 nm, resulting in the junction capacitance  $C_j \approx 0.15 - 0.2 \text{ fF}$  (or the junction charging energy  $E_c = e^2/2C_j \approx 0.4 - 0.5 \text{ meV}$ ) and tunnel resistance  $R_j \approx 60 - 250 \text{ k}\Omega$ . An example of the resulting structure, a SET transistor with resistors (we will call it R-SET) is depicted in Fig. 1.

The Cr microstrips (shown only partially in the SEM photo, Fig. 1a) had the nominal lateral dimensions of  $w = 80 \text{ nm}$  by  $\ell = 8 \mu\text{m}$  and a resistance per unit length  $r$  of up to  $10 \text{ k}\Omega/\mu\text{m}$  (or  $R_\square = rw$  up to  $800 \Omega$  per square). The total dc resistance  $R \approx 30 - 80 \text{ k}\Omega$  of Cr strips normally did not exceed  $R_j$ . (This ensured establishing of the charge equilibrium before a tunneling event occurs, i.e. the condition assumed in theory [11].) On the other hand, these resistance magnitudes corresponded to substantial values of parameter  $z \approx 1 - 3$ . These values should ensure the strong suppression of cotunneling, which, according to Eq.(1), is equivalent to the action of

one to three additional tunnel junctions attached to the original structure.

### B. Characterization of resistors

The resistors exhibited practically linear  $I - V$  characteristics at temperatures down to the lowest temperature of our measurements  $T = 15$  mK. An example of the derivative plot  $dI/dV - V$  is presented in Fig. 2. The strictly linear behavior of our resistors (at least those having  $R \leq 50$  k $\Omega$  or  $R_{\square} \leq 500$   $\Omega$  per square) compares favorably with that of the long arrays of tunnel junctions [2], which can hardly model the real metallic resistance behavior. Due to the inherent Coulomb blockade, these arrays usually exhibit considerable non-linearity at small voltages, that limits their application.

The microstrip resistor generally presents a lossy transmission line with an inductance per unit length,  $\mathcal{L} \sim \mu_0 \approx 1.26$  pH/ $\mu\text{m}$  which reactance at characteristic frequencies of 10-100 GHz is negligibly small,  $< 1 \Omega/\mu\text{m} \ll r$ . The distributed capacitance of this  $RC$ -line was found experimentally from the normal-state  $I-V$  characteristics of the single-junction structures with such resistors. Our idea was based on the fact that at  $T = 0$  the second derivative of the  $I-V$  curve should mimic the function  $P(E)$  determined by impedance  $Z(\omega)$  (see, for example, the review paper [14]),

$$\frac{d^2 I}{dV^2} = \frac{e}{R_j} P(eV). \quad (2)$$

Function  $P(E)$  plays an important role in the "environment" theory of tunneling where it describes the probability of the transfer of energy  $E$  to the external circuit in a tunneling event.

First we measured the  $dI/dV-V$  curves and then derived the  $d^2 I/dV^2-V$  curves and averaged them over several runs. Then we fitted the obtained curves with those computed from theory [14] for the particular case of a  $RC$ -line impedance. The line resistance  $r$  was taken from the dc measurements while the line capacitance per unit length  $c$  was the fitting parameter. The resulting fit is shown in Fig. 3. It gave the value of specific capacitance  $c \approx 62$  aF/ $\mu\text{m}$  [15], or total capacitance  $C_0 = c\ell \approx 500$  aF of the whole line. A similar estimation,  $c \approx 60$  aF/ $\mu\text{m}$ , was made by Kuzmin *et al.* [15] from the shape of the supercurrent bump in the  $I - V$  characteristic of a small Josephson junction attached to 0.1  $\mu\text{m}$ -wide and 28  $\mu\text{m}$ -long Cr resistors.

### C. Measurements of cotunneling current

For evaluating the effect of cotunneling in Al-Cr circuits, we performed measurements of the  $I - V$  curves of R-SETs. Qualitatively similar to  $I - V$  curves of SET transistors without resistors, the  $I - V$  curves of our

structures were featured by a sharp Coulomb blockade corner and a steep decrease of  $I$  inside the blockade region (typical of SET arrays with a large number of junctions  $N > 2$ ). This pointed to a strong suppression of the cotunneling current due to the attached resistors.

To obtain higher accuracy of measurement inside the Coulomb blockade region, the lock-in technique was applied. The log-log plot of the  $I - V$  curves of three different samples is presented in Fig. 4. The electric parameters of these samples are compiled in Table I. The reference sample 1 (without resistors) shows a cubic decrease of current,  $\eta = 3$ , which is typical of the low-temperature behavior of ordinary SET transistors [16]. The experimental data for R-SET samples 2 and 3 with resistors of 40 k $\Omega$  and 80 k $\Omega$ , respectively, measured in the range  $0.2 \text{ mV} < V < 0.4 \text{ mV}$  demonstrate a much steeper decay,  $\eta = 2z + 3 \approx 6-9$ .

### III. SUPPRESSION OF COTUNNELING BY ON-CHIP RESISTORS

We found that the behavior of R-SETs is well described by Eq.(1) in the range of the bias voltage up to  $V \approx 200 - 400 \mu\text{V}$ . This fact is still surprising because Eq.(1) was derived for the pure ohmic impedance, which for our samples is realized for substantially lower voltages,  $V < V_{RC} = \hbar\Omega_{RC}/e \approx 15 - 30 \mu\text{V}$ , where

$$\Omega_{RC} = \frac{1}{RC_0} \approx (2.4 - 4.8) \times 10^{10} \text{ s}^{-1}, \quad (3)$$

the roll-off frequency of the transmission line (see Fig. 5). Moreover, the range of applicability of Eq.(1) was found to be extended even somewhat beyond the voltages  $V_c = \hbar\Omega_c/e$ , where

$$\Omega_c = \frac{8r}{cR_k^2} \approx (1 - 2) \times 10^{11} \text{ s}^{-1}, \quad (4)$$

the frequency at which the real part of the line impedance drops down to the level  $\text{Re}Z(\omega) = R_k$  (see Fig. 5). In our case,  $V_c \approx 70 \mu\text{V}$  and  $140 \mu\text{V}$  for samples 2 and 3, respectively.

The data show, that the effect of the resistive microstrips is very close to that of pure resistors in substantially wider than expected range of voltage. This disparity between the encouraging experimental results and rather conservative predictions of theory [11] is most likely because of the theoretical model which does not take into account a non-ohmic dispersion of real resistors. That is why a more general approach (which deals with the  $RC$ -line environment) is urgently needed. Such theory should give the quantitative answer to the question what the optimum length  $\ell$  of a resistor is which causes an effective suppression of cotunneling in the whole range of the Coulomb blockade. So far we accept the empirical criterion  $\ell \sim 3C_j/c$ .

Another important experimental issue is the measurement of very low cotunneling current. The accuracy of both dc and lock-in measurements is severely limited by the noise of preamplifier. However, there is more efficient way to evaluate very small  $I$ : it is to count individual electrons carrying this current. The experiment of this kind was recently carried out by Lotkhov *et al.* [17] with a four-junction chain of tunnel junctions attached on one side to a voltage source through a 50 k $\Omega$  resistor (identical to those described in this paper) and, on the other side, to a so-called memory island. The change of the number of electrons on the memory island was reliably measured by a SET electrometer capacitively coupled to that island. Due to the presence of the resistor, this so-called R-trap demonstrated an amazing capability of holding the electric charge (or, in other terms, of not leaking) over hours. This characteristic is more than three orders of magnitude better than that of the ordinary four-junction chains without resistors. [18] In fact, it is comparable to that of the devices consisting of  $N = 6-7$  junctions [19,20] in which the cotunneling is drastically suppressed because of a large number of junctions in the chains. Thus, the experiment [17] complements the present study of cotunneling current suppression from the side of very low currents.

#### IV. TOWARDS THE R-PUMP

The results of our experiments encourage us to further develop the family of fewer-junction SET circuits with on-chip resistors. These circuits can have an extremely small cotunneling component while the sequential tunneling component of SET can still be efficiently controlled by gates. The most attractive devices are the SET turnstile and pump with local resistors, or R-turnstile and R-pump, respectively. They are capable of carrying an accurate dc current  $I = ef$ , where  $f$  is the frequency of the rf drive applied to the gate(s). These devices were first referred to Odintsov *et al.* [11]; here we develop a concept for their operation and make a preliminary evaluation of the characteristics expected.

As an example, Fig. 6 illustrates the basic electric circuit of a three-junction R-pump. It comprises two islands supplied with the gates of capacitances  $C_{g1}, C_{g2} \ll C_j$ . These gates are driven by two harmonic signals,

$$V_{1,2} = V_{01,02} + A \cos(2\pi ft \pm \frac{\theta}{2}) \quad (5)$$

of the frequency  $f \ll (R_j C_j)^{-1}$  and a relative phase shift  $\theta$ . Voltages  $V_{01,02}$  adjust the working point ensuring the pumping regime. Varying  $\theta$  in the range  $[90^\circ, 180^\circ]$  one can compensate an unavoidable cross-talk between the gates in such a way that polarization charges on the two islands alternate in time as quadrature components. This phasing ensures the optimum pumping cycle (see, for example, the review by Esteve [21]), whose parameters, as

will be shown below, remaining intact in our case. The key elements of the R-pump are two resistors,  $R/2$  each,

$$R_k < R < R_j, \quad (6)$$

and this condition ensures establishing of the charge equilibrium in the circuit at the rate  $\tau^{-1} \sim (RC_j)^{-1} \gg f$ . This means that the resistors carry current only during a short time  $\sim \tau$  after a tunneling event. Then the voltage drop across the resistors is zero and the chain of junctions is at zero bias,  $V_L = V_R = 0$ , similarly to the case of  $R = 0$ .

The most important issue in the pump dynamics is the dependence of the electron tunneling rate  $\Gamma$  on the energy  $E$  gained in this event. In our case,  $\Gamma$  is expressed as a convolution integral [14]

$$\Gamma(E) = \int_{-\infty}^{\infty} \Gamma_0(E') P_3(E - E') dE', \quad (7)$$

where

$$\Gamma_0(E) = \frac{1}{e^2 R_j} \frac{E}{1 - \exp(-E/k_B T)} \quad (8)$$

is the usual rate for  $R = 0$ . Similar to function  $P(E)$  of a single-junction circuit with resistor, the "environment function"  $P_3(E)$  describes the absorption of energy in the three-junction circuit with resistor. In contrast to  $P(E)$  (see Fig. 3),  $P_3(E)$  is generally a "more peaked" function with the peak position closer to the origin  $E = 0$ . This is because two additional junctions connected in series with resistor  $R$  (see the inset of Fig. 7) considerably (by the factor of  $\kappa_1^2 = (1/3)^2$ ) reduce the dissipative part of the impedance seen by the given junction. For not very large  $R$ , say,  $\sim (2-4)R_k \approx 50-100$  k $\Omega$ , this results in a dependence  $\Gamma(E)$  which is not very much different from  $\Gamma_0(E)$ . This is illustrated in Fig. 7 for the ohmic resistor as well as for the  $RC$ -line. One can see that at  $T = 0$  all three curves have the same onset threshold  $E = 0$ .

From this consideration we can draw two important conclusions. First, the stability diagram of the R-pump in the plane of gate voltages  $V_1, V_2$  is the same as that of the ordinary pump [21], i.e. it consists of hexagonal domains with the triple-points. The coordinates of these nodes are identical for the two devices, so there is no need to revise the pumping cycle parameters  $V_{01}, V_{02}, A$  and  $\theta$ . Secondly, the curves computed for  $\Gamma$  in the range of characteristic values of energy,  $0 < E < \tilde{E} \sim 0.2E_c$  (dependent on the cycle parameters) fall below the dependence  $\Gamma_0 = E/(e^2 R_j)$  given by Eq.(8) at  $T = 0$  and can be roughly approximated as  $\Gamma \approx E/(e^2 R')$  with  $R' \sim 2R_j$  and  $3R_j$  for the  $RC$ -line and the pure resistor, respectively. This means that the resistors somewhat hamper (slow down) the sequential electron tunneling in the R-pump, and a reduction of frequency  $f$  might be required to ensure reliable operation.

To minimize the errors  $\delta I_{\text{mis}}$  associated with missing the tunneling events, the operation frequency  $f$  should

be rather low. [21] For the ordinary pump the condition  $f \approx 2 \times 10^{-3} (R_j C_j)^{-1}$  ensures the level  $|\delta I_{\text{mis}}|/I < 10^{-8}$ . For the R-pump with  $R = 50 \text{ k}\Omega$ , this condition reads  $f \approx 2 \times 10^{-3} (R' C_j)^{-1} \approx 30 \text{ MHz}$  for  $R_j = 200 \text{ k}\Omega$  and  $C_j = 150 \text{ aF}$ . This driving frequency corresponds to  $I \approx 5 \text{ pA}$ . Although the larger values of  $R$  apparently lead to an appreciable reduction of maximum  $f$ , the use of more low-ohmic junctions ( $R_j \sim 50 - 100 \text{ k}\Omega$ ) might possibly be allowed [22], and this may provide a substantial velocity gain in the cycling rate.

As to the errors associated with thermally activated tunnel events with the magnitude  $|\delta I_{\text{th}}|/I \sim \exp(-\tilde{E}/k_B T)$ , they can also be made sufficiently low. With the state-of-the-art junctions of  $C_j \approx 150 \text{ aF}$  and a typical effective electron temperature of the small islands of about  $60 \text{ mK}$  [21], we can reduce these errors below the level  $10^{-8}$ . Due to an appreciably larger volume of the resistors and their connection to external leads, their electron temperature is expected to be even lower. A possible excess shot noise in our regime of zero voltage (thermodynamic equilibrium) apparently is zero.

Although the accurate evaluation of cotunneling relies on simulations based on the theory describing the practical case of the  $RC$ -line, we present here an estimate for the pure resistance of the moderate value of  $R = 50 \text{ k}\Omega$ , relying on the experimental fact that the effects of this resistance and of the  $RC$ -line on cotunneling are similar. For the aforementioned set of parameters, *viz.*  $C_j = 150 \text{ aF}$ ,  $R_j = 100 \text{ k}\Omega$ ,  $T = 60 \text{ mK}$  and  $V = |V_L - V_R| < k_B T/e \approx 5 \text{ }\mu\text{V}$ , formulas Eq.(9) of paper [12] yield for  $N = 3$  the rate of cotunneling through all three junctions,  $\Gamma_{\text{cot}}^{(3)} \sim 4 \times 10^{-5} \text{ s}^{-1}$ . This yield  $|\delta I_{\text{cot}}^{(3)}|/I = \Gamma_{\text{cot}}^{(3)}/f \sim 10^{-11}$  for  $f = 30 \text{ MHz}$ .

When electron is transferred across one of the junctions the cotunneling across two other junctions (in the opposite direction) with the rate  $\Gamma_{\text{cot}}^{(2)}$  can occur instead. For this process the damping effect of the resistors is attenuated by factor of  $\kappa^2 = (2/3)^2 \approx 0.44$  determined by the ratio of capacitances of the whole chain and of the pair of junctions. [14] Evaluating  $\Gamma_{\text{cot}}^{(2)}$  along the lines of Refs. [12] and [23] leads for the aforementioned parameters to the relative errors of pumping  $\sim 10^{-8}$ .

We conclude that the R-pump with realistic parameters combines the potentially high accuracy, normally achievable in the many-junction ( $N = 6-7$ ) devices, and the attractive simplicity of the three-junction device. Its implementation is feasible within the framework of present-day fabrication technology and the standard measuring facilities for SET, which assume, in particular, a reliable filtering of the microwave frequency noise (see, for instance, Ref. [24]). The work on the Al-Cr R-pump is presently in progress at PTB. [25]

## V. CONCLUSION

We have shown that compact ( $\sim$  several  $\mu\text{m}$ ) Cr resistors of a magnitude up to  $100 \text{ k}\Omega$  connected in series to a SET device can drastically improve the characteristics of this device, considerably suppressing the cotunneling effect. Although our resistors had a substantial self-capacitance, the experimental data obtained are in a good agreement with theoretical predictions made for the pure ohmic resistance. Such a resistor can replace  $\Delta N = z \equiv R/R_k$  junctions in a SET circuit in which small cotunneling leakage is crucial. In particular, the R-SETs have a sharp Coulomb blockade corner in their  $I - V$  curves and, hence, they exhibit excellent modulation of voltage by gate at a very low level of bias current  $I$ .

We showed that the implementation of a three-junction electron pump with on-chip resistors is feasible with the present fabrication technology. The accuracy of the controlled transfer of single electrons in this R-pump ( $|\delta I|/I \leq 10^{-8}$ ) is sufficient for important applications in metrology, for example, for the cryogenic capacitor charging experiment [19].

The obvious advantage of the R-pump consists in the minimum number of islands, namely  $N - 1 = 2$ . Besides the simplicity of the rf-drive (two phase-shifted signals only) this design drastically simplifies the adjustment of the offset charges on the islands by the gates. Moreover, a drift of these charges due to slow recharging processes in a substrate causing detuning of the pump is potentially smaller in the case of two islands of the R-pump.

## ACKNOWLEDGMENTS

The authors wish to thank V. A. Krupenin for his assistance in the measurements. Useful discussions on the initial stage of this work with K. Flensburg, A. A. Odintsov, F. Liefvink and P. Teunissen are gratefully acknowledged. The work is supported in part by the German BMBF (Grant No. 13N7168) and the EU (MEL ARI Research Project 22953- CHARGE).

- 
- [1] D. V. Averin and K. K. Likharev, J. Low Temp. Phys. **62**, 345 (1986).
  - [2] P. Delsing, K. K. Likharev, L. S. Kuzmin and T. Claeson, Phys. Rev. Lett. **63**, 1180 (1989).
  - [3] A. N. Cleland, J. M. Schmidt and J. Clarke, Phys. Rev. Lett. **64**, 1565 (1990).
  - [4] L. S. Kuzmin and Yu. A. Pashkin, Physica B **194-196**, 1713 (1994).
  - [5] P. Joyez, D. Esteve and M. H. Devoret, Phys. Rev. Lett. **80**, 1956 (1998).

- [6] W. Zheng, J. R. Friedman, D. V. Averin, S. Han and J. E. Lukens, *Solid State Commun.* **108**, 839 (1998).
- [7] G. L. Ingold, P. Wyrowski and H. Grabert, *Z. Phys. B* **85**, 443 (1991).
- [8] K. K. Likharev and A. B. Zorin, *J. Low Temp. Phys.* **59**, 347 (1985).
- [9] L. S. Kuzmin and D. B. Haviland, *Phys. Scripta* **T42**, 171 (1992).
- [10] D. V. Averin and A. A. Odintsov, *Phys. Lett. A* **140**, 251 (1989).
- [11] A. A. Odintsov, V. Bujanja and G. Schön, *Phys. Rev. B* **46**, 6875 (1992).
- [12] D. S. Golubev and A. D. Zaikin, *Phys. Lett. A* **169**, 475 (1992).
- [13] J. Niemeyer, *PTB-Mitt.* **84**, 251 (1974); G. J. Dolan, *Appl. Phys. Lett.* **31**, 337 (1977).
- [14] G. L. Ingold and Yu. V. Nazarov, in *Single Charge Tunneling*, edited by H. Grabert and M. H. Devoret (Plenum, New York, 1992), Chapter 2, p.21.
- [15] L. S. Kuzmin, Yu. V. Nazarov, D. B. Haviland, P. Delsing and T. Claeson, *Phys. Rev. Lett.* **67**, 1161 (1991).
- [16] L. J. Geerligs, D. V. Averin and J. E. Mooij, *Phys. Rev. Lett.* **65**, 3037 (1990).
- [17] S. V. Lotkhov, H. Zangerle, A. B. Zorin and J. Niemeyer, *Appl. Phys. Lett.* **75**, 2665 (1999).
- [18] T. A. Fulton, P. L. Gammel, and L. N. Dunkleberger, *Phys. Rev. Lett.* **67**, 3148 (1991); P. Lafarge, P. Joyez, H. Pothier, A. Cleland, T. Holst, D. Esteve, C. Urbina and M. H. Devoret, *C. R. Acad. Sci. Paris* **314**, 883 (1992).
- [19] M. W. Keller, J. M. Martinis, N. M. Zimmerman and A. H. Steinbach, *Appl. Phys. Lett.* **69**, 1804 (1996).
- [20] P. D. Dresselhaus, L. Ji, S. Han, J. E. Lukens and K. K. Likharev, *Phys. Rev. Lett.* **72**, 3226 (1994).
- [21] D. Esteve in *Single Charge Tunneling*, edited by H. Grabert and M. H. Devoret (Plenum, New York, 1992), Chapter 3, p.108.
- [22] As the experiment on the four-junction R-trap showed [17], rather low tunnel resistances of junctions  $R_j \sim 70$  k $\Omega$  did not lead to a noticeable charge leakage in the chain.
- [23] H. Pothier, Ph.D. thesis, Paris VI University, 1991.
- [24] A. B. Zorin, *Rev. Sci. Instrum.* **66**, 4296 (1995).
- [25] S. V. Lotkhov, S. A. Bogoslovsky, A. B. Zorin and J. Niemeyer, to be presented at Conference on Precision Electromagnetic Measurements CPEM 2000 (14-19 May 2000, Sydney, Australia).

FIG. 1. SEM image (a) and the electric measurement diagram (b) of R-SET, i.e. the Al transistor equipped with 4 identical Cr resistors. This arrangement is used for 4-point measurements of the transistor as well as for direct testing of the resistors.

FIG. 2. The derivative of the current-voltage characteristic of two Cr resistors connected in series. The curve shows insignificant traces of the Coulomb blockade which may be due to the granular nature of the film.

FIG. 3. The second derivative plot (symbols) of the current-voltage characteristic of an Al single junction equipped with four on-chip Cr resistors (similar to those fragmentarily shown in Fig. 1). The equivalent impedance of the junction environment is determined by the impedance of a single strip whose equivalent electric circuit is shown in the inset. Function  $P(E)$  (solid line) was computed for an  $RC$ -line impedance for the given (measured)  $r = R/\ell$  and fitted  $c$ .

FIG. 4.  $I - V$  characteristics (points) of three Al SET transistors in the Coulomb blockade regime in the normal state. The bare sample 1 was not equipped with resistors. Either of samples 2 and 3 (see their micrograph in Fig. 1) has four similar Cr microstrip resistors with a magnitude of about 40 k $\Omega$  and 80 k $\Omega$ , respectively. The gate voltages were adjusted to maximize the Coulomb blockade. The voltage ( $V_0$ ) and current ( $I_0$ ) units are given in Table I. The solid straight lines show the theoretical dependence given by Eq.(1) for the values of  $\eta = R/R_k$  taken from dc measurements of  $R$ .

FIG. 5. The electromagnetic impedance of a  $RC$ -line modeling the typical Cr resistor (similar to that of transistor sample 2) versus frequency. The upper scale is the conversion of frequency into the voltage units. The characteristic frequencies  $\Omega_{RC}$  and  $\Omega_c$  (see text) are shown by arrows. The quantum resistance level is shown by a dashed line.

FIG. 6. The equivalent electric circuit diagram of a three-junction R-pump.

FIG. 7. The rate of electron tunneling through a particular junction of R-pump (modeled by the simplified network shown in the inset) versus the energy gain associated with this tunneling. The dashed line relates to a pure ohmic resistance of 50 k $\Omega$ , while the solid line gives the data for the  $RC$ -line of similar dc resistance. The dash-dotted and dotted lines describe the ordinary case of the zero resistance  $R$  for the zero and finite temperature, respectively. The curves for  $R \neq 0$  should be changed with temperature in a qualitatively similar way.

TABLE I. Parameters of the transistor samples:  $R_\Sigma$  is the sum tunnel resistance;  $C_\Sigma$ , the total capacitance of the island. The evaluation of  $C_\Sigma$  for sample 1 was straightforwardly made from the offset voltage  $V_0 = e/C_\Sigma$ , while for samples 2 and 3 the finite environmental impedance corrections were taken into account. The current unit  $I_0 = e R_k / (\pi^3 R_\Sigma^2 C_\Sigma)$ .

Sample	1	2	3
Resistance $R_\Sigma$ [k $\Omega$ ]	240	280	115
Capacitance $C_\Sigma$ [fF]	0.26	0.29	0.37
Voltage unit $V_0$ [ $\mu$ V]	610	550	430
Current unit $I_0$ [pA]	28	18	8.5
Resistance $R$ [k $\Omega$ ]	–	40	80
$V_{RC} = \hbar\Omega_{RC}/e$ [ $\mu$ V]	–	30	15
$V_c = \hbar\Omega_c/e$ [ $\mu$ V]	–	70	140

This figure "FIG1A.JPG" is available in "JPG" format from:

<http://arxiv.org/ps/cond-mat/9912032v1>

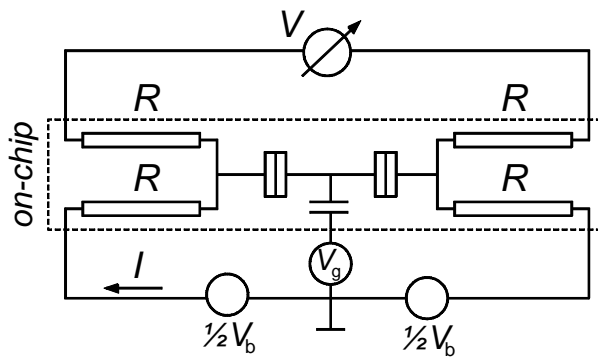

Fig. 1b

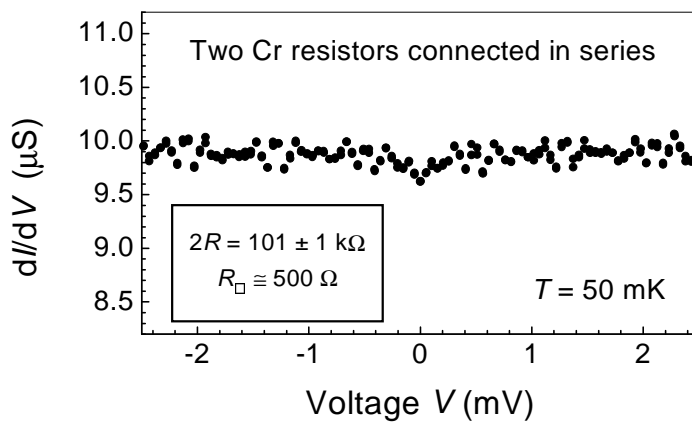

Fig. 2



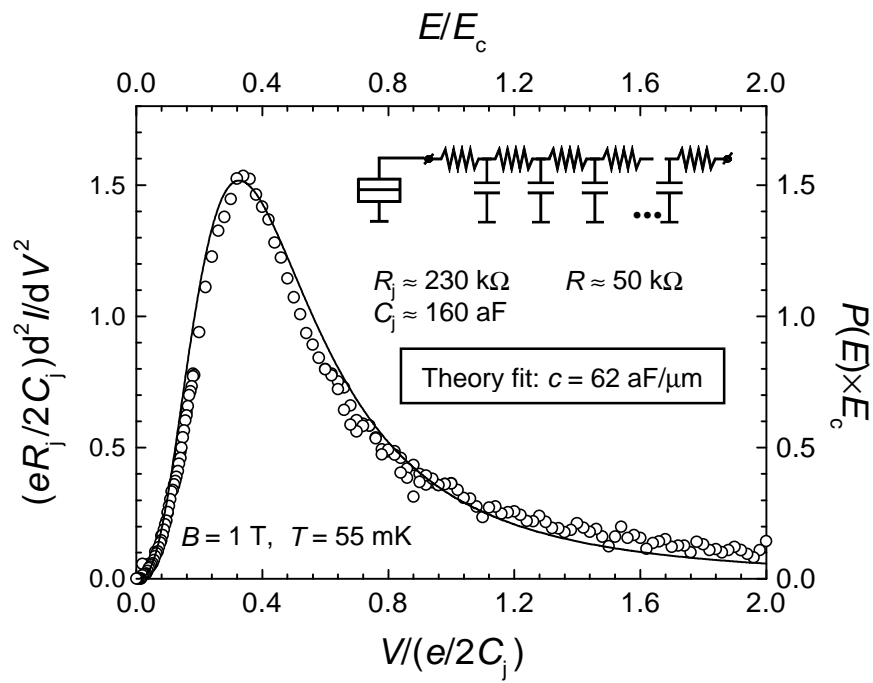

Fig.3

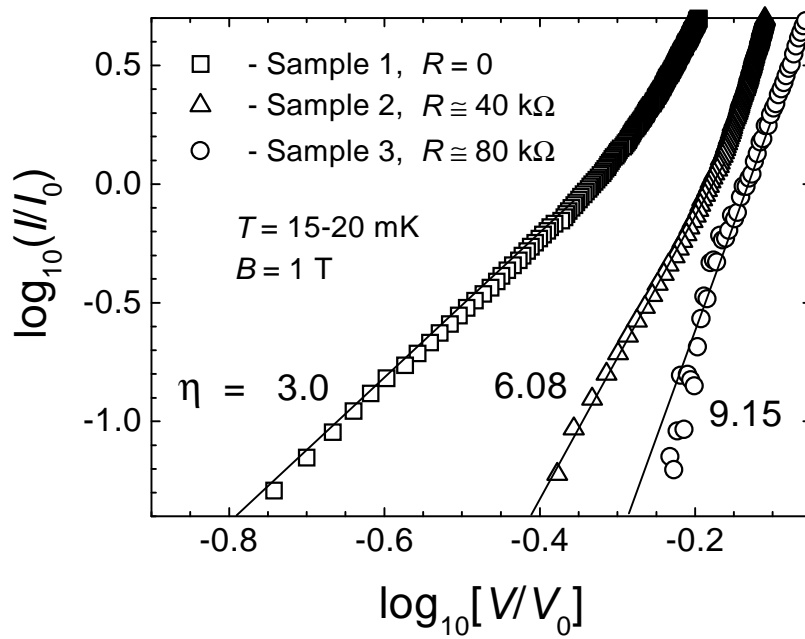

Fig.4

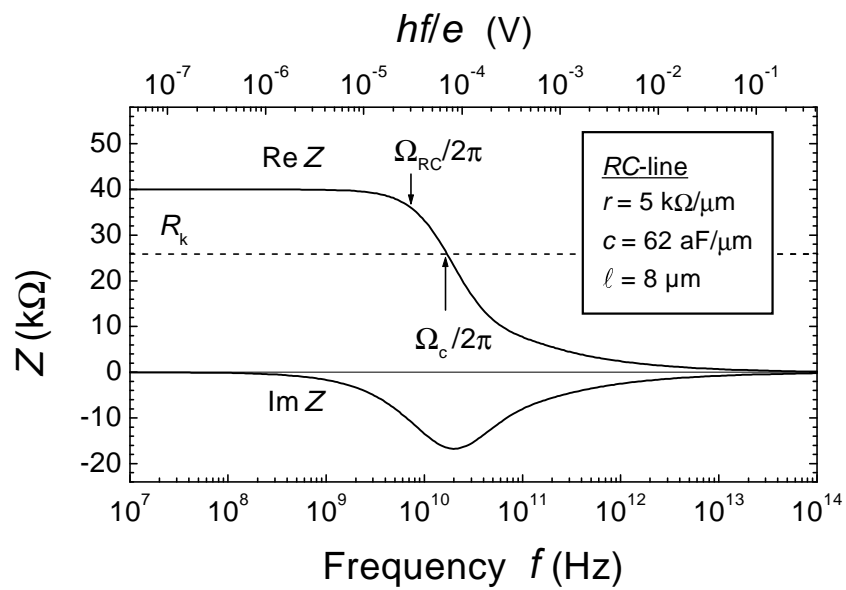

Fig.5

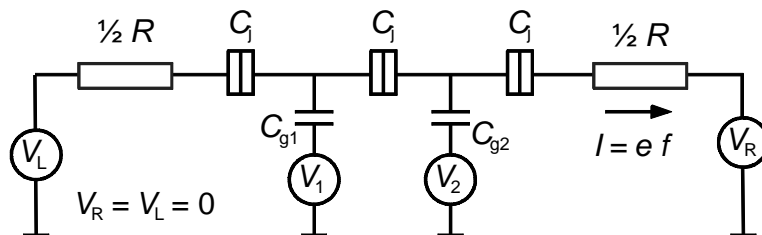

Fig.6

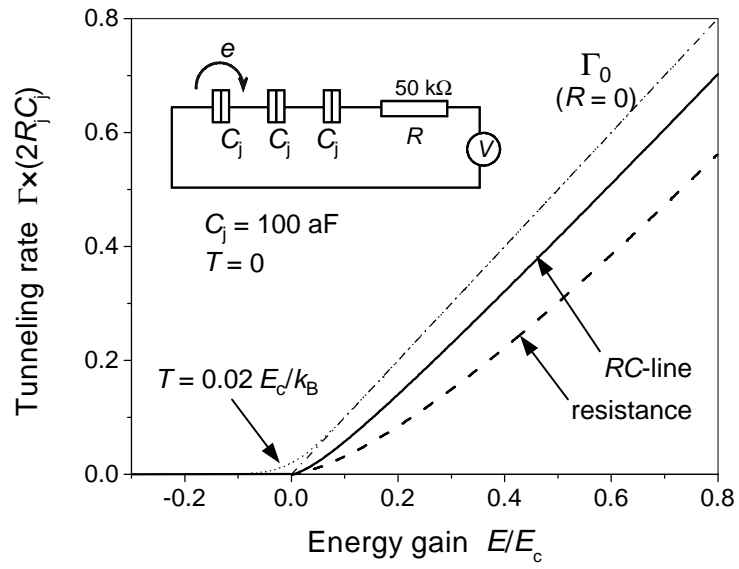

Fig. 7