

Random Walks on Figure Eight:From Polymers Through Chaos to Gravity and Beyond

Arkady L.Kholodenko*

Abstract

This paper is extended and broadly generalized version of earlier published rapid communication, Phys.Rev.E **58**, R5213 (1998).It also elaborates on some problems which were left unsolved or just mentioned in Physics Reports **298**, 251 (1998). Applications of the obtained results include (but not limited to)polymer physics, classical and quantum chaos, fractional Hall effect,dynamics of textures in liquid crystals and 2+1 Einsteinian gravity. The paper presents some self contained excerpts from mathematics (not discussed so far in physics literature) to facilitate the uninterrupted reading of the manuscript.

PACS number(s):02.50.-r,05.40.+j,61.41.+e

*375 H.L. Hunter Laboratories ,Clemson University, Clemson ,SC 29634-1905 , USA

I. Introduction

In our recent short paper [1] we had provided new derivation of Spitzer's law [2] for Brownian windings . This problem is of some importance in polymer physics since it allows to define the concept of entanglement in precise mathematical terms. It is also of relevance to other disciplines , e.g. 2+1 gravity , quantum Hall effect, etc. Due to format limitations of our paper[1] many important topics were either briefly mentioned or not discussed at all. This paper serves to correct this deficiency. If the reader will have patience to go over the entire manuscript , he or she will recognize, that, still, this much longer paper is just an introduction into the very rich field of various topological problems which are waiting for development. In particular, in this work we had only briefly mentioned the hyperbolic groups (in section 6) while this has become a very large area of research in mathematics[3] .Study of random walks on hyperbolic groups and their associated graphs reveals that, for example, the notion of ultrametricity which is used in the theory of spin glasses[4] is just a special case of hyperbolicity.Hence, the static and dynamic problems associated with spin glasses,glasses in general, and all other cases which involve replicas, could be studied without replicas by properly formulating the ultrametric problems within the scope of the hyperbolic group methods.The steps in this direction were already made by mathematicians[5] but large amount of work is still waiting for development. Also, the issues related to symbolic dynamic and finite state automata interpretation of the results presented in this paper were left completely outside the scope of this paper. Interested reader can ,in part, correct this deficiency by reading recent review article by Adler[6].

This paper had been also motivated to some extent by the recent papers in physics literature where one and the same mathematical object is being treated by completely different methods. Specifically, in Ref.[7] the authors study the extension of the results of Aharonov-Bohm [8] to the case of two magnetic fluxes while in Ref.[9] quantum mechanics in the rectangular billiard with single pointlike scatterer was studied. Subsequently, the results of the last paper were improved [10] and generalized to many scatterers in Ref.[11]. To this list of papers ,one may add Ref.[12],etc.,while in Ref.[13] the random walks on the disordered cellular networks were studied. In this paper it is shown, that all these problems are interrelated and ,therefore, could be treated using the same mathematical methods.Moreover, other problems could be studied by these methods as well and some of these problems are discussed in section 7 . In particular, by analogy with the Aharonov-Bohm

problem in two dimensions which had become a sort of Hydrogen atom-like problem to all problems which involve physical processes in the multiply connected spaces, in three dimensions one can think of a problem about random walks in the presence of nontrivial knots mentioned already in our earlier work, Ref[14]. Such problem may have at least some biological significance since it is important to know to what extent diffusion processes are being affected by the topology of, say, knotted DNA. In this work, we use the same methods as that developed for the treatment of random walks on figure eight in order to provide some solutions to the problem of random walks in the presence of knots. Alternative methods of solution of this problem are discussed in Ref.[15]. We also reconsider the dynamics of area-preserving toral homeo(diffeo)morphisms[16] from the point of view of random walks on the Teichmüller modular group. Such reconsideration is useful for several reasons. First, it allows to discuss new ways of classifying chaotic and non-chaotic systems through the associated with them 3-manifolds. Second, it is very useful for the description of dynamics of textures in liquid crystals and particles in 2+1 gravity. In this paper, naturally, above topics are studied only in passing so that interested reader is encouraged to read our recent papers [17] for better understanding of all aspects of these problems. In this work we demonstrate how the figure 8 problem is related to the solution of David Hilbert's 21st problem(in section 5). In the same section we discuss how this problem is connected with the theory of exactly integrable systems, Knizhnik-Zamolodchikov equations, quantum groups, theory of elasticity. We would like to emphasize that our presentation is not just a review of literature: each section contains worked out examples which are original in nature. At the same time, some mathematical facts are presented along with these developments to facilitate the uninterrupted reading of the manuscript.

In section 2 some old results related to random walks on once punctured plane are revisited from the point of view of the results of Ito and McKean[18], Lyons and McKean[19] and McKean and Sullivan[20]. The rest of the paper could be considered as various attempts to extend, to reanalyze and to generalize their results to the case of multiple punctures. The guiding principle in doing this is associated with various aspects of random walks on groups, mainly free groups. The comprehensive mathematically rigorous and physically readable review of this subject can be found in Ref.[21]. In our work only very small portion of the available mathematical results is utilized. In section 3 we introduce some concepts related to groups and group presentations in order to use them in section 4 devoted to finding

the function which connects the multiply connected trice punctured sphere - the space in which the random walk on figure 8 is taking place - to the simply connected universal covering Riemann surface. Although in case of trice punctured sphere such function can be found, generalization of the methods by which it was obtained to more than three punctures represents a formidable task associated with mathematical methods which so far had been used only in string theory. We discuss these methods in the same section and later, in section 7, provide an introduction to the completely different approach to the whole problem based on mathematical ideas of Grotendieck and Belyi [22]. The results of section 4 are being put in a broader context of Riemann-Hilbert problem and Knizhnik-Zamolodchikov equations in section 5. This section also clarifies the connections with the gauge field-theoretic treatments of the same problems popular in physics literature [14]. In section 6 we develop some results of Kasteleyn [23] related to random walks on free groups. Based on this development, we reobtain the results of Lyons and McKean for transience/recurrence of random walks on the trice punctured sphere. We also provide in this section a definition of hyperbolic groups and hyperbolic spaces and show that the ultrametric spaces (used in the theory of spin glasses [4]) are just special cases of hyperbolic spaces. The results obtained in this section are further developed in section 7. In this section, solely devoted to applications, we discuss several topics. In particular, we discuss random walks in the presence of knots. We demonstrate that the transience/recurrence of random walks in the presence of a knot depends upon its nature. For example, random walk on figure 8 is related to the random walk in the complement of the figure 8 knot and, hence, is transient while random walk in the complement of the trefoil knot (the simplest among torus-type knots) is recurrent. Next, we discuss the chaotic v.s. regular behavior of such walks by analyzing their behavior with help of number-theoretic methods, by using the theory of Teichmüller spaces and by employing some facts from the theory of 3-manifolds. These methods provide new efficient ways of description of chaotic systems and are potentially useful for treatments of dynamics of liquid crystals and 2+1 gravity. Naturally, these topics are treated only superficially in this paper, but, we hope, that many illustrations which we supply along the way, should be helpful for better understanding and appreciation of much deeper results available in mathematics [24] and used in our earlier works [17] for treatment of these physical problems. This section is finished with several additional applications. For instance, use of Markov triples, known in the number theory for more than a century [25] along with the results of Grotendieck and Belyi [22] provides us with an opportunity to introduce an alternative explanation of the fractional Hall

effect. These results are also complementary to that presented in section 4. We also discuss some connections between the results the theory of free groups and the theory of braids . Such discussion reveals advantages and disadvantages of either methods for studying evolution of random walks in multiply connected spaces.

II. Some results about random walks on once punctured plane

Study of random walks on once punctured plane is closely related to the Aharonov-Bohm (A-B) effect in quantum mechanics [8].Although this problem was studied very thoroughly, here we would like to emphasize some of its aspects which, to our knowledge, had received much less attention. In particular,we would like to investigate how the description of random walks on once punctured plane $\mathbf{R}^2 - \mathbf{0}$ is related to the description of the random walks on the circle \mathbf{S}^1 .The last problem was studied in great detail by Schulman [26 ,27] and is considered to be the benchmark problem associated with quantization in multiply connected spaces [28] .

Although it is intuitively clear that both problems are connected , to establish such connection mathematically is nontrivial.Let us begin with the observation that in both cases we are dealing with multiply connected spaces.The theory of differential equations on the punctured plane was initiated already by Poincare and is known in the literature as the theory of Fuchsian equations [29,30].According to this theory ,it is essential to find a simply connected (covering)space which is associated with multiply connected (base) space.Then, the related problem is solved by lifting it to this covering (simply connected)space and then,the solution is projected down to the base space. To find a transformation from the base space space M (multiply connected) to the covering space \tilde{M} (simply connected)could be already a very difficult (and even unsolvable !) problem .Accordingly,some simplifications may be required in order to obtain at least a partial information.The circle \mathbf{S}^1 and the punctured plane $\mathbf{R}^2 - \mathbf{0}$ represent a good examples of use of general methods outlined above and are ideally suited for study of simplifications. Fortunately ,both problems could be solved completely so that they could be considered as having the same status in the theory of diffusion/quantum mechanical problems in multiply connected spaces as the Hydrogen atom problem in standard quantum mechanics.

The universal covering space \tilde{M} for the circle problem is real line \mathbf{R} so that $\mathbf{S}^1 = \mathbf{R}/\mathbf{Z}$ where \mathbf{Z} is the set of all integers .For the random walk of

N effective steps on \mathbf{R} we expect our distribution (Green's) function to be transitionally invariant , i.e.

$$G_N^{\mathbf{R}}(\tilde{x}', \tilde{x}) = G_N^{\mathbf{R}}(\tilde{x}' - \tilde{x}), \quad (2.1)$$

where $G_N^{\mathbf{R}}$ is the Green's function (end-to-end distribution function) for the random walk on \mathbf{R} and $\tilde{x}(\tilde{x}')$ is the initial (final)position of the walk in this space.Surely, Eq.(2.1) can be equivalently rewritten as

$$G_N^{\mathbf{R}}(\tilde{x}' + 2\pi n, \tilde{x} + 2\pi n) = G_N^{\mathbf{R}}(\tilde{x}', \tilde{x}), \quad (2.2)$$

where $n = 0, \pm 1, \pm 2, \dots$ The above example can be easily generalized now.

Let γ be some generator of motion(s) on \tilde{M} , $\gamma \in \Gamma$, where Γ is some group of motions on \tilde{M} , then, in general, we should require

$$G_N^{\tilde{M}}(\gamma\tilde{x}', \gamma\tilde{x}) = G_N^{\tilde{M}}(\tilde{x}', \tilde{x}). \quad (2.3)$$

since this result holds for Eq.s(2.1) and(2.2). The above equation can be equivalently rewritten as

$$G_N^{\tilde{M}}(\gamma\tilde{x}', \tilde{x}) = G_N^{\tilde{M}}(\tilde{x}', \gamma^{-1}\tilde{x}). \quad (2.4)$$

This follows easily if we replace \tilde{x} by $\gamma^{-1}\tilde{x}$ in Eq.(2.3). In the case of quantum mechanics the transition from \tilde{M} to M is made via

$$G_N^M(x', x) = \sum_{\gamma \in \Gamma} \rho(\gamma) G_N^{\tilde{M}}(\gamma\tilde{x}', \tilde{x}) \quad (2.5)$$

where $\rho(x)$ is the phase factor ,

$$\rho(\gamma) = e^{i\delta(\gamma)} \quad (2.6)$$

which is subject to the cocycle constraint [31 ,32]

$$\delta(\gamma\gamma') = \delta(\gamma) + \delta(\gamma'). \quad (2.7)$$

This constraint follows easily from the composition law (Markov property) for propagators.

In the case of punctured plane the phase factor δ is actually responsible for changes in statistics and/or for particle-hole interactions. In the case of \mathbf{S}^1 the phase $\delta = 0$ (or $\delta = \pi$) is associated with bosons (or fermions)[26]. There is yet another interpretation of the phase factor. It comes from the polymer physics .In Ref.[14] we had demonstrated that the description of the random

walks on \mathbf{S}^1 can be associated with the description of random walks (polymers) which are confined between the parallel plates (or planes) with which these walks are allowed to interact. The interactions are effectively introducing statistics so that, depending on their strength, the polymer chain acts as bosonic or fermionic quantum particle or as a particle with fractional statistics.

The result given by Eq.(2.5) still deserves some additional comments. Let us discuss the case of a simple random walk so that we can put $\delta(\gamma) = 0$. Already in Eq.(2.2) we had introduced the fundamental domain D : $0 \leq x < 2\pi$, so that the translations producing \mathbf{R} are created by the successive use of γ applied to some $x \in D$. This simple result should hold in more general cases too. That is, we expect that the manifold M should be expressible as a quotient $M = \tilde{M}/\Gamma$. More intuitively, \tilde{M} should be related to some fundamental domain in \tilde{M} so that the whole \tilde{M} is being covered (without gaps!) by translations of the fundamental domain with help of the group elements $\gamma \in \Gamma$. Consider, therefore, instead of Eq.(2.5), its modification

$$\tilde{G}_N^{\tilde{M}}(\tilde{x}', \tilde{x}) = \sum_{\gamma \in \Gamma} G_N^{\tilde{M}}(\gamma \tilde{x}', \tilde{x}). \quad (2.8)$$

Let $\gamma^{(1)} \in \Gamma$. We would like to demonstrate now that

$$\tilde{G}_N^{\tilde{M}}(\gamma^{(1)} \tilde{x}', \gamma^{(1)} \tilde{x}) = \tilde{G}_N^{\tilde{M}}(\tilde{x}', \tilde{x}) \equiv \tilde{G}_N^{\tilde{M}}(\tilde{x}' - \tilde{x}). \quad (2.9)$$

Indeed, using Eq.(2.8), we obtain

$$\tilde{G}_N^{\tilde{M}}(\gamma^{(1)} \tilde{x}', \gamma^{(1)} \tilde{x}) = \sum_{\gamma \in \Gamma} G_N^{\tilde{M}}(\gamma \gamma^{(1)} \tilde{x}', \gamma^{(1)} \tilde{x}). \quad (2.10)$$

Using Eq.(2.4), we obtain as well

$$\sum_{\gamma \in \Gamma} G_N^{\tilde{M}}\left(\left(\gamma^{(1)}\right)^{-1} \gamma \gamma^{(1)} \tilde{x}', \tilde{x}\right) = \sum_{\gamma \in \Gamma} G_N^{\tilde{M}}(\gamma \tilde{x}', \tilde{x}) \quad (2.11)$$

since $\left(\gamma^{(1)}\right)^{-1} \gamma \gamma^{(1)} \in \gamma \in \Gamma$. This proves Eq.(2.9). Using this result, it is possible to prove the following

Theorem. 2.1. *Let $G_N^{\tilde{M}}(\tilde{x}', \tilde{x})$ be the distribution function for the random walk on the covering space \tilde{M} which possesses property reflected in Eq.(2.9), then the distribution function on the base space M can be obtained from $G_N^{\tilde{M}}$ through simple identification:*

$$\tilde{G}_N^{\tilde{M}}(\tilde{x}', \tilde{x}) = G_N^M(x', x) \quad (2.12)$$

where \tilde{x}' and \tilde{x} are inverse images of x and x' under the natural projection: $\tilde{M} \rightarrow M = \tilde{M}/\Gamma$.

Proof. Please, consult Ref.[28].

Remark. 2.2. Using Eq.(2.9), it is clear, that it is sufficient that \tilde{x} and $\tilde{x}' \in D$. This means, that if we are able to find solution for the random walk problem in the covering space \tilde{M} , we can obtain solution of the random walk problem in the base space M without additional complications.

Let us illustrate the above general statements on example of the random walk on $\mathbf{R}^2 - \mathbf{0}$. Using dimensionless units we obtain the following diffusion equation,

$$\frac{\partial f}{\partial t} = \frac{1}{4} \left(\frac{\partial^2}{\partial x^2} + \frac{\partial^2}{\partial y^2} \right) f, \quad (2.13)$$

where the factor $\frac{1}{4}$ (the diffusion coefficient) is chosen for further convenience and $f = f(x, y; t)$ with $t \in \mathbf{N}$. It is convenient to rewrite Eq.(2.13) in terms of complex variables: $z = x + iy, \bar{z} = x - iy$. Simple calculation produces then

$$\frac{\partial f}{\partial t} = \frac{\partial^2}{\partial z \partial \bar{z}} f. \quad (2.14)$$

Since this equation is not defined for $z = \bar{z} = 0$, we would like to introduce new complex variable w via $z = \exp\{w\}$. Unlike z , the complex variable $w = u + iv$ is defined on the entire complex w -plane. In terms of w -variable Eq.(2.14) can be rewritten as

$$\begin{aligned} \frac{\partial f}{\partial t} &= e^{-2u} \frac{\partial^2}{\partial w \partial \bar{w}} f \\ &= e^{-2u} \frac{1}{4} \left(\frac{\partial^2}{\partial u^2} + \frac{\partial^2}{\partial v^2} \right) f. \end{aligned} \quad (2.15)$$

Obtained equation describes Brownian motion on a simply connected covering space \tilde{M} which is the Riemann surface of the logarithmic function, i.e.

$$w = \ln |z| + i(\arg z + 2\pi n), n = 0, \pm 1, \pm 2, \dots, \quad (2.16)$$

and is known to be simply connected. The result just obtained coincides with that discussed in the book by Ito and McKean, e.g. see page 280 of Ref.[18]. Ito and McKean argue (without demonstration) that the diffusion Eq.(2.15) can be converted into the form given by Eq.(2.13) by replacing Brownian time t by another, actually, random time T .

The idea of the proof goes back to Paul Levi [33] and was refined by others [34]. Let us discuss in some detail how this can actually be done. To this purpose, let us rewrite Eq.(2.15) in the following equivalent form

$$\frac{\partial f}{\partial t} e^{2u} = \frac{1}{4} \left(\frac{\partial^2}{\partial u^2} + \frac{\partial^2}{\partial v^2} \right) f. \quad (2.17)$$

Now let us select new time T by requiring

$$\frac{dT}{dt} = \exp\{-2u(T)\}$$

or, equivalently,

$$t = \int_0^T d\tau \exp\{2u(\tau)\}. \quad (2.18)$$

This then will bring Eq.(2.17) back to the form of Eq.(2.13) as anticipated. Eq.(2.18) coincides with that presented on page 280 of Ito and McKean [18] where it was given without derivation. In spite of its simple form, thus transformed diffusion equation will depend upon the random time T since $u(t)$ is Brownian motion. Accordingly, the observables calculated with help of such diffusion equation will require an extra averaging. This may sometimes be inconvenient in practical calculations. To recognize this difficulty we shall discuss a generic example which exhibits all the features involved. Before doing so, several remarks are in order.

First, it is clear, that in more general case of multiple punctures one has to find an analogue of Eq.(2.16), i.e. to find some function $z = \Phi(w)$ such that w -plane (actually Riemann surface) is going to be an universal covering space \tilde{M} which is simply connected by construction.

Second, to find such function is not an easy task and may not be possible in general, e.g. sections 4 and 7 below. Nevertheless, if such function can be found, then, by analogy with Eq.(2.15), we will be able to write

$$\frac{\partial f}{\partial t} = \frac{1}{4} \left| \Phi'(w) \right|^{-2} \left(\frac{\partial^2}{\partial u^2} + \frac{\partial^2}{\partial v^2} \right) f \quad (2.19)$$

and, accordingly, the new time can be defined as

$$t = \int_0^T d\tau \left| \Phi'(w(\tau)) \right|^2 \quad (2.20)$$

so that the diffusion equation ,Eq.(2.19) ,again acquires its canonical form given by Eq.(2.13) in accord with general result by Paul Levi[33].

Let us now return back to our example of once punctured plane.In this case, the explicit form of the end-to- end distribution function is well known,e.g. see Refs.[14,18,35] ,and in polar system of coordinates it is given by

$$G(r_1, r_2, \Delta\theta; t) = \frac{1}{2\pi t} \exp\left\{-\frac{r_1^2 + r_2^2}{t}\right\} \sum_{m=-\infty}^{\infty} e^{im\Delta\theta} I_m(z) \quad (2.21)$$

,where $\Delta\theta = \theta_2 - \theta_1$, $z = 2r_1 r_2 / t$ and $I_m(z) = I_{-m}(z)$ is the modified Bessel's function. The above distribution function can be used either for study of the radial or the angular distributions or both . Suppose,we are interested in the angular distribution function only .Then,using Eq.(2.21),it is convenient to introduce the normalized distribution function defined according to the following prescription :

$$F(z, \Delta\theta) = \frac{G(r_1, r_2, \Delta\theta; t)}{G(r_1, r_2, 0; t)} = \frac{1}{I_0(z)} \sum_{m=-\infty}^{\infty} e^{im\Delta\theta} I_{|m|}(z). \quad (2.22)$$

The Fourier transform of such defined distribution function can now be obtained in a standard way as

$$F(z, \alpha) = \int_{-\infty}^{\infty} d\Delta\theta e^{-i\alpha\Delta\theta} F(z, \Delta\theta) = \frac{I_{|\alpha|}(z)}{I_0(z)}. \quad (2.23)$$

Let us now choose $r_2 = \hat{r}\sqrt{t} + r_1$. This choice is motivated by known scaling properties of Brownian motion [34]. For large t one obtains : $z \simeq 2r_1 \hat{r} / \sqrt{t}$. For fixed \hat{r} and r_1 and $t \rightarrow \infty$ one surely expects $z \rightarrow 0$. Using known asymptotic expansion of $I_{|\alpha|}(z)$ for small z 's in Eq.(2.23) allows us to obtain closed form analytic expression for $F(z, \alpha)$ in this limit as

$$F(z, \alpha) \simeq \exp\left\{-\frac{|\alpha|}{2} \ln t\right\}. \quad (2.24)$$

The inverse Fourier transform of Eq.(2.24) produces famous Cauchy-type distribution for $\Delta\theta$

$$P(x = \frac{2\Delta\theta}{\ln t}) dx = \frac{1}{\pi} \frac{1}{1+x^2} dx \quad (2.25)$$

obtained originally by Spitzer in 1958 [2] in much more complicated way.

Let us now reproduce this result with help of the random time change discussed above. To this purpose, let us begin with the classical Lagrangian L for the fictitious Brownian particle traveling in the punctured plane. By introducing polar system of coordinates our L can be written as

$$L[\tau] = \frac{1}{2} \left(\dot{r}^2 + r^2 \dot{\theta}^2 \right). \quad (2.26)$$

The path integral for such particle can be written now in a usual way as

$$G(r_1, r_2, \Delta\theta; t) = \int D[r[\tau], \theta[\tau]] \exp\left\{-\int_0^t d\tau L[\tau]\right\} \quad (2.27)$$

where the limits of path integration are not written explicitly. Following the same line of arguments as that which had lead us from Eq.(2.13) to (2.15) let us represent r -variable through x -variable defined by $r = \exp x$. Surely, for $-\infty < x < \infty$, we have $0 < r < \infty$ as required. The Lagrangian L is now being converted to

$$L = \frac{1}{2} e^{2x} (\dot{x}^2 + \dot{\theta}^2) \quad (2.28)$$

which, in view of Eq.(2.27), should have its analogue in Eq.(2.15). Consider now the change of time variable inside of the path integral in Eq.(2.27). That is we have $\tau = \tau(T)$ so that, for example,

$$\frac{dx}{dT} \frac{dT}{d\tau} \text{ and, accordingly, } d\tau \left(\frac{dx}{d\tau} \right)^2 = dT \frac{dT}{d\tau} \left(\frac{dx}{dT} \right)^2. \quad (2.29)$$

This then requires us to make a choice for $\frac{dT}{dt}$ which is identical with that made in Eq.(2.18) so that in terms of new time T our path integral, Eq.(2.27), represents, indeed, a free diffusion process in which x and θ are two independent Brownian motions in accord with our previous calculations. Let us now calculate the generating function $F(z, \alpha)$ which was defined in Eq.(2.23) but, this time, with help of the propagator Eq.(2.27) (with time rescaled). We have

$$F(z, \alpha) = \left\langle e^{i\alpha \int_0^T d\tau \theta(\tau)} \right\rangle \quad (2.30)$$

where $\langle \dots \rangle$ denotes functional integral averaging with help of the properly normalized propagator, Eq.(2.27). The Gaussian integration can be trivially

performed now with the result :

$$F(z, \alpha) = \int_0^\infty dT \int_{x_1(0)}^{x_2(T)} D[x(\tau)] \delta(t - \int_0^T d\tau \exp\{2x(\tau)\}) \exp\{-\frac{1}{2} \int_0^T d\tau (\dot{x}^2 + \alpha^2)\}. \quad (2.31)$$

In arriving at this result we took into account the constraint ,Eq.(2.18),so that the final answer is written in terms of the unrescaled time.The constraints of this sort were discussed before in Refs [36,37].The presence of constraint complicates calculations somehow.To by- pass this difficulty,the Laplace transform of Eq.(2.31) can be taken with the result

$$F_s(z, \alpha) = \int_0^\infty dT \int_{x(0)}^{x(T)} D[x(\tau)] \exp\{-\frac{1}{2} \int_0^T d\tau (\dot{x}^2 + \alpha^2 + 2s \exp\{2x(\tau)\})\} \quad (2.32)$$

where the Laplace variable s is conjugate to time τ .The corresponding Schrödinger-like equation can be now easily written as

$$\left[s \exp\{2x\} - \frac{1}{2} \left(\frac{\partial^2}{\partial x^2} - \alpha^2 \right) \right] F_s(z, \alpha) = \delta(x - x'). \quad (2.33)$$

By using again r -variable(instead of x) we obtain instead of Eq.(2.33) the following equivalent equation ($x \neq x'$)

$$\left[sr^2 - \frac{1}{2} \left(r^2 \frac{\partial^2}{\partial r^2} + r \frac{\partial}{\partial r} - \alpha^2 \right) \right] F_s(z, \alpha) = 0 \quad (2.34)$$

in which one can easily recognize the equation for the modified Bessel's function(s) I_α and K_α . The Green's function can be constructed with help of these functions in a standard way,e.g.see Ref.[18] ,with the result :

$$F_s(z, \alpha) = \begin{cases} I_{|\alpha|}(\sqrt{2sr_1})K_{|\alpha|}(\sqrt{2sr_2}) & \text{if } r_1 < r_2 \\ K_{|\alpha|}(\sqrt{2sr_1})I_{|\alpha|}(\sqrt{2sr_2}) & \text{if } r_2 < r_1 \end{cases} . \quad (2.35)$$

With help of this function the inverse Laplace transform now can be performed with help of Eq.(56) of Cr.5 of Bateman and Erdelyi [38] resulting in

$$F(z, \alpha) = \frac{1}{2t} \exp\{-\frac{r_1^2 + r_2^2}{t}\} I_{|\alpha|}(z) \quad (2.36)$$

It is clear ,that this result coincides with earlier obtained Eq.(2.23) provided that it is properly normalized.

From the above derivation it is clear that the entire distribution function,Eq.(2.21),can also be obtained. By repeating the same steps as we have used to arrive at Eq.(2.33) ,we obtain now

$$\left[s \exp\{2x\} - \frac{1}{2} \left(\frac{\partial^2}{\partial x^2} + \frac{\partial^2}{\partial \theta^2} \right) \right] G(x, x', \theta) = \delta(x - x') \delta(\theta - \theta'). \quad (2.37)$$

This equation is defined in the fundamental domain in the covering space \tilde{M} which is just strip of finite width 2π in θ direction and infinite $-\infty < x < \infty$ in x direction. Naturally,this equation coincides with Eq.(2.17) (if the Laplace transform of Eq.(2.17) is performed).It is remarkable that the radial and the angular Brownian motions are completely decoupled in terms of variables which we are using.

If,as before ,we introduce r -variable via $r=\exp x$,then Eq.(2.37) becomes again Bessel-type equation for the corresponding Green's function.The fundamental domain D under such change will be converted from an infinite strip to the whole $r-\theta$ plane with cut along the positive semiaxis.In this case we observe that Eq.(2.21) is in accord with Eq.(2.12) as required.Evidently,we could as well use the strip of width π ,then the strip is converted into the upper half plane.The Riemann surface of the logarithm can be made by properly gluing together either the stuck of cut $r-\theta$ planes or half planes .That is the Riemann surface can be described (or constructed) in several ways [38].The half plane description is especially useful since it allows to obtain the Cauchy-type distribution at once [34].At the same time,the description in terms of $r-\theta$ variables leads to the undesirable coupling between the radial and the angular Brownian motions.Indeed,the Green's function for the circle S^1 of radius r is known [26,31] to be expressed as

$$G(\Delta\theta, t) = \frac{1}{2\pi} \sum_{m=-\infty}^{\infty} e^{im\Delta\theta} e^{-\frac{tm^2}{4r^2}} . \quad (2.38)$$

For $r_1 = r_2$ and $z \gg 1$ use of the asymptotic estimate [40]

$$I_n \simeq \frac{1}{\sqrt{2\pi z}} \left(1 + \frac{1}{8z} + O(z^{-2}) \right) \exp\left\{ z - \frac{n^2}{2z} + O(z^{-2}) \right\}$$

allows us to bring Eq.(2.21) into the form

$$G(r_1 = r_2 = r, \Delta\theta; t) \simeq \sqrt{\frac{t}{4\pi r^2}} \sum_{m=-\infty}^{\infty} e^{im\Delta\theta} e^{-\frac{tm^2}{4r^2}} . \quad (2.39)$$

Hence, in terms of usual polar coordinates, it is impossible to disentangle the angular and the radial parts of Brownian motion for **arbitrary** values of r and t . At the same time, depending upon the questions being asked, it may be sufficient to use, say, the angular part, e.g. Eq.(2.38) only. Moreover, the obtained results can be generalized to d -dimensions. In this case the Green's function analogue of S^1 problem is known to be [18]

$$G(\theta_1, \theta_2; t) = \sum_{n=0}^{\infty} e^{-t\gamma_n} \sum_{l \leq m(n)} S_n^l(\theta_1) S_n^l(\theta_2) \quad (2.40)$$

with $\gamma_n = \frac{1}{2}n(n + d - 2)$ and $S_n^l(\theta)$ obeying the generalized spherical harmonics equation

$$\frac{1}{2} \nabla^2 S_n^l = \gamma_n S_n^l. \quad (2.41)$$

The above Green's function should be compared with that for $\mathbf{R}^2 - \mathbf{0}$. As results of Ref.[18] indicate, the reduction analogous to that given by Eq.(2.39) is **not** possible for $d > 2$.

In the case of random walks the most commonly asked questions are associated with the probability of returning to the origin (or to a given site) and with the mean time spent at the origin (or at a given site) [41]. Unfortunately, the continuum formulation of the random walk problems is not well suited for treatment of these problems. Indeed, let us consider the standard (Gaussian-like) propagator for the random walk in d -dimensions given by [31]

$$G_N(\mathbf{x}_1 - \mathbf{x}_2) = \left(\frac{1}{4\pi N} \right)^{\frac{d}{2}} \exp\left\{ -\frac{(\mathbf{x}_1 - \mathbf{x}_2)^2}{4N} \right\}. \quad (2.42)$$

The mean time $\langle T \rangle$ spent at the origin is defined by the Laplace transform given by

$$\langle T \rangle = \lim_{s \rightarrow 0^+} \int_0^{\infty} dN e^{-sN} G_N(0) \simeq \int \frac{d^d k}{(2\pi)^d} \frac{1}{k^2}. \quad (2.43)$$

Surely, this quantity is not well defined in **any** dimension. Use of spherical coordinates converts Eq.(2.43) into

$$\langle T \rangle \approx \int_0^{\infty} dk k^{d-3} \equiv G(0). \quad (2.44)$$

More accurate lattice calculations indicate [42] that the above integral is actually finite for $d=3$ and divergent for $d=1$ and 2 . The probability $\Pi(0)$ of returning to the origin is known to be related to $G(0)$ as follows [41,42] :

$$\Pi(0) = 1 - \frac{1}{G(0)} . \quad (2.45)$$

accordingly, the random walk is **recurrent** or **transient** depending upon $\Pi(0)$ being equal or lesser than one.

Going back to our initial problem we would like to find out if the recurrence (or transience) for S^1 problem can help us to establish the recurrence/transience for $\mathbf{R}^2 - \mathbf{0}$ problem. Looking at Eqs. (2.38),(2.39) we notice that, at least for $z \gg 1$, such questions are legitimate to ask.

Using Eq.(2.38) for $\Delta\theta = 0$ we obtain,

$$G(0) = \frac{2r^2}{\pi} \sum_{m=-\infty}^{\infty} \frac{1}{m^2} = \infty . \quad (2.46)$$

From here we conclude that the random walk on S^1 is recurrent. Let us consider now the full expression, Eq.(2.21) ,for the propagator in $\mathbf{R}^2 - \mathbf{0}$ plane. We obtain,

$$G(0) = \frac{1}{2\pi} \sum_{m=-\infty}^{\infty} \int_0^{\infty} \frac{dt}{t} \exp\{-\frac{r^2}{t}\} I_m(\frac{2r^2}{t}) . \quad (2.47)$$

For integer m we get $I_m(z) = I_{-m}(z)$. Therefore ,to evaluate $G(0)$ we can use the series expansion for $I_m(z)$, $m \geq 0$:

$$I_m(z) = \sum_{n=0}^{\infty} \frac{(\frac{z}{2})^{2n+m}}{n! \Gamma(m+n+1)} . \quad (2.48)$$

Substitution of this expression into Eq.(2.47) and use of the standard tables of integrals provides us with generic result:

$$\begin{aligned} I &= \int_0^{\infty} dx x^{\nu-1} \exp\{-\frac{\beta}{x} - \gamma x\} \\ &= 2 \left(\frac{\beta}{\gamma}\right)^{\frac{\nu}{2}} K_{\nu}(2\sqrt{\beta\gamma}) \end{aligned}$$

for the integral in Eq.(2.47) which ,when combined with Eqs.(2.47) and (2.48) leads us to the same conclusion : $G(0) = \infty$.Using different arguments,McKean and Lyons [19] have reached the same conclusion: Brownian motion on once punctured plane is recurrent.This means,in particular,that the polymer lying in the plane **cannot** be entangled with another polymer which is perpendicular to this plane.The planarity of the problem is not too restrictive ,e.g. see Ref.[14].This means that the same result will remain correct in case of cylindrically symmetric problem.The situation changes drastically if,instead of **one** hole ,we would consider planar Brownian motion in the presence of **two** holes.This problem and its generalizations is considered in the rest of this paper.

III. The trice punctured sphere as hyperbolic Riemann surface

In the previous section the task of finding the universal covering surface \tilde{M} for the once punctured plane was solved rather straightforwardly.The mapping $z = \exp w$ (or $w = \ln |z| + i(\arg z + 2\pi n)$) with $z \in M$ and $w \in \tilde{M}$ provides the desired answer.This answer was obtained,however,not in a systematic way but rather by a simple guessing.If two (or more) punctures are involved ,a simple guessing can hardly help.Therefore,to find the covering space \tilde{M} and the mapping function $z = f(w)$ becomes a problem on its own.There are many ways to arrive at correct answer (which for the case of arbitrary number and arrangement of punctures may not even exist ,e.g.see Section 4).In this work we choose the group-theoretic method which is directly associated with the homotopy theory used for treatment of diffusion on the circle S^1 discussed in Section 2.An excellent introduction to the homotopy (and also to the knot) theory is Ref.[43] to which we refer our readers for more comprehensive treatment(s).Some facts about the combinatorial group theory can be found in accessible form in Refs[44,45].

Let us begin with the following observation.The once punctured sphere $S^2 - \mathbf{0}$ is actually simply connected(i.e.each point can be connected with any other so that all paths are homotopically equivalent).The twice punctured sphere is equivalent to $\mathbf{R}^2 - \mathbf{0}$ and ,therefore,the covering problem we had studied already in previous section.The homotopy classes in this case are made of paths with different winding numbers.The homotopy group is free infinite cyclic and abelian with just one generator a so that paths with different winding numbers are made of successive applications of a and a^{-1} .Surely, $a^m a^n = a^n a^m$ for windings m and n since the group is abelian.Let us now

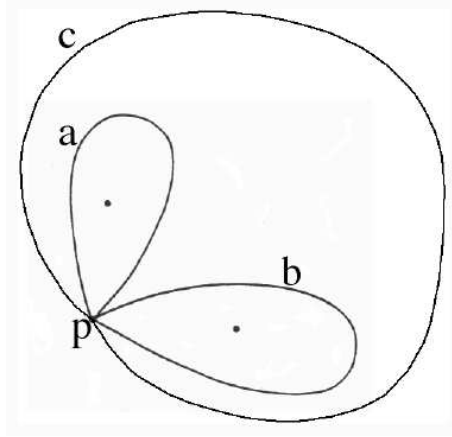

Figure 1: Homotopy of paths(with respect to some arbitrary point p) on the trice punctured sphere

consider the trice punctured sphere (or twice punctured plane).The homotopically nonequivalent paths are depicted in Fig.1.

The homotopy group is made of generators a and b related to the windings around the first and the second puncture respectively. Lyons and McKean [19] and McKean and Sullivan [20] in their study of diffusion on the trice punctured sphere introduce yet another generator c which is associated with windings around the point at infinity. The homotopy group is non-abelian with 3 generators a, b and c subject to one relation

$$abc = 1 \tag{3.1}$$

The combinatorial group theory teaches us [44] ,that **any** group G can be described in terms of set of generators $\{a_i\}$ and relations $\{R_i\}$ between some (or all) of group elements.The generators and relations form a **presentation** for the group G ,i.e.

$$G = \langle a_1, \dots, a_n \mid R_1, \dots, R_k \rangle . \tag{3.2}$$

In the cases when there are no relations the groups are called **free**. It can be proven that **any** free group with two or more generators is non-abelian. It also can be proven that any group G can be considered as some subgroup of the free group (with sufficient number of generators).In our case we have

$$G = \langle a, b, c \mid abc = 1 \rangle \tag{3.3}$$

This is a special case of the so called triangle groups [45] to be further discussed in section 7. At first sight it looks like this group is **not** free. This, however, is **not** the case. Indeed, let us notice first that $c=(ab)^{-1}$. Consider now the combinations ab and ba . If the relation $abc = 1$ would be absent and, instead, we would have just free group made of two elements a and b , then we can construct a word W (actually, the **reduced** word) via

$$W = a^{\alpha_1} b^{\beta_1} \dots a^{\alpha_r} b^{\beta_r} \quad (3.4)$$

where α_1 and β_r can be **any** integers while α_i and β_i are any integers, **except zero**. Evidently, the word W encodes some specific pattern of windings around the first and the second puncture. If, instead of elements a and b we would consider the combinations $\hat{a} = ab$ and $\hat{b} = ba$, then, we can again construct some word, just like in Eq.(3.4). The totality of all words based on generators \hat{a} and \hat{b} happens to be the same as that based on generators a and b [44]. But c is just \hat{a}^{-1} ! Because of this, the group based on presentation given by Eq.(3.3) is actually free group constructed of two generators, i.e. presentation given by Eq.(3.3) can be replaced by the equivalent presentation

$$G = \langle a, b \mid \rangle . \quad (3.5)$$

It can be shown [44], that such defined free non-abelian group can be realized with help of, say, 2×2 matrices

$$a \implies \left\| \begin{array}{cc} 1 & 0 \\ x & 1 \end{array} \right\| \quad \text{and} \quad b \implies \left\| \begin{array}{cc} 1 & x \\ 0 & 1 \end{array} \right\| \quad (3.6)$$

so that

$$a^n = \left\| \begin{array}{cc} 1 & 0 \\ nx & 1 \end{array} \right\| \quad \text{and} \quad b^n = \left\| \begin{array}{cc} 1 & nx \\ 0 & 1 \end{array} \right\| \quad (3.7)$$

where x is some rational number. The above introduced matrices are unimodular. This means the following. Let z be some complex number. The group of unimodular transformations is made of transformations of the type

$$z \rightarrow \frac{az + b}{cz + d} \quad (3.8)$$

such that the determinant $DetL = ad - bc$ of the matrix

$$L = \left\| \begin{array}{cc} a & b \\ c & d \end{array} \right\| \quad (3.9)$$

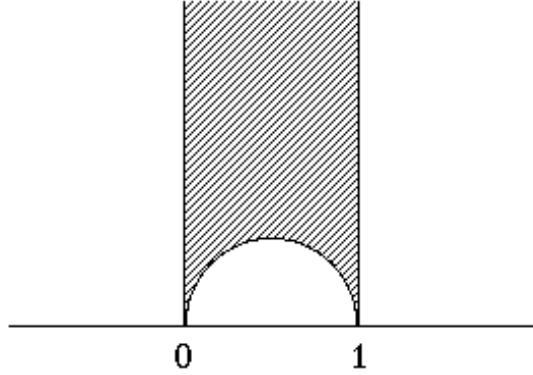

Figure 2: The fundamental triangle on H^2

is equal to one. Clearly, transformations defined by matrices a and b are unimodular. It is known [46] that the unimodular transformations are acting on the upper half plane (Poincaré model H^2 of the hyperbolic plane) defined by

$$H^2 = \{x + iy = z \in \mathbb{C} \mid y > 0\} \quad (3.10)$$

by mapping it to itself.

The H^2 is the universal covering space for every Riemann surface of genus $g > 1$ [46, 47]. Such surface can be constructed with help of some fundamental polygon D in H^2 . The appropriately chosen (see below) unimodular transformations will translate (tessellate) this polygon across H^2 so that the entire H^2 will be covered by copies of this polygon **without gaps**. This picture is an elementary extension of a much simpler picture of torus as a quotient of the Euclidean plane by the group of translations tessellating the fundamental quadrangle or of a circle S^1 as quotient \mathbf{R}/\mathbf{Z} which we had studied in Section 2.

For the trice punctured sphere we can choose one puncture at infinity while two others at points 0 and 1 respectively. Then, the fundamental triangle is depicted in Fig. 2.

Naturally, the vertices of this triangle should not belong to the triangle itself. If the H^2 plane is filled by such tessellated triangles, the w -plane is covered by an infinity of the upper and lower half-planes which are the con-

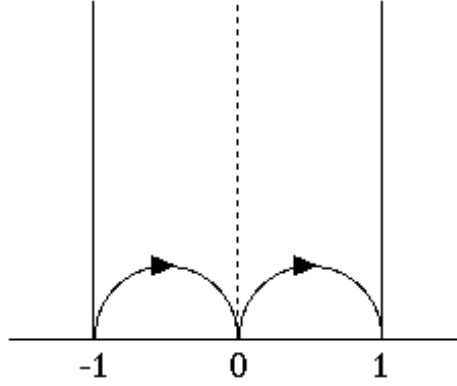

Figure 3: The fundamental quadrangle on H^2 . It is also used for description of the punctured torus, e.g. see Ref. [1] and Fig.13 below.

formal images of the tessellated triangles. Each half-plane has three "neighbors" which are connected with it along the stretch $0 < w < 1$ and two rays $-\infty < w < 0$ and $1 < w < \infty$ respectively. The totality of half-planes connected with each other in the way just indicated forms the modular surface \tilde{M} (one way of making Riemann surfaces [48]). The modular surface \tilde{M} is the universal covering surface for the twice punctured sphere. More exactly, the motion of some Brownian walker on the twice punctured plane around puncture(s) can be associated with the motion of its image on H^2 . The topology of the twice punctured plane model is actually the same as for the once punctured torus. This fact was briefly discussed in our earlier work, Refs [1,14].

Let us discuss now some consequences of this observation. In the next section we are going to find the explicit form of the function which maps the complex plane with cuts (or better \tilde{M}) into H^2 . Let $w = J(z)$ be such function so that $w \in \tilde{M}$ and $z \in H^2$. Consider action of such defined function on the fundamental triangle depicted in Fig.2. without loss of generality, it is more convenient to consider two adjacent triangles as depicted in Fig.3.

These triangles make up the region $R \subset H^2$ bounded by two vertical lines $\text{Re} z = \pm 1$ and two semicircles $|z \pm \frac{1}{2}| = \frac{1}{2}$. The left boundary $\text{Re} z = -1$ is connected with the right boundary $\text{Re} z = 1$ with help of translation: $b(z) = 2 + z$ while the lower left boundary $|z + \frac{1}{2}| = \frac{1}{2}$ is connected with the lower

right $|z - \frac{1}{2}| = \frac{1}{2}$ by means of transformation $a(z) = \frac{z}{2z+1}$. Comparison with Eqs(3.6) and (3.8) indicates that the combination of such defined motions do constitute free non-abelian group composed of two generators. For the function $J(z)$ we have to require

$$J(a(z)) = J(z) \quad (3.11a)$$

and also

$$J(b(z)) = J(z) \quad (3.11b)$$

in order to achieve the tessellation of H^2 without gaps.It could be shown as well that

$$J(ab(z)) = J(ba(z)) = J(z) \quad (3.12)$$

Such equations are the defining relations for the automorphic function $J(z)$. At this point,several questions arise. First,are the above transformations $a(z)$ and $b(z)$ unique ?Second,based on these transformations alone can one find the explicit form of the function $J(z)$ by using the periodicity properties shown above ? The answer to the first question is negative.Already Eqs.(3.6) and (3.7) indicate that this is **not** the case.At the same time, for given set of a and b generators it is possible to find the automorphic function $J(z)$ which will possess the required transformation properties. Non uniqueness of the transformations leads to the non uniqueness of the fundamental polygon D on which these generators act.Recent studies had shown [49] that some choice of generators of the free group $G(\mu)$,e.g.

$$\begin{aligned} b(z) &= 2 + z \\ a(z) &= \mu + \frac{1}{z} \end{aligned} \quad (3.13)$$

where $\mu_1 = 3i$;or $\mu_2 = 0.0533 + 1.9i$,etc also describe the homotopy group of the punctured torus. For the case $\mu_1 = 3i$ a simple connected domain $D \in H^2$ is depicted in Fig.4.

Action of generators $a(z)$ and $b(z)$ on the fundamental polygon **does not** lead to the tessellation of the entire H^2 .Instead ,the above free group tessellates some subdomain Δ of H^2 so that the quotient Δ/G is still the punctured torus.For $\mu = \mu_2$ the domain Δ is depicted in Fig.5 and has, by now familiar,fractal-like shape.We shall not go into details of such much more elaborate treatment of the punctured torus .For less exotic situations ,e.g.that depicted in Fig.3,the explicit form of the function $J(z)$ can be found and this task is accomplished in the next section.

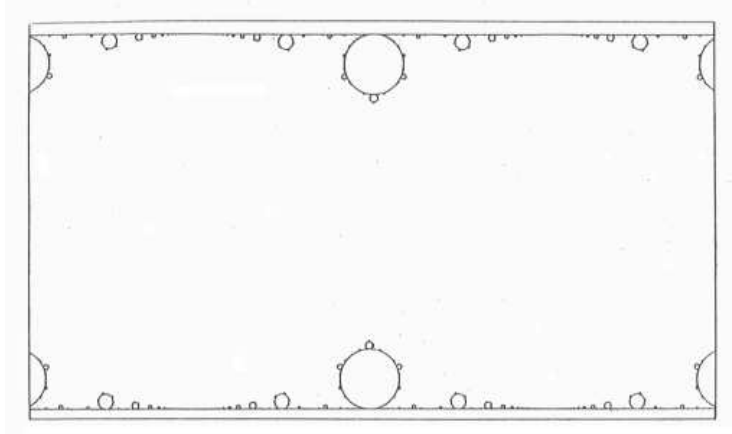

Figure 4: A simply connected domain D of H^2 whose quotient $D/G(\mu_1)$ produces the punctured torus \square

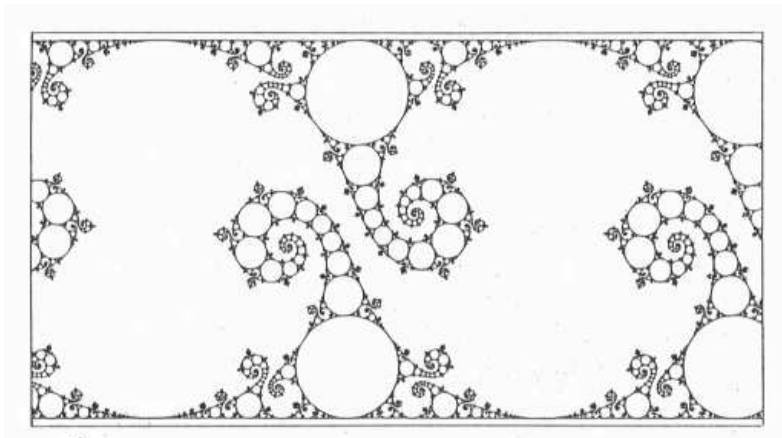

Figure 5: A simple connected domain D of H^2 whose quotient $D/G(\mu_2)$ produces punctured torus as well. \square .

IV. Uniformization of the n-punctured sphere

On the sphere $S^2 = C \cup \{\infty\}$ let us consider a region Ω obtained by removing a finite number of points, i.e. $\Omega = S^2 \setminus \{p_1, \dots, p_n\}$ with $n \geq 3$. According to the uniformization theorem there must be some meromorphic function λ which provides the universal covering map of Ω by H^2 defined by Eq.(3.10). Suppose J is some function which maps H^2 into Ω , then if g is some function which maps H^2 to H^2 (e.g.see Eq.(3.8)), then $J = \lambda \circ g$, where \circ denotes the functional composition. Surely, such defined function J coincides with that which was introduced earlier, e.g.see Eq.s (3.11),(3.12). The function J is locally invertible so that a closed path in Ω has as its image a closed path in H^2 if and only if it is homotopic to zero. A closed path in Ω with, say, winding number +1 with respect to p_k and 0 with respect to p_j , $j \neq k$, lifts to a path in H^2 with the point $T_k z$, where T_k is related to one of the homotopy generators, e.g. a (or b), discussed in the previous section. Evidently, by analogy with Eq.(3.1), we can write in this more general case

$$T_1 T_2 \dots T_n = 1 \quad (4.1)$$

Let us now connect points p_1 and p_2 by a simple (without crossings) arc q_1 and let us proceed in the same fashion with p_2 and p_3, \dots, p_n and p_1 . Then, Ω is being decomposed into two simply connected regions G_1 and G_2 . Upon mapping into H^2 these regions will go into subregions of H^2 whose boundary meets the real line ($y = 0$) at $2n-2$ points. Fig.3 represents just an example of this sort. In this case we have 3 points -1, 0 and +1 of the fundamental region R located on the real line while the fourth point is located at $\pm\infty$ of real line. In order to find such mapping the following theorem is helpful[50].

Theorem.4.1. *Suppose $z = J(w)$ where $w \in H^2$ is universal covering map of Ω , then, $\{w, z\}$ is meromorphic function of z given by*

$$\{w, z\} = \frac{1}{2} \sum_{k=1}^n \frac{1}{(z - p_k)^2} + \sum_{k=1}^n \frac{m_k}{z - p_k} \quad (4.2)$$

where the Schwarzian derivative $\{w, z\}$ is defined by

$$\{w, z\} = \left[\left(\frac{w''}{w'} \right)' - \frac{1}{2} \left(\frac{w''}{w'} \right)^2 \right] \quad (4.3)$$

with $w = w(z) \equiv J^{-1}(z)$ and $w' = \frac{dw}{dz}$, etc, and constants m_k are subject to relations:

$$\sum_{k=1}^n m_k = 0,$$

$$\sum_{k=1}^n (2m_k p_k + 1) = 0, \quad (4.4)$$

$$\sum_{k=1}^n (m_k p_k^2 + p_k) = 0.$$

Eq.4.2 is the third order nonlinear differential equation whose solution may or may not be easy to find. However, already Poincare' had discovered [29] that ,instead of struggling with solution of Eq.(4.2) ,one can consider much simpler second order linear differential equation of the type

$$y'' + \frac{1}{2}\{w, z\}y = 0. \quad (4.5)$$

In order to solve Eq.(4.5) the r.h.s.of Eq.(4.2) must be used. Then, the obtained equation is of Fuchsian type[30] and can be solved, provided that the constants m_k (the accessory parameters) are known. Eq.(4.5) produces two linearly independent solutions y_1 and y_2 . The most spectacular outcome of all this can be summarized as follows:

Theorem 4.2 . *If two independent solutions of Eq.(4.5) are known, then the mapping function $w = w(z)$ can be determined from solutions of one of the following equations:*

$$y_1 = w (w')^{-\frac{1}{2}} \quad \text{or} \quad y_2 = (w')^{-\frac{1}{2}}. \quad (4.6)$$

To find the accessory parameters m_k is not an easy task in general. Recent results of conformal and string theory provide some new results in this direction. Before discussing these results, let us illustrate how the results just described work in the case of twice and trice punctured sphere. In the first case we may associate p_1 with $z = 0$ so that the combined use of Eqs(4.2)-(4,5) produces the following differential equation:

$$y'' + \frac{1}{4z^2}y = 0. \quad (4.7)$$

Looking for solution of Eq.(4.7) in the form $y = z^\alpha$ we can easily obtain $y_{1,2} = \sqrt{z}$.Using Eq.(4.6) we obtain as well

$$\sqrt{z} = \left(\sqrt{w'(z)} \right)^{-1} \quad (4.8)$$

This leads us immediately to

$$w = \ln |z| + \text{const} \quad (4.9)$$

The obtained result is incomplete agreement with earlier obtained, Eq.(2.16).

In the second case we may associate p_1 with $z = 0$, p_2 with $z = 1$ and p_3 with $z = \infty$. The combined use of Eqs(4.2)-(4.5) then produces

$$y'' + \left\{ \frac{1}{z^2} + \frac{1}{4(z-1)^2} + \frac{1}{4z} - \frac{1}{4(z-1)} \right\} y = 0. \quad (4.10)$$

This equation can be reduced to that for the hypergeometric function if we use the following substitution:

$$y(z) = \sqrt{z(z-1)} f(z). \quad (4.11)$$

Then, for the function $f(z)$ we obtain the following hypergeometric equation:

$$z(z-1)f'' + (1-2z)f' - \frac{1}{4}f = 0. \quad (4.12)$$

Let us recall that the hypergeometric function F obeys in general equation of the type

$$z(z-1)F'' + [c - (a+b+1)z]F' - abF = 0 \quad (4.13)$$

which has solution in terms of the following series expansion

$$F(a, b, c; z) = 1 + \frac{a \cdot b}{c \cdot 1} z + \frac{a \cdot (a+1) \cdot b \cdot (b+1)}{c \cdot (c+1) \cdot 1 \cdot 2} z^2 + \dots \quad (4.14)$$

For a special values of a, b and c and also z this expansion coincides exactly with the series expansion for the complete elliptic integral K defined by

$$K = \int_0^{\frac{\pi}{2}} dx \frac{1}{\sqrt{1 - k^2 \sin^2 x}}. \quad (4.15)$$

For this to happen, we have to require $a = b = \frac{1}{2}, c = 1$ and $z = k^2$ in Eq.(4.13). This then produces [48]

$$K = \frac{\pi}{2} F\left(\frac{1}{2}, \frac{1}{2}, 1; k^2\right) \quad (4.16)$$

Using these results we conclude that K is solution of Eq.(4.12) (since the values of constants a, b and c produce Eq.(4.12)) in which we have to replace z by k^2 . Another independent solution of Eq.(4.12) can be obtained if we replace k^2 in Eq.(4.16) by $(k')^2 = 1 - k^2$. From the theory of elliptic functions it is known that $(k')^2$ should not touch the real axis which is cut from $z=0$ to $z=-\infty$. This circumstance implies then that k^2 should not touch the real axis cut from $z=1$ to $z=+\infty$. Using Eq.(4.6) we obtain now

$$\frac{y_1}{y_2} = w(z) = \frac{K'(z)}{K(z)} \quad (4.17)$$

where $K'(z)$ is the same as K in Eq.(4.16) with $k \rightarrow k'$ and k' being replaced by z . Strictly speaking, solutions of Eq.(4.13) are determined with accuracy up to some constant c . Therefore, the above result should be amended by

$$w(z) = c \frac{K'(z)}{K(z)} \equiv J^{-1}(z) \quad (4.18)$$

The choice of constant c is determined by the requirement that the above mapping of z -plane (with cuts from 1 to ∞ and from $-\infty$ to 0) is mapping onto the fundamental region of the Poincare H^2 plane as depicted in Figs 2 and 3. If we choose $c=i$, then the upper z half-plane is mapped into the right half of the fundamental region D depicted in Fig.3 while the lower z half plane is mapped into the left half of D [51]. The inverse of $w(z)$ is given by the function $J(w)$ defined below:

$$z = J(w) = 16q \prod_{n=1}^{\infty} \left(\frac{1 + q^{2n}}{1 + q^{2n-1}} \right)^8 \quad (4.19)$$

with $q = \exp\{i\pi w\}$. These results were briefly mentioned in our earlier work, Ref [14], e.g. see Appendix of Ref.[14]. Generalization of the obtained results to the case of n punctures ($n \geq 3$) is nontrivial (this is so because the system of equations, Eq.(4.4) can be easily solved only for $n=1$ and 2 , provided that the third point is located at ∞). Therefore, many methods can be used, in principle, with variable degree of success. In this section we would like to discuss only methods which originate in string and conformal field theories. In section 7 we shall discuss in some detail other possibilities.

In general, the accessory parameters $m_k = m_k(p_1, \dots, p_k)$ could be some very complicated and, in general, unknown functions of puncture locations. Some progress had been recently made based on the following key observation

made by Zograf and Takhtadjan[52]. Consider the Schwarzian derivative, Eq.(4.3), rewritten in the following way

$$\{w, z\} = -\frac{1}{2} \left(\partial_z \ln \left| \frac{\partial w}{\partial z} \right| \right)^2 + \frac{d^2}{dz^2} \ln \left| \frac{\partial w}{\partial z} \right| \quad (4.20)$$

This result coincides with that given by Eq.(4.3) as can be seen by direct calculation. At the same time, let $\varphi(z) = \ln \left| \frac{\partial w}{\partial z} \right|$, then we can write instead of Eq.(4.20) the following result

$$\{w, z\} = \frac{d^2}{dz^2} \varphi - \frac{1}{2} \left(\frac{d\varphi}{dz} \right)^2 \quad (4.21)$$

or, in view of Eq.(4.2),

$$\frac{d^2}{dz^2} \varphi - \frac{1}{2} \left(\frac{d\varphi}{dz} \right)^2 = \frac{1}{2} \sum_{k=1}^n \frac{1}{(z - p_k)^2} + \sum_{k=1}^n \frac{m_k}{z - p_k} \quad (4.22)$$

The function φ satisfies the Liouville equation

$$\frac{\partial^2}{\partial z \partial \bar{z}} \varphi = \frac{1}{2} \exp \varphi(z, \bar{z}) \quad (4.23)$$

which describes the surfaces of constant negative curvature $\kappa = -1$. The Poincare H^2 model, Eq.(3.10), equipped with such type of metric becomes a model of the hyperbolic (or Lobachevski) plane. The Liouville equation can be obtained as equation of motion coming from the variation of the Liouville action functional $S[\varphi]$ given by

$$S[\varphi] = \int_{\Delta} d^2 z \left[\left(\frac{d\varphi}{dz} \right)^2 + e^\varphi \right] + \text{counterterms} \quad (4.25)$$

where Δ is determined by $\Delta = \Omega \setminus \cup_{i=1}^{n-1} \{|z - p_i| < r\} \cup \{|z| > \frac{1}{r}\}$, $r \rightarrow 0^+$ and the explicit analytic form of the counterterms is not important for what will follow next. By switching from the Lagrangian to the Hamiltonian formalism we obtain, using Eq.(4.25), the energy-momentum (the stress-energy) tensor T_{zz} given by

$$T_{zz} = \frac{d^2}{dz^2} \varphi - \frac{1}{2} \left(\frac{d\varphi}{dz} \right)^2 \equiv T \quad (4.26)$$

This result can now be combined with Eq.(4.22). This leads, in view of eq.s(4.5), (4.21) and (4.22) to the result:

$$y'' + \frac{1}{2}Ty = 0. \quad (4.27)$$

This equation represents the classical limit of the corresponding quantum/statistical mechanical equation considered in the famous paper by Belavin, Polyakov and Zamolodchikov (section 5 of Ref.[53]) in connection with the development of the conformal field theory. Systematic corrections to these classical results, Eq.s(4.20)-(4.27), can be achieved through Feynman's way of doing quantum mechanics. That is one formally defines the path integral

$$\langle \Omega \rangle = \int_{C(\Omega)} D[\varphi] \exp\left\{-\frac{1}{2\pi h} S[\varphi]\right\} \quad (4.28)$$

where $\Omega = S^2 \setminus \{p_1, \dots, p_n\}$ as before, $C(\Omega)$ is the appropriately chosen domain of functional integration and h is some control parameter which is fixed at the end of calculations[54]. It is not our purpose here to discuss the implications of such path integral formulation of the uniformization problem. The details could be found in the references already provided. Here we only are concerned with calculating the accessory parameters m_k . These parameters can be obtained, in principle, by means of a simple looking formula[54,55]:

$$m_k = \frac{1}{2\pi} \frac{\partial S}{\partial p_k}. \quad (4.29)$$

The simplicity of this formula is somewhat misleading since it was obtained with help of a saddle point approximation. And even within this approximation actual computation can be made only for some special cases, e.g. when two punctures are very close to each other while the rest are far away. In particular, for $n < 4$, one obtains [55]

$$m_k = -\frac{1}{2(p_k - p_n)}, \quad p_k \rightarrow p_n, \quad (4.30)$$

while for $n \geq 4$ and one of the punctures is being located at zero, one obtains [],

$$m = -\frac{1}{2p} + \frac{\pi^2}{2p(\ln|p|)^2}, \quad p \rightarrow 0. \quad (4.31)$$

It is also possible to obtain the exact results for some very special symmetric arrangement of the punctures. Whence, although, in principle, solution

of Eq.(4.5) solves the uniformization (or mapping) problem completely, in practice, even if all m_k would be known, solution of Eq.(4.5) could be so complicated that its practical use in path integral calculations similar to that described in section 2 becomes nonpractical. Nevertheless, our efforts are not completely in vain. For example, we have learned already from example of the trice punctured sphere that solution of Eq.(4.5) not only provides the desired map but also gives the exact shape of the fundamental region in H^2 plane, e.g. see Figs 2 and 3. In order to use other methods, e.g. see section 7, we also need the precise shape of the fundamental region or, equivalently, the explicit form of the unimodular transformation, Eq. (3.8). For the fundamental domain depicted in Fig.3 the corresponding unimodular transformation is known to be [51]

$$a = \left\| \begin{array}{cc} 1 & 0 \\ 2 & 1 \end{array} \right\| \quad \text{and} \quad b = \left\| \begin{array}{cc} 1 & 2 \\ 0 & 1 \end{array} \right\| .$$

in accord with earlier obtained Eq.(3.6). Analogously, if the points are arranged as n -th roots of unity, it can be shown [50], that

$$m_k = -\frac{1}{2}p^{-k} \tag{4.32}$$

and the corresponding unimodular transformation can be found explicitly as well. Fortunately, this is not needed as results of section 7 indicate. The most important for us is the fact that the results obtained in this section for the trice punctured sphere could be used for uniformization of the Riemann surface of **any** genus. In this work we would like only to provide an outline of these far reaching results, in section 7. In the meantime, in order to keep things in proper perspective, we would like now to discuss some topics which are directly related to just covered.

V. Connections with the Riemann-Hilbert Problem and Knizhnik-Zamolodchikov equations

Eq.(4.5) with $\{w, z\}$ given by Eq.(4.2) is a typical case of Fuchsian differential equation. The most general form of equations of Fuchsian type is known to be given by

$$y^{(p)} + q_1(x)y^{(p-1)} + \dots + q_p(x)y = 0 \tag{5.1}$$

where the coefficients $q_i(x)$ **near some singular point** a are given by

$$q_i(x) = \frac{r_i(x)}{(x-a)^i}, \quad i = 1, \dots, p \tag{5.2}$$

where functions $r_1(x), \dots, r_p(x)$ are holomorphic at a . The above p -th order linear differential equation has, in general, p independent solutions. To find these solutions it is convenient to replace the above higher order differential equation with the equivalent system of the first order differential equations. This can be accomplished through the following changes of variables :

$$y = z^1,$$

$$(x - a) \frac{dy}{dx} = z^2,$$

.....

$$(x - a)^{p-1} \frac{d^{p-1}y}{dx^{p-1}} = z^p.$$

Using such defined z variables and the fact that Eq.(5.1) is equivalent to the system of equations given below

$$\frac{dy^1}{dx} = y^2$$

$$\frac{dy^2}{dx} = y^3 \tag{5.3}$$

.....

$$\frac{dy^p}{dx} = -q_p(x)y^1 - \dots - q_1(x)y^p$$

it is a simple matter to bring Eq.(5.1) to the canonical form

$$\frac{dz}{dx} = A(x)z, \tag{5.4}$$

where the vector z is given by

$$z = \begin{bmatrix} z^1 \\ \cdot \\ \cdot \\ \cdot \\ z^p \end{bmatrix} \tag{5.5}$$

and the matrix $A(x)$ is given by

$$A(x) = \frac{1}{x-a} \begin{vmatrix} 0 & 1 & 0 & 0 & \dots & 0 \\ 0 & 1 & 1 & 0 & \dots & 0 \\ 0 & 0 & 2 & 1 & \dots & 0 \\ \dots & \dots & \dots & \dots & \dots & \dots \\ -r_p & -r_{p-1} & \dots & \dots & \dots & p-1-r_1 \end{vmatrix} \quad (5.6)$$

It is clear that the above arguments can be extended to the case when ,instead of one singularity located at a we would have n singularities located at a_i , $i=1-n$.Then,instead of Eq.(5.4),we would have equation which looks like Eq.(5.4) but with matrix $A(x)$ being replaced by

$$A(x) = \sum_{i=1}^n \frac{1}{x-a_i} B_i(x) \quad (5.7)$$

with matrix $B_i(x)$ being nonsingular at above points.For example, the hypergeometric equation, Eq.(4.13), can be presented in Fuchsian form given below

$$\frac{dz}{dx} = \left(\left(\begin{array}{cc} 0 & 0 \\ -ab & -c \end{array} \right) \frac{1}{x} + \left(\begin{array}{cc} 0 & 1 \\ 0 & c-(a+b) \end{array} \right) \frac{1}{x-1} \right) z \quad (5.8)$$

while the Bessel equation , Eq.(2.34), which upon trivial rescaling can be brought to the standard form

$$\frac{d^2y}{dx^2} + \frac{1}{x} \frac{dy}{dx} + \left(1 - \left(\frac{\nu}{x}\right)^2\right)y = 0 \quad (5.9)$$

can be presented in the Fuchsian form of the following type

$$\frac{dz}{dx} = \frac{1}{x} \left(\begin{array}{cc} 0 & 1 \\ \nu^2 - x^2 & 0 \end{array} \right) z \quad (5.10)$$

where the column vector z is given by

$$z = \begin{pmatrix} y \\ x \frac{dy}{dx} \end{pmatrix}. \quad (5.11)$$

Eq.(4.7) is also of Fuchsian type . It can be brought to form of Eq.(5.10) with matrix $A(x)$ given by

$$A(x) = \frac{1}{x} \begin{pmatrix} 0 & 1 \\ -1 & 1 \end{pmatrix} \quad (5.12)$$

with vector z being the same as in Eq.(5.11).

Consider now Eq.(5.4) from different perspective. First ,assume that there is some matrix function $\Gamma(x)$ such that we can relate vector z to another vector Z via

$$Z = \Gamma(x)z. \quad (5.13)$$

This then allows us to write

$$\frac{dZ}{dx} = \frac{d\Gamma}{dx}z + \Gamma \frac{dz}{dx}$$

or,equivalently,

$$\frac{dz}{dx} = \Gamma^{-1} \frac{dZ}{dx} - \Gamma^{-1} \frac{d\Gamma}{dx} z. \quad (5.14)$$

Substitution of this result back into Eq.(5.4) and elimination of Z with help of Eq.(5.13) produces

$$\frac{dz}{dx} = A'(x)z \quad (5.15)$$

with matrix $A'(x)$ being given by

$$A'(x) = \Gamma A \Gamma^{-1} + \frac{d\Gamma}{dx} \Gamma^{-1}. \quad (5.16)$$

At this point the reader can easily recognize the gauge transformation characteristic of the nonabelian gauge field theories [56].Unlike the field-theoretic case, our field is **nonrandom** and,therefore, we cannot use field-theoretic methods which always involve the averages over randomly fluctuating fields.Such averages make sense ,nevertheless,since in physical reality the punctures(poles) are not fixed but can move(see,however,section 7 for further details).. One may think of Eq.(5.4) (or (5.15)) as some sort of equation for the massless Dirac particle(e.g.neutrino) placed in time-dependent (or space-dependent but not both!)nonabelian gauge field [56].The question arises: can one consider instead the **massive** Dirac particle in such gauge field ? The answer turns out to be negative as we are going to demonstrate momentarily this purpose instead of Eq.(5.7) we would like to consider more general matrix given by

$$A(x) = \sum_{i=1}^n \frac{1}{x - a_i} B_i(x) + B(x) \quad (5.17)$$

where the matrix $B(x)$ is not singular for all x . Let all $a_i \neq \infty$ and require our system of equations, Eq.(5.7) to be nonsingular at ∞ as well. This puts some constraint on both $B_i(x)$ and $B(x)$. By replacing x with $\tau = x^{-1}$ in Eq.s (5.7),(5.17) a simple analysis shows that $B(x) = 0$ and, in addition,

$$\sum_{i=1}^n B_i(x) = 0 \quad (5.18)$$

Accordingly, we cannot use massive Dirac particle interpretation of the obtained results. At the same time, let $x \in \Omega$ where Ω was defined at the beginning of section 4. Let, as before, H^2 be the universal covering space of Ω (that is we are considering at least three punctures). By analogy with section 3, let G be the group of motions in the covering space. Let now σ and $\delta \in G$, then if $z(x)$ is solution of the system Eq.(5.7) and $z(\tilde{x})$ is solution in the covering space, then as before, $z(\sigma\tilde{x})$, is also a solution to Eq.(5.7) in the covering space. Moreover, in view of the linearity of Eq.(5.4), such solution is defined only with accuracy up to some **constant** matrix $\chi(\sigma)$. Let us introduce notations: $z(\sigma\tilde{x}) = z \circ \sigma$ and $z(\sigma\tilde{x})\chi(\sigma) = (z \circ \sigma)\chi(\sigma)$. Using these results, we obtain as well

$$z \circ \delta = [(z \circ \sigma)\chi(\sigma)] \circ \delta = (z \circ \sigma \circ \delta)\chi(\sigma)$$

This naturally implies

$$(z \circ \delta)\chi(\delta) = (z \circ \sigma \circ \delta)\chi(\sigma)\chi(\delta) = (z \circ (\sigma\delta))\chi(\sigma\delta)$$

that is

$$\chi(\sigma\delta) = \chi(\sigma)\chi(\delta) \quad (5.19)$$

which is a **monodromy** group condition analogous to that we have already encountered in connection with Eq.(2.7). In case of the trice punctured sphere, using Eq.(3.1), we obtain

$$\chi(abc) = \chi(a)\chi(b)\chi(c) = \chi(1) = 1 \quad (5.20)$$

Evidently, in case of more than 3 punctures we should have

$$\prod_{i=1}^n \chi(a_i) = 1 \quad (5.21)$$

where a_i is the generator of motion around i -th loop (e.g. see Fig.1). The classical Riemann-Hilbert (R-H) problem can be formulated now as follows.

R-H problem: *given location of the points $p_1, \dots, p_n \in S^2$ and matrices $\chi(a_i)$, find a linear differential equation of the type given by Eqs(5.4)-(5.7) whose monodromy group coincides with the group associated with matrices $\chi(a_i)$.*

If we allow points p_1, \dots, p_n to move, then one may pose

The related problem: *find conditions under which for the fixed monodromy group (and this is very natural since topologically nothing changes) solutions of Eq.(5.4) and the matrix $A(x)$ will depend continuously on the set p_1, \dots, p_n .*

More precisely, let $z = z(x_0; x)$ be solution of the system of Eqs(5.4), where $x_0 = \{p_{10}, \dots, p_{n0}\}$. Then, the necessary and sufficient condition for the matrix $A(x)$ as function of parameters p_1, \dots, p_n and x_0 to be associated with the **fixed** monodromy group depends upon the solvability of the following set of (consistency) equations

$$\frac{\partial A_j}{\partial p_i} = [A_j, A_i] \left(\frac{1}{p_i - p_j} - \frac{1}{p_{i0} - p_i} \right), \quad j \neq i,$$

$$\frac{\partial A_i}{\partial p_i} = - \sum_{j \neq i} [A_i, A_j] \frac{1}{p_i - p_j}, \quad (5.22)$$

$$\frac{\partial A_i}{\partial x_0} = \sum_{j \neq i} [A_i, A_j] \frac{1}{x_0 - p_j}, \quad i = 1, \dots, n .$$

The system of equations given above is known in the literature as Schlesinger's equations [57]. Study of solutions of these equations is directly associated with study of the exactly integrable classical and quantum systems [58], conformal field theory [59] and Einsteinian 3+1 gravity [60] and, therefore, is not going to be discussed further in this section.

Nevertheless, to make our presentation self-contained, we would like to discuss briefly connections between the system of Eqs.(5.7) and that known in the literature as Knizhnik-Zamolodchikov (K-Z) equations [61]. The system of equations (5.4) can be formally solved using method of Lappo-Danilevsky [62]. Let the matrix of solutions of Eq.(5.4) be just a unit matrix I for $x = x_0$, then, for $x \neq x_0$ we can formally write solution to Eq.(5.4) in the following form

$$z(x) = I + \sum_{\nu=1}^{\infty} \sum_{j_1, \dots, j_\nu}^{1, \dots, n} L_{x_0}(p_{j_1}, \dots, p_{j_\nu} | x) A_{j_1} \cdots A_{j_\nu} \quad (5.23)$$

where the functions $L_{x_0}(\dots)$ are defined recursively as follows

$$L_{x_0}(p_{j_1} | x) = \int_{x_0}^x \frac{dy}{y - p_{j_1}} \quad (5.24)$$

and, accordingly,

$$L_{x_0}(p_{j_1}, \dots, p_{j_\nu} | x) = \int_{x_0}^x \frac{L_{x_0}(p_{j_1}, \dots, p_{j_{\nu-1}} | y)}{y - p_{j_\nu}} dy. \quad (5.25)$$

Using these results, let us consider now the following system of equations

$$\frac{\partial f}{\partial x_i} = h \sum_{j=1, j \neq i}^n \frac{t_{ij}}{x_i - x_j} f(x_1, \dots, x_n). \quad (5.26)$$

Here h is some prescribed constant (control parameter) and the symmetric matrix t_{ij} is also assumed to be given (actually, the matrix t_{ij} is **not the matrix** but rather the tensor product of two matrices [61] but for the moment we shall ignore this fact). The above system of equations is known in the literature as K-Z system of equations [61]. It has numerous physical applications, e.g. see Ref. [14], which are not going to be discussed here. What will be important for us is its connection with Eqs (5.4) and (5.22). To establish this connection several steps are needed. First, using the property of symmetry of the matrix t_{ij} it is straightforward to obtain the following auxiliary equations

$$\sum_{i=1}^n \frac{\partial f}{\partial x_i} = 0 \quad \text{and} \quad \sum_{i=1}^n x_i \frac{\partial f}{\partial x_i} = \sum_{1 \leq i < j \leq n} f(x_1, \dots, x_n) \quad (5.27)$$

Eq.s (5.27) reduce the number of independent variables in K-Z equation to $n - 2$. In particular, solution $f(x_1, x_2, x_3)$ of K-Z Eq. (5.26) actually depends only upon one variable which we shall denote as x . More specifically, if we look for solution of Eq. (5.26) in the form

$$f(x_1, x_2, x_3) = (x_3 - x_1)^{h(t_{12} + t_{23} + t_{31})} g(x) \quad (5.28)$$

where

$$x = \frac{x_2 - x_1}{x_3 - x_1},$$

then,substitution of such an ansatz into Eq.(5.26) produces the following equation for the function $g(x)$:

$$\frac{dg}{dx} = h\left(\frac{t_{12}}{x} + \frac{t_{23}}{x-1}\right)g(x). \quad (5.29)$$

In the original paper by Knizhnik and Zamolodchikov[61] it is explained why t_{12} and t_{23} are actually 2×2 matrices (not just usual numbers which are components of the matrix).Comparison with Eq.(5.8) then suggests immediately that we are dealing with the hypergeometric equation and ,indeed, Knizhnik and Zamolodchikov had obtained two solutions for $g(x)$ in terms of hypergeometric functions .Their solution is not the most general ,however. A complete solution was found by Drinfeld[63] and ,more explicitly,by Le and Murakami [64].It is noteworthy to describe it since it is related to quantum groups and Vassiliev invariants for knots and links [65-67].To describe this solution, let us consider instead of Eq.(5.29) the following generalization

$$\frac{dg}{dx} = \frac{h}{2\pi\sqrt{-1}}\left(\frac{A}{x} + \frac{B}{x-1}\right)g(x) \quad (5.30)$$

where the prefactor $\frac{h}{2\pi\sqrt{-1}}$ is chosen for convenience only (since $\frac{h}{2\pi}$ is just the usual Planck constant in quantum mechanics)and the factors A and B are some non-commuting variables, e.g.matrices.Let $g_1(x)$ and $g_2(x)$ be two independent solutions of Eq.(5.30).Then, as it was shown by Drinfeld [63], $g_1(x) = g_2(x)\Phi(A, B)$ where the function Φ of two noncommuting variables is known in the literature as Drinfeld associator .The explicit form of Φ is hard to find in closed form .If h is small parameter,then ,after some tedious calculations[64]which involve use of Lappo-Danilevskii-type expansions ,one finally obtains

$$\Phi(A, B) = 1 - \frac{\zeta(2)}{(2\pi\sqrt{-1})^2}[A, B]h^2 + \frac{\zeta(3)}{(2\pi\sqrt{-1})^3}([A, B], B) - [A, [A, B]]h^3 + \dots \quad (5.31)$$

Here $\zeta(x)$ is Riemann zeta function.To obtain solutions $g_1(x)$ and $g_2(x)$ is rather easy in the neighbourhoods of 0 and 1.To this purpose it is sufficient to look for solution of g_1 in the form

$$g_1(x) = P(x)x^{hA} \quad (5.32)$$

and,analogously,

$$g_2(x) = Q(1-x)(1-x)^{hB} \quad (5.33)$$

Assuming that functions $P(x)$ and $Q(1-x)$ can be represented in terms of power series expansions it is rather straightforward to find the successive coefficients. For values of x not necessarily close to $x=0$ and $x=1$ again one should be looking for solution using Lappo-Danilevsky method. Altschuler and Freidel had demonstrated [66] how Drinfeld associator Φ can be used for calculation of the regularized Vassiliev-Kontsevich invariant for knots and links. It is not our purpose to reproduce these calculations in this paper. Instead, we would like to mention yet another physical application of the obtained results.

To this purpose, let us consider again system of equations Eq.(5.4) with matrix $A(x)$ being given by Eq.(5.7). Let us first choose matrices B_i to be constants. Then, the gauge transformation, Eq.(5.16), is just a similarity transformation so that we can always select such Γ 's that the resulting matrix be diagonal. Without loss of generality, we shall assume that this is the case from now on. Let us then look for a solution of Eq.(5.4) in the vicinity of one of the points, say, a_j . We can always choose the system of coordinates located at this point. Then, in the vicinity of this point we essentially have to solve the following equation

$$\frac{dz}{dx} = \frac{A_j}{x} z \quad (5.34)$$

The solution of this equation is obtained at once and is given by $z = x^{A_j} = \exp\{A_j \ln x\}$. Now, if x is in the complex plane (or on S^2) use of Eq.(2.16) produces, after one rotation around $x=0$, the following solution $z \circ \sigma = \exp\{2\pi i A_j\} z \equiv \chi(\sigma) z$. If now the matrix $A(x)$ is x -dependent, then one can look for solution of Eq.(5.4) in the form

$$z(x) = \sum_{j=1}^n \Phi_j(x) (x - a_j)^{A_j} \quad (5.35)$$

where A_j is the value of $A(x)$ at $x=a_j$ (surely, upon proper diagonalization) and the functions $\Phi_j(x)$ are holomorphic at $x=a_j$. Instead of S^2 , let us consider a disc D^2 first. Let x_0 be the location of singular point(s) in D^2 and let $\gamma_1, \dots, \gamma_n$ be a set of loops which go around the singular points while $\{\chi(\sigma_j)\}$ be the respective monodromy matrix set. Now we cover D^2 by domains U_j so that each domain U_j has only one singularity a_j . Using Eq.(5.35) in each domain we have $z_j = \Phi_j(t) t^{A_j}$ (where t is the local coordinate in U_j 'th domain) so that at the intersection of U_i and U_j domains we should have the consistency condition

$$\Phi_j^{-1} \Phi_{j+1} = t^{A_j} t^{-A_{j+1}} \mid U_j \cap U_{j+1} \quad (5.36)$$

or ,more generally, if one considers S^2 ,

$$\Phi_{j+}(x) = G(x)\Phi_{j-}(x) \tag{5.37}$$

with $G(x)$ being some known function . This type of boundary value problem is very well known in the theory of elasticity [68] and was thoroughly studied since it was first formulated by Hilbert in 1900 (21st Hilbert’s problem) [69].Whence, the use of the non -Abelian gauge field theories has a long history . Birkhoff [70] had shown that solution of the Hilbert problem ,Eq(5.37) is equivalent to the solution of the Fuchsian system of equations , Eq.(5.4). More readable account of this proof is contained in Ref.[71] .Use of Riemann-Hilbert problem in the the theory of exactly integrable equations is well documented,e.g. in Ref[72].Accordingly, it is not our intention to discuss these topics in this paper.Instead we would like to discuss topics related to random walks on groups in the following section.

VI. Random walks on free groups: an introduction

By now,it should become clear that even for 3 punctures in the plane the path integral approach developed in section 2 becomes nonpractical.In current literature the situation with 3 or more punctures is treated with help of an auxiliary abelian or nonabelian gauge fields as described in our Phys.Reports ,Ref[14]. Such approach though plausible but mathematically less rigorous. To realize the difficulty , we would like to mention the following. In Ref.[7] the trice punctured sphere (or twice punctured plane) problem was solved with help of path integral methods.However,the major question about the recurrence/transience was not even addressed. Moreover,the method used in Ref.[7] does not admit generalization to the multiple punctured case . Accordingly, it is necessary to develop other methods of dealing with these problems. In this section we shall discuss an alternative approach which originates from the fundamental work of Kesten[73] .

In section 3 we had discussed presentation for the group G ,e.g.see Eq.(3.2) (with all $R_i = 0$) and associated with it word W ,Eq.(3.4).Following Kesten, let us consider the random walk on G in which every step consist of right multiplication by a_i (or its inverse) each with probability p_i .Surely,one can complicate matters by assigning different probabilities for direct and inverse elements but we shall not complicate our presentation at this time. For the

free group of n elements we should require at each step

$$2 \sum_{i=1}^n p_i = 1 \quad (6.1)$$

The random walk thus defined determines a Markov chain whose possible states are elements of G . The transition probability (to be precisely defined below) from some $W_1 \in G$ to another $W_2 \in G$ is given by the probability that W_2 is reached in one step from W_1 . So far all this looks very detached from the previous discussions. To make a connection, we shall, following Ref.[3], introduce some additional concepts. Let X be a metric space in which the distance (the geodesic distance) $d(x,y)$ between points x and y which belong to X is formally determined by

$$d(x, y) = |x - y| \quad (6.2)$$

In particular, if $W_1, W_2 \in G$, then

$$|W_1 - W_2| = \min\{m \mid W_1^{-1}W_2 = a_1a_2\dots a_m\}. \quad (6.3)$$

That is the distance between words is determined by the minimal word. For example, let $W_1 = a_1a_2a_2^{-1}a_3$. Surely, this word is not minimal since the combination $a_2a_2^{-1}=1$ can be easily removed. As simple as it is, the general problem of comparing different words, known as word problem [44], cannot be solved in general [74]. This does not mean that the problem cannot be solved for a specific group, for example, for the free group. More on this subject is discussed in the classical monograph, Ref. [44]. More important for us is the fact that such defined distance, Eq.(4.3), possesses the property of translational invariance, just like in the case of Eq.(2.3). Indeed, let us consider $|\gamma W_1 - \gamma W_2|$. According to Eq.(6.3) we have

$$|\gamma W_1 - \gamma W_2| = (\gamma W_1)^{-1} \gamma W_2 = W_1^{-1} \gamma^{-1} \gamma W_2 = W_1^{-1} W_2. \quad (6.4)$$

It is possible to introduce not only the distance but even the curvature of the group, etc. For instance, following Milnor [75], for a finitely generated group, i.e. group of finite number of generators, e.g. n , one can define the growth function $\gamma(s)$ which for each positive integer s determines the number of words with length $\leq s$. Then, it can be shown, that for the free group of n generators the growth function is given by

$$\gamma(s) = (n(2n - 1)^s - 1) / (n - 1) \quad (6.5)$$

and this result is directly related to the curvature of the underlying manifold whose fundamental group consist of n elements.

It should be noted,that the distance defined above is not the only possibility in groups. For instance,if we fix some element,say unity, as a reference point, then ,one can introduce another distance between x and y ,also known in the literature as Gromov product[3,76,77], e.g.

$$d_G(x, y) = \frac{1}{2}(|x| + |y| - |xy^{-1}|) \quad (6.6)$$

so that,by construction, $d_G(x, x)=|x| \geq 0$ which makes perfect sence.Using this result one can go further by providing the following

Definition 6.1. *Let δ be nonnegative real number.The metric space X is said to be δ -hyperbolic if*

$$d_G(x, y) \geq \min(d_G(x, z), d_G(y, z)) - \delta \quad (6.7)$$

for every x, y and $z \in X$.Moreover, the metric space is **hyperbolic**(in the sence discussed in sections 3 and 4) if there is a real number δ so that X is δ -hyperbolic.

It can be demonstrated[3,76,77] that:

- a) every graph is 0- hyperbolic;
- b)every free group of finite rank is hyperbolic.

Moreover, following Ref.[77], the δ -**ultrametric** space X can now be defined via

$$|x - y| \leq \max(|x - z|, |y - z|) + \delta \quad (6.8)$$

for all $x, y, z \in X$.Using such definition, the following theorem can be proven[77]

Theorem 6.2. *Every metric space X which satisfy the above inequality is actually δ -hyperbolic.*

This means that the **ultrametric space is a special case of hyperbolic space**. This fact could be used for solving some problems related to spin glasses and other systems which require use of replicas[4].

Going back to our problem of symmetric random walk on free groups we need to introduce two probabilities :

$m^{(n)}$ = Probability of returning to the unit element e at n-th step given that one initially starts at e .

$r^{(n)}$ =Probability of returning for the **first time** to e at n-th step at n-th step given that one initially starts at e .

With such defined probabilities the generating functions $m(x)$ and $r(x)$ can be now formally introduced as follows:

$$m(x) = \sum_{n=0}^{\infty} m^{(n)} x^n, \text{ provided that } m^{(0)} = 1 \quad (6.9)$$

and

$$r(x) = \sum_{n=1}^{\infty} r^{(n)} x^n. \quad (6.10)$$

As it was demonstrated by Feller[78], e.g. see page 311 of Feller's book.

$$m(x) = \frac{1}{1 - r(x)}. \quad (6.11)$$

Thus, if $r(x)$ is known, $m(x)$ is known as well. To determine $r(x)$ one needs to determine $r^{(n)}$ explicitly. Elegant solution of this combinatorial problem is presented in Kesten's paper[73], e.g. see pages 348, 349 of Ref.[73] and take into account similar derivations in Feller's book, Ref[78], with the following result:

$$r(x) = \frac{n - (n^2 - (2n - 1)x^2)^{\frac{1}{2}}}{2n - 1}. \quad (6.12)$$

Use of Eq.(6.11) provides us with the following value of $m(x)$

$$m(x) = \frac{2n - 1}{n - 1 + (n^2 - (2n - 1)x^2)^{\frac{1}{2}}} \quad (6.13)$$

with n being the number of generators in the free group G .

Now, we would like to use all this information in order to discuss the random walk on Bethe lattice, Fig.6, which is just the universal covering space of figure eight (in the case of free nonabelian group of two generators) or, more generally, the covering space of the union of n circles[74] (in case of n generators). Such problem was solved by conventional methods in Ref.[79] and we would like to borrow a couple results from this reference for the sake of comparison. In particular, let $P_t(l|m)$ be the probability that the walk originated at position m will end up at position l after t steps. In case of the Bethe lattice the position m (or l) is determined with respect to the origin, e.g. see Fig.6, so that m means the number of links making a path between the origin and point m , etc. The Markov chain equation is given by

$$P_{t+1}(l|m) = \sum_{l'} \gamma(l, l') P_t(l'|m) \quad (6.14)$$

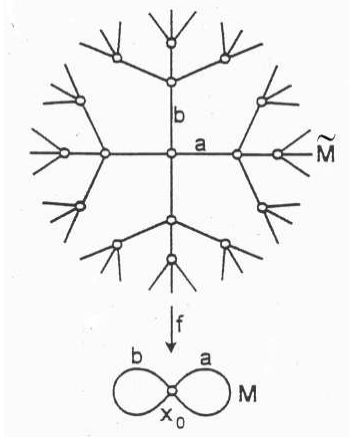

Figure 6: Figure 8 and its universal covering space

with $\gamma(l, l')$ being determined by

$$\gamma(l, l') = \begin{cases} (1 - \frac{1}{2n})\delta_{l, l'} + \frac{1}{2n}\delta_{l, l'-1}, & l' \geq 1 \\ \delta_{l, l'+1}, & l' = 0 \end{cases} \quad (6.15)$$

The probability $\Pi(0)$ of returning to the origin, defined in Eq.(2.45), is calculated to be

$$\Pi(0) = \frac{1}{2n - 1} \quad (6.16)$$

and is surely less than one for $n \geq 2$. Hence, for $n \geq 2$ the walk is transient and this result is in accord with results obtained by Lyons and McKean[19] and McKean and Sullivan[20] who used different methods. For $n=1$ the walk is recurrent, since $\Pi(0) = 1$, and this result is in accord with earlier obtained in section 2 for 2 punctures one of which being located at infinity. We would like now to reproduce this result using the theory of random walks on groups. This is needed for various reasons discussed in the Introduction, below, and to be discussed in the next section. To begin, following Kasteleyn[23], we consider an analogue of Eq.(6.14) for group elements (letters) a_1, \dots, a_n of some free group G . Let $P_t(W)$ be the probability of creating the word W of t letters starting from e . The Markov chain equation analogous to Eq.(6.14) can now be written as

$$P_t(W') = \sum_{W \in G} P_{t-1}(W^{-1}W')p(W), \quad t \geq 1. \quad (6.17)$$

with $p(W)$ being defined as **stepping** probability which is the probability of choosing a particular branch at each vertex of the tree. Looking at Fig.6 ,we can easily notice that it is exactly the same probability as for crossing the vertex of figure 8 (in case of two generator group). Surely,one can complicate matters by assigning different weights to different choices of crossing the vertex as it is done ,for example, in the case of the Ising model. Such possibility immediately connects the walks on groups with various statistical mechanical models as discussed ,for example, in Ref.[80]. We shall in this work restrict our discussion to the simplest possible case ,e.g. $p(W) = 1/2n$ (motivated by Fig.6).As in the case of usual random walks[42], it is convenient to introduce the generating function $P(W, z)$ as follows

$$P(W, z) = \sum_{t=0}^{\infty} P_t(W) z^t \quad (6.18)$$

This generating function obeys an equation of the following type

$$P(W', z) - \delta_{W',e} = z \sum_{W \in G} P_{t-1}(W^{-1}W', z) p(W) \quad (6.19)$$

so that the probability $\Pi(W)$ that a walk starting at e will ever visit element W (excluding the start as visit to e) is given by

$$\Pi(W) = \lim_{z \rightarrow 1} \frac{P(W, z) - \delta_{W,e}}{P(e, z)} \quad (6.20)$$

The crucial moment now is to notice that ,actually, $P(e, z) = m(z)$ where $m(z)$ is given by Eq.(6.9).At this moment Kasteleyn claims that this observation allows one to determine $P(W, z)$ with help of Eq.(6.19). Since the details of the derivation are not provided in Kasteleyn's paper, we restore these calculations in this work. To this purpose, let us assume that solution could be sought in the form

$$P(W, z) = \lambda^{|W|} P(e, z) \quad (6.21)$$

with $|W|$ being defined by Eq.(6.3). Using these results in Eq.(6.19) we obtain,

$$\lambda^{|W'|} P(e, z) - \delta_{W',e} = \frac{z}{2n} \sum_{W \in G} \lambda^{|W^{-1}W'|} P(e, z). \quad (6.22)$$

Let us notice now that the actual length of the combination $|W^{-1}W'|$ is equal to one since in one step of the random walk only one letter is added

or subtracted according to the definitions made above. Finally, let $W' = e$ and ,since $|e| = 0$, we obtain from Eq.(6.22) the following result:

$$\frac{P - 1}{Pz} = \lambda \quad (6.23)$$

since

$$\sum_{W \in G} = 2n \quad (6.24)$$

by construction. Here $P = P(e, z)$. By combining Eq.(6.13) with Eq.(6.23) we obtain

$$\lambda = \frac{z}{n + (n^2 - (2n - 1)z^2)^{\frac{1}{2}}} \quad (6.25)$$

Obtained result coincides exactly with that obtained by Kasteleyn, Ref[23], e.g. see his Eq.8 , where it was given without derivation. By combining Eqs(6.21) and (6.25) we obtain the final result for $P(W, z)$ which can be used now for calculation of $\Pi(W)$. In particular, for $W = e$ we obtain, using Eq.(6.20),

$$\Pi(e) \equiv \Pi(0) = \frac{1}{2n - 1} \quad (6.26)$$

in complete accord with earlier obtained Eq.(6.16) . It should become clear by now, that consideration of random walks on groups provides practically as much information as one could possibly get by much more tedious calculations using the real-space approach. This is so because the group-theoretic methods provide an equivalent and complete description of the underlying geometric and topological properties of a given manifold[3,75-77]. We would like now to elaborate this observation in the next section.

VII. Some applications

The recurrence/transience of random walks has actually numerous physical applications which had been mentioned already in our previous works[14]. To make our presentation self-contained, we would like to remind to our readers about some of these applications and to discuss additional physical applications in this section.

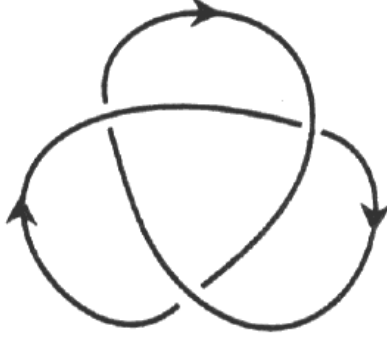

Figure 7: Planar projection of the trefoil knot

A. Polymers

First, the results of previous section can be used in the theory of polymer solutions[14] since they provide the exact mathematical formulation of the concept of entanglement through use of mathematically well defined concepts of recurrence and transience. It should be clear by now that the random walks on groups are **not at all** limited to the planar problems since the homotopy of paths are not limited to two dimensions. In particular, one can think now about random walks in the presence of knots and links(the possibility mentioned already in our earlier work, Ref[14]). From this reference we know that almost all flexible polymers are either knotted or quasiknotted in solution in case if their length L is large. Formation of knots/links may affect both static and dynamic properties of polymer solutions and also polymer interfaces as is well known. Nevertheless, to detect the presence of knots in solution is very nontrivial problem. Fortunately, using methods developed in this work this problem may be solved to some extent. Let us explain briefly how this can be done on examples of trefoil ,Fig.7, and figure eight ,Fig.8, knots.Using either results of our Appendix A2 of Ref[14] or more specialized books on knot theory,e.g. Ref[43],[81], one obtains the following group presentations

$$G_T = \langle a, b, c \mid cb = ba = ac \rangle \quad (7.1)$$

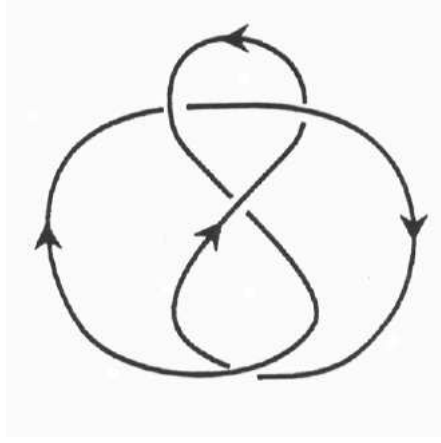

Figure 8: Planar projection of the figure 8 knot.

for the trefoil and

$$G_8 = \langle a, b \mid \rangle \quad (7.2)$$

for the figure 8 knot complement groups. We would like to remind our readers that the above group presentations are for the fundamental groups of the **complements** of these knots in S^3 (i.e. for $S^3 \setminus K$ where K is the knot of given type and $S^3 = R^3 \cup \{\infty\}$). It is being assumed that the knot has finite thickness (framing) so that the toroidal-like tunnel occupied by K is removed from R^3 thus converting it to space with possibly very complicated topology. The Cayley graph for the fundamental group of the trefoil is depicted in Fig.9 while that for the figure 8 is depicted in Fig.6. Fig.9 has rather complicated structure which was discovered by Max Dehn [82] whose Dehn's twists we also going to discuss below. When viewed from above, one can see the three-valent Bethe lattice (the terminology used in physics literature for the Cayley graph [74]). At each vertex of such lattice three infinite ladders are glued together in an obvious way. To describe random walks on such lattices is not an easy task and, besides, the presentation given by Eq.(7.1) is **not** unique, for example, using results of Ref[81] one obtains as well.

$$G_T = \langle x, y \mid x^2 = y^3 = 1 \rangle \quad (7.3)$$

with the corresponding Cayley graph (part of it) depicted in Fig.10. Clearly, the random walk in the complement of the figure 8 knot is transient (that is

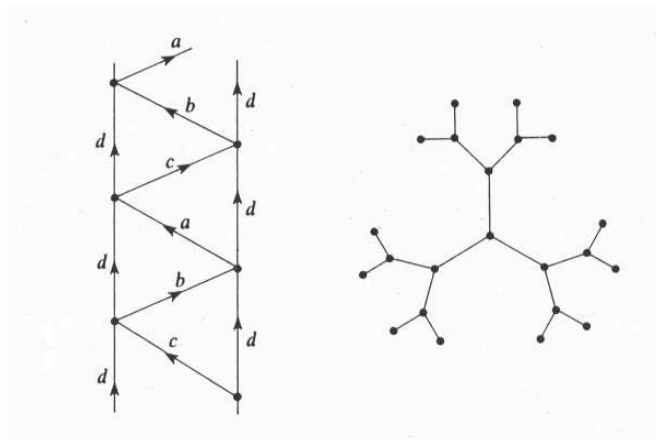

Figure 9: Cayley graph for the complement of the trefoil. Here $d=cb$.

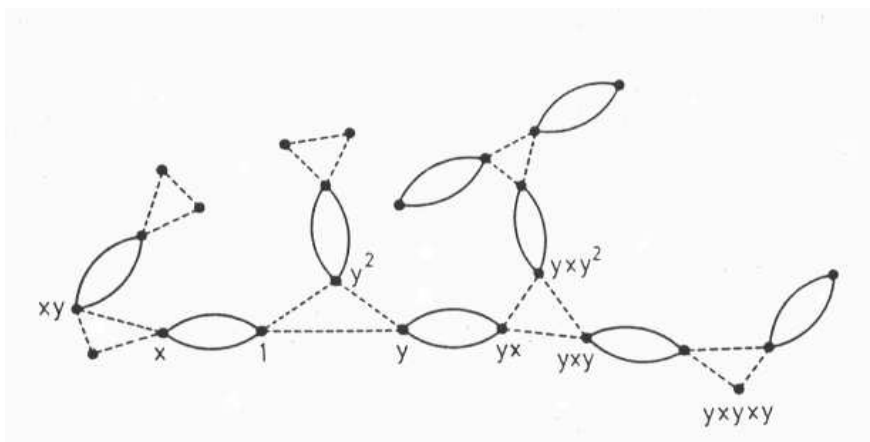

Figure 10: An alternative universal covering space for the complement of trefoil knot.

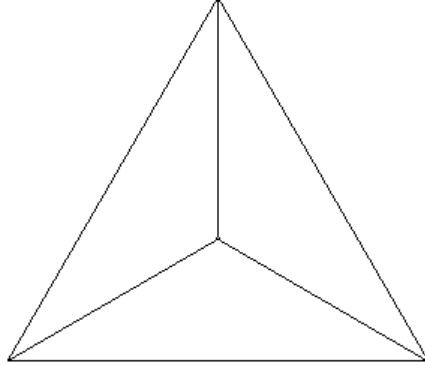

Figure 11: Base space for the graph depicted in Fig.10

if one could make a solution of linear and circular knotted polymers which all are figure 8 knots ,the linear polymers will become entangled with such knotted structures so that it will become practically impossible to separate these two types of polymers).To determine the recurrence/transience for the complement of the trefoil knot requires some additional efforts which are worth spending,see the next subsection.Already now few remarks are in place. Just by looking at Fig.10 one can make the following observations. If we collapse the solid line loops to lines and the dashed triangles to points, we would obtain three-valent Bethe lattice as depicted in Fig.9. This lattice is the universal covering space for the triangle depicted in Fig.11. Actually, to be consistent with the existing conventions of combinatorial group theory[83] one has to modify Fig.11 as depicted in Fig.12. This is needed because ,according to the existing rules , at given vertex only two edges of the same color(e.g. solid lines and/or dashed lines) can meet.By looking at Fig.10 this fact then explains why figure 8 complement is transient while that for the trefoil is recurrent. Indeed,for the figure 8 we have at each vertex the probability $3/4$ to go forward and only $1/4$ to go backward while for the trefoil we get $1/2$ to go forward and $1/2$ to go backward ,much like for the random walks on the line which represent the universal covering space for once punctured plane discussed in section 2. Surely,such walks are recurrent as it had been demonstrated already.

Since the entanglements affect both static and dynamic properties of polymer solutions,it is clear, that the presence of knotted structures should

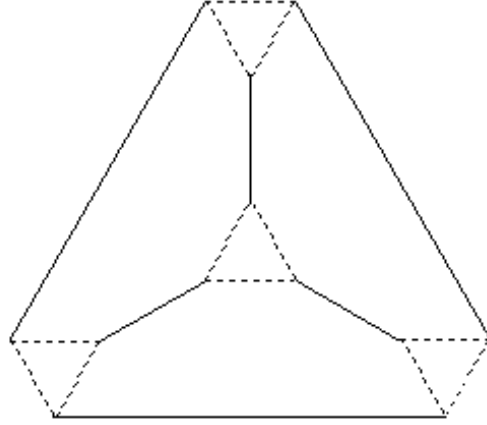

Figure 12: The same base space as in Fig.11 but with better resolution required by the graphical representation of groups[]

be important in changing these properties. The presence of knotted structures is also important biologically since for **different** knots the first return and the escape times should be different .If the diffusion processes take place in the vicinity of such knotted structures,e.g. DNA's, the outcomes will be different for different types of knots.This observation could be important in processes which involve the molecular recognition. Let us however return to the problem of transience/recurrence for the random walks on fundamental groups for thefoil and figure 8 in order to discuss additional very important aspects of the recurrence-transience problem.

B. Classical and quantum chaos and random walks on Teichmüller modular group

From the knot theory textbooks,e.g.see Ref[43,81], it is well known that although figure 8 and trefoil knots look very similar, they actually belong to completely different "universality classes" as it can be seen already from the difference in their group presentations and will be explained further below. The trefoil knot is just a typical representative of the class of torus knots while the figure 8 knot belongs to the class of hyperbolic knots (actually it is the simplest example of hyperbolic-type knots[84]). It is not our purpose

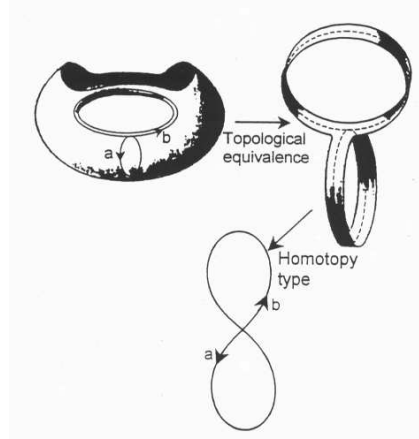

Figure 13: Topological structure of once punctured torus

to go into all details of the above distinction between these different classes of knots. Instead, we are going to emphasize aspects of these knots which are logically related to the discussions we had presented so far.

In our earlier work, Ref[1], we had noticed the fact that the fundamental group of the the the punctured torus is the same as for figure 8. This could be easily seen from the following picture, Fig.13. Although in physics literature quantum mechanics of such "leaky torus" had been discussed [85] along with many generalizations[9-12], including those which involve the quantum Hall effect[86],e.g.Aharonov-Bohm effect under the periodic boundary conditions,etc.,surprisingly, the spectral analysis and other related aspects of the punctured torus are still at the forefront of research in mathematics[87].Because of this, we would like to emphasize here some aspects of the problems related to punctured torus which had not been (to our knowledge) discussed in physics literature.Following Ref.[88] ,it is convenient to group the generators a and b of the free group G_8 according to the following scheme:

$$\begin{aligned}
 ab &\rightarrow L \\
 ba &\rightarrow L \\
 (bb)^{-1} &\rightarrow L \\
 ab^{-1} &\rightarrow R \\
 bb &\rightarrow R \\
 b^{-1}a &\rightarrow R
 \end{aligned}$$

where R and L stand for "right" and "left" as it is usually done in symbolic

dynamics[89]. Surely, the above correspondence (automorphism) is quite arbitrary and it is obvious that other possibilities could be tested. What is less trivial is to prove[90] that the totality of words generated by sequences given by Eq.(3.4) coincides exactly with the totality of words of the type

$$W = R^{n_1} L^{n_2} \dots \quad (7.4)$$

where $[n_1, n_2, \dots]$ is continuous fraction expansion of some number, say $\theta < 1$. Recall [91], that the continuous fraction for θ is actually given by

$$\theta = \frac{1}{n_1 + \frac{1}{n_2 + \frac{1}{n_3 + \dots}}} \quad (7.5)$$

The continuous fraction always stops if θ is rational number or it becomes periodic for some irrational numbers, e.g. those which come from solutions of quadratic equations, and it is infinite and nonperiodic for generic irrational θ . We would like now to argue that for the torus-type knots θ is always rational number while for hyperbolic knots, e.g. for figure 8, θ should be irrational. Since in the first case words have finite length this means that if we have one of such longest words, then multiplication by R (or by L) should make such word trivial, i.e. $W=1$. The trivial word, when depicted graphically[83], simply means that there is a closed loop in the graph. This, in turn, means that the motion is recurrent. If there are no closed loops, then the motion could be either transient or recurrent. We had established this fact already in the previous section for the figure 8. Since the trefoil knot is associated with three-valent Bethe lattice it means that the random walks on such lattices behave quite differently as compared with Bethe lattices with vertices of even valency. This difference also should show up in various properties of statistical mechanical models on such graphs[80]. In this work, naturally, we are not going to touch these subjects. Let us now explain better how all this is associated with chaos. Superficially, an infinite word, Eq.(7.4), made of totally random sequences of R and L already suggests chaoticity. In general, the word W may or may not be random. It may correspond to the sequence of base pairs along DNA, to some number written in binary system, the sequence of "up" and "down" spins in Ising-like model, to sequence of hits in the Poincare return maps, etc. One can do still better than just these observations. To this purpose some knowledge of the knot theory is helpful and we refer our readers to the specialized literature, e.g. see Refs[43,81].

Let us begin with a very well known fact from the combinatorial group theory which is this. Let G be free nonabelian group made of two generators a and b . Let us construct a commutator $aba^{-1}b^{-1} \equiv \mathcal{K}$, then the quotient G/\mathcal{K} is just an abelian group that is, instead of presentation given by Eq.(3.5), we obtain now

$$G_a = \langle a, b \mid ab = ba \rangle \quad (7.6)$$

and this is just the fundamental group of the torus. Such abelianization had effectively removed the puncture from the torus so that it became essentially the product of two circles with the group $Z \oplus Z$ of covering transformations instead of just Z considered in section 2. This procedure of abelianization is characteristic not only for the punctured torus but for Riemann surface of **any** genus g : it is sufficient to make just one hole in such surface in order to obtain the free group of $2g$ generators. Using this fact, one can prove the following related theorem

Theorem 7.1. *If Γ is finite graph with α_1 vertices and α_2 edges then, the fundamental group of the graph $\pi_1(\Gamma)$ is just a free group of n generators where $n = 1 + \alpha_2 - \alpha_1$.*

Proof. Please, consult Ref[43], page 228.

The above theorem and the results presented in previous sections explain at once the results of Ref[13] where the hyperbolicity of the disordered network was established using much longer chain of arguments.

Going back to the torus case, one might think that the quantum mechanics on the torus is trivial. To a large extent this is the case, as compared with the case of the punctured torus, and, indeed, many results for toroidal topology had been obtained in the theory of dynamical systems[16], quantum billiards[92] and the conformal field theories[93]. Nevertheless, even this case is still under detailed investigation as recent literature indicates[94]. In any event, by analogy with the circle, we shall utilize the properties of the covering space which is just the infinite two dimensional lattice. We would like to construct explicitly the group representation which describe the motions on such lattice(s). Fortunately, this has been done already so that we can use known results. Moreover, these results will be useful also for the punctured torus case. Since the torus $T = S^1 \times S^1$ and the case of S^1 was studied in section 2, we can begin our discussion by dissecting our torus so that it becomes a square (without loss of generality) with sides of unit length. Then, the location of some point on the torus (or inside the square) can be described in terms of the four real coordinates

$$(x_1, x_2, x_3, x_4) = (\cos \alpha, \sin \alpha, \cos \beta, \sin \beta) \quad (7.7)$$

or,alternatively, in terms of two complex coordinates z and w such that

$$|z|^2 + |w|^2 = 2 \tag{7.8}$$

since $|z|^2 = |w|^2 = 1$. But Eq.(7.8) is the equation for 3-sphere

$$S^3 = \{(z, w) \in C^2 : |z|^2 + |w|^2 = 2\} \tag{7.9}$$

It can be proven[95](and the proof is not too difficult) that all torus knots are obtained as result of intersection of the sphere S^3 with the complex surface $z^p + w^q = 0$ where p and q are relative primes so that p/q is some rational number.Although all this is mathematically correct, we would like to provide intuitively more convincing picture of what is actually taking place. For this reason, we need to use the universal covering surface which is square lattice with the side length being 2π .For construction of the trefoil knot, we need to consider the basic rectangle with sides of length 4π and 6π respectively which can cover the entire complex plane by obvious translations. Let us now draw the straight line from the point $(0,0)$ to the point $(4\pi, 6\pi)$ and let us by means of obvious translations bring the squares affected by this line to the initial square which corner is located at $(0,0)$. All this is depicted on Fig.14. Now,the pattern in this initial square can be transferred back from the universal cover to the dissected torus without any change.Actually,this pattern could be created directly in the base space too as depicted in Fig.15. This figure was created with account of the periodic boundary conditions on the torus and,already from this picture one can recognize the knot projection if one properly resolves the intersections between the dashed and the solid lines(as it is always required in knot theory[43]).Fig.15 allows us to reglue the square into the torus knowing that ,indeed,the three dimensional knot is going to be created as result of such operation. This is depicted in Fig.16. On this figure two trefoils are depicted :one is $(3,2)$ and another is $(2,3)$ which are, actually, the mirror images of each other and are called the right and the left hand trefoils respectively[43]. Now,what all this has to do with our original intentions?.For this,we have to talk about the analytical theory of toral automorphisms.It is clear,even without any actual calculations,that the figure 8 knot should be associated with the lines of irrational slope in the covering lattice, Fig.14.Such plausible reasoning would be to a large extent correct if we would forget the results of section 3 in which we had established that the universal covering space of the punctured torus is **not** a square lattice but rather the Poincare upper half plane H^2 . This fact provides yet another evidence of profound distinction between the trefoil and figure 8 knots.The situation can be repaired somehow if we provide

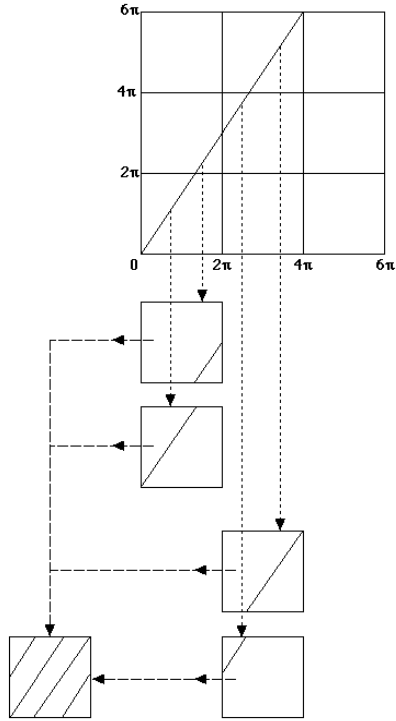

Figure 14: Dynamics of rational paths on the covering space of the torus

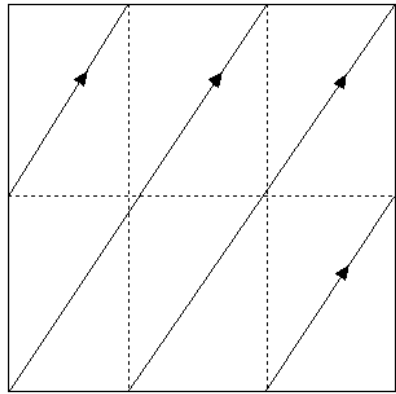

Figure 15: Dynamics of the rational paths in the base space of the torus

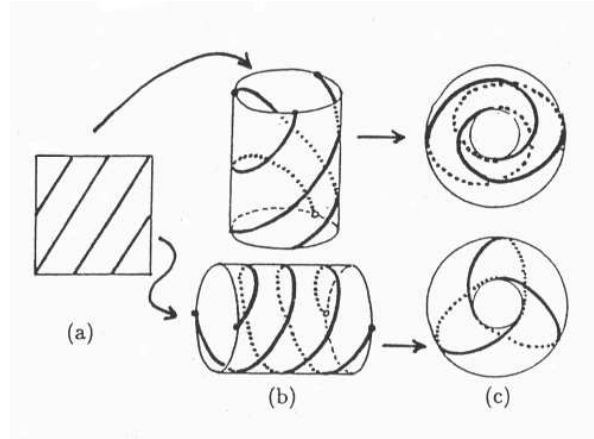

Figure 16: Rational dynamics on the torus can be equivalently described in terms of the associated with it torus knots

different interpretation of the results depicted in Fig.14. To this purpose one needs to introduce the notion of the Teichmüller space of the punctured torus[96]. To make this concept readily comprehensible let us start with the notion of Dehn twists.As it had been proven by Nielsen[74], following works of Dehn[82],all selfhomeomorphisms of two dimensional surfaces can be performed with help of sequence of Dehn twists. Fig.17a depicts one of such twists, while Fig.17b demonstrates what such twist can produce on the surface of a torus. This simple observation can now be broadly generalized. To do this several steps are required. To begin, let us consider ,instead of a square lattice, Fig.14,more general lattice ,as depicted in Fig.18, which is characterized by the complex parameter τ (which is the ratio of periods ω_1 and ω_2 (some relatively prime integers)along the respective axes) so that ,in accord with Eq.(7.6), the abelian group of translations Γ_τ can be described as

$$\Gamma_\tau = \{\gamma = m + n\tau \mid m, n \in Z; \tau \in C, \text{Im } \tau > 0\} \quad (7.10)$$

Surely,the difference between different tori lies in different values of τ . Let us glue now the basic parallelogram in order to form torus with canonical marking,Fig.18b. For the reference torus we can take,say $\tau = i$.Now,if we change τ we thus going to form new torus which ,evidently, **cannot** be **isometrically** transformed to the old one. The relation between the new

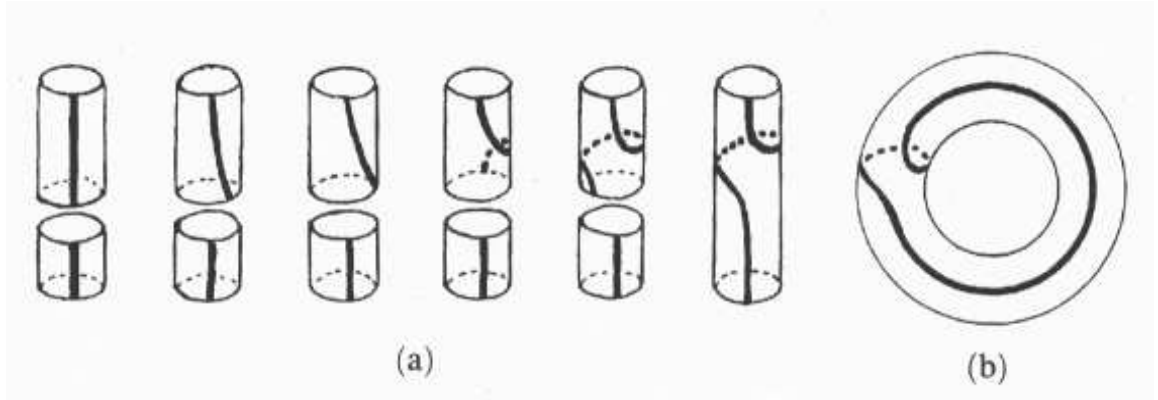

Figure 17: Physics of the Dehn twist

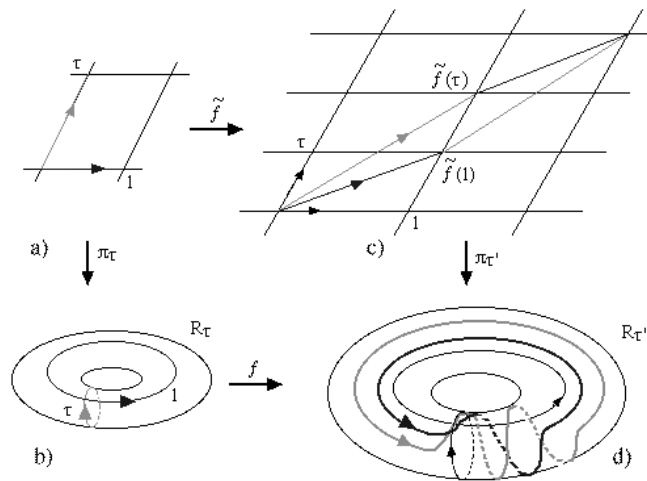

Figure 18: Canonical marking and dynamics of toral automorphisms

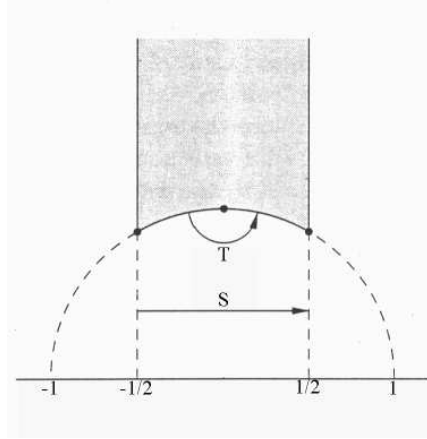

Figure 19: Fundamental domain for $PSL(2,Z)$

torus and the old one is established through

$$\tau' = \frac{a\tau + b}{c\tau + d} \quad (7.11)$$

with a, b, c and d being integers subject to constraint $ad - bc = 1$. The group $PSL(2,Z)$ of the transformations just described is evidently the subgroup of $PSL(2,R)$ introduced in section 3 and is known as **modular** group. Since $PSL(2,R)$ is the group of isometries of H^2 , evidently, $PSL(2,Z)$ is also acting on H^2 . The moduli space $M = H^2 / PSL(2,Z)$ for the torus, by definition, coincides with the fundamental domain, Fig.19, for the group $PSL(2,Z)$ as is well known[51]. The Teichmüller space is related to M but is more physically appealing as it will become clear momentarily. To this purpose, let us discuss the sequence of transformations as depicted in Fig.18c and d. From this figure it is clear, that upon regluing of the deformed parallelogram the pattern of canonical markings, Fig.18b, had undergone some changes and, in view of Fig.17, these changes could be interpreted in terms of the sequence of Dehn twists made with respect to canonical markings. Let us discuss an example of the trefoil knot. Let us have originally the square lattice with sides of the basic square 1 and i respectively. To construct a new lattice we use as a guide Fig.18. The fundamental parallelogram of new periods can be chosen according to the following set of equations written with respect to the "old" axes:

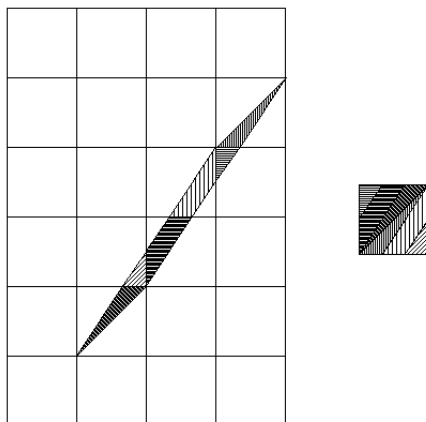

Figure 20: An example of an area preserving toral homeomorphism related to formation of the trefoil knot

$$\tilde{f}(\tau) = \omega_1 \tau' = ai + b \quad (7.12)$$

where in Eq.(7.12) we have to put $a = 3$ and $b = 2$ in order to obtain the trefoil knot. The numbers 3 and 2 are precisely the numbers of full twists with respect to canonical basis. In addition to Eq.(7.12) we also have

$$\tilde{f}(1) = \omega_1 = ci + d \quad (7.13)$$

and

$$ad - bc = 1 \quad (7.14)$$

The above two additional equations reflect the fact that the transformation leading from the original square to the final parallelogram are area-preserving which is insured by Eq.(7.14) while Eq.(7.13) comes as result of such constraint. With $a = 3$ and $b = 2$ Eqs. (7.14) produce the following set of solutions for c and d : a) $c=1, d=1$ or b) $c=-2$ and $d=-1$. Figs 20 and 21 demonstrate all this graphically. Both solutions make sense for the following reasons. These solutions provide the number of Dehn twists for the second basic curve involved in canonical marking. This second basic curve intersects the first one in just one point ,Fig.18b,initially and Fig.

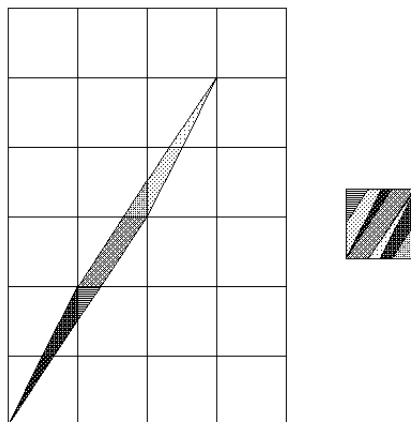

Figure 21: Different toral homeomorphism associated with the same trefoil knot

18d,finally.But the amount of twisting of this second curve is related to the first one only by the law of area conservation so that in both cases we get the trefoil knot for the first basic curve.One can express all this in terms of vectors (a,b) and (c,d) which provide the numbers of Dehn twists along "vertical" /"horizontal" directions for the first and second canonical curves respectively.After this discussion it becomes clear that if we reglue the parallelograms in Fig.20 and 21, we reobtain respective toruses as depicted in Fig.18d. Evidently, if we **physically** relate the initial square to the final parallelogram(s) we recognize that some stretching (may be twisting also)was necessary in order to bring the square to the parallelogram before gluing. Hence, the Dehn twists are **always** associated with some stretching and twisting of the underlying surface. This fact is **directly** associated with the notion of the **Teichmüller space** since it is just the space of parameters responsible for surface deformations. In our case,the driving parameter is τ so that the Teicmüller space is H^2 for both torus and punctured torus[96] as it should become now intuitively clear based on the discussion we had just completed.Finally, the sequence of Dehn twists associated with selfhomeomorphisms(diffeomorphisms) of torus(surface of genus g , in general) causes some fundamental changes in the marking responsible for the fact that,for example,different torus knots are **isometrically** different.Therefore, it is possible to associate the **mapping class group**, known also as **Teichmüller modular group**, with the group generated by all

nontrivial (that is not reducible to identity) Dehn twists (associated with canonical marking) so that the random walk problem of section 6 becomes the problem about the random walk on the mapping class group (except ,now we have to deal with random walks on groups which are not free).An excellent and readable description of the mapping class groups could be found in Ref.[97] while good discussion of random walks on various groups which are not free could be found in Ref[21].Our first illustration of nontriviality of this group is the isometric difference between the tori depicted in Figs.20 and 21. Let us discuss this topic a bit further since it has some applications to dynamics of liquid crystals and 2+1 quantum gravity as described in our earlier work,Ref[17],(and ,especially, Appendix of this reference where connections of these dynamical problems with toral automorphisms (in the simplest case)are discussed) .

If we select τ in the fundamental domain, Fig.19, i.e. in the moduli space M , then, it can be shown[51] ,that different $\tau \in M$ are **not** connected with each other by means of Möbius-type transformation, Eq.(7.11).But,once we picked some specific τ ,then, this τ is connected with other τ' which lies **outside** the moduli space via transformation of the type given by Eq.(7.11) . By means of successive applications of transformation law Eq.(7.11), one can reach all conjugate points in the corresponding hyperbolic triangles which tessellate H^2 so that application of Eq.(7.11) to all points of the moduli space will cover the entire H^2 . Thus the Teicmüller modular group is acting on the moduli space. Moreover, it is possible to show[51] that the arbitrary matrix

$$V = \begin{pmatrix} a & b \\ c & d \end{pmatrix} = TS^{n_1}S^{n_2}T \dots S^{n_k}TS^{n_l} \quad (7.15)$$

where

$$S = \begin{pmatrix} 1 & 1 \\ 0 & 1 \end{pmatrix} \quad (7.16)$$

and

$$T = \begin{pmatrix} 0 & 1 \\ -1 & 0 \end{pmatrix} \quad (7.17)$$

Since

$$T^2 = \begin{pmatrix} -1 & 0 \\ 0 & -1 \end{pmatrix} = \begin{pmatrix} 1 & 0 \\ 0 & 1 \end{pmatrix} \quad (7.18)$$

projectively, e.g. see Eq.(7.11), this explains why in expansion (7.15) all T's have the first power. The fundamental domain for $PSL(2, Z)$ in Fig.19 is depicted with generators T and S in mind. As for the generator S, we had already encountered it, e.g. see Eq.(3.6). This means :a) that the numbers n_1, \dots, n_l can be arbitrary integers and b) that using Eqs(7.15)-(7.17) we can always replace a -generator in Eq.(3.6) with the appropriate sequence of T and S generators. Moreover, the combination $TS = Q$ produces projectively

$$Q^3 = 1 \tag{7.19}$$

so that, in view of Eq.s(7.3) ,(7.18) and (7.19), we can consider the random walk on the complement of the trefoil using the generators of $PSL(2, Z)$. This result is in accord with Ref[81] where other arguments were used to reach the same conclusions. From the discussion we had just presented it is clear that the description of the toral automorphisms by means of the random walks on the mapping class group should be equivalent to traditionally used in the theory of dynamical systems [16]. E.g., for example, the torus mapping depicted in Fig.20 could be equivalently described in terms of the map given by

$$y' = x + 2y \tag{7.20a}$$

$$x' = x + 3y \tag{7.20b}$$

and, of course,

$$1 \cdot 3 - 1 \cdot 2 = 1$$

The above arguments (x and y) in this map should be taken mod 1 [16] by analogy with S^1 case earlier discussed in section 2. For the case of toral automorphisms the use of Teichmüller space interpretation appears as plausible curiosity. The things change dramatically if the self homeomorphisms of surfaces of higher genus is of interest, e.g. in gravity or liquid crystals [17]. In mathematics literature, the Nielsen-Thurston theory of surface selfhomeomorphisms is well developed [24,98] and, in view of the discussion already presented, can be used for description of various physical phenomena, including dynamics of liquid crystals and gravity. Indeed, based on the results just obtained the toral selfhomeomorphisms could be of three types: a) **reducible**, when the words like that in Eq.(7.15) are of finite length (this corresponds to finite continued fraction expansion, Eq.(7.5)); b) **periodic** (which

may correspond to the periodic continued fraction of some quadratic irrationals) and (c) **irreducible** (or Anosov (pseudo Anosov in more general case)) which may be associated with truly irrational continued fraction expansions. The first possibility in the language of liquid crystals[99] corresponds to solid phase, the second to the hexatic phase and the third to the liquid phase. For more details, please, consult our earlier work, Ref[17].

C. Three-manifolds which fiber over the circle

Connections between theory of dynamical systems and theory of knots and links are the most naturally described in terms of the Nielsen-Thurston theory[98] and, although this field is still under active development even in mathematics[100], we would like to provide here a sketch of what one may expect upon development of such connections. This information may be useful in fields ranging from gravity through liquid crystals, dynamics of fracture and even folding of proteins (for references related to these problems, please, consult our earlier work, Ref[17]).

Description of dynamical systems in terms of Lyapunov exponents, fractal and multifractal dimensions, entropy, etc is well known[101]. Recently, however, more and more emphasis is being made on connections between dynamical systems and the theory of knots and links[102]. The complements of knots and links are 3-manifolds and, moreover, there are 3-manifolds which are not related to links/knots, especially those which are not compact. The 3-manifolds arise completely naturally in the theory of dynamical systems. To realize this fact it is sufficient just to take a look again at Fig.15. Extension this picture to a cube with periodic boundary condition creates already our first 3 manifold, i.e. cube with the opposite sides properly identified. This example already provides a clue as to how 3-manifolds can be constructed: e.g. take some polyhedron and identify the opposite sides in some systematic way. As a result of such an identification we again obtain some 3-manifold. Since some of these 3 manifolds are related to knots it is interesting to know that, for example, Fig.8 knot complement, which is also a 3-manifold, can be obtained by proper gluing of faces of two ideal tetrahedra to each other. This and other very beautiful illustrations of making 3-manifolds associated with simple knots/links could be found in Ref.[103]. In case of trefoil, the associated 3-manifold is a (3,2) Lens space. It is easily created out of two **solid** toruses. To do so we should have one torus with standard canonical marking being glued to other (twisted) torus which contains the trefoil knot on its surface so that the initial (canonical)

marking is glued to the final marking and then the rest of two torus surfaces being glued to each other [104]. This example gives an idea about the way 3-manifolds are related to surface dynamics. Let us now be more specific. Let S be some surface and let $x \in S$. Consider a homeomorphism $\psi : S \rightarrow S$. Imagine now that this homeomorphism takes place in stages, i.e. evolves in time so that at time $t=0$ $\psi(x) = x$ while at time 1 $\psi(x)$ may or may not coincide with $x \forall x \in S$. The time 1 is, of course, quite arbitrary and is chosen for convenience only. Let us now identify $(x,0)$ with $(\psi(x),1) \forall x \in S$. This identification leads us to a 3-manifold T_ψ . This 3-manifold is a fiber bundle with fiber S , base S^1 (a circle) and monodromy ψ . It is clear that the monodromy ψ is directly related to the random walk on the Teichmüller modular group (as described in the previous subsection). It is clear also that different surface dynamics will lead to different 3-manifolds in general so that the topology and geometry of 3-manifolds is yet another way of description of dynamical systems [100,102].

The above picture can be elaborated now as follows. Since there is one-to-one correspondence between the sequence of Dehn twists and the sequence of words being regulated by the continued fractions expansions it is clear that the trivial fiber bundle can be associated with the **reducible** selfhomeomorphisms and that the **periodic** selfhomeomorphisms produce naturally 3-manifolds known also as Seifert fibered spaces [81,84,104]. Surely, all torus knots are associated with periodic selfhomeomorphisms and, therefore are in one-to-one correspondence with Seifert fibered spaces as was already established by Seifert in 1933 (the sufficiently simple proof of this could be found in chr.6 of Ref.[81]). What is much less clear why the above construction of 3-manifolds should be also applicable to **irreducible** (or pseudo Anosov) selfhomeomorphisms. The fact that this is actually possible had been proven rather recently [100]. And, the most remarkable fact of this proof lies in use of Feigenbaum-Cvitanovich results for one dimensional maps which, in the light of the results we had presented already should not be totally unexpected. 3-manifolds associated with knots such as figure 8 are hyperbolic. So that all knots other than torus knots should be associated with hyperbolic 3-manifolds. That this is indeed the case had been proven by Thurston [86,103] and was mentioned already in our earlier work, Ref[14]. The hyperbolicity of knots is directly connected with transience of random walks in the presence of such knots as we had already discussed in section 7.A. Moreover, using the results of hyperbolic geometry it is possible to get information about fractal dimensions of the limit sets (in case of dynamical interpretation). Some introduction to this subject can be found in our earlier work, Ref.[105].

D. Schottky doubles, Markov triples and Grothendieck's dessins d'enfants

Although we had covered many aspects of the figure 8 story, there are many topics which we had not mentioned at all so far. In this subsection we would like to correct this deficiency. Evidently, our presentation is going to be brief but, since the topics to be discussed are directly and logically related to the rest of this paper, it is impossible not to mention about them

Let us begin with the notion of Schottky double. From the discussion we had so far it is clear that treatment of boundaries in the hyperbolic geometry is not as simple as it is in Euclidean case. For instance, suppose we would like to calculate the spectrum of Laplacian on the punctured torus. The question immediately arises: how the spectrum of Laplacian will depend upon the boundary conditions at the puncture? To some extent this problem was solved by Gutzwiller[85] who however admits, e.g. see page 376 of Ref.[85], that more systematic mathematical treatment is given in the monograph by Lax and Phillips[106]. Surprisingly, the case is still not closed as recent Annals of Mathematics paper [87] indicates. Hence, it would be too naive to address this problem in its full generality in this paper. Nevertheless, we would like to mention one simple case which has its familiar analogue, for example, in standard quantum mechanics. The idea belongs to Schottky and is described in Ref.[96]. Consider a Riemann surface R with punctures and its copy \bar{R} obtained by reflecting R in the mirror. Given these two copies, glue them along the boundaries of punctures. Thus obtained new Riemann surface is known as Schottky double. In the case of punctured torus the Schottky double is a double torus which, not surprisingly, was also considered by Gutzwiller[85]. Such construction is equivalent of having perfectly reflecting boundary conditions in standard quantum mechanics and also has some applications to polymer solutions in confined geometries[14], etc. The boundary conditions (that is the existence of puncture), as pointed by Gutzwiller [85] and known from the theory of Riemann surfaces[107], could be modelled by imposing certain constraints on the commutator \mathcal{K} defined before Eq.(7.6). In particular, one can require

$$\mathcal{K} = aba^{-1}b^{-1} = \mathcal{P} \quad (7.21)$$

(where \mathcal{P} is transformation of the type given by Eq.(7.11)) to be **parabolic**, that is $\text{tr}(\mathcal{P})=2$. Such requirement provides one constraint on the explicit form of matrices a and b . Additional constraints could be imposed by locating vertices of the hyperbolic triangle at points 0, 1 and ∞ as depicted in Fig.2,

or hyperbolic quadrangle at points $-1, 0, 1$ and $+\infty$, as depicted in Fig.3. Let us check this result explicitly. Using results of section 3 we obtain,

$$a(z) = \frac{z}{2z + 1} \quad (7.22)$$

$$b(z) = z + 2 \quad (7.23)$$

Accordingly,

$$a(z)^{-1} = \frac{z}{-2z + 1} \quad (7.24)$$

and

$$b(z)^{-1} = z - 2 \quad (7.25)$$

Using Eqs.(7.22)-(7.25) in (7.21) a short computation produces

$$\mathcal{P}(z) = \frac{\frac{3}{8}z + 1}{\frac{1}{2}z + \frac{13}{8}} \quad (7.26)$$

From here, $\text{tr}(\mathcal{P}(z))=2$ as required. The above simple calculation teaches us some very important lessons. First, since we are dealing with projective transformations, e.g. that given by Eq.(7.11), we can always normalize our matrices the way which is the most convenient for us. In particular, already in more than hundred years ago Fricke[108] had shown that for any unimodular matrices A and B

$$(\text{tr}A)^2 + (\text{tr}B)^2 + (\text{tr}AB)^2 = (\text{tr}A)(\text{tr}B)(\text{tr}AB) + \text{tr}\mathcal{K} + 2 \quad (7.27)$$

where, as before, \mathcal{K} is the commutator of A and B. Now, let $\text{tr}\mathcal{K} = -2$. This is quite permissible in view of Eq.(7.26) since multiplication by -1 of both numerator and denominator changes nothing (e.g. see Eq.(7.18)). Such normalization however, makes a difference in Eq.(7.27) which now could be brought to form

$$(\text{tr}A)^2 + (\text{tr}B)^2 + (\text{tr}C)^2 = (\text{tr}A)(\text{tr}B)(\text{tr}C) \quad (7.28)$$

where $C = (AB)^{-1}$ and the fact that $\text{tr}(D) = \text{tr}(D^{-1})$ for any unimodular matrix D was used. By setting $|\text{tr}A| = 3m_1$, $|\text{tr}B| = 3m_2$ and $|\text{tr}C| = 3m_3$ we obtain, instead of Eq.(7.28), the following equation for the **Markov triples**[25]

$$m_1 + m_2 + m_3 = 3m_1m_2m_3 \quad (7.29)$$

with m_1, m_2, m_3 being nonnegative integers. By looking at this equation we immediately recognize that it is trivially satisfied by $m_1 = m_2 = m_3 = 1$. This information, when combined with the requirement of unimodularity, is sufficient for restoring the explicit form of matrices A and B, and hence, AB. Questions arise :a) are there other solutions to the equation for Markov triples and b) what is their physical significance if they indeed exist? The answer to the first question is known in mathematical literature and will be discussed shortly below. The answer to the second question could be related to the fractional quantum Hall effect. Indeed, if solutions other than trivial to Eq.(7.29) do exist, then, based on the results of sections 3 and 4, we conclude that they may be associated with different shapes of the fundamental domains in H^2 plane and, accordingly, to different locations of punctures in S^2 . Thus if the punctures are associated with anyons, then, evidently, their mutual position cannot be arbitrary so that we have some sort of solid phase in the **cluster approximation** (made of 3 punctures). Within this approximation the filling fraction [14], $0 < \nu < 1$ can be calculated and, because the pattern of Markov triples is very intricate (see discussion below) one obtains a very rich array of the permissible filling fractions characteristic for the fractional quantum Hall effect [109]. To what extent such cluster picture can be extended to more than 3 punctures is related to the works of Grotendieck on dessin d'enfants [22] to be also discussed below.

Looking at Eq.(7.29) it is clear that there is a complete symmetry between m_1, m_2 and m_3 . This symmetry can be broken if we notice that (2,1,1) is also solution to Eq.(7.29). This solution is called *singular* [25]. It could be shown, that this is the only solution for which 2 out of three Markov numbers are the same. All other solutions have distinct Markov numbers. To generate these other solutions (Markov triples) it is sufficient to have a "seed" in the form (m_1, m_2, m_3) which, by definition, obeys Markov equation, Eq.(7.29). Then, the first generation of new Markov triples given by

$$(m'_1, m_2, m_3), (m_1, m'_2, m_3) \text{ and } (m_1, m_2, m'_3)$$

where

$$m'_1 = 3m_2m_3 - m_1; m'_2 = 3m_1m_3 - m_2; m'_3 = 3m_1m_2 - m_3 \quad (7.30)$$

If one starts with (1,1,1) then, the Markov tree (its part of course) is depicted in Fig.22. The emergence of numbers m'_1 , etc., can be easily understood if we consider, instead of Eq.(7.29), its equivalent form given by

$$f(x) = x^2 - 3m_2m_3x + m_2^2 + m_3^2. \quad (7.31)$$

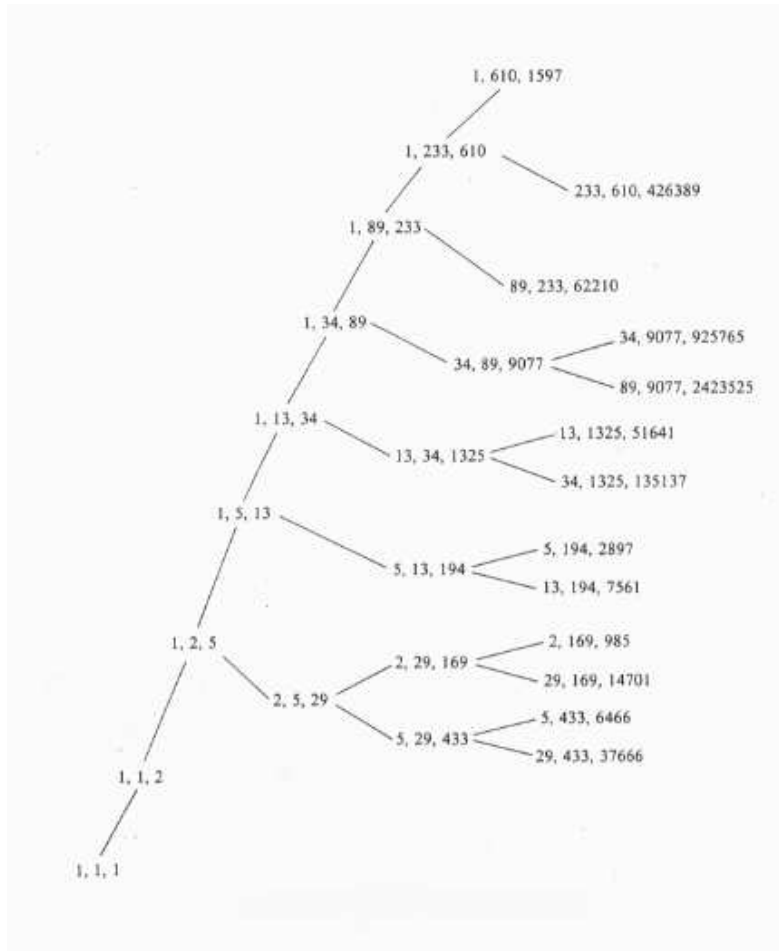

Figure 22: Fragment of the Markov tree closest to the original "seed"

Evidently, $f(x) = 0$ for $x = m_1$ and $x' = 3m_2m_3 - m_1$. Additional information about Markov triples could be found in Refs.[110-112]. Now the question arises as to what extent one can generalize these results to more than tree punctures. There are several ways to proceed. For example, prior to Theorem 7.1. we've noticed that it is sufficient to make one puncture (hole) in surface of any genus g in order to obtain a free group with $2g$ generators. By analogy with Eq.(7.29), one may think of solutions of equation

$$x_1^2 + x_2^2 + \cdots + x_n^2 = nx_1x_2 \cdots x_n \quad (7.32)$$

as it was done by Hurwitz[113] and elaborated by Hirzebruch and Zagier[114]. There is, however, much more striking approach to the whole problem. It was proposed by Grotendieck [22] and was elaborated by Belyi[115] and others[22]. These mathematical results had found already their place in physics literature in connection with problems related to discretized string theory[22] and the theory of polygonal billiards[116]. As it was argued above, these results could be potentially useful in the theory of fractional Hall effect and/or quantum chaos, etc.

The idea of the Grotendieck approach is rather simple. Take for example the torus case. The torus, Fig.18a(or 18b) can be made out of two triangles and, accordingly, any Riemann surface of genus g also can be triangulated. Such triangulation of arbitrary closed Riemann surface could be easily understood if we would consider the motion of fictitious particle in a triangular billiard whose angles are some rational fractions of π . Instead of watching the complicated trajectory inside the triangle it is much better to unfold the trajectory in a way shown in Fig.23. Such unfolded trajectory is just a straight line, just as in the case of a torus, Fig. 14. From the covering surface, e.g. that depicted in Fig.14, one needs now to restore the corresponding (Riemann) surface. This was done initially by Richens and Berry[117] and was subsequently generalized and elaborated by Zemlyakov and Katok[118] and many others, e.g. see Ref.[119]. Strictly speaking, to triangulate Riemann surface one needs to consider such triangle groups whose action on the fundamental domain for such groups will cover (tessellate) given Riemann surface without gaps or overlaps. Grotendieck calls such groups "cartographic groups". A good survey of the cartographic groups is given in Ref.[22]. The triangulation of Riemann surfaces is not a new idea. The new idea lies in utilizing the results for the trice punctured sphere, sections 3-4, in order to achieve the triangulation of Riemann surface of **any** genus. The dessins d'enfants (the drawings of children) problem is directly related to the triangulation problem and can be formulated as problem of drawing an

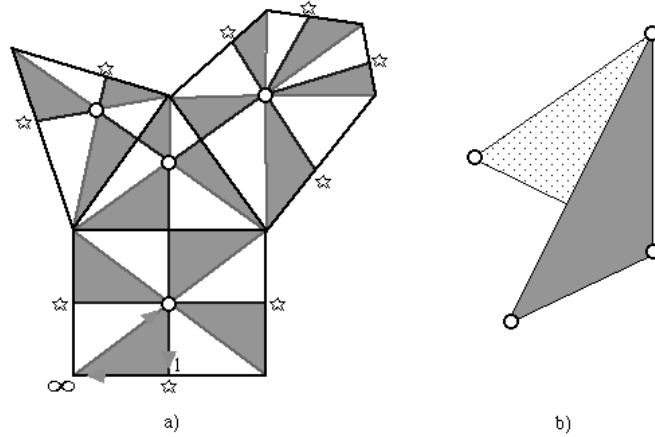

Figure 24: Triangulation of the arbitrary Riemann surface a) and the associated with it double triangle b) which (upon regluing) is topologically equivalent to the trice punctured sphere as discussed in the text

arbitrary (but pre assigned) closed graph on Riemann surface. This happens to be not a simple task. To make a connection between the trice punctured sphere and some Riemann surface one needs to have a mapping function which connects the triangulation on the Riemann surface with triangles on the sphere. This function had been constructed explicitly by Belyi [115]. We follow, however, the work of Shabat and Voevodsky [120] in order to illustrate the basic idea of the method.

If the surface is orientable, it is possible to color the adjacent triangles in two different colors, say, black and white. Given such coloring, one can distinguish three types of vertices: \circ , \cdot , and \star . Let the red arrow connect \circ and \star , let also the black arrow connect \star with \cdot and, finally, let the blue arrow connect \cdot with \circ . Let us next associate the vertex \circ with number 0, \star with 1 and \cdot with ∞ . The above numbers are associated with the location of punctures on S^2 for the trice punctured sphere as discussed in sections 3 and 4. To understand the connection, observation of Fig. 24a is helpful at this time. Let us select two adjacent triangles which, by construction, are colored differently, e.g. see Fig. 24b. Finally, if we glue together these triangles along the free edges, thus obtained object is just a trice punctured sphere. This can be easily understood if we imagine that the triangles are made of rubber and we blow up air through one of the open holes and then close it. Hence, to get a triangulation of an arbitrary Riemann surface \mathcal{R} , one should only

look for the appropriate branched covering with branches over the points 0, 1 and ∞ . Clearly, for each point, say, 0 on S^2 , there is a finite number of the corresponding points on \mathcal{R} , etc. The mapping function $F(z)$ which actually maps $S^2 \setminus \{0, 1, \infty\}$ to \mathcal{R} is given by

$$F(z) = \frac{(m+n)^{m+n}}{m^m n^n} z^m (1-z)^n \quad (7.33)$$

with m, n being some integers which value depends upon the genus of \mathcal{R} .

From this discussion it is clear that thus obtained Markov triples could be now used for an arbitrary \mathcal{R} and this fact then proves their relevance for computation of the multitude of the filling fractions ν characteristic for the fractional Hall effect [109]. To complete our discussion, we have to consider still one more topic.

E. Connections with braid groups

We include this subsection in this paper in order to emphasize some aspects of theory of braids which are directly related to the discussion we had so far. We assume, that the reader is familiar with some basic concepts of the theory of braids [81]. The braid group is infinite group of n-1 generators $\sigma_1, \sigma_2, \dots, \sigma_{n-1}$ obeying the following set of defining equations (in the planar case only)

$$\sigma_i \sigma_j = \sigma_j \sigma_i \text{ for } |i-j| \geq 2 \quad (7.34)$$

and

$$\sigma_i \sigma_{i+1} \sigma_i = \sigma_{i+1} \sigma_i \sigma_{i+1} \text{ for } 1 \leq i \leq n-2. \quad (7.35)$$

As it was shown already by Artin (inventor of the Braid group) [121], the braid group can actually be generated just by its two elements

$$a = \sigma_1 \sigma_2 \dots \sigma_{n-1} \quad (7.36)$$

and

$$\sigma = \sigma_1. \quad (7.37)$$

Thus,

$$\sigma_i = a^{i-1} \sigma a^{-(i-1)}, \quad (7.38)$$

and

$$a^n = (a\sigma)^{n-1}. \quad (7.39)$$

In particular, let $n=3$, then, instead of Eqs(7.35), we get

$$\sigma_1\sigma_2\sigma_1 = \sigma_2\sigma_1\sigma_2 \quad (7.40)$$

Accordingly,

$$a = \sigma_1\sigma_2 \quad (7.41)$$

and, using Eq.(7.40), it is convenient to introduce yet another generator

$$b = a\sigma \quad (7.42)$$

Then, Eq.(7.39) is reduced to

$$a^3 = b^2 \quad (7.43)$$

Thus, we had obtained back the presentation group for the trefoil given earlier by Eq.(7.3). a^n , introduced in Eq.(7.39), has some physical meaning . If we would have a trivial braid made of n strands , then application of a^n to such trivial braid amounts of full rotation of the lower side of the frame while keeping the upper side fixed[81]. Therefore , if the system ,say, is **not** rotationally invariant, one cannot use the concept of braids while the concept of fundamental group of free generators still survives. The connections between braids and free groups could be made more explicit if needed . Here we would like only to touch upon the most immediate connections. To this purpose we need to introduce the notion of **colored** braid. Basically, the braid is colored if the end of each strand lies exactly over its beginning (that is for the ordered sequence on the bottom frame there is exactly the same ordered sequence on the top). From this definition, we notice that colored braids correspond to the **distinguishable** particles in physics terminology . For the colored braids P_n made of n strands ,connection with free groups becomes very direct. Fig. 25 provides an example of a generic action of the braiding generator $a_j^{(i)}$ (an element of a **free** group) while Fig.26 illustrates how the colored braid P_4 could be made out of composition of braids made with help of the generators of the free groups F_1, F_2 and F_3 . For general n mathematically, such braid can be written as semidirect product

$$P_n = F_1 \triangleleft (F_2 \triangleleft (\dots (F_{n-1} \triangleleft F_n)) \quad (7.44)$$

For the colorless case, one can analyze the connections further by using Eq.s(7.36)-(7.39).

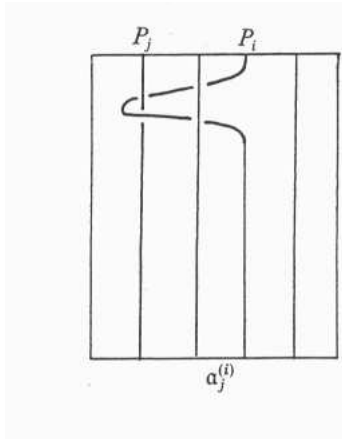

Figure 25: Action of the free group braiding generator $a_j^{(i)}$ on the braid

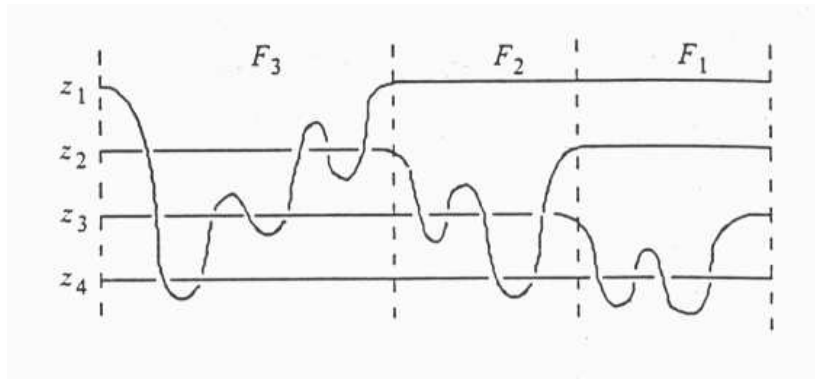

Figure 26: Colored braid made with help of composition of actions of generators of free groups F_1, F_2 and F_3 made of one, two and three generators respectively

References

- [1] A.Kholodenko, Phys.Rev.E **58** ,R5213 (1998).
- [2] F.Spitzer, Am.Math.Soc.Trans.**87**, 187 (1958).
- [3] M.Coornaert and A.Papadopoulos, *Symbolic Dynamics and Hyperbolic Groups* (Springer-Verlag,Berlin, 1993).
- [4] R.Rammal,G.Tolouse and M.Virasoro, Rev.Mod.Phys.**58** ,765 (1986).
- [5] D.Cartwright,V,Kaimanovich and W.Woess, Ann .Inst.Fourier(Grenoble) **44**,
1243(1994).
- [6] R.Adler,Am.Math.Soc.Bull. **35**,1 (1998).
- [7] S.Wu Qian,Zhi-Y Gu and Guo-Q Xie, J.Phys.A**30** ,1273 (1997).
- [8] Y.Aharonov and D.Bohm, Phys.Rev.**115**, 485 (1959).
- [9] T.Shigehara,Phys.Rev.E **50**,4357 (1994).
- [10] T.Shigehara and T.Cheon, Phys.Rev. E **54**, 1321 (1996).
- [11] T.Cheon and T.Shigevara ,Phys.Rev E **54** ,3300 (1996).
- [12] R.Weaver and D.Sornette, Phys.Rev.E **52** ,3341 (1995).
- [13] T.Aste, Phys.Rev.E **55**,6233 (1997).
- [14] A.Kholodenko and Th.Vilgis, Physics Reports **298** (5,6),251 (1998).
- [15] N.Varopoulos, Math Proc. Cambr. Phil.Soc. **97**,299 (1985).
- [16] A.Katok and B.Hasselblat, *Introduction to the Modern Theory of Dynamical Systems* (Cambridge U.Press,Cambridge,1997).
- [17] A.Kholodenko , hep-th/9901040 and hep-th/9901047 , Journal of Geometry and Physics(in press).
- [18]K.Ito and H.McKean, *Diffusion Processes and Their Sample Paths* (Springer-Verlag, Berlin,1965).
- [19] T.Lyons and H.McKean ,Adv. Math. **51**,212 (1984).
- [20] H.McKean and D.Sullivan ,Adv Math.**51**, 203 (1984).
- [21] W.Woess, London Math.Soc.Bull. **26**,1 (1994).
- [22] L.Schnieps Editor,*The Grotendieck Theory of Dessins D'Denfants* (Cambridge U.Press, Cambridge, 1994).
- [23] P.Kasteleyn, in Group Theoretical Methods in Physics (Springer-Verlag, Berlin,1983).
- [24] W.Thurston, Am.Math.Soc.Bull. **19**,417 (1988).

- [25] T.Cusick and M.Flahive, *The Markoff and Lagrange Spectra* (AMS Publ.Providence, RI , 1989).
- [26] L.Sculman, *Phys.Rev.***176**,1558 (1968).
- [27] L.Schulman, *J.Math.Phys.* **12**, 304 (1971).
- [28] J.Dovker,*J.Phys. A* **5** ,936 (1972).
- [29] H.Poincare, *Papers on Fuchsian Equations*, J.Stillwell Editor(Springer-Verlag,Berlin,1985).
- [30] M.Yoshida ,*Fuchsian Differential Equations* (Vieweg & Sohn, Wiesbaden,1987).
- [31] L.Schulman, *Techniques and Applications of Path Integration* (J.Wiley & Sons, New York,1981).
- [32] R.Jackiw, *Comments in Nuclear and Particle Phys.***15**, 99 (1985).
- [33] P.Levy, *Processus Stochasiques et Movement Brownien* (Gauthier-Villars,Paris,1948).
- [34] R.Durrett, *Brownian Motion and Martingales* (Wadsworth Inc.,Belmont, CA, 1984).
- [35] S.Deser,R.Jackiw and G.t'Hooft ,*Ann.Phys.***152**, 220 (1994).
- [36] T.Jaroszkevich, *Phys.Rev.Lett.* **61**, 2401 (1988).
- [37] D.Khandekar and S.Lavande ,*Phys.Reports* **137**,115 (1986).
- [38] H.Bateman and A.Erdelyi, *Tables of Integral Transforms*,Vol.1 (Mc-Graw Hill,New York,1954).
- [39] N.Levinson and R.Redheffer, *Complex Variables* (Holden Day Inc.,San Francisco,1970).
- [40] A.Kholodenko and A.Beyerlein, *Phys.Lett.A* **132** ,347 (1988).
- [41] P.Gerl, *Lecture Notes in Math.* Vol.1210 ,285 (1986).
- [42] C.Itzykson and J.Drouffe, *Statistical Field Theory*, Vol.1 (Cambridge U.Press,Cambridge,1989).
- [43] N.Gilbert and T.Porter , *Knots and Surfaces* (Clarendon Press,Oxford, 1994).
- [44] W.Magnus, A.Karras and D.Solitar ,*Combinatorial Group Theory* (J.Wiley & Sons, New York,1966).
- [45] H.Coxter and W.Moser ,*Generators and Relations for Discrete*

- Groups* (Springer-Verlag, Berlin,1980).
- [46] S.Katok, *Fuchsian Groups*(U.of Chicago Press, Chicago, 1992).
- [47] L.Ford, *Automorphic Functions* (McGraw Hill,New York,1929).
- [48] Z.Nehari,*Conformal Mapping* (Dower Publ.Inc.,New York,1975).
- [49] L.Keen, Math.Intellegencer **16**, 11 (1994).
- [50] J.Hempel,London Math.Soc.Bull.**20** ,97 (1986).
- [51] N.Akhieser, *Elements of the Theory of Elliptic Functions* (Nauka, Moscow,1970).
- [52] P.Zograf and L.Takhtadjian, Math.USSR,Sbornik **60**,143 (1988).
- [53] A.Belavin,A.Polyakov and A.Zamolodchikov ,Nucl.Phys.B **241**,333 (1984).
- [54] L.Takhtadjian,Phys.Lett.A **8**,3529 (1993).
- [55] P.Zograf,Leningrad Math.Journ.**1**,941 (1990).
- [56] C.Itzykson and J-B Zuber,*Quantum Field Theory* (McGraw Hill,New York,1980).
- [57] L.Schlessinger,J.fur Reine und Angev.Math.**141**,96 (1912).
- [58] M.Jimbo and T.Miva , *Integrable Systems in Statistical Mechanics* (World Scientific,Singapore,1985).
- [59] B.Blok and S.Yankelowitz, Nucl.Phys. B **321**,717 (1989).
- [60] N.Hitchin, J.Diff.Geometry **42**,30 (1995).
- [61] V.Knizhnik and A.Zamolodchikov ,Nucl.Phys.B **247**,83 (1984).
- [62] C.Kassel,*Quantum Groups* (Springer-Verlag,Berlin,1995).
- [63] V.Drinfeld,Leningrad math.Journ.**1**,1419 (1990).
- [64] T.Lee and J.Murakami, Compositio Math.**102**,41 (1996).
- [65] D.Bar Natan,Topology **34**, 423 (1995).
- [66] D.Altshuller and L.Freidel ,Comm.Math.Phys. **170**, 41 (1995).
- [67] D.Bar Natan, Proc.Symp.in Appl.Math. **51**,129 (1996).
- [68] N.Muskhelishvili,*Singular Integral equations* (Gröningen, Nederlands,1953).
- [69] D.Hilbert, Gott.Nachr. **14**,289(1900).
- [70] G.Birkhoff,*Collected Works* ,Vol.1 (AMS Press,New York,1950).
- [71]J.Plemej,*Problems in the Sence of Riemann and Klein*(Interscience Publ.New York,1964).
- [72] S.Novikov,S.Manakov,L.Pitaevskii and V.Zakharov ,*Theory of Solitons*

- (Consultants Bureau, New York,1984).
- [73] H.Kesten, Am.Math.Soc.Transactions **92**,336 (1959).
- [74] J.Stillwell, *Classical Topology and Combinatorial Group Theory* (Springer-Verlag,Berlin,1995).
- [75] J.Milnor, J.of Differential Geometry **2**,1 (1968);see also *Collected Works*, Vol.1
(Publish or Perish ,Houston,1994).
- [76] E.Gys,P.de la Harpe Editors ,*Sur les Groupes Hyperboliques D'Apres Mikhael Gromov*(Birkhäuser,Boston ,1990).
- [77] M.Coornaert,T.Deslant and A.Papadopoulos ,*Geometrie et Theorie des Groups* (Springer-Verlag,Berlin,1990).
- [78] W.Feller, *An Introduction to Probability Theory and its Applications* ,Vol.1
(John Wiley & Sons Inc.,New York,1957).
- [79] B.Huges and M.Sahimi , J.Stat.Phys.**29**,781 (1982).
- [80] N.Biggs, *Iteration Models* (Cambridge U.Press,Cambridge,1977).
- [81] G.Brude and H.Zieshang , *Knots* (Walter de Gruyter,Berlin,1985) .
- [82] W.Magnus, *Max Dehn* ,Math.Intellegencer,**1**,132 (1978).
- [83] T.Grossman and W.Magnus ,*Groups and Their Graphs* (Random House,New York,1964).
- [84] W.Thurston,Am.Math.Soc.Bulletin **6**,357 (1982).
- [85] M.Gutzviller,*Chaos in Classical and Quantum Mechanics* (Springer-Verlag,Berlin,1990).
- [86] J.Avron,R.Seiler and P.Zograf,Phys.Rev.Lett.**75**,697 (1995).
- [87] L.Gullope and M.Zworski, Ann.Math.**145**,597 (1997); ibid Y.Minsky,*The Classification of Punctured Torus Groups* ,Ann.Math. (to be published).
- [88] C.Series,Math.Intellegencer **7**, 20 (1985).
- [89] B.Kitchens, Symbolic Dynamics (Springer-Verlag,Berlin,1988).
- [90] C.Series, J.London Math.Soc. **31** ,69 (1985).
- [91] G.Hardy and E.Wright, *Introduction to the Theory of Numbers* (Clarendon Press,Oxford,1960).
- [92] S.Nonnemacher and A.Voros, J.Stat.Phys. **92**,431 (1998).

- [93] P.di Francesco, P.Mathieu and D.Senechal, *Conformal Field Theory* (Springer-Verlag,Berlin,1997).
- [94] J.Marklof,Comm.Math.Phys.**199**,169 (1998).
- [95] J.Milnor, *Singular Points of Complex Hypersurfaces* (Princeton U.Press,Princeton,1968).
- [96] W.Abikoff, *The Real Analytic Theory of Teichmüller Space* (Springer-Verlag,Berlin,1980).
- [97] J.Birman ,in *Discontinuous Groups and Riemann Surfaces*(Princeton U.Press,Princeton,1974).
- [98] A.Casson and S.Bleiler,*Automorphisms of Surfaces after Nielsen and Thurston*(Cambridge U.Press,Cambridge,1995).
- [99] P.Chaikin and D.Lubensky ,*Principles of Condensed Matter Physics* (Cambridge U.Press,Cambridge,1995).
- [100] C.McMullen , *Renormalization and 3-Manifolds Which Fiber Over the Circle*(Princeton U.Press,Princeton,1996).
- [101] Y.Pesin, *Dimension Theory in Dynamical Systems* (The U.of Chicago Press,Chicago,1997).
- [102] R.Ghrist,P.Holmes and M.Sullivan, *Knots, Links and Three-Dimensional Flows*(Springer-Verlag,Berlin,1997).
- [103] W.Thurston,*Geometry and Topology of 3 Manifolds* (Princeton U.,Department of Mathematics,Set of Lecture Notes,Princeton,1979).
- [104] D.Rolfsen,*Knots and Links* (Publish or Perish,Houston,TX,1990).
- [105] A.Kholodenko, hep-th/9902167.
- [106] P.Lax and R.Phillips, *Scattering Theory for Automorphic Functions* (Princeton U.Press,Princeton,1976).
- [107] H.Farkas and I.Kra , *Riemann Surfaces* (Springer-Verlag,New York,1992).
- [108] R.Fricke,Gött.Nach.12 ,91 (1896).
- [109] F,Wilzek,*Fractional Statistics and Anyon Superconductivity* (World Scientific,Singapore,1990).
- [110] H.Kohn, in Lecture Notes in Pure and Applied Math,Vol.92 ,D.Chudnovsky and G.Chudnovsky Editoirs (Marcell Dekker,New York,1984).

- [111] B.Bowdich, London Math.Soc.Bull.**28**,73 (1996).
- [112] B.Bowdich, London Math Soc.Proceedings,**77**,697 (1998).
- [113] A.Hurwitz, Math.Ann.39,279 (1891).
- [114] F.Hirzerbruch and D.Zagier, *The Atiach-Singer Theorem and Elementary Number Theory*(Publish or Perish,Houston,1974).
- [115] G.Belyi, Math.USSR, Izvestia **14**,247 (1980).
- [116] P.Cohen,C.Itzykson and J.Wolfart,Comm.Math.Phys.**163** ,605 (1994).
- [117] P.Richens and M.Berry ,Physica D **2** ,495 (1981).
- [118] A.Zemlyakov and A.Katok ,Math.Notes,**18**,291 (1975).
- [119] S.Tabachnikov, *Billiards* (SMF,Marseille,1995).
- [120] G.Shabat and V.Voevodsky, in Progress in Math.,Vol.88 (Birkhäuser,Boston,1990).
- [121] E.Artin,Ann.Math.**48**,101;ibid 643 (1947).