

Multidimensional Bosonization

A. Houghton¹, H.-J. Kwon², and J. B. Marston¹

October 8, 2018

¹Department of Physics, Box 1843, Brown University, Providence RI 02912-1843 USA

²Department of Physics, University of Florida, Gainesville, FL 32611-8440 USA

Abstract

Bosonization of degenerate fermions yields insight both into Landau Fermi liquids, and into non-Fermi liquids. We begin our review with a pedagogical introduction to bosonization, emphasizing its applicability in spatial dimensions greater than one. After a brief historical overview, we present the essentials of the method. Well known results of Landau theory are recovered, demonstrating that this new tool of many-body theory is robust. Limits of multidimensional bosonization are tested by considering several examples of non-Fermi liquids, in particular the composite fermion theory of the half-filled Landau level. Nested Fermi surfaces present a different challenge, and these may be relevant in the cuprate superconductors. We conclude by discussing the future of multidimensional bosonization. [Published in *Advances in Physics* **49**, 141 - 228 (2000).]

Contents

1	Introduction	2
2	Basics of Bosonization	10
3	Stability of Fermi Liquids	21
4	Thermodynamics of Fermi Liquids	25
5	Collective Modes	28
6	Quasiparticle Properties	32
7	Two Particle Properties: Density Response	45
	7.1 Response at Small Wavevectors	46
	7.2 Response at $ \mathbf{q} \approx 2k_F$	47
8	The Half-Filled Landau Level	50

9	Two-Particle Response of Gauge-Fermion Systems	62
10	Nested Fermi Surfaces	66
11	Conclusion	78
12	Acknowledgments	81
A	Calculation of the Boson Correlation Function	81
B	Integrating Out Fast Boson Fields	82
C	Free Fermion Propagator	83
D	How Kohn's Theorem Is Satisfied	84

1 Introduction

Bosonization, a concept which sounds quite mysterious, is in fact both easy to understand and ubiquitous. In this review we outline an approach via bosonization to the problem of many interacting fermions in spatial dimensions greater than one. As the virtue of multi-dimensional bosonization lies in the reduction of complicated four-fermion interactions to a Gaussian problem, we stress the simplicity of the approach.

Multidimensional bosonization is more delicate than bosonization in one dimension. In particular the technique is not useful for certain strongly correlated systems, specifically those in which the Fermi surface is obliterated by singular or unscreened interactions, as it relies heavily on the existence of an abrupt change in the quasiparticle occupancy near the Fermi wavevector. It is also difficult to implement systematic perturbative expansions using bosonization. In these instances, it is more useful to work with the original fermionic variables. Nevertheless bosonization provides a straightforward approach to many interesting problems and we begin this review with a brief introduction to the method in its several forms.

Historically bosonization has been associated closely with the quantum physics of particles moving in one spatial dimension or with statistical mechanics in two dimensions. (For up-to-date reviews of one-dimensional bosonization, which contain material not covered here, see the articles by Schulz[1], Voit[2], and von Delft and Schoeller[3].) But any fermion system which exhibits collective excitations has some sort of bosonic description. Spin waves in a ferromagnet, plasmons in a metal, and superconducting order are well known examples. In these instances, some if not all of the low energy degrees of freedom have a bosonic description. We focus here on cases when *all* of the low-energy fermion degrees of freedom may be replaced by bosons. Mathematically the replacement can be carried out, at least formally, by means of a Hubbard-Stratonovich transformation[4]: auxiliary bosons are coupled to the fermion degrees of freedom, and then the fermions are integrated out yielding a purely bosonic effective theory. In practice, however, the transformation is useful only if there are

additional constraints. The following two examples illustrate the power of bosonization when the fermions are subject to constraints in the form of infinite symmetries.

Consider first the problem of representing a spin-1/2 degree of freedom in terms of the underlying fermions. The angular momentum algebra is reproduced faithfully if we introduce fermion creation and annihilation operators $c^{\dagger\alpha}$ and c_α which obey the canonical anticommutation relations $\{c^{\dagger\alpha}, c_\beta\} = \delta_\beta^\alpha$. Then we may write:

$$\vec{S} = \frac{1}{2} c^{\dagger\alpha} \vec{\sigma}_\alpha^\beta c_\beta \quad (1.1)$$

subject to the constraint

$$n \equiv c^{\dagger\alpha} c_\alpha = 1 . \quad (1.2)$$

Here an implicit summation over repeated raised and lower Greek spin indices is assumed. More generally, to describe a quantum magnet for instance, we attach a site index \mathbf{x} to the operators:

$$\vec{S}_\mathbf{x} = \frac{1}{2} c_\mathbf{x}^{\dagger\alpha} \vec{\sigma}_\alpha^\beta c_{\mathbf{x}\beta} . \quad (1.3)$$

If, for example, we consider now the nearest-neighbor Heisenberg magnet

$$H = J \sum_{\langle \mathbf{x}, \mathbf{y} \rangle} \vec{S}_\mathbf{x} \cdot \vec{S}_\mathbf{y} \quad (1.4)$$

it is clear that its representation in terms of the underlying fermions is not as economical as its representation in terms of the spins themselves, since the spin operators of equation 1.3, and hence the Hamiltonian equation 1.4, are invariant under $U(1)$ gauge transformations at each lattice point[5, 6]:

$$\begin{aligned} c_{\mathbf{x}\alpha} &\rightarrow e^{i\theta_\mathbf{x}} c_{\mathbf{x}\alpha} . \\ c_\mathbf{x}^{\dagger\alpha} &\rightarrow e^{-i\theta_\mathbf{x}} c_\mathbf{x}^{\dagger\alpha} \end{aligned} \quad (1.5)$$

because the local phase rotation $\theta_\mathbf{x}$ cancels out. We denote this infinite gauge symmetry $U(1)_x^\infty$. The physical meaning of this local symmetry is simply that the charge degrees of freedom are frozen out and play no role in the insulating magnet. The underlying fermions have both charge and spin degrees of freedom, but as the number of fermions on each site is fixed to be one, only the spin degree of freedom is active.

Spin operators $S_\mathbf{x}^+$ and $S_\mathbf{x}^-$ create particle-hole excitations, localized on a single site \mathbf{x} . That is, $S_\mathbf{x}^+$ creates a spin- \uparrow fermion and destroys a spin- \downarrow fermion at site \mathbf{x} . These local particle-hole excitations, taken together, have a bosonic character, as two fermions bound together obey boson statistics. As the charge degree of freedom is frozen in place, the remaining spin degree of freedom can be represented instead in terms of bosons which obey the usual canonical commutation relations $[b_\alpha, b^{\dagger\beta}] = \delta_\alpha^\beta$. Now it is permissible to write:

$$\vec{S}_\mathbf{x} = \frac{1}{2} b_\mathbf{x}^{\dagger\alpha} \vec{\sigma}_\alpha^\beta b_{\mathbf{x}\beta} . \quad (1.6)$$

These spins obey precisely the same algebra, and if we now constrain the number of bosons to be one per site,

$$n_\mathbf{x} \equiv b_\mathbf{x}^{\dagger\alpha} b_{\mathbf{x}\alpha} = 1 , \quad (1.7)$$

the operators are spin- $\frac{1}{2}$. Note that such a replacement of fermions with bosons – our first concrete example of bosonization – would not have been permissible for a model which contains both charge and spin degrees of freedom, such as the Hubbard model. For instance, in the non-interacting $U \rightarrow 0$ limit, the Hubbard model reduces to the tight-binding model

$$H = -t \sum_{\langle \mathbf{x}, \mathbf{y} \rangle} c_{\mathbf{x}}^{\dagger \alpha} c_{\mathbf{y} \alpha} + H.c. \quad (1.8)$$

which is clearly not invariant under the $U(1)_x^\infty$ transformations, equation 1.5. Distinct $U(1)$ rotation angles at neighboring sites, θ_x and θ_y do not cancel in general. Physically this means that the full Fermi character of the electrons is manifested, as they propagate from lattice site to lattice site. Of course the ground state in the $U \rightarrow 0$ limit is a degenerate Fermi liquid. For $U > 0$ at half-filling, and for a bipartite lattice, on the other hand, the charge degrees of freedom are frozen out. Then the low energy effective theory of the resulting antiferromagnetic insulator does exhibit the $U(1)_x^\infty$ symmetry.

At this point it might be asked what *practical* benefit can be gained by the replacement of the fermions with bosons. Our model provides a nice illustration: with bosons, semiclassical approximations may be contemplated. In the case of the antiferromagnet with $J > 0$, for instance, an expansion in powers of $1/S$ about the limit of large on-site spin S is now possible [7], as the on-site spin can be increased simply by populating more bosons at each site: $S = \frac{1}{2}n_b$. (In the fermion representation this can only be done by attaching an additional orbital index to the fermions, and then enforcing Hund's rule to align the fermions into a maximal spin state.) In particular, the Néel ordered state of the unfrustrated antiferromagnet on a square lattice can be accessed in this way even at the mean-field level. In contrast mean-field theories with fermions are disordered[7].

There is another system which possesses infinite $U(1)$ symmetry and which can be bosonized easily: the free, degenerate, Fermi gas or liquid[8]. We begin with the usual Hamiltonian:

$$H = \sum_{\mathbf{k}} \epsilon_{\mathbf{k}} c_{\mathbf{k}}^{\dagger \alpha} c_{\mathbf{k} \alpha} . \quad (1.9)$$

The Hamiltonian is invariant under an infinity of $U(1)$ rotations, but now at each point in momentum space, rather than position space:

$$\begin{aligned} c_{\mathbf{k} \alpha} &\rightarrow e^{i\theta_{\mathbf{k}}} c_{\mathbf{k} \alpha} . \\ c_{\mathbf{k}}^{\dagger \alpha} &\rightarrow e^{-i\theta_{\mathbf{k}}} c_{\mathbf{k}}^{\dagger \alpha} . \end{aligned} \quad (1.10)$$

This $U(1)_k^\infty$ symmetry, like the $U(1)_x^\infty$ symmetry explored above, has a clear physical interpretation: in the absence of interactions and disorder, momentum is a good quantum number for the single-particle states, as these are infinitely long-lived. Thus we may make the identification:

$$\begin{aligned} U(1)_x^\infty &\leftrightarrow \text{insulating solid} \\ U(1)_k^\infty &\leftrightarrow \text{conducting liquid.} \end{aligned} \quad (1.11)$$

Again the particle-hole pairs can be bosonized, and this bosonization furnishes us with another example of how some properties can be seen more clearly in the bosonic basis. Recall

the classic calculation of the specific heat at constant volume V , C_V , of a degenerate Fermi liquid[9]. Two integrals, each a function of the temperature T and the chemical potential μ , must be computed: the total energy of the system $U(T, \mu)$ and the total number of fermions $N(T, \mu)$. To extract C_V , the chemical potential must be determined first, as it depends on temperature. Taking this variation into account, the correct answer at low temperatures is:

$$C_V = \left(\frac{\partial U}{\partial T} \right)_N = \frac{\pi^2}{3} k_B^2 T N(0) \times V. \quad (1.12)$$

Here $N(0)$ is the density of states per unit volume at the Fermi surface. The same result may be recovered more readily by simply treating the particle-hole excitations as free bosons. More readily, because there is no chemical potential for the bosons as they are not conserved in number, but rather vanish in the zero-temperature limit. Now the total energy of a system of free bosons with single-particle energies ϵ_i is given by:

$$U = \sum_i \frac{\epsilon_i}{e^{\epsilon_i/k_B T} - 1} \quad (1.13)$$

and therefore

$$C_V = \frac{1}{4k_B T^2} \sum_i \frac{\epsilon_i^2}{\sinh^2\left(\frac{\epsilon_i}{2k_B T}\right)}. \quad (1.14)$$

To apply this formula we need a sensible interpretation of ϵ_i . As we are interested in the low-temperature properties, we first linearize the spectrum of particle-hole excitations:

$$\begin{aligned} \epsilon_{\mathbf{k}+\mathbf{q}} - \epsilon_{\mathbf{k}} &= \frac{(\mathbf{k} + \mathbf{q})^2 - \mathbf{k}^2}{2m} \\ &\approx \frac{\mathbf{k} \cdot \mathbf{q}}{m} \end{aligned} \quad (1.15)$$

where the second line holds in the limit $|\mathbf{q}| \ll |\mathbf{k}|$. This restriction means that we are considering only particle-hole excitations where particle and hole have nearly the same momentum. We show below that this constraint, which is unphysical, can in fact be discarded. At low temperatures the particle-hole pairs lie near the Fermi surface, and we may set $|\mathbf{k}| = k_F$, the Fermi momentum. Then the dispersion reads

$$\epsilon_{\mathbf{k}+\mathbf{q}} - \epsilon_{\mathbf{k}} = v_F q_{\parallel} \quad (1.16)$$

where q_{\parallel} is the component of the momentum parallel to the Fermi wavevector \mathbf{k} at the Fermi surface, $q_{\parallel} \equiv \hat{\mathbf{k}} \cdot \mathbf{q}$. Of particular significance is the fact that the energy of a pair has this simple form when $|\mathbf{q}| \ll k_F$, not depending on \mathbf{k} , but rather only on the relative momentum q_{\parallel} . The energy of a particle-hole pair, like that of a single free particle, is determined uniquely by a single momentum. Substituting the dispersion into the specific heat formula, equation 1.14, we obtain:

$$\begin{aligned} C_V &= \frac{\text{No. of states on the Fermi Surface}}{4k_B T^2} \times \sum_{q_{\parallel} > 0} \frac{(v_F q_{\parallel})^2}{\sinh^2\left(\frac{v_F q_{\parallel}}{2k_B T}\right)} \\ &= \frac{8\pi k_F^2 (L/2\pi)^3}{4k_B T^2} \times \int_0^{\infty} dq_{\parallel} \frac{v_F^2 q_{\parallel}^2}{\sinh^2\left(\frac{v_F q_{\parallel}}{2k_B T}\right)}. \end{aligned} \quad (1.17)$$

Upon making a change of variables, and using the fact that

$$\int_0^\infty \frac{x^2 dx}{\sinh^2(x)} = \frac{\pi^2}{6} \quad (1.18)$$

the exact result, equation 1.12, is recovered with the correct prefactor[8].

Why is it permissible to restrict $|\mathbf{q}| \ll k_F$? At any non-zero temperature there are a macroscopic number of particle-hole excitations, some with large \mathbf{q} and some with small \mathbf{q} . However, in the vicinity of any point on the Fermi surface there are statistically equal numbers of particles and holes. Whether or not these particles and holes originate from small or large momentum scattering processes, they have the same statistical mechanical description, and they can always be re-assigned to small- \mathbf{q} pairs which are described accurately by the above bosonic calculation.

With this introduction to multidimensional bosonization, we turn now to a brief history of efforts to use bosonization to describe interacting fermion liquids. For more than forty years Landau Fermi liquid theory provided the framework to discuss the physics of strongly interacting fermion systems[10]. In the phenomenological theory the coupling between electrons is given in terms of a few parameters which are determined by comparison with experiment[11]. Landau Fermi liquid theory, focusing on the collective excitations of the Fermi surface, is a type of bosonization. Zero sound modes, ordinary sound, and paramagnetic spin waves all have a bosonic character, despite their origin in terms of fermions.

A microscopic interpretation of the Landau theory was provided in the late 1950's and early 1960's via many body perturbation theory[12, 13]. Although the main idea behind Fermi liquid theory is deceptively simple, the concept of a quasiparticle, its realization in the microscopic theory is far from straightforward. Qualitatively when an electron interacts with all of the other electrons it polarizes its immediate vicinity due to the electron-electron repulsion, and this complex entity is the Landau quasiparticle. In this picture the interaction between electrons does not affect the quantum numbers of the electron, only its dynamics. For example the effective mass m^* of the quasiparticle generally differs from the bare mass of the electron. In the microscopic approach, the existence of the quasiparticle can be ascertained by identifying a simple pole in the single-particle Green's function. At zero temperature this pole yields a δ -function peak in the single-particle spectral function at the Fermi surface. In the non-interacting case all of the weight is in this peak and there is no incoherent contribution to the spectral function. For free electrons the single-particle occupancy $n_{\mathbf{k}}$ has a discontinuity of magnitude $Z_F = 1$ at $|\mathbf{k}| = k_F$. When interactions are turned on, according to the Landau hypothesis, the discontinuity remains, but is reduced in magnitude to $0 < Z_F < 1$, as shown in figure 1 with the remaining spectral weight appearing as incoherent background. This idea is made explicit by considering a power-series expansion of the self-energy of the quasiparticle about the low-energy limit:

$$\Sigma(\omega, \mathbf{k}) = a \omega + b \epsilon_{\mathbf{k}} + ic \omega^2 \text{sgn}(\omega) + O(\omega^3) . \quad (1.19)$$

In the absence of singular interactions, Pauli blocking constrains the phase space for scattering, as shown in figure 2. The scattering rate vanishes as ω^2 in the low-energy limit[14, 15], and thus the $U(1)_k^\infty$ symmetry is recovered in this limit (see below). The mapping of the bare fermions $c_{\mathbf{k}}$ onto the Landau quasiparticles $\psi_{\mathbf{k}}$ may also be made explicit by writing:

$$\psi_{\mathbf{k}} = Z_F^{-\frac{1}{2}} c_{\mathbf{k}} \quad (1.20)$$

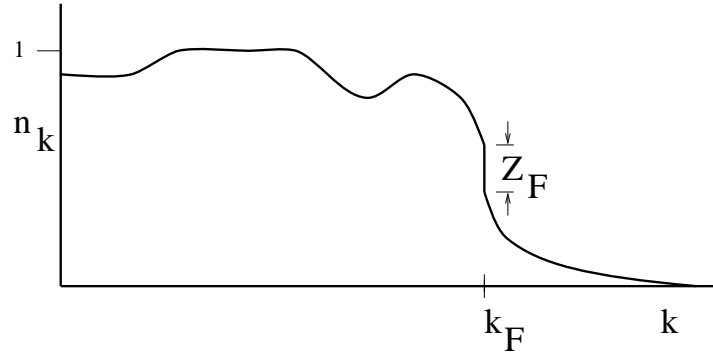

Figure 1: Particle occupancy of the interacting Fermi liquid. The discontinuity at the Fermi surface has magnitude $Z < 1$; remaining spectral weight shows up as incoherent structure at higher energies away from the Fermi surface.

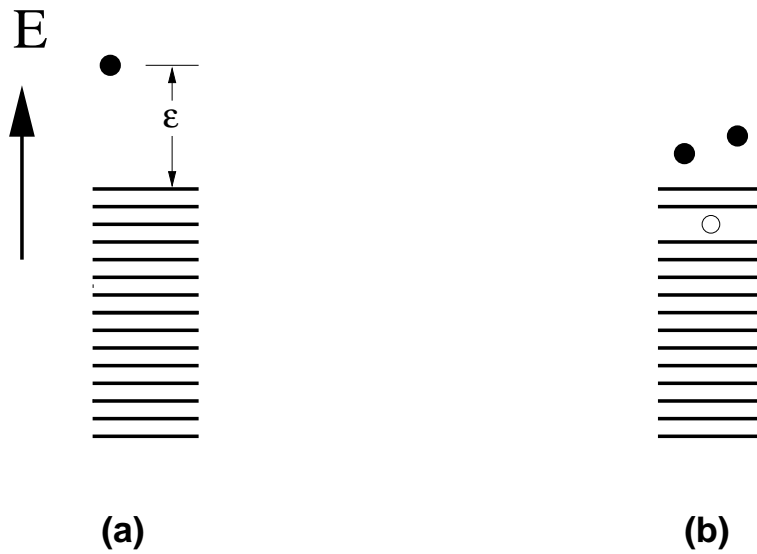

Figure 2: A quasiparticle (a) of energy ϵ can lower its energy via the formation of a particle-hole pair (b), but the phase-space for these processes diminishes as ϵ^2 in the $\epsilon \rightarrow 0$ limit. This is known as Pauli blocking.

where in terms of the self-energy, equation 1.19, we have $Z_F^{-1} = 1 + a$ and $m^* = m \times (1 - a)/(1 + b)$. With this renormalization, the single-particle occupancy of the quasiparticles, $\langle \psi_{\mathbf{k}}^\dagger \psi_{\mathbf{k}} \rangle$, like that of free fermions, has a unit step at the Fermi surface. According to Luttinger's theorem[16], the discontinuity in the occupancy encloses the same volume in momentum space. In the special case of the isotropic Fermi gas with a spherical Fermi surface, the surface remains fixed at exactly the same position.

The existence of Landau quasiparticles implies the existence of a Fermi surface, but the reverse does not necessarily hold. In one spatial dimension it is well known that the Landau picture breaks down, perturbation theory diverges, and the quasiparticle is destroyed by the interactions. In this case a different paradigm, the ‘‘Luttinger liquid,’’ (the term having been introduced in 1981 by Haldane[17]) describes a wide range of interacting fermion systems. The foundation for this picture was provided in early work by Tomonaga[18] who showed how to bosonize a one-dimensional interacting fermion system with a band cutoff. The foundations of one-dimensional bosonization were further developed by Luther and Peschel[19], Coleman[20], and Mandelstam[21]. Mattis and Lieb[22] showed that a model of interacting fermions proposed by Luttinger[23] (a model which allowed only forward scattering and in which the cutoff was taken to infinity) could be solved exactly. This solution demonstrated explicitly that the low energy degrees of freedom of the interacting one-dimensional electron gas are collective modes of charge density and spin density. Nonetheless a Fermi surface survives in the sense that the single-particle occupancy is non-analytic at exactly the same locations in momentum space as the free Fermi gas,

$$n_k \sim n_{k_F} - \text{const} \, \text{sgn}(k - k_F) |k - k_F|^{2\zeta} , \quad (1.21)$$

where the exponent ζ depends on the interaction strength[2]. The Luttinger liquid fixed point has $U(1)_L \otimes U(1)_R$ symmetry which reflects the conservation of the number of quasiparticles at each of the two Fermi points. Due to this enhanced symmetry, the Hamiltonian can be expressed in terms of left and right current operators, $J_L(x) = : \psi_L^\dagger(x) \psi_L(x) :$ and $J_R(x) = : \psi_R^\dagger(x) \psi_R(x) :$, and the bare two-body interaction can be replaced in the low-energy limit by the effective interaction

$$H_{int} = \int dx J_L(x) J_R(x) . \quad (1.22)$$

As the current operators obey a simple type of harmonic-oscillator algebra, the problem reduces to that of diagonalizing a Gaussian Hamiltonian.

In spatial dimension $D > 1$, Haldane pointed out that the $U(1)_L \otimes U(1)_R$ symmetry enlarges, in the case of a Landau Fermi liquid, to the infinite $U(1)_k^\infty$ symmetry[8]. Although the bare interacting fermion Hamiltonian has only global $U(1)$ symmetry reflecting global conservation of charge, the Landau semiclassical energy functional

$$\epsilon_{\mathbf{k}} = \epsilon_{\mathbf{k}}^0 + \sum_{\mathbf{k}'} f_{\mathbf{k}\mathbf{k}'} \delta n_{\mathbf{k}'} , \quad (1.23)$$

where $\delta n_{\mathbf{k}}$ is the quasiparticle occupancy and \mathbf{k} and \mathbf{k}' denote momenta on the Fermi surface, has the same $U(1)_k^\infty$ symmetry as the free system because the energy $\epsilon_{\mathbf{k}}$ depends only on the occupancies $n_{\mathbf{k}}$, each of which separately is invariant under the $U(1)_k^\infty$ transformation

equation 1.10. Haldane proposed that a fully quantum mechanical description of the interacting fermion system might be obtained by bosonization, at least in cases where there is a well defined Fermi surface. In this viewpoint the formation of the Fermi surface is a zero temperature quantum critical phenomenon, an idea anticipated by Anderson in his book *Basic Notions of Condensed Matter Physics*[24]. Of course the bare Hamiltonian does not exhibit the enlarged $U(1)_k^\infty$ symmetry; rather only the effective low-energy theory has this symmetry. Symmetry-breaking terms are irrelevant perturbations of the fixed point effective Hamiltonian. Indeed, for fermions with short-range interactions, this was shown explicitly in renormalization group (RG) calculations in a mathematical-physics style by Feldman and Trubowitz[25] and by Benfatto and Gallavotti[26]. Shankar's particularly clear exposition of the RG approach to interacting fermions is the one we draw upon most heavily in the following[27].

A pioneering attempt to generalize the bosonization approach to spatial dimension greater than one was made by Luther[28]. Luther studied free fermions in general dimension by bosonizing the fermion fields at each point on the Fermi surface. The central idea was that the spectrum of the free fermion Hamiltonian can be reproduced by the particle hole excited states in the radial direction in momentum space,

$$H_0 = v_F \sum_{\mathbf{k}} (|\mathbf{k}| - k_F) \psi_{\mathbf{k}}^{\dagger\alpha} \psi_{\mathbf{k}\alpha} , \quad (1.24)$$

and therefore it is possible to take the fermions to be one dimensional in each radial direction \mathbf{k} . In this construction, however, conservation of momentum makes it impossible for particle-hole pairs in different radial sectors to interact. This is where the subject remained until Haldane[8] showed that coupling between different points of the Fermi surface could be incorporated by adopting a different geometry: he coarse grained the degrees of freedom near the Fermi surface into patches of finite extent rather than along radial rays. The approach was developed as a calculational tool by the authors and their collaborators who emphasized the role of the current algebras[29, 30, 31, 32, 33]. Independently, Castro-Neto and Fradkin used a coherent-state formalism which emphasized fluctuations in the geometry of the Fermi surface to derive similar results[34, 35]. A program to include systematically corrections to the Gaussian bosonic fixed point has been initiated by Fröhlich, Götschmann, and Marchetti[36] and also by Kopietz and co-workers[37, 38]. One of the goals of this approach, which employs a Hubbard-Stratonovich transformation to replace the fermions with bosons, is to include non-linear terms in the fermion dispersion, as these terms are especially important in gauge theories of interacting fermions. See also work by Khveshchenko[39]. Some of these later developments are summarized in a review article by Metzner, Castellani and DiCastro[40] who discuss the close connection between multidimensional bosonization and the Ward identity approach[41, 42].

It has been demonstrated how the main results of Fermi liquid theory can be recovered within this multidimensional bosonization approach[8, 29, 30, 31, 32, 33, 34, 35, 37]. Furthermore, the stability of the Fermi liquid fixed point can be tested[30, 31]. More important, bosonization provides a non-perturbative approach to the study of non-Fermi liquid fixed points that arise for example in the study of single layer quantum Hall fluids at even-denominator fillings $\nu = 1/2, 1/4, \dots$, and which may possibly be relevant in the cuprate superconductors, as we discuss below in Section 10. In this instance, bosonization is a partic-

ularly appropriate tool, as within limitations described below it does not presuppose a Fermi liquid form for the quasiparticle propagator, and therefore non-trivial zero-temperature fixed points can be accessed.

The outline of the rest of our review is as follows. In Section 2 we introduce the essentials of multidimensional bosonization. In Section 3 we employ the renormalization group to examine the stability of the Fermi liquid fixed point. The thermodynamics of interacting fermions is examined in Section 4. Collective modes are exhibited easily in the bosonized picture, more easily perhaps than in the traditional fermion approach, and an illustrative calculation of the spectrum of the charge mode is presented in Section 5. The difficult problem of calculating the fermion propagator is addressed in Section 6. Two-particle properties such as the linear response to external density perturbations are examined in Section 7. Although bosonization is limited to a description of low energy phenomena, high momentum processes are contained accurately. In particular, we show that the Kohn anomaly at wavevector $|\mathbf{q}| \approx 2k_F$ is recovered within bosonization. In Section 8 we turn our attention to the non-Fermi liquid fixed points exemplified by composite fermion theories of the half-filled Landau level in the fractional quantum Hall effect. The gauge-invariant density response is calculated in Section 9. We discuss nested Fermi surfaces and their possible relevance to cuprate superconductivity in Section 10. Finally we conclude in Section 11 with some further thoughts about the usefulness of multidimensional bosonization.

2 Basics of Bosonization

In this section we formulate the problem of an interacting Fermi liquid using a bosonization scheme which is applicable in any spatial dimension. We start from the bare Hamiltonian of fermions interacting via two-body interactions. Initially, for simplicity, we consider a spherical Fermi surface. The bare Hamiltonian is given by

$$H = \int d^D x c^{\dagger\alpha}(\mathbf{x}) \left(\frac{-\nabla^2}{2m} \right) c_{\alpha}(\mathbf{x}) + \frac{1}{2} \int d^D x d^D y V(\mathbf{x} - \mathbf{y}) c^{\dagger\alpha}(\mathbf{x}) c^{\dagger\beta}(\mathbf{y}) c_{\beta}(\mathbf{y}) c_{\alpha}(\mathbf{x}) . \quad (2.1)$$

First we make use of the renormalization group to integrate out the high-energy degrees of freedom[27]. The region of integration is depicted in figure 3. The result is a low energy effective Hamiltonian describing quasiparticles with an effective mass m^* interacting via two-body and higher-order interactions which, in general, include the long range Coulomb interaction as well as short range Fermi liquid interactions. Field operators $\psi_{\mathbf{k}}^{\dagger}$ and $\psi_{\mathbf{k}}$ create and destroy these quasiparticles and are related to the bare fermion operators by

$$\psi_{\mathbf{k}} = Z_{\mathbf{k}}^{-1/2} c_{\mathbf{k}} \quad (2.2)$$

for momenta \mathbf{k} which are restricted to a narrow shell of thickness λ around the Fermi surface $k_F - \lambda/2 < |\mathbf{k}| < k_F + \lambda/2$ depicted in figure 4. Note that an attempt is not being made to calculate the values of m^* , $Z_{\mathbf{k}}$, or the other effective parameters from first principles; there is no generally reliable way to do this. Rather we focus on the remaining low-energy degrees of freedom and the effective theories which control them.

As the next step, the Fermi surface is coarse grained by tiling it with squat boxes of height λ perpendicular to the Fermi surface and dimension Λ^{D-1} along the surface. The

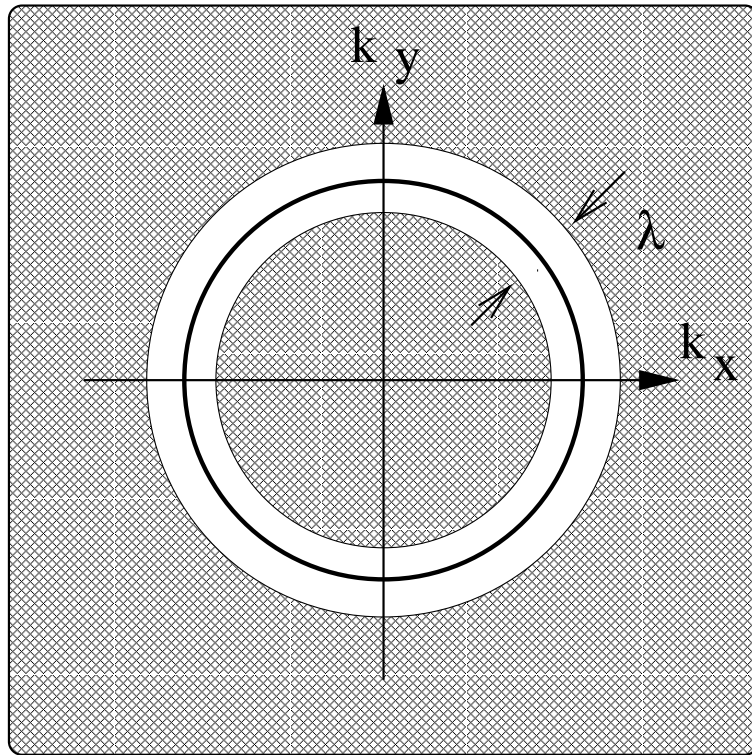

Figure 3: High-energy degrees of freedom, indicated by the hatched region, are integrated out yielding an effective theory for the remaining low-energy degrees of freedom near the Fermi surface (circle). These are to be bosonized.

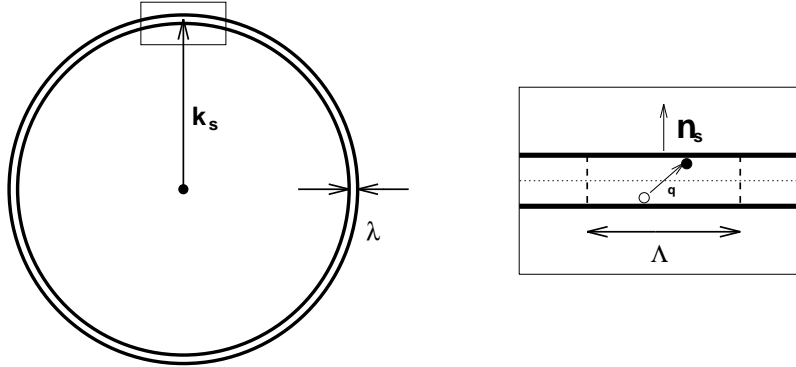

Figure 4: The narrow shell of thickness λ which contains the Fermi surface. The surface is tiled with squat boxes; the blowup shows one of the boxes at position \mathbf{S} which contains a particle-hole pair of momentum \mathbf{q} . We require $|\mathbf{q}| < \lambda \ll \Lambda \ll k_F$ for multidimensional bosonization to work (see text).

boxes are small and have a squat aspect ratio in the relevant limits $\lambda \ll \Lambda \ll k_F$ and $\Lambda^2/k_F \ll \lambda$. The reason for these limits, which are of crucial import, is discussed below. We introduce operators $\psi_\alpha(\mathbf{S}; \mathbf{x})$ and $\psi^{\dagger\alpha}(\mathbf{S}; \mathbf{x})$ which respectively annihilate and create fermion quasiparticles inside each patch

$$\psi_\alpha(\mathbf{S}; \mathbf{x}) = e^{i\mathbf{k}_S \cdot \mathbf{x}} \sum_{\mathbf{p}} \theta(\mathbf{S}; \mathbf{p}) e^{i(\mathbf{p} - \mathbf{k}_S) \cdot \mathbf{x}} \psi_{\mathbf{p}\alpha} , \quad (2.3)$$

where k_S is the Fermi momentum located at the center of the squat box labeled by the coordinate \mathbf{S} . Also, we introduce $\theta(\mathbf{S}; \mathbf{p})$ which equals one if \mathbf{p} lies inside the box and is zero otherwise. In terms of these operators the effective interaction is an instantaneous two-body interaction of the form

$$\psi^{\dagger\alpha}(\mathbf{S}; \mathbf{x}) \psi^{\dagger\beta}(\mathbf{T}; \mathbf{y}) \psi_\beta(\mathbf{U}, \mathbf{y}) \psi_\alpha(\mathbf{V}, \mathbf{x}) . \quad (2.4)$$

This is the only marginal interaction as all terms with more operators or derivatives are irrelevant in the usual renormalization group sense[27]; retardation may be neglected for the same reason. The bare Hamiltonian, equation 2.1, is rotationally invariant, and barring spontaneous magnetization we can restrict our attention to rotationally invariant effective interactions. The interaction is heavily constrained by momentum conservation which demands that

$$|\mathbf{k}_U + \mathbf{k}_V - \mathbf{k}_S - \mathbf{k}_T| < \lambda \ll \Lambda . \quad (2.5)$$

In two dimensions there are only three possibilities: $\mathbf{V} = \mathbf{S}$ and $\mathbf{U} = \mathbf{T}$ (forward scattering); $\mathbf{U} = \mathbf{S}, \mathbf{V} = \mathbf{T}$ (exchange scattering); and $\mathbf{S} = -\mathbf{T}, \mathbf{U} = -\mathbf{V}$ (BCS Cooper pair scattering, where the (-) sign connotes the antipodal point). The three scattering processes are depicted in figure 5 and the corresponding Feynman diagrams appear in figure 6. In three dimensions there is the additional complication of out-of-plane scattering[27]. For the sake of simplicity we ignore these azimuthal processes here.

It is clear that the interactions in the forward and exchange channels possess the large $U(1)_k^\infty$ symmetry: a $U(1)$ phase rotation of both spin species of fermions in each squat box

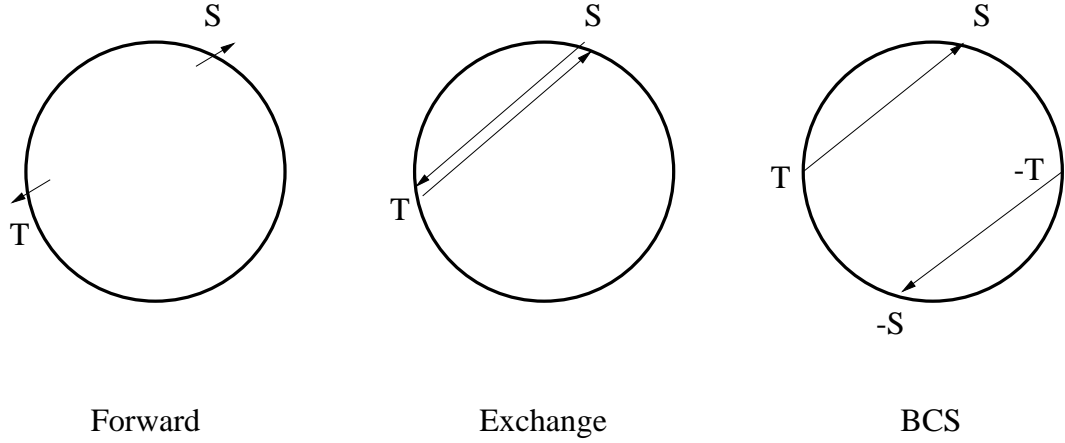

Figure 5: The three marginally relevant scattering channels in $D = 2$ which are confined to the narrow shell of width λ about the Fermi surface and which conserve momentum.

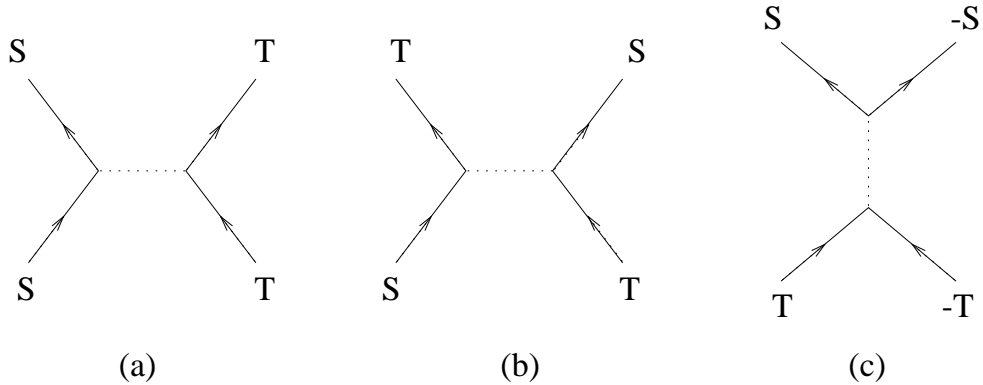

Figure 6: Feynman diagrams corresponding to the three marginally relevant scattering channels. The interactions between fermions (solid lines) are mediated by gauge fields (dotted line). (a) Forward scattering with amplitude $f_c(\mathbf{S}, \mathbf{T}) - \frac{1}{4} f_s(\mathbf{S}, \mathbf{T})$. (b) Exchange scattering with amplitude $\frac{1}{2} f_s(\mathbf{S}, \mathbf{T})$. (c) BCS Cooper pair scattering with amplitude $V_{BCS}(\mathbf{S} - \mathbf{T})$.

leaves the interaction in these two channels invariant as patches \mathbf{S} and \mathbf{T} each contain a creation and an annihilation operator. (There is no corresponding $SU(2)_k^\infty$ spin symmetry, as the exchange of spin between two separate patches on the Fermi surface breaks this symmetry.) The BCS interaction which couples quasiparticles in four separate patches breaks the $U(1)_k^\infty$ symmetry down to the ordinary global $U(1)$ symmetry which just reflects overall conservation of charge. We defer analysis of the BCS term until the next section, where it is shown to be marginally irrelevant or relevant depending on the sign of the coupling, and consider the remainder of the effective Hamiltonian:

$$\begin{aligned}
H[\psi^\dagger, \psi] &= \int d^D x \sum_{\mathbf{S}} \left\{ \psi^{\dagger\alpha}(\mathbf{S}; \mathbf{x}) \left(\frac{\mathbf{k}_{\mathbf{S}}}{m^*} \cdot \frac{\nabla}{i} \right) \psi_{\alpha}(\mathbf{S}; \mathbf{x}) \right\} \\
&+ \int d^D x d^D y \sum_{\mathbf{S}\mathbf{T}} \left\{ f_c(\mathbf{S}, \mathbf{T}; \mathbf{x} - \mathbf{y}) [\psi^{\dagger\alpha}(\mathbf{S}; \mathbf{x}) \psi_{\alpha}(\mathbf{S}; \mathbf{x})] [\psi^{\dagger\beta}(\mathbf{T}; \mathbf{y}) \psi_{\beta}(\mathbf{T}; \mathbf{y})] \right. \\
&+ \left. \frac{1}{4} f_s(\mathbf{S}, \mathbf{T}; \mathbf{x} - \mathbf{y}) [\psi^{\dagger\alpha}(\mathbf{S}; \mathbf{x}) \vec{\sigma}_{\alpha}^{\beta} \psi_{\beta}(\mathbf{S}; \mathbf{x})] \cdot [\psi^{\dagger\gamma}(\mathbf{T}; \mathbf{y}) \vec{\sigma}_{\gamma}^{\delta} \psi_{\delta}(\mathbf{T}; \mathbf{y})] \right\}. \quad (2.6)
\end{aligned}$$

The quasiparticle spectrum has been linearized about the Fermi surface, $\epsilon(\mathbf{k}) = v_F^*(|\mathbf{k}| - k_F)$, and the quasiparticle velocity defines the effective mass through the relation $v_F^* = k_F/m^*$. Functions $f_c(\mathbf{S}, \mathbf{T}; \mathbf{x} - \mathbf{y})$ and $f_s(\mathbf{S}, \mathbf{T}; \mathbf{x} - \mathbf{y})$ parameterize the effective interactions in the forward and exchange channels. Upon making use of the Pauli matrix identity

$$\vec{\sigma}_{\alpha}^{\beta} \cdot \vec{\sigma}_{\gamma}^{\delta} = 2\delta_{\gamma}^{\beta}\delta_{\alpha}^{\delta} - \delta_{\alpha}^{\beta}\delta_{\gamma}^{\delta} \quad (2.7)$$

it is straightforward to show that the forward scattering channel has amplitude $f_c - f_s/4$ while the exchange channel has amplitude $f_s/2$. Again no attempt is made here to calculate the short-range part of the parameters f_c and f_s as this is of comparable difficulty to a first-principles calculation of, say, the boiling point of water. Long-range density-density interactions such as the Coulomb repulsion, on the other hand, determine[43] the form of $f_c(\mathbf{S}, \mathbf{T}; \mathbf{x} - \mathbf{y})$ in the limit of large separation, $|\mathbf{x} - \mathbf{y}| \rightarrow \infty$. The remaining low-energy degrees of freedom within the shell are responsible for the screening of this long-range interaction, if screening occurs (see Section 6).

To bosonize the effective Hamiltonian, equation 2.6, we introduce the coarse grained currents

$$J_{\alpha}(\mathbf{S}; \mathbf{q}) = \sum_{\mathbf{k}} \theta(\mathbf{S}; \mathbf{k} - \mathbf{q}) \theta(\mathbf{S}; \mathbf{k}) \left\{ \psi_{\mathbf{k}-\mathbf{q}\alpha}^{\dagger} \psi_{\mathbf{k}\alpha} - \delta_{\mathbf{q},\mathbf{0}}^D n_{\mathbf{k}\alpha} \right\} \quad (2.8)$$

here $n_{\mathbf{k}\alpha} = \langle \psi_{\mathbf{k}\alpha}^{\dagger} \psi_{\mathbf{k}\alpha} \rangle$ and the spin index α is not summed over, so all of the spin indices appear as subscripts. The index \mathbf{S} labels a patch, with $\mathbf{S} \equiv (\theta, \phi)$ in three dimensions, on the Fermi surface at momentum $\mathbf{k}_{\mathbf{S}}$. Recall that $\theta(\mathbf{S}; \mathbf{k}) = 1$ if \mathbf{k} lies inside a squat box centered on \mathbf{S} with height λ in the radial (energy) direction and area Λ^{D-1} along the Fermi surface; $\theta(\mathbf{S}; \mathbf{k}) = 0$ otherwise. These two scales are made small in the sense that $k_F \gg \Lambda \gg \lambda > |\mathbf{q}|$ by setting $\lambda = k_F/N$, and $\Lambda = k_F/N^{\alpha}$ where $\alpha < 1$ and $N \rightarrow \infty$. We also require that $\alpha > 1/2$ as otherwise the circular Fermi surface curves out of the squat box in the $N \rightarrow \infty$ limit. The relationship between these currents and the usual *total* density operator $\rho(\mathbf{q})$ and total current operator $\mathbf{J}(\mathbf{q})$ familiar to condensed matter physicists is, for small- \mathbf{q} ,

$$\rho(\mathbf{q}) = \sum_{\mathbf{S}} \sum_{\alpha=\uparrow,\downarrow} J_{\alpha}(\mathbf{S}; \mathbf{q}) \quad (2.9)$$

and

$$\mathbf{J}(\mathbf{q}) = \sum_{\mathbf{S}} \sum_{\alpha=\uparrow,\downarrow} \mathbf{v}_F(\mathbf{S}) J_\alpha(\mathbf{S}; \mathbf{q}) \quad (2.10)$$

where $\mathbf{v}_F(\mathbf{S}) = \mathbf{k}_S/m^*$ is the fermion velocity at patch \mathbf{S} .

The coarse-grained current $J_\alpha(\mathbf{S}; -\mathbf{q})$ creates a particle-hole pair of relative momentum \mathbf{q} and spin α in patch \mathbf{S} of the Fermi surface. As discussed in the Introduction, we expect $J_\alpha(\mathbf{S}; \mathbf{q})$ to have a bosonic character. Indeed, the currents satisfy the $U(1)$ current algebra

$$[J_\alpha(\mathbf{S}; \mathbf{q}), J_\beta(\mathbf{T}; \mathbf{p})] = \delta_{\alpha,\beta} \delta_{\mathbf{S},\mathbf{T}}^{D-1} \delta_{\mathbf{q}+\mathbf{p},0}^D \Omega \hat{\mathbf{n}}_{\mathbf{S}} \cdot \mathbf{q}. \quad (2.11)$$

Here the quantity

$$\Omega \equiv \Lambda^{D-1} \left(\frac{L}{2\pi} \right)^D, \quad (2.12)$$

which equals the number of states in the squat box divided by the cutoff λ , appears for the first of many times. Also $\hat{\mathbf{n}}_{\mathbf{S}}$ is the unit normal to the Fermi surface at patch \mathbf{S} . This result can be made plausible by the following argument. First, the current operators $J_\alpha(\mathbf{S}; \mathbf{q})$ and $J_\beta(\mathbf{T}; \mathbf{p})$ clearly commute if $\alpha \neq \beta$. They also commute if $\mathbf{S} \neq \mathbf{T}$ as the creation and annihilation operators are in separate boxes. The right hand side of equation 2.11, if it is a c -number and not an operator, must be non-zero only when $\mathbf{q} = -\mathbf{p}$ as otherwise momentum is not conserved. As the anomaly must change sign upon interchanging the two current operators, it must contain odd powers of \mathbf{q} . Finally, as the current operators are scalars, a dot product of \mathbf{q} with some other vector must appear. The only other vector is $\hat{\mathbf{n}}_{\mathbf{S}}$.

The right hand side of equation 2.11 can be determined rigorously by direct computation on making use of the canonical anticommutation relations $\{\psi_{\mathbf{q}}^\dagger, \psi_{\mathbf{p}\beta}\} = \delta_{\beta}^{\alpha} \delta_{\mathbf{q},\mathbf{p}}^D$.

$$\begin{aligned} & [J_\alpha(\mathbf{S}; \mathbf{q}), J_\beta(\mathbf{T}; \mathbf{p})] \\ &= \delta_{\alpha,\beta} \delta_{\mathbf{S},\mathbf{T}}^{D-1} \left[\sum_{\mathbf{k}} \theta(\mathbf{S}; \mathbf{k} - \mathbf{q} - \mathbf{p}) \theta(\mathbf{S}; \mathbf{k}) [\theta(\mathbf{S}; \mathbf{k} - \mathbf{q}) - \theta(\mathbf{S}; \mathbf{k} - \mathbf{p})] \delta_{\mathbf{q}+\mathbf{p},0}^D n_{\mathbf{k}\alpha} \right. \\ & \quad \left. + \sum_{\mathbf{k}} \theta(\mathbf{S}; \mathbf{k} - \mathbf{q} - \mathbf{p}) \theta(\mathbf{S}; \mathbf{k}) [\theta(\mathbf{S}; \mathbf{k} - \mathbf{q}) - \theta(\mathbf{S}; \mathbf{k} - \mathbf{p})] \right. \\ & \quad \left. \times \left\{ \psi_{\mathbf{k}-\mathbf{p}-\mathbf{q}\alpha}^\dagger \psi_{\mathbf{k}\alpha} - \delta_{\mathbf{q}+\mathbf{p},0}^D n_{\mathbf{k}\alpha} \right\} \right] \\ &= \delta_{\alpha,\beta} \delta_{\mathbf{S},\mathbf{T}}^{D-1} \delta_{\mathbf{q}+\mathbf{p},0}^D \Omega \hat{\mathbf{n}}_{\mathbf{S}} \cdot \mathbf{q} + \text{Error}. \end{aligned} \quad (2.13)$$

The first term on the right hand side of equation 2.13, called the ‘‘quantum anomaly’’ or simply ‘‘anomaly,’’ is of order $\lambda \Lambda^{D-1} (L/2\pi)^D$. The second term, the error, can be bounded by replacing the operator with a c -number:

$$(\psi_{\mathbf{k}-\mathbf{q}-\mathbf{p}\alpha}^\dagger \psi_{\mathbf{k}\alpha} - \delta_{\mathbf{q}+\mathbf{p},0}^D n_{\mathbf{k}\alpha}) \rightarrow (1 - \delta_{\mathbf{q}+\mathbf{p},0}^D) \quad (2.14)$$

and computing the volume of the geometrical intersection of the two θ functions $[\theta(\mathbf{S}; \mathbf{k} - \mathbf{q}) - \theta(\mathbf{S}; \mathbf{k} - \mathbf{p})]$. Here a crucial assumption is introduced: the quasiparticle occupancy $n_{\mathbf{k}\alpha} = 1$ deep below the Fermi surface on the lower face of the squat box, $|\mathbf{k}| = k_F - \lambda/2$. Likewise, $n_{\mathbf{k}\alpha} = 0$ on the upper face. Hence, matrix elements of the error term vanish on the upper and lower faces of the squat box, and a simple computation then shows that

$$\text{Error} < \max\{|\mathbf{q}|, |\mathbf{p}|\} \times \lambda \Lambda^{D-2} (L/2\pi)^D < \lambda^2 \Lambda^{D-2} (L/2\pi)^D \quad (2.15)$$

where L is the length of one side of the system. The error therefore is negligible compared to the anomaly as long as the limit $\lambda/\Lambda \rightarrow 0$ (or equivalently $N \rightarrow \infty$), is chosen. This establishes the key $U(1)$ current algebra, equation 2.11. The calculation of the error term makes it clear why the squat aspect ratio is so important: Scattering of quasiparticles between adjacent boxes is minimized by the construction[29]. Unlike bosonization in one spatial dimension, which is accurate even when the cutoff λ is a sizable fraction of the Fermi momentum, in higher spatial dimensions bosonization is more delicate. Because the Fermi surface curves, we require $\Lambda \ll k_F$, and to minimize interpatch scattering we require $\lambda \ll \Lambda$; hence $\lambda \ll k_F$ and the quasiparticle occupancy must change from 1 to 0 over the small momentum range λ . This point has not received sufficient attention in the literature.

The charge currents also have an ‘‘Abelian’’ bosonic representation. If we set

$$J_\alpha(\mathbf{S}; \mathbf{x}) = \sqrt{4\pi} \hat{\mathbf{n}}_{\mathbf{S}} \cdot \nabla \phi_\alpha(\mathbf{S}; \mathbf{x}), \quad (2.16)$$

then we must demand that the bosonic fields $\phi_\alpha(\mathbf{S}; \mathbf{x})$ satisfy the commutation relations:

$$[\phi_\alpha(\mathbf{S}; \mathbf{x}), \phi_\beta(\mathbf{T}; \mathbf{y})] = \begin{cases} i \frac{\Omega^2}{4} \delta_{\alpha,\beta} \delta_{\mathbf{S},\mathbf{T}}^{D-1} \epsilon[\hat{\mathbf{n}}_{\mathbf{S}} \cdot (\mathbf{x} - \mathbf{y})]; & |\hat{\mathbf{n}}_{\mathbf{S}} \times (\mathbf{x} - \mathbf{y})| \Lambda \ll 1 \\ 0; & |\hat{\mathbf{n}}_{\mathbf{S}} \times (\mathbf{x} - \mathbf{y})| \Lambda \gg 1. \end{cases} \quad (2.17)$$

Here $\epsilon(x) = 1$ if $x > 0$ and -1 if $x < 0$. This can be accomplished by decomposing the boson fields into canonical boson annihilation and creation operators

$$\phi_\alpha(\mathbf{S}; \mathbf{x}) = i \sum_{\mathbf{q}, \hat{\mathbf{n}}_{\mathbf{S}} \cdot \mathbf{q} > 0} \frac{a_\alpha^\dagger(\mathbf{S}; -\mathbf{q}) e^{-i\mathbf{q} \cdot \mathbf{x}} - a_\alpha(\mathbf{S}; \mathbf{q}) e^{i\mathbf{q} \cdot \mathbf{x}}}{\sqrt{\hat{\mathbf{n}}_{\mathbf{S}} \cdot \mathbf{q}}} \quad (2.18)$$

where

$$[a_\alpha(\mathbf{S}; \mathbf{q}), a_\beta^\dagger(\mathbf{T}; \mathbf{p})] = \delta_{\mathbf{S},\mathbf{T}}^{D-1} \delta_{\mathbf{q},\mathbf{p}}^D \delta_{\alpha,\beta} \quad (2.19)$$

then

$$J_\alpha(\mathbf{S}; \mathbf{q}) = \sqrt{\Omega |\hat{\mathbf{n}}_{\mathbf{S}} \cdot \mathbf{q}|} [a_\alpha(\mathbf{S}; \mathbf{q}) \theta(\hat{\mathbf{n}}_{\mathbf{S}} \cdot \mathbf{q}) + a_\alpha^\dagger(\mathbf{S}; -\mathbf{q}) \theta(-\hat{\mathbf{n}}_{\mathbf{S}} \cdot \mathbf{q})] \quad (2.20)$$

and equation 2.11 follows immediately. We have thus replaced the fermion bilinear appearing in equation 2.8 with a single boson operator. The boson operator acts on the quiescent Fermi liquid to produce a single particle-hole pair, which as noted above and in the Introduction, has bosonic character.

We now introduce the key formula of the bosonization procedure which expresses the fermion quasiparticle field operator ψ as an exponential[44] of the boson fields:

$$\psi_\alpha(\mathbf{S}; \mathbf{x}) = \frac{1}{\sqrt{V}} \sqrt{\frac{\Omega}{a}} e^{i\mathbf{k}_{\mathbf{S}} \cdot \mathbf{x}} \exp \left\{ i \frac{\sqrt{4\pi}}{\Omega} \phi_\alpha(\mathbf{S}; \mathbf{x}) \right\} \hat{O}(\mathbf{S}). \quad (2.21)$$

Here V is the system volume, $a \equiv 1/\lambda$ is the ultraviolet cutoff, and $\hat{O}(\mathbf{S})$ is an ordering operator introduced to maintain Fermi statistics in the angular direction along the Fermi surface

$$\hat{O}(\mathbf{S}) \equiv \exp \left[i\pi \sum_{\mathbf{T}=1}^{\mathbf{S}-1} \sum_{\alpha=\uparrow,\downarrow} J_\alpha(\mathbf{T}; \mathbf{q} = \mathbf{0}) \right] \quad (2.22)$$

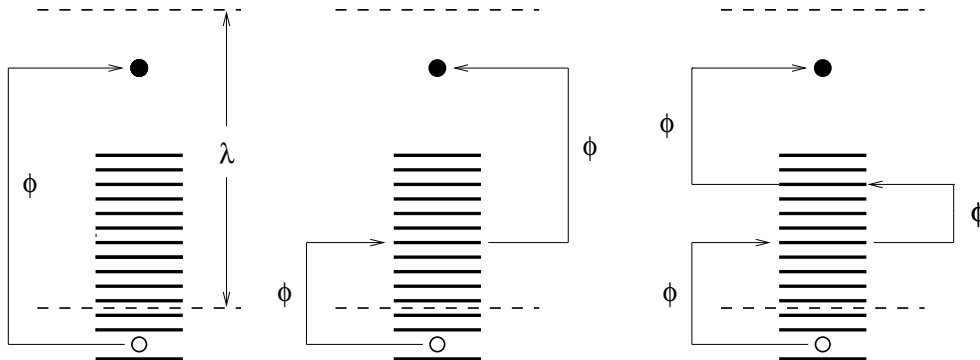

Figure 7: The Fermi quasi-particle ψ^\dagger formed by repeated action of the operator ϕ which produces particle-hole pairs. One hole is left behind beneath the cutoff, so there are an odd number of fermions within the low-energy region specified by the ultraviolet cutoff λ .

where the patch labels \mathbf{T} have been arranged consecutively. For example, the order can be chosen to start at point $\mathbf{T} = 1$ on the Fermi surface, spiral outward in a clockwise fashion, and finally converge at the corresponding antipode[28]. The operator $J_\alpha(\mathbf{S}; \mathbf{0})$ appearing in equation 2.22 simply counts the number of quasiparticles in box \mathbf{T} , so $\hat{O}(\mathbf{S})$ supplies the extra minus signs, much like the Jordan-Wigner transformation[45], which preserves anti-commuting statistics. In practice it is easy to identify these minus signs by hand and the explicit form of $\hat{O}(\mathbf{S})$ is not needed usually. Anticommutation rules are satisfied automatically in the direction perpendicular to the Fermi surface, as may be verified easily either by using the commutation relations, equation 2.17, or by examination of the fermion propagator (see Appendix C). How can the fermion operator ψ possibly be equated to the exponential of the bosonic operator ϕ ? To understand this remarkable relationship it is important to appreciate the crucial role played by the cutoff λ . As depicted in figure 7, we can think of ψ^\dagger as a sort of coherent state formed out of multiple particle-hole pairs[3]. A hole is left beneath the cutoff, and is therefore beyond the horizon of the low-energy degrees of freedom.

It is important to test for closure using this bosonized representation of the fermion fields. We seek to verify that

$$\begin{aligned}
 J_\alpha(\mathbf{S}; \mathbf{x}) &= V \lim_{\epsilon \rightarrow 0} \left\{ \psi_\alpha^\dagger(\mathbf{S}; \mathbf{x} + \epsilon \hat{\mathbf{n}}_{\mathbf{S}}) \psi_\alpha(\mathbf{S}; \mathbf{x}) - \langle \psi_\alpha^\dagger(\mathbf{S}; \mathbf{x} + \epsilon \hat{\mathbf{n}}_{\mathbf{S}}) \psi_\alpha(\mathbf{S}; \mathbf{x}) \rangle \right\} \\
 &= \sqrt{4\pi} \hat{\mathbf{n}}_{\mathbf{S}} \cdot \nabla \phi_\alpha(\mathbf{S}; \mathbf{x}) .
 \end{aligned} \tag{2.23}$$

Here, in the first line, the current operator has been normal-ordered by point-splitting. That is, the expectation value of the fermion bilinear with fields at slightly different positions \mathbf{x} and $\mathbf{x} + \epsilon \hat{\mathbf{n}}_{\mathbf{S}}$ has been subtracted, to accord with the definition in momentum space, equation

2.8. To obtain the second line, first use the bosonization formula, equation 2.21, to write

$$\psi_\alpha^\dagger(\mathbf{S}; \mathbf{x} + \epsilon \hat{\mathbf{n}}_{\mathbf{S}}) \psi_\alpha(\mathbf{S}; \mathbf{x}) = \frac{1}{V} \frac{\Omega}{a} \exp \left[-i \frac{\sqrt{4\pi}}{\Omega} \phi_\alpha(\mathbf{S}; \mathbf{x} + \epsilon \hat{\mathbf{n}}_{\mathbf{S}}) \right] \times \exp \left[i \frac{\sqrt{4\pi}}{\Omega} \phi_\alpha(\mathbf{S}; \mathbf{x}) \right]. \quad (2.24)$$

Then apply the following useful operator identity[46]:

$$e^A e^B = : e^{A+B} : e^{\langle AB + \frac{A^2+B^2}{2} \rangle} \quad (2.25)$$

which holds if A and B are linear combinations of simple harmonic oscillator creation and annihilation operators. Here the notation $: A :$ indicates normal ordering, with all annihilation operators on the right, and all creation operators on the left. This useful relationship, which we use frequently, can be derived using the more familiar Baker-Hausdorff relation:

$$e^{A+B} = e^A e^B e^{-\frac{1}{2}[A,B]} = e^B e^A e^{\frac{1}{2}[A,B]}. \quad (2.26)$$

Now we can write

$$\begin{aligned} \psi_\alpha^\dagger(\mathbf{S}; \mathbf{x} + \epsilon \hat{\mathbf{n}}_{\mathbf{S}}) \psi_\alpha(\mathbf{S}; \mathbf{x}) &= \frac{\Omega}{Va} \lim_{\epsilon \rightarrow 0} : \exp -i \frac{\sqrt{4\pi}}{\Omega} [\phi_\alpha(\mathbf{S}; \mathbf{x} + \epsilon \hat{\mathbf{n}}_{\mathbf{S}}) - \phi(\mathbf{S}; \mathbf{x})] : \\ &\times \exp \frac{4\pi}{\Omega^2} \langle \phi_\alpha(\mathbf{S}; \mathbf{x} + \epsilon \hat{\mathbf{n}}_{\mathbf{S}}) \phi_\alpha(\mathbf{S}; \mathbf{x}) - \phi_\alpha^2(\mathbf{S}; \mathbf{x}) \rangle. \end{aligned} \quad (2.27)$$

The equal-time correlation function of the ϕ fields, derived in Appendix A, is given by

$$G_\phi(\mathbf{S}; \mathbf{x}) = \langle \phi_\alpha(\mathbf{S}; \mathbf{x}) \phi_\alpha(\mathbf{S}; \mathbf{0}) - \phi_\alpha^2(\mathbf{S}; \mathbf{0}) \rangle = \begin{cases} \frac{\Omega^2}{4\pi} \ln \frac{ia}{\hat{\mathbf{n}}_{\mathbf{S}} \cdot \mathbf{x} + ia}; & |\hat{\mathbf{n}}_{\mathbf{S}} \times \mathbf{x}| \Lambda \ll 1 \\ -\infty; & |\hat{\mathbf{n}}_{\mathbf{S}} \times \mathbf{x}| \Lambda \gg 1 \end{cases} \quad (2.28)$$

Inserting this result into equation 2.27 yields:

$$\psi_\alpha^\dagger(\mathbf{S}; \mathbf{x} + \epsilon \hat{\mathbf{n}}_{\mathbf{S}}) \psi_\alpha(\mathbf{S}; \mathbf{x}) = \frac{\Omega}{Va} : [1 - i\epsilon \frac{\sqrt{4\pi}}{\Omega} \hat{\mathbf{n}}_{\mathbf{S}} \cdot \nabla \phi_\alpha(\mathbf{S}; \mathbf{x}) + O(\epsilon^2)] : \left(\frac{ia}{\epsilon + ia} \right). \quad (2.29)$$

The first, constant, term in this expansion about $\epsilon = 0$ is subtracted off in the point-splitting convention of equation 2.23 and the continuum limit may be taken. The correct order of limits is $\lim_{\epsilon \rightarrow 0} \lim_{a \rightarrow 0}$ because the separation between the fields ϵ must always be much greater than the ultraviolet lattice cutoff a . As required by consistency $J_\alpha(\mathbf{S}; \mathbf{x}) = \sqrt{4\pi} \hat{\mathbf{n}}_{\mathbf{S}} \cdot \nabla \phi_\alpha(\mathbf{S}; \mathbf{x})$. Similarly, by careful use of point-splitting it can be shown that the free part of the Hamiltonian is quadratic in the currents,

$$\begin{aligned} H_0 &= v_F^* \sum_{\mathbf{S}} \int d^D x \psi^{\dagger\alpha}(\mathbf{S}; \mathbf{x}) \left(\hat{\mathbf{n}}_{\mathbf{S}} \cdot \frac{\nabla}{i} \right) \psi_\alpha(\mathbf{S}; \mathbf{x}) \\ &= \frac{v_F^*}{2\Omega V} \sum_{\mathbf{S}; \alpha} \int d^D x [J_\alpha(\mathbf{S}; \mathbf{x})]^2 \\ &= \frac{2\pi v_F^*}{\Omega V} \sum_{\mathbf{S}; \alpha} \int d^D x [\hat{\mathbf{n}}_{\mathbf{S}} \cdot \nabla \phi_\alpha(\mathbf{S}; \mathbf{x})]^2 \end{aligned} \quad (2.30)$$

quadratic because it has been assumed that the spectrum can be linearized near the Fermi surface. Non-linear corrections to the dispersion, when significant, lead to cubic and higher order terms in the boson fields which can only be treated perturbatively[17]. As a final check on the bosonization formula we compute the equal-time free fermion Green's function by again making use of equation 2.21.

$$\begin{aligned}
G_{F\alpha}^0(\mathbf{S}; \mathbf{x}) = \langle \psi_\alpha(\mathbf{S}; \mathbf{x}) \psi_\alpha^\dagger(\mathbf{T}; \mathbf{0}) \rangle &= \frac{\Omega}{Va} \delta_{\mathbf{S}, \mathbf{T}}^{D-1} e^{i\mathbf{k}_\mathbf{S} \cdot \mathbf{x}} \exp \left[\frac{4\pi}{\Omega^2} G_\phi(\mathbf{S}; \mathbf{x}) \right] \\
&= \begin{cases} i \frac{\Lambda^{D-1}}{(2\pi)^D} \frac{e^{i\mathbf{k}_\mathbf{S} \cdot \mathbf{x}}}{\mathbf{x} \cdot \hat{\mathbf{n}}_\mathbf{S} + ia}; & |\hat{\mathbf{n}}_\mathbf{S} \times \mathbf{x}| \Lambda \ll 1 \\ 0; & \text{otherwise} \end{cases} \quad (2.31)
\end{aligned}$$

as expected. The low-energy fermion quasiparticle is related to the patch fermions by a sum over the patches

$$\psi_\alpha(\mathbf{x}) = \sum_{\mathbf{S}} \psi_\alpha(\mathbf{S}; \mathbf{x}) , \quad (2.32)$$

so the usual Green's function $G_F(\mathbf{x})$ can be obtained by summing over the patches,

$$G_F(\mathbf{x}) = \sum'_{\mathbf{S}} G_F(\mathbf{S}; \mathbf{x}), \quad (2.33)$$

where the prime indicates that the sum is only over patches for which $|\mathbf{x} \times \hat{\mathbf{n}}_\mathbf{S}| \Lambda < 1$. Physically this means that fermions in each patch, $\psi(\mathbf{S}; \mathbf{x})$, propagate along nearly straight rays, reminiscent of semiclassical ballistic trajectories.

The $U(1)_k^\infty$ transformation rotates the phase of the fermions by a different amount $\theta_{\mathbf{S}\alpha}$ in each patch:

$$\psi_\alpha(\mathbf{S}; \mathbf{x}) \rightarrow e^{i\theta_{\mathbf{S}\alpha}} \psi_\alpha(\mathbf{S}; \mathbf{x}) . \quad (2.34)$$

The transformation leaves the current operators $J_\alpha(\mathbf{S}; \mathbf{x})$ invariant, as the phase factors $\pm\theta_{\mathbf{S}\alpha}$ cancel out in the first line of equation 2.23. Therefore Hamiltonians or actions which can be expressed solely in terms of the patch currents possess the large $U(1)_k^\infty$ symmetry. In terms of the boson fields, the $U(1)_k^\infty$ transformations amount to a translation of the fields by a constant:

$$\phi_\alpha(\mathbf{S}; \mathbf{x}) \rightarrow \phi_\alpha(\mathbf{S}; \mathbf{x}) + \frac{\Omega}{\sqrt{4\pi}} \theta_{\mathbf{S}\alpha} . \quad (2.35)$$

Any Hamiltonian or action which conserves total charge is invariant under the global $U(1)$ symmetry $\theta_{\mathbf{S}\alpha} = \theta$. The BCS channel breaks the $U(1)_k^\infty$ symmetry down to this global symmetry, as the phases in the four separate patches $(\mathbf{S}, -\mathbf{S})$ and $(\mathbf{T}, -\mathbf{T})$ do not cancel out in general. The exchange channel, on the other hand, possesses a restricted $U(1)_k^\infty$ symmetry: both spin species must rotate through the same angle, $\theta_{\mathbf{S}\alpha} = \theta_\mathbf{S}$. The restriction reflects the fact that while the exchange channel transports spin between two different patches of the Fermi surface, the total number of quasiparticles in each patch remains unchanged. Effective actions with only forward scattering possess the full $U(1)_k^\infty$ symmetry, however, and these are particularly amenable to bosonization, as shown below.

Having shown how fermion quasiparticles are bosonized in each patch, we can now bosonize the effective Hamiltonian, equation 2.6. If we choose \hat{z} as the spin quantization

axis, introduce charge and spin currents

$$\begin{aligned} J_c(\mathbf{S}; \mathbf{x}) &= J_\uparrow(\mathbf{S}; \mathbf{x}) + J_\downarrow(\mathbf{S}; \mathbf{x}) \\ J_s(\mathbf{S}; \mathbf{x}) &= J_\uparrow(\mathbf{S}; \mathbf{x}) - J_\downarrow(\mathbf{S}; \mathbf{x}) \end{aligned} \quad (2.36)$$

and the corresponding charge and spin bosons

$$\begin{aligned} \phi_c(\mathbf{S}; \mathbf{x}) &= \phi_\uparrow(\mathbf{S}; \mathbf{x}) + \phi_\downarrow(\mathbf{S}; \mathbf{x}) \\ \phi_s(\mathbf{S}; \mathbf{x}) &= \phi_\uparrow(\mathbf{S}; \mathbf{x}) - \phi_\downarrow(\mathbf{S}; \mathbf{x}) \end{aligned} \quad (2.37)$$

the effective Hamiltonian can be written in terms of the currents as

$$\begin{aligned} H[\psi^\dagger, \psi] &= \int d^D x \sum_{\mathbf{S}} \frac{v_F^*}{4\Omega} [J_c^2(\mathbf{S}; \mathbf{x}) + J_s^2(\mathbf{S}; \mathbf{x})] \\ &+ \int d^D x d^D y \sum_{\mathbf{S}, \mathbf{T}} \left\{ \frac{f_c(\mathbf{S}, \mathbf{T}; \mathbf{x} - \mathbf{y})}{V^2} J_c(\mathbf{S}; \mathbf{x}) J_c(\mathbf{T}; \mathbf{y}) + \frac{f_s(\mathbf{S}, \mathbf{T}; \mathbf{x} - \mathbf{y})}{V^2} J_s(\mathbf{S}; \mathbf{x}) J_s(\mathbf{T}; \mathbf{y}) \right. \\ &+ \left. f_s(\mathbf{S}, \mathbf{T}; \mathbf{x} - \mathbf{y}) [\psi_\uparrow^\dagger(\mathbf{S}; \mathbf{x}) \psi_\downarrow(\mathbf{S}; \mathbf{x}) \psi_\downarrow^\dagger(\mathbf{T}; \mathbf{y}) \psi_\uparrow(\mathbf{T}; \mathbf{y}) + \uparrow \leftrightarrow \downarrow] \right\} \end{aligned} \quad (2.38)$$

In terms of the ϕ fields it becomes

$$\begin{aligned} H[\phi_c, \phi_s] &= \int d^D x \sum_{\mathbf{S}} \frac{\pi v_F^*}{\Omega} \left\{ [\hat{\mathbf{n}}_{\mathbf{S}} \cdot \nabla \phi_c(\mathbf{S}; \mathbf{x})]^2 + [\hat{\mathbf{n}}_{\mathbf{S}} \cdot \nabla \phi_s(\mathbf{S}; \mathbf{x})]^2 \right\} \\ &+ \frac{1}{V^2} \int d^D x d^D y \sum_{\mathbf{S}, \mathbf{T}} \left\{ 4\pi f_c(\mathbf{S}, \mathbf{T}; \mathbf{x} - \mathbf{y}) [\hat{\mathbf{n}}_{\mathbf{S}} \cdot \nabla \phi_c(\mathbf{S}; \mathbf{x})] [\hat{\mathbf{n}}_{\mathbf{T}} \cdot \nabla \phi_c(\mathbf{T}; \mathbf{y})] \right. \\ &+ 4\pi f_s(\mathbf{S}, \mathbf{T}; \mathbf{x} - \mathbf{y}) \left([(\hat{\mathbf{n}}_{\mathbf{S}} \cdot \nabla \phi_s(\mathbf{S}; \mathbf{x}))] [\hat{\mathbf{n}}_{\mathbf{T}} \cdot \nabla \phi_s(\mathbf{T}; \mathbf{y})] \right. \\ &+ \left. \left. 2 \left(\frac{\Omega}{a} \right)^2 \cos \frac{\sqrt{4\pi}}{\Omega} [\phi_s(\mathbf{S}; \mathbf{x}) - \phi_s(\mathbf{T}; \mathbf{y})] \right) \right\} \end{aligned} \quad (2.39)$$

Although the spin and charge degrees of freedom separate in the Hamiltonian, equation 2.39, it does not follow necessarily that the spin and charge excitations propagate at different velocities.

It is remarkable that the charge part of the Hamiltonian is completely bilinear in the currents, or equivalently, the ϕ_c fields, and therefore it is invariant under the full $U(1)_k^\infty$ symmetry and can be diagonalized exactly. In this instance the multidimensional bosonization scheme has transformed the four point fermion interaction into a problem of Gaussian bosons. Diagonalization is non-trivial, but as we show in subsequent sections, we can calculate the multi-point correlation functions exactly. The spin sector of the Hamiltonian is more complicated since the last, x-y, term in equation 2.39, the coupling between the x-components and the y-components of the spin current, is a nonlinear cosine function of the spin boson fields. Consequently it breaks the $U(1)_k^\infty$ symmetry and the equations of motion are nonlinear. Nevertheless the low-energy behavior of the theory can be analyzed by the RG method we discuss in the next section.

3 Stability of Fermi Liquids

In this section we examine the stability of the Fermi liquid fixed point against BCS pairing in a weak-coupling RG calculation. It is well known that an attractive interaction leads to a superconducting instability, and here we show how this occurs in the bosonic representation. In contrast to mean-field theories, bosonization when combined with the renormalization group provides an unbiased means for analyzing instabilities, as it treats all of the interaction channels on an equal footing.

For simplicity we consider the case of spinless fermions in two dimensions as the extension to three dimensions is straightforward. Consider also a circular Fermi surface to eliminate the possibility of nesting which could lead to charge or spin density wave instabilities in the forward and exchange channels. These possibilities are discussed later in Section 10. To further simplify the problem, initially we turn off the interactions in the forward and exchange channels, as we shall see that these channels do not alter the renormalization of the BCS channel at leading order, at least for the case of the circular Fermi surface.

In the BCS channel a fermion in patch \mathbf{S} on the Fermi surface is paired with the fermion in patch, $-\mathbf{S}$, directly opposite, see figure 5. In cylindrical coordinates patches \mathbf{S} and $-\mathbf{S}$ correspond to θ and $\theta + \pi$. To carry out the RG calculation we use the path integral framework, as we wish to rescale both space and (imaginary) time. The BCS action expressed in terms of the four Fermi fields is:

$$S_{int}[\psi^*, \psi] = \int d\tau \int d^2x \sum_{\mathbf{S}, \mathbf{T}} \frac{V_{BCS}(\mathbf{S} - \mathbf{T})}{N^*(0)} \psi^*(-\mathbf{T}; x) \psi^*(\mathbf{T}; x) \psi(\mathbf{S}; x) \psi(-\mathbf{S}; x) \quad (3.1)$$

here $N^*(0) = m^*/(2\pi)$ is the density of states at the Fermi energy and \mathbf{S} and \mathbf{T} are restricted to range over only half of the Fermi surface. As the fermions are spinless V_{BCS} must change sign under inversion so $V_{BCS}(\theta) = -V_{BCS}(\theta + \pi)$. Also the Hamiltonian is Hermitian and therefore $V_{BCS}(\mathbf{S} - \mathbf{T}) = V_{BCS}(\mathbf{T} - \mathbf{S})$. The interaction can be written in bosonic representation using the bosonization formula, equation 2.21. In doing so it is important to keep track of the order of the fermion operators. Formally the correct sign is set by the ordering operator $\hat{O}(\mathbf{S})$ but as noted in Section 2 in practice it is easier to determine the sign by inspection of the fermion operators. With these remarks in mind the action is written as

$$S_{int}[\phi] = \left[\frac{\Lambda\lambda}{(2\pi)^2} \right]^2 \sum_{\mathbf{S}, \mathbf{T}} \int d\tau \int d^2x \frac{V_{BCS}(\mathbf{S} - \mathbf{T})}{N^*(0)} \exp \left[i \frac{\sqrt{4\pi}}{\Omega} [\phi_{\mathbf{S}}(x) - \phi_{\mathbf{T}}(x)] \right] \quad (3.2)$$

where we have introduced the combination $\phi_{\mathbf{S}}(x) \equiv \phi(\mathbf{S}; x) + \phi(-\mathbf{S}; x)$ and have defined the usual 2 + 1 dimensional space-time coordinate $x \equiv (\mathbf{x}, \tau)$.

Because an exponential of the boson field appears in the action, equation 3.2, it is most convenient to implement the RG transformation in real space. The RG transformation rescales only the component of length parallel to the Fermi surface normal, $x_{\parallel} \equiv \hat{\mathbf{n}}_{\mathbf{S}} \cdot \mathbf{x}$. The perpendicular component, $x_{\perp} \equiv \hat{\mathbf{n}}_{\mathbf{S}} \times \mathbf{x}$, remains invariant so that the real space volume element $d^2x = dx_{\parallel} dx_{\perp}$ becomes $(sdx_{\parallel}) dx_{\perp}$ and $d\tau \rightarrow sd\tau$. The quadratic part of the action is invariant under this transformation provided that the boson field is invariant, $\phi \rightarrow \phi$. Then it follows that the BCS interaction is marginal as expected. The usual renormalization

group procedure is to integrate out the fast parts of the fields $\phi(\mathbf{S}; \mathbf{x})$. Here “fast” means high-energy. To be precise modes with momenta

$$\frac{\lambda}{2s} < |\hat{\mathbf{n}}_{\mathbf{S}} \cdot \mathbf{q}| < \frac{\lambda}{2} \quad (3.3)$$

are eliminated which in real space translates into integrating out the short distance pieces of the fields with $2a < |\hat{\mathbf{n}}_{\mathbf{S}} \cdot \mathbf{x}| < 2sa$, where we recall that $a \equiv \lambda^{-1}$ is the ultraviolet cutoff. To complete the transformation $x_{\parallel} \rightarrow sx_{\parallel}$, and $\tau \rightarrow s\tau$. Integration over the fast modes is accomplished as usual within the functional integral

$$e^{-S[\phi(\mathbf{S}; x)]} = \prod_{\mathbf{T}} \int_{2a < |\hat{\mathbf{n}}_{\mathbf{T}} \cdot \mathbf{x}| < 2as} D\phi(\mathbf{T}; x) e^{-S_0[\phi] - S_{int}[\phi]} \quad (3.4)$$

As only the fast parts of the fields are integrated out it is convenient to split the ϕ fields into slow ϕ' and fast h fields by writing $\phi = \phi' + h$. Then we can write the right hand side of equation 3.4 as $\exp(-S_0[\phi]) \times \langle \exp(-S_{int}[\phi' + h]) \rangle$ where $\langle \rangle$ means an average over the fast $h(\mathbf{T}; x)$ fields only. The renormalized interaction is found perturbatively by expanding in powers of V_{BCS} and at leading order

$$\begin{aligned} \langle S_{int}[\phi'] \rangle &= \left[\frac{\Lambda\lambda}{2\pi} \right]^2 \sum_{\mathbf{S}, \mathbf{T}} \int d\tau \int d^2x \frac{V_{BCS}(\mathbf{S} - \mathbf{T})}{N^*(0)} \exp \left\{ i \frac{\sqrt{4\pi}}{\Omega} [\phi'_{\mathbf{S}}(x) - \phi'_{\mathbf{T}}(x)] \right\} \\ &\times \left\langle \exp i \frac{\sqrt{4\pi}}{\Omega} [h_{\mathbf{S}}(x) - h_{\mathbf{T}}(x)] \right\rangle \end{aligned} \quad (3.5)$$

To evaluate the restricted average $\langle \rangle$ we make use of the propagator of the h fields (the derivation of the propagator is given in Appendix B):

$$\langle h(\mathbf{S}; x) h(\mathbf{S}; 0) \rangle = \begin{cases} \frac{\Omega^2}{4\pi} \ln \left[\frac{x_{\parallel} + iv_F^* \tau + (2isa) \text{sgn}(\tau)}{x_{\parallel} + iv_F^* \tau + (2ia) \text{sgn}(\tau)} \right], & \Lambda |x_{\perp}| \ll 1 \\ 0; & \text{otherwise.} \end{cases} \quad (3.6)$$

In particular

$$\langle h^2(\mathbf{S}; 0) \rangle = \frac{\Omega^2}{4\pi} \ln(s) . \quad (3.7)$$

Now use the fact that, for a Gaussian measure,

$$\langle e^{ih} \rangle = e^{-\frac{1}{2} \langle h^2 \rangle} \quad (3.8)$$

and equation 3.5 becomes

$$\langle S_{int}[\phi'] \rangle = \left[\frac{\Lambda\lambda/s}{2\pi} \right]^2 \sum_{\mathbf{S}, \mathbf{T}} \int_{-\infty}^{\infty} d\tau \int' d^2x \frac{V_{BCS}(\mathbf{S} - \mathbf{T})}{N^*(0)} \exp \left\{ \frac{i\sqrt{4\pi}}{\Omega} [\phi'_{\mathbf{S}}(\mathbf{x}) - \phi'_{\mathbf{T}}(\mathbf{x})] \right\}, \quad (3.9)$$

where the prime on the integral indicates that the region of spatial integration covers only small distances. Then, upon rescaling space and time, we recover $S_{int}[\phi]$.

The first nontrivial contribution to the renormalized interaction is at second order in the expansion in powers of the BCS interaction, V_{BCS} . This term is evaluated by making use of the variant of the Baker-Hausdorff formula, equation 2.25, and the propagator of the h fields:

$$\begin{aligned} \langle S_{int}^2[\phi'] \rangle &= \left[\frac{\Lambda\lambda}{(2\pi)^2 s} \right]^4 \sum_{\mathbf{S}, \mathbf{T}} \int d\tau \int d^2x \frac{V_{BCS}(\mathbf{S} - \mathbf{U}) V_{BCS}(\mathbf{U} - \mathbf{T})}{[N^*(0)]^2} \exp \left\{ i \frac{\sqrt{4\pi}}{\Omega} [\phi'_{\mathbf{S}}(x) - \phi'_{\mathbf{T}}(x)] \right\} \\ &\times \frac{1}{\Lambda} \int_{-\infty}^{\infty} d\sigma \int_{2a}^{2as} dy_{\parallel} \frac{[v_F^* \sigma + 2as \operatorname{sgn}(\sigma)]^2 + y_{\parallel}^2}{[v_F^* \sigma + 2a \operatorname{sgn}(\sigma)]^2 + y_{\parallel}^2} \end{aligned} \quad (3.10)$$

where $y_{\parallel} \equiv \hat{\mathbf{n}}_{\mathbf{U}} \cdot \mathbf{y}$ is the spatial integration variable and the factor of $1/\Lambda$ in the second line is the result of integrating over the perpendicular coordinate, y_{\perp} . As $s \rightarrow \infty$ the highest power of s (in this case $\ln(s)$) gives the leading contribution to the renormalization. The time integral over σ may be evaluated by contour integration. The structure is such that of the two poles, one lies in the upper half plane and one in the lower, which is a direct result of the coupling in the BCS channel between patches \mathbf{U} and $-\mathbf{U}$. The remaining spatial integral is proportional to $\ln(s)$ and we find that the flow of the coupling function in the BCS channel is given by:

$$\frac{dV_{BCS}(\mathbf{S} - \mathbf{T})}{d \ln(s)} = -\frac{\Lambda}{(2\pi)^2 k_F} \sum_{\mathbf{U}} V_{BCS}(\mathbf{S} - \mathbf{U}) V_{BCS}(\mathbf{U} - \mathbf{T}) . \quad (3.11)$$

For the circular Fermi surface considered here

$$\Lambda \sum_{\mathbf{U}} = \frac{k_F}{2} \int_0^{2\pi} d\theta \quad (3.12)$$

and the flow equation can be diagonalized by a Fourier decomposition of the BCS interaction into angular momentum channels:

$$V_{\ell} \equiv \int_0^{2\pi} \frac{d\theta}{2\pi} e^{i\ell\theta} V_{BCS}(\theta) . \quad (3.13)$$

The flow equations decouple channel by channel, and are simplified further as V_{ℓ} is dimensionless:

$$\frac{dV_{\ell}}{d \ln(s)} = -\frac{V_{\ell}^2}{4\pi} . \quad (3.14)$$

This result, which is identical to that derived by Shankar in the fermion basis[27], tells us that the couplings V_{ℓ} , which are marginal at tree level, are in fact marginally relevant if negative, and marginally irrelevant if positive. The first case leads to the BCS instability, in the second case the Fermi liquid fixed point is stable, as indicated by figure 8.

We should ask now, what would happen were we to include at the outset the other marginal interactions, for example the coupling between the charge-currents:

$$S_{FL} = \frac{1}{V^2} \sum_{\mathbf{S}, \mathbf{T}} \int d\tau \int d^2x \int d^2y f_c(\mathbf{S}, \mathbf{T}; \mathbf{x} - \mathbf{y}) J_c(\mathbf{S}; \mathbf{x}, \tau) J_c(\mathbf{T}; \mathbf{y}, \tau) . \quad (3.15)$$

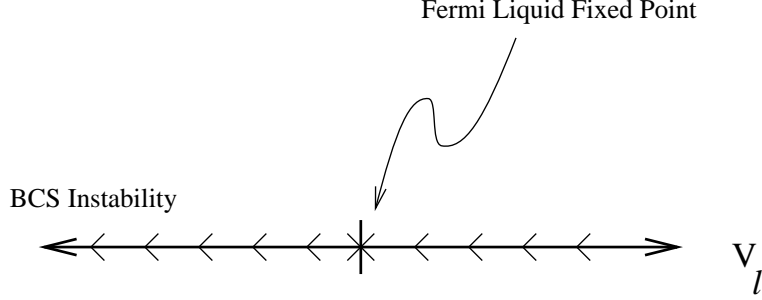

Figure 8: RG flows decouple, channel by channel. The Fermi liquid fixed point is at $V_\ell = 0$.

Since the interactions are quadratic in the boson fields, they parameterize infinitely many different Gaussian fixed points which do not flow under the RG transformations. Incorporated into the RG calculation they contribute only subleading corrections to scaling and do not influence the leading RG flows of the BCS interaction. For example, although bosons in different patches are correlated via the interaction, this correlation is only a fraction, Λ/k_F , of the correlations within the same patch, as we prove below in Section 6. The leading RG flows, equation 3.14, are unchanged.

It is not difficult to see that the system develops an energy gap if the BCS interaction is attractive in any channel. The RG flows in attractive channels scale to large negative values as $s \rightarrow \infty$, and the size of the gap may be estimated by calculating the length scale at which the renormalized coupling becomes of order one. Alternatively, a mean-field approximation shows how the gap develops. Suppose for simplicity that $V_{BCS}(\theta) = V_{\ell=1} \cos(\theta)$, conducive to p-wave ordering. As in the classic BCS calculation we may decouple the Cooper pairs via a Hubbard-Stratonovich transformation upon introducing a field $\Psi(\mathbf{S}) = \Delta(\mathbf{S})e^{i\Phi}$. Then the bosonized Hamiltonian for the pair $(\mathbf{S}, -\mathbf{S})$ is given by

$$\begin{aligned}
 H[\phi_{\mathbf{S}}] &= \int d^2x \left\{ \frac{2\pi v_F^*}{\Omega V} \left([(\hat{\mathbf{n}}_{\mathbf{S}} \cdot \nabla)\phi(\mathbf{S}; \mathbf{x})]^2 + [(\hat{\mathbf{n}}_{\mathbf{S}} \cdot \nabla)\phi(-\mathbf{S}; \mathbf{x})]^2 \right) \right. \\
 &\quad \left. - \frac{\Delta(\mathbf{S})\Lambda}{2\pi k_F a} \cos\left[\frac{\sqrt{4\pi}}{\Omega}(\phi_{\mathbf{S}}(x) - \Phi)\right] \right\}. \quad (3.16)
 \end{aligned}$$

At the mean field level, $\Delta(\mathbf{S}) e^{i\Phi}$ can be assumed to be constant with no fluctuations, and the problem is equivalent to a sine-Gordon model in each direction $\hat{\mathbf{n}}_{\mathbf{S}}$. The continuous $U(1)_k^\infty$ gauge symmetry of the action under translations of the boson field by an additive constant, $\phi_{\mathbf{S}} \rightarrow \phi_{\mathbf{S}} + \frac{\Omega}{\sqrt{4\pi}}(\theta_{\mathbf{S}} + \theta_{-\mathbf{S}})$, breaks spontaneously giving rise to the usual superconducting energy gap.

There is in fact the possibility of a BCS instability even when the interactions are repulsive: the Kohn-Luttinger effect[47]. This possibility only becomes apparent beyond leading order. The bare couplings, V_ℓ , due to a short-range repulsive interaction are all positive but tend rapidly to zero at large ℓ . Fermi liquid interactions as discussed above generate irrelevant contributions in the BCS channel down by a positive power of Λ/k_F , nevertheless this is sufficient to make some of the V_ℓ slightly negative, at least at sufficiently large ℓ , leading to an instability. Because of the small magnitude of these coefficients, the effect can only be important at extremely low temperatures and the essential physics is controlled by the

Fermi liquid fixed point. However, nesting instabilities can enlarge dramatically this effect, and we examine this situation in Section 10.

Finally, it might be thought that in general an instability must occur in the spin sector since the interaction is a cosine function of the spin boson. Indeed this does occur in one spatial dimension: the coupling between spin currents at the left and right Fermi points flows under the RG transformation[48, 49, 50, 46]. If this were to be the case in $D > 1$ it would spell disaster for the multidimensional bosonization approach to Landau Fermi liquids since the Landau parameters in the spin sector should be constants parameterizing the Landau fixed point. However, on closer inspection it is clear that the spin couplings are indeed fixed. Repeating the weak-coupling RG calculations to second order for the x-y part of the interaction in equation 2.39 gives

$$\begin{aligned} \frac{1}{2}\langle S_{xy}^2[\phi'_s] \rangle &= \lambda^2 \left(\frac{\Lambda}{(2\pi)^2} \right)^4 \int d\tau \int d^2x \sum_{\mathbf{S}, \mathbf{T}} \cos \frac{\sqrt{8\pi}}{\Omega} [\phi'_s(\mathbf{S}; x) - \phi'_s(\mathbf{T}; x)] \\ &\times \sum_{\mathbf{U}} f_s(\mathbf{S}, \mathbf{U}) f_s(\mathbf{U}, \mathbf{T}) \frac{1}{\Lambda} \int_{-\infty}^{\infty} d\sigma \int_{2a < |y_{\parallel}| < 2sa} dy_{\parallel} \frac{1}{(y_{\parallel} + iv_F^* \sigma)^2} \end{aligned} \quad (3.17)$$

In this case, unlike the case of the BCS interaction, the correction vanishes since the integral over (y_{\parallel}, σ) does not encompass a simple pole, and the spin interaction is strictly marginal, at least within this second-order perturbative calculation. A deeper, and non-perturbative, reason for the exact marginal nature of the spin current coupling in $D > 1$ is given below in Section 5.

4 Thermodynamics of Fermi Liquids

In this section we use the bosonization formalism to calculate the specific heat of the interacting Landau Fermi liquid in three dimensions. We show that a well-known nonanalyticity in the specific heat, a term proportional to $T^3 \ln T$, is reproduced by the method. The existence of such a term is consistent with careful measurements[51] of the specific heat of helium-3. It has also been seen in heavy fermion systems. For the sake of simplicity we turn off the spin-spin interaction and eliminate the spin index. Then the bosonic Hamiltonian of the interacting spinless fermion system is given by

$$H = \frac{1}{2} \sum_{\mathbf{S}, \mathbf{T}} \sum_{\mathbf{q}} V(\mathbf{S}, \mathbf{T}; \mathbf{q}) J(\mathbf{S}; -\mathbf{q}) J(\mathbf{T}; \mathbf{q}) \quad (4.1)$$

where

$$V(\mathbf{S}, \mathbf{T}; \mathbf{q}) = \frac{v_F^*}{\Omega} \delta_{\mathbf{S}, \mathbf{T}}^{D-1} + \frac{f(\mathbf{S}, \mathbf{T}; \mathbf{q})}{V}. \quad (4.2)$$

As the nonanalytic behavior of the specific heat derives from small momentum processes it is sufficient to take the Fermi surface to be locally flat. If we again let $q_{\parallel} \equiv \hat{\mathbf{n}}_{\mathbf{S}} \cdot \mathbf{q}$ denote the component of the momentum \mathbf{q} parallel to the surface normal or Fermi momentum in patch \mathbf{S} , the charge currents $J(\mathbf{S}; \mathbf{q})$ can be represented in terms of canonical boson creation and

annihilation operators as follows

$$J(\mathbf{S}; \mathbf{q}) = \begin{cases} \sqrt{-\Omega q_{\parallel}} a^{\dagger}(\mathbf{S}; -\mathbf{q}), & q_{\parallel} \leq 0 \\ \sqrt{\Omega q_{\parallel}} a(\mathbf{S}; \mathbf{q}), & q_{\parallel} > 0 \end{cases} \quad (4.3)$$

With the replacement of the current operators with the canonical bosons the Hamiltonian becomes

$$H = \sum_{\mathbf{S}, \mathbf{T}} \sum_{\mathbf{q}, q_{\parallel} > 0} V(\mathbf{S}, \mathbf{T}; \mathbf{q}) \Omega q_{\parallel} a^{\dagger}(\mathbf{S}; \mathbf{q}) a(\mathbf{T}; \mathbf{q}) \quad (4.4)$$

which we can diagonalize directly to find the spectrum. The specific heat is then computed using the standard formula for bosons, equation 1.14.

First we review the case of noninteracting fermions, $f(\mathbf{S}, \mathbf{T}; \mathbf{q}) = 0$, discussed in the Introduction. The eigenenergies of the bosonized Hamiltonian in this case are simply

$$\epsilon(\mathbf{S}; \mathbf{q}) = v_F^* \hat{\mathbf{n}}_{\mathbf{S}} \cdot \mathbf{q} = v_F^* q_{\parallel} \quad (4.5)$$

which agrees with equation 1.16, the energy of a particle-hole pair. The sum over the patch index \mathbf{S} and the components of \mathbf{q} perpendicular to the Fermi wavevector counts the number of states at the Fermi surface which we call A . The sum over the components of \mathbf{q} parallel to the Fermi wavevector can be converted to an integral. Then assuming that the temperature is sufficiently low such that the thermally excited particle-hole pairs lie within the cutoff, $k_B T \ll v_F^* \lambda$, we obtain

$$\begin{aligned} C_V &= \frac{A}{4k_B T^2} \left(\frac{L}{2\pi} \right) \int_0^{\infty} \frac{v_F^{*2} q_{\parallel}^2}{\sinh^2\left(\frac{v_F^* q_{\parallel}}{2k_B T}\right)} dq_{\parallel} \\ &= k_B^2 T \left[\frac{m^* k_F}{2\pi^2} \right] \frac{\pi^2}{3} L^3. \end{aligned} \quad (4.6)$$

This is the correct result for spinless fermions in $D = 3$ which, of course, should be multiplied by a factor of 2 to account for spin. It is remarkable that the boson formula, equation 1.14, yields the full specific heat. Multidimensional bosonization reproduces the entire fermion Hilbert space.

Now we follow Pethick and Carneiro[52] and focus on particle-hole pairs separated only by a small momentum $\mathbf{w} = \mathbf{k}_{\mathbf{S}} - \mathbf{k}_{\mathbf{T}}$ (with $|\mathbf{w}| \ll k_F$) since a consideration of these processes is sufficient to demonstrate the existence of nonanalytic contributions to the specific heat. In this limit we may continue to approximate the Fermi surface as locally flat as shown in figure 9; this simplifies considerably the problem of diagonalizing the quadratic boson Hamiltonian (see Section 5). Now the current-current coupling $f(\mathbf{S}, \mathbf{T}; \mathbf{q})$ may be expanded in powers of the dimensionless, and rotationally-invariant, expansion parameter $\mathbf{q}^2/(\mathbf{w}^2 + \mathbf{q}^2)$:

$$\begin{aligned} f(\mathbf{S}, \mathbf{T}; \mathbf{q}) &= a + b \frac{\mathbf{q}^2}{\mathbf{q}^2 + \mathbf{w}^2} + \dots \\ &= a + b \frac{q_{\parallel}^2}{q_{\parallel}^2 + \mathbf{w}^2} + \dots \end{aligned} \quad (4.7)$$

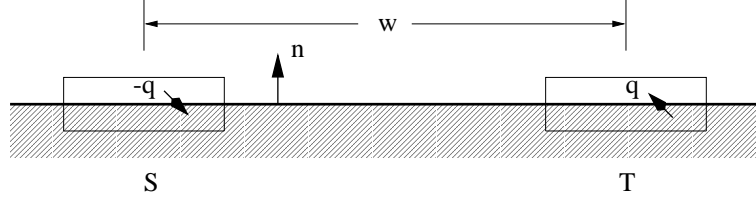

Figure 9: The Fermi surface treated as locally flat, with nearby particle-hole pairs of momentum \mathbf{q} and $-\mathbf{q}$ coupled together.

In the second line we have dropped the perpendicular $\mathbf{q}_\perp \equiv \hat{\mathbf{n}}_S \times \mathbf{q}$ terms in the numerator since they do not contribute to the non-analyticity. The same approximation can be made in the denominator, as the squat aspect-ratio of the patches enforces $|\mathbf{w}| \gg |\mathbf{q}|$ in the $N \rightarrow \infty$ limit. The q_\parallel^2 term in the denominator must be retained to eliminate the artificial divergence which would otherwise occur in the $\mathbf{w}^2 \rightarrow 0$ limit. The expansion is controlled in low-temperature limit which ensures that $|q_\parallel|$, the particle-hole momentum perpendicular to the Fermi surface, is small. The current-current interaction coefficient b , which therefore is irrelevant in the RG sense, gives subleading corrections to the specific heat. In actual fact, the interaction considered here differs from that studied by Pethick and Carneiro in that it couples particle-hole pairs at point \mathbf{S} and \mathbf{T} whereas the Pethick-Carneiro interaction couples the quasiparticle occupancies $n_{\mathbf{p}}$ and $n_{\mathbf{u}+\mathbf{p}}$. To be precise, the Pethick-Carneiro interaction has the form $b' \sum_{\mathbf{u}, \mathbf{p}} (\hat{\mathbf{u}} \cdot \hat{\mathbf{p}})^2 \delta n_{\mathbf{p}} \delta n_{\mathbf{u}+\mathbf{p}}$. This interaction cannot be expressed directly in terms of the currents since it involves the products of quasiparticle *occupancies* above and below the Fermi surface, whereas the current operator evaluated at zero momentum $J(\mathbf{S}; \mathbf{0})$ averages the occupancy operator over the interior of a squat box. Therefore a direct connection with the earlier calculation of Pethick and Carneiro cannot be made.

To proceed, we diagonalize the Hamiltonian with the aid of a Fourier transform from patch index space \mathbf{S} to \mathbf{X} space. Let

$$a^\dagger(\mathbf{S}; \mathbf{q}) = \frac{\Lambda}{\sqrt{4\pi k_F^2}} \int d^2 X e^{-i\mathbf{X} \cdot \mathbf{S}} a^\dagger(\mathbf{X}, \mathbf{q}) \quad (4.8)$$

where $\int d^2 X 1 = 4\pi k_F^2 / \Lambda^2$ is equal to the number of patches which cover the Fermi surface. Then

$$H = L^3 \int d^2 X \int_{-\Lambda/2}^{\Lambda/2} \frac{dq_x}{2\pi} \int_{-\Lambda/2}^{\Lambda/2} \frac{dq_y}{2\pi} \int_0^\lambda \frac{dq_z}{2\pi} \epsilon(\mathbf{X}; \mathbf{q}) a^\dagger(\mathbf{X}; \mathbf{q}) a(\mathbf{X}; \mathbf{q}). \quad (4.9)$$

Using equation 4.2 and the representation of the current given in equation 4.3 we obtain the eigenenergies

$$\epsilon(\mathbf{X}; \mathbf{q}) = v_F^* q_\parallel + \frac{b\Lambda^2 q_\parallel^3}{(2\pi)^3} \sum_{\mathbf{w}} \frac{e^{-i\mathbf{X} \cdot \mathbf{w} / \Lambda}}{q_\parallel^2 + \mathbf{w}^2} \quad (4.10)$$

The sum can be converted to a Riemann integral by the substitution $\Lambda^2 \sum_{\mathbf{w}} \rightarrow \int d^2 w$ and we find

$$\epsilon(\mathbf{X}; \mathbf{q}) = v_F^* q_\parallel - \frac{bq_\parallel^3}{(2\pi)^3} \pi \ln(q_\parallel^2 |\mathbf{X}|^2). \quad (4.11)$$

In this equation we have discarded those terms proportional to b that make analytic contributions to the specific heat and have retained only the logarithmic correction. We treat this term as a perturbation and calculate the specific heat to $O(b)$. The change in the specific heat δC_V due to this perturbation is

$$\begin{aligned}\delta C_V &= -b \frac{A}{k_B T^2} \frac{v_F^* \pi}{(2\pi)^2} \frac{L}{2\pi} \int_0^\infty dq_{\parallel} \frac{q_{\parallel}^4 \ln q_{\parallel}}{\sinh^2 \left[\frac{v_F^* q_{\parallel}}{2k_B T} \right]} \\ &= -b \frac{2ALk_B^4}{\pi^3 (v_F^*)^4} T^3 \ln T \int_0^\infty \frac{x^4}{\sinh^2 x} dx\end{aligned}\quad (4.12)$$

In the second line of this equation we have retained only the term containing $T^3 \ln T$ temperature dependence. The integral in the second line equals $\pi^4/30$ so the final result is

$$\frac{\delta C_V}{L^3} = b \frac{k_B^4 (m^*)^4}{15k_F^2} T^3 \ln T . \quad (4.13)$$

Not surprisingly this result has the same form as that found by Pethick and Carneiro[52] as dimensional analysis makes this likely. A direct comparison of the coefficient is meaningless, however, as the interactions are not the same. Nevertheless, the same point is made: subleading corrections to the linear specific heat have many different origins. Irrelevant interactions such as equation 4.7 or the Pethick-Carneiro form both make nonanalytic contributions to the specific heat, as do other more complicated irrelevant terms[53]. Repeating the calculation in $D = 2$ we find that the interaction equation 4.7 leads to a subleading correction $\delta C_V \sim bT^2$, also in agreement with fermionic calculations[54].

5 Collective Modes

The curvature of the Fermi surface did not play an important role in the determination of the specific heat. In fact we took the Fermi surface to be flat and consequently the Hamiltonian could be rewritten as the sum of products of a single creation operator and a single annihilation operator. Collective excitations of the Fermi surface, on the other hand, are possible because of the curvature. The Fermi surface itself may be viewed as dynamical, sloshing back and forth relative to its equilibrium position in momentum space. It is important to reproduce the collective mode spectrum within the bosonic representation. For a curved Fermi surface the Hamiltonian contains the products of two annihilation operators and the products of two creation operators in addition to the bilinear combination of annihilation and creation operators found for a flat Fermi surface. Therefore a straightforward diagonalization of the bosonic Hamiltonian is no longer possible, see however[34, 35].

In order to discuss the spectrum of collective modes it is necessary to elaborate further on the Hamiltonian. In the absence of an attractive BCS interaction the excitations of the interacting Fermi liquid are in the particle-hole channel and carry either charge or spin. To exhibit this factorization into charge and spin sectors explicitly the bosonized Hamiltonian can be written as $H = H_c + H_s$. The Hamiltonian for the charge sector in D dimensions, as before, is bilinear in the charge current operators $J(\mathbf{S}; \mathbf{q}) = \sum_{\alpha} J_{\alpha}(\mathbf{S}; \mathbf{q})$. We drop the ‘‘c’’

subscript on the charge currents as no ambiguity results.

$$H_c = \frac{1}{2} \sum_{\mathbf{S}\mathbf{T}} \sum_{\mathbf{q}} V_c(\mathbf{S}, \mathbf{T}; \mathbf{q}) J(\mathbf{S}; -\mathbf{q}) J(\mathbf{T}; \mathbf{q}) \quad (5.1)$$

The prefactor of 1/2 compensates for the double-counting $\mathbf{q} \leftrightarrow -\mathbf{q}$ in the sum over the momentum. For the present we consider only the case of short-range Fermi liquid interactions $f_c(\mathbf{S}, \mathbf{T})$:

$$V_c(\mathbf{S}, \mathbf{T}; \mathbf{q}) = \frac{1}{2} \Omega^{-1} v_F^* \delta_{\mathbf{S}, \mathbf{T}}^{D-1} + \frac{1}{V} f_c(\mathbf{S}, \mathbf{T}) . \quad (5.2)$$

The charge currents satisfy the equal-time $U(1)$ current algebra, equation 2.11, but with twice the anomaly as the spin index is summed over. The factor of $\frac{1}{2}$ in the first term of equation 5.2 compensates for this doubling.

For our analysis of the spin collective modes it is convenient to introduce spin currents which are manifestly $SU(2)$ covariant instead of continuing to employ the spin quantization axis as in Section 2. These so-called “non-Abelian” currents[55] are defined to be:

$$\vec{J}(\mathbf{S}; \mathbf{q}) = \frac{1}{2} \sum_{\mathbf{k}} \theta(\mathbf{S}; \mathbf{k} - \mathbf{q}) \theta(\mathbf{S}; \mathbf{k}) \psi_{\mathbf{k}-\mathbf{q}}^{\dagger\alpha} \vec{\sigma}_{\alpha}^{\beta} \psi_{\beta\mathbf{k}} \quad (5.3)$$

where again $\vec{\sigma}$ are Pauli matrices. Note that, unlike the case of the charge currents, there is no need to subtract the vacuum expectation value as the quiescent Fermi liquid is non-magnetic. Like the charge currents, spin currents in different patches on the Fermi surface commute. They also commute with the charge currents. Spin currents in the same box satisfy the more complicated $SU(2)$ current algebra:

$$[J^a(\mathbf{S}; \mathbf{q}), J^b(\mathbf{T}; \mathbf{p})] = \frac{1}{2} \Omega \hat{\mathbf{n}}_{\mathbf{S}} \cdot \mathbf{q} \delta_{\mathbf{S}, \mathbf{T}}^{D-1} \delta^{ab} \delta_{\mathbf{q}+\mathbf{p}, \mathbf{0}}^D + i \delta_{\mathbf{S}, \mathbf{T}}^{D-1} \epsilon^{abc} J^c(\mathbf{S}; \mathbf{q} + \mathbf{p}) ; \quad (5.4)$$

here $(a, b, c) = (x, y, z)$ label the three components of the spin, and ϵ^{abc} is the completely antisymmetric tensor. The coefficient of the first term on the right hand side of the current algebra, equation 5.4, is known as the “central charge,” k . In gapless one-dimensional antiferromagnets[56] with half-odd-integer spin- S , generically $k = 1$ except at special integrable points where $k = 2S$. Here, by contrast, $k = (\Lambda L/2\pi)^{D-1} \gg 1$. The effective spin is large because the coarse-graining procedure sums over a multitude of momentum points inside each squat box; consequently the spin currents are semiclassical in nature.

The spin Hamiltonian is quadratic in the non-Abelian spin currents (unlike the Abelian case, there are no cosines) and Fermi liquid spin-spin interactions f_s which appear in the Hamiltonian couple together spin currents in different patches:

$$H_s = \frac{1}{2} \sum_{\mathbf{S}\mathbf{T}} \sum_{\mathbf{q}} V_s(\mathbf{S}, \mathbf{T}; \mathbf{q}) \vec{J}(\mathbf{S}; -\mathbf{q}) \cdot \vec{J}(\mathbf{T}; \mathbf{q}) \quad (5.5)$$

where

$$V_s(\mathbf{S}, \mathbf{T}; \mathbf{q}) = \frac{2}{3} v_F^* \Omega^{-1} \delta_{\mathbf{S}, \mathbf{T}}^{D-1} + \frac{1}{V} f_s(\mathbf{S}, \mathbf{T}) . \quad (5.6)$$

Note the factor of 2/3 appearing in the construction of the free Hamiltonian, which we discuss below.

Instead of diagonalizing H directly, we find instead the equations of motion for the charge and spin currents which we shall show are equivalent to the well-known collective-mode equations. In the charge sector,

$$\begin{aligned} i\frac{\partial}{\partial t}J(\mathbf{S}; \mathbf{q}) &= [J(\mathbf{S}; \mathbf{q}), H_c] \\ &= v_F^* \hat{\mathbf{n}}_{\mathbf{S}} \cdot \mathbf{q} J(\mathbf{S}; \mathbf{q}) + \hat{\mathbf{n}}_{\mathbf{S}} \cdot \mathbf{q} \frac{2\Omega}{V} \sum_{\mathbf{T}} f_c(\mathbf{S}, \mathbf{T}) J(\mathbf{T}; \mathbf{q}) . \end{aligned} \quad (5.7)$$

The first term on the right hand side of equation 5.7 is due to the free dispersion relation for the particle-hole pairs of momentum \mathbf{q} in the patch \mathbf{S} . The second term couples currents in different patches. Note that

$$\begin{aligned} \frac{\Omega}{V} \sum_{\mathbf{T}} &= \int \frac{d^D k}{(2\pi)^D} \delta(|\mathbf{k}| - k_F) \\ &= \frac{k_F^2}{(2\pi)^3} \int_{-1}^1 d(\cos \theta) \int_0^{2\pi} d\phi \quad (D = 3) ; \end{aligned} \quad (5.8)$$

so the second term reduces to the usual integral over the Fermi surface in the continuum limit of a large number of patches, $N \rightarrow \infty$. The equations of motion for the spin currents contain, in addition to these two terms, a third term which makes the spins precess in the local magnetic field, a phenomenon which is especially important when the system is magnetically polarized.

$$\begin{aligned} i\frac{\partial}{\partial t}J^a(\mathbf{S}; \mathbf{q}) &= v_F^* \hat{\mathbf{n}}_{\mathbf{S}} \cdot \mathbf{q} J^a(\mathbf{S}; \mathbf{q}) + \frac{\Omega}{2V} \hat{\mathbf{n}}_{\mathbf{S}} \cdot \mathbf{q} \sum_{\mathbf{T}} f_s(\mathbf{S}, \mathbf{T}) J^a(\mathbf{T}; \mathbf{q}) \\ &\quad - \frac{i}{V} \epsilon^{abc} \sum_{\mathbf{k}} J^b(\mathbf{S}; \mathbf{k}) \sum_{\mathbf{T}} f_s(\mathbf{S}, \mathbf{T}) J^c(\mathbf{T}; \mathbf{q} - \mathbf{k}) . \end{aligned} \quad (5.9)$$

Note that the factor of $2/3$ multiplying the Fermi velocity v_F^* in the free part of equation 5.6 does not appear in equation 5.9. The origin of the factor of $2/3$ is easy to understand in the Sugawara construction of the free fermion Hamiltonian out of current bilinears[57, 58]. It reflects the $SU(2)$ invariance of the spin currents which permits the replacement $\vec{J}(\mathbf{S}; \mathbf{q}) \cdot \vec{J}(\mathbf{S}; -\mathbf{q}) \rightarrow 3J_z(\mathbf{S}; q)J_z(\mathbf{S}; -\mathbf{q})$, at least for the purpose of computing the spectrum. The derivation given here, on the other hand, does not rely on this argument as spin rotational invariance is respected explicitly. Rather the factor of $2/3$ in equation 5.6 cancels contributions to the equations of motion that arise from both the δ^{ab} and $i\epsilon^{abc}$ terms in the spin current algebra.

Now we are in a position to understand the deeper reason for the absence of renormalization of the spin Landau parameters alluded to in Section 3. Unlike the $D = 1$ case, the spin current operators defined by equation 5.3 involve a sum over a large number of momenta inside the squat box. This is apparent in the non-Abelian algebra equation 5.4 as the diagonal anomaly (the first term proportional to δ^{ab}) is of order $\Omega|\hat{\mathbf{n}}_{\mathbf{S}} \cdot \mathbf{q}| \gg 1$. In the absence of macroscopic spin polarization the anomaly overwhelms the off-diagonal, $i\epsilon^{abc}$, term. Physically this means that, in zero applied magnetic field, the spin equation is identical in form to the charge equation, and spin waves propagate freely as expected[11]. In the opposite limit

of a large external magnetic field, the last term in equation 5.9 dominates. Spins precess locally in this limit. Returning now to the question of the spin Landau parameters, we see that they remain fixed, as only the non-linear $i\epsilon^{abc}$ term can drive renormalization flows and it can be neglected. This proof, which is non-perturbative, and therefore independent of the size of the spin Landau parameters, is consistent with the absence of renormalization found in the weak-coupling calculation presented in Section 3.

As it stands these operator equations are exact, at least in the $N \rightarrow \infty$ limit in which the current algebras, equations 2.11 and 5.4, become exact. Solving the charge collective mode equation 5.7 is straightforward as it is linear. The equation for the spin currents is more difficult to solve due to the nonlinear term. Here for completeness we solve the charge equation for a spherical Fermi surface in $D = 3$ with one Landau parameter, $f_c(\mathbf{S}, \mathbf{T}) = f_0$. As usual we search for a normal mode solution of the form:

$$J(\mathbf{S}; \mathbf{q}, t) = e^{-i\omega t} u(\mathbf{S}; \mathbf{q}) ; \quad (5.10)$$

also set $\mathbf{q} = q\hat{z}$ for definiteness. Then equation 5.7 becomes:

$$(v_F^* q \cos \theta - \omega) u(\theta, \phi; q) + v_F^* q \cos \theta \frac{f_0 k_F^2}{4\pi^3 v_F^*} \int_{-1}^1 d(\cos \theta') \int_0^{2\pi} d\phi' u(\theta', \phi'; q) = 0 \quad (5.11)$$

and the solution then is given by

$$u(\theta, \phi; q) = \frac{\cos \theta}{x - \cos \theta} \quad (5.12)$$

where we have introduced the dimensionless quantity $x \equiv \frac{\omega}{v_F^* |\mathbf{q}|}$. Equation 5.11 determines the allowed values of x . Substituting equation 5.12 into equation 5.11 we find that propagating modes exist for $x > 1$ with x given implicitly by:

$$\begin{aligned} 1 &= \frac{k_F m^* f_0}{2\pi^2} \left(x \ln \frac{x+1}{x-1} - 2 \right) \\ &= \frac{F_0}{2} \left(x \ln \frac{x+1}{x-1} - 2 \right) \end{aligned} \quad (5.13)$$

with the introduction of the conventional dimensionless form of the Landau parameters

$$F_\ell = N^*(0) f_\ell \quad (5.14)$$

and recalling that in $D = 3$

$$N^*(0) = 2 \int_0^\infty \frac{4\pi k^2 dk}{(2\pi)^3} \delta(\epsilon(\mathbf{k}) - \epsilon_F) = \frac{m^* k_F}{\pi^2} . \quad (5.15)$$

Analytic solutions of equation 5.13 exist[15] in the extreme limits $0 < F_0 \ll 1$ and $F_0 \gg 1$:

$$x = \begin{cases} 1 + 2e^{-2/F_0}, & 0 < F_0 \ll 1 \\ \sqrt{F_0/3}, & F_0 \gg 1 . \end{cases} \quad (5.16)$$

It is remarkable that the charge sector can be solved exactly without taking the semiclassical limit of a macroscopically occupied collective mode. We show in the next Section that the position of the poles of the boson correlation function agree with the dispersion of the collective mode found here, as must be the case.

To complete the discussion, we show how to construct spin collective modes in the semiclassical limit. We seek to replace the quantum spin current operator \mathbf{J}^a with its semiclassical expectation value:

$$\langle J^a(\mathbf{S}; \mathbf{q}, t) \rangle = S^a(\mathbf{S}; \mathbf{q}, t) \quad (5.17)$$

Note that the collective mode amplitudes are real valued in \mathbf{x} -space as $[\vec{J}(\mathbf{S}; \mathbf{q})]^\dagger = \vec{J}(\mathbf{S}; -\mathbf{q})$. The replacement of the current operators by c -numbers can be accomplished formally by introducing a coherent state basis which spans the space of geometric distortions of the Fermi surface[34, 35]. Spin collective mode coherent states are generated by exponentials of the spin current operator

$$|\Psi[\vec{S}]\rangle = \exp \left\{ \sum_{\mathbf{T}} \sum_{\mathbf{q}} 2 \frac{\theta(\hat{\mathbf{n}}_{\mathbf{T}} \cdot \mathbf{q})}{\Omega \hat{\mathbf{n}}_{\mathbf{T}} \cdot \mathbf{q}} \vec{S}(\mathbf{T}; \mathbf{q}) \cdot \vec{J}(\mathbf{T}; -\mathbf{q}) \right\} |0\rangle \quad (5.18)$$

where $|0\rangle$ represents the quiescent Fermi liquid. A simple computation using the spin current algebra equation 5.4 then shows that

$$\frac{\langle \Psi[\vec{S}] | J^a(\mathbf{T}; \mathbf{p}) | \Psi[\vec{S}] \rangle}{\langle \Psi[\vec{S}] | \Psi[\vec{S}] \rangle} = S^a(\mathbf{T}; \mathbf{p}) \quad (5.19)$$

consistent with our definition, equation 5.17. In the equation for the spin collective modes it is also necessary to decouple the expectation value of the product of two spin currents into the product of expectation values $\vec{S}(\mathbf{T}; \mathbf{k}) \times \vec{S}(\mathbf{T}; \mathbf{q} - \mathbf{k})$. The decoupling is exact only in the semiclassical limit of a macroscopically occupied spin mode.

In summary, multidimensional bosonization captures all of the well-known physics of charge and spin collective modes. The derivation of the equations of motion is straightforward and relies only on the existence of the Abelian and non-Abelian current-current commutation relations and the quadratic Hamiltonian which describes the $U(1)_k^\infty$ fixed point.

6 Quasiparticle Properties

In this section we use the bosonization scheme to determine the fermion propagator of a system of spinless fermions interacting via two body forces. The question we address is: What is the nature of the ground state and how does the ground state depend on the spatial dimension D and the range of the interactions?

Making use of the bosonization formula, equation 2.21, the fermion propagator for a single patch on the Fermi surface can be expressed in terms of the boson propagator

$$\begin{aligned} G_F(\mathbf{S}; \mathbf{x}, \tau) &= -\langle \psi(\mathbf{S}; \mathbf{x}, \tau) \psi^\dagger(\mathbf{S}; \mathbf{0}, 0) \rangle \\ &= -\frac{\Lambda^{D-1}}{(2\pi)^D} \frac{e^{i\mathbf{k}_S \cdot \mathbf{x}}}{a} \langle \exp[i\frac{\sqrt{4\pi}}{\Omega} \phi(\mathbf{S}; \mathbf{x}, \tau)] \exp[-i\frac{\sqrt{4\pi}}{\Omega} \phi(\mathbf{S}; \mathbf{0}, 0)] \rangle \end{aligned} \quad (6.1)$$

which can be rewritten by means of the Baker-Hausdorff formula, equation 2.26 as

$$G_F(\mathbf{S}; \mathbf{x}, \tau) = -\frac{\Lambda^{D-1}}{(2\pi)^D} \frac{e^{i\mathbf{k}_S \cdot \mathbf{x}}}{a} \exp \left[\frac{4\pi}{\Omega^2} \langle \phi(\mathbf{S}; \mathbf{x}, \tau) \phi(\mathbf{S}; \mathbf{0}, 0) - \phi^2(\mathbf{S}; \mathbf{0}, 0) \rangle \right] \quad (6.2)$$

It is convenient to express the fields, ϕ in terms of the canonical boson fields, a and a^\dagger , equation 2.18. Then the correlation function $G_\phi(\mathbf{S}; \mathbf{x}, \tau)$ can be written as

$$G_\phi(\mathbf{S}; \mathbf{x}, \tau) = \langle \phi(\mathbf{S}; \mathbf{x}, \tau) \phi(\mathbf{S}; \mathbf{0}, 0) - \phi^2(\mathbf{S}; \mathbf{0}, 0) \rangle = \frac{\Omega}{4\pi} \sum_{\mathbf{q}} \int \frac{d\omega}{2\pi} [e^{i(\mathbf{q} \cdot \mathbf{x} - \omega\tau)} - 1] \frac{\langle a(\mathbf{S}; \mathbf{q}) a^\dagger(\mathbf{S}; \mathbf{q}) \rangle}{\hat{\mathbf{n}}_S \cdot \mathbf{q}} \quad (6.3)$$

which determines the fermion Green's function once the Fourier transform of the boson Green's function

$$G_B(\mathbf{S}; \mathbf{x}, \tau) = -\langle a(\mathbf{S}; \mathbf{x}, \tau) a^\dagger(\mathbf{S}; \mathbf{0}, 0) \rangle \quad (6.4)$$

is known. This procedure although straightforward in principle can be difficult to carry out in practice. As we show below, the Fourier transform of the boson Green's function can be obtained exactly for any interaction and for any spatial dimension, but to determine the fermion Green's function this result must be back transformed, equation 6.3, and exponentiated, equation 6.2. Finally, to extract the nature of the fermion propagator, this space-time result must be Fourier transformed back into momentum and frequency space.

To determine the boson propagator we introduce source fields $\xi(\mathbf{S}; q)$ and $\xi^*(\mathbf{S}; q)$ where $q \equiv (\mathbf{q}, \omega)$ is shorthand notation for the $D+1$ dimensional vector and construct the generating functional:

$$Z[\xi, \xi^*] = \int Da(\mathbf{S}; q) Da^*(\mathbf{S}; q) \exp \left[-S[a^*, a] - \sum_{\mathbf{q}} \sum_{\hat{\mathbf{n}}_S \cdot \mathbf{q} > 0} \int \frac{d\omega}{2\pi} \{ \xi^*(\mathbf{S}; q) a(\mathbf{S}; q) + \xi(\mathbf{S}; q) a^*(\mathbf{S}; q) \} \right]. \quad (6.5)$$

Here the action is given in terms of the Hamiltonian as:

$$S[a^*, a] = \int d\tau \left\{ \sum_{\mathbf{S}} \int d^D x a^*(\mathbf{S}; x) \frac{\partial}{\partial \tau} a(\mathbf{S}; x) + H[a^*, a] \right\}. \quad (6.6)$$

Then the boson Green's function may be found by differentiating with respect to the source fields:

$$G_B(\mathbf{S}, \mathbf{T}; q) = -\langle a(\mathbf{S}; q) a^*(\mathbf{T}; q) \rangle = -\frac{\delta^2 \ln Z}{\delta \xi(\mathbf{T}; q) \delta \xi^*(\mathbf{S}; q)} \Big|_{\xi = \xi^* = 0}. \quad (6.7)$$

To illustrate this procedure consider a system of spinless fermions in two dimensions interacting via short range Fermi liquid interactions. The action is

$$S[a^*, a] = S_0[a^*, a] + S_{FL}[a^*, a] \quad (6.8)$$

where the free fermion contribution to the action, written in terms of the canonical boson fields, is:

$$S_0[a^*, a] = -\sum_{\mathbf{q}} \sum_{\hat{\mathbf{n}}_S \cdot \mathbf{q} > 0} \int \frac{d\omega}{2\pi} (i\omega - v_F^* \hat{\mathbf{n}}_S \cdot \mathbf{q}) a^*(\mathbf{S}; q) a(\mathbf{S}; q) \quad (6.9)$$

and the term due to Fermi liquid interactions can be expressed as:

$$S_{FL}[a^*, a] = \frac{1}{2V} \int \frac{d\omega}{2\pi} \sum_{\mathbf{S}, \mathbf{T}} \sum_{\mathbf{q}} f(\mathbf{S}, \mathbf{T}) J(\mathbf{S}; -q) J(\mathbf{T}; q) \quad (6.10)$$

where we recall that

$$J(\mathbf{S}; q) = \sqrt{\Omega \hat{\mathbf{n}}_{\mathbf{S}} \cdot \mathbf{q}} [a(\mathbf{S}; q) \theta(\mathbf{S}; \mathbf{q}) + a^*(\mathbf{S}; -q) \theta(\mathbf{S}; -\mathbf{q})]. \quad (6.11)$$

In equation 6.9 and in what follows we abbreviate $\sum_{\mathbf{q}} \sum_{\mathbf{S}, \hat{\mathbf{n}}_{\mathbf{S}} \cdot \mathbf{q} > 0}$ by simply $\sum_{\mathbf{q}} \sum_{\hat{\mathbf{n}}_{\mathbf{S}} \cdot \mathbf{q} > 0}$. For free fermions the generating function is

$$\begin{aligned} Z[\xi, \xi^*] &= \int DaDa^* \exp \left\{ \sum_{\mathbf{q}} \sum_{\hat{\mathbf{n}}_{\mathbf{S}} \cdot \mathbf{q} > 0} \int \frac{d\omega}{2\pi} a^*(\mathbf{S}; q) (i\omega - v_F^* \hat{\mathbf{n}}_{\mathbf{S}} \cdot \mathbf{q}) a(\mathbf{S}; q) \right. \\ &\quad \left. - \xi^*(\mathbf{S}; q) a(\mathbf{S}; q) - \xi(\mathbf{S}; q) a^*(\mathbf{S}; q) \right\}. \end{aligned} \quad (6.12)$$

The action is quadratic in the bose fields which can be integrated out to give

$$Z[\xi, \xi^*] = \exp - \sum_{\mathbf{q}} \sum_{\hat{\mathbf{n}}_{\mathbf{S}} \cdot \mathbf{q} > 0} \int \frac{d\omega}{2\pi} \xi^*(\mathbf{S}; q) \frac{1}{(i\omega - v_F^* \hat{\mathbf{n}}_{\mathbf{S}} \cdot \mathbf{q})} \xi(\mathbf{S}; q) \quad (6.13)$$

and therefore

$$G_B^0(\mathbf{S}, \mathbf{T}; q) = -\langle a(\mathbf{S}; q) a^*(\mathbf{T}; q) \rangle = \frac{\delta_{\mathbf{S}, \mathbf{T}}^{D-1}}{i\omega - v_F^* \hat{\mathbf{n}}_{\mathbf{S}} \cdot \mathbf{q}} \quad (6.14)$$

On taking the modified Fourier transform, equation 6.3, the patch-diagonal piece of the G_ϕ correlation function is given by:

$$G_\phi^0(\mathbf{S}; \mathbf{x}, \tau) = -\frac{\Omega^2}{4\pi} \ln \left[\frac{\hat{\mathbf{n}}_{\mathbf{S}} \cdot \mathbf{x} + iv_F^* \tau}{ia} \right]. \quad (6.15)$$

Exponentiating this equation, the free fermion Green's function is found to be given by

$$G_F^0(\mathbf{S}; \mathbf{x}, \tau) = \frac{i\Lambda}{(2\pi)^2} \frac{e^{i\mathbf{k}_{\mathbf{S}} \cdot \mathbf{x}}}{\hat{\mathbf{n}}_{\mathbf{S}} \cdot \mathbf{x} + iv_F^* \tau}. \quad (6.16)$$

Additional details of the calculation are presented in Appendix C.

The analysis can be extended now to include the interactions, equation 6.10. First Fourier decompose the coupling $f(\mathbf{S}, \mathbf{T})$ and introduce Landau parameters f_n :

$$f(\mathbf{S}, \mathbf{T}) = \sum_n f_n \cos[n\theta(\mathbf{k}_{\mathbf{S}}, \mathbf{k}_{\mathbf{T}})] \quad (6.17)$$

and recall the addition theorem in $D = 2$

$$\cos[n\theta(\mathbf{k}_{\mathbf{S}}, \mathbf{k}_{\mathbf{T}})] = (-1)^n \left[\cos[n\theta(\mathbf{k}_{\mathbf{S}}, \mathbf{q})] \cos[n\theta(\mathbf{k}_{\mathbf{T}}, \mathbf{q})] + \sin[n\theta(\mathbf{k}_{\mathbf{S}}, \mathbf{q})] \sin[n\theta(\mathbf{k}_{\mathbf{T}}, \mathbf{q})] \right]. \quad (6.18)$$

Here $\theta(\mathbf{k}_S, \mathbf{k}_T)$ is the angle between \mathbf{k}_S and \mathbf{k}_T . To avoid the complicated Bogoliubov transformation needed to diagonalize the Hamiltonian, we introduce instead auxiliary gauge fields A_n^ℓ and A_n^t , two fields for each n , and perform a Hubbard-Stratonovich transformation to decouple the interaction[32]. We call these auxiliary fields “gauge” fields since in the case of the long-range Coulomb interaction which we consider below they correspond to the scalar component of the electromagnetic potential, A_0 , which mediates the interaction (see figure 6). Written in terms of the gauge fields the short-range interaction has the form

$$\begin{aligned}
S_{FL} &= \frac{1}{2V} \int \frac{d\omega}{2\pi} \sum_{\mathbf{q}} \left\{ (-1)^n \left[A_n^\ell(-q) \frac{1}{f_n} A_n^\ell(q) + A_n^t(-q) \left(\frac{1}{f_n} - \delta_{n,0} \right) A_n^t(q) \right] \right. \\
&+ i \sum_{\mathbf{S}} \left[A_n^\ell(-q) \cos[n\theta(\mathbf{k}_S, \mathbf{q})] + A_n^t(-q) \sin[n\theta(\mathbf{k}_S, \mathbf{q})] \right] J(\mathbf{S}; q) \\
&+ \left. i \sum_{\mathbf{S}} \left[A_n^\ell(q) \cos[n\theta(\mathbf{k}_S, -\mathbf{q})] + A_n^t(q) \sin[n\theta(\mathbf{k}_S, -\mathbf{q})] \right] J(\mathbf{S}; -q) \right\} \quad (6.19)
\end{aligned}$$

where it is understood that the repeated index n is summed over. When the gauge fields are integrated out in the generating functional the original interaction is reproduced. Now if we express the currents $J(\mathbf{S}; q)$ in terms of the canonical boson fields we see that

$$\begin{aligned}
&\int \frac{d\omega}{2\pi} \sum_{\mathbf{q}, \mathbf{S}} A_n^\ell(-q) \cos[n\theta(\mathbf{k}_S, \mathbf{q})] J(\mathbf{S}; q) \\
&= \int \frac{d\omega}{2\pi} \sum_{\mathbf{q}, \mathbf{S}} A_n^\ell(q) \cos[n\theta(\mathbf{k}_S, -\mathbf{q})] J(\mathbf{S}; -q) \\
&= \int \frac{d\omega}{2\pi} \sum_{\mathbf{q}, \hat{\mathbf{n}}_S \cdot \mathbf{q} > 0} \sqrt{\Omega \hat{\mathbf{n}}_S \cdot \mathbf{q}} \left[a(\mathbf{S}; q) A_n^\ell(-q) \cos[n\theta(\mathbf{k}_S, \mathbf{q})] \right. \\
&+ \left. a^*(\mathbf{S}; q) A_n^\ell(q) \cos[n\theta(\mathbf{k}_S, -\mathbf{q})] \right] \quad (6.20)
\end{aligned}$$

and therefore

$$\begin{aligned}
S_{FL} &= \frac{1}{V} \int \frac{d\omega}{2\pi} \sum_{\mathbf{q}} \left\{ \left[A_n^\ell(-q) \frac{(-1)^n}{2f_n} A_n^\ell(q) + A_n^t(-q) (-1)^n \frac{(1 - \delta_{n,0})}{2f_n} A_n^t(q) \right] \right. \\
&+ i \sum_{\hat{\mathbf{n}}_S \cdot \mathbf{q} > 0} a(\mathbf{S}; q) \left[\sqrt{\Omega \hat{\mathbf{n}}_S \cdot \mathbf{q}} \left[A_n^\ell(-q) \cos[n\theta(\mathbf{k}_S, \mathbf{q})] + A_n^t(-q) \sin[n\theta(\mathbf{k}_S, \mathbf{q})] \right] \right. \\
&+ \left. \left. a^*(\mathbf{S}; q) \left[\sqrt{\Omega \hat{\mathbf{n}}_S \cdot \mathbf{q}} \left[A_n^\ell(q) \cos[n\theta(\mathbf{k}_S, -\mathbf{q})] + A_n^t(q) \sin[n\theta(\mathbf{k}_S, -\mathbf{q})] \right] \right] \right\}. \quad (6.21)
\end{aligned}$$

The action is now in a form which allows the canonical bose fields, a and a^* , to be integrated out and the resulting generating functional is expressed as

$$\begin{aligned}
Z[\xi, \xi^*] &= \int DA_n^\ell DA_n^t \exp -S_G[A] \\
&\times \exp - \left\{ \int \frac{d\omega}{2\pi} \sum_{\mathbf{q}} \sum_{\hat{\mathbf{n}}_S \cdot \mathbf{q} > 0} \frac{i}{V} \frac{\sqrt{\Omega \hat{\mathbf{n}}_S \cdot \mathbf{q}}}{i\omega - v_F^* \hat{\mathbf{n}}_S \cdot \mathbf{q}} \left[\xi^*(\mathbf{S}; q) b_n^m(\mathbf{S}; -\mathbf{q}) A_n^m(q) + \xi(\mathbf{S}; q) b_n^m(\mathbf{S}; \mathbf{q}) A_n^m(-q) \right] \right. \\
&+ \left. \xi^*(\mathbf{S}; q) \frac{1}{(i\omega - v_F^* \hat{\mathbf{n}}_S \cdot \mathbf{q})} \xi(\mathbf{S}; q) \right\} \quad (6.22)
\end{aligned}$$

here the index m ranges over (ℓ, t) and the associated 2-vectors $b_n^m(\mathbf{S}; \mathbf{q})$ have components:

$$\begin{aligned} b_n^\ell(\mathbf{S}; \mathbf{q}) &\equiv \cos[n\theta(\mathbf{k}_\mathbf{S}, \mathbf{q})] \\ b_n^t(\mathbf{S}; \mathbf{q}) &\equiv \sin[n\theta(\mathbf{k}_\mathbf{S}, \mathbf{q})] . \end{aligned} \quad (6.23)$$

Using this notation the gauge action can be written as

$$S_G[A] = \frac{1}{V} \int \frac{d\omega}{2\pi} \sum_{\mathbf{q}; \hat{\mathbf{n}}_\mathbf{S} \cdot \mathbf{q} > 0} A_n^m(-q) K_{nn'}^m(q) A_{n'}^m(q) \quad (6.24)$$

where the matrices $K_{nn'}$ are given by

$$K_{nn'}^\ell(q) = (-1)^n \left[\frac{\delta_{nn'}}{f_n} - \frac{\Lambda}{(2\pi)^2} \sum_{\mathbf{S}} \frac{\hat{\mathbf{n}}_\mathbf{S} \cdot \mathbf{q}}{(i\omega - v_F^* \hat{\mathbf{n}}_\mathbf{S} \cdot \mathbf{q})} \cos[n\theta(\mathbf{k}_\mathbf{S}, \mathbf{q})] \cos[n'\theta(\mathbf{k}_\mathbf{S}, \mathbf{q})] \right] \quad (6.25)$$

and

$$K_{nn'}^t(q) = (-1)^n \left[\frac{\delta_{nn'}(1 - \delta_{n,0})}{f_n} - \frac{\Lambda}{(2\pi)^2} \sum_{\mathbf{S}} \frac{\hat{\mathbf{n}}_\mathbf{S} \cdot \mathbf{q}}{(i\omega - v_F^* \hat{\mathbf{n}}_\mathbf{S} \cdot \mathbf{q})} \sin[n\theta(\mathbf{k}_\mathbf{S}, \mathbf{q})] \sin[n'\theta(\mathbf{k}_\mathbf{S}, \mathbf{q})] \right] . \quad (6.26)$$

In these equations the \mathbf{q} -sum is now restricted to $\hat{\mathbf{n}}_\mathbf{S} \cdot \mathbf{q} > 0$, and the sum over \mathbf{S} (integral over angles) runs free. Recognizing that $\Lambda \sum_{\mathbf{S}} = 2\pi k_F$, equation 6.25 can be written in the more familiar form:

$$K_{nn'}^\ell(q) = (-1)^n \left[\frac{\delta_{nn'}}{f_n} - N^*(0) \int \frac{d\theta}{2\pi} \frac{\cos \theta}{x - \cos \theta} \cos(n\theta) \cos(n'\theta) \right] \quad (6.27)$$

and a similar equation for $K_{nn'}^t$, here as usual $x \equiv \omega/(v_F^* |\mathbf{q}|)$ and $N^*(0) = m^*/2\pi$ is the density of states of spinless fermions in two dimensions.

The gauge fields can now be integrated out to provide an explicit expression for the generating functional

$$\begin{aligned} Z[\xi, \xi^*] &= \exp - \left\{ \sum_{\mathbf{q}; \hat{\mathbf{n}}_\mathbf{S} \cdot \mathbf{q} > 0} \int \frac{d\omega}{2\pi} \left[\sum_{\mathbf{S}} \xi^*(\mathbf{S}; q) \frac{1}{i\omega - v_F^* \hat{\mathbf{n}}_\mathbf{S} \cdot \mathbf{q}} \xi(\mathbf{S}; q) \right. \right. \\ &+ \sum_{\mathbf{S}\mathbf{T}} \xi^*(\mathbf{S}; q) \frac{\sqrt{\Omega \hat{\mathbf{n}}_\mathbf{S} \cdot \mathbf{q}}}{i\omega - v_F^* \hat{\mathbf{n}}_\mathbf{S} \cdot \mathbf{q}} (b_n^m(\mathbf{S}; -\mathbf{q}) D_{nn'}^m(q) b_{n'}^m(\mathbf{T}; \mathbf{q})) \\ &\left. \left. \times \frac{\sqrt{\Omega \hat{\mathbf{n}}_\mathbf{T} \cdot \mathbf{q}}}{i\omega - v_F^* \hat{\mathbf{n}}_\mathbf{T} \cdot \mathbf{q}} \xi(\mathbf{T}; q) \right] \right\} . \end{aligned} \quad (6.28)$$

Here the gauge propagator is given by the matrix inverse of the K -matrix:

$$\mathbf{D}^m(q) = [\mathbf{K}^m(q)]^{-1} . \quad (6.29)$$

The boson propagator now can be determined directly by differentiating the generating functional, equation 6.7:

$$G_B(\mathbf{S}, \mathbf{T}; q) = \frac{\delta_{\mathbf{S}, \mathbf{T}}^{D-1}}{i\omega - v_F^* \hat{\mathbf{n}}_\mathbf{S} \cdot \mathbf{q}} + \frac{\sqrt{\Omega \hat{\mathbf{n}}_\mathbf{S} \cdot \mathbf{q}}}{i\omega - v_F^* \hat{\mathbf{n}}_\mathbf{S} \cdot \mathbf{q}} b_n^m(\mathbf{S}; -\mathbf{q}) D_{nn'}^m(q) b_{n'}^m(\mathbf{T}; \mathbf{q}) \frac{\sqrt{\Omega \hat{\mathbf{n}}_\mathbf{T} \cdot \mathbf{q}}}{i\omega - v_F^* \hat{\mathbf{n}}_\mathbf{T} \cdot \mathbf{q}} \quad (6.30)$$

and the fermion propagator follows immediately upon exponentiating:

$$\begin{aligned}
G_F(\mathbf{S}; \mathbf{x}, \tau) &= \frac{\Lambda}{(2\pi)^2} \frac{e^{i\mathbf{k}_S \cdot \mathbf{x}}}{\hat{\mathbf{n}}_S \cdot \mathbf{x} + iv_F^* \tau} \exp \left[- \sum_{\mathbf{q}} \int \frac{d\omega}{2\pi} (e^{i(\mathbf{q} \cdot \mathbf{x} - \omega \tau)} - 1) \frac{b_n^m(\mathbf{S}; -\mathbf{q}) D_{nn'}^m(q) b_{n'}^m(\mathbf{S}; \mathbf{q})}{(i\omega - v_F^* \hat{\mathbf{n}}_S \cdot \mathbf{q})^2} \right] \\
&= \frac{\Lambda}{(2\pi)^2} \frac{e^{i\mathbf{k}_S \cdot \mathbf{x}}}{\hat{\mathbf{n}}_S \cdot \mathbf{x} + iv_F^* \tau} \exp[-\delta G_\phi(\mathbf{S}; \mathbf{x}, \tau)]; \quad \mathbf{x}_\perp \equiv \mathbf{x} \times \hat{\mathbf{n}}_S = 0
\end{aligned} \tag{6.31}$$

This key result is exact within the bosonization scheme. The condition $\mathbf{x}_\perp = 0$ can be replaced by $|\mathbf{x}_\perp|/\Lambda < 1$ provided we control the logarithmic infrared divergence of the free boson correlation function by placing the system in a large box. The weak divergence, which is a consequence of treating the Fermi surface as locally flat within each patch, presents no real difficulties in practice and is ignored in the following. For $|\mathbf{x}_\perp|/\Lambda > 1$ the fermion Green's function vanishes since bosons separated by large perpendicular distances, \mathbf{x}_\perp , are uncorrelated. For convenience in the second line of equation 6.31 we have introduced the notation $\delta G_\phi(\mathbf{S}; \mathbf{x}, \tau)$ to denote the modified Fourier transform of the additive correction to the free ϕ -boson propagator due to interactions

$$\delta G_\phi(\mathbf{S}; \mathbf{x}, \tau) = \int_{-\lambda/2}^{\lambda/2} \frac{d^D q}{(2\pi)^D} \int \frac{d\omega}{2\pi} [e^{i(\mathbf{q} \cdot \mathbf{x} - \omega \tau)} - 1] \delta G_\phi(\mathbf{S}; \mathbf{q}, \omega) \tag{6.32}$$

where we can identify $\delta G_\phi(\mathbf{S}; \mathbf{q}, \omega)$ as

$$\delta G_\phi(\mathbf{S}; \mathbf{q}, \omega) = \frac{b_n^m(\mathbf{S}; \mathbf{q}) D_{nn'}^m(q) b_{n'}^m(\mathbf{S}; \mathbf{q})}{(i\omega - v_F^* \hat{\mathbf{n}}_S \cdot \mathbf{q})^2} \tag{6.33}$$

In equation 6.31 the momentum integral ranges over $(-\lambda/2, \lambda/2)$ in each direction. By contrast in the free part of the boson and fermion propagators the perpendicular momentum ranges over the much larger interval $(-\Lambda/2, \Lambda/2)$. The reason for this lies in the fact that the Fermi surface normal points in a different direction in each patch on the Fermi surface. As interactions couple together different patches, and as the patches are squat boxes with dimension $\Lambda^{D-1} \times \lambda$, only wavevectors $|\mathbf{q}| < \lambda$ are permitted by the geometry of the construction.

To complete the program of computing the fermion two point function, the in-patch Green's function equation 6.31 is summed over all patches on the Fermi surface,

$$G_F(\mathbf{x}, \tau) = \sum_{\mathbf{S}}' G_F(\mathbf{S}; \mathbf{x}, \tau). \tag{6.34}$$

As in section 2, the prime indicates that the sum is only over patches for which $|\mathbf{x} \times \hat{\mathbf{n}}_S|/\Lambda < 1$. The expression for the fermion Green's function given here, equations 6.31 and 6.34, is identical to that found by Castellani et al.[42] who made use of Ward identities derived in the fermion basis[41] to obtain equation 6.31.

In general the calculation of correlation functions is complicated as it involves large matrices, but to illustrate the method, as is common practice, we can truncate the Landau expansion and set all parameters except f_0 equal to zero. First, to demonstrate the nonperturbative nature of the approach explicitly, we consider the propagator of a fermion liquid in

one spatial dimension. In one dimension there are two Fermi points and fermion quasiparticles can only propagate to the right or to the left. In this instance the generating functional is given by

$$Z[\xi, \xi^*] = \exp - \sum_q \int \frac{d\omega}{2\pi} \left\{ \xi^*(R, q) \frac{1}{i\omega - v_F^* q} \xi(R, q) - \xi^*(L, q) \frac{1}{i\omega + v_F^* q} \xi(L, q) + \frac{q}{2\pi} \left(\frac{\xi^*(R, q)}{i\omega - v_F^* q} - \frac{\xi(L, -q)}{i\omega + v_F^* q} \right) K_{00}^{-1}(q) \left(\frac{\xi(R, q)}{i\omega - v_F^* q} - \frac{\xi^*(L, -q)}{i\omega + v_F^* q} \right) \right\} \quad (6.35)$$

where the single element of the matrix K_{00} is given by

$$K_{00}(q) = \left[\frac{1}{f_0} - \frac{q}{2\pi} \left(\frac{1}{i\omega - v_F^* q} - \frac{1}{i\omega + v_F^* q} \right) \right] \quad (6.36)$$

The boson propagator for quasiparticles propagating to the right, for example, is given by

$$G_B(R; q) = \frac{1}{i\omega - v_F^* q} + \frac{q}{2\pi} \frac{K_{00}^{-1}(q)}{(i\omega - v_F^* q)^2} \quad (6.37)$$

which after some algebra can be rewritten as

$$G_B(R; q) = \frac{a}{i\omega - qv_F^*(1 + f_0/\pi v_F^*)^{1/2}} + \frac{b}{i\omega + qv_F^*(1 + f_0/\pi v_F^*)^{1/2}} \quad (6.38)$$

where

$$\begin{pmatrix} a \\ b \end{pmatrix} = \frac{1}{2} \left[1 \pm \frac{(1 + f_0/2\pi v_F^*)}{(1 + f_0/\pi v_F^*)^{1/2}} \right]. \quad (6.39)$$

Now $v'_F = v_F^*(1 + f_0/2\pi v_F^*)$ is the renormalized Fermi velocity due to *intrapatch* scattering. Introducing the dimensionless coupling $F_0 \equiv f_0/(\pi v'_F)$ the boson Green's function can be expressed as

$$G_B(R, q) = \frac{\cosh^2 \eta}{i\omega - qv'_F(1 - (F_0/2)^2)^{1/2}} + \frac{\sinh^2 \eta}{i\omega - qv'_F(1 - (F_0/2)^2)^{1/2}} \quad (6.40)$$

where

$$\cosh^2 \eta = \frac{1}{2} \left[1 + \frac{1}{\sqrt{1 - (F_0/2)^2}} \right] \quad (6.41)$$

reflecting the fact that *interpatch* interactions further renormalize the speed of right and left moving quasiparticles, $\bar{v}_F = v'_F \sqrt{1 - (F_0/2)^2}$. The fermion propagator can now be found analytically using equations 6.2 and 6.3 as

$$G_F(R; x, \tau) = ie^{ik_F x} \frac{(x^2 + \bar{v}_F^2 \tau^2)^{-\zeta}}{(x + i\bar{v}_F \tau)} \quad (6.42)$$

The result is exact and identical to that found by diagonalizing the bosonic Hamiltonian via a Bogoliubov transformation[2]. It illustrates the well-known fact that in one spatial dimension even short-range interactions destroy the Fermi liquid fixed point. The propagator

is non-analytic in the coupling constant f_0 , the anomalous exponent $\zeta = \sinh^2 \eta$, and the simple pole of the noninteracting Fermi gas at $x = -iv_F^* \tau$ is replaced by a branch cut. The distribution function for fermions near the Fermi surface is obtained by Fourier transform of the equal-time ($\tau = 0$) propagator:

$$n_R(k) = n_R(k_F) - C \operatorname{sgn}(k - k_F) |k - k_F|^{2\zeta} \quad (6.43)$$

where C is a nonuniversal constant. The occupancy no longer has a step discontinuity at the Fermi surface, rather it is continuous, although non-analytic, with a divergent slope at the Fermi points, characteristic of a Luttinger liquid.

We have shown that bosonization transforms the problem of interacting fermions into a problem of Gaussian bosons which in one dimension can be solved exactly. In one dimension the conventional Fermi liquid picture breaks down and the fixed point is a Luttinger liquid. In the remainder of this section we use the multidimensional bosonization approach to study the properties of interacting fermions systems in higher dimension, especially two spatial dimensions. In $D = 2$, the zero-zero elements of the inverse gauge propagator are given by

$$K_{00}^\ell(q) = \frac{1}{f_0} + \chi_0(q) \quad (6.44)$$

where

$$\chi_0(\mathbf{q}, \omega) = N^*(0) \int \frac{d\theta}{2\pi} \frac{\cos \theta}{\cos \theta - \frac{i\omega}{v_F^* |\mathbf{q}|}} \quad (6.45)$$

It follows from equation 6.30 that the boson propagator is given by

$$G_B(\mathbf{S}, \mathbf{T}; q) = \frac{\delta_{\mathbf{S}, \mathbf{T}}}{i\omega - v_F^* \hat{\mathbf{n}}_{\mathbf{S}} \cdot \mathbf{q}} + \frac{\Lambda}{(2\pi)^2} \frac{\sqrt{\hat{\mathbf{n}}_{\mathbf{S}} \cdot \mathbf{q}}}{i\omega - v_F^* \hat{\mathbf{n}}_{\mathbf{S}} \cdot \mathbf{q}} \left(\frac{f_0}{1 + f_0 \chi_0(q)} \right) \frac{\sqrt{\hat{\mathbf{n}}_{\mathbf{T}} \cdot \mathbf{q}}}{i\omega - v_F^* \hat{\mathbf{n}}_{\mathbf{T}} \cdot \mathbf{q}} \quad (6.46)$$

In particular the in-patch boson propagator is:

$$\begin{aligned} G_B(\mathbf{S}; q) &= \frac{1}{i\omega - v_F^* \hat{\mathbf{n}}_{\mathbf{S}} \cdot \mathbf{q}} + \frac{\Lambda}{(2\pi)^2} \frac{\hat{\mathbf{n}}_{\mathbf{S}} \cdot \mathbf{q}}{(i\omega - v_F^* \hat{\mathbf{n}}_{\mathbf{S}} \cdot \mathbf{q})^2} \frac{f_0}{1 + f_0 \chi_0(q)} \\ &\approx \left[i\omega - v_F^* \hat{\mathbf{n}}_{\mathbf{S}} \cdot \mathbf{q} - \frac{\Lambda}{(2\pi)^2} (\hat{\mathbf{n}}_{\mathbf{S}} \cdot \mathbf{q}) \frac{f_0}{1 + f_0 \chi_0(q)} \right]^{-1}. \end{aligned} \quad (6.47)$$

Analytically continuing to real frequency, the longitudinal susceptibility is given by the Lindhard function:

$$\chi_0(x) = N^*(0) \left[1 - \frac{\theta(x^2 - 1)|x|}{\sqrt{x^2 - 1}} + \frac{i\theta(1 - x^2)|x|}{\sqrt{1 - x^2}} \right] \quad (6.48)$$

where $x \equiv \omega/(v_F^* |\mathbf{q}|)$. In the so-called q -limit (the limit $\omega \rightarrow 0$ is taken *before* $\mathbf{q} \rightarrow 0$ and hence the ratio $\omega/|\mathbf{q}| \rightarrow 0$) the Lindhard function has an imaginary part: $\chi_0 \approx N^*(0)[1 + i\omega/(v_F^* |\mathbf{q}|)]$. The bosons have a finite lifetime because they scatter between patches. In this limit the boson propagator is expressed most naturally in terms of the scattering amplitude $A_0 \equiv F_0/(1 + F_0)$ where as before the dimensionless coupling $F_0 \equiv N^*(0)f_0$.

$$G_B(\mathbf{S}; \mathbf{q}, \omega) = \delta_{\mathbf{S}, \mathbf{T}}^{D-1} \left\{ \omega - v_F^* \hat{\mathbf{n}}_{\mathbf{S}} \cdot \mathbf{q} \left[1 - \left(\frac{\Lambda}{2\pi k_F} \right) A_0 \right] - i \hat{\mathbf{n}}_{\mathbf{S}} \cdot \mathbf{q} A_0^2 \frac{|\omega|}{|\mathbf{q}|} \right\}^{-1} \quad (6.49)$$

The bosons have a finite lifetime, as they scatter between patches, but unlike in one dimension, the renormalization of the boson velocity due to interactions amongst the bosonized shell of excitations with energy less than $v_F^* \lambda$ is insignificant, vanishing in the $N = 2\pi k_F / \Lambda \rightarrow \infty$ limit.

To consider the effect of long range interactions, for example the Coulomb interaction $V(\mathbf{q}) = 2\pi e^2 / |\mathbf{q}|$, we simply replace the Landau coupling f_0 in equation 6.47 by the momentum-dependent interaction[43] $V(\mathbf{q})$. In the q -limit, the effective interaction $V(\mathbf{q}) / [1 + \chi_0 V(\mathbf{q})]$ is screened and the analysis given above holds. In the opposite limit, the ω -limit, the collective excitations of the interacting fermion system are given by the zeros of the boson propagator where the self-energy diverges, $\det \mathbf{K} = 0$. In particular, $\chi_0 \approx -1 / (2x^2)$ and therefore

$$\det \mathbf{K} = 1 - \frac{\pi e^2}{|\mathbf{q}|} N^*(0) \left(\frac{v_F^* |\mathbf{q}|}{\omega} \right)^2 \quad (6.50)$$

which vanishes when $\omega^2 = 2\pi e^2 n_f |\mathbf{q}| / m^*$ where $n_f \equiv k_F^2 / 4\pi$ is the density of spinless fermions. However, it is well known that the frequency of the longitudinal collective mode, the plasma frequency, should only depend on the bare mass. This requirement, known as Kohn's theorem[59], is an immediate consequence of Galilean invariance, as large numbers of electrons sloshing back and forth in response to an applied oscillating electric field carry momentum corresponding to the product of their speed multiplied by the bare electron mass. To see that Kohn's theorem holds within the bosonization scheme, recall that the effective Hamiltonian of a fermion system interacting via long range forces describes a gas of low energy excitations coupled by both long range Coulomb interactions and by short range Fermi liquid forces. For our purposes it is sufficient to set all of the Landau parameters except f_1 equal to zero. K is now a three by three matrix whose determinant is given by

$$\det \mathbf{K} = \begin{bmatrix} V(\mathbf{q})^{-1} + \chi_0, & \chi_{\ell 0}, & 0 \\ \chi_{\ell 0}, & f_1^{-1} + \chi_{\ell \ell}, & 0 \\ 0, & 0, & f_1^{-1} + \chi_{tt} \end{bmatrix} \quad (6.51)$$

where the susceptibilities are given by

$$\begin{aligned} \chi_{\ell 0}(x) &= N^*(0) \int \frac{d\theta}{2\pi} \frac{\cos^2 \theta}{\cos \theta - x} \approx -\frac{N^*(0)}{2x} \\ \chi_{\ell \ell}(x) &= N^*(0) \int \frac{d\theta}{2\pi} \frac{\cos^3 \theta}{\cos \theta - x} \approx -\frac{3N^*(0)}{8x^2} \end{aligned} \quad (6.52)$$

and

$$\chi_{tt}(x) = N^*(0) \int \frac{d\theta}{2\pi} \frac{\cos \theta \sin^2 \theta}{\cos \theta - x} \approx -\frac{N^*(0)}{8x^2} \quad (6.53)$$

the approximate expressions are given in the ω -limit. The determinant vanishes when

$$\frac{1}{V(\mathbf{q})} = -\chi_0(x) + f_1 \chi_{\ell 0}^2(x) \approx \frac{N^*(0)}{2} \left(\frac{v_F^* |\mathbf{q}|}{\omega} \right)^2 \left(1 + \frac{F_1}{2} \right), \quad (6.54)$$

but $(1 + F_1/2) = m^* / m$ and therefore the zeros are located at $\omega^2 = (2\pi e^2 n_f / m) |\mathbf{q}|$, which is the correct plasma frequency of a two dimensional Fermi liquid.

Now we can determine the quasiparticle propagator of fermions interacting via the short-range Landau interaction f_0 using:

$$G_F(\mathbf{S}; \mathbf{x}, \tau) = G_F^0(\mathbf{S}; \mathbf{x}, \tau) \exp[-\delta G_\phi(\mathbf{S}; \mathbf{x}, \tau)] . \quad (6.55)$$

In general this is a complicated procedure; but for our purposes here it is sufficient to expand in powers of δG_ϕ , as the expansion converges quickly for low fermion energies. The Fourier transform can then be taken directly,

$$G_F(\mathbf{S}; \mathbf{k}, \omega) = \sum_{\mathbf{q}} \int \frac{d\nu}{2\pi} G_F^0(\mathbf{S}; \mathbf{k} - \mathbf{q}, \omega - \nu) [\delta_{\mathbf{q},0} \delta(\nu) + \delta G_\phi(\mathbf{S}; \mathbf{q}, \nu) + \dots] \quad (6.56)$$

where

$$\delta G_\phi(\mathbf{S}; \mathbf{q}, \nu) = -\frac{1}{(i\nu - v_F^* \hat{\mathbf{n}}_{\mathbf{S}} \cdot \mathbf{q})^2} \frac{f_0}{1 + f_0 \chi_0(\mathbf{q})} . \quad (6.57)$$

If we further expand in powers of f_0 , the first order correction is purely real and leads to only an infinitesimal velocity shift to the fermion propagator. The leading contribution to the imaginary part of the fermion self-energy appears at next order,

$$\delta G_\phi(\mathbf{S}; \mathbf{q}, \nu) = \frac{f_0^2 \chi_0(\mathbf{q}, \nu)}{(i\nu - v_F^* \hat{\mathbf{n}}_{\mathbf{S}} \cdot \mathbf{q})^2} . \quad (6.58)$$

Now the only dependence of δG_ϕ on the perpendicular momentum $q_\perp \equiv \hat{\mathbf{n}}_{\mathbf{S}} \times \mathbf{q}$ is through the susceptibility $\chi_0(\mathbf{q}, \nu)$:

$$\chi_0(\mathbf{q}, \nu) = N^*(0) \left(1 - \frac{\nu \operatorname{sgn}(\nu)}{\sqrt{\nu^2 + (v_F^* q_\parallel)^2 + (v_F^* q_\perp)^2}} \right) ; \quad (6.59)$$

here, as usual, $q_\parallel \equiv \hat{\mathbf{n}}_{\mathbf{S}} \cdot \mathbf{q}$. Carrying out the integral over the perpendicular momentum in equation 6.56, and retaining only the imaginary part we find:

$$\operatorname{Im} \int_{-\lambda/2}^{\lambda/2} dq_\perp \chi_0(\mathbf{S}; \mathbf{q}, \nu) = \frac{N^*(0)}{v_F^*} \nu \operatorname{sgn}(\nu) \ln \left(\frac{q_\parallel^2 + (\nu/v_F^*)^2}{\lambda^2} \right) \quad (6.60)$$

and therefore the contribution to the quasiparticle Green's function is

$$\begin{aligned} \delta G_F(\mathbf{S}; k_\parallel, \omega) &= i \frac{f_0^2}{(2\pi)^2} \frac{N^*(0)}{v_F^*} \int_0^\omega d\nu \int_{-\lambda/2}^{\lambda/2} \frac{dq_\parallel}{2\pi} i\nu \operatorname{sgn}(\nu) \ln \left((\nu/v_F^*)^2 + q_\parallel^2 \right) \\ &\times \frac{1}{i(\nu - \omega) - v_F^*(q_\parallel - k_\parallel)} \frac{1}{(i\nu - v_F^* q_\parallel)^2} . \end{aligned} \quad (6.61)$$

The integral over q_\parallel can be carried out by complex integration and the final integral over ν evaluated exactly with the result that

$$\begin{aligned} \delta G_F(\mathbf{S}; k_\parallel, \omega) &= i \left(\frac{f_0}{2\pi} \right)^2 \frac{N^*(0)}{2(v_F^*)^2} \frac{\operatorname{sgn}(\omega)}{(v_F^* k_\parallel - i\omega)^2} \left\{ \left[(i\omega)^2 + \left(\frac{i\omega - v_F^* k_\parallel}{2} \right)^2 \right] \ln \left| \frac{i\omega - v_F^* k_\parallel}{v_F^* \lambda} \right| \right. \\ &+ \left. \left[(i\omega)^2 - \left(\frac{i\omega - v_F^* k_\parallel}{2} \right)^2 \right] \ln \left| \frac{i\omega + v_F^* k_\parallel}{v_F^* \lambda} \right| - \frac{i\omega}{2} (2i\omega - v_F^* k_\parallel) \right\} . \end{aligned} \quad (6.62)$$

Analytically continuing to real frequencies we find that the imaginary part of the fermion self-energy is given by

$$\begin{aligned} \text{Im}\Sigma_F(\mathbf{S}; k_{\parallel}, \omega) &= \left(\frac{f_0}{2\pi}\right)^2 \frac{N^*(0)}{2(v_F^*)^2} \text{sgn}(\omega) \left\{ \left[\omega^2 + \left(\frac{\omega - v_F^* k_{\parallel}}{4}\right)^2 \right] \ln \left(\frac{\omega - v_F^* k_{\parallel}}{v_F^* \lambda}\right) \right. \\ &+ \left. \left[\omega^2 - \left(\frac{\omega - v_F^* k_{\parallel}}{4}\right)^2 \right] \ln \left(\frac{\omega + v_F^* k_{\parallel}}{v_F^* \lambda}\right) - \frac{\omega}{2}(2\omega - v_F^* k_{\parallel}) \right\}. \end{aligned} \quad (6.63)$$

The appearance of the combination $\omega - v_F^* k_{\parallel}$ in the self-energy is the result of linearizing the fermion dispersion about the Fermi energy. This form is not expected to survive in detail, either within the fermionic representation[60], or perturbatively within bosonization[17, 38], when the quadratic term in the fermion dispersion is included. This is not surprising, as both the quadratic dispersion and the self-energy are equally irrelevant in the RG sense. A consistent calculation of the self-energy must retain the quadratic term.

The imaginary part of the self-energy at the quasiparticle pole is the inverse of the quasiparticle lifetime. The location of the pole has been shifted from its bare value to $\omega = v_F' k_{\parallel}$ due to renormalization of the Fermi velocity $v_F' = v_F^* [1 + \frac{\Lambda}{(2\pi k_F)} \frac{F_0}{1+F_0}]$. Note that Λ , not λ , appears in this expression because it is the patch-diagonal piece of the current-current interaction, $(f_0/V)J(\mathbf{S}; \mathbf{q})J(\mathbf{S}; -\mathbf{q})$, which is responsible for the renormalization of the velocity. As a result the imaginary part of the self-energy at the pole is given by

$$\text{Im}\Sigma_F(\mathbf{S}; k_{\parallel}, \omega) = \frac{f_0^2}{(2\pi)^2} \frac{N^*(0)}{2v_F^{*2}} \text{sgn}(\omega) \left\{ \omega^2 \ln \frac{\Lambda F_0 \omega^2}{\pi v_F^{*2} \lambda^2 k_F} - \frac{\omega^2}{2} \right\} \quad (6.64)$$

the form of which we recognize immediately from previous work on two-dimensional Fermi liquids[61, 62, 63, 64]. This quantity is always negative since $\omega^2 \ll \lambda^2 k_F / \Lambda$. Despite the dependence of the self-energy on $\ln \omega$, the weight of the quasiparticle pole, $Z_{\mathbf{k}}$, is unchanged in the $|\mathbf{k}| \rightarrow k_F$ limit. This is as expected, since as noted above short-range Fermi liquid interactions make only irrelevant contributions to the quasiparticle self-energy and do not destroy the Fermi liquid fixed point. The result is not changed if we consider the more general case of nonlocal short range interactions $f(\mathbf{S}, \mathbf{T}; \mathbf{q})$ as the additional momentum dependence only gives rise to irrelevant operators which do not change the behavior of the system.

The question remains as to whether or not singular long-range interactions can destroy Fermi liquid behavior. In fact Bares and Wen[65] have shown that for a sufficiently long-ranged interaction, logarithmic in real space, Fermi liquid behavior in two dimensions does break down. Here we show how this comes about within the bosonization framework and then discuss why Fermi liquid theory remains intact for fermions interacting via Coulomb or shorter-ranged forces. As bosonization is a nonperturbative approach which does not presuppose the form of the fermion propagator it provides a particularly appropriate framework within which to address this question.

If we consider a gas of fermions interacting via Coulomb interactions $V(\mathbf{q}) \propto e^2/|\mathbf{q}|^{D-1}$ then the correction to the boson Green's function is given by equation 6.57, slightly generalized to include momentum dependence:

$$\delta G_{\phi}(\mathbf{S}; \mathbf{q}, \omega) = \frac{V(\mathbf{q})}{1 + V(\mathbf{q})\chi_0(\mathbf{q})} \frac{1}{(i\omega - v_F^* \hat{\mathbf{n}}_{\mathbf{S}} \cdot \mathbf{q})^2} \quad (6.65)$$

In dimension greater than one, for small \mathbf{q} and small ω , with $\omega \ll |\mathbf{q}|$ screening is complete, δG_ϕ no longer depends on $V(\mathbf{q})$,

$$\delta G_\phi(\mathbf{S}; \mathbf{q}, \omega) \approx \frac{\chi_0^{-1}(q)}{(i\omega - v_F^* \hat{\mathbf{n}}_{\mathbf{S}} \cdot \mathbf{q})^2}. \quad (6.66)$$

The imaginary part of the fermion self-energy can be obtained in the manner we have described above and is given in two dimensions by

$$\text{Im}\Sigma_F(\omega)_{\text{pole}} \approx \frac{1}{(2\pi)^2 v_F^{*2} N^*(0)} \text{sgn}(\omega) \left(\omega^2 \ln \frac{2\pi\omega^2\Lambda}{v_F^{*2}\lambda^2 k_F} - \frac{\omega^2}{2} \right) \quad (6.67)$$

and in three dimensions by

$$\text{Im}\Sigma_F(\omega)_{\text{pole}} \propto \frac{\lambda}{v_F^{*2} k_F^2} \omega^2 \text{sgn}(\omega) + O(\omega^2/k_F^3) \quad (6.68)$$

in agreement with the well known results of Fermi liquid theory[11]. As in Fermi liquid theory the momentum cutoff appears in this result. In the random phase approximation (RPA) the cutoff λ is replaced by an energy of the order of the plasma frequency[66]. Azimuthal non-planar scattering processes are included in RPA, accounting for the shorter lifetime. These processes are neglected in our $D = 3$ calculation, though it should be possible to treat them perturbatively.

It is clear from this discussion that the breakdown of the Fermi liquid behavior can only be brought about, if at all, by high-energy processes for which screening is ineffective. To resolve this question we determine the equal-time fermion propagator of a gas of fermions in two dimensions interacting via the logarithmic potential $V(\mathbf{q}) = g/\mathbf{q}^2$ introduced by Bares and Wen[65]. Then

$$\delta G_\phi(\mathbf{S}; \mathbf{x}, \tau = 0) = - \sum_{|\mathbf{q}| < \lambda} (e^{i\mathbf{q}\cdot\mathbf{x}} - 1) \int_{v_F^*|\mathbf{q}|}^{v_F^*\lambda/2} \frac{d\omega}{2\pi} \frac{K_{00}^{-1}(q)}{(i\omega - v_F^* \hat{\mathbf{n}}_{\mathbf{S}} \cdot \mathbf{q})^2} \quad (6.69)$$

where

$$K_{00}^{-1}(q) = \frac{g/\mathbf{q}^2}{1 + (g/\mathbf{q}^2)\chi_0(\mathbf{q}, \omega)} \quad (6.70)$$

$\chi_0(x \gg 1) \approx N(0)/2x^2$ and therefore in the ω -limit,

$$K_{00}^{-1}(q) = -\frac{g\omega^2/\mathbf{q}^2}{(i\omega)^2 - gn_f/m}. \quad (6.71)$$

For this super long-range potential, the collective excitations of the system, plasmons, have a finite energy, given by the zeros of K_{00} , $\omega_p = \sqrt{g\frac{n_f}{m}}$. Here we have adjusted the density of states and Fermi velocity such that the plasma frequency depends on the bare mass as it should by Kohn's theorem. The cutoff λ has to be chosen such that the energy cutoff is much larger than the plasmon energy $v_F^*\lambda \gg \omega_p$. Obviously bosonization is less accurate for systems with a large plasmon gap, nevertheless we expect it to be qualitatively correct. Now since $\omega > v_F^*|\mathbf{q}|$ we may replace $(i\omega - v_F^* \hat{\mathbf{n}}_{\mathbf{S}} \cdot \mathbf{q})^2$ by ω^2 in the frequency integral and carry out

the integrations. The frequency integral gives a constant due to the plasmon pole at finite frequency. It remains to evaluate the two dimensional integral over the momentum \mathbf{q} which because of the factor of $\mathbf{q}^2 = q_{\perp}^2 + q_{\parallel}^2$ in the denominator gives rise to a logarithmic dependence on $x_{\parallel} \equiv \hat{\mathbf{n}}_{\mathbf{S}} \cdot \mathbf{x}$. To obtain the fermion quasiparticle propagator δG_{ϕ} is exponentiated and we find

$$G_F(\mathbf{S}; x_{\parallel}, \tau = 0) = \begin{cases} \frac{\Lambda}{(2\pi)^2} \frac{e^{ik_F x_{\parallel}}}{x_{\parallel}} |\lambda x_{\parallel}|^{-\zeta}, & \lambda x_{\parallel} \gg 1 \\ \frac{\Lambda}{(2\pi)^2} \frac{e^{ik_F x_{\parallel}}}{x_{\parallel}}, & \lambda x_{\parallel} \ll 1 \end{cases} \quad (6.72)$$

where the exponent ζ is given by:

$$\zeta \equiv \frac{1}{2} \sqrt{\frac{g}{\pi v_F^* k_F}}. \quad (6.73)$$

The nonanalytic dependence of G_F on x_{\parallel} reflects the destruction of the quasiparticle pole by the emission and absorption of plasmons. The power law dependence with exponent ζ is a consequence of the nonperturbative treatment of the interaction within the bosonization approach. The perturbative RPA approach in the fermion basis gave instead a logarithmic dependence on x_{\parallel} . Bares and Wen[65] then used a variational wavefunction to argue that the logarithm should be exponentiated into a power law with the same exponent as obtained above. Multidimensional bosonization obviously allows us to obtain the power law directly. As we have discussed, the appearance of an anomalous power law in the Green's function results in the elimination of the discontinuity in the quasiparticle occupancy at the Fermi surface, replacing it by a continuous but nonanalytic crossover. The quasiparticle occupancy decreases from one to zero over a momentum scale of the order of λ . The derivation of the current algebra only requires that the occupancy change over a momentum scale of the same order, providing a consistent picture. It should be noted, on the other hand, that consistency does not necessarily mean that the result is correct. For example, it is possible that the super long-ranged interaction actually induces Wigner crystallization[67]. Either way, the destruction of the Fermi liquid is complete.

It is instructive to repeat the calculation of the equal-time Green's function for the realistic case of a fermion liquid interacting via Coulomb forces in both two and three dimensions[31]. In two dimensions the plasmon frequency is proportional to $\sqrt{|\mathbf{q}|}$. In this case the integral over ω is no longer constant, as it was for the Bares and Wen potential, but rather it is proportional to $\sqrt{|\mathbf{q}|}$; as a result the momentum integral vanishes as $\sqrt{\lambda/k_F}$. In three dimensions the plasmon frequency is non-zero but the integral over \mathbf{q} is again suppressed, in this instance because of the reduced phase space at small momentum, and as a result δG_{ϕ} vanishes as λ/k_F . In each case the quasiparticle propagator has the standard Fermi liquid form. The weight at the pole undergoes no additional renormalization beyond the factor of Z_k due to integrating out the high-energy degrees of freedom, equation 2.2.

In this section we examined the effects of both short and long range longitudinal interactions on fermion liquids. We found that if the superconducting instability is suppressed then the Fermi liquid state is the ground state of a degenerate gas of fermions interacting via short-range forces, or by Coulomb forces, in either two or three dimensions. Bosonization

provides a means to go beyond an assumed Fermi liquid form for the quasiparticle propagator. Indeed had we considered fermions with spin we would have found that the bosonized Hamiltonian separates into two parts, charge and spin, leading to the possibility that, as in one dimension, the quasiparticle propagator would reflect spin charge separation. Spin charge separation would destroy the Fermi liquid, as the key element, the existence of a pole in the single particle Green's function with non-zero spectral weight, would be replaced by a branch cut. In dimension greater than one this does not occur because in the $\Lambda \rightarrow 0$ limit the location of the pole in the boson propagator is unchanged from its free value. Consequently the spin and charge velocities are equal and both degrees of freedom propagate together in the usual quasiparticle form. On the other hand, the Fermi liquid form is destroyed both in one dimension, where the ground state is a Luttinger liquid, and in the case of the superlong range interaction in two dimensions studied by Bares and Wen. The non-Fermi liquid fixed points of these two examples are accessible via bosonization.

7 Two Particle Properties: Density Response

In the previous section we discussed the single particle properties of an interacting fermion system in some detail. Here we turn to the consideration of two-particle properties, specifically the density response. We are concerned with two limits in particular, low-wavevectors, $|\mathbf{q}| \approx 0$ and high-wavevectors, $|\mathbf{q}| \approx 2k_F$.

In the low-wavevector limit we show that the classic RPA result for the density response is exact within multidimensional bosonization. In fact in early work in the fermion basis this result was anticipated by Geldart and Taylor[68]. These authors showed that, in the calculation of the density response, self-energy corrections to the fermion propagator were canceled by vertex corrections at leading order in an expansion in the Coulomb interaction. This question has been addressed most recently by Kopietz, Hermisson, and Schönhammer[37] who were able to show that, provided the quasiparticle dispersion is linear, this result holds to all orders in a loop expansion. It is not immediately obvious *a priori* that a bosonization scheme with the restriction $|\mathbf{q}| < \lambda \ll \Lambda$ can describe processes with large momentum transfer. In fact, as in one dimension, multidimensional bosonization can describe processes with either small or large momentum transfer provided they are of sufficiently low energy, $|\omega| \ll v_F^* \lambda$. To illustrate this point we determine the density response of a Fermi gas at $|\mathbf{q}| \approx 2k_F$ which, due to the sharp reduction in the phase space for low energy scattering, is nonanalytic, as was first pointed out by Kohn[69].

To begin we write the fermion density-density correlation function in the bosonic representation. The fermion density fluctuation is given by

$$\delta\rho(\mathbf{x}, \tau) = : \psi^\dagger(\mathbf{x}, \tau) \psi(\mathbf{x}, \tau) : = \sum_{\mathbf{S}\mathbf{T}} : \psi^\dagger(\mathbf{S}; \mathbf{x}, \tau) \psi(\mathbf{T}; \mathbf{x}, \tau) : \quad (7.1)$$

where the colons denote normal ordering which in this case is equivalent to subtracting the uniform background density. Then the density-density correlation function can be written as

$$\langle \delta\rho(\mathbf{x}, \tau) \delta\rho(\mathbf{0}, 0) \rangle = \frac{1}{V^2} \sum_{\mathbf{S}\mathbf{T}} \langle J(\mathbf{S}; \mathbf{x}, \tau) J(\mathbf{T}; \mathbf{0}, 0) \rangle$$

$$\begin{aligned}
& + \left(\frac{\Omega}{Va}\right)^2 \sum_{\mathbf{S} \neq \mathbf{T}, \mathbf{U} \neq \mathbf{V}} e^{i(\mathbf{k}_S - \mathbf{k}_T) \cdot \mathbf{x}} \left\langle \exp \left\{ i \frac{\sqrt{4\pi}}{\Omega} [\phi(\mathbf{S}; \mathbf{x}, \tau) - \phi(\mathbf{T}; \mathbf{x}, \tau)] \right\} \right. \\
& \times \left. \exp \left\{ i \frac{\sqrt{4\pi}}{\Omega} [\phi(\mathbf{U}; \mathbf{0}, 0) - \phi(\mathbf{V}; \mathbf{0}, 0)] \right\} \right\rangle
\end{aligned} \tag{7.2}$$

For small momentum transfer $|\mathbf{q}| < \lambda \ll k_F$ only the first term is relevant, whereas the second term is important at large momentum transfer. We separate the analysis of these two regimes in the following subsections.

7.1 Response at Small Wavevectors

Consider the density response of a free Fermi gas at long wavelength and low frequency. For free fermions, the currents in different patches are uncorrelated and the density response is given by

$$\Pi^0(\mathbf{q}, \omega) = - \sum_{\mathbf{S}} \langle J(\mathbf{S}; \mathbf{q}, \omega) J(\mathbf{S}; -\mathbf{q}, -\omega) \rangle \tag{7.3}$$

where $J(\mathbf{S}; \mathbf{q}, \omega)$ is given by equation 2.20 and therefore

$$\begin{aligned}
\sum_{\mathbf{S}} \langle J(\mathbf{S}; \mathbf{q}, \omega) J(\mathbf{S}; -\mathbf{q}, -\omega) \rangle & = \Omega \sum_{\mathbf{S}} (\mathbf{n}_S \cdot \mathbf{q}) \langle a(\mathbf{S}; \mathbf{q}) a^*(\mathbf{S}; \mathbf{q}) \rangle \\
& = - \sum_{\mathbf{S}} \frac{\hat{\mathbf{n}}_S \cdot \mathbf{q}}{i\omega - v_F^* \hat{\mathbf{n}}_S \cdot \mathbf{q}}
\end{aligned} \tag{7.4}$$

If we consider the specific case of two dimensions and recall that $\frac{\Lambda}{v_F^*(2\pi)^2} \sum_{\mathbf{S}} = N^*(0) \int \frac{d\theta}{2\pi}$ then

$$\Pi^0(\mathbf{q}, \omega) = N^*(0) \int \frac{d\theta}{2\pi} \frac{\cos \theta}{\cos \theta - x} \tag{7.5}$$

where again $x \equiv \omega/(v_F^*|\mathbf{q}|)$ and therefore

$$\Pi^0(\mathbf{q}, \omega) = N^*(0) \left(\frac{|x|}{\sqrt{x^2 - 1}} - 1 \right) = -\chi_0(\mathbf{q}, \omega) \tag{7.6}$$

which is the well known result for the density response of the free electron gas in the limit of small momentum.

Generalizing to include a long range Coulomb interaction, currents in different patches are now correlated and the correlation function written out in full reads

$$\begin{aligned}
\langle J(\mathbf{S}; q) J(\mathbf{T}; -q) \rangle & = \Omega \sqrt{(\hat{\mathbf{n}}_S \cdot \mathbf{q})(\hat{\mathbf{n}}_T \cdot \mathbf{q})} \times \left[\langle a(\mathbf{S}; q) a(\mathbf{T}; -q) \rangle \theta(\hat{\mathbf{n}}_S \cdot \mathbf{q}) \theta(-\hat{\mathbf{n}}_T \cdot \mathbf{q}) \right. \\
& + \langle a(\mathbf{S}; q) a^\dagger(\mathbf{T}; q) \rangle \theta(\hat{\mathbf{n}}_S \cdot \mathbf{q}) \theta(\hat{\mathbf{n}}_T \cdot \mathbf{q}) \\
& + \langle a^\dagger(\mathbf{S}; -q) a(\mathbf{T}; -q) \rangle \theta(-\hat{\mathbf{n}}_S \cdot \mathbf{q}) \theta(-\hat{\mathbf{n}}_T \cdot \mathbf{q}) \\
& \left. + \langle a^\dagger(\mathbf{S}; -q) a^\dagger(\mathbf{T}; q) \rangle \theta(-\hat{\mathbf{n}}_S \cdot \mathbf{q}) \theta(\hat{\mathbf{n}}_T \cdot \mathbf{q}) \right]
\end{aligned} \tag{7.7}$$

and contains contributions from all possible two point boson Green's functions. All of these functions can be obtained from the generating functional, which in this instance is given by

$$\begin{aligned}
Z[\xi, \xi^*] &= \int DA \exp \left[-\frac{1}{2} \sum_{\mathbf{q}} \int \frac{d\omega}{2\pi} \left\{ \frac{1}{V(\mathbf{q})} - 2 \sum_{\hat{\mathbf{n}}_{\mathbf{S}} \cdot \mathbf{q} > 0} \frac{\hat{\mathbf{n}}_{\mathbf{S}} \cdot \mathbf{q}}{i\omega - v_F^* \hat{\mathbf{n}}_{\mathbf{S}} \cdot \mathbf{q}} \right\} A(-q)A(q) \right] \\
&\times \exp \sum_{\mathbf{q}} \int \frac{d\omega}{2\pi} \sum_{\hat{\mathbf{n}}_{\mathbf{S}} \cdot \mathbf{q} > 0} \left[\frac{i\Omega \sqrt{\hat{\mathbf{n}}_{\mathbf{S}} \cdot \mathbf{q}}}{i\omega - v_F^* \hat{\mathbf{n}}_{\mathbf{S}} \cdot \mathbf{q}} [A(-q)\xi(\mathbf{S}; q) + A(q)\xi^*(\mathbf{S}; q)] \right. \\
&\left. - \xi^*(\mathbf{S}; q) \frac{1}{i\omega - v_F^* \hat{\mathbf{n}}_{\mathbf{S}} \cdot \mathbf{q}} \xi(\mathbf{S}; q) \right]. \tag{7.8}
\end{aligned}$$

here $A(q)$ is the longitudinal gauge field introduced to decouple the Coulomb interaction. The correlation functions in equation 7.7 are found in the usual way, for example

$$\begin{aligned}
\langle a(\mathbf{S}; q) a^\dagger(\mathbf{T}; q) \rangle &= -\frac{\delta^2 \ln Z}{\delta \xi^*(\mathbf{S}; q) \delta \xi(\mathbf{S}; q)} \Big|_{\xi = \xi^* = 0} \\
&= \frac{\Omega \sqrt{(\hat{\mathbf{n}}_{\mathbf{S}} \cdot \mathbf{q})(\hat{\mathbf{n}}_{\mathbf{T}} \cdot \mathbf{q})}}{(i\omega - v_F^* \hat{\mathbf{n}}_{\mathbf{S}} \cdot \mathbf{q})(i\omega - v_F^* \hat{\mathbf{n}}_{\mathbf{T}} \cdot \mathbf{q})} \langle A(q)A(-q) \rangle. \tag{7.9}
\end{aligned}$$

Likewise, the anomalous propagator is given by

$$\langle a(\mathbf{S}; q) a(\mathbf{T}; -q) \rangle = -\frac{\Omega \sqrt{(\hat{\mathbf{n}}_{\mathbf{S}} \cdot \mathbf{q})(\hat{\mathbf{n}}_{\mathbf{T}} \cdot \mathbf{q})}}{(i\omega - v_F^* \hat{\mathbf{n}}_{\mathbf{S}} \cdot \mathbf{q})(i\omega - v_F^* \hat{\mathbf{n}}_{\mathbf{T}} \cdot \mathbf{q})} \langle A(q)A(-q) \rangle. \tag{7.10}$$

Combining all of the terms in equation 7.7 we obtain

$$\begin{aligned}
\langle J(\mathbf{S}; \mathbf{q}, \omega) J(\mathbf{T}; -\mathbf{q}, -\omega) \rangle &= \frac{\Omega \hat{\mathbf{n}}_{\mathbf{S}} \cdot \mathbf{q}}{i\omega - v_F^* \hat{\mathbf{n}}_{\mathbf{S}} \cdot \mathbf{q}} \delta_{\mathbf{S}, \mathbf{T}}^{D-1} \\
&+ \Omega \frac{\Lambda}{(2\pi)^2} \frac{(\hat{\mathbf{n}}_{\mathbf{S}} \cdot \mathbf{q})(\hat{\mathbf{n}}_{\mathbf{T}} \cdot \mathbf{q})}{(i\omega - v_F^* \hat{\mathbf{n}}_{\mathbf{S}} \cdot \mathbf{q})(i\omega - v_F^* \hat{\mathbf{n}}_{\mathbf{T}} \cdot \mathbf{q})} \\
&\times \frac{V(\mathbf{q})}{1 - V(\mathbf{q})\Pi^0(\mathbf{q})}. \tag{7.11}
\end{aligned}$$

Then summing over \mathbf{S} and \mathbf{T} we find

$$\Pi(\mathbf{q}, \omega) = \frac{\Pi^0(\mathbf{q}, \omega)}{1 - V(\mathbf{q})\Pi^0(\mathbf{q}, \omega)}, \tag{7.12}$$

which is identical to the random phase approximation result for the density response, and is exact in the limit $\mathbf{q}, \omega \rightarrow 0$.

7.2 Response at $|\mathbf{q}| \approx 2k_F$

We have seen that bosonization successfully captures the physics of the long wavelength response of an interacting fermion system. As a further test of the formalism we consider the density response at short wavelengths, in particular around $|\mathbf{q}| = 2k_F$. At wavevectors

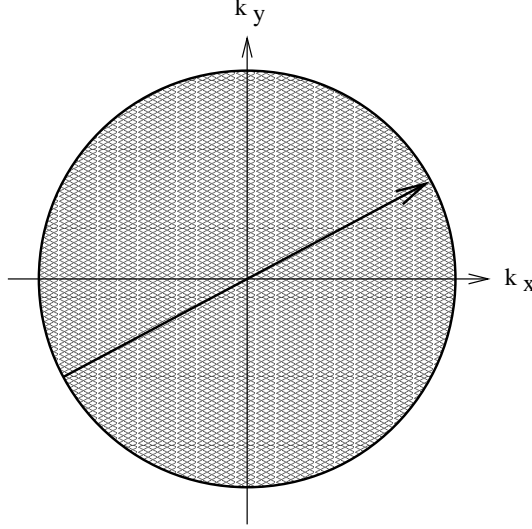

Figure 10: Wavevector of magnitude $2k_F$ just spans the Fermi surface.

greater than the spanning vector of the Fermi surface it is no longer possible to excite particle hole pairs at zero frequency; see figure 10. Consequently the density response is nonanalytic at $|\mathbf{q}| = 2k_F$, as was first pointed out by Kohn[69].

At first sight it is not obvious how large momentum transfer processes can be described within a bosonization framework with the restriction $|\mathbf{q}| < \lambda < k_F$. The reason why this is possible is made clear on noticing that scattering between patches is allowed, and that in fact the second term in equation 7.2 contains these processes explicitly; recall that anomalies in $2k_F$ scattering are described correctly by standard one dimensional bosonization[48]. Bosonization in one and higher dimensions can describe processes with either small or large momentum provided they are of low enough energy to lie inside the shell depicted in figure 4.

Since for free fermions the bosons in different patches are independent, the correlation function in the second term of equation 7.2 is zero except when $\mathbf{V} = \mathbf{S}$ and $\mathbf{U} = \mathbf{T}$ and the contribution to the density response function is given by

$$\begin{aligned} \Pi^0(\mathbf{x}, \tau) &= - \left(\frac{\Omega}{Va} \right)^2 \sum_{\mathbf{S} \neq \mathbf{T}} e^{i(\mathbf{k}_S - \mathbf{k}_T) \cdot \mathbf{x}} \left\langle e^{i \frac{\sqrt{4\pi}}{\Omega} [\phi(\mathbf{S}; \mathbf{x}, \tau) - \phi(\mathbf{T}; \mathbf{x}, \tau)]} e^{i \frac{\sqrt{4\pi}}{\Omega} [\phi(\mathbf{T}; \mathbf{0}, 0) - \phi(\mathbf{S}; \mathbf{0}, 0)]} \right\rangle \\ &= \left[\frac{\Lambda^{D-1}}{(2\pi)^D} \sum_{\mathbf{S}} \frac{e^{i\mathbf{k}_S \cdot \mathbf{x}}}{\hat{\mathbf{n}}_S \cdot \mathbf{x} + iv_F^* \tau} \right] \left[\frac{\Lambda^{D-1}}{(2\pi)^D} \sum_{\mathbf{T}} \frac{e^{-i\mathbf{k}_T \cdot \mathbf{x}}}{(\hat{\mathbf{n}}_T \cdot \mathbf{x} + iv_F^* \tau)} \right]. \end{aligned} \quad (7.13)$$

Implicit in the last line is the restriction $|\mathbf{x}_\perp| \Lambda < 1$. As we are concerned with the response at $|\mathbf{q}| \approx 2k_F$, only patches which are nearly opposite to each other on either side of the Fermi surface participate in the scattering, $\hat{\mathbf{n}}_S \approx -\hat{\mathbf{n}}_T$. Therefore we may carry out the sum over patches in each of the two terms in equation 7.13 keeping in mind that the spatial directions perpendicular to the Fermi surface normal are the same for both terms. To simplify the calculation we consider the static response, $\omega = 0$, only and specialize to the case of a circular Fermi surface in two dimensions. Integrating the density response over time τ we

obtain

$$\Pi^0(\mathbf{x}, \omega = 0) = \pi v_F^* [N^*(0)]^2 \int \frac{d\theta_1}{2\pi} \int \frac{d\theta_2}{2\pi} \frac{e^{ik_F r (\cos \theta_1 - \cos \theta_2)}}{r(\cos \theta_1 - \cos \theta_2)} [\text{sgn}(\cos \theta_1) - \text{sgn}(\cos \theta_2)] \quad (7.14)$$

where $\theta_{1,2}$ are the angles between \mathbf{x} and \mathbf{k}_S , and \mathbf{x} and \mathbf{k}_T , respectively, and $r \equiv |\mathbf{x}|$. Now we can focus on the case of $|\mathbf{q}| \approx 2k_F$ by limiting the range of integration over the angular variables $\theta_{1,2}$ to angles near $\theta_1 = 0$ and $\theta_2 = \pi$. In this limited range the cosines appearing in equation 7.14 may be expanded in a Taylor series as $\cos \theta_{1,2} = \pm(1 - \theta_{1,2}^2/2)$ and the Gaussian integral over angles can be carried out. Finally take the Fourier transform to \mathbf{q} -space. Then if θ is the angle between \mathbf{q} and \mathbf{x} , the density response function is given by

$$\Pi^0(\mathbf{q}, \omega = 0) = i \frac{[N^*(0)]^2}{2m^*} \int_0^\infty r dr \int_0^{2\pi} d\theta \frac{\exp i(2k_F - |\mathbf{q}| \cos \theta)r}{r^2}. \quad (7.15)$$

Now

$$\frac{1}{\pi} \int_0^\pi d\theta e^{-i|\mathbf{q}|r \cos \theta} = J_0(|\mathbf{q}|r) \approx \sqrt{\frac{2}{\pi|\mathbf{q}|r}} \cos(|\mathbf{q}|r - \frac{\pi}{4}), \quad |\mathbf{q}|r \gg 1 \quad (7.16)$$

and therefore

$$\Pi_{2k_F}(\mathbf{q}, \omega = 0) = i \frac{[N^*(0)]^2}{2m^*} \sqrt{\frac{\pi}{k_F}} e^{\frac{i\pi}{4}} \int_a^\infty dr \frac{\exp[i(2k_F - |\mathbf{q}|)r]}{r^{3/2}} \quad (7.17)$$

Here we have assumed $|\mathbf{q}| \approx 2k_F$ and we have also introduced the ultraviolet cutoff a to eliminate the artificial divergence at small r . Finally, asymptotic analysis of the radial integral gives the nonanalytic contribution to the density response function

$$\int_a^\infty \frac{e^{i(2k_F - |\mathbf{q}|)r}}{r^{3/2}} dr \approx -2\sqrt{\pi} i \sqrt{|\mathbf{q}| - 2k_F} \quad (7.18)$$

and therefore

$$\Pi_{2k_F}(\mathbf{q}, \omega = 0) = \begin{cases} \frac{\sqrt{2}m^*}{4\pi} \sqrt{\frac{|\mathbf{q}| - 2k_F}{2k_F}} + C, & |\mathbf{q}| > 2k_F \\ C, & |\mathbf{q}| < 2k_F. \end{cases} \quad (7.19)$$

Here C is a constant which can be determined by a more careful evaluation of the integrals in the small r region. Continuity across $|\mathbf{q}| = 2k_F$ ensures that the same constant appears in both limits of equation 7.19. The Kohn anomaly of equation 7.19 agrees precisely with that found directly in the fermion basis[70]. Repeating the calculation in $D = 3$ we show easily that the static response is given by

$$\Pi_{2k_F}(\mathbf{q}, \omega = 0) = \frac{k_F m^*}{8\pi^2} \frac{2k_F - |\mathbf{q}|}{|\mathbf{q}|} \ln \left| \frac{|\mathbf{q}| - 2k_F}{2k_F} \right| + \dots \quad (7.20)$$

Which again agrees with the exact result[69] found in the fermion basis in the limit $|\mathbf{q}| \rightarrow 2k_F$. The Kohn anomaly persists even if longitudinal interactions are included. This has already been anticipated in equations 7.19 and 7.20 where the effective mass appears rather than the bare mass.

8 The Half-Filled Landau Level

The two-dimensional electron gas in a magnetic field with even denominator Landau level filling fraction has been the subject of extensive study. For an overview see [71]. Experiments at even denominator filling point to a compressible metallic state[72, 73, 74, 75, 76] rather than the incompressible state found at odd denominator fractional filling. Furthermore, the remarkable similarity between phenomena observed at high magnetic fields near filling fraction $\nu = 1/2$, and those found for electrons in weak magnetic fields can be explained within the composite fermion framework[77]. A composite fermion is formed by attaching an even number of “statistical” flux quanta to an electron. Specifically, in the case of the half-filled Landau level, two such flux quanta are attached. Then if the statistical magnetic field due to each attached flux line is spatially averaged, the external magnetic field is effectively canceled and the composite fermions travel in zero net field. The mean-field ground state is, therefore, a filled Fermi sea with a Fermi momentum k_F larger than that of the free, unpolarized, Fermi electron gas by a factor[78] of $\sqrt{2}$ consistent with experimental observation[76].

This picture has been formalized as a Chern-Simons gauge theory by Lopez and Fradkin[79], by Kalmeyer and Zhang[80], and by Halperin, Lee, and Read[78] (HLR). In this approach the electrons are subjected to a singular gauge transformation converting them into composite fermions which interact with each other via a statistical transverse gauge field, the Chern-Simons field, in addition to the usual Coulomb or short-range interaction, and the mean-field theory is constructed. However the effect of dynamical fluctuations of the gauge field (equivalent to fluctuations in the electron density) must be addressed. In this section and in the following section we employ multidimensional bosonization in an attempt to answer this question.

The Hamiltonian for a two dimensional electron gas of density n_f in a perpendicular magnetic field B is given by

$$H[c_e^\dagger, c_e] = \frac{1}{2m} \int d^2x c_e^\dagger(\mathbf{x}) \left(\frac{\nabla}{i} + e\mathbf{A}(\mathbf{x}) \right)^2 c_e(\mathbf{x}) + H_{\text{Coulomb}}[c_e^\dagger, c_e]. \quad (8.1)$$

We have dropped the spin index as we assume that the spin of all of the electrons has been aligned parallel to the external magnetic field by the Zeeman interaction. The vector potential $\mathbf{A}(\mathbf{x})$ is due to the uniform external magnetic field \mathbf{B} which points in the \hat{z} direction normal to the plane and m is the band mass of the electrons. We use units where $c = 1$ and the electron charge is $-e$. At a value $B = 4\pi n_f/e$, half of the states in the lowest Landau level are filled. The composite-fermion theory of the half filled Landau level makes use of a local gauge transformation to describe the system as a collection of quasiparticles that obey Fermi statistics:

$$c^\dagger(\mathbf{x}) = c_e^\dagger(\mathbf{x}) \exp \left[-i\tilde{\phi} \int d^2y \arg(\mathbf{x} - \mathbf{y}) c_e^\dagger(\mathbf{y}) c_e(\mathbf{y}) \right]. \quad (8.2)$$

When $\tilde{\phi}$ is an even integer the quasiparticles are fermions. Each quasiparticle is a composite object comprising the physical electron together with a flux tube of integer $\tilde{\phi}$ quanta. The transformed Hamiltonian is given by

$$H[c^\dagger, c] = \frac{1}{2m} \int d^2x c^\dagger(\mathbf{x}) \left[\frac{\nabla}{i} + e\mathbf{A}(\mathbf{x}) - \mathbf{a}(\mathbf{x}) \right]^2 c(\mathbf{x}) \quad (8.3)$$

where

$$\mathbf{a}(\mathbf{x}) = \tilde{\phi} \int d^2y \frac{\hat{\mathbf{z}} \times (\mathbf{x} - \mathbf{y})}{|\mathbf{x} - \mathbf{y}|^2} c^\dagger(\mathbf{y})c(\mathbf{y}) \quad (8.4)$$

and

$$\nabla \times \mathbf{a}(\mathbf{x}) = 2\pi \tilde{\phi} n_f(\mathbf{x}) \quad (8.5)$$

The average field strength of the flux tubes can now be adjusted to cancel out the external magnetic field. At half filling, setting $\tilde{\phi} = 2$

$$\nabla \times [e\mathbf{A}(\mathbf{x}) - \mathbf{a}(\mathbf{x})] = e \left(B - \frac{2\pi n_f \tilde{\phi}}{e} \right) = 0. \quad (8.6)$$

Consequently at the mean field level, the quasiparticles behave as if they are free fermions in zero net field; the infinite Landau degeneracy is lifted and presumably the state is stable against two body Coulomb interactions. The important question to ask now is whether gauge fluctuations or, equivalently quasiparticle density fluctuations (equation 8.5) modify or destroy the mean field state. In the following we assume that despite strong gauge fluctuations, multidimensional bosonization is applicable. Later we verify that this assumption is correct for the case of Coulomb or longer-range interactions.

The bare action for composite fermions interacting via a Coulomb interaction and subject to the constraint, equation 8.5, can be written

$$\begin{aligned} S[c^*, c, A_\mu, \mathbf{a}] &= \int d^2x d\tau \left\{ c^*(x) \left(\frac{\partial}{\partial \tau} - iA_0(x) \right) c(x) \right. \\ &+ \frac{1}{2m} c^*(x) \left[\frac{\nabla}{i} + e\mathbf{A}(x) - \mathbf{a}(x) \right]^2 c(x) + \frac{iA_0(x)}{2\pi\hat{\phi}} [\nabla \times \mathbf{a}(x)] \left. \right\} \\ &+ \frac{1}{2} \frac{1}{(2\pi\hat{\phi})^2} \int d^2x d^2y d\tau [\nabla_{\mathbf{x}} \times \mathbf{a}(\mathbf{x}, \tau)] V(\mathbf{x} - \mathbf{y}) [\nabla_{\mathbf{y}} \times \mathbf{a}(\mathbf{y}, \tau)] \quad (8.7) \end{aligned}$$

As usual we work in the Coulomb gauge $\nabla \cdot \mathbf{a} = 0$. The next to the last term in equation 8.7 is the Chern-Simons term introduced by Lopez and Fradkin[79], by Kalmeyer and Zhang[80], and by Halperin, Lee, and Read[78] (HLR) so that the integration over A_0 enforces the constraint, equation 8.5. The last term in the action is the longitudinal Coulomb interaction which has been written in terms of the gauge field by making use of the constraint. It is important to notice that in the Chern-Simons gauge theory the longitudinal interaction plays an important role in suppressing fermion density fluctuations. Since density fluctuations are equivalent to gauge fluctuations in a Chern-Simons theory, repulsive long-range Coulomb interactions moderate and control the gauge fluctuations. As shown below, gauge fluctuations are stronger for shorter-range interactions, and in fact completely obliterate the Fermi surface. In this case multidimensional bosonization is not useful.

As before we integrate out the high-energy fermion degrees of freedom using the renormalization group. We also make the replacement $\mathbf{a} - e\mathbf{A} \rightarrow \mathbf{A}$, reflecting the fact that now we are studying fluctuations about zero net mean magnetic field. The resultant effective action reads:

$$S_{eff}[\psi^*, \psi, A_\mu] = \int d^2x d\tau \left\{ \psi^*(x) \left(\frac{\partial}{\partial \tau} - iA_0(x) \right) \psi(x) \right.$$

$$\begin{aligned}
& + \frac{1}{2m^*} \psi^*(x) \left(\frac{\nabla}{i} - \mathbf{A}(x) \right)^2 \psi(x) + i \frac{A_0(x)}{2\pi\tilde{\phi}} (\nabla \times \mathbf{A}(x)) \Big\} \\
& + \frac{1}{2} \frac{1}{(2\pi\tilde{\phi})^2} \int d^2x d^2y d\tau [\nabla_{\mathbf{x}} \times \mathbf{A}(\mathbf{x}, \tau)] V(\mathbf{x} - \mathbf{y}) [\nabla_{\mathbf{y}} \times \mathbf{A}(\mathbf{y}, \tau)] \quad (8.8)
\end{aligned}$$

At filling fraction $\nu = 1/2$ we set $\tilde{\phi} = 2$ to cancel out the external field. As stated above, \mathbf{A} should be interpreted as the fluctuation about the mean field value. The effective action can now be expressed in terms of Abelian charge currents

$$J(\mathbf{S}; \mathbf{q}, \omega) = \sqrt{\Omega |\hat{\mathbf{n}}_{\mathbf{S}} \cdot \mathbf{q}|} [a(\mathbf{S}; \mathbf{q}, \omega) \theta(\hat{\mathbf{n}}_{\mathbf{S}} \cdot \mathbf{q}) + a^*(\mathbf{S}; -\mathbf{q}, \omega) \theta(-\hat{\mathbf{n}}_{\mathbf{S}} \cdot \mathbf{q})] \quad (8.9)$$

as

$$S_{eff}[A_\mu, a] = S_G^0[A_\mu] + S[A_\mu, a] \quad (8.10)$$

where

$$\begin{aligned}
S[A_\mu, a] & = \sum_{\mathbf{q}} \sum_{\hat{\mathbf{n}}_{\mathbf{S}} \cdot \mathbf{q} > 0} \int \frac{d\omega}{2\pi} (i\omega - v_F^* \hat{\mathbf{n}}_{\mathbf{S}} \cdot \mathbf{q}) a^*(\mathbf{S}; q) a(\mathbf{S}; q) \\
& + \frac{1}{V} \sum_{\mathbf{q}} \int \frac{d\omega}{2\pi} \left\{ - \sum_{\mathbf{S}} J(\mathbf{S}; q) \left[iA_0(-q) + \frac{k_{\mathbf{S}}}{m^*} \cdot \mathbf{A}(-q) \right] \right. \\
& \left. + \frac{n_f}{2m^*} \mathbf{A}(q) \cdot \mathbf{A}(-q) \right\} , \quad (8.11)
\end{aligned}$$

and the bare gauge action can be read off from equation 8.8,

$$\begin{aligned}
S_G^0[A_\mu] & = \frac{1}{V} \sum_{\mathbf{q}} \int \frac{d\omega}{2\pi} \left\{ - \frac{1}{4\pi\tilde{\phi}} [A_0(-q) [\mathbf{q} \times \mathbf{A}(q)] - A_0(q) [\mathbf{q} \times \mathbf{A}(-q)]] \right. \\
& \left. + \frac{1}{2} \frac{\mathbf{q}^2}{(2\pi\tilde{\phi})^2} V(\mathbf{q}) \mathbf{A}(q) \cdot \mathbf{A}(-q) \right\} . \quad (8.12)
\end{aligned}$$

Fermi liquid interactions should also be included in the action[81]: If all Landau coefficients except f_1 are set equal to zero they are described by

$$S_{FL} = - \frac{f_1}{2V k_F^2} \sum_{\mathbf{S}, \mathbf{T}; \mathbf{q}} \int \frac{d\omega}{2\pi} J(\mathbf{S}; q) (\mathbf{k}_{\mathbf{S}} \cdot \mathbf{k}_{\mathbf{T}}) J(\mathbf{T}; -q) \quad (8.13)$$

which is made gauge covariant by the replacement

$$\mathbf{k} \rightarrow \frac{\nabla}{i} - \mathbf{A} . \quad (8.14)$$

As stated, for computational convenience we work in the Coulomb gauge which eliminates the longitudinal component of the vector gauge field, only the transverse component $A_T(q) \equiv \hat{\mathbf{q}} \times \mathbf{A}(q)$ remains.

Now we can determine the composite quasiparticle two point Green's function. It is important to note that the propagator for physical electrons is not the same as the propagator for the composite particles, as the physical electrons do not have attached flux[78]. The first

step as usual is to determine the boson propagator; for the moment we set the short-ranged part of the interaction, the Landau parameters generated upon integrating out the high-energy fields, to zero. We construct the generating functional and integrate out the boson fields

$$\begin{aligned}
Z[\xi, \xi^*] &= \int DA_\mu \exp -S_G[A_\mu] \\
&\times \exp \int \frac{d\omega}{2\pi} \sum_{\mathbf{q}} \sum_{\hat{\mathbf{n}}_{\mathbf{S}} \cdot \mathbf{q} > 0} \left\{ \frac{\sqrt{\Omega \hat{\mathbf{n}}_{\mathbf{S}} \cdot \mathbf{q}}}{V[i\omega - v_F^* \hat{\mathbf{n}}_{\mathbf{S}} \cdot \mathbf{q}]} [\xi(\mathbf{S}; q)[iA_0(-q) - v_F^* \sin(\theta)A_T(-q)] \right. \\
&\quad \left. + \xi^*(\mathbf{S}; q)[iA_0(q) + v_F^* \sin(\theta)A_T(q)] \right\} \\
&\times \exp - \int \frac{d\omega}{2\pi} \sum_{\mathbf{q}, \hat{\mathbf{n}}_{\mathbf{S}} \cdot \mathbf{q} > 0} \xi^*(\mathbf{S}; q) \frac{1}{i\omega - v_F^* \hat{\mathbf{n}}_{\mathbf{S}} \cdot \mathbf{q}} \xi(\mathbf{S}; q)
\end{aligned} \tag{8.15}$$

where the gauge action

$$\begin{aligned}
S_G[A_\mu] &= S_G^0[A_\mu] + \int \frac{d\omega}{2\pi} \sum_{\mathbf{q}} \sum_{\hat{\mathbf{n}}_{\mathbf{S}} \cdot \mathbf{q} > 0} \left[[iA_0(-q) - v_F^* \sin(\theta)A_T(-q)] \frac{\Omega \hat{\mathbf{n}}_{\mathbf{S}} \cdot \mathbf{q}}{i\omega - v_F^* \hat{\mathbf{n}}_{\mathbf{S}} \cdot \mathbf{q}} \right. \\
&\quad \left. \times [iA_0(q) + v_F^* \sin(\theta)A_T(q)] - \frac{n_f}{2m^*} A_T(-q)A_T(q) \right].
\end{aligned} \tag{8.16}$$

In writing equations 8.15 and 8.16 we have used the fact that

$$\begin{aligned}
\frac{\mathbf{k}_{\mathbf{S}} \cdot \mathbf{A}(q)}{m^*} &= \frac{k_F}{m^*} \hat{\mathbf{q}} \times \mathbf{A}(q) \sin \theta(\mathbf{k}_{\mathbf{S}}, \mathbf{q}) \\
&= v_F^* \sin(\theta) A_T(q)
\end{aligned} \tag{8.17}$$

where as before $\theta(\mathbf{k}_{\mathbf{S}}, \mathbf{q})$ is the angle between $\mathbf{k}_{\mathbf{S}}$ and \mathbf{q} . Now in equation 8.16 restrict the \mathbf{q} integral and let the \mathbf{S} sum run free; then we can write the gauge action as

$$S_G[A_\mu] = \frac{1}{2} \sum_{\mathbf{S}} \sum_{\hat{\mathbf{n}}_{\mathbf{S}} \cdot \mathbf{q} > 0} \int \frac{d\omega}{2\pi} A_\mu(-q) K^{\mu\nu}(q) A_\nu(q) \tag{8.18}$$

where the matrix \mathbf{K} is given by

$$\mathbf{K}(q) = \begin{pmatrix} \chi_0(q), & \frac{-|\mathbf{q}|}{2\pi\phi} \\ \frac{-|\mathbf{q}|}{2\pi\phi}, & \chi_T(q) - \frac{\mathbf{q}^2 V(\mathbf{q})}{(2\pi\phi)^2} \end{pmatrix} \tag{8.19}$$

and μ and ν are summed over $(0, T)$. Here χ_0 is the longitudinal susceptibility given by equation 6.48 and χ_T , the transverse susceptibility, is given by

$$\begin{aligned}
\chi_T(\mathbf{q}, \omega) &= v_F^{*2} N^*(0) \int \frac{d\theta \sin^2 \theta \cos \theta}{2\pi \cos \theta - x} - \frac{n_F}{m^*} \\
&= -v_F^{*2} N^*(0) [x^2 - |x| \sqrt{x^2 - 1} \theta(x^2 - 1) - i|x| \sqrt{1 - x^2} \theta(1 - x^2)];
\end{aligned} \tag{8.20}$$

as before, $x \equiv \omega/(v_F^* |\mathbf{q}|)$. Integrating out the gauge fields and differentiating the logarithm of the generating functional with respect to the source fields ξ and ξ^* we find the boson

propagator

$$G_B(\mathbf{S}, \mathbf{T}; q) = \frac{\delta_{\mathbf{S}, \mathbf{T}}}{i\omega_n - v_F^* \hat{\mathbf{n}}_{\mathbf{S}} \cdot \mathbf{q}} + \sum_{\mathbf{S}, \mathbf{T}} \frac{\sqrt{\Omega \hat{\mathbf{n}}_{\mathbf{S}} \cdot \mathbf{q}}}{i\omega - v_F^* \hat{\mathbf{n}}_{\mathbf{S}} \cdot \mathbf{q}} b_\nu^*(\mathbf{S}; \mathbf{q}) D^{\nu\mu}(q) b_\mu(\mathbf{T}; \mathbf{q}) \frac{\sqrt{\Omega \hat{\mathbf{n}}_{\mathbf{T}} \cdot \mathbf{q}}}{i\omega - v_F^* \hat{\mathbf{n}}_{\mathbf{T}} \cdot \mathbf{q}} \quad (8.21)$$

where the vector $b_\mu(\mathbf{S}; \mathbf{q})$ has components

$$\begin{aligned} b_0(\mathbf{S}; \mathbf{q}) &= 1 \\ b_T(\mathbf{S}; \mathbf{q}) &= iv_F^* \sin \theta(\mathbf{k}_{\mathbf{S}}, \mathbf{q}) \end{aligned} \quad (8.22)$$

and the gauge propagator is given by

$$D^{\nu\mu} = \langle A^\nu(-q) A^\mu(q) \rangle = (K^{-1})^{\nu\mu}. \quad (8.23)$$

In the q -limit, $\omega \ll v_F^* |\mathbf{q}|$, the gauge propagator is dominated by its transverse (T) component and

$$b_\nu^*(\mathbf{S}; \mathbf{q}) D^{\nu\mu}(q) b_\mu(\mathbf{S}; \mathbf{q}) \approx \frac{q_\perp^2}{|\mathbf{q}|^2} \frac{v_F^{*2} \chi_0(q)}{\chi_0(q) \left(\chi_T(q) - \frac{\mathbf{q}^2 V(\mathbf{q})}{(2\pi\phi)^2} \right) - \frac{\mathbf{q}^2}{(2\pi\phi)^2}}. \quad (8.24)$$

In this limit the gauge propagator has an imaginary part due to quasiparticle damping. For the Coulomb interaction, after the analytic continuation $i\omega \rightarrow \omega$,

$$b_\nu^*(\mathbf{S}; \mathbf{q}) D^{\nu\mu}(\mathbf{q}) b_\mu(\mathbf{S}; \mathbf{q}) \approx v_F^{*2} \frac{q_\perp^2}{\mathbf{q}^2} \frac{1}{i\gamma \frac{|\omega|}{|\mathbf{q}|} - \chi|\mathbf{q}|} \quad (8.25)$$

where following the notation of HLR we introduce $\gamma \equiv n_f / \pi v_F^* N(0)$, and $\chi \equiv 2\pi e^2 / (4\pi^2 \varepsilon \tilde{\phi}^2)$, where ε is the dielectric constant. The pole is located at $\omega = i(e^2 / \varepsilon k_F) |\mathbf{q}|^2$. If, on the other hand, $V(\mathbf{q})$ is a short range interaction the pole is at $\omega \propto iv_F^* |\mathbf{q}|^3 k_F^2$. The location of the pole in both instances agrees with the RPA result of HLR[78]. In the opposite limit ω -limit, $\omega \gg v_F^* |\mathbf{q}|$

$$b_\nu^*(\mathbf{S}; \mathbf{q}) D^{\nu\mu}(q) b_\mu(\mathbf{S}; \mathbf{q}) \approx \frac{\omega^2}{\mathbf{q}^2} \frac{(n_f / m^*) (2\pi\tilde{\phi})^2}{\omega^2 - (n_f / m^*)^2 2\pi\tilde{\phi}^2}. \quad (8.26)$$

In this limit, the zeros of the denominator give the characteristic frequency of the collective modes of the system, the cyclotron modes, with frequency $\omega = 2\pi\tilde{\phi} n_f / m^*$, the cyclotron frequency of a free particle of mass m^* in an external magnetic field of magnitude $B = 2\pi n_f \tilde{\phi} / e$. The correct result is obtained, as in Section 6, when the Fermi liquid interaction, equation 8.13, is included in the theory. Then the zeros shift to

$$|\omega| = \omega_c = 2\pi n_f \tilde{\phi} \left(\frac{1}{m^*} + \frac{f_1}{4\pi} \right) = 2\pi n_f \tilde{\phi} / m \quad (8.27)$$

as predicted[59]. The details of the proof of this result are given in Appendix D.

The form of equation 8.26 is similar to the corresponding result found for the super long-range interaction of Bares and Wen[65]. However since a projection onto the lowest Landau

level is implicit in the HLR theory, the cutoff must be such that $v_F^* \lambda \ll \omega_c$ to disallow inter-Landau level transitions. This restriction is an auxiliary condition in the definition the composite fermion Green's function. Non-Fermi liquid behavior, if there is such behavior, arises from the form of the gauge propagator in the opposite q -limit. Although there is no obvious small parameter we can estimate the fermion quasiparticle self-energy from equation 8.24 by expanding the fermion Green's function in powers of $D_{\mu\nu}$. Given this caveat, in the case of the Coulomb interaction, at first order in the expansion, the self-energy has the marginal Fermi liquid form in agreement with the RPA calculation of HLR[78].

As the expansion in powers of the boson propagator is unreliable instead we calculate the fermion Green's function directly from the key bosonization formula, equation 2.21. The fermion Green's function equation 6.31 is a product of the free propagator and a multiplicative factor which is the exponential of the correction to the free ϕ -boson propagator

$$G_F(\mathbf{S}; \mathbf{x}, \tau) = G_F^0(\mathbf{S}; \mathbf{x}, \tau) \exp[-\delta G_\phi(\mathbf{S}; \mathbf{x}, \tau)] \quad (8.28)$$

where

$$\delta G_\phi(\mathbf{S}; \mathbf{x}, \tau) = \sum_{\mathbf{q}} \int \frac{d\omega}{2\pi} (e^{i(\mathbf{q}\cdot\mathbf{x} - \omega\tau)} - 1) \frac{b_\nu^*(\mathbf{S}; \mathbf{q}) D^{\nu\mu}(q) b_\mu(\mathbf{S}; \mathbf{q})}{(i\omega - v_F^* \hat{\mathbf{n}}_{\mathbf{S}} \cdot \mathbf{q})^2}. \quad (8.29)$$

Setting $x_\perp = 0$, the integral over q_\parallel can be evaluated by complex integration. In the q -limit we find that

$$\delta G_\phi(\mathbf{S}; \mathbf{x}, \tau) = \frac{|x_\parallel|}{2\pi\chi} \int_0^\infty \frac{d\omega}{2\pi} e^{-\frac{\omega}{v_F^*} \text{sgn}(x_\parallel)(x_\parallel + i v_F^* \tau)} \left[\ln \left(\omega + \left(\frac{\lambda}{2} \right)^2 \frac{\chi}{\gamma} \right) - \ln \left(\omega + \left(\frac{\omega}{v_F^*} \right)^2 \frac{\chi}{\gamma} \right) \right]. \quad (8.30)$$

The final integration over frequency can be carried out using the integration formula

$$\int_0^\infty e^{-\mu x} \ln(\beta + x) dx = \frac{1}{\mu} [\ln \beta - e^{\mu\beta} E_i(-\mu\beta)], \quad (8.31)$$

where $E_i(x)$ is the exponential integral function. The result, after continuation to real time, $i\tau \rightarrow -t$, is

$$\delta G_\phi(\mathbf{S}; \mathbf{x}, t) = \frac{x_\parallel \zeta}{x_\parallel - v_F^* t} \left[\ln |(x_\parallel - v_F^* t) \delta| - e^{(x_\parallel - v_F^* t) \delta \text{sgn}(x_\parallel)} E_i[-(x_\parallel - v_F^* t) \delta \text{sgn}(x_\parallel)] + \gamma \right]. \quad (8.32)$$

Here

$$\delta \equiv \frac{e^2}{4\varepsilon v_F^* \tilde{\phi}^2} \frac{\lambda^2}{k_F} \quad (8.33)$$

is a momentum scale,

$$\zeta \equiv \frac{\tilde{\phi}^2 \varepsilon v_F^*}{2\pi e^2} \quad (8.34)$$

is a dimensionless number and $\gamma \approx 0.577216$ is Euler's constant. Making use of the asymptotic expansion of the exponential integral function $\delta G_\phi(\mathbf{S}; \mathbf{x}, t)$ reduces to

$$\delta G_\phi(\mathbf{S}; \mathbf{x}, t) = \begin{cases} \zeta |x_\parallel| \delta \ln(|x_\parallel - v_F^* t| \delta), & |x_\parallel - v_F^* t| \delta \ll 1 \\ -\zeta \frac{x_\parallel}{x_\parallel - v_F^* t} \ln(|x_\parallel - v_F^* t| \delta), & |x_\parallel - v_F^* t| \delta \gg 1. \end{cases} \quad (8.35)$$

For simplicity, first we consider the equal-time propagator which at long distances $|\hat{\mathbf{n}}_{\mathbf{S}} \cdot \mathbf{x}| \gg \delta^{-1}$ is given by

$$G_F(\mathbf{S}; \mathbf{x}) = \frac{\Lambda}{(2\pi)^2} \frac{e^{i\mathbf{k}_{\mathbf{S}} \cdot \mathbf{x}}}{\hat{\mathbf{n}}_{\mathbf{S}} \cdot \mathbf{x}} (|\hat{\mathbf{n}}_{\mathbf{S}} \cdot \mathbf{x}| \delta)^{-\zeta} \quad (8.36)$$

and at short distances $|\hat{\mathbf{n}}_{\mathbf{S}} \cdot \mathbf{x}| \ll \delta^{-1}$ by the usual Fermi liquid form

$$G_F(\mathbf{S}; \mathbf{x}) = \frac{\Lambda}{(2\pi)^2} \frac{e^{i\mathbf{k}_{\mathbf{S}} \cdot \mathbf{x}}}{\hat{\mathbf{n}}_{\mathbf{S}} \cdot \mathbf{x}}. \quad (8.37)$$

At momentum scales less than δ the quasiparticle pole is destroyed by transverse gauge interactions, suggesting that the $\nu = 1/2$ system is controlled by a non-Fermi liquid fixed point. Despite the appearance of the anomalous exponent ζ , the composite quasiparticle Green's function differs in an important way from the Green's function found in Section 6 for the super long-range interaction. It can be inferred from equation 8.36 that the composite quasiparticle occupancy drops abruptly from one to zero over a momentum scale $\delta \propto \lambda^2/k_F$ which is much less than the cut off λ , as $\lambda \rightarrow 0$. The basic consistency condition for the bosonization scheme is well satisfied in this instance.

The carrier density of a typical Ga As / Al_x Ga_{1-x} As sample is of the order of $n_f \approx 10^{11} \text{cm}^{-2}$, the electron band mass $m_b \approx 0.068m_e$, and the dielectric constant is given by $\varepsilon \approx 12.8$. The effective mass of the composite fermion quasiparticle has to be estimated. Since the electron states in the lowest Landau level are degenerate, the electron band mass does not enter. Instead the energy scale is determined by the Coulomb energy at the magnetic length scale[78, 82]. From dimensional analysis the effective mass of the quasiparticle must be therefore

$$m^* = \frac{\varepsilon}{e^2} \frac{\sqrt{4\pi n_f}}{C} \quad (8.38)$$

where C is a dimensionless constant to be determined either theoretically or from experiment. Experiments at $\nu = 1/2$ suggest[73, 74] that $m^* \approx 10m_b$ and hence $C \approx 10$. This value agrees well with the theoretical estimate of Shankar and Murthy[82]. For values in this range we find $\zeta = C\tilde{\phi}^2/2\pi \simeq 0.05$, quite small and possibly difficult to measure. For the purpose of estimating δ , we may take the cutoff λ to be of the order of the Fermi momentum, $\lambda \approx k_F$, and find $\delta = \lambda^2/(4C\tilde{\phi}^2 k_F) \approx O(k_F)$ as expected since k_F is the only physical momentum scale in the problem. Notice that the Fermi energy $\epsilon_F = k_F^2/(2m^*)$ is still much smaller than the cyclotron energy $\omega_c = k_F^2\tilde{\phi}/(2m_b)$ and hence the requirement that $v_F^*\lambda \ll \omega_c$ is respected even for $\lambda \approx k_F$.

Let us consider briefly longitudinal interactions other than Coulomb. Because longitudinal interactions control fermion density fluctuations and hence, by the constraint, gauge fluctuations, we expect repulsive interactions that have a longer range than Coulomb to stabilize the Fermi liquid fixed point. Drawing from the RG approach of Nayak and Wilczek[83] and Chakravarty, Norton, and Syljuasen[84] we set $V(\mathbf{q}) = g|\mathbf{q}|^{y-1}$, as $y = 0$ (the Coulomb case) is marginal. Repeating the calculation of the equal-time Green's function for $y \neq 0$, we find

$$\delta G_\phi(\mathbf{S}; \mathbf{x}) = \int \frac{dq_\perp}{2\pi} \int_0^{\lambda v_F^*} \frac{d\omega}{2\pi} \left(\frac{x_\parallel}{v_F^*} \right) e^{i\omega x_\parallel/v_F^*} \frac{v_F^*|q_\perp|}{i\gamma\omega - \chi|q_\perp|^{2+y}}. \quad (8.39)$$

When $y \neq 0$, the correction to the boson propagator scales as [33, 85]

$$\delta G_\phi(\mathbf{S}; \mathbf{x}) \sim (|x_\parallel| \delta')^{y/(2+y)}, \quad (8.40)$$

where

$$\delta' \equiv (\chi/v_F^* \gamma)(v_F^*/\chi)^{(2+y)/y}. \quad (8.41)$$

The same result has been obtained in the Eikonal approach of Khveshchenko and Stamp [86]. For $y < 0$, the gauge interaction is irrelevant, $\delta G_\phi \rightarrow 0$ as $|x_\parallel| \rightarrow \infty$ and the Landau fixed point is recovered. For $y > 0$, however, there are pronounced deviations from the Landau fixed point when $|\delta G_\phi| \gg 1$ or, equivalently, when $|x_\parallel| \gg (\delta')^{-1}$. The small momentum regime is controlled by a non-Fermi-liquid fixed point about which bosonization can tell us little as the deviations from Fermi-liquid behavior are too large, much larger than in the case of the longitudinal interaction of Bares and Wen discussed in the previous Section. For example, the discontinuity in the quasiparticle occupancy at the Fermi surface is completely eliminated and the formalism is not internally self consistent. The problem of a pure gauge interaction in two dimensions, considered by Lee and Nagaosa [87] and Blok and Monien [88] as a model for the cuprate superconductors, is the special case $y = 1$. Again, this system is outside the scope of multidimensional bosonization.

An important feature of the bosonization procedure is the linearization of the free fermion spectrum in the vicinity of the Fermi surface: $\epsilon_{\mathbf{k}_S + \mathbf{q}} - \epsilon_{\mathbf{k}_S} \approx \mathbf{v}_S^* \cdot \mathbf{q}$. Nonlinear terms in the dispersion due to curvature of the Fermi surface are neglected and within bosonization can only be accounted for perturbatively. This approximation may be questioned, particularly in the case of a mediating transverse gauge interaction, when the interaction vertex draws its most important contribution from q_\perp , the momentum perpendicular to \mathbf{k}_S . To see this, consider the transverse gauge propagator $D_{TT}^{-1}(q) \sim i\gamma|\omega|/|\mathbf{q}| - \chi|\mathbf{q}|^{1+y}$; the perpendicular momentum scales as $q_\perp^2 \propto |\omega|^{2/(2+y)}$ and therefore it, rather than the pole familiar from the linearized approximation, $q_\parallel = \omega/v_F^*$, dominates the physics of quasiparticle propagation for $y > 0$. The question of the reliability of multidimensional bosonization has been addressed [33] in the fermion basis by the use of the Ward identity approach derived by Castellani, Di Castro and Metzner [42]. As mentioned in Section 2 the Green's function derived using the Ward identities is identical to that found by bosonization provided that the relationship between density and current vertices, $\mathbf{\Lambda}(\mathbf{S}) = \mathbf{v}_S^* \Lambda^0(\mathbf{S})$, which becomes exact in one dimension, remains accurate in dimensions greater than one. In this context, we can ask whether deviations from this relationship are so strong that they destroy the form of the propagator found within the multidimensional bosonization approach. For the Chern-Simons gauge theory with $y < 0$, multidimensional bosonization is internally self-consistent as the quadratic parts of the dispersion cancel out and the vertex corrections are subleading [33]. The marginal case of the Coulomb interaction, $y = 0$, is delicate and must be treated with special care. Whether or not multidimensional bosonization is accurate for $y = 0$ is a question we address below.

We return now to an examination of the single particle properties of composite fermions, in particular the physically interesting case of the marginal Coulomb interaction, $y = 0$. The starting point is the single particle propagator in real time which is obtained from equation 8.35. In particular we show that the Green's function obtained from multidimensional bosonization is similar, but not identical, to the marginal Fermi liquid (MFL) form [89]. For

simplicity we set $v_F^* = 1$ and denote x_{\parallel} by x ; we also drop the prefactor of $\Lambda e^{i\mathbf{k}\cdot\mathbf{x}}/(2\pi)^2$. Then the Green's function in the two limits $|x-t|\delta \gg 1$ and $|x-t|\delta \ll 1$ can be written as

$$G_F(\mathbf{S}; \mathbf{x}, t) = \begin{cases} \frac{1}{x-t+ia \operatorname{sgn}(x)} \exp\{\zeta|x|\delta \ln|x-t|\delta\}; & |x-t|\delta \ll 1 \\ \frac{1}{x-t+ia \operatorname{sgn}(x)} \exp\left\{-\zeta \frac{x \ln|x-t|\delta}{x-t}\right\}; & |x-t|\delta \gg 1 \end{cases} \quad (8.42)$$

Ideally we would Fourier transform the Green's function directly into momentum and frequency space to extract the self-energy. Unfortunately, this task is quite difficult, so we begin with the observation that the pole of the free fermion Green's function at $x = t$ has been eliminated by the transverse interactions, because as $x \rightarrow t$, $G_F(\mathbf{S}; \mathbf{x}, t) \rightarrow |x-t|^{\zeta\delta|x|}/(x-t) \rightarrow 0$. To find where the spectral weight is concentrated, we expand the Green's function in the limit of long time: $|t| \gg |x + \zeta x \ln(|x-t|\delta)|$. Since in the long-time limit $|x/(x-t)| \ll 1$ we may expand the exponential appearing in the second line of equation 8.42 in Taylor series; keeping the leading terms we obtain

$$\begin{aligned} G_F(\mathbf{S}; \mathbf{x}, t) &= \frac{1}{x-t+ia \operatorname{sgn}(x)} \times \frac{1}{1 + \frac{\zeta x}{x-t} \ln(|x-t|\delta) + \dots} \\ &= \frac{1}{(x-t) + \zeta x \ln(|x-t|\delta) + ia \operatorname{sgn}(x)} \end{aligned} \quad (8.43)$$

where the ellipses denote higher order terms that are negligible in the $|t| \gg x$ limit. We may now Fourier transform the leading term to obtain the self-energy. If we make the approximation that near the pole in equation 8.43, $\ln(|x-t|\delta) \simeq \ln(|x|\delta)$ the integral over time can be done and

$$\begin{aligned} G_F(\mathbf{S}; \mathbf{k}, \omega) &= \int dx dt \frac{e^{i(\omega t - \mathbf{k}\cdot\mathbf{x})}}{(x-t) + \zeta x \ln(|x-t|\delta) + ia \operatorname{sgn}(x)} \\ &\approx 2\pi i \int dx [\theta(-x)\theta(\omega) - \theta(x)\theta(-\omega)] e^{i(\omega-k)x} \exp[i\zeta\omega \ln|x|\delta] \\ &= 2\pi i \int dx [\theta(-x)\theta(\omega) - \theta(x)\theta(-\omega)] e^{i(\omega-k)x} \sum_{n=0}^{\infty} \frac{[i\zeta\omega x \ln(|x|\delta)]^n}{n!}. \end{aligned} \quad (8.44)$$

Now each term coming from the Taylor-series expansion of the exponential can be integrated separately and the series resummed. It is readily shown that

$$\int_0^{\infty} dx e^{(ik-\eta)x} [x \ln(|x|\delta)]^n = \frac{-1}{(ik-\eta)^{n+1}} \left\{ n! \ln^n[(\eta-ik)/\delta] + O(\ln^{n-1}[(\eta-ik)|\delta]) \right\} \quad (8.45)$$

where $\eta > 0$ is a small term which ensures convergence. Up to subleading corrections, the Green's function is

$$\begin{aligned} G_F(\mathbf{S}; \mathbf{k}, \omega) &= \frac{2\pi}{(\omega-k)} \sum_{n=0}^{\infty} \left[\frac{\zeta\omega}{\omega-k} \ln[i(\omega-k)\operatorname{sgn}(\omega)/\delta]^n \right. \\ &= \left. \frac{2\pi}{(\omega-k) - \zeta\omega \ln[i(\omega-k)\operatorname{sgn}(\omega)/\delta]} \right] \end{aligned} \quad (8.46)$$

and hence the leading contribution to the quasiparticle self-energy is

$$\Sigma(\mathbf{S}; \mathbf{k}, \omega) = \zeta\omega \ln(|\omega - k|/\delta) + \frac{i\pi}{2}\zeta\omega \operatorname{sgn}[(\omega - k)\omega] . \quad (8.47)$$

At the pole $k \equiv \omega - \zeta\omega \ln(|\omega|/\delta)$, $w \ll k$ and to logarithmic accuracy the self-energy is given by

$$\Sigma(\mathbf{S}; \mathbf{k}, \omega) = \zeta\omega \ln(|\omega|/v_F^*\delta) - i\frac{\pi}{2}\zeta\omega \quad (8.48)$$

the marginal Fermi liquid form[89]. In equation 8.48 we have restored v_F^* . It should be emphasized that v_F^* is the Fermi velocity obtained by integrating out the high energy degrees of freedom; but in a marginal Fermi liquid such as that found here there is no definite velocity; rather the velocity is a logarithmic function of the energy scale and is of the order of, but not equal to, v_F^* . At half filling $\tilde{\phi} = 2$ and $\zeta = 2v_F^*/\pi e^2$. Upon setting $\lambda \equiv k_F$ for the purpose of estimating the size of the self-energy we find $v_F^*\delta = O(\epsilon_F)$, the Fermi energy. It should be emphasized that this result is incomplete, as the equal-time composite fermion Green's function, equation 8.36, exhibits an anomalous exponent. This equal-time behavior is subleading, however, as the Green's function decays more rapidly as a function of increasing spatial separation than at large temporal separation. The approximate self-energy calculated above, equation 8.48, captures only the long-time behavior of the Green's function.

Equation 8.48 is identical to the self-energy found by Altshuler, Ioffe, and Millis via a perturbative loop expansion[90]. These authors argue that the multi-loop contributions to the self-energy only contribute sub-leading corrections to the one-loop result. This claim is clearly at variance with the anomalous power law decay of the equal-time propagator found within multidimensional bosonization, equation 8.36. However, a recent calculation by Kopietz[91] shows that the two-loop contribution to the self-energy, $\Sigma_2(\epsilon)$, is actually more singular than the one-loop self-energy $\Sigma_1(\epsilon) \sim \epsilon^{2/(2+y)}$, casting doubt on the reliability of perturbative loop expansions. Specifically, Kopietz evaluates the two-loop Feynman diagram (see figure 11), employing bare fermion propagators with the full non-linear quasiparticle dispersion:

$$\Sigma_2(\mathbf{p}, \epsilon) = i \int \frac{d\omega d^2q}{(2\pi)^3} V_0(\mathbf{p} - \mathbf{q}; -\mathbf{q}) G_0(\mathbf{p} - \mathbf{q}, \epsilon - \omega) D_{TT}(\mathbf{q}, \omega) V_1(\mathbf{p}, \epsilon; \mathbf{q}, \omega) . \quad (8.49)$$

here G_0 is the bare fermion Green's function given, setting $v_F^* = k_F = \gamma = \chi = 1$ for simplicity, by

$$G_0(\mathbf{p}, \nu) = \frac{1}{i\nu - \frac{1}{2}(\mathbf{p}^2 - 1) + i\eta \operatorname{sgn}(\nu)} . \quad (8.50)$$

D_{TT} is the transverse gauge propagator which does not renormalize significantly[92, 93] and is therefore given by the formula obtained above using multidimensional bosonization:

$$D_{TT}(\mathbf{q}, \omega) = \frac{1}{i\frac{|\omega|}{|\mathbf{q}|} - |\mathbf{q}|^{1+y}} . \quad (8.51)$$

V_1 is the one-loop correction to the bare current vertex V_0 . Unlike V_1 , V_0 does not depend on the external frequencies, and is given simply by:

$$V_0(\mathbf{p}; \mathbf{q}) = \hat{\mathbf{q}} \times \mathbf{p} . \quad (8.52)$$

Kopietz finds that $\Sigma_2(\epsilon) \sim \epsilon^{2/(2+y)} \ln(\epsilon)$ which is bigger than $\Sigma_1(\epsilon)$ by the logarithmic factor $\ln(\epsilon)$. This result contradicts equation 8 of Reference [90].

To check the result, the one-loop correction to the current vertex has been computed numerically[94] on lattices up to size $1024 \times 1024 \times 1024$:

$$\begin{aligned} V_1(\mathbf{p}, \epsilon; \mathbf{q}, \omega) &= i \int \frac{d\omega' d^2 q'}{(2\pi)^3} G_0(\mathbf{p} - \mathbf{q} - \mathbf{q}', \epsilon - \omega - \omega') V_0(\mathbf{p} - \mathbf{q}; \mathbf{q}') \\ &\times D_{TT}(\mathbf{q}', \omega') V_0(\mathbf{p} - \mathbf{q} - \mathbf{q}'; -\mathbf{q}') G_0(\mathbf{p} - \mathbf{q}', \epsilon - \omega'). \end{aligned} \quad (8.53)$$

An important test of the numerical calculation can be performed by invoking the Ward identity. For external momentum $\mathbf{q} = 0$, the Ward identity (which reflects the conservation of the total number of particles[95, 42]) relates the one-loop vertex correction V_1 to the quasiparticle Green's function G_1 dressed with the one-loop self-energy $\Sigma_1(\epsilon) \sim \epsilon^{2/(2+y)}$:

$$V_1(\mathbf{p}, \epsilon; \mathbf{0}, \omega) = \frac{G_1^{-1}(\mathbf{p}, \epsilon) - G_1^{-1}(\mathbf{p}, \epsilon - \omega)}{\omega}. \quad (8.54)$$

The numerical results agree with this exact relation for $0 \leq y \leq 1$, demonstrating their reliability. The vertex can also be evaluated in the kinematic region relevant for the calculation of the two-loop contribution of the self-energy when the fermion propagators are dressed at one-loop order, $\Sigma_2^{(1)}$:

$$\Sigma_2^{(1)}(\mathbf{p}, \epsilon) = i \int \frac{d\omega d^2 q}{(2\pi)^3} V_0(\mathbf{p} - \mathbf{q}; -\mathbf{q}) G_1(\mathbf{p} - \mathbf{q}, \epsilon - \omega) D_{TT}(\mathbf{q}, \omega) V_1(\mathbf{p}, \epsilon; \mathbf{q}, \omega). \quad (8.55)$$

For the case of very strong gauge fluctuations, $y = 1$, the important region is given by $q_{\parallel} \sim \omega^{2/3}$ and $q_{\perp} \sim \omega^{1/3}$, the vertex correction is finite and nearly constant as a function of the gauge frequency ω :

$$V_1(\mathbf{p}, \epsilon; q_{\parallel} \sim \omega^{2/3}, q_{\perp} \sim \omega^{1/3}, \omega) \approx \text{const.} \quad (8.56)$$

If this were the whole story, it would be a self-consistent demonstration that the leading behavior of the full self-energy is given simply by the one-loop form, as stated by Altshuler, Ioffe and Millis[90] and by Stern and Halperin[96]. The Fermi liquid fixed point would be destroyed, the quasiparticle weight would vanish, and a type of Migdal theorem[97, 13] would hold as vertex corrections would make only subleading contributions. However, unlike the usual Migdal theorem where the electron mass divided by the ion mass is the small parameter which limits the size of the vertex corrections, in the gauge theory there is no obvious small parameter.

Kopietz[91] points out, however, that in the kinematic region relevant for *bare* fermion propagators, $q_{\parallel} \sim \omega$ and $q_{\perp} \sim \omega^{1/2}$, there is a contribution to the one-loop vertex correction V_1 which, in contrast to the bare vertex V_0 , changes sign under:

$$\epsilon \rightarrow -\epsilon \quad (8.57)$$

or

$$\omega \rightarrow -\omega. \quad (8.58)$$

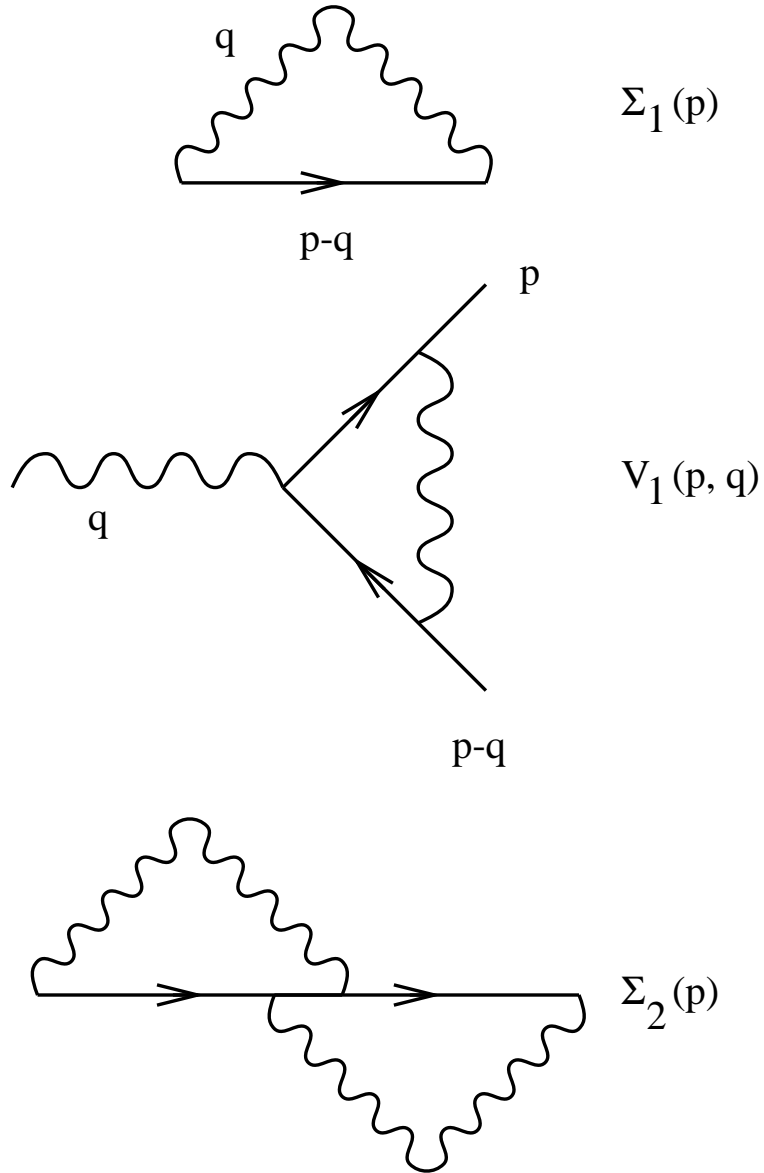

Figure 11: The one-loop contribution to the self-energy $\Sigma_1(p)$, the one-loop vertex correction $V_1(p; q)$, and the two-loop contribution to the self-energy, $\Sigma_2(p)$. The calculation of $\Sigma_2(p)$ can be broken down into two steps: first calculate $V_1(p; q)$ and then replace one of the two bare vertices V_0 which appears in $\Sigma_1(p)$ by V_1 .

This odd part of the vertex correction has the form:

$$V_1(\mathbf{p}, \epsilon; \mathbf{q}, \omega) = -c \operatorname{sgn}(\epsilon) \frac{|\epsilon|^{\frac{2}{2+y}}}{\omega} \quad (8.59)$$

where c is a constant; this behavior is found in the limit $|\omega| > |\epsilon|^{\frac{1}{2+y}}$. Numerical calculations[94] confirm the existence of this feature of the vertex, tracking the fermion energy $|\epsilon|$ as predicted. Linearization of the quasiparticle spectrum does not change the feature qualitatively. Naively equation 8.59 would appear to be a subleading correction, but, because it has a different symmetry than the bare vertex (which has no frequency dependence), Kopietz[91] finds that it makes the leading contribution to the 2-loop self-energy, at least when bare fermion propagators G_0 are used, equation 8.49. If this is correct, there is no obvious sense in which a Migdal-type theorem holds. On the other hand, it would be surprising if Fermi liquid behavior were restored, as claimed by Kopietz and Castilla[98]. In particular, it seems unlikely that the $\ln(\epsilon)$ term at two-loop order resums into a compensating power law as suggested in Reference [91]. We know that Fermi liquid behavior is **not** restored in the case of a linearized fermion spectrum, where multidimensional bosonization can be applied with confidence[99].

The form of the composite quasiparticle propagator therefore remains controversial. In any case, as the propagator is not gauge-invariant, it is unclear whether or not physical meaning can be ascribed to it. We turn now to an examination of some gauge-invariant properties.

9 Two-Particle Response of Gauge-Fermion Systems

In the previous section we focused attention exclusively on the single particle properties of the composite fermions of the Chern-Simons gauge theory. Using multidimensional bosonization we derived the composite fermion propagator which was found to have non-Fermi liquid form. However the composite fermion Green's function is not gauge invariant, and does not have a clear physical meaning. In fact it has been shown by Kim *et al.*[93] that, depending on the choice of gauge, different types of singularity appear. These same authors also used the perturbative loop expansion to study such gauge invariant quantities as the density and current response at small momentum transfer. These two particle response functions are gauge-invariant because the physical electron density, which is of course gauge-invariant, equals the composite fermion density. Kim *et al.* were able to show that the two-particle properties of the interacting gauge system are in fact Fermi liquid like: the singular corrections to the quasiparticle self-energy were canceled by singular vertex corrections, at least up to two-loop order. However the possibility of singular behavior at large momentum transfer could not be ruled out. In fact, Altshuler, Ioffe and Millis[90] have argued that the vertex correction at momentum transfer $2k_F$ should be singular since the gauge fields mediate an attractive interaction between currents moving in the same direction. In this section we use the multidimensional bosonization formalism to determine the density and current response for both small momentum transfer $|\mathbf{q}| \approx 0$ and $|\mathbf{q}| \approx 2k_F$.

The density-density correlation function is given in all generality by equation 7.2, in

particular at long wavelengths the density response is given by

$$\Pi_{00}(\mathbf{q}, \omega) = - \sum_{\mathbf{S}, \mathbf{T}} \langle J(\mathbf{S}; \mathbf{q}, \omega) J(\mathbf{T}; -\mathbf{q}, -\omega) \rangle \quad (9.1)$$

where in complete analogy to equation 7.11 the correlation function for the gauge theory can be written as

$$\begin{aligned} & \langle J(\mathbf{S}; \mathbf{q}, \omega) J(\mathbf{T}; -\mathbf{q}, -\omega) \rangle \\ = & -\Omega \left[\frac{\hat{\mathbf{n}}_{\mathbf{S}} \cdot \mathbf{q}}{i\omega - v_F^* \hat{\mathbf{n}}_{\mathbf{S}} \cdot \mathbf{q}} \delta_{\mathbf{S}, \mathbf{T}}^{D-1} \right. \\ & \left. + \frac{\Lambda}{(2\pi)^2} \frac{(\hat{\mathbf{n}}_{\mathbf{S}} \cdot \mathbf{q})(\hat{\mathbf{n}}_{\mathbf{T}} \cdot \mathbf{q})}{(i\omega - v_F^* \hat{\mathbf{n}}_{\mathbf{S}} \cdot \mathbf{q})(i\omega - v_F^* \hat{\mathbf{n}}_{\mathbf{T}} \cdot \mathbf{q})} b_\nu^*(\mathbf{S}; \mathbf{q}) D^{\nu\mu}(q) b_\mu(\mathbf{T}; \mathbf{q}) \right]. \end{aligned} \quad (9.2)$$

Recall that \mathbf{D} is the gauge field propagator, the vector $b_\nu(\mathbf{S}; \mathbf{q}) = (1, iv_F^* \frac{\mathbf{q} \times \hat{\mathbf{n}}_{\mathbf{S}}}{|\mathbf{q}|})$, and the index ν runs over $(0, T)$. Now as

$$\begin{aligned} b_\nu^*(\mathbf{S}; \mathbf{q}) D^{\nu\mu}(q) b_\mu(\mathbf{T}; \mathbf{q}) &= D_{00}(q) - iv_F^* \frac{\mathbf{q} \times \hat{\mathbf{n}}_{\mathbf{S}}}{|\mathbf{q}|} D_{T0}(q) + iv_F^* \frac{\mathbf{q} \times \hat{\mathbf{n}}_{\mathbf{T}}}{|\mathbf{q}|} D_{0T}(q) \\ &+ \frac{(\mathbf{q} \times \hat{\mathbf{n}}_{\mathbf{S}})(\mathbf{q} \times \hat{\mathbf{n}}_{\mathbf{T}})}{|\mathbf{q}|} D_{TT}(q) \end{aligned} \quad (9.3)$$

only the term proportional to D_{00} survives the summation over \mathbf{S} and \mathbf{T} and therefore

$$\Pi_{00}(\mathbf{q}, \omega) = -\chi_0(q) [1 - D_{00}(q)\chi_0(q)] \quad (9.4)$$

where

$$D_{00}(q) = \left[\chi_T(q) - \frac{\mathbf{q}^2 V(\mathbf{q})}{(2\pi\tilde{\phi})^2} \right] (\det \mathbf{K})^{-1} \quad (9.5)$$

and

$$\det \mathbf{K} = \chi_0(q) \left[\chi_T(q) - \frac{\mathbf{q}^2 V(\mathbf{q})}{(2\pi\tilde{\phi})^2} \right] - \frac{\mathbf{q}^2}{(2\pi\tilde{\phi})^2}. \quad (9.6)$$

Here χ_0 and χ_T are the longitudinal and transverse susceptibilities of the free electron gas defined in equations 6.48 and 8.20. Combining these results, the long wavelength density response can be written as

$$\Pi_{00}(\mathbf{q}, \omega) = \frac{\Pi_{00}^0(\mathbf{q}, \omega) \mathbf{q}^2 / (2\pi\tilde{\phi})^2}{\mathbf{q}^2 / (2\pi\tilde{\phi})^2 - \Pi_{00}^0(\mathbf{q}, \omega) [n_f/m^* + q^2 V(\mathbf{q}) / (2\pi\tilde{\phi})^2 - \Pi_{11}^0(\mathbf{q}, \omega)]} \quad (9.7)$$

where we have introduced the paramagnetic component of the current response

$$\chi_T(q) = \Pi_{11}^0(q) - n_f/m^* \quad (9.8)$$

and Π_{00}^0 is the density response of the free electron gas. The transverse current response can be found in a similar way

$$\Pi_{11}^0(\mathbf{q}, \omega) = \Pi_{11}^0(\mathbf{q}, \omega) \left[1 + D_{TT}(\mathbf{q}, \omega) \Pi_{11}^0(\mathbf{q}, \omega) \right] \quad (9.9)$$

where

$$D_{TT}(\mathbf{q}, \omega) = \frac{\Pi_{00}^0(\mathbf{q}, \omega)}{\mathbf{q}^2 / (2\pi\tilde{\phi})^2 - \Pi_{00}^0(\mathbf{q}, \omega)[n_f/m^* + \mathbf{q}^2 V(\mathbf{q}) / (2\pi\tilde{\phi})^2 - \Pi_{11}^0(\mathbf{q}, \omega)]}. \quad (9.10)$$

The results found here for the longitudinal and transverse response, equations 9.7 and 9.9, are identical to the results found within RPA[78]. They also agree with the leading two-loop result of Kim *et al.*[93] from which we can conclude that the cancellation between divergent vertex corrections and divergent self-energy corrections is inherent in bosonization. The zero-frequency density response, the compressibility, vanishes as

$$\Pi_{00}(\mathbf{q}, 0) \propto |\mathbf{q}|, \quad (9.11)$$

instead of $|\mathbf{q}|^2$ or faster, so the electron system at $\nu = 1/2$ is in fact compressible, a result reproduced recently within the formalism of Shankar and Murthy[82] by Halperin and Stern[100].

We now turn to consider the real space density response function in two dimensions at momentum transfer $2k_F$. With the gauge interaction, currents moving in the same direction are attracted to each other so we might anticipate nonanalytic behavior in Π_{2k_F} . This nonanalyticity has a quite different physical origin than the Kohn anomaly. The Kohn anomaly is due to the reduced availability of phase space at low energies. By contrast the behavior we expect in the present context should be apparent even if we only consider scattering between two patches at exactly opposite points on the Fermi surface. Therefore we need only consider terms with $\mathbf{k}_S = -\mathbf{k}_T$ in the $2k_F$ response function, equation 7.13.

$$\begin{aligned} \Pi_{2k_F}(\mathbf{x}, \tau) &= - \left(\frac{\Omega}{Va} \right)^2 \sum_{\mathbf{S}} \left\langle \exp \left[i \frac{\sqrt{4\pi}}{\Omega} (-\phi(\mathbf{S}; x) + \phi(-\mathbf{S}; x)) \right] \right. \\ &\quad \times \left. \exp \left[i \frac{\sqrt{4\pi}}{\Omega} (-\phi(\mathbf{S}; 0) + \phi(-\mathbf{S}; 0)) \right] \right\rangle \end{aligned} \quad (9.12)$$

which can be transformed using the generalized Baker-Hausdorff formula, equation 2.26, into

$$\begin{aligned} \Pi_{2k_F}(\mathbf{x}, \tau) &= - \left(\frac{\Omega}{Va} \right)^2 \exp - \frac{4\pi}{\Omega^2} \left([\langle \phi(\mathbf{S}; \mathbf{x}) \phi(-\mathbf{S}; 0) \rangle - \langle \phi(\mathbf{S}; 0) \phi(-\mathbf{S}; 0) \rangle] \right. \\ &\quad \left. - [\langle \phi(\mathbf{S}; \mathbf{x}) \phi(\mathbf{S}; \mathbf{0}) \rangle - \langle \phi^2(\mathbf{S}; \mathbf{0}) \rangle] + [\mathbf{S} \rightarrow -\mathbf{S}] \right) \end{aligned} \quad (9.13)$$

The correlation function connecting patches at opposite points on the Fermi surface contains the new physics; it can be expressed in terms of the canonical boson correlation functions as:

$$\begin{aligned} [\langle \phi(\mathbf{S}; x) \phi(-\mathbf{S}; 0) \rangle - \langle \phi(\mathbf{S}; 0) \phi(-\mathbf{S}; 0) \rangle] &= - \frac{\Omega}{4\pi} \sum_{\mathbf{p}, \hat{\mathbf{n}}_S \cdot \mathbf{p} > 0} \int \frac{d\omega}{2\pi} \frac{1}{|\hat{\mathbf{n}}_S \cdot \mathbf{p}|} \\ &\times \left[(e^{i(\mathbf{p} \cdot \mathbf{x} - \omega\tau)} - 1) \langle a(\mathbf{S}; p) a(-\mathbf{S}; -p) \rangle + (e^{-i(\mathbf{p} \cdot \mathbf{x} - \omega\tau)} - 1) \langle a^*(\mathbf{S}; p) a^*(-\mathbf{S}; -p) \rangle \right] \end{aligned} \quad (9.14)$$

The boson correlation functions are then determined from the generating functional equation 8.15:

$$\begin{aligned} \langle a^*(\mathbf{S}; p) a^*(-\mathbf{S}; -p) \rangle &= \frac{\Omega |\hat{\mathbf{n}}_{\mathbf{S}} \cdot \mathbf{p}|}{(v_F^* \hat{\mathbf{n}}_{\mathbf{S}} \cdot \mathbf{p})^2 - (i\omega)^2} \left[-D_{00}(p) + iv_F^* \frac{\mathbf{p} \times \hat{\mathbf{n}}_{\mathbf{S}}}{|\mathbf{p}|} (D_{0T}(p) + D_{T0}(p)) \right. \\ &\quad \left. + v_F^{*2} \left(\frac{\mathbf{p} \times \hat{\mathbf{n}}_{\mathbf{S}}}{|\mathbf{p}|} \right)^2 D_{TT}(p) \right] \end{aligned} \quad (9.15)$$

The other correlation function, $\langle a(\mathbf{S}; p) a(-\mathbf{S}; -p) \rangle$, is given by this same expression upon replacing $iv_F^* \rightarrow -iv_F^*$. Combining these results in equation 9.14 and adding the corresponding terms with $\mathbf{S} \rightarrow -\mathbf{S}$ we find that the contribution to the exponent of equation 9.13 from the interpatch correlations, $(\mathbf{S}, -\mathbf{S})$, is given by

$$\begin{aligned} & -\frac{4\pi}{\Omega^2} \{ [\langle \phi(\mathbf{S}; x) \phi(-\mathbf{S}; 0) \rangle - \langle \phi(\mathbf{S}, 0) \phi(-\mathbf{S}, 0) \rangle] + [\mathbf{S} \rightarrow -\mathbf{S}] \} \\ &= 2 \sum_{\mathbf{p}} \int \frac{d\omega}{2\pi} \frac{[e^{i(\mathbf{p} \cdot \mathbf{x} - \omega\tau)} - 1]}{\omega^2 + (v_F^* \hat{\mathbf{n}}_{\mathbf{S}} \cdot \mathbf{p})^2} \left[-D_{00}(\mathbf{p}, \omega) + \left(\frac{v_F^* p_{\perp}}{|\mathbf{p}|} \right)^2 D_{TT}(\mathbf{p}, \omega) \right] \end{aligned} \quad (9.16)$$

The contribution of the intrapatch correlations can be obtained directly from the boson propagator, equation 8.21:

$$\begin{aligned} & \frac{4\pi}{\Omega^2} [\langle \phi(\mathbf{S}; \mathbf{x}) \phi(\mathbf{S}; 0) \rangle - \langle \phi^2(\mathbf{S}; 0) \rangle] + [\mathbf{S} \rightarrow -\mathbf{S}] = \ln \frac{a^2}{(\hat{\mathbf{n}}_{\mathbf{S}} \cdot \mathbf{x} + iv_F^* \tau)(\hat{\mathbf{n}}_{\mathbf{S}} \cdot \mathbf{x} - iv_F^* \tau)} \\ & - \sum_{\mathbf{p}} \int \frac{d\omega}{2\pi} [e^{i(\mathbf{p} \cdot \mathbf{x} - \omega\tau)} - 1] \left[\frac{1}{(i\omega - v_F^* \hat{\mathbf{n}}_{\mathbf{S}} \cdot \mathbf{p})^2} + \frac{1}{(i\omega + v_F^* \hat{\mathbf{n}}_{\mathbf{S}} \cdot \mathbf{p})^2} \right] \\ & \times \left[D_{00}(\mathbf{p}, \omega) + \left(\frac{v_F^* p_{\perp}}{|\mathbf{p}|} \right)^2 D_{TT}(\mathbf{p}, \omega) \right] \end{aligned} \quad (9.17)$$

and therefore

$$\begin{aligned} \Pi_{2k_F}(\mathbf{x}, \tau) &= - \left[\frac{\Lambda}{(2\pi)^2} \right]^2 \sum'_{\mathbf{S}} \frac{1}{(\hat{\mathbf{n}}_{\mathbf{S}} \cdot \mathbf{x} + iv_F^* \tau)(\hat{\mathbf{n}}_{\mathbf{S}} \cdot \mathbf{x} - iv_F^* \tau)} \\ & \times \exp -4 \sum_{\mathbf{p}} \int \frac{d\omega}{2\pi} [e^{i(\mathbf{p} \cdot \mathbf{x} - \omega\tau)} - 1] \left[\frac{v_F^2 p_{\parallel}^2 D_{00}(p) + (i\omega)^2 \left(\frac{v_F p_{\perp}}{|\mathbf{p}|} \right)^2 D_{TT}(p)}{[(i\omega)^2 - (v_F^* \hat{\mathbf{n}}_{\mathbf{S}} \cdot \mathbf{p})^2]^2} \right] \end{aligned} \quad (9.18)$$

where the prime on the sum over patches indicates that the sum over \mathbf{S} is only over patches for which $|\mathbf{x} \times \hat{\mathbf{n}}_{\mathbf{S}}| \lambda < 1$. As in the case of the two-point function the most singular contribution comes from the p -limit, the exponent can be evaluated and we find

$$\begin{aligned} \Pi_{2k_F}(\mathbf{x}, \tau) &= - \left[\frac{\Lambda}{(2\pi)^2} \right] \sum'_{\mathbf{S}} \frac{\exp \mathcal{E}(\hat{\mathbf{n}}_{\mathbf{S}} \cdot \mathbf{x}, \tau)}{(\hat{\mathbf{n}}_{\mathbf{S}} \cdot \mathbf{x} + iv_F^* \tau)(\hat{\mathbf{n}}_{\mathbf{S}} \cdot \mathbf{x} - iv_F^* \tau)} \\ & \propto \frac{\exp \mathcal{E}(|\mathbf{x}|, \tau)}{(|\mathbf{x}| + iv_F^* \tau)(|\mathbf{x}| - iv_F^* \tau)} \end{aligned} \quad (9.19)$$

where

$$\begin{aligned} \mathcal{E}(x, \tau) \equiv & \zeta \left[\frac{x}{(x - iv_F^* \tau)} \ln |(x - iv_F^* \tau)\delta| + \frac{x}{(x + iv_F^* \tau)} \ln |(x + iv_F^* \tau)\delta| \right. \\ & \left. + \frac{1}{2} \ln^2 |(x - iv_F^* \tau)\delta| + \frac{1}{2} \ln^2 |(x + iv_F^* \tau)\delta| \right] \end{aligned} \quad (9.20)$$

for $|x - iv_F^* \tau|\delta \gg 1$ and $|x + iv_F^* \tau|\delta \gg 1$. The log-squared terms appearing in the exponent $\mathcal{E}(|x|, \tau)$ have their origin in the correlations induced by the gauge interaction between bosons in opposite hemispheres. Although it is technically difficult to Fourier transform the response function into frequency space, the leading singular behavior can be estimated by a rough scaling argument, and it is found to be

$$\Pi_{2k_F}(\omega) \propto \exp[\zeta \ln^2 |\omega/v_F^* \delta|] \quad (9.21)$$

where again $v_F^* \delta = O(\epsilon_F)$. Π_{2k_F} is strongly singular as $\omega \rightarrow 0$, in qualitative agreement with results from an exact diagonalization study[101].

10 Nested Fermi Surfaces

Understanding the cuprate superconductors, both in the normal state and in the superconducting state, is one of the most challenging problems in condensed matter physics. Many interesting phenomena emerge, especially when the hole doping is less than optimal. As the doping is decreased superconductivity is quenched and eventually the material becomes an antiferromagnetic insulator; hence in the underdoped regime the interplay between the antiferromagnetic exchange channel and the superconducting channel is likely to be important. This is the common operating assumption of spin fluctuation[102], gauge[5, 6, 103], SO(5) symmetry[104], and stripe[105] models of high-temperature superconductivity, to mention just some of the theories. Indeed since angle-resolved photoemission experiments[106] indicate that the Fermi surface of the copper-oxygen plane is nested or nearly so; it seems clear that the tendency towards antiferromagnetism must be taken into account.

The interplay between nesting, umklapp processes, and the formation of charge-density-wave (CDW), spin-density-wave (SDW), and BCS instabilities has been illustrated in a simple model of the Fermi surface which reduces the nested planes to just four Fermi points[29]. In a recent paper, Furukawa and Rice use a generalized version of this model to argue that the spin gap in the cuprate superconductors can be understood as a consequence of umklapp processes[107]. In this section, however, we retain the whole Fermi surface. Wilson's RG algorithm, which we introduced in Section 3, integrates out high-energy degrees of freedom to derive a low-energy effective theory. In degenerate fermion systems this means that we shrink successively the inner and outer sides of the momentum shell which encloses the Fermi surface[27, 108]. As in Section 3 we investigate the RG flow of the effective interactions by integrating out the high-energy modes of the bosonic field $\phi(\mathbf{S}; x)$. The advantage of the bosonized RG calculation is that the existence of well-defined quasiparticles is not assumed *a priori*. Furthermore, interaction channels which possess $U(1)_k^\infty$ symmetry can be diagonalized exactly at the outset[30].

First we introduce the prototypical low-energy model of a two-dimensional nested fermion liquid. Then multidimensional bosonization is used to incorporate the direct and exchange channels and to show that the resulting low-energy fixed point is a marginal Fermi liquid, which has obvious implications for the normal state of the cuprate superconductors[89]. Next we derive the RG equations for the BCS channel and discuss the BCS instability. An analog of the Landau theorem, here made applicable to anisotropic Fermi surfaces, is invoked. We include the marginally relevant antiferromagnetic interactions and evaluate their RG flow and their contributions to the different BCS channels. The flow in the $d_{x^2-y^2}$ -wave channel dominates the other BCS channels. This phenomena is similar to the Kohn-Luttinger effect[47, 109]. The difference here being that nesting of the Fermi surface can induce BCS instabilities at leading order, rather than at subleading order as in the Kohn-Luttinger effect, and therefore can enhance the tendency toward superconductivity.

The Hubbard model is a deceptively simple, but convenient, description of many strongly correlated fermion systems[110]. It serves as the prototype for our analysis[111]. A RG investigation of this model, of course, must take into account a realistic band structure near the Fermi surface. On a square lattice, the two-dimensional Hubbard model with nearest-neighbor hopping has a low-energy description which is complicated by several features of its anisotropic nested Fermi surface. Near half-filling, low-energy umklapp processes are permitted. The Fermi speed varies along the Fermi surface, and there are van Hove singularities in the density of states. Due to nesting, the system certainly cannot be a standard Landau Fermi liquid. The quasiparticles are expected to have a short lifetime, $\tau \sim 1/T$, and even the existence of a well-defined Fermi surface may be questioned[107, 112].

Consider the Hamiltonian of the two-dimensional Hubbard model:

$$H = -t \sum_{\langle \mathbf{x}, \mathbf{y} \rangle} c_{\mathbf{x}}^{\dagger \alpha} c_{\mathbf{y} \alpha} + U \sum_{\mathbf{x}} n_{\mathbf{x} \uparrow} n_{\mathbf{x} \downarrow} , \quad (10.1)$$

where $\langle \mathbf{x}, \mathbf{y} \rangle$ are nearest neighbors on a square lattice and U is the on-site interaction strength. We assume $|U/t| \ll 1$ so that a weak-coupling perturbative expansion is justified. Of course in real systems typically $|U/t| \gg 1$, but we assume as an operating hypothesis that the behavior at strong coupling is qualitatively the same as at weak coupling. This is equivalent to assuming that, at intermediate values of the coupling, no other fixed points intervene between the weak and strong coupling regimes. To begin, as usual, first we turn off the on-site interaction term and discuss the nature of the Fermi surface resulting from the hopping term alone. The spectrum of the fermions is

$$\epsilon(\mathbf{k}) = -2t (\cos k_x a + \cos k_y a), \quad (10.2)$$

where a is the lattice spacing, not to be confused with $1/\lambda$, the ultraviolet cutoff of multidimensional bosonization. At half-filling, due to particle-hole symmetry, the Fermi surface is the set of points in \mathbf{k} space with zero energy, and this set satisfies:

$$\cos k_x a + \cos k_y a = 0 . \quad (10.3)$$

The Fermi velocity depends on \mathbf{k} and is given, on the Fermi surface, by

$$\begin{aligned} \mathbf{v}_F(\mathbf{k}) &= 2ta (\sin k_x a, \sin k_y a) \\ &= v (\sin k_x a, \sin k_y a) \end{aligned} \quad (10.4)$$

where $v \equiv 2ta$. Van Hove singularities in the density of states occur at the four corners of the Fermi surface, $\mathbf{k} = (\pm\pi/a, 0)$ and $\mathbf{k} = (0, \pm\pi/a)$, as the Fermi velocity vanishes at those points.

Now turn the interaction U back on and perform RG transformations until the low energy scale ϵ_c is reached. Assuming that the weak interaction does not alter the shape of the Fermi surface or change the spectrum qualitatively, we may linearize the quasiparticle spectrum:

$$\epsilon(\mathbf{S}; \mathbf{q}) = v^* |\sin(\mathbf{k}_{\mathbf{S}x}a)| q_{\parallel}(\mathbf{S}) , \quad (10.5)$$

which agrees with equation 10.2 close to the Fermi surface. Here $q_{\parallel}(\mathbf{S}) \equiv \hat{\mathbf{n}}_{\mathbf{S}} \cdot (\mathbf{k} - \mathbf{k}_{\mathbf{S}})$, where as usual $\mathbf{k}_{\mathbf{S}}$ is the Fermi wavevector for patch \mathbf{S} and $\mathbf{k}_{\mathbf{S}x}$ is its x-component. This Fermi surface is difficult to bosonize since at the four corners, the van Hove points, the Fermi velocity is zero. However, away from half-filling the van Hove singularities are no longer in the low-energy zone. Therefore we introduce a simple spectrum in which the van Hove singularities are smoothed out. If we distort the four corners of the Fermi surface into four quarter-circles with a radius κ as shown in figure 10), the modified spectrum is given by:

$$\epsilon(\mathbf{S}; \mathbf{q}) = \begin{cases} v^* |\sin(\mathbf{k}_{\mathbf{S}x}a)| q_{\parallel}(\mathbf{S}), & \kappa < |\mathbf{k}_{\mathbf{S}x}| < \pi - \kappa, \\ v^* \sin(\kappa a) q_{\parallel}(\mathbf{S}), & \text{otherwise} \end{cases} \quad (10.6)$$

This is a reasonable choice because the number of states near the van Hove points is of order $\kappa a / \sin(\kappa a) \sim O(1)$, which is finite even upon taking the limit $\kappa \rightarrow 0$. The smoothed quarter-circles contain a fixed fraction of the total number of states, as do the original van Hove points. From now on we set $a = 1$ and $v^* = 1$ for convenience. Factors such as $1/a$ may be recovered whenever a comparison with other scales is needed. For example, with this convention the nesting vectors are $\mathbf{Q} = \pm(\pi, \pi)$ and $\mathbf{Q} = \pm(\pi, -\pi)$ and the density of states at the Fermi energy, $N^*(0)$, which is of order $(v^*a)^{-1}$ becomes a factor of order unity.

Now that the Fermi velocity is well-defined over the entire Fermi surface, the model can be bosonized. As before, we coarse-grain the Fermi surface with small squat boxes of width Λ along the Fermi surface and height

$$\lambda(\mathbf{S}) \equiv \frac{\epsilon_c}{v_F(\mathbf{S})} \quad (10.7)$$

normal to the Fermi surface, as shown in figure 10. The Fermi speed in patch \mathbf{S} is

$$v_F(\mathbf{S}) = \sin(\mathbf{k}_{\mathbf{S}x}) . \quad (10.8)$$

The two momentum scales Λ and $\lambda(\mathbf{S})$ are taken to be small so that the inequality $1 \gg \Lambda \gg \lambda(\mathbf{S})$ is obeyed in each patch. As we stressed in Section 2, these limits are imposed to minimize the scattering of fermions outside of the squat box to conserve the number of fermions in each patch; the $U(1)$ current algebra equation 2.11 holds in this limit. The effective action of the bosonized low-energy theory is

$$S[a^*, a] = \sum_{\mathbf{q}} \sum_{\lambda(\mathbf{S}) > \hat{\mathbf{n}}_{\mathbf{S}} \cdot \mathbf{q} > 0} \int \frac{d\omega}{2\pi} [i\omega - v_F(\mathbf{S}) \hat{\mathbf{n}}_{\mathbf{S}} \cdot \mathbf{q}] a^{*\alpha}(\mathbf{S}; q) a_{\alpha}(\mathbf{S}; q) + S_I[a^*, a] . \quad (10.9)$$

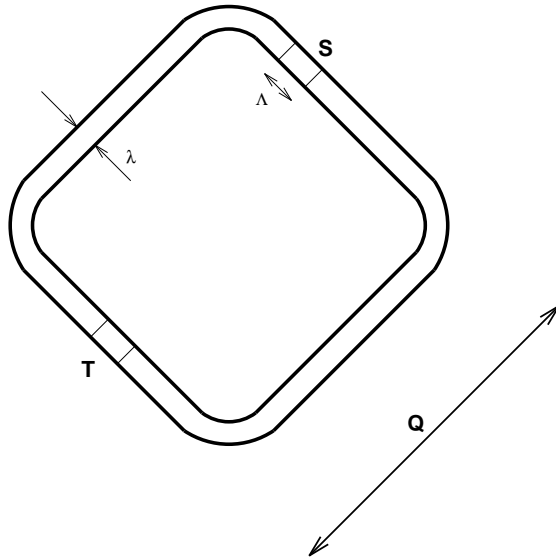

Figure 12: The low-energy effective theory in the vicinity of the Fermi surface. The faces are flat, but the Fermi speed varies along each face. The corners have been rounded out into quarter-circles of radius κ to smooth out the Van Hove singularities. The thin momentum shell is coarse-grained into squat boxes of height $\lambda(\mathbf{S})$ and width Λ . Again we require $|\mathbf{q}| < \lambda(\mathbf{S}) \ll \Lambda \ll 1/a$ for bosonization to work. Momentum \mathbf{Q} is one of four commensurate nesting vectors.

Here $a_\alpha(\mathbf{S}; q)$ and $a^{*\alpha}(\mathbf{S}; q)$ are the familiar canonical bosonic fields and S_I is the interaction term. Now consider the renormalization of the fermion interactions. As in the case of a circular Fermi surface, the marginal interactions are four-fermion (two-body) interactions, which can be verified by checking the engineering dimension. However, unlike the case of a circular Fermi surface, nesting permits additional marginal scattering channels at large momentum. In addition to the BCS instability, these channels could induce spin-density-wave (SDW) or charge-density-wave (CDW) instabilities; but first, before we discuss these logarithmically renormalized channels we must consider the forward scattering channel. We recall that, in the case of a circular Fermi surface, the interacting Fermi system with non-singular forward scattering is a Landau Fermi liquid in $D > 1$. In one dimension, however, forward scattering has a dramatic effect leading to a Luttinger liquid. Clearly the nested Fermi surface has some similarities to the one-dimensional system; it is important, therefore, to understand the effect of the forward scattering channel before the large-momentum scattering channels are included perturbatively.

For simplicity, we suppress the momentum dependence of the coupling function and drop the spin indices. Inclusion of the spin exchange channel is not expected to change the result qualitatively. The action for the forward scattering channel in the fermion basis is

$$S_{\text{fs}}[\psi^*, \psi] = -f_0 \sum_{\mathbf{S}, \mathbf{T}} \int d^2x d\tau \psi^*(\mathbf{S}; \mathbf{x}, \tau) \psi(\mathbf{S}; \mathbf{x}, \tau) \psi^*(\mathbf{T}; \mathbf{x}, \tau) \psi(\mathbf{T}; \mathbf{x}, \tau) . \quad (10.10)$$

In bosonized form it is written compactly as

$$S_{\text{fs}} = -\frac{f_0}{V} \sum_{\mathbf{S}, \mathbf{T}} \sum_{\mathbf{q}} \int \frac{d\omega}{2\pi} J(\mathbf{S}; q) J(\mathbf{T}; -q) , \quad (10.11)$$

which is clearly marginal since it is bilinear in the boson fields. Here as usual q denotes the 2+1 dimensional vector (\mathbf{q}, ω) . Focusing our attention on the fermions which lie on the nested part of the Fermi surface, since that is where the most singular behavior arises, we obtain the in-patch boson correlation function

$$\langle a(\mathbf{S}; q) a^\dagger(\mathbf{S}; q) \rangle = \frac{1}{i\omega - v_F(\mathbf{S}) \hat{\mathbf{n}}_{\mathbf{S}} \cdot \mathbf{q}} + \frac{\Lambda}{(2\pi)^2} \frac{\hat{\mathbf{n}}_{\mathbf{S}} \cdot \mathbf{q}}{(i\omega - v_F(\mathbf{S}) \hat{\mathbf{n}}_{\mathbf{S}} \cdot \mathbf{q})^2} [K_0(q)]^{-1} . \quad (10.12)$$

After analytic continuation to real frequencies,

$$\begin{aligned} K_0(q) &= \frac{1}{f_0} - \frac{2\Lambda}{(2\pi)^2} \sum_{\mathbf{S}} \frac{\theta(\hat{\mathbf{n}}_{\mathbf{S}} \cdot \mathbf{q}) \hat{\mathbf{n}}_{\mathbf{S}} \cdot \mathbf{q}}{\omega - v_F(\mathbf{S}) \hat{\mathbf{n}}_{\mathbf{S}} \cdot \mathbf{q}} \\ &= \frac{1}{f_0} + \frac{\sqrt{2}}{(2\pi)^2} \left[(2\pi)^2 \chi_0(\sin \kappa \mathbf{q}, \omega) + \chi_N(\mathbf{q}, \omega) \right] , \end{aligned} \quad (10.13)$$

where χ_N is the contribution from the flat part of the Fermi surface:

$$\begin{aligned} \chi_N(q) &= \frac{4}{\sqrt{1 - \omega^2/q_{\parallel}^2}} \ln \left[\frac{\sqrt{1 - \omega^2/q_{\parallel}^2} + \cos \kappa}{\sqrt{1 - \omega^2/q_{\parallel}^2} - \cos \kappa} \right] \\ &\quad + \frac{4}{\sqrt{1 - \omega^2/q_{\perp}^2}} \ln \left[\frac{\sqrt{1 - \omega^2/q_{\perp}^2} + \cos \kappa}{\sqrt{1 - \omega^2/q_{\perp}^2} - \cos \kappa} \right] . \end{aligned} \quad (10.14)$$

As before q_{\parallel} is the component of \mathbf{q} parallel to the Fermi surface normal $\hat{\mathbf{n}}_{\mathbf{S}}$ and q_{\perp} is the perpendicular component. The contribution to the boson correlation function from the curved part of the Fermi surface, the term proportional to χ_0 in equation 10.13, as shown in Section 6, contributes a term to the fermion self-energy, $\text{Im } \Sigma \sim \omega^2 \ln \omega$, and is therefore uninteresting.

We can estimate perturbatively the imaginary part of the quasiparticle self-energy arising from the susceptibility $\chi_N(q)$. In the limits $|q_{\parallel}| > |\omega| > |q_{\parallel}| \sin \kappa$ or $|q_{\perp}| > |\omega| > |q_{\perp}| \sin \kappa$, the susceptibility has an imaginary part. The boson correlation function then can be expanded to second order in f_0 :

$$\begin{aligned} \langle a(\mathbf{S}; q) a^\dagger(\mathbf{S}; q) \rangle &\approx \frac{i}{\omega - v_F(\mathbf{S}) \hat{\mathbf{n}}_{\mathbf{S}} \cdot \mathbf{q}} \\ &+ i \frac{\Lambda}{(2\pi)^2} \frac{\hat{\mathbf{n}}_{\mathbf{S}} \cdot \mathbf{q}}{(\omega - v_F(\mathbf{S}) \hat{\mathbf{n}}_{\mathbf{S}} \cdot \mathbf{q})^2} \left(f_0 - f_0^2 \frac{\sqrt{2}}{(2\pi)^2} \chi_N(q) \right). \end{aligned} \quad (10.15)$$

Just as for the isotropic Fermi liquid of Section 6, the first-order term in f_0 renormalizes the Fermi velocity, and the velocity correction, $\delta v = f_0 \Lambda$, is infinitesimal in the $\Lambda \rightarrow 0$ limit. Spin-charge velocity separation therefore does not occur, as can be verified easily by inclusion of the spin indices. Inserting equation 10.15 into equation 6.3, exponentiating, expanding the exponential to second order in f_0 , and finally performing a Fourier transform into (\mathbf{k}, ω) space gives the imaginary part of the quasiparticle self-energy[30], $\text{Im } \Sigma(\mathbf{k}, \omega) \approx \omega f_0^2 \Lambda$, which has the marginal Fermi liquid form[89]. Like the $D = 3$ case of a spherical Fermi surface, the prefactor Λ which appears in the self-energy obtained by bosonization is replaced by a number of order unity in an RPA calculation of the self-energy. Corrections at higher orders in f_0 can be estimated and are also consistent with the marginal Fermi liquid form, in agreement with expectations of others who found that the inverse quasiparticle lifetime, $1/\tau$, is proportional to the temperature[112]. Since the quasiparticle weight in a marginal Fermi liquid vanishes logarithmically at the Fermi surface, the Fermi liquid fixed point breaks down but the occupancy still changes rapidly enough near the Fermi surface for multidimensional bosonization to be applied.

Now we include the large-momentum scattering channels by the perturbative RG method. We can discard the forward scattering channel since we have shown that it contributes only sub-leading corrections to the RG equations. We study the RG flow of the BCS channel and derive an analog of the Landau theorem[113]. Like the circular Fermi surface, the nested Fermi surface has reflection symmetry about the origin and therefore the BCS channel flows logarithmically with decreasing energy scale. For a circular Fermi surface, the Landau theorem states that there is a BCS instability if any one of the V_ℓ is negative, where V_ℓ is the ℓ -th orbital angular momentum component of the BCS vertex function defined in equation 3.13. However, for nested Fermi surfaces, the BCS vertex is not rotationally invariant, and $V_{BCS}(\mathbf{S}, \mathbf{T})$ must be expanded in a double Fourier series[109] and the Fourier coefficients are now coupled. The RG equation for the BCS flows, equation 3.11, is also modified as the Fermi speed $v_F(\mathbf{U})$ is not uniform.

$$\frac{dV_{BCS}(\mathbf{S}, \mathbf{T})}{d \ln(s)} = - \frac{\Lambda}{(2\pi)^2} \sum_{\mathbf{U}} \frac{V_{BCS}(\mathbf{S}, \mathbf{U}) V_{BCS}(\mathbf{U}, \mathbf{T})}{v_F(\mathbf{U})}. \quad (10.16)$$

Note that the weight function $v_F(\mathbf{U})^{-1}$ now appears in the sum.

In order to analyze the RG equation, we must Fourier-decompose the BCS vertex function. The vertex function has D_4 symmetry, and there are five sets of basis functions which generate the two-dimensional function space to which it belongs. The five sets are: A_1 and A_2 (s -wave), B_1 and B_2 (d -wave), and E (p -wave)[109]. The basis functions for each set are as follows:

$$\begin{aligned}
A_1 & : \quad a_1(n, \mathbf{S}) \equiv \left[\frac{v_F(\mathbf{S})}{2\pi\sqrt{2}} \right]^{1/2} \cos(2n\mathbf{k}_{\mathbf{S}x}) , \quad a_1(0, \mathbf{S}) \equiv \left[\frac{v_F(\mathbf{S})}{4\pi\sqrt{2}} \right]^{1/2} , \\
A_2 & : \quad a_2(n, \mathbf{S}) \equiv \text{sgn}(\mathbf{k}_{\mathbf{S}y}) \left[\frac{v_F(\mathbf{S})}{2\pi\sqrt{2}} \right]^{1/2} \sin(2n\mathbf{k}_{\mathbf{S}x}) , \\
B_1 & : \quad b_1(n, \mathbf{S}) \equiv \left[\frac{v_F(\mathbf{S})}{2\pi\sqrt{2}} \right]^{1/2} \cos[(2n+1)\mathbf{k}_{\mathbf{S}x}] , \\
B_2 & : \quad b_2(n, \mathbf{S}) \equiv \text{sgn}(\mathbf{k}_{\mathbf{S}y}) \left[\frac{v_F(\mathbf{S})}{2\pi\sqrt{2}} \right]^{1/2} \sin[(2n+1)\mathbf{k}_{\mathbf{S}x}] , \\
E & : \quad e(n, \mathbf{S}) \equiv \left[\frac{v_F(\mathbf{S})}{2\pi\sqrt{2}} \right]^{1/2} \left(c_1 \sin[(n+1/2)\mathbf{k}_{\mathbf{S}x}] \right. \\
& \quad \left. + c_2 \text{sgn}(\mathbf{k}_{\mathbf{S}y}) \cos[(n+1/2)\mathbf{k}_{\mathbf{S}x}] \right) . \tag{10.17}
\end{aligned}$$

A factor of $\sqrt{v_F(\mathbf{S})}$ has been inserted to render the functions orthonormal under summation over the Fermi surface with the weight function $v_F(\mathbf{S})^{-1}$. In general the BCS vertex function can be expressed as a double Fourier expansion in terms of these orthonormal basis functions; there are no cross terms between basis functions of different symmetry:

$$\begin{aligned}
V_{BCS}(\mathbf{S}, \mathbf{T}) & = \sum_{n,m} \left\{ C_1^{nm} a_1(n, \mathbf{S}) a_1(m, \mathbf{T}) + C_2^{nm} a_2(n, \mathbf{S}) a_2(m, \mathbf{T}) \right. \\
& \quad + C_3^{nm} b_1(n, \mathbf{S}) b_1(m, \mathbf{T}) + C_4^{nm} b_2(n, \mathbf{S}) b_2(m, \mathbf{T}) \\
& \quad \left. + C_5^{nm} e(n, \mathbf{S}) e(m, \mathbf{T}) \right\} . \tag{10.18}
\end{aligned}$$

This expansion is valid as long as $v_F(\mathbf{S}) \neq 0$ which is the case for the model considered here as the Van Hove singularities have been smoothed out.

Inserting equation 10.18 into equation 10.16 the RG equations for the Fourier coefficients are found:

$$\frac{dC_i^{nm}}{d \ln(s)} = - \frac{1}{(2\pi)^2} \sum_{l=0}^{\infty} C_i^{nl} C_i^{lm} \tag{10.19}$$

where $i = 1, \dots, 5$ labels the 5 sets of coefficients. The analog of the Landau theorem for the nested fermion liquid is obtained by considering the diagonal Fourier coefficients which obey the equations

$$\frac{dC_i^{nn}}{d \ln(s)} = - \frac{1}{(2\pi)^2} \sum_{l=0}^{\infty} |C_i^{nl}|^2 . \tag{10.20}$$

The diagonal coefficients decrease as the length scale s increases, and therefore, if any one value of C_i^{nn} is negative initially, a BCS instability occurs. This sufficient condition for an

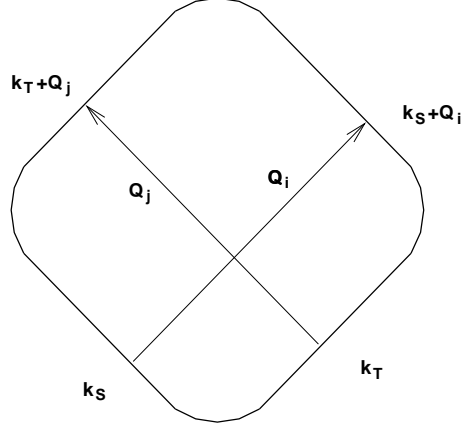

Figure 13: A typical density-wave scattering channel which is permitted because $\mathbf{Q}_i + \mathbf{Q}_j$ is a reciprocal lattice wavevector.

instability allows us to identify the possible symmetry of the resulting order parameter, since the gap function $\Delta(\mathbf{S})$ is related to the BCS vertex function as usual by:

$$\Delta(\mathbf{S}) = - \sum_{\mathbf{T}} V_{BCS}(\mathbf{S}, \mathbf{T}) \frac{\Delta(\mathbf{T})}{2E(\mathbf{k}_{\mathbf{T}})}, \quad (10.21)$$

where $E(\mathbf{k})$ is the dispersion of the low-lying quasiparticle excitations in the superconducting state.

With these criteria we can study the possibility of a BCS instability in the presence of a repulsive Hubbard- U interaction. First, we consider the RG flow of the channels generated directly by the repulsive- U interaction. We consider only those channels which flow logarithmically in length scale s , as all other channels are irrelevant. In addition to the BCS channel, there are three other classes of interaction channel which renormalize logarithmically in the presence of nesting. The first class is the CDW or SDW channel, which we denote simply by DW (density wave). In the physically relevant case of a repulsive bare Hubbard interaction, the DW channel leads to a SDW instability. However, this channel is decoupled from the BCS channel. The second and third classes are the $\mathbf{Q} = \mathbf{0}$ and the umklapp $\mathbf{Q} \neq \mathbf{0}$ repulsive exchange channels which do renormalize the BCS channel, and which therefore can induce superconducting instabilities.

Expressed in terms of the fermion fields, the action for the DW channel is:

$$\begin{aligned} S_{DW}[\psi^*, \psi] &= \frac{f_{DW}}{2} \int d\tau d^2x \sum_{\mathbf{S}, \mathbf{T}} \sum_{i=1, j=1}^4 \psi^{*\alpha}(\mathbf{S}; x) \psi_{\beta}(\mathbf{S} + \mathbf{Q}_i; x) \\ &\times \psi^{*\gamma}(\mathbf{T}; x) \psi_{\delta}(\mathbf{T} + \mathbf{Q}_j; x) [\delta_{\alpha}^{\beta} \delta_{\gamma}^{\delta} - \delta_{\gamma}^{\beta} \delta_{\alpha}^{\delta}]. \end{aligned} \quad (10.22)$$

Here \mathbf{Q}_i and \mathbf{Q}_j are two of the four nesting vectors shown in figure 13, $i, j = 1, 2, 3, 4$, and the notation $\mathbf{S} + \mathbf{Q}_i$ is shorthand for momentum $\mathbf{k}_{\mathbf{S}} + \mathbf{Q}_i$. Umklapp scattering, $\mathbf{Q}_i + \mathbf{Q}_j \neq \mathbf{0}$, is permitted because $\mathbf{Q}_i + \mathbf{Q}_j$ is a reciprocal lattice wavevector. The spin indices in equation 10.22 have been symmetrized consistent with Fermi statistics[108]. Due to nesting, this channel flows logarithmically with length scale and leads to either a CDW or a SDW

instability, depending on the sign of f_{DW} . The action can be decoupled into CDW and SDW channels,

$$S_{DW} = \frac{1}{2} \int d\tau d^2x \sum'_{\mathbf{S}, \mathbf{T}} \sum_{i=1, j=1}^4 \{f_{SDW} \vec{S}(\mathbf{S}, \mathbf{Q}_i; x) \cdot \vec{S}(\mathbf{T}, \mathbf{Q}_j; x) + f_{CDW} n(\mathbf{S}, \mathbf{Q}_i; x) n(\mathbf{T}, \mathbf{Q}_j; x)\}, \quad (10.23)$$

where

$$\vec{S}(\mathbf{S}, \mathbf{Q}_i; x) = \frac{1}{2} \psi^{*\alpha}(\mathbf{S}; x) \vec{\sigma}_\alpha^\beta \psi_\beta(\mathbf{S} + \mathbf{Q}_i; x) \quad (10.24)$$

and

$$n(\mathbf{S}, \mathbf{Q}_i; x) = \psi^{*\alpha}(\mathbf{S}; x) \psi_\alpha(\mathbf{S} + \mathbf{Q}_i; x) \quad (10.25)$$

are the spin density and the charge density, respectively. The primed summation over \mathbf{S}, \mathbf{T} indicates that the sum is only over the flat parts of the Fermi surface.

Consider the RG flow of the CDW term; for simplicity again we drop the spin indices. From the bosonization formula, equation 2.21, the bosonized form of the CDW action is

$$S_{CDW}[\phi] = \frac{f_{CDW}}{2} \frac{\Lambda^4}{(2\pi)^4} \sum'_{\mathbf{S}, \mathbf{T}} \sum_{i=1, j=1}^4 \int d\tau d^2x \frac{\lambda(\mathbf{S}) \lambda(\mathbf{T})}{4} \times \exp \left\{ i \frac{\sqrt{4\pi}}{\Omega} [\phi(\mathbf{S} + \mathbf{Q}_i; x) + \phi(\mathbf{T} + \mathbf{Q}_j; x) - \phi(\mathbf{S}; x) - \phi(\mathbf{T}; x)] \right\} \quad (10.26)$$

Under rescaling, $t \rightarrow t'/s$, $x_\parallel \rightarrow x'_\parallel/s$, and $\epsilon_c \rightarrow s\epsilon'_c$; as expected S_{CDW} is scale invariant and therefore marginal. Next the fields are split into high and low-energy modes $\phi(\mathbf{S}; x) \rightarrow \phi'(\mathbf{S}; x) + h(\mathbf{S}; x)$ where, as in Section 3, $h(\mathbf{S}; x)$ is the high-energy field with momentum in the range $\lambda'(\mathbf{S})/2 < |\mathbf{p}| < \lambda(\mathbf{S})/2$ with $\lambda'(\mathbf{S}) \equiv \epsilon'_c/v_F(\mathbf{S})$. The correlation function of the $h(\mathbf{S}; x)$ fields is given by

$$\langle h(\mathbf{S}; \mathbf{x}, \tau) h(\mathbf{T}; \mathbf{0}, 0) \rangle = \begin{cases} \delta_{\mathbf{S}, \mathbf{T}}^{D-1} \frac{\Omega^2}{4\pi} \ln \left(\frac{\hat{\mathbf{n}}_{\mathbf{S}} \cdot \mathbf{x} + i v_F(\mathbf{S}) \tau + 2is/\lambda(\mathbf{S})}{\hat{\mathbf{n}}_{\mathbf{S}} \cdot \mathbf{x} + i v_F(\mathbf{S}) \tau + 2i/\lambda(\mathbf{S})} \right), & |\hat{\mathbf{n}}_{\mathbf{S}} \times \mathbf{x}| \Lambda \ll 1 \\ 0, & |\hat{\mathbf{n}}_{\mathbf{S}} \times \mathbf{x}| \Lambda \gg 1, \end{cases} \quad (10.27)$$

similar to equation 3.6, but with explicit patch-dependence in the speed $v_F(\mathbf{S})$ and in the cutoff $\lambda(\mathbf{S})$. We then determine how the partition function renormalizes as the fast modes are integrated out:

$$\begin{aligned} \langle \exp[-S_{CDW}] \rangle &= \langle 1 - S_{CDW} + \frac{1}{2} S_{CDW}^2 + \dots \rangle \\ &= \exp[-S'_{CDW}]. \end{aligned} \quad (10.28)$$

Here the average in the brackets is taken over only the high-energy fields $h(\mathbf{S}; x)$ and S'_{CDW} is the renormalized CDW action. We evaluate $\langle S_{CDW} \rangle$ using equation 3.7 and the formula $\langle e^{ih} \rangle = e^{-(h^2/2)}$ to obtain

$$\begin{aligned} \langle S_{CDW} \rangle &= \frac{f_{CDW}}{2} \left(\frac{\Lambda}{(2\pi)^2} \right)^2 \sum'_{\mathbf{S}, \mathbf{T}} \sum_{i=1, j=1}^4 \int d\tau d^2x \frac{\lambda(\mathbf{S}) \lambda(\mathbf{T})}{4s^2} \\ &\times \exp \left\{ i \frac{\sqrt{4\pi}}{\Omega} [\phi'(\mathbf{S} + \mathbf{Q}_i; x) + \phi'(\mathbf{T} + \mathbf{Q}_j; x) - \phi'(\mathbf{S}; x) - \phi'(\mathbf{T}; x)] \right\} \end{aligned} \quad (10.29)$$

Replacing $\lambda(\mathbf{S})$ with $s\lambda'(\mathbf{S})$ [$\lambda'(\mathbf{S})$ is the new momentum cutoff] and $\phi' \rightarrow \phi$ we recover equation 10.26 with the new cutoff. The third term on the right hand side of equation 10.28 gives the second order correction to S_{CDW} . Using the relation $\langle e^A e^B \rangle = e^{\langle AB + (A^2 + B^2)/2 \rangle}$ and equation 10.27, we find

$$\begin{aligned}
& \frac{1}{2} [\langle S_{CDW}^2 \rangle - \langle S_{CDW} \rangle^2] = \frac{f_{CDW}^2}{2} \left[\frac{\Lambda}{(2\pi)^2} \right]^4 \sum'_{\mathbf{S}, \mathbf{T}, \mathbf{U}} \sum'_{i,j,l} \int d\tau d^2x \frac{\lambda(\mathbf{S}) \lambda(\mathbf{T}) \lambda^2(\mathbf{U})}{16s^4} \\
& \times \exp \left\{ i \frac{\sqrt{4\pi}}{\Omega} [\phi'(\mathbf{S} + \mathbf{Q}_i; x) + \phi'(\mathbf{T} + \mathbf{Q}_j; x) - \phi'(\mathbf{k}; x) - \phi'(\mathbf{T}; x)] \right\} \\
& \times \int d\sigma d^2y \exp \left\{ \frac{4\pi}{\Omega^2} [\langle h(\mathbf{U}; \mathbf{y}, \sigma) h(\mathbf{U}; \mathbf{0}, 0) \rangle + \langle h(\mathbf{U} + \mathbf{Q}_i; \mathbf{y}, \sigma) h(\mathbf{U} + \mathbf{Q}_i; \mathbf{0}, 0) \rangle] \right\} \\
& + \text{subleading terms} \\
& \approx \frac{f_{CDW}^2}{2} \left[\frac{\Lambda}{(2\pi)^2} \right]^4 \sum'_{\mathbf{S}, \mathbf{T}} \sum_{i=1, j=1}^4 \int d\tau d^2x \sum'_{\mathbf{U}} \frac{\lambda^2(\mathbf{U})}{4s^2} \frac{2\pi}{\Lambda} \int d\sigma d(\hat{\mathbf{n}}_{\mathbf{U}} \cdot \mathbf{y}) \frac{4s^2/\lambda^2(\mathbf{U})}{[v_F(\mathbf{U})\sigma]^2 + (\hat{\mathbf{n}}_{\mathbf{U}} \cdot \mathbf{y})^2} \\
& \times \frac{\lambda(\mathbf{S}) \lambda(\mathbf{T})}{4s^2} \exp \left\{ i \frac{\sqrt{4\pi}}{\Omega} [\phi'(\mathbf{S} + \mathbf{Q}_i; x) + \phi'(\mathbf{T} + \mathbf{Q}_j; x) - \phi'(\mathbf{S}; x) - \phi'(\mathbf{T}; x)] \right\} \\
& + \text{subleading terms} . \tag{10.30}
\end{aligned}$$

Performing the integrals over $\hat{\mathbf{n}}_{\mathbf{U}} \cdot \mathbf{y}$ and σ , we obtain the RG equation for the CDW coupling function

$$\frac{df_{CDW}(s)}{d \ln(s)} = - \frac{\Lambda}{2(2\pi)^2} \sum'_{\mathbf{U}} \frac{1}{v_F(\mathbf{U})} f_{CDW}^2(s) . \tag{10.31}$$

This channel is unstable if f_{CDW} is negative, which is the case for a bare attractive interaction, $U < 0$, leading to charge-density ordering at wavevector (π, π) or $(\pi, -\pi)$.

Similarly, a RG transformation can be performed to find the flow equation in the SDW channel yielding

$$\frac{df_{SDW}(s)}{d \ln(s)} = - \frac{\Lambda}{(2\pi)^2} \sum'_{\mathbf{U}} \frac{1}{v_F(\mathbf{U})} f_{SDW}^2(s) . \tag{10.32}$$

There is an instability if $f_{SDW} < 0$, which corresponds to a bare repulsive interaction $U > 0$. The SDW instability leads to antiferromagnetic spin-density ordering, also with wavevectors (π, π) and $(\pi, -\pi)$ as the repulsive interaction induces an antiferromagnetic exchange interaction. We can determine easily the energy scale of the SDW instability. Integrating equation 10.32, we obtain the critical energy at which the SDW instability occurs by equating it to the energy scale at which the coupling constant f_{SDW} grows to be of order one:

$$E_{SDW} \sim E_F \exp \left[- \frac{1}{\frac{8\sqrt{2}}{(2\pi)^2} \ln \frac{2}{\epsilon_c} |f_{SDW}|} \right] . \tag{10.33}$$

Now we can examine the overlap between the BCS and the DW channels. In figure 14 we show a typical scattering process belonging to both channels. The contribution of these processes to the action can be written in terms of the BCS vertex function and the fermion fields as:

$$S_{\text{overlap}} = \sum_{\mathbf{S}, \mathbf{T}} \int d\tau d^2x V_{BCS}(\mathbf{S}, \mathbf{T}) \psi^{*\alpha}(\mathbf{S}; x) \psi^{*\beta}(-\mathbf{S}; x) \psi_{\beta}(-\mathbf{T}; x) \psi_{\alpha}(\mathbf{T}; x) \delta_{\mathbf{T}, \mathbf{S} + \mathbf{Q}}^2 . \tag{10.34}$$

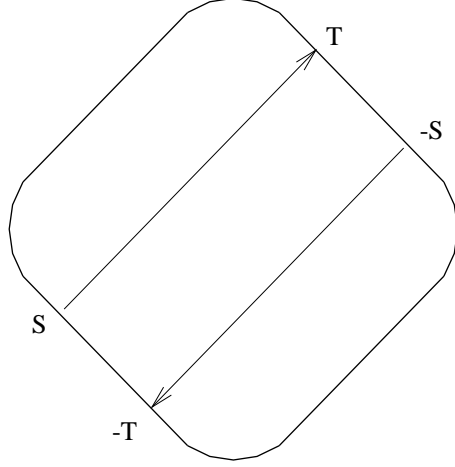

Figure 14: A typical overlap between density-wave and BCS channels.

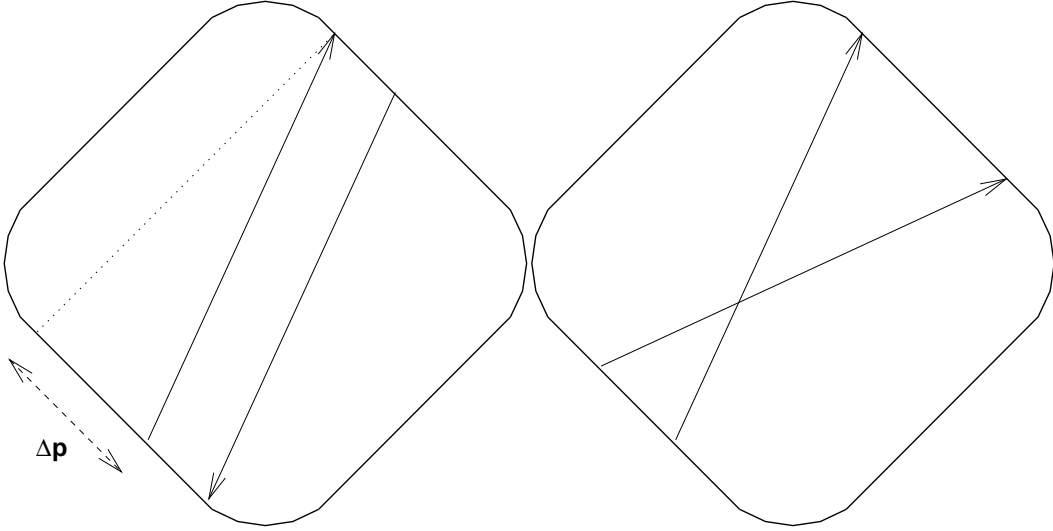

Figure 15: (a) An exchange channel with zero momentum transfer which logarithmically renormalizes the BCS channel. (b) Same, but with momentum transfer $2\mathbf{Q}$. This is an umklapp process.

Clearly, due to the factor of $\delta_{\mathbf{T}, \mathbf{S}+\mathbf{Q}}^2$, there is a severe phase space restriction in the overlapping channel, which gives rise to an overall factor of $\Lambda a \ll 1$. Therefore, at leading order the DW channel is decoupled from the BCS channel.

The two classes of repulsive channels which do renormalize the BCS channel are shown in figure 15. Their contributions to the action, written in terms of the fermion variables, are respectively:

$$S_R[\psi^{*\alpha}, \psi_\beta] = \frac{f_R}{2} \sum_{\mathbf{S}, \mathbf{T}} \sum_{i=1}^4 \sum_{\Delta \mathbf{p}} \int d\tau d^2x \psi^{*\alpha}(\mathbf{S}; x) \psi_\beta(\mathbf{S} + \Delta \mathbf{p} + \mathbf{Q}_i; x)$$

$$\times \psi^{*\gamma}(\mathbf{T}; x) \psi_\delta(\mathbf{T} - \Delta\mathbf{p} - \mathbf{Q}_i; x) [\delta_\alpha^\beta \delta_\gamma^\delta - \delta_\gamma^\beta \delta_\alpha^\delta], \quad (10.35)$$

which is a zero momentum process and

$$\begin{aligned} S_U[\psi^{*\alpha}, \psi_\beta] &= \frac{f_U}{2} \sum_{\mathbf{S}, \mathbf{T}} \sum_{i=1}^4 \sum_{\Delta\mathbf{p}} \int d\tau d^2x \psi^{*\alpha}(\mathbf{S}; x) \psi_\beta(\mathbf{S} + \Delta\mathbf{p} + \mathbf{Q}_i; x) \\ &\times \psi^{*\gamma}(\mathbf{T}; x) \psi_\delta(\mathbf{T} - \Delta\mathbf{p} + \mathbf{Q}_i; x) [\delta_\alpha^\beta \delta_\gamma^\delta - \delta_\gamma^\beta \delta_\alpha^\delta], \end{aligned} \quad (10.36)$$

which is an umklapp process permitted as $2\mathbf{Q}_i$ is a commensurate wavevector. In both channels we assume the coupling functions to be momentum-independent and we anti-symmetrize the spin indices. Now we expand the partition function to second order in $S_R + S_U$, integrate out the high-energy modes, and study the resulting effective action generated by this procedure. In the course of this RG procedure, both S_R and S_U are renormalized as well as the BCS action, and the resulting flow equations are a complicated set of coupled differential equations. As we are only interested in the initial growth of the BCS channel, we do not need to perform a complete analysis of the flow equations, we need only examine how $S_R + S_U$ renormalizes the BCS channel in the initial stages of its growth near $s = 1$. The second-order correction to the BCS channel is given by:

$$\begin{aligned} \frac{1}{2} \langle (S_R + S_U)^2 \rangle &\approx \ln(s) (f_R^2 + 4f_U^2) \sum_{\mathbf{S}} \sum_{i=1}^4 \sum_{\Delta\mathbf{p}} \int d\tau d^2x \psi^{*\alpha}(\mathbf{S}; x) \psi^{*\beta}(-\mathbf{S}; x) \\ &\times \psi_\beta(\mathbf{S} + \Delta\mathbf{p} + \mathbf{Q}_i; x) \psi_\alpha(-\mathbf{S} - \Delta\mathbf{p} - \mathbf{Q}_i; x) \\ &\times \frac{\sqrt{2}}{2(2\pi)^2} \frac{1}{\cos \Delta\mathbf{p}_x/2} \ln \left(\frac{1 + \cos(\kappa + |\Delta\mathbf{p}_x|/2)}{1 - \cos(\kappa + |\Delta\mathbf{p}_x|/2)} \right) \\ &+ \frac{\ln(s)}{2} f_R^2 \left[\frac{\sqrt{2}}{(2\pi)^2} \ln \left(\frac{1 + \cos \kappa}{1 - \cos \kappa} \right) + \frac{1}{2\pi} \right] \\ &\times \sum_{\mathbf{S}, \mathbf{T}} \int d\tau d^2x \psi^{*\alpha}(\mathbf{S}; x) \psi^{*\beta}(-\mathbf{S}; x) \psi_\beta(-\mathbf{T}; x) \psi_\alpha(\mathbf{T}; x) \\ &+ \text{non-BCS terms}. \end{aligned} \quad (10.37)$$

The second term in equation 10.37 governs the flow of the s -wave BCS channel but since the s -wave channel is repulsive at first order it is not a candidate for instability. However, the first term in equation 10.37, as it has strong wavevector dependence, contributes to the RG flow in all of the other BCS channels. The flow equations are:

$$\begin{aligned} \frac{dV_{BCS}(\mathbf{S}, \mathbf{T})}{d \ln(s)} &= (f_R^2 + 4f_U^2) \frac{\sqrt{2}}{2(2\pi)^2} \frac{1}{\cos \Delta\mathbf{p}_x(\mathbf{S}, \mathbf{T})/2} \ln \left(\frac{1 + \cos(\kappa + |\Delta\mathbf{p}_x(\mathbf{S}, \mathbf{T})|/2)}{1 - \cos(\kappa + |\Delta\mathbf{p}_x(\mathbf{S}, \mathbf{T})|/2)} \right) \\ &- \frac{\Lambda}{(2\pi)^2} \sum_{\mathbf{U}} \frac{1}{v_F(\mathbf{U})} V_{BCS}(\mathbf{S}, \mathbf{U}) V_{BCS}(\mathbf{U}, \mathbf{T}), \end{aligned} \quad (10.38)$$

if \mathbf{S} and \mathbf{T} are in the same quadrant in the (k_x, k_y) plane. On the other hand, when \mathbf{S} and \mathbf{T} are in different quadrants,

$$\frac{dV_{BCS}(\mathbf{S}, \mathbf{T})}{d \ln(s)} = - \frac{\Lambda}{(2\pi)^2} \sum_{\mathbf{U}} \frac{1}{v_F(\mathbf{U})} V_{BCS}(\mathbf{S}, \mathbf{U}) V_{BCS}(\mathbf{U}, \mathbf{T}). \quad (10.39)$$

Finally, we can determine which BCS channels are attractive by evaluating the generalized Fourier coefficients of the double expansion shown in equation 10.18. After performing the generalized Fourier transform of the RHS of equation 10.38 we find that, among the fundamental modes, there are two diagonal Fourier coefficients which flow to negative values. Their rate of change, evaluated for the case $\kappa = 0.01$, is:

$$\begin{aligned} \frac{dC_2^{11}}{d\ln(s)} &= \Lambda^2 \sum_{\mathbf{S}, \mathbf{T}} \frac{1}{v_F(\mathbf{S}) v_F(\mathbf{T})} \frac{dV_{BCS}(\mathbf{S}, \mathbf{T})}{d\ln(s)} a_2(1, \mathbf{S}) a_2(1, \mathbf{T}) \\ &\approx -0.1 (f_R^2 + 4 f_U^2) - |C_2^{11}|^2 / (2\pi)^2, \end{aligned} \quad (10.40)$$

$$\begin{aligned} \frac{dC_3^{00}}{d\ln(s)} &= \Lambda^2 \sum_{\mathbf{S}, \mathbf{T}} \frac{1}{v_F(\mathbf{S}) v_F(\mathbf{T})} \frac{dV_{BCS}(\mathbf{S}, \mathbf{T})}{d\ln(s)} b_1(0, \mathbf{S}) b_1(0, \mathbf{T}) \\ &\approx -0.23 (f_R^2 + 4 f_U^2) - |C_3^{00}|^2 / (2\pi)^2. \end{aligned} \quad (10.41)$$

Here we have set $C_2^{11}(s=1) = C_3^{00}(s=1) = 0$ initially. From the Landau theorem we infer that there can be a BCS instability in either the B_1 ($d_{x^2-y^2}$ -wave) or A_2 (extended s -wave) channels provided the SDW instability does not preempt it. Furthermore, as the inequality

$$\left| \frac{dC_3^{00}}{d\ln(s)} \right| > \left| \frac{dC_2^{11}}{d\ln(s)} \right| \quad (10.42)$$

holds for small values of κ , $d_{x^2-y^2}$ -wave superconductivity is preferred. Superconducting order, if it exists, will most likely possess $d_{x^2-y^2}$ -wave symmetry. This conclusion is consistent with the expectation that nearest-neighbor antiferromagnetic exchange favors $d_{x^2-y^2}$ -wave superconductivity. It also agrees qualitatively with a diagrammatic approach[114] and a parquet solution obtained for the flat Fermi surface[115].

Of course, the tendency towards spin-density order dominates all other instabilities close to half-filling. But slightly below half-filling, because nesting is not perfect but nonetheless effective, there is competition between the SDW and BCS instabilities. As the energy cutoff ϵ_c around the Fermi surface is reduced via the RG transformation towards ϵ_s , where ϵ_s is the energy deviation of the actual Fermi surface from perfect nesting, the SDW channel stops flowing but the BCS channel continues to renormalize logarithmically as its flow is independent of nesting. If the initial SDW coupling is small enough or if ϵ_s is large enough (the SDW channel does not develop an instability until $\epsilon_c \rightarrow \epsilon_s$) SDW order will not occur. Instead, superconductivity will set in at a sufficiently low temperature.

11 Conclusion

In this review we have shown that multidimensional bosonization, when combined with the Renormalization Group picture, is a powerful tool for the study of strongly interacting fermion systems. First, an effective action for quasiparticles is derived by integrating out the high energy degrees of freedom which lie outside of the concentric shells which encircle the Fermi surface. The renormalization process is stopped before all of the degrees of freedom are eliminated; the effective Hamiltonian so obtained describes quasiparticles confined to a narrow region around the Fermi surface of width $\lambda \ll k_F$. Of course no attempt is made to

calculate the values of parameters such as the effective mass m^* or the coupling constants for the short-ranged part of the forward and exchange interactions as this can only be done reliably in special limits, for example the case of a very weak bare interaction. The Fermi surface is now discretized, tiled into squat boxes with aspect ratio $\lambda \ll \Lambda$, where Λ is the length of the box along the surface. In each squat box, currents defined in terms of the fermionic quasiparticles also have an equivalent representation in terms of bosonic fields. When it is legitimate to linearize the quasiparticle spectrum about the Fermi momentum by dropping the non-linear terms, the complicated many-body interactions reduce to a quadratic form in the boson fields which possesses the large $U(1)_k^\infty$ symmetry, assuming that there is no BCS instability. Given these caveats, the boson propagator can be determined exactly from a generating functional; the fermion propagator then follows on using the exponential representation of the fermions in terms of the bosons.

As the existence of Landau quasiparticles is not presupposed, multidimensional bosonization is a useful nonperturbative approach to access non-trivial ground states of strongly correlated fermion systems and to study their stability. In one spatial dimension, well-known exact results are recovered. The ground state is generically a Luttinger liquid, and the low-lying excitations are collective modes of charge and spin which propagate at different velocities. In higher dimension the Landau Fermi liquid is realized when fermions interact via a longitudinal interaction of either short-range, or of the usual Coulomb form. Unphysically longer ranged interactions, however, can destroy the Landau quasiparticles. All of the important results of Fermi liquid theory can be recovered within bosonization, the nonanalytic $T^3 \ln T$ contribution to the specific heat in three dimensions, the equations of motion of charge and spin collective modes, as well as screening and quasiparticle damping in two and three dimensions. Both long and short wavelength physics can be described provided the energy is low enough to be within a shell surrounding the Fermi surface. For example the density response has the usual RPA form at low wavevectors, and at high wavevectors near $2k_F$ the Kohn nonanalyticity is found.

The possibility of non-Fermi liquid ground states has been raised for systems interacting via transverse gauge fields, as these fields are not screened at low frequencies. Such a scenario has been suggested as the mechanism underlying cuprate superconductivity, but a concrete example is furnished by quantum Hall systems in two dimensions, specifically a two-dimensional electron gas in a perpendicular magnetic field such that only the lowest Landau level is half-filled. In the widely used Chern-Simons gauge theory the physical electrons are mapped by a singular gauge transformation onto composite fermions which each carry two units of statistical flux and interact via a transverse gauge field in addition to the usual longitudinal density-density interaction. At the mean field level the average flux cancels the external magnetic field and the ground state is a free Fermi gas. The stability of this state against gauge (= charge) fluctuations was studied by determining the composite quasiparticle propagator. Multidimensional bosonization broke down for longitudinal interactions shorter-ranged than Coulomb as the transverse gauge fluctuations, which are moderated by the longitudinal interaction, are too strong in this instance. In the case of the Coulomb interaction, two important results were found. At equal time and at long distances the propagator has the form $G_F(\mathbf{S}; x_\parallel) \sim |x_\parallel|^{-\zeta}/x_\parallel$. In the opposite limit of long temporal separation, $|t| \gg |x_\parallel|$, the leading terms can be Fourier transformed and the self-energy extracted, yielding the marginal Fermi liquid form, $\Sigma(\omega) \sim \zeta \omega \ln |\omega|$, identical to that found

within RPA.

This result has been criticized by several authors and remains controversial. The basis for the criticism is the linearization of the quasiparticle dispersion, an approximation which is especially useful in bosonization as it leads to a Gaussian bosonic action. Because gauge fluctuations carry relatively large transverse momentum, it has been argued that non-linear corrections to the quasiparticle dispersion should be retained, especially in the case of short-range longitudinal interactions. Furthermore, Altshuler, Ioffe, and Millis[90] argue that, in the case of the Coulomb interaction, when the quadratic $q_{\perp}^2/(2m^*)$ term is retained the MFL form of the self-energy given above is the leading term, and all other higher-order terms are subleading. This claim has been criticized by Kopietz who points out[91] that the two-loop self-energy is more divergent than the single-loop self-energy. Kopietz and Castilla[98] attempted to incorporate the $q_{\perp}^2/2m^*$ term within a bosonized treatment and find that Fermi liquid behavior is recovered, even in the case of short-range longitudinal interactions where the gauge fluctuations should be strongest and most disruptive. The nature of the composite quasiparticle propagator, and whether or not it is even physically meaningful, remains the subject of ongoing research. Different, direct, schemes for bosonization of Landau levels have been proposed[116, 117], and these may prove useful. Renormalization group methods, when combined with the Ward identity approach[118] are another route being pursued.

A particularly important feature of multidimensional bosonization is that it can be combined with the renormalization group to analyze various instabilities of the Fermi liquid, all of which are treated on an equal footing. Bosonization is most useful in this context as the forward-scattering parts of the interaction, those which preserve the $U(1)_k^{\infty}$ symmetry, can be incorporated exactly at the outset as part of the Gaussian fixed point. As a simple example we have studied the BCS instability for a circular Fermi surface, and have rederived the RG flow equations found by Shankar[27] in the fermion basis. For a nested Fermi surface close to half-filling, we studied the competition (for a repulsive bare interaction) between density wave and superconducting instabilities. A pleasing conclusion coming from this calculation is that the $d_{x^2-y^2}$ superconducting channel is favored in agreement with experiments[119]. Above T_c the normal state is a marginal Fermi liquid, also in qualitative agreement with many experiments[120]. Bosonization is particularly appropriate here as the forward-scattering channel responsible for the marginal Fermi liquid state is incorporated non-perturbatively. Unlike other approaches, in multidimensional bosonization Feynman diagrams receive rather less emphasis than algebraic and geometric ways of understanding correlated fermions. When combined with the renormalization group, bosonization yields insight into fermion liquids which does not rely on the resummation techniques of microscopic Fermi liquid theory[13]. By unifying the microscopic and Landau pictures, multidimensional bosonization provides a new way to think about correlated fermions.

Finally we should mention some outstanding problems which remain unanswered. First, as we have noted, linearization of the fermion dispersion is a central approximation, crucial to the success of the approach. As pointed out originally by Haldane[17], nonlinear corrections to the dispersion can only be included systematically in a perturbative treatment. When these terms are important, it is not clear how useful bosonization remains. The most important failing of bosonization to date, however, is that it remains unable to account for the intermingling effects of interaction and disorder leading to diffusion and the modification of screening[121]. To understand the role of disorder it is necessary to confront the effects

of interpatch scattering, which breaks the $U(1)_k^\infty$ symmetry down to just the usual global $U(1)$ charge conservation symmetry. Some progress has been made in the special case of one spatial dimension where the weak-coupling RG equations have been worked out[122]. In higher dimension, forward scattering by impurities can be included rather easily[38, 123], but this has no effect once the $\lambda/k_F \rightarrow 0$ limit is taken, as required if multidimensional bosonization is to be rigorous. In the regime of strong disorder, Belitz and Kirkpatrick have used a Hubbard-Stratonovich transformation to decouple the fermion interaction along with replicated disorder by introducing bosonic Q -fields[124]. They emphasize that the soft, low-energy, modes of disordered systems differ qualitatively from the low-energy degrees of freedom in the clean limit, as they are diffusive rather than ballistic in character. It remains to be seen whether or not a theory can be constructed which interpolates accurately between the limits of weak and strong disorder.

12 Acknowledgments

We thank P. A. Bares, K. Bedell, D. Belitz, C. Castellani, C. Di Castro, S. Das Sarma, J. P. Eisenstein, B. I. Halperin, T. Kirkpatrick, G. Kotliar, A. Ludwig, A. Maccarone, W. Metzner, A. Millis, G. Murthy, P. Nelson, R. Shankar, A. Stern, and C. M. Varma for helpful discussions. This work was initiated at the Institute for Theoretical Physics in Santa Barbara. Additional work was carried out at the Aspen Center for Physics. The research was supported in part by the National Science Foundation through grants DMR-9008239 (A.H.) and DMR-9357613 (J.B.M.) and by a grant from the Alfred P. Sloan Foundation (J.B.M.).

A Calculation of the Boson Correlation Function

Use equation 2.18 to find the equal-time correlation function

$$\begin{aligned} G_\phi(\mathbf{S}; \mathbf{x}) &= \langle \phi(\mathbf{S}; \mathbf{x}) \phi(\mathbf{S}; \mathbf{0}) - \phi^2(\mathbf{S}; \mathbf{0}) \rangle \\ &= \frac{\Omega}{4\pi} \sum_{\mathbf{p}, \hat{\mathbf{n}}_{\mathbf{S}} \cdot \mathbf{p} > 0} \theta(\mathbf{S}; \mathbf{p}) \frac{(e^{i\mathbf{p} \cdot \mathbf{x}} - 1) e^{-a\hat{\mathbf{n}}_{\mathbf{S}} \cdot \mathbf{p}}}{|\hat{\mathbf{n}}_{\mathbf{S}} \cdot \mathbf{p}|} \end{aligned} \quad (\text{A.1})$$

where we have introduced the convergence factor $e^{-a\hat{\mathbf{n}}_{\mathbf{S}} \cdot \mathbf{p}}$. To evaluate the integral over the component of momentum parallel to the surface normal, $p_{\parallel} \equiv \hat{\mathbf{n}}_{\mathbf{S}} \cdot \mathbf{p}$, consider first the integral

$$I(x_{\parallel}) \equiv \int_{\alpha}^{\lambda/2} \frac{dp_{\parallel}}{4\pi} \frac{e^{ip_{\parallel}x_{\parallel}}}{p_{\parallel}}, \quad (\text{A.2})$$

here α is an infrared cutoff which drops out of the calculation at the end. Then

$$I(0) = \frac{1}{4\pi} \ln \left[\frac{\lambda}{2\alpha} \right], \quad (\text{A.3})$$

$$\frac{dI(x_{\parallel})}{dx_{\parallel}} = i \int_{\alpha}^{\lambda/2} \frac{dp_{\parallel}}{4\pi} e^{ip_{\parallel}(x_{\parallel}+ia)} = -\frac{1}{4\pi(x_{\parallel} + ia)} \quad (\text{A.4})$$

and

$$I(x_{\parallel}) = -\frac{1}{4\pi} \ln(x_{\parallel} + ia) + C \quad (\text{A.5})$$

where, from equation A.3,

$$C = \frac{1}{4\pi} \ln \frac{ia\lambda}{2\alpha} \quad (\text{A.6})$$

and therefore

$$I(x_{\parallel}) = -\frac{1}{4\pi} \ln \left[\frac{2\alpha x_{\parallel} + ia}{\lambda} \right]. \quad (\text{A.7})$$

Now consider the integrals over the momenta perpendicular to the surface normal, specializing to the case $D = 2$ for concreteness:

$$\begin{aligned} \int_{-\Lambda/2}^{\Lambda/2} \frac{dp_{\perp}}{2\pi} e^{ip_{\perp}x_{\perp}} &= \frac{1}{\pi x_{\perp}} \sin \frac{\Lambda x_{\perp}}{2} \\ &\cong \begin{cases} \frac{\Lambda}{2\pi}, & \Lambda|x_{\perp}| \ll 1 \\ 0, & \Lambda|x_{\perp}| \gg 1 \end{cases} \end{aligned} \quad (\text{A.8})$$

Combining these results, and using the fact that $\sum_{\mathbf{p}} = L^D \int \frac{d^D p}{(2\pi)^D}$ we find that the infrared cutoff α drops out and

$$G_{\phi}(\mathbf{S}; \mathbf{x}) = \begin{cases} -\frac{\Omega^2}{4\pi} \ln \left[\frac{x_{\parallel} + ia}{ia} \right], & \Lambda|\mathbf{x}_{\perp}| \ll 1 \\ -\infty, & \Lambda|\mathbf{x}_{\perp}| \gg 1. \end{cases} \quad (\text{A.9})$$

B Integrating Out Fast Boson Fields

To evaluate the propagator of the h fields, make use of the relationship between ϕ and the canonical bose fields, a and a^* , equation 2.18 to write

$$\langle h(\mathbf{S}, x)h(\mathbf{S}, 0) \rangle = \frac{\Omega}{4\pi} \int \frac{d\omega}{2\pi} \sum'_{\mathbf{q}} \frac{\langle a(\mathbf{S}, q)a^{\dagger}(\mathbf{S}, q) \rangle}{q_{\parallel}} e^{i(\mathbf{q} \cdot \mathbf{x} - \omega\tau)} \quad (\text{B.1})$$

where

$$\sum'_{\mathbf{q}} = \left(\frac{L}{2\pi} \right)^D \int_{-\Lambda/2}^{\Lambda/2} d^{D-1}q_{\perp} \int_{\lambda/2s < |q_{\parallel}| < \lambda/2} dq_{\parallel} \quad (\text{B.2})$$

and

$$\langle a(\mathbf{S}, q)a^*(\mathbf{S}, q) \rangle = \frac{-1}{i\omega - v_F^* q_{\parallel}} \quad (\text{B.3})$$

The frequency integral is straightforward and equation B.1 reduces to

$$\langle h(\mathbf{S}, x)h(\mathbf{S}, 0) \rangle = \frac{\Omega^2}{4\pi} \int_{\lambda/2s < |q_{\parallel}| < \lambda/2} dq_{\parallel} \frac{e^{i(q_{\parallel}(x_{\parallel} + iv_F^*\tau))}}{q_{\parallel}} [\theta(q_{\parallel})\theta(\tau) - \theta(-q_{\parallel})\theta(-\tau)] \quad (\text{B.4})$$

where we have used the result (given here for $D = 2$):

$$\int_{-\Lambda/2}^{\Lambda/2} dq_{\perp} e^{iq_{\perp}x_{\perp}} = \frac{\sin(\Lambda x_{\perp}/2)}{(x_{\perp}/2)} \rightarrow \begin{cases} \Lambda, & \Lambda|x_{\perp}| \ll 1 \\ 0, & \text{otherwise} \end{cases} \quad (\text{B.5})$$

To evaluate the integral over q_{\parallel} write it as the difference $\int_0^{\lambda/2} - \int_0^{\lambda/2s}$ and replace the upper limit by a smooth cut-off to find

$$\langle h(\mathbf{S}, x)h(\mathbf{S}, 0) \rangle = \begin{cases} \frac{\Omega^2}{4\pi} \ln \left[\frac{x_{\parallel} + iv_F^* \tau + (2is/\lambda) \text{sgn}(\tau)}{x_{\parallel} + iv_F^* \tau + (2i/\lambda) \text{sgn}(\tau)} \right], & \Lambda|x_{\perp}| \ll 1 \\ 0, & \text{otherwise} . \end{cases} \quad (\text{B.6})$$

C Free Fermion Propagator

Expressed in terms of the boson fields the fermion propagator in patch \mathbf{S} is given by

$$G_F(\mathbf{S}; \mathbf{x}, \tau) = \frac{-\Lambda^{D-1}}{(2\pi)^D} \frac{e^{i\mathbf{k}_S \cdot \mathbf{x}}}{a} \exp \left[\frac{4\pi}{\Omega^2} \langle \phi(\mathbf{S}; x, \tau) \phi(\mathbf{S}, 0) - \phi^2(\mathbf{S}, 0) \rangle \right], \quad (\text{C.1})$$

where the correlation function of the ϕ fields expressed in terms of the canonical boson fields a , and a^* , is given by

$$\begin{aligned} G_{\phi}(\mathbf{S}; \mathbf{x}, \tau) &= \langle \phi(\mathbf{S}; \mathbf{x}, \tau) \phi(\mathbf{S}, \mathbf{0}, 0) - \phi^2(\mathbf{S}; \mathbf{0}, 0) \rangle \\ &= \frac{\Omega}{4\pi} \sum_{\mathbf{q}} \int \frac{d\omega}{2\pi} \left[e^{i(\mathbf{q} \cdot \mathbf{x} - \omega\tau)} - 1 \right] \frac{\langle a(\mathbf{S}; q) a^{\dagger}(\mathbf{S}; q) \rangle}{\hat{\mathbf{n}}_S \cdot \mathbf{q}} \end{aligned} \quad (\text{C.2})$$

which determines the fermion Green's function once the Fourier transform of the boson Green's function is known. Now the free boson Green's function is given by equation B.3:

$$G_B^0(\mathbf{S}; \mathbf{q}, \omega) = \frac{-1}{i\omega - v_F^* \hat{\mathbf{n}}_S \cdot \mathbf{q}} \quad (\text{C.3})$$

and therefore

$$G_{\phi}^0(\mathbf{S}; \mathbf{x}, \tau) = \frac{i\Omega^2}{4\pi} \int_{-\lambda/2}^{\lambda/2} dq_{\parallel} \int_{-\infty}^{\infty} \frac{d\omega}{2\pi} \frac{e^{i(q_{\parallel} x_{\parallel} - \omega\tau)} - 1}{q_{\parallel} (\omega + iv_F^* q_{\parallel})} \quad (\text{C.4})$$

where we have used equation B.5, valid for $D = 2$, to integrate over the perpendicular momentum. Now consider

$$\begin{aligned} \frac{\partial}{\partial x_{\parallel}} G_{\phi}^0(\mathbf{S}; \mathbf{x}, \tau) &= i \frac{\Omega^2}{4\pi} \int_{-\lambda/2}^{\lambda/2} dq_{\parallel} [\theta(q_{\parallel})\theta(\tau) - \theta(-q_{\parallel})\theta(-\tau)] e^{iq_{\parallel}(x_{\parallel} + iv_F^* \tau)} \\ &= -\frac{\Omega^2}{4\pi} \frac{1}{(x_{\parallel} + iv_F^* \tau)} \end{aligned} \quad (\text{C.5})$$

and therefore

$$G_{\phi}(\mathbf{S}; x, \tau) = -\frac{\Omega^2}{4\pi} \ln(x_{\parallel} + iv_F^* \tau) + C; \quad (\text{C.6})$$

but $\lim_{\tau \rightarrow 0^+} G_\phi(\mathbf{S}; \mathbf{0}, \tau) = 0$, which gives $C = \frac{\Omega^2}{4\pi} \ln(ia)$ and

$$G_\phi^0(\mathbf{S}; \mathbf{x}, \tau) = -\frac{\Omega^2}{4\pi} \ln \left[\frac{x_{\parallel} + iv_F^* \tau}{ia} \right] \quad (\text{C.7})$$

For the case of $D = 2$, it follows from equation C.1 that

$$G_F(\mathbf{S}; \mathbf{x}, \tau) = \frac{i\Lambda}{(2\pi)^2} \frac{e^{i\mathbf{k}_S \cdot \mathbf{x}}}{\hat{\mathbf{n}}_S \cdot \mathbf{x} + iv_F^* \tau} \quad (\text{C.8})$$

The Green's function for real time is obtained by continuing $i\tau \rightarrow -t$.

D How Kohn's Theorem Is Satisfied

In this appendix, we derive the result quoted in Section 8, namely the collective excitations of the interacting quasiparticles of the half-filled Landau level occur at a frequency $\omega = 2\pi n_f \tilde{\phi}/m$, the cyclotron frequency of a particle with bare mass m in a magnetic field $B = 2\pi n_f \tilde{\phi}/e$. To prove this result, we add to the action of the Chern-Simons gauge theory a Fermi liquid interaction in which all the coefficients except f_1 have been set equal to zero[81]. The contribution to the action, equation 8.13, is given in real time by

$$S_{FL}[\psi^*, \psi] = \frac{f_1}{2k_F^2} \int d^2x dt \psi^*(x) \nabla \psi(x) \cdot \psi^*(x) \nabla \psi(x) \quad (\text{D.1})$$

which is made gauge covariant by replacing ∇ by $\nabla - i\mathbf{A}$. On Fourier transforming it is given in terms of the currents as

$$\begin{aligned} S_{FL} &\approx -\frac{f_1}{2Vk_F^2} \int \frac{d\omega}{2\pi} \left\{ \sum_{\mathbf{S}, \mathbf{T}, \mathbf{q}} J(\mathbf{S}; q) \mathbf{k}_S \cdot \mathbf{k}_T J(\mathbf{T}; -q) \right. \\ &+ \frac{f_1}{2Vk_F^2} \sum_{\mathbf{S}, \mathbf{q}} n_f [J(\mathbf{S}; q) \mathbf{k}_S \cdot \mathbf{A}(-q) + J(\mathbf{S}; -q) \mathbf{k}_S \cdot \mathbf{A}(q)] \\ &\left. - \frac{f_1}{2Vk_F^2} \sum_{\mathbf{q}} n_f^2 \mathbf{A}(q) \cdot \mathbf{A}(-q) \right\} \quad (\text{D.2}) \end{aligned}$$

As in Section 6 the term quadratic in J is decoupled by introducing additional transverse A_t and longitudinal A_l gauge fields.

Including the Fermi liquid interaction the complete action of the theory is given by

$$\begin{aligned} S[A^\mu, a, \xi, \xi^*] &= \sum_{\mathbf{S}} \sum_{\mathbf{q}, \hat{\mathbf{n}}_S \cdot \mathbf{q} > 0} \int \frac{d\omega}{2\pi} \left\{ (\omega - v_F^* \hat{\mathbf{n}}_S \cdot \mathbf{q}) a^*(\mathbf{S}; q) a(\mathbf{S}; q) \right. \\ &+ \xi(\mathbf{S}; q) a^*(\mathbf{S}; q) + \xi^*(\mathbf{S}; q) a(\mathbf{S}; q) \left. \right\} \\ &+ \frac{1}{V} \sum_{\mathbf{S}} \sum_{\mathbf{q}} \int \frac{d\omega}{2\pi} J(\mathbf{S}; q) \left\{ A_0(-q) + \left(v_F^* + \frac{f_1 n_f}{k_F} \right) \frac{\hat{\mathbf{n}}_S \times \mathbf{q}}{|\mathbf{q}|} A_T(-q) \right. \\ &+ \left. \frac{\hat{\mathbf{n}}_S \cdot \mathbf{q}}{|\mathbf{q}|} A_l(-q) + \frac{\hat{\mathbf{n}}_S \times \mathbf{q}}{|\mathbf{q}|} A_t(-q) \right\} \end{aligned}$$

$$\begin{aligned}
& + \frac{1}{2V} \sum_{\mathbf{q}} \int \frac{d\omega}{2\pi} \left\{ \left[\frac{n_f}{m^*} + \frac{f_1 n_f^2}{k_F^2} + \frac{\mathbf{q}^2 V(\mathbf{q})}{(2\pi\tilde{\phi})^2} \right] A_T(q) A_T(-q) + \frac{2i|\mathbf{q}|}{2\pi\tilde{\phi}} A_0(q) A_T(-q) \right. \\
& \left. - \frac{1}{f_1} A_l(q) A_l(-q) - \frac{1}{f_1} A_t(q) A_t(-q) \right\}, \tag{D.3}
\end{aligned}$$

where μ runs over $0, T, l$ and t . We have coupled the boson fields a^* and a to ξ and ξ^* to construct a generating functional as in equation 8.15. After integrating out the boson fields we obtain the effective action:

$$\begin{aligned}
S_{eff}[A^\mu, \xi, \xi^*] &= \frac{1}{2} \int \frac{d^2q}{(2\pi)^2} \int \frac{d\omega}{2\pi} \left\{ \left[\frac{n_f}{m^*} + \frac{f_1 n_f^2}{k_F^2} + \frac{\mathbf{q}^2 V(\mathbf{q})}{(2\pi\tilde{\phi})^2} + (v_F^* + \frac{f_1 n_f}{k_F})^2 \chi_t(q) \right] A_T(q) A_T(-q) \right. \\
& + \frac{2i|\mathbf{q}|}{2\pi\tilde{\phi}} A_0(q) A_T(-q) + \left[-\frac{1}{f_1} + \chi_l(q) \right] A_l(q) A_l(-q) + \left[-\frac{1}{f_1} + \chi_t(q) \right] A_t(q) A_t(-q) \\
& + \chi_{l0}(q) [A_l(q) A_0(-q) - A_0(q) A_l(-q)] + 2[v_F^* + \frac{f_1 n_f}{k_F}] \chi_t(q) A_T(q) A_t(-q) \\
& + \chi_0(q) A_0(q) A_0(-q) \left. \right\} - \frac{1}{V} \sum_{\mathbf{q}, \hat{\mathbf{n}}_{\mathbf{S}} \cdot \mathbf{q} > 0} \int \frac{d\omega}{2\pi} \sum_{\mathbf{S}} \left\{ \frac{\xi(\mathbf{S}; q) \sqrt{\Omega |\hat{\mathbf{n}}_{\mathbf{S}} \cdot \mathbf{q}|}}{(\omega - v_F^* \hat{\mathbf{n}}_{\mathbf{S}} \cdot \mathbf{q})} A_\alpha(-q) b^\alpha(\mathbf{S}; q) \right. \\
& \left. + \frac{\xi^*(\mathbf{S}; q) \sqrt{\Omega |\hat{\mathbf{n}}_{\mathbf{S}} \cdot \mathbf{q}|}}{(\omega - v_F^* \hat{\mathbf{n}}_{\mathbf{S}} \cdot \mathbf{q})} A_\alpha(q) b^\alpha(\mathbf{S}; -q) + \frac{\xi^*(\mathbf{S}; q) \xi(\mathbf{S}; q)}{\omega - v_F^* \hat{\mathbf{n}}_{\mathbf{S}} \cdot \mathbf{q}} \right\}, \tag{D.4}
\end{aligned}$$

here

$$b^\alpha(\mathbf{S}; q) \equiv \left(1, [v_F^* + \frac{f_1 n_f}{k_F}] \frac{\hat{\mathbf{n}}_{\mathbf{S}} \times \mathbf{q}}{|\mathbf{q}|}, \frac{\hat{\mathbf{n}}_{\mathbf{S}} \cdot \mathbf{q}}{|\mathbf{q}|}, \frac{\hat{\mathbf{n}}_{\mathbf{S}} \times \mathbf{q}}{|\mathbf{q}|} \right) \tag{D.5}$$

and the susceptibilities $\chi_\alpha(q)$ are defined by:

$$\begin{aligned}
\chi_0(q) &= -N^*(0) \int \frac{d\theta}{2\pi} \frac{\cos \theta}{x - \cos \theta + i\eta \operatorname{sgn}(x)} \\
&= N^*(0) \left[1 - \theta(x^2 - 1) \frac{|x|}{\sqrt{x^2 - 1}} + i\theta(1 - x^2) \frac{|x|}{\sqrt{1 - x^2}} \right] \\
\chi_t(q) &= N^*(0) \int \frac{d\theta}{2\pi} \frac{\cos \theta \sin^2 \theta}{x - \cos \theta + i\eta \operatorname{sgn}(x)} \\
&= N^*(0) \left[x^2 - \frac{1}{2} - \theta(x^2 - 1) |x| \sqrt{x^2 - 1} - i\theta(1 - x^2) |x| \sqrt{1 - x^2} \right] \\
\chi_l(q) &= N^*(0) \int \frac{d\theta}{2\pi} \frac{\cos^3 \theta}{x - \cos \theta + i\eta \operatorname{sgn}(x)} \\
&= N^*(0) \left[-x^2 - \frac{1}{2} + \theta(x^2 - 1) |x| \frac{x^2}{\sqrt{x^2 - 1}} - i\theta(1 - x^2) |x| \frac{x^2}{\sqrt{1 - x^2}} \right] \\
\chi_{l0}(q) &= -\chi_{l0}(-q) = N^*(0) \int \frac{d\theta}{2\pi} \frac{\cos^2 \theta}{x - \cos \theta + i\eta \operatorname{sgn}(x)} \\
&= N^*(0) \left[-x + \theta(x^2 - 1) |x| \frac{x}{\sqrt{x^2 - 1}} - i\theta(1 - x^2) |x| \frac{x}{\sqrt{1 - x^2}} \right], \tag{D.6}
\end{aligned}$$

and $x = \omega / (v_F^* |\mathbf{q}|)$. The boson propagator is obtained in the usual way

$$\langle a(\mathbf{S}; q) a^\dagger(\mathbf{S}; q) \rangle = \frac{i}{\omega - v_F^* \hat{\mathbf{n}}_{\mathbf{S}} \cdot \mathbf{q} + i\eta \operatorname{sgn}(\omega)}$$

$$+ i \frac{\Lambda}{(2\pi)^2} \hat{\mathbf{n}}_{\mathbf{S}} \cdot \mathbf{q} \frac{D_{\alpha\beta}(q) b^\alpha(\mathbf{S}; q) b^\beta(\mathbf{S}; -q)}{[\omega - v_F^* \hat{\mathbf{n}}_{\mathbf{S}} \cdot \mathbf{q} + i\eta \operatorname{sgn}(\omega)]^2}, \quad (\text{D.7})$$

and the collective modes are given by the poles of the gauge propagator. The inverse gauge propagator can be read off from the action equation D.4 and in the limit of interest $\omega \gg v_F^* |\mathbf{q}|$ is given by

$$[K(q)]_{\alpha\beta} = \begin{pmatrix} -\frac{N^*(0)}{2x^2} & \frac{i|\mathbf{q}|}{2\pi\phi} & -\frac{N^*(0)}{2x} & 0 \\ \frac{i|\mathbf{q}|}{2\pi\phi} & n_f \left(\frac{1}{m^*} + \frac{f_1 n_f}{k_F^2} \right) & 0 & -\frac{N^*(0)}{8x^2} \left(1 + \frac{m^* f_1 n_f}{k_F^2} \right) \\ \frac{N^*(0)}{2x} & 0 & -\frac{1}{f_1} & 0 \\ 0 & -\frac{N^*(0)}{8x^2} \left(1 + \frac{m^* f_1 n_f}{k_F^2} \right) & 0 & -\frac{1}{f_1} \end{pmatrix} \quad (\text{D.8})$$

The poles of $D_{\alpha\beta}$ are found by setting $\det|K_{\alpha\beta}| = 0$ which gives $\omega^2 = [2\pi\tilde{\phi}n_f(1/m^* + f_1/4\pi)]^2 = (2\pi n_f \tilde{\phi}/m_b)^2$. The second equality follows from the application of Galilean invariance to a Fermi liquid[29]. The energy of the collective mode is at the cyclotron frequency determined by the bare electron band mass in agreement with Kohn's theorem.

References

- [1] H. J. Schulz, "Fermi liquids and non-Fermi liquids," *Proceedings of Les Houches Summer School LXI*, eds. E. Akkermans, G. Montambaux, J. Pichard, and J. Zinn-Justin (Elsevier, Amsterdam, 1995).
- [2] J. Voit, *Rep. Prog. Phys.* **58**, 977 (1995).
- [3] J. von Delft and H. Schoeller, *Ann. Physik* **4**, 225 (1998) (cond-mat/9805275).
- [4] R. L. Stratonovich, *Doklady Akad. Nauk S.S.S.R* 1097 (1957) [*Sov. Phys. Doklady* **2**, 416 (1958)]; J. Hubbard, *Phys. Rev. Lett.* **3**, 77 (1959).
- [5] G. Baskaran and P. W. Anderson, *Phys. Rev. B* **37**, 580 (1988).
- [6] I. Affleck and J. B. Marston, *Phys. Rev. B* **37**, 3774 (1988); J. B. Marston and I. Affleck, *Phys. Rev. B* **39**, 11538 (1989).
- [7] See, for instance, Assa Auerbach, *Interacting Electrons and Quantum Magnetism* (Springer-Verlag, New York, 1994).
- [8] F. D. M. Haldane, "Luttinger's theorem and bosonization of the Fermi surface," in *Proceedings of the International School of Physics "Enrico Fermi,"* **121 Varenna 1992** edited by R. Schrieffer and R. A. Broglia (North-Holland, New York, NY 1994).
- [9] N. Ashcroft and D. Mermin, *Solid State Physics*, pp 47 – 48 (Saunders College, Philadelphia, 1976).
- [10] L. D. Landau, *Sov. Phys. JETP* **3**, 920 (1956); **5**, 101 (1957).

- [11] G. Baym and C. Pethick, *Landau Fermi-Liquid Theory: Concepts and Applications* (Wiley, New York, 1991).
- [12] L. D. Landau, Sov. Phys. JETP **35**, 70 (1958).
- [13] A. A. Abrikosov, L. P. Gorkov, and I. E. Dzyaloshinskii, *Methods of Quantum Field Theory in Statistical Physics*, Dover (New York, 1975); A. L. Fetter and D. L. Walecka, *Quantum Theory of Many-Particle Systems*, McGraw-Hill (New York, 1971); G. Rickayzen, *Green's Functions and Condensed Matter* (Academic Press, San Diego, 1980).
- [14] D. Pines and P. Nozieres, *The Theory of Quantum Liquids*, (Addison-Wesley, New York, 1989), Vol. I.
- [15] J. W. Negele and H. Orland, *Quantum Many-Particle Systems*, p. 254, (Addison-Wesley, Redwood City, 1988).
- [16] J. M. Luttinger, Phys. Rev. **119**, 1153 (1960).
- [17] F. D. M. Haldane, J. Phys. C **14**, 2585 (1981).
- [18] S. Tomonaga, Prog. Theor. Phys. **5**, 544 (1950).
- [19] A. Luther and I. Peschel, Phys. Rev. B **9**, 2911 (1974).
- [20] S. Coleman, Phys. Rev. D **11**, 2088 (1975).
- [21] S. Mandelstam, Phys. Rev. D **11**, 3026 (1975).
- [22] D. C. Mattis and E. H. Lieb, J. Math. Phys. **6**, 304 (1965).
- [23] J. M. Luttinger, J. Math. Phys. NY **4**, 1154 (1963).
- [24] P. W. Anderson, *Basic Notions of Condensed Matter Physics*, p. 84 (Benjamin-Cummings, Menlo Park, 1984).
- [25] J. Feldman and E. Trubowitz, Helv. Phys. Acta **63**, 156 (1990); **64**, 213 (1991); **65**, 679 (1992).
- [26] G. Benfatto and G. Gallavotti, Phys. Rev. B **42**, 9967 (1990); J. Stat. Phys. **59**, 541 (1990).
- [27] R. Shankar, Physica A **177**, 530 (1991); Rev. Mod. Phys. **66**, 129 (1994).
- [28] A. Luther, Phys. Rev. B **19**, 320 (1979).
- [29] A. Houghton and J. B. Marston, Phys. Rev. B **48**, 7790 (1993).
- [30] A. Houghton, H.-J. Kwon, and J. B. Marston, Phys. Rev. B **50**, 1351 (1994).
- [31] A. Houghton, H.-J. Kwon, J. B. Marston and R. Shankar, J. Phys.: Cond. Matt. **6**, 4909 (1994).

- [32] H.-J. Kwon, A. Houghton, and J. B. Marston, Phys. Rev. Lett. **73** 284 (1994).
- [33] H.-J. Kwon, A. Houghton, and J. B. Marston, Phys. Rev. B **52**, 8002 (1995).
- [34] A. H. Castro Neto and Eduardo H. Fradkin, Phys. Rev. Lett **72**, 1393 (1994); Phys. Rev. B **49**, 10877 (1994).
- [35] A. H. Castro Neto and Eduardo H. Fradkin, Phys. Rev. B. **51**, 4084 (1995).
- [36] J. Fröhlich, R. Götschmann, and P. A. Marchetti, J. Phys. A **28**, 1169 (1995).
- [37] P. Kopietz, J. Hermisson, and K. Schönhammer, Phys. Rev. B **52**, 10877 (1995); P. Kopietz and K. Schönhammer, Z. Phys. B **100**, 259 (1996).
- [38] Peter Kopietz, *Bosonization of Interacting Fermions in Arbitrary Dimensions* (Springer-Verlag, Berlin, 1997).
- [39] D. V. Khveshchenko, Phys. Rev. B **49**, 16893 (1994); Phys. Rev. B **52**, 4833 (1995).
- [40] W. Metzner, C. Castellani, and C. DiCastro, Adv. Phys. **47**, 317 (1998).
- [41] I. E. Dzyaloshinsky and A. I. Larkin, Sov. Phys. JETP **38**, 202 (1974).
- [42] C. Castellani, C. Di Castro and W. Metzner, Phys. Rev. Lett. **72**, 316 (1994); C. Di Castro, C. Castellani, and W. Metzner, “Conservation laws in normal metals: Luttinger liquid vs. Fermi liquid,” in *The Physics and the Mathematical Physics of the Hubbard Model* edited by D. Campbell (Plenum Press, New York, in press); C. Castellani and C. Di Castro, “Crossover from Luttinger to Fermi liquid by increasing dimension,” in *Proceedings of IV International Conference on Materials and Mechanisms of Superconductivity, Grenoble, July 1994*, edited by P. Wyder (Elsevier Publications, 1995).
- [43] V. P. Silin, Sov. Phys. JETP **6**, 955 (1958); *ibid.* **7**, 486 (1958).
- [44] K. D. Schötte and U. Schötte, Phys. Rev. **182**, 479 (1969).
- [45] P. Jordan and E. Wigner, Z. Phys. **47**, 631 (1928).
- [46] R. Shankar, *Katmandu Lectures, BCSPIN Summer School 1991 in Condensed Matter and Particle Physics*, Eds. Y. Lu, J. Pati and Q. Shafi (World Scientific, Singapore, 1993).
- [47] W. Kohn and J. M. Luttinger, Phys. Rev. Lett. **15**, 524 (1965); A. V. Chubukov, Phys. Rev. B **48**, 1097 (1993).
- [48] V. J. Emery, “Theory of the one-dimensional electron gas,” in *Highly Conducting One-Dimensional Solids*, eds. J. T. Devreese, R. P. Evrard, and V. E. van Doren (Plenum, New York, 1979).
- [49] J. Solyom, Adv. Phys. **28**, 201 (1979).
- [50] I. Affleck, J. Phys. Condensed Matter **1**, 3047 (1989).

- [51] D. S. Greywall, Phys. Rev. B **27**, 2747 (1983).
- [52] C. J. Pethick and G. M. Carneiro, Phys. Rev. A **7**, 304 (1973).
- [53] K. S. Bedell, private communication.
- [54] D. Coffey and K. S. Bedell, Phys. Rev. Lett. **71**, 1043 (1993).
- [55] E. Witten, Commun. Math. Phys. **92**, 455 (1984); A. B. Zamolodchikov and V. A. Fateev, Yad. Fiz. **43**, 1031 (1986) [Sov. J. Nucl. Phys. **43**, 657 (1986)]; D. Gepner and E. Witten, Nucl. Phys. B **278**, 493 (1986); A. W. W. Ludwig and I. Affleck, *ibid.* **360**, 641 (1991).
- [56] I. Affleck and F. D. M. Haldane, Phys. Rev. B **36**, 5291 (1987).
- [57] H. Sugawara, Phys. Rev. **170**, 1659 (1968).
- [58] P. Goddard and D. Olive, Int. J. Mod. Phys. A **1**, 303 (1986).
- [59] W. Kohn, Phys. Rev. **123**, 1242 (1961).
- [60] C. J. Halboth and W. Metzner, Phys. Rev. B **57**, 8873 (1998).
- [61] C. Hodges *et al.*, Phys. Rev. B **4**, 302 (1971).
- [62] P. Bloom, Phys. Rev. B **12**, 125 (1975).
- [63] G. F. Giuliani and J. J. Quinn, Phys. Rev. B **26**, 4421 (1982).
- [64] P. C. E. Stamp, J. Phys. I **3** (1993).
- [65] P. Bares and X. G. Wen, Phys. Rev. B **48**, 8636 (1993).
- [66] J. J. Quinn and R. A. Ferrell, Phys. Rev. **112**, 812 (1958).
- [67] E. Wigner, Trnas. Farad. Soc. **34**, 678 (1938).
- [68] D. J. W. Geldart and R. Taylor, Canadian J. Phys. **48**, 150 and 167 (1970).
- [69] W. Kohn, Phys. Rev. Lett. **2**, 393 (1959).
- [70] F. Stern, Phys. Rev. Lett. **18**, 546 (1967).
- [71] B. I. Halperin, "Fermion Chern-Simons theory and the unquantized quantum Hall effect," in *Perspectives in Quantum Hall Effects*, S. Das Sarma and A. Pinczuk, eds. (Wiley, N.Y. 1997).
- [72] H.W. Jiang *et al.* Phys. Rev. B **40**, 12013 (1989); R. L. Willet *et al.* Phys. Rev. Lett. **65**, 112 (1990); R. R. Du *et al.*, Phys. Rev. Lett. **70**, 2944 (1993); R. L. Willett *et al.* Phys. Rev. B **47**, 7344 (1993); W. Kang *et al.* Phys. Rev. Lett. **71** 3850 (1993); H. C. Manoharan, M. Shayegan, and S. J. Klepper, Phys. Rev. Lett. **73**, 3270 (1994); R. R. Du *et al.*, Phys. Rev. Lett. **73**, 3274 (1994).

- [73] R. R. Du *et al.* Solid State Comm. **90**, 71 (1994).
- [74] D. R. Leadley, R. J. Nicholas, C. T. Foxon, and J. J. Harris, Phys. Rev. Lett. **72**, 1906 (1994).
- [75] R. L. Willett, R. R. Ruel, K. W. West, and L. N. Pfeiffer, Phys. Rev. Lett. **71**, 3846 (1993).
- [76] V. J. Goldman, B. Su, and J. K. Jain, Phys. Rev. Lett. **72**, 2065 (1994).
- [77] J. K. Jain, Phys. Rev. Lett. **63**, 199 (1989); Phys. Rev. B **41**, 7653 (1990); Science **266**, 1199 (1994).
- [78] B. I. Halperin, P. A. Lee and N. Read, Phys. Rev. B **47**, 7312 (1993).
- [79] A. Lopez and E. Fradkin, Phys. Rev. B **44**, 5246 (1991); *ibid*, **47**, 7080 (1993); Phys. Rev. Lett. **69**, 2126 (1992).
- [80] V. Kalmeyer and S. C. Zhang, Phys. Rev. B **46**, 9889 (1992).
- [81] S. H. Simon and B. I. Halperin, Phys. Rev. B **48**, 17368 (1993)
- [82] R. Shankar and G. Murthy, Phys. Rev. Lett. **79**, 4437 (1997); G. Murthy and R. Shankar, Phys. Rev. Lett. **80**, 5458 (1998); G. Murthy and R. Shankar, to appear in *Composite Fermions*, O. Heinonen, Editor, cond-mat/9802244.
- [83] C. Nayak and F. Wilczek, Nucl. Phys. B **417**, 359 (1994); **430**, 534 (1994).
- [84] S. Chakravarty, R. E. Norton, and O. F. Syljuasen, Phys. Rev. Lett. **74**, 1423 (1995).
- [85] P. Kopietz, Phys. Rev. B **53**, 12761 (1996).
- [86] D. V. Khveshchenko and P. C. E. Stamp, Phys. Rev. Lett. **71**, 2118 (1994); Phys. Rev. B **49**, 5227 (1994).
- [87] P. A. Lee, N. Nagaosa, Phys. Rev. B **46**, 5621 (1992).
- [88] B. Block and H. Monien, Phys. Rev. B **47**, 3454 (1993).
- [89] C. M. Varma, P. B. Littlewood, S. Schmitt-Rink, E. Abrahams, and A. E. Ruckenstein, Phys. Rev. Lett. **63**, 1996 (1989).
- [90] B. L. Altshuler, L. B. Ioffe, and A. J. Millis, Phys. Rev. B **50**, 14048 (1994).
- [91] P. Kopietz, cond-mat/9801145, to appear in Int. J. Mod. Phys.
- [92] J. Gan and E. Wong, Phys. Rev. Lett. **71**, 4226 (1993).
- [93] Y. B. Kim, A. Furusaki, X.-G. Wen, and P. A. Lee, Phys. Rev. B **50**, 17917 (1994).
- [94] A. Maccarone and J. B. Marston, unpublished.

- [95] J. R. Schrieffer, *Theory of Superconductivity*, p. 228 (W. A. Benjamin, New York, 1964).
- [96] A. Stern and B. I. Halperin, Phys. Rev. B **52**, 5890 (1995).
- [97] A. B. Migdal, Sov. Phys. JETP **7**, 996 (1958).
- [98] P. Kopietz and G. E. Castilla, Phys. Rev. Lett. **76**, 4777 (1996); Phys. Rev. Lett. **78**, 314 (1997).
- [99] We thank A. Millis for pointing this out to us.
- [100] B. I. Halperin and A. Stern, “Compressibility of a quantum Hall system at $\nu = 1/2$,” cond-mat/9802061.
- [101] E. Rezayi, private communication. We have corrected a sign error which appeared in equation 124 of a previous publication [H.-J. Kwon, A. Houghton, and J. B. Marston, Phys. Rev. B **52**, 8002 (1995)].
- [102] See, for instance, A. J. Millis, H. Monien, and D. Pines, Phys. Rev. B **42**, 167 (1990); P. Monthoux, A. V. Balatsky, and D. Pines, Phys. Rev. Lett. **67**, 3448 (1991); N. Bulut, D. J. Scalapino, and S. R. White, Physica C **246**, 85 (1995).
- [103] X. G. Wen and P. A. Lee, Phys. Rev. Lett. **76**, 503 (1996); D. H. Kim and P. A. Lee, “Theory of spin excitations in undoped and underdoped cuprates,” cond-mat/9810130.
- [104] S. C. Zhang, Science **275**, 1089 (1997).
- [105] See, for example, J. Zaanen and O. Gunnarsson, Phys. Rev. B **40**, 7391 (1989); S. A. Kivelson and V. J. Emery in *The Los Alamos Symposium-1993: Strongly Correlated Electron Systems*, K. S. Bedell *et al.*, eds. (Addison-Wesley, Menlo Park, 1994); V. J. Emery and S. A. Kivelson, Physica C **263**, 44 (1996); O. Zachar, S. A. Kivelson and V. J. Emery, Phys. Rev. B **57**, 1422 (1995); C. Castellani *et al.*, Phys. Rev. Lett. **75**, 4650 (1995); S. White and D. Scalapino, Phys. Rev. B **55**, 14701 (1997).
- [106] D. S. Dessau *et al.*, Phys. Rev. Lett. **71**, 2781 (1993); Z. X. Shen and D. S. Dessau, Phys. Rep. **253**, 1 (1995). Also see M. R Norman *et al.* Nature **392**, 157 (1998).
- [107] N. Furukawa and T. M. Rice, J. Phys. Condens. Matter **10**, L381 (1998).
- [108] G. Y. Chitov and D. Sénéchal, Phys. Rev. B **52**, 13487 (1995).
- [109] M. A. Baranov, A. V. Chubukov, and M. Yu Kagan, Int. J. of Mod. Phys. B **6**, 2471 (1992).
- [110] P. W. Anderson, Science **235**, 1196 (1987).
- [111] H.-J. Kwon, Phys. Rev. B **55**, 5988 (1997).
- [112] A. Virosztek and J. Ruvalds, Phys. Rev. B **42**, 4064 (1990).

- [113] E. M. Lifshitz and L. P. Pitaevskii, *Statistical Physics*, part 2 (Pergamon, New York, 1980).
- [114] J. Ruvalds *et al.*, Phys. Rev. B **51**, 3797 (1995).
- [115] A. T. Zheleznyak, V. M. Yakovenko, and I. E. Dzyaloshinskii, Phys. Rev. B **55**, 3200 (1997).
- [116] H. Westfahn Jr., A. H. Castro Neto, and A. O. Caldeira, Z. Physik B **103**, 279 (1997).
- [117] S. Conti and G. Vignale, J. Phys. C **10**, L779 (1998).
- [118] A. Maccarone, C. Castellani, C. Di Castro, unpublished.
- [119] H. Ding *et al.*, Phys. Rev. B **54**, 9678 (1996); C. C. Tsuei *et al.*, Nature **387**, 481 (1997); K. A. Kouznetsov *et al.*, Phys. Rev. Lett. **79**, 3050 (1997).
- [120] P. B. Littlewood, and C. M. Varma, Phys. Rev. B **46**, 405 (1992); P. B. Littlewood, J. Zaanen, G. Aeppli, H. Monien, Phys. Rev. B **48**, 487 (1993).
- [121] See, for example, P. A. Lee and T. V. Ramakrishnan, Rev. Mod. Phys. **57**, 287 (1985); C. Castellani, C. Di Castro, and S. Strinati, *Lecture Notes in Physics* **268** (Springer-Verlag, Berlin, 1986); A. M. Finkelstein, Sov. Sci. Rev. A. Phys. **14**, 1 (1990); D. Belitz and T. R. Kirkpatrick, Rev. Mod. Phys. **66**, 261 (1994).
- [122] T. Giamarchi and H. J. Schulz, Europhys. Lett. **3**, 1287 (1987); Phys. Rev. B **37**, 325 (1988). Also see: T. Giamarchi and P. Le Doussal, Phys. Rev. B **53**, 15206 (1996).
- [123] P. Kopietz, J. Phys. Condens. Matter **8**, 10483 (1996).
- [124] D. Belitz and T. R. Kirkpatrick, Phys. Rev. B **56**, 6513 (1997); D. Belitz, F. Evers, and T. R. Kirkpatrick, "Theory of many-fermion systems II: The case of the Coulomb interactions," cond-mat/9803313.