

The generalized multi-channel Kondo model: Thermodynamics and fusion equations

P. Zinn-Justin⁽¹⁾ and N. Andrei^{(2)†}

Laboratoire de Physique Théorique de l'Ecole Normale Supérieure*
24 rue Lhomond, 75231 Paris Cedex 05, France

Abstract

The $SU(N)$ generalization of the multi-channel Kondo model with arbitrary rectangular impurity representations is considered by means of the Bethe Ansatz. The thermodynamics of the model is analyzed by introducing modified fusion equations for the impurity, leading to a simple description of the different IR fixed points of the theory. The entropy at zero temperature is discussed; in particular the overscreened case is explained in terms of quantum group representation.

1/98

⁽¹⁾ pzinn@physique.ens.fr

⁽²⁾ natan@physics.rutgers.edu

† Permanent address: Department of Physics and Astronomy, Rutgers University, Piscataway, NJ 08855, USA

* unité propre du CNRS, associée à l'Ecole Normale Supérieure et l'Université Paris-Sud.

1. Introduction and basic equations

The Kondo model with antiferromagnetic coupling was studied in 1964 [1] and found account for the low-temperature resistivity of metals in which magnetic impurities were present (Kondo effect). The perturbative calculations led to divergences as the temperature was lowered, indicating an inaccessible strong-coupling IR region. This stimulated great theoretical interest in the field. Several approaches were used to study the Kondo effect in more detail [2–4]; here we are particularly interested in the fact that the model, formulated in terms of one dimensional fields, was found to be solvable by Bethe Ansatz techniques [5,6].

In this paper we study the solution of a generalized Kondo model, describing fermions carrying color (spin) and flavor (channel) in the fundamental representations of $SU(N)$ and $SU(f)$ respectively, interacting with a localized impurity. The impurity is in a $(n \times l)$ rectangular representation of the color, and in a trivial representation of the flavor group. The model combines and generalizes the multichannel Kondo Model of Nozieres and Blandin [7] applicable when the impurity orbital structure is taken into account, and the $SU(N)$ version of Coqblin and Schrieffer [8] valid for rare earth materials with strong $j - j$ coupling.

We shall diagonalize the model (section 1); the Bethe-Ansatz basis separates in a natural way into charge, spin, and flavor sectors. This separation, when the interaction with the impurity is turned off, corresponds to the decomposition of the free fermion CFT describing the electrons into a $U(1)$ sector, a $SU(N)$ level f WZW and a $SU(f)$ level N WZW. Only the spin sector interacts non-trivially with the impurity as we shall see by studying the associated Bethe Ansatz Equations. In this sector, we shall find that two symmetries play a key role: the original $SU(N)$ symmetry of the whole theory, and a new hidden quantum group $SU_q(N)$ symmetry where $q = \exp(2i\pi/(f + N))$. These symmetries will naturally appear in the structure of the effective Bethe Ansatz Equations describing this sector. It should be noted that we are here extending the well-known connection between the WZW $SU(N)$ level f theory, i.e. the non-interacting spin sector of the electrons, with quantum group $SU_q(N)$ – through the braiding matrices or the truncated fusion rules – to our interacting (non conformal) theory: the fact that the quantum group symmetry is preserved is probably equivalent to the fact that integrability is preserved.

We shall next briefly study the ground state and the low-lying excitations (section 2), and then move on to the thermodynamics of the system. In order to do so we shall

consider a scaling limit procedure where the linear density of the electrons D , which can be thought of the order of the depth of the Fermi sea, plays the role of a UV cutoff of the theory and is sent to infinity while keeping the physical energy scale, $De^{-2\pi/Nc}$, finite. We can then introduce *fusion equations* dressed by finite temperature for the impurity; we quote equations (3.19):

$$\chi_j^r(\zeta + i\pi/N)\chi_j^r(\zeta - i\pi/N) = \chi_j^{r+1}(\zeta)\chi_j^{r-1}(\zeta) + \chi_{j+1}^r(\zeta)\chi_{j-1}^r(\zeta)e^{-2\delta_{jf}\sin(\pi r/N)e^\zeta}. \quad (1.1)$$

Here ζ is a parametrization of the temperature ($T \propto e^{-\zeta}$) and χ_j^r is the contribution of the impurity whose representation is a rectangular $r \times j$ Young tableau to the (finite temperature) partition function. So this system of equations connects impurities with different spins (intuitively impurities with high spin are made out of smaller spin impurities through the fusion procedure), and it contains all the physics of the model. Indeed we shall use it to compute physically interesting quantities in the low and high temperature regimes (section 4). Finally we shall tackle with the interpretation of the zero temperature entropy (section 5) using quantum group arguments.

1.1. The model.

The Hamiltonian to be studied is,

$$\mathcal{H} = -i \int \bar{\psi}_i^a(x) \partial_x \psi_i^a(x) dx + J \bar{\psi}_i^a(0) \sigma_A^{ab} \psi_i^b(0) \bar{\chi}^\alpha \tau_A^{\alpha\beta} \chi^\beta. \quad (1.2)$$

The energy spectrum of the electrons is taken to be linear in the momentum as we shall be studying universal properties near the Fermi surface.

The electrons are in the fundamental representation σ_A (corresponding to Young tableau consisting of one box), and the impurity in the representation τ_A , given by a rectangular Young tableau with l columns and n rows, $1 \leq n \leq N - 1$. The impurity is a singlet of the flavor group $SU(f)$, while the electrons are in its fundamental representation. The fermionic field $\psi_i^a(x)$ annihilates an electron at x with spin (or color) index a , $a = 1, \dots, N$ and flavor index i , $i = 1, \dots, f$. Note that from the point of view of 2D quantum field theory, there is only one chirality of electrons (“right-movers”). The operator $\bar{\chi}^\alpha \tau_A^{\alpha\beta} \chi^\beta$ represents the impurity spin operator in a representation $\{\tau_A\}$, where the impurity field χ^α is taken to be fermionic and subject to the constraint $\sum_\alpha \bar{\chi}^\alpha \chi^\alpha = 1$. Summation over all indices is implied, $A = 1 \dots N^2 - 1$ being a $\mathfrak{su}(N)$ Lie algebra index.

The interaction with the impurity breaks the $U(fN)$ symmetry of the free hamiltonian down to $U(1)^{charge} \times SU(N)^{spin} \times SU(f)^{flavor}$. It will be implicitly assumed that all the flavor levels are equally populated.

We shall find that the model possesses a variety of IR fixed points, whose nature depends on the symmetry structure in the flavor sector and on the spin representation $n \times l$, generalizing the familiar $N = 2$ case (the multichannel Kondo model [9–11]). We shall identify the mechanism underlying the appearance of these fixed points as *dynamical fusion* by which the electrons form spin complexes whose interaction with the impurity leads to a new behavior in the infrared [10]. These complexes consist of f electrons fused into local objects that transform according to Young Tableaux of one row of length f . These composites interact with the impurity and determine low energy properties of the model.

In the Bethe-Ansatz approach a precise description of the formation of these composites can be given. To do so, a careful cut-off procedure needs to be introduced to allow the formation of the composites while maintaining integrability in the presence of a finite cut-off. The linearized hamiltonian propagates separately the charge-spin-flavor degrees of freedom that make up the electron. Therefore the effect of flavor on the spin degrees of freedom is recovered only in the full space. To follow the dynamic coupling of spin and flavor we add some curvature which maintains the identity of the electron while allowing its components to interact. In the end of the calculation the cut-off is sent to infinity and the curvature removed. Already in the free field theory the resulting theory is quite involved, and even the counting of states is not trivial [12]. However, the resulting basis is the natural one in which to turn on the impurity, it is the zero order approximation in the sense of degenerate perturbation theory.

The scheme consists of the following elements:

- ◇ A second derivative term with a cutoff, Λ ,

$$\mathcal{H}_\Lambda = -\frac{1}{2\Lambda} \int \bar{\psi}_i^a(x) \partial_x^2 \psi_i^a(x) dx. \quad (1.3)$$

This term explicitly provides an energy cut-off. Furthermore, it introduces curvature into the electronic spectrum and breaks charge-spin-flavor (CSF) separation. Once the electron composites are formed, and the low-energy spectrum of the theory is identified, the cutoff is taken to infinity.

Adding the term (1.3) also imposes restrictions on the form of the eigenstates which

can be expressed in terms of the following counterterms without which the model is not integrable for finite Λ .

- ◇ An electron-electron interaction term, of the form

$$2\tilde{J} \int \bar{\psi}_i^a(x) \bar{\psi}_j^b(x) \psi_i^b(x) \psi_j^a(x) dx, \quad (1.4)$$

The term has no effect on the spectrum once the cut off is removed and no impurity is present, independently of the value of the coupling \tilde{J} . The linearized spectrum has a large degeneracy which is removed when the interaction with the impurity is added. The addition of (1.3) and (1.4) provides a way of finding the eigenstates, as we will show below.

- ◇ A counterterm \mathcal{H}_{cc} , of the form

$$\mathcal{H}_{cc} = \frac{1}{\Lambda} \int \bar{\psi}_i^a(x) V(x) \psi_i^a(x) dx, \quad (1.5)$$

with

$$V(x) = \frac{x}{|x|} (\delta'(x^{+0}) + \delta'(x^{-0})), \quad (1.6)$$

needs to be added to the Hamiltonian in order to preserve integrability at the origin; this term vanishes once the cutoff is removed, and plays no further role in the problem.

Eigenstates of (1.2) with N_e electrons and one impurity are of the form

$$|F \rangle = \int \prod_j dx_j F_{\{i_j\},b}^{\{a_j\}}(\{x_j\}) \bar{\chi}_b \prod_{j=1}^{N_e} \bar{\psi}_{i_j}^{a_j}(x_j) |0 \rangle, \quad (1.7)$$

where the fermionic field $\bar{\chi}_b$ creates the impurity at $x = 0$. The amplitude F satisfies the differential equation $h|F \rangle = E|F \rangle$, where the first quantized Hamiltonian h takes the form

$$\begin{aligned} h = & \sum_{j=1}^{N_e} \left\{ -i\partial_j - \frac{1}{2\Lambda} \partial_j^2 + 2J\delta(x_j) \sigma_{A\tau A} \right\} \\ & + \sum_{l < j} 2\tilde{J}\delta(x_l - x_j) (P_{lj} - \mathcal{P}_{jl}) + \sum_{j=1}^{N_e} \frac{1}{\Lambda} V(x_j), \end{aligned} \quad (1.8)$$

with $P_{jl}(\mathcal{P}_{jl})$ being the spin (flavor) exchange operator. When the impurity is also in the fundamental representation, we can write

$$\begin{aligned} h = & \sum_{j=1}^{N_e} (-i\partial_j - (\Lambda^{-1})\partial_j^2 + 2J\delta(x_j) P_{j0}) \\ & + \sum_{l < j} 2\tilde{J}\delta(x_l - x_j) (P_{lj} - \mathcal{P}_{jl}) + \sum_{j=1}^{N_e} \frac{1}{\Lambda} V(x_j). \end{aligned} \quad (1.9)$$

We see that the interaction terms act only when electrons coincide at the same point or at the impurity site. Hence, the eigenstate amplitudes are combinations of plane waves with pseudo-momenta k_j , and have coefficients that depend on the ordering of the electrons and the spin and flavor indices. These coefficients are related through products of electron-electron and electron-impurity S -matrices that we will write below. Here we will only write explicitly the results for an impurity in the fundamental representation.

The electron-impurity S -matrix can be written, to first order in $1/\Lambda$,

$$S_{j0} = e^{i \arctan \frac{c}{1+\lambda_j}} \left(\frac{\lambda_j + 1 - icP_{j0}}{\lambda_j + 1 - ic} \right), \quad (1.10)$$

where

$$\lambda_j = \left(\frac{1 + J^2}{1 - J^2} \right) \frac{k_j}{\Lambda}, \quad c \equiv \frac{2J}{1 - J^2}. \quad (1.11)$$

In the scaling limit, J and c have the same scaling behavior. Notice that (1.10) is trivial in the flavor sector.

The electron-electron S -matrix is of the form

$$S_{jl} = \frac{\lambda_j - \lambda_l - icP_{jl}}{\lambda_j - \lambda_l - ic} \frac{\lambda_j - \lambda_l + icP_{jl}}{\lambda_j - \lambda_l + ic}. \quad (1.12)$$

if we set

$$\tilde{J} = \frac{J}{1 + J^2}, \quad (1.13)$$

Integrability is guaranteed since S_{j0} and S_{jl} satisfy the Yang-Baxter conditions

$$\begin{aligned} S_{jl}S_{j0}S_{l0} &= S_{l0}S_{j0}S_{jl} \\ S_{jl}S_{jk}S_{lk} &= S_{lk}S_{jk}S_{jl} \end{aligned} \quad (1.14)$$

Finally, the energy eigenvalue of a N_e electron state is of the form

$$E = \sum_{j=1}^{N_e} k_j \left(1 + \frac{k_j}{2\Lambda} \right). \quad (1.15)$$

In order to determine the spectrum, we impose periodic boundary conditions, and solve the corresponding eigenvalue problem. The procedure is standard [13] and we skip here the details. The result is contained in the Bethe Ansatz Equations (B.A.E.) which we proceed to write down. Each of the degrees of freedom – charge, spin and flavor – is described by a set of variables whose number depends on the symmetry of the particular state. The charge degrees of freedom are given by the set $\{k_j, j = 1, \dots, N_e\}$. The spin degrees of

freedom are parametrized by the sets $\{\Lambda_\gamma^r, \gamma = 1, \dots, M^r, r = 1, \dots, N-1\}$. Finally, the flavor degrees of freedom are represented by the sets $\{\omega_\gamma^r, \gamma = 1, \dots, \bar{M}^r, r = 1, \dots, f-1\}$. The set of integers $\{M^r, r = 1, \dots, N-1\}$ specify the symmetry of the spin component of the wave function. Similarly, the quantum numbers $\{\bar{M}^r\}$ specify the symmetry of the flavor component.

The equations are: (L size of the periodic space)

$$\begin{aligned}
e^{ik_j L} &= \prod_{\gamma=1}^{M^1} \frac{\Lambda_\gamma^1 - (1 + \lambda_j) + i\frac{c}{2}}{\Lambda_\gamma^1 - (1 + \lambda_j) - i\frac{c}{2}} \prod_{\gamma=1}^{\bar{M}^1} \frac{\omega_\gamma^1 - (1 + \lambda_j) - i\frac{c}{2}}{\omega_\gamma^1 - (1 + \lambda_j) + i\frac{c}{2}}, \\
\left\{ \begin{aligned}
& - \prod_{\beta=1}^{\bar{M}^1} \frac{\omega_\gamma^1 - \omega_\beta^1 + ic}{\omega_\gamma^1 - \omega_\beta^1 - ic} = \prod_{j=1}^{N^e} \frac{\omega_\gamma^1 - (1 + \lambda_j) + i\frac{c}{2}}{\omega_\gamma^1 - (1 + \lambda_j) - i\frac{c}{2}} \prod_{\beta=1}^{\bar{M}^2} \frac{\omega_\gamma^1 - \omega_\beta^2 + i\frac{c}{2}}{\omega_\gamma^1 - \omega_\beta^2 - i\frac{c}{2}}, \\
& - \prod_{\beta=1}^{\bar{M}^r} \frac{\omega_\gamma^r - \omega_\beta^r + ic}{\omega_\gamma^r - \omega_\beta^r - ic} = \prod_{t=r\pm 1} \prod_{\beta=1}^{\bar{M}^t} \frac{\omega_\gamma^r - \omega_\beta^t + i\frac{c}{2}}{\omega_\gamma^r - \omega_\beta^t - i\frac{c}{2}} \quad r = 2, \dots, f-1, \\
& - \prod_{\beta=1}^{M^1} \frac{\Lambda_\gamma^1 - \Lambda_\beta^1 + ic}{\Lambda_\gamma^1 - \Lambda_\beta^1 - ic} = \prod_{j=1}^{N^e} \frac{\Lambda_\gamma^1 - (1 + \lambda_j) + i\frac{c}{2}}{\Lambda_\gamma^1 - (1 + \lambda_j) - i\frac{c}{2}} \prod_{\beta=1}^{M^2} \frac{\Lambda_\gamma^1 - \Lambda_\beta^2 + i\frac{c}{2}}{\Lambda_\gamma^1 - \Lambda_\beta^2 - i\frac{c}{2}}, \\
& - \prod_{\beta=1}^{M^n} \frac{\Lambda_\gamma^n - \Lambda_\beta^n + ic}{\Lambda_\gamma^n - \Lambda_\beta^n - ic} = \frac{\Lambda_\gamma^n + i\frac{c}{2}}{\Lambda_\gamma^n - i\frac{c}{2}} \prod_{t=n\pm 1} \prod_{\beta=1}^{M^t} \frac{\Lambda_\gamma^n - \Lambda_\beta^t + i\frac{c}{2}}{\Lambda_\gamma^n - \Lambda_\beta^t - i\frac{c}{2}}, \\
& - \prod_{\beta=1}^{M^r} \frac{\Lambda_\gamma^r - \Lambda_\beta^r + ic}{\Lambda_\gamma^r - \Lambda_\beta^r - ic} = \prod_{t=r\pm 1} \prod_{\beta=1}^{M^t} \frac{\Lambda_\gamma^r - \Lambda_\beta^t + i\frac{c}{2}}{\Lambda_\gamma^r - \Lambda_\beta^t - i\frac{c}{2}} \quad r = 2, \dots, N-1, r \neq n.
\end{aligned} \right. \tag{1.16}
\end{aligned}$$

The next step is to solve the equations for all possible states, identify the ground state and the low energy excitations above it. Subsequently, by summing over all excitation energies we shall obtain the partition function.

The B.A.E. are a function of the cutoff Λ which eventually is sent to infinity. In this limit the equations reduce to a smaller set once the correct ground state has been identified. It corresponds to *string* solutions (see below) leading to electron composites which interact most efficiently with the impurity. The ground state and low lying excitations lie in a sector of the theory given by solutions of a particular form – *f-strings*. Solutions of this type are $SU(f)$ flavor singlets which allows them to have maximally large $SU(N)$ spin. We shall see that this class of excitations is characterized by a scale $T_0 = De^{-\frac{2\pi}{Nc}}$. When strings are broken to form flavored excitations we expect them to be characterized by other scales which will tend to infinity as the cut-off is removed and thus do not contribute to the impurity dynamics.

The formation of composites in flavor corresponds to solutions of the B.A.E. where the charge parameters, $\{\lambda_j\}$, are complex numbers centered around $\{\omega_\gamma^1\}$. Likewise, rank r flavor parameters are themselves centered around rank $r + 1$ solutions [10]. The form of the charge parameters is,

$$\{\lambda_j, j = 1 \dots N_e\} = \left\{ p_\delta / \Lambda + ic \left(\frac{f+1}{2} - q \right); q = 1, 2, \dots, f, p_\delta \text{ real}, \delta = 1, \dots, N_e/f \right\}. \quad (1.17)$$

while the flavor parameters,

$$\{\omega_\gamma^r, \gamma = 1, 2, \dots, M^r\} = \left\{ p_\delta / \Lambda + iJ \left(\frac{f-r+1}{2} - q \right); q = 1, 2, \dots, f-r, \delta = 1, \dots, N_e/f \right\} \quad (1.18)$$

where $r = 1, \dots, f - 1$. These configurations satisfy the B.A.E. in a trivial manner and induce *fusion* in the B.A.E. equations as well as in the form of the wavefunctions. A string built on momentum p as its real part induces in the wave function a composite of the form $\exp\{-\frac{1}{2}\Lambda J \sum_{j,l} |x_j - x_l| + ip(x_1 + \dots + x_f)\} \times [\dots]$, which becomes local as $\Lambda \rightarrow \infty$. These composites will be described by effective *fused* B.A. Equations obtained by inserting the string configurations into the full B.A.E. After removing the cutoff they become

$$\begin{aligned} \prod_{\substack{\beta=1 \\ \beta \neq \gamma}}^{M^r} \frac{\Lambda_\gamma^r - \Lambda_\beta^r + ic}{\Lambda_\gamma^r - \Lambda_\beta^r - ic} \prod_{t=r \pm 1} \prod_{\beta=1}^{M^t} \frac{\Lambda_\gamma^r - \Lambda_\beta^t - ic/2}{\Lambda_\gamma^r - \Lambda_\beta^t + ic/2} \\ = \left(\frac{\Lambda_\gamma^1 - 1 + ifc/2}{\Lambda_\gamma^1 - 1 - ifc/2} \right)^{N_e \delta^{r1}} \left(\frac{\Lambda_\gamma^n + ilc/2}{\Lambda_\gamma^n - ilc/2} \right)^{\delta^{rn}} \end{aligned} \quad (1.19)$$

for each root Λ_γ^r . N_e is now the number of composites of f electrons (i.e. originally N_e/f). (1.19) will be our starting point for all subsequent calculations.

The energy ε of a composite of f electrons is given by:

$$e^{iL\varepsilon} = \prod_{\gamma=1}^{M^1} \left(\frac{\Lambda_\gamma^1 - 1 + ifc/2}{\Lambda_\gamma^1 - 1 - ifc/2} \right) \quad (1.20)$$

The (irreducible) representation R of the resulting state is given by the numbers M^r of roots of type r ; indeed, each root Λ_γ^r moves one box of the Young tableau down from row r to row $r + 1$. In other words one starts with the empty configuration $M^r = 0$ which corresponds to the highest possible weight (fig. 1).

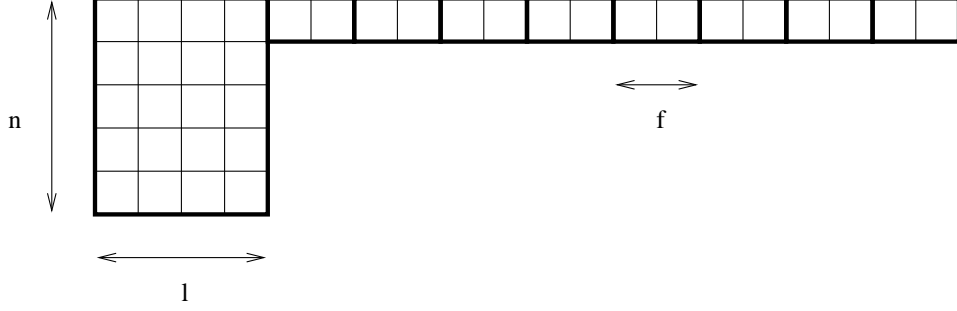

Fig. 1: The highest possible weight of the model.

We call this representation R_0 . Then

$$R = R_0 - \sum_{r=1}^{N-1} M^r \alpha^r \quad (1.21)$$

where $\alpha^r = e^r - e^{r+1}$ is the r^{th} simple root of the Dynkin diagram A_{N-1} (e^a , $a = 1 \dots N$ corresponds to one box in row a of the corresponding Young diagram, see appendix A for more details).

1.2. Continuous B.A.E.

As we are mainly interested in the thermodynamics of this model, we shall immediately write equations in the thermodynamic limit ($N_e \rightarrow \infty$, keeping the density of electrons per unit length $D \equiv N_e/L$ and the densities of roots M^r/L fixed i.e. of the order of some physical energy scale). In this limit, standard calculations lead to continuous B.A.E. Let us briefly derive these in a rather formal way which will minimize the amount of calculations.

We recall that according to the “string hypothesis”, the Λ_γ^r group into strings of roots with the same real part, and a fixed distance of ic between two consecutive roots.

We therefore introduce some notations. We shall need the function

$$\Theta(\Lambda) \equiv \frac{1}{i} \log \frac{\Lambda - ic/2}{\Lambda + ic/2} = 2 \arctan \left(\frac{2\Lambda}{c} \right) + \pi \quad (1.22)$$

where we have specified the determination of the log on the real axis, so that $\Theta(-\infty) = 0$.

We also define its “descendants” generated by strings:

$$\Theta_{k_1, \dots, k_p}(\Lambda) = \sum_{j_1, \dots, j_p} \Theta(\Lambda + ic(j_1 + \dots + j_p)), \quad (1.23)$$

each j_a being an integer (or a half-integer, depending on the parity of k_a) which ranges from $-(k_a - 1)/2$ to $(k_a - 1)/2$. In particular $\Theta_k(\Lambda) = (1/i) \log((\Lambda - ikc/2)/(\Lambda + ikc/2))$.

Again, on the real axis, the analytic structure is chosen so that no cut crosses the real axis and $\Theta_{k_1, \dots, k_p}(-\infty) = 0$.

In the same way we define

$$K(\Lambda) = \frac{1}{2\pi} \frac{d}{d\Lambda} \Theta(\Lambda) = \frac{1}{2\pi} \frac{c}{\Lambda^2 + c^2/4} \quad (1.24)$$

and its descendants K_{k_1, \dots, k_p} .

If $\Lambda_{j;\gamma}^r$ is the center of the γ^{th} string ($1 \leq \gamma \leq M_j^r$) of length j (j positive integer) and of type r ($1 \leq r \leq N-1$), then by multiplying eq. (1.19) for all the j roots of a given string and taking the log, we find:

$$\begin{aligned} 2\pi I_{j;\gamma}^r &= \delta^{r1} N_e \Theta_{f,j}(\Lambda_{j;\gamma}^r - 1) + \delta^{rn} \Theta_{l,j}(\Lambda_{j;\gamma}^r) \\ &- \sum_{k=1}^{\infty} \sum_{\beta=1}^{M_k^r} \Theta_{2,j,k}(\Lambda_{j;\gamma}^r - \Lambda_{k;\beta}^r) + \sum_{t=r\pm 1} \sum_{k=1}^{\infty} \sum_{\beta=1}^{M_k^t} \Theta_{j,k}(\Lambda_{j;\gamma}^r - \Lambda_{k;\beta}^t). \end{aligned} \quad (1.25)$$

The $I_{j;\gamma}^r$ are half-integers of a given parity. Differentiating once with respect to Λ and introducing the densities of roots and holes ρ_j^r and $\tilde{\rho}_j^r$ we get:

$$\tilde{\rho}_j^r + \rho_j^r = \delta^{r1} N_e K_{f,j}(\Lambda - 1) + \delta^{rn} K_{l,j}(\Lambda) - \sum_k K_{2,j,k} \star \rho_j^r + \sum_{t=r\pm 1} \sum_k K_{j,k} \star \rho_k^t \quad (1.26)$$

where \star denotes convolution in Λ space. From now on, unless explicitly stated otherwise, all subscript indices are string indices, running from 1 to ∞ , and all superscript indices are Dynkin diagram indices, running from 1 to $N-1$.

ρ_j^r is normalized by the condition $\sum_j j \int d\Lambda \rho_j^r = \sum_j j M_j^r = M^r$. This is slightly incorrect since the M^r diverge in the thermodynamic limit, only M^r/L is physical; but it simplifies notations.

To simplify even further the form of Eq. (1.26) let us introduce the ‘‘spectral parameter-dependent’’ Cartan matrices C^{qr} , C_{jk} of A_{N-1} , A_∞ and their inverses G^{qr} , G_{jk} .

For $1 \leq q, r \leq N-1$, C^{qr} is defined by

$$C^{qr}(\Lambda) = \delta^{qr} \delta(\Lambda) - (\delta^{qr+1} + \delta^{qr-1}) s(\Lambda) \quad (1.27)$$

where s is the simple function $s(\Lambda) = 1/(2c \cosh(\pi\Lambda/c))$. The same formula holds for C_{jk} , only the boundary conditions $1 \leq j, k < \infty$ being different.

In order to express G^{qr} and G_{jk} we use Fourier transform defined by

$$\phi(\kappa) \equiv \int \phi(\Lambda) \exp(i\kappa 2\Lambda/c) d\Lambda$$

for any function $\phi(\Lambda)$. We have $s(\kappa) = 1/(2 \cosh(\kappa))$, and

$$\begin{aligned} G^{qr}(\kappa) &= G^{rq}(\kappa) = 2 \coth(\kappa) \frac{\sinh((N-q)\kappa) \sinh(r\kappa)}{\sinh(N\kappa)} & q \geq r \\ G_{jk}(\kappa) &= G_{kj}(\kappa) = 2 \coth(\kappa) \exp(-j|\kappa|) \sinh(k\kappa) & j \geq k \end{aligned} \quad (1.28)$$

Eq. (1.26) can be rewritten in a simple manner using these kernels. Let us prove for example that $K_{2,j,k} = G_{jk}$ for $j > k$. One starts with $K_j(\kappa) = \exp(-j|\kappa|)$; then adding the indices k (resp. 2) amounts to multiplying (for convolution) by $\sinh(k\kappa)/\sinh(\kappa)$ (resp. $2 \cosh(\kappa)$), which produces G_{jk} .

Thus, Eq. (1.26) becomes:

$$\tilde{\rho}_j^r + \sum_{q,k} C^{qr} \star G_{jk} \star \rho_k^q = f_j^r \quad (1.29)$$

where by definition $f_j^r \equiv \delta^{r1} N_e K_{f,j}(\Lambda - 1) + \delta^{rn} K_{l,j}(\Lambda)$. Multiplying by C_{jk} we finally find:

$$\sum_k C_{jk} \star \tilde{\rho}_k^r + \sum_q C^{qr} \star \rho_j^q = \delta_{jf} \delta^{r1} N_e s(\Lambda - 1) + \delta_{jl} \delta^{rn} s(\Lambda) \quad (1.30)$$

2. Ground state and low-lying excitations

In this section, we discuss the nature of the ground state and of the physical excitations above the ground state. Before proceeding, the following remark should be made:

In order to get a simple consistent picture (that sheds some light on the thermodynamic results we find in the next sections), we shall intentionally choose to ignore some purely discrete effects which are connected with the exact number of electrons. As an example, let us remember that even in the simplest Bethe Ansatz-solvable model, the $SU(2)$ spin 1/2 XXX model, the ground state representation depends on the parity of the number of spins; but the thermodynamic properties of the model do not depend on it, and one can make the simplifying assumption that it is even. In our case, we shall ignore these effects by allowing the M^r to be sometimes non-integer. Such a procedure should certainly not affect the thermodynamic quantities such as the free energy in the $L \rightarrow \infty$ limit¹.

¹ Note that these effects *will* modify the $1/L$ corrections to the free energy, which are themselves of the same order as the free energy of the impurity (cf Eq. (3.3) of next section); but the latter should be unaffected at leading order.

2.1. Energy.

According to (1.20), the energy (without any magnetic field) is given by:

$$\begin{aligned}
E &= -D \sum_{\gamma=1}^{M^1} \Theta_f(\Lambda_\gamma^1 - 1) \\
&= -D \sum_j \sum_{\gamma=1}^{M_j^1} \Theta_{f,j}(\Lambda_{j;\gamma}^1 - 1) \\
&= -D \sum_j \int d\Lambda \rho_j^1(\Lambda) \Theta_{f,j}(\Lambda - 1).
\end{aligned} \tag{2.1}$$

($D = N_e/L$). For future use we shall rewrite this

$$E = \sum_{j,r} \int d\Lambda \rho_j^r(\Lambda) g_j^r(\Lambda) \tag{2.2}$$

where $g_j^r(\Lambda) \equiv -D\delta^{r1}\Theta_{f,j}(\Lambda - 1)$.

The energy can also be expressed in terms of $\tilde{\rho}$:

$$\begin{aligned}
E &= -D \sum_{r,j,k} \int d\Lambda C_{jk} \star G^{r1} \star (-\tilde{\rho}_k^r + f_k^r) \Theta_{f,j}(\Lambda - 1) \\
&= E_{\text{g.s.}} + D \sum_r \int d\Lambda \tilde{\rho}_f^r(\Lambda) G^{r1} \star \left[2 \arctan(e^{\pi(\Lambda-1)/c}) \right].
\end{aligned} \tag{2.3}$$

which we can again rewrite under the form

$$E = E_{\text{g.s.}} + \sum_{r,j} \int d\Lambda \tilde{\rho}_j^r(\Lambda) \tilde{g}_j^r(\Lambda) \tag{2.4}$$

where explicitly:

$$\tilde{g}_j^r \equiv D\delta_{jf} \left[2 \arctan \left(\tan \left(\frac{\pi}{2} \frac{N-r}{N} \right) \tanh \left(\frac{\pi}{Nc} (\Lambda - 1) \right) \right) + \pi \frac{N-r}{N} \right] \tag{2.5}$$

We first give a brief explanation of (2.3)–(2.4). $E_{\text{g.s.}}$ is the energy of the ground state. It is obtained for $\tilde{\rho}_f^r = 0$, that is the ground state is filled with the maximum amount of f -strings; we shall build it explicitly in 2.3. Above the ground state, excitations are created by holes in the sea of f -strings; the other strings do not contribute to the energy. Their role should become transparent in next subsection.

Let us also see what happens in the scaling limit, when the density of electrons per unit length D , which will eventually become the UV cutoff of our theory, is sent to infinity; then, a typical state of our system will have densities per unit length of f -strings M_f^r/L that will be of order D and will diverge. On the other hand, densities of *holes* of f -strings \tilde{M}_f^r/L , and of j -strings M_j^r/L ($j \neq f$) will remain of the order of the physical energy scale. We have already rewritten the energy $E - E_{\text{g.s.}}$ in terms of the $\tilde{\rho}_f^r$ only, whose densities remain finite. It is interesting to do the same thing for the quantum numbers characterizing the $SU(N)$ representation of the state.

2.2. Representation of a state.

We have seen that a Bethe Ansatz state is in the representation $R = R_0 - \sum_r M^r \alpha^r$, where the M^r are the numbers of roots of type r : $M^r = \sum_j j M_j^r$. A better way to describe the corresponding $SU(N)$ Young tableau is to count the number of columns n^r of a given length r ($1 \leq r \leq N - 1$). One can easily show the following relation (cf appendix A for more details):

$$n^r = \delta^{r1} N_e f + \delta^{rn} l - 2 \sum_{j,q} C^{qr} j M_j^q \quad (2.6)$$

Here C^{qr} stands for $C^{qr}(\kappa = 0)$, that is (up to a factor of 2) the usual Cartan matrix of $SU(N)$.

We shall now relate the quantum numbers n^r to the numbers of holes $\tilde{M}_f^r = \int \tilde{\rho}_f^r$ and of strings M_j^r ($j \neq f$).

We start from equation (1.29) with $j = f$, which we integrate from $-\infty$ to $+\infty$ (i.e. take $\kappa = 0$):

$$\tilde{M}_f^r + \sum_q C^{qr} G_{ff} M_f^q + \sum_{k \neq f, q} C^{qr} G_{kf} M_k^q = G_{ff} \delta^{r1} \frac{N_e}{2} + G_{fl} \delta^{rn} \frac{1}{2} \quad (2.7)$$

where the argument $\kappa = 0$ is implied for all kernels. Using this formula, one can easily compute the sum of eq. (2.6). We give the final result:

$$n^r = \begin{cases} \tilde{M}_f^r - \sum_{j>f,q} (j-f) 2 C^{qr} M_j^q & l \leq f \\ \tilde{M}_f^r - \sum_{j>f,q} (j-f) 2 C^{qr} M_j^q + (l-f) \delta^{rn} & l \geq f \end{cases} \quad (2.8)$$

The first observation is that we must treat separately the underscreened case ($l \geq f$) and the overscreened case ($l \leq f$): this is directly related to the representation/degeneracy of the ground state, which we shall discuss in next subsection.

Notice next that the role of the j -strings, $j > f$, which did not contribute to the energy, is now clear: they allow to lower the spin of the system at fixed energy, i.e. fixed physical excitations². This is the usual way, in Bethe Ansatz systems, to select between the different irreducible subrepresentations inside the tensor product of the representations of the physical excitations (without any j -strings, $j > f$, the system is in the highest possible weight representation).

On the other hand the j -strings ($j < f$) do not change the representation of the state: in fact they play a role which is quite similar to the j -strings ($j > f$), but for an other quantum number which can be associated with a state, its $SU_q(N)$ representation ($q = \exp(2i\pi/(f + N))$), so that the set of representations is “restricted to level f ”). We shall elaborate on this new quantum number in section 5.

2.3. The ground state.

According to Eq. (2.3), the ground state is obtained for $\tilde{\rho}_f^r = 0$. This means that the ground state is filled with a continuous density of f -strings of all types $r = 1 \dots N - 1$. It can then be shown that there are no j -strings ($j \neq f$); this allows to calculate the densities ρ_f^r from (1.29):

$$\rho_f^r(\Lambda) = N_e G^{r1} \star s(\Lambda - 1) + G^{rn} \star (G_{ff})^{-1} \star K_{lf}(\Lambda) \quad (2.9)$$

We shall now discuss separately the different cases:

- $f \leq l$ (underscreening). We first compute the ground state representation. Applying (2.8) to the ground state, we find the following Young tableau (fig. 2).

Let us try to interpret intuitively this Young tableau. First there are a large number (of order N_e) of electrons that are not directly interacting with the impurity: they are represented by the “trivial” part (i.e. N rows) of the Young tableau, to the left of the impurity. Then there are exactly $N - n$ fused electrons which can be thought as on the same site as or glued to the impurity: Their effect is to reduce its spin from $n \times l$ to $n \times (l - f)$. To confirm this analysis, one can calculate the density of holes of j -strings $\tilde{\rho}_j^r$; one finds:

$$\tilde{\rho}_j^r(\Lambda) = \delta^{rn} (K_{l,j}(\Lambda) - G_{jf} \star (G_{ff})^{-1} K_{f,l}(\Lambda)) \quad (2.10)$$

² It is known that for a small number of excitations, the complex roots (non- f -strings) do not necessarily form exact j -strings: the spacing of their imaginary parts might deviate from the string behavior. However this does not modify qualitative analysis.

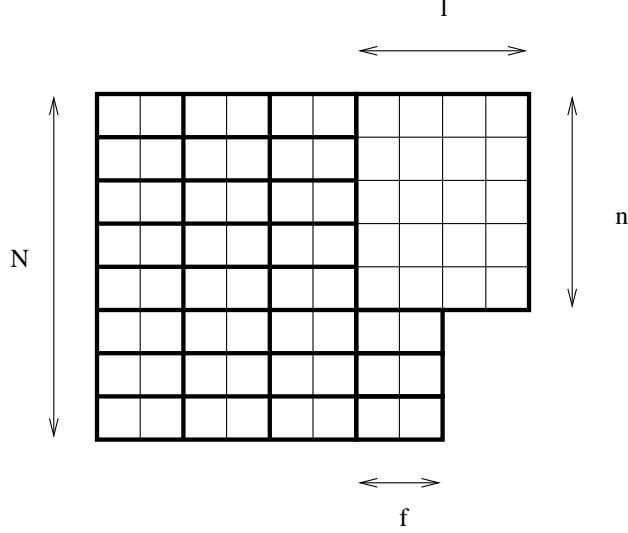

Fig. 2: Underscreening of the impurity by the electrons. On this example, 3 fused $f = 2$ electrons screen the 5×4 impurity, reducing its spin to 5×2 .

For $j > f$, $\tilde{\rho}_j^n \neq 0$ so there are holes of j -strings; but one can check that there are “not enough” to actually create j -strings (this confirms the fact that the ground state cannot contain j -strings). The interpretation of this result is the following: the underscreened impurity is in a given irreducible representation of $SU(N)$, so its spin cannot be changed. However, if one adds one physical excitation into the system, it will create more holes of j -strings and allow creation of j -strings: that is so because the tensor product of the (non trivial) representation of the impurity and of another non trivial representation is necessarily reducible, and the choice between the different irreducible subrepresentations is made, as has already been mentioned, by inserting appropriate j -strings (cf Eq. (2.8)).

On the other hand, for $j < f$, one finds from (2.10) that $\tilde{\rho}_j^r = 0$: the screened impurity possesses a trivial $SU_q(N)$ quantum number.

- $f \geq l$ (overscreening). This time Eq. (2.8) implies that the ground state is in the trivial representation, which is not what one might naively expect; indeed, by minimizing only the interaction part $J\bar{\psi}_i^a(0)\sigma_A^{ab}\psi_i^b(0)\bar{\chi}^\alpha\tau_A^{\alpha\beta}\chi^\beta$ of the Hamiltonian, one would obtain a different ground state representation [14]. Let us mention now that what this proves is that the RG fixed point $J = \infty$ is unstable to the kinetic part of the Hamiltonian and that we have a non-trivial IR fixed point $J = J^*$. This will be explained more carefully when we study the thermodynamics of the model.

One can again calculate the densities of holes of j -strings: the formula (2.10) is still valid; but the analysis is reversed. For $j > f$, one find $\tilde{\rho}_j^r = 0$, which confirms the fact that

the ground state is in the trivial representation. On the contrary we now have holes of j -strings for $j < f$: the impurity possesses a non-trivial $SU_q(N)$ quantum number, though it originally possessed none. Of course its origin is related to the presence of the electrons that screen the impurity. We shall discuss this in detail when we consider the entropy at zero temperature.

2.4. Physical excitations.

We have already mentioned that physical spin excitations are created by inserting holes of f -strings. As there are $N - 1$ types of holes, we conclude that there are $N - 1$ types of physical particles labeled by $r = 1 \dots N - 1$. The rapidity Λ at which the hole is inserted determines the energy and momentum of the corresponding excitation. We have already given in 2.1 the energy $\epsilon^r(\Lambda) = \tilde{g}_f^r(\Lambda)$: (Eq. (2.5))

$$\epsilon^r(\Lambda) = D \left[2 \arctan \left(\tan \left(\frac{\pi}{2} \frac{N-r}{N} \right) \tanh \left(\frac{\pi}{Nc} (\Lambda - 1) \right) \right) + \pi \frac{N-r}{N} \right] \quad (2.11)$$

As $\epsilon^r(-\infty) = 0$, these are massless excitations. From general arguments it is clear that they have a linear dispersion relation, so that their momentum $p^r = \epsilon^r$. This can also be easily extracted from the Bethe Ansatz equations by writing a phase shift condition on a compactified space for one single physical excitation.

We may at this point go to the scaling limit $D \rightarrow \infty$, $c \rightarrow 0$ keeping the physical scale $T_0 \equiv D e^{-2\pi/Nc}$ fixed. The energy/momentum then takes the simple form:

$$\epsilon^r = p^r = 2T_0 \sin \left(\frac{\pi r}{N} \right) e^{2\pi\Lambda/Nc} \quad (2.12)$$

which is characteristic of a relativistic (massless) right-moving particle, with $2\pi\Lambda/Nc$ its rapidity.

We also know their representation from 2.2: according to Eq. (2.8), inserting a hole of type r creates a column of size r in the corresponding Young tableau; that is, the particle of type r belongs to the fundamental (or totally antisymmetric) representation of $SU(N)$ with r boxes. It can also be shown that they belong to the same representation of the quantum group $SU_q(N)$.

These particles interact with each other and with the impurity, which leads to the concept of phaseshift. The latter can be extracted from the Bethe Ansatz equations; however, we postpone their detailed study to a future publication.

3. Thermodynamic Bethe Ansatz equations (T.B.A.)

We now want to study the model at finite temperature T ($T \gg 1/L$). In the standard way, one derives the T.B.A. by minimizing the free energy $F = E - TS$ with respect to ρ_j^r ; using (1.29) one finds that $\delta S/\delta \rho_j^r$ equals: ($\eta_j^r \equiv \tilde{\rho}_j^r/\rho_j^r$)

$$\log(1 + \eta_j^r) - \sum_{q,k} C^{qr} \star G_{jk} \star \log(1 + (\eta_k^q)^{-1}) = \frac{g_j^r}{T} \quad (3.1)$$

where we have used $g_j^r = \delta E/\delta \rho_j^r$, the energy of a j -string of type r (Eq. (2.2)). Note that the T.B.A. do not depend on the representation of the impurity. In fact one can say that the T.B.A. only describe the electrons (in a way appropriate for studying their interaction with the impurity) and not the impurity itself. On the contrary, the fusion equations that will be written later describe specifically the impurity.

3.1. Free energy.

General T.B.A. formulae imply that

$$\begin{aligned} F &= -T \sum_{j,r} \int d\Lambda f_j^r(\Lambda) \log(1 + (\eta_j^r(\Lambda))^{-1}) \\ (\text{using T.B.A.}) &= - \sum_{j,k,q,r} \int d\Lambda G^{qr} \star C_{jk} \star f_k^q(\Lambda) [-g_j^r(\Lambda) + T \log(1 + \eta_j^r(\Lambda))] \end{aligned} \quad (3.2)$$

The first term is the ground state energy. In the second term, the explicit expression of f_k^q leads to

$$F = E_{\text{g.s.}} + L\mathcal{F} + F_l^n, \quad (3.3)$$

where \mathcal{F} is the free energy per unit length of the electrons:

$$\mathcal{F} = -DT \sum_r \int d\Lambda \widehat{G}^{r1}(\Lambda - 1) \log(1 + \eta_f^r(\Lambda)) \quad (3.4)$$

and F_l^n is the free energy of the impurity:

$$F_l^n = -T \sum_r \int d\Lambda \widehat{G}^{rn}(\Lambda) \log(1 + \eta_l^r(\Lambda)). \quad (3.5)$$

Here we have introduced a new notation which will prove convenient: $\widehat{G}^{qr}(\Lambda) \equiv G^{qr} \star s(\Lambda)$; \widehat{G}^{qr} has the following Fourier transform:

$$\widehat{G}^{qr}(\kappa) = \widehat{G}^{rq}(\kappa) = \frac{\sinh((N - q)\kappa) \sinh(r\kappa)}{\sinh(\kappa) \sinh(N\kappa)} \quad q \geq r \quad (3.6)$$

3.2. Scaling limit.

We now take the limit $c \rightarrow 0$, $D \rightarrow \infty$, keeping $T_0 \equiv D e^{-2\pi/Nc}$ fixed; T_0 is the dynamically generated energy scale due to the presence of the impurity. We rewrite the T.B.A. equations (3.1) under the form

$$\log(1 + (\eta_j^r)^{-1}) - \sum_{q,k} G^{qr} \star C_{jk} \star \log(1 + \eta_k^q) = \frac{\tilde{g}_j^r}{T} \quad (3.7)$$

which become in the scaling limit (Eq. (2.12))

$$\log(1 + (\eta_j^r)^{-1}) - \sum_{q,k} G^{qr} \star C_{jk} \star \log(1 + \eta_k^q) = 2\delta_{jf} \sin\left(\frac{\pi r}{N}\right) e^\zeta \quad (3.8)$$

where we have successively rescaled³ and shifted the rapidity:

$$\zeta = \frac{2\pi\Lambda}{Nc} + \log(T_0/T). \quad (3.9)$$

The shift removes any dependence of the T.B.A. on T . The qualitative picture of the behavior of these equations is then the following: there are two asymptotic regimes $\zeta \rightarrow \pm\infty$ characterized by limiting values $\eta_j^r(\pm\infty)$. We shall derive these values in the next subsection, once we have explained their group-theoretic meaning.

As the crossover between the two regimes occurs for $\zeta \approx 0$ that is $\frac{2\pi}{Nc}\Lambda \approx \log(T/T_0)$, $\zeta \rightarrow -\infty$ will be called the high-temperature regime, whereas $\zeta \rightarrow +\infty$ will be the low-temperature regime.

Let us also rewrite the free energy in terms of the new variable: we use for example $\widehat{G}^{r1}(\Lambda) = (1/Nc) \sin(\pi r/N) / (\cosh((2\pi/Nc)\Lambda) - \cos(\pi r/N))$:

$$\begin{aligned} \mathcal{F} &= -\frac{T^2}{\pi} \sum_r \sin\left(\frac{\pi r}{N}\right) \int d\zeta e^\zeta \log(1 + \eta_f^r(\zeta)) \\ F_l^n &= -T \sum_r \int d\zeta \widehat{G}^{rn}(\zeta - \log(T_0/T)) \log(1 + \eta_l^r(\zeta)) \end{aligned} \quad (3.10)$$

The fact that T_0 only appears in the free energy of the impurity indicates that it is the presence of the impurity which triggered the energy scale dynamical generation.

³ Note that the rescaling also induces a rescaling of the kernels, according to the rule $\phi(\zeta)d\zeta = \phi(\Lambda)d\Lambda$.

3.3. Fusion equations and interpretation of limiting values.

We shall now work with the T.B.A. equations (3.8), i.e. after the scaling limit has been taken. Let us see how these equations are related to fusion equations for rectangular Young tableaux. The first step is to analytically continue the functions η_j^r to the strip $|\text{Im } \zeta| \leq \pi/N$, so that they possess no zeros or poles for $|\text{Im } \zeta| < \pi/N$. Then $\log(1 + \eta_j^r)$ and $\log(1 + (\eta_j^r)^{-1})$ can also be continued in the same way. For any function that satisfies this analyticity requirement one can then define an inverse operator of \widehat{G}^{qr} which we of course denote by \widehat{C}^{qr} ; this operator is *not* a convolution kernel since it acts in the following way:

$$\widehat{C}^{qr} \star \phi(\zeta) = \delta^{qr} (\phi(\zeta + i\pi/N) + \phi(\zeta - i\pi/N)) - (\delta^{qr+1} + \delta^{qr-1}) \phi(\zeta) \quad (3.11)$$

\widehat{C}^{qr} can be considered as a discrete Laplace operator in (r, ζ) space. As $\widehat{G}^{qr} = G^{qr} \star s$, one should have $C^{qr} = \widehat{C}^{qr} \star s$: this is indeed the case on condition that one correctly remains inside the analyticity strip when performing the convolution integral (fig. 3).

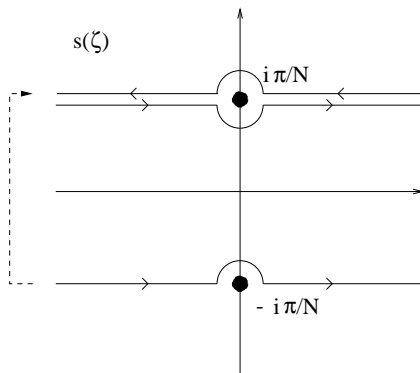

Fig. 3: $s(\zeta) = N/(4\pi \cosh(N\zeta/2))$ has poles at $\zeta = \pm i\pi/N$, so that when one considers the convolution kernel $s(\zeta + i\pi/N) + s(\zeta - i\pi/N)$, one should deform the integration contour so as to remain inside the analyticity strip. Then due to $2i\pi/N$ -antiperiodicity only the pole contribution at $\zeta = +i\pi/N$ remains, so that $s(\zeta + i\pi/N) + s(\zeta - i\pi/N) = \delta(\zeta)$.

We now take eq. (3.8) and act on it with \widehat{C}^{qr} : this annihilates the r.h.s. and we find after exponentiation:

$$\eta_j^r(\zeta + i\pi/N) \eta_j^r(\zeta - i\pi/N) = \frac{[1 + \eta_{j+1}^r(\zeta)] [1 + \eta_{j-1}^r(\zeta)]}{[1 + (\eta_j^{r+1}(\zeta))^{-1}] [1 + (\eta_j^{r-1}(\zeta))^{-1}]} \quad (3.12)$$

This system of equations (“Y-system”) [15] is well-known to be related to $SU(N)$ “spectral parameter-dependent” fusion equations [16]. For now, we simply note the “rank-level

duality” of these equations: $j \leftrightarrow r$, $\eta \leftrightarrow \eta^{-1}$. In fact, we have to be careful because of the non-trivial r.h.s. of Eq. (3.8), which does not appear in the framework of normal fusion equations. We shall therefore proceed with caution and rederive the fusion equations from the very beginning. First we introduce the generalized characters

$$\chi_j^r(\zeta) \equiv \exp \left[\sum_q \widehat{G}^{qr} \star \log(1 + \eta_j^q) \right] \quad (3.13)$$

(we call them generalized characters because normal characters are the solutions of the standard fusion equations, whereas here we deal with modified fusion equations). Notice the similarity with Eq. (3.5) or (3.10): one has

$$\log \chi_l^n(\zeta) = -\frac{1}{T} F_l^n(T = T_0 e^{-\zeta}) \quad (3.14)$$

In fact, as the T.B.A. equations do not depend on the representation of the impurity, one can consider that the χ_j^r , for *any* values of r and j , are related to the free energy F_j^r of an impurity in the representation $r \times j$ (r rows, j columns) !

One can invert relation (3.13) using the definition of \widehat{C}^{qr} :

$$1 + \eta_j^r(\zeta) = \frac{\chi_j^r(\zeta + i\pi/N) \chi_j^r(\zeta - i\pi/N)}{\chi_j^{r+1}(\zeta) \chi_j^{r-1}(\zeta)} \quad (3.15)$$

(χ_j^0 and χ_j^N are by convention equal to 1). So far we have not used the T.B.A. (3.8) yet. We now do so in order to derive “dual” (in the sense of rank-level duality) expressions for $1 + (\eta_j^r)^{-1}$. First we introduce a \widehat{C}_{jk} defined by the same formula (3.11), and such that $\widehat{C}_{jk} \star s = C_{jk}$. As $G^{qr} \star C_{jk} = \widehat{G}^{qr} \star \widehat{C}_{jk}$, the insertion of the definition of the characters in (3.8) gives:

$$\log(1 + (\eta_j^r)^{-1}) = \sum_k \widehat{C}_{jk} \star \log \chi_k^r + 2\delta_{jf} \sin\left(\frac{\pi r}{N}\right) e^\zeta \quad (3.16)$$

Notice the additional term due to the r.h.s. of (3.8), which leads to the following modified formula:

$$1 + (\eta_j^r(\zeta))^{-1} = \frac{\chi_j^r(\zeta + i\pi/N) \chi_j^r(\zeta - i\pi/N)}{\chi_{j+1}^r(\zeta) \chi_{j-1}^r(\zeta)} e^{2\delta_{jf} \sin(\pi r/N) e^\zeta} \quad (3.17)$$

($\chi_0^r \equiv 1$) or finally

$$\eta_j^r(\zeta) = \frac{\chi_{j+1}^r(\zeta) \chi_{j-1}^r(\zeta)}{\chi_j^{r+1}(\zeta) \chi_j^{r-1}(\zeta)} e^{-2\delta_{jf} \sin(\pi r/N) e^\zeta}. \quad (3.18)$$

This, with the boundary conditions $\chi_j^0 = \chi_j^N = 1$ and $\chi_0^r = 1$, allows to compute $\eta_j^r(\zeta)$ as a function of the $\chi_k^t(\zeta)$. Remembering that χ_k^t is directly related to the free energy of an

impurity in the representation $t \times k$, one can consider that one puts “test” impurities (corresponding to any rectangular Young tableau) in the system in order to find the characters χ_j^r , and from there the functions η_j^r .

One can now proceed to write down modified fusion equations for the χ_j^r : rewriting the trivial identity (3.15) = 1 + (3.18) we find

$$\chi_j^r(\zeta + i\pi/N)\chi_j^r(\zeta - i\pi/N) = \chi_j^{r+1}(\zeta)\chi_j^{r-1}(\zeta) + \chi_{j+1}^r(\zeta)\chi_{j-1}^r(\zeta)e^{-2\delta_{jf}\sin(\pi r/N)e^\zeta}. \quad (3.19)$$

This system of coupled non-linear equations can be represented by fig. 4.

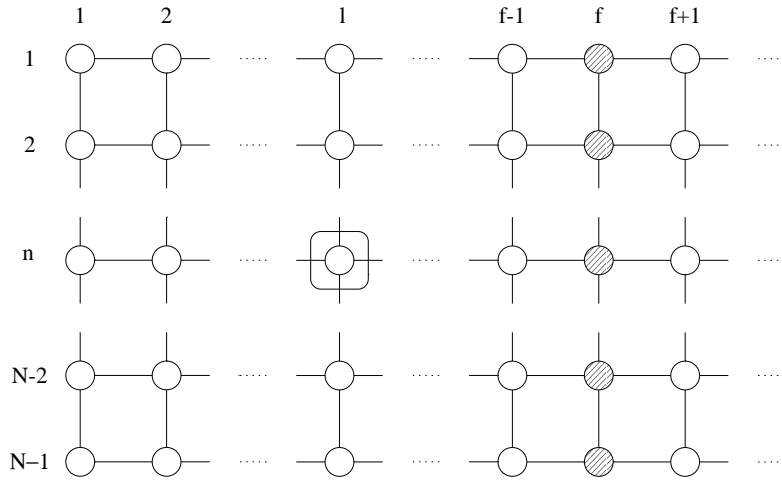

Fig. 4: Pictorial representation of the modified fusion equations. The marked circles correspond to the position of the modified term. The square around the circle n, l means that it is χ_l^n which gives the free energy of the impurity.

Just like the T.B.A. equations, the fusion equations contain all the physics of the Kondo model. In fact, it is the additional term $\exp(-2\delta_{jf}\sin(\pi r/N)e^\zeta)$ which really contains all the information on the crossover from the low-temperature regime to the high-temperature regime. We shall elaborate on this in next section which contains all the calculations of thermodynamic quantities.

For the moment, in order to see the role of the additional term in a very simple setting, let us consider the limits $\zeta \rightarrow \pm\infty$; then the shifts of $\pm i\pi/N$ of ζ become negligible, which means that the equations (3.19) reduce to $SU(N)$ tensor product equations for rectangular Young tableaux, and the χ_j^r tend to asymptotic values $\chi_j^r(\pm\infty)$ which should be ordinary $SU(N)$ characters. We now compute these values in the absence of magnetic field:

- When $\zeta \rightarrow -\infty$, the modification induced by the r.h.s. of (3.8) vanishes and one simply obtains ordinary tensor product equations for any $j \geq 1$ and r . Therefore

$$\chi_j^r(-\infty) = \chi_j^r(G) \quad (3.20)$$

where $\chi_j^r(G)$ is the character associated with some matrix $G \in SU(N)$ and the rectangular Young tableau $r \times j$ (cf appendix A for a definition).

The constraint that $\eta_j^r > 0$ (i.e. $\chi_j^r > 0$) for all r and j , the boundary conditions $\chi_0^r = 1$, $\chi_{-1}^r = 0$ and the asymptotic behavior of χ_j^r as $j \rightarrow \infty$ (we shall work out the latter in the more general case of the presence of a magnetic field, see 3.4) lead to the unique solution $G = 1_{SU(N)}$, i.e. the T.B.A. select the Perron-Frobenius eigenvalue of the tensor product matrix corresponding to the Young tableau $r \times j$. This gives the following values of $\eta_j^r(-\infty)$:

$$\eta_j^r(-\infty) = \frac{j(j+N)}{r(N-r)}. \quad (3.21)$$

- When $\zeta \rightarrow +\infty$, the fusion equations (3.19) are cut in two separate parts: for $j \leq f$, we can consider that we have normal fusion equations with the additional boundary condition $\chi_{f+1}^r = 0$; this, with the usual boundary conditions $\chi_0^r = 1$, $\chi_{-1}^r = 0$, implies that

$$\chi_j^r(+\infty) = \chi_j^r(G_f) \quad j \leq f \quad (3.22)$$

where G_f is a $SU(N)$ matrix which can be uniquely determined by imposing $\eta_j^r > 0$: ($\theta \equiv \pi/(f+N)$)

$$G_f = \begin{pmatrix} e^{i(-N+1)\theta} & & & & 0 \\ & e^{i(-N+3)\theta} & & & \\ & & \ddots & & \\ & & & e^{i(N-3)\theta} & \\ 0 & & & & e^{i(N-1)\theta} \end{pmatrix} \quad (3.23)$$

We shall see in section 5 that this character can again be interpreted as the Perron-Frobenius eigenvalue of an appropriately truncated (at level f) tensor product matrix.

For $j > f$, this time everything happens as if $\chi_{f-1}^r = 0$. Together with $\chi_f^r = 1$ (this comes out of (3.22)-(3.23)) and the asymptotic behavior of χ_j^r as $j \rightarrow \infty$, it reproduces the boundary conditions found in the limit $\zeta \rightarrow -\infty$, except for a shift of f in the string index. Therefore:

$$\chi_j^r(+\infty) = \chi_{j-f}^r(1_{SU(N)}) \quad j > f \quad (3.24)$$

Finally,

$$\eta_j^r(+\infty) = \begin{cases} \frac{\sin(j\theta) \sin((j+N)\theta)}{\sin(r\theta) \sin((N-r)\theta)} & 1 \leq j \leq f \\ \frac{(j-f)(j-f+N)}{r(N-r)} & j \geq f \end{cases} \quad (3.25)$$

3.4. Magnetic field.

In a $SU(N)$ -invariant model, the most general magnetic field B one can impose is an arbitrary element of the Lie algebra $\mathfrak{su}(N)$:

$$B = \sum_{A=1}^{N^2-1} B_A T_A \quad (3.26)$$

where the T_A are the generators of $\mathfrak{su}(N)$ acting on the whole Hilbert space of our model. Using the $SU(N)$ symmetry one can suppose that B belongs to the Cartan subalgebra; this means that B can be described in the fundamental representation of $SU(N)$ as the diagonal matrix:

$$B = \begin{pmatrix} B^1 & & & 0 \\ & B^2 & & \\ & & \ddots & \\ 0 & & & B^N \end{pmatrix} \quad (3.27)$$

with the condition $B^1 + B^2 + \dots + B^N = 0$. One still has a residual symmetry of permutation of the eigenvalues of B which allows to choose: $B^1 < B^2 < \dots < B^N$. This choice will prove convenient later. Of course in the $SU(2)$ case B has only two eigenvalues $B^1 \equiv -B$ and $B^2 = B$, and we recover the usual one-component magnetic field.

The effect of the magnetic field is that, for a given Bethe Ansatz solution belonging to an irreducible representation R (characterized by its highest weights, or by the numbers M^r), the states with different $SU(N)$ quantum numbers (weights) have a different energy. In other words, the corresponding energy level E has been split in several levels; the resulting contribution to the partition function then factorizes: $Z = Z_B Z_{\mathcal{H}}$, with $Z_{\mathcal{H}} = \exp(-E/T)$ and

$$Z_B = \chi_R(e^{-B/T}) \quad (3.28)$$

where $e^{-B/T}$ is the diagonal matrix with eigenvalues $e^{-B^a/T}$, and χ_R denotes the character of the representation R . Fortunately, this expression simplifies in the thermodynamic limit, when one deals with large Young tableaux: then, one can show (see appendix A) that

$$Z_B \propto e^{-\sum_{r=1}^{N-1} M^r b^r / T} \quad (3.29)$$

Here one has used the ordering of the B^a , and defined $b^r = B^{r+1} - B^r$. Hence, $-b^r$ effectively acts as a *chemical potential* for the r^{th} type of B.A. roots⁴.

The change induced by the addition of a magnetic field in the T.B.A. is straightforward: the r.h.s. of (3.1) is now:

$$\frac{g_j^r}{T} = -\frac{D}{T} \delta^{r1} \Theta_{f,j}(\Lambda - 1) + j \frac{b^r}{T} \quad (3.30)$$

The other equations (3.2)–(3.19) are unchanged: the presence of the magnetic field is hidden in the asymptotics of η_j^r as $j \rightarrow \infty$. Starting from (3.1), simple manipulations show that

$$\lim_{j \rightarrow \infty} K_j \star \log(1 + \eta_{j+1}^r) - K_{j+1} \star \log(1 + \eta_j^r) = \frac{b^r}{T} \quad (3.31)$$

or for the characters

$$\lim_{j \rightarrow \infty} K_j \star \log \chi_{j+1}^r - K_{j+1} \star \log \chi_j^r = \sum_{a=1}^r \frac{B^a}{T}. \quad (3.32)$$

4. Calculation of thermodynamic quantities.

We shall work directly with the χ_j^r and the fusion equations (3.19) they satisfy, since they will provide us with the free energy of the impurity, through the correspondence (3.14) that we recall:

$$F_l^n(T) = -T \log \chi_l^n(\zeta = \log(T_0/T)). \quad (4.1)$$

4.1. High temperature ($T \gg T_0$).

The high temperature behavior is governed by the $\zeta \rightarrow -\infty$ region of the T.B.A. In this region, the modified fusion equations become “free” in the sense that the extra term of Eqs. (3.19) $\exp(-2\delta_{jf} \sin(\pi r/N) T_0/T) = 1$ up to $1/T$ corrections. Let us see what this means physically for the impurity:

When a magnetic field is present, one can show that the solution (3.20) of the fusion equations is still valid, except that the matrix G is no more restricted to be in $SU(N)$ (only in $SL(N)$); in fact, the choice

$$G = e^{-B/T} \quad (4.2)$$

⁴ Actually, even for $B = 0$, Z_B gives an additional entropic factor in the partition function that we have not taken into account so far. But its effect is negligible in the thermodynamic limit: only the leading behavior embodied in Eq. (3.29) matters.

gives the correct asymptotics (3.32), as can be checked by applying the asymptotic form of characters for large Young tableaux (appendix A) to χ_j^r , $j \rightarrow \infty$. There are $1/\zeta$ corrections⁵ to the $\zeta \rightarrow -\infty$ behavior of the χ_j^r , which gives the following expansion:

$$F_l^n \stackrel{T \rightarrow \infty}{\cong} -T \left[\log \chi_l^n (e^{-B/T}) + \frac{\alpha_l^n}{\log(T/T_0)} + \dots \right] \quad (4.3)$$

The first term is simply, as already noted (Eq. (3.28)) the free energy of a spin in the representation $n \times l$, that is the impurity without any interaction with the electrons. This indicates a $J = 0$ UV fixed point, with logarithmic corrections characteristic of asymptotic freedom.

4.2. Low temperature ($T \ll T_0$, $B \lesssim T$).

The region where both T and B are small compared to T_0 corresponds to the vicinity of $\zeta = +\infty$.

We shall in particular consider F_l^n for very low magnetic fields ($B \ll T$); due to $SU(N)$ -invariance the expansion takes the form (cf appendix A):

$$F_l^n \stackrel{B \rightarrow 0}{\sim} \sigma_l^n \frac{1}{2N} \sum_{a=1}^N (B^a)^2 \quad (4.4)$$

which defines the magnetic susceptibility σ_l^n .

The extra term of Eq. (3.19) is now exponentially small, so that one obtains a separation of the equations according to $j < f$, $j = f$, $j > f$. Note that to calculate the corrections to the $\zeta = +\infty$ value of χ_l^n , we do need to take into account the shifts of $\pm i\pi/N$ of (3.19).

- Underscreened case ($f < l$). Again, it is easy to extend the $\zeta \rightarrow +\infty$ limit (3.24) to include a magnetic field; taking into account the power-law corrections, one finds that

$$F_l^n \stackrel{T \rightarrow 0}{\cong} -T \left[\log \chi_{l-f}^n (e^{-B/T}) + \frac{\beta_l^n}{\log(T/T_0)} + \dots \right] \quad (4.5)$$

The first term is interpreted by saying that the impurity has been (under)screened by the electrons (cf fig. 2), and it now behaves like a spin in the $n \times (l - f)$ representation. This

⁵ These power-law corrections are characteristic of a system of T.B.A. equations for which the index j takes an *infinite* set of values.

indicates a $J = \infty$ IR fixed point, the logarithmic corrections correspond to IR asymptotic freedom.

In particular, since the electrons do not contribute to the zero temperature and zero magnetic field entropy (cf appendix B), we can extract the latter from Eq. (4.5) and check that it is just the logarithm of the dimension of the representation of the ground state, as expected.

For the susceptibility one finds

$$\sigma_l^n \stackrel{T \rightarrow 0}{\sim} -\frac{1}{T} \frac{n(N-n)(l-f)(l-f+N)}{N^2-1} \quad (4.6)$$

which contains the normal low-temperature $1/T$ divergence.

- Screened case ($f = l$). The limit $\chi_f^n(\zeta \rightarrow +\infty) = 1$ indicates that there is no term of order T in the expansion of F_f^n . This corresponds to the intuitive fact that the impurity has been completely screened by the electrons ($J = \infty$ fixed point). Expanding around $\zeta = +\infty$ in the fusion equations for $j = f$ one finds particularly simple (linear) equations and the expansion $\chi_f^n = 1 + cst \sin(\pi n/N) e^{-\zeta}$ plus next corrections of the type $e^{-k\zeta}$, k integer; but not the constant in front of the first correction. Fortunately, for $f = l$, one can use an alternative method. One expands (3.10) in the limit $T \ll T_0$:

$$\begin{aligned} F_f^n \stackrel{T \rightarrow 0}{\sim} & -\frac{T^2}{\pi T_0} \sum_r \frac{\sin\left(\frac{\pi r}{N}\right) \sin\left(\frac{\pi n}{N}\right)}{\sin\left(\frac{\pi}{N}\right)} \int d\zeta e^\zeta \log(1 + \eta_f^r) \\ & = \frac{1}{T_0} \frac{\sin\left(\frac{\pi n}{N}\right)}{\sin\left(\frac{\pi}{N}\right)} \mathcal{F} \end{aligned} \quad (4.7)$$

so that we are led to the computation of \mathcal{F} , which is done in appendix B. We only reproduce here the result (B.12):

$$F_f^n \stackrel{T \rightarrow 0}{\sim} -f \frac{\sin\left(\frac{\pi n}{N}\right)}{\sin\left(\frac{\pi}{N}\right)} \left[\frac{\pi}{12} \frac{N^2-1}{N+f} \frac{T^2}{T_0} + \frac{1}{4\pi} \sum_{a=1}^N \frac{(B^a)^2}{T_0} \right] \quad (4.8)$$

Furthermore, according to the form of the next corrections ($e^{-k\zeta}$), F_f^n has only integer powers of T in its expansion.

The magnetic susceptibility σ_f^n is

$$\sigma_f^n \stackrel{T \rightarrow 0}{\sim} -\frac{1}{T_0} \frac{\sin\left(\frac{\pi n}{N}\right)}{\sin\left(\frac{\pi}{N}\right)} \frac{Nf}{2\pi} \quad (4.9)$$

which reaches a finite limit as $T \rightarrow 0$. This confirms that the impurity is completely screened in the IR.

- Overscreened case ($f > l$). This is the most interesting case. Independently of the magnetic field, one find the result (3.22), or more explicitly

$$F_l^n \stackrel{T \rightarrow 0}{\sim} -T \log \left[\prod_{p=1}^n \prod_{q=n+1}^N \frac{\sin(q-p+l)\theta}{\sin(q-p)\theta} \right] \quad (4.10)$$

where $\theta = \pi/(f+N)$.

It is clear that here, the entropy at zero temperature $S(T=0) = \log \chi_l^n(G_f)$ is not the logarithm of an integer number, a phenomenon which has a simple explanation (see next section). In particular, it is smaller than the naive value $\chi_{f-l}^n(1_{SU(N)})$ one would obtain if one minimized only the interaction term in the Hamiltonian [14]. This corresponds to the fact that the RG flow reaches a non-trivial IR fixed point $J = J^*$ characterized by Non-Fermi Liquid behavior.

One should note that the number $\chi_l^n(G_f)$ involved is directly determined by the geometry of the fusion equations diagram (fig. 5).

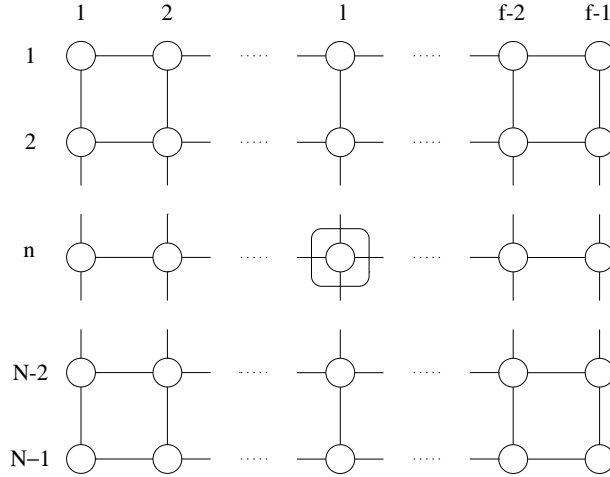

Fig. 5: Pictorial representation of the fusion equations $j < f$ in the limit $\zeta \rightarrow \infty$, when they decouple from the equations $j > f$.

The symmetries of the diagram imply equalities of zero temperature entropies for different impurities: obviously $\chi_l^n(G_f) = \chi_l^{N-n}(G_f) = \chi_{f-l}^n(G_f)$. Furthermore, one can see on this graphical representation that the rank-level duality of the equations implies that the simultaneous interchange of $n \leftrightarrow l$ and $N \leftrightarrow f$ should leave $\chi_l^n(G_f)$ unchanged. For example, this relates the cases of an overscreened impurity in a completely symmetric

representation ($n = 1$) and in a completely antisymmetric representation ($l = 1$) (this particular duality can be found in the large N limit in [17])

Let us also calculate the next correction to the free energy. Since we are now dealing with a finite set of coupled equations ($1 \leq j \leq f - 1$, $1 \leq r \leq N - 1$), one expects exponentially small corrections to the dominant behavior. We already know from (4.8) that $\chi_f^r = 1 + O(e^{-\zeta})$; and χ_f^r is connected to χ_{f-1}^r by the fusion equations (even in the $\zeta \rightarrow +\infty$ limit: take (3.19) for $j = f - 1$), and from there on to all the χ_j^r , $j < f$. This implies that all the χ_j^r have corrections of order $e^{-\zeta}$; but these may be subdominant compared to other exponentially small corrections. Hence, we try the ansatz

$$\chi_j^r(\zeta) = \chi_j^r(+\infty) (1 + a_j^r e^{-\tau\zeta}) \quad (4.11)$$

for $1 \leq j \leq f - 1$, with $0 < \tau < 1$. Expanding the fusion equations (3.19) around $\zeta \rightarrow +\infty$ leads to the following set of linear equations for the a_j^r :

$$\frac{1}{1 + \eta_j^r(+\infty)} (a_j^{r+1} + a_j^{r-1}) + \frac{1}{1 + (\eta_j^r(+\infty))^{-1}} (a_{j+1}^r + a_{j-1}^r) = \lambda a_j^r \quad (4.12)$$

where $\lambda \equiv 2 \cos(\pi\tau/N)$, and we have the boundary conditions $a_j^0 = a_j^N = a_0^r = a_f^r = 0$. This is an eigenvalue problem; the dominant correction in (4.11) corresponds to the biggest λ , so we are looking for the Perron-Frobenius eigenvalue and eigenvector⁶. The solution

$$\begin{aligned} a_j^r &= a \sin(r\theta) \sin((N - r)\theta) \sin(j\theta) \sin((j + N)\theta) \\ \lambda &= 2 \cos(2\theta) \end{aligned} \quad (4.13)$$

satisfies (4.12), the boundary conditions and the positivity requirement $a_j^r > 0$. Notice that (4.13) respects the rank-level duality of (4.12) (exchange of $r \leftrightarrow j$ and $N \leftrightarrow f$).

We finally find $\tau = 2N/(f + N)$. We then need to treat separately the cases $\tau < 1$, $\tau = 1$, $\tau > 1$, which leads to the following discussion:

★ For $f < N$, $1 < \tau < 2$ and the dominant correction is the $e^{-\zeta}$ correction; as the next correction coming from χ_f^r is of order $e^{-2\zeta}$, one can write

$$F_l^n \stackrel{T \rightarrow 0}{\equiv} -T \left[\log \chi_l^n(G_f) + \gamma_l^n \frac{T}{T_0} + a_l^n \left(\frac{T}{T_0} \right)^\tau + \dots \right] \quad (4.14)$$

⁶ Note that the solution $a_j^r = 1$ trivially satisfies (4.12) with $\lambda = 2$, but not the boundary conditions.

where γ_l^n and a (the constant in a_l^n) are functions of the ratio B/T , so that

$$\sigma_l^n \stackrel{T \rightarrow 0}{\propto} \frac{1}{T_0} \left[1 - cst \left(\frac{T}{T_0} \right)^{\frac{N-f}{N+f}} \right] \quad (4.15)$$

The susceptibility tends to a finite value, as in the screened case, but the next correction has a non-integer power.

★ For $f = N$ (the “self-dual”, i.e. square diagram), $\tau = 1$: the exponential corrections of the χ_f^r are exactly of the same order as those of the χ_j^r , $j < f$, so that they have to be inserted as boundary conditions in (4.12): a_f^r now has a non-zero value which one can extract from (4.8) (this new boundary condition breaks the self-duality of the equations). In fact, there is no solution to this system of inhomogeneous linear equations, precisely because $\lambda = 2 \cos(\pi/N)$ (i.e. $\tau = 1$) is an eigenvalue of the matrix of this system. This is a “resonance” phenomenon, and as is usual in such degenerate cases we must replace the ansatz (4.11) with

$$\chi_j^r(\zeta) = \chi_j^r(+\infty) \left(1 + (a_j^r + b_j^r \zeta) e^{-\zeta} \right) \quad (4.16)$$

One can then find a solution to the corresponding inhomogeneous linear system with b_j^r of the type of (4.13): $b_j^r = b \sin(\pi r/N) \sin(\pi j/N)$ so that

$$F_l^n \stackrel{T \rightarrow 0}{\propto} -T \left[\log \chi_l^n(G_f) + b_l^n \frac{T}{T_0} \log \left(\frac{T}{T_0} \right) + \dots \right] \quad (4.17)$$

where again b is a B/T -dependent constant;

$$\sigma_l^n \stackrel{T \rightarrow 0}{\propto} \frac{1}{T_0} \log \left(\frac{T}{T_0} \right) \quad (4.18)$$

The susceptibility has a logarithmic divergence.

★ For $f > N$, $\tau < 1$, and we find:

$$F_l^n \stackrel{T \rightarrow 0}{\propto} -T \left[\log \chi_l^n(G_f) + a_l^n \left(\frac{T}{T_0} \right)^\tau + \dots \right] \quad (4.19)$$

$$\sigma_l^n \stackrel{T \rightarrow 0}{\propto} \frac{1}{T_0} \left(\frac{T}{T_0} \right)^{-\frac{f-N}{N+f}} \quad (4.20)$$

The susceptibility is divergent as $T \rightarrow 0$, but with a non-integer power-law.

In all three cases, the fact that the divergence of the susceptibility is always slower than $1/T$ indicates that the $SU(N)$ spin of the impurity is completely screened at the IR fixed point (cf section 2).

5. Interpretation of the entropy at zero temperature.

We shall first discuss in an abstract setting, how to calculate the entropic factor connected to a particle in a general theory. We shall then apply this to the impurity in our model, which will yield the zero temperature entropy (since the electrons do not contribute to it).

5.1. General principles.

We consider a system in which states can be characterized by a quantum number R . As several states may have the same quantum number, we associate to each R a degeneracy d_R . Let us now imagine that we take a state which has the quantum number R , and add to it a particle: we obtain a new state which has the quantum number R' . Of course, for a given R and a given type of particle, not all R' are allowed; therefore we associate to the particle the adjacency matrix $A_{RR'}$ which is 0 if the transition from R to R' is forbidden, and 1 (or in fact any positive integer in case of multiple possible transitions) if the transition is allowed.

Let us now start from the vacuum, which conventionally has the quantum number $R = \emptyset$. If we put one particle with associated adjacency matrix $(A_0)_{RR'}$ into the system, the number of states allowed is by definition

$$\Omega = \sum_R (A_0)_{\emptyset R} d_R \tag{5.1}$$

This expression is correct for a system of fixed finite length L ; the entropy at zero temperature is equal to $\log \Omega$, that is the logarithm of an integer. However, we shall argue that this is in fact not the proper definition of the entropic factor associated to this particle in the thermodynamic limit. Indeed, as the size L of the system grows, at fixed temperature T , the average number of particles in the system necessarily diverges. In fact in a massless theory, it is obvious that the number of particles is of order $TL \gg 1$ (even if T is in the end sent to 0).

Therefore, we come to the conclusion that to define the entropic factor of a given particle as $L \rightarrow \infty$, one should always consider it as surrounded with a large number of other particles. One should then extract from the entropy of the resulting state the contribution of the particle we are interested in.

From this point of view the entropic factor is

$$\Omega = \sum_R (A_0 A_1^{N_1} A_2^{N_2} \dots A_p^{N_p})_{\emptyset R} d_R \quad (5.2)$$

where we have introduced the numbers N_i and adjacency matrices A_i of the different types of particles.

We shall make the assumption that all the matrices A_i commute. This will always be the case for us. Then in the limit $N_i \rightarrow \infty$, we can write

$$\Omega \propto \lambda_0 \lambda_1^{N_1} \lambda_2^{N_2} \dots \lambda_p^{N_p} \quad (5.3)$$

where λ_i is the biggest eigenvalue of A_i , which is necessarily real positive since A_i has positive entries, and which is associated with the Perron-Frobenius eigenvector common to all matrices A_i . The contribution to the entropy of our original particle has now become $S = \log \lambda_0$.

An important remark is that the entropy does not depend on the degeneracy numbers d_R ! This may sound slightly paradoxical, but it will in fact play a key role in what follows.

Let us come back to our Kondo model. Here we have in fact two quantum numbers. We shall first introduce and study these two quantum numbers one at a time, constructing the adjacency matrices and computing their Perron-Frobenius eigenvalues according to the procedure described above.

5.2. The $SU(N)$ quantum number.

Let us suppose first that the quantum number R is simply the $SU(N)$ irreducible representation of the state. To a particle which belongs to the representation R_0 we associate the adjacency matrix $(A_{R_0})_{RR'}$ which is the usual tensor product matrix in the space of representations; it is defined by the decomposition rule

$$R_0 \otimes R = \bigoplus_{R'} (A_{R_0})_{RR'} R'$$

i.e. matrix elements of A_{R_0} are $SU(N)$ Littlewood-Richardson coefficients. The degeneracy d_R is the dimension of the representation R . Equation (5.1) reads here

$$\Omega = \sum_R (A_{R_0})_{\emptyset R} d_R = d_{R_0} \quad (5.4)$$

so that we immediately find the correct result that $S = \log \Omega$ is the logarithm of the dimension of the representation R_0 . Here, the formalism we developed is useless; it just gives in a complicated way the same result since the analogue of Eq. (5.2) is

$$\Omega = \sum_R (A_{R_0} A_{R_1}^{N_1} A_{R_2}^{N_2} \dots A_{R_p}^{N_p})_{\emptyset R} d_R = d_{R_0} d_{R_1}^{N_1} d_{R_2}^{N_2} \dots d_{R_p}^{N_p} \quad (5.5)$$

which immediately exhibits the Perron-Frobenius eigenvalues $\lambda_i = d_{R_i}$ of the adjacency matrices.

5.3. The $SU_q(N)$ quantum number (restricted to level f).

Let us first introduce the quantum group $U_q(\mathfrak{sl}(N))$, with $q = \exp(2i\theta) = \exp(2i\pi/(f+N))$. We remind the reader that given a simple Lie algebra \mathfrak{g} , one can construct a family of deformations $U_q(\mathfrak{g})$ of it: $U_q(\mathfrak{g})$ is an algebra (in fact a Hopf algebra, see [18]) whose defining relations are deformations of those of \mathfrak{g} , with q the deformation parameter (when $q \rightarrow 1$ one recovers the undeformed universal enveloping algebra $U(\mathfrak{g})$). Quantum groups are the natural symmetries of integrable models, even though the $U_q(\mathfrak{sl}(N))$ symmetry that we now consider is in a sense “hidden” in the Kondo model, and we rediscover it by computing thermodynamic quantities.

Let us turn to the representation theory of $U_q(\mathfrak{sl}(N))$. For generic q , it is identical to that of $\mathfrak{sl}(N)$ (and irreducible representations can be depicted e.g. by Young tableaux as in appendix A). However, for q a root of unity⁷, the situation is more complicated: a subclass of irreducible representations, the “good” representations behave like for any value of q ; but the others have a more complicated behavior (in particular several Young tableaux merge together into indecomposable but not irreducible representations). In our case, when q is a primitive $(f+N)$ th root of unity, the “good” representations, which we also call “ $SU_q(N)$ representations” for simplicity, are characterized by the property that the number of columns of their Young tableau $n^1 + \dots + n^{N-1} = m^1 - m^N \leq f$. We denote their set by $P^+(N, f)$ ⁸.

Fortunately, it can be shown that one can consistently restrict the representation theory $U_q(\mathfrak{sl}(N))$ to the “good” representations. This is the situation we consider now: the $SU_q(N)$ quantum number is precisely an element of the set $P^+(N, f)$. The justification

⁷ Here, we consider the so-called “restricted specialization” of $U_q(\mathfrak{sl}(N))$

⁸ We borrow this notation from affine Lie algebra theory, since $P^+(N, f)$ can also be defined as the set of integral dominant weights of $A_{N-1}^{(1)}$ at level f .

of this choice is that, from the form of the B.A.E., we conjecture that in the spin sector of the Kondo model, only such representations are present. In fact, this can also be guessed from the similar situation in the WZW $SU(N)$ level f theory.

Let us comment on the physical implication of such a quantum number. One-particle states are now organized in multiplets of $SU_q(N)$ with certain “good” representations, (for us, they are the fundamental representations of $SU_q(N)$); however, as soon as one considers multi-particle states, it becomes clear that the Hilbert space of our theory does not have a Fock structure any more: indeed by performing the tensor product of enough representations of $P^+(N, f)$ one necessarily obtains representations with more than f columns and which therefore do not belong to $P^+(N, f)$. A truncation is needed to keep only the “good” representations in the tensor product.

The non-Fock structure of the states is most easily imagined by considering the physical particles as kinks [19], that is states interpolating between different classical vacua labeled by the $SU_q(N)$ quantum number. This is the same “kink structure” which appears, for example, in RSOS models [20]. In the end, this non-Fock structure will be responsible for the fractional zero temperature entropy.

This truncation (and the associated kink structure) is apparent when one builds the adjacency matrices $(A_j^r)_{RR'}$; they are the *truncated tensor product matrices* for the quantum group $U_q(\mathfrak{sl}(N))$ associated to the rectangular Young tableaux $r \times j$. In the kink picture, the adjacency matrices describe the possible transitions between the different classical vacua. Here we do not give an abstract algebraic construction for A_j^r but rather a simple explicit procedure.

We start with A_1^1 which is obtained by taking the corresponding standard (i.e. untruncated) tensor product matrix and restricting it (in the naive sense) to $P_+(N, f)$. Explicitly, this means that $(A_1^1)_{RR'} = 1$ if there is a $a \in \{1, \dots, N\}$ such that $R' = R + e^a$, 0 otherwise. We have shown in fig. 6 the set $P_+(3, 3)$; each arrow corresponds to the addition of a e^a , $a = 1 \dots 3$, so that A_1^1 is precisely the adjacency matrix of the resulting graph.

This way we have defined the matrix A_1^1 . We could use the same restriction procedure for any matrix A_1^r corresponding to a fundamental representation of $SU(N)$; explicitly, $(A_1^r)_{RR'} = 1$ if there are a_1, \dots, a_r all distinct such that $R' = R + e^{a_1} + \dots + e^{a_r}$, 0 otherwise. Fig. 7 gives an example of such a construction.

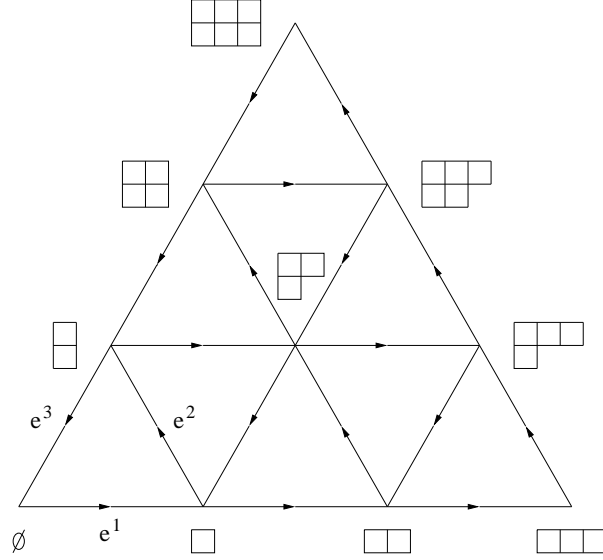

Fig. 6: The set $P_+(3,3)$ and the graph of A_1^1 .

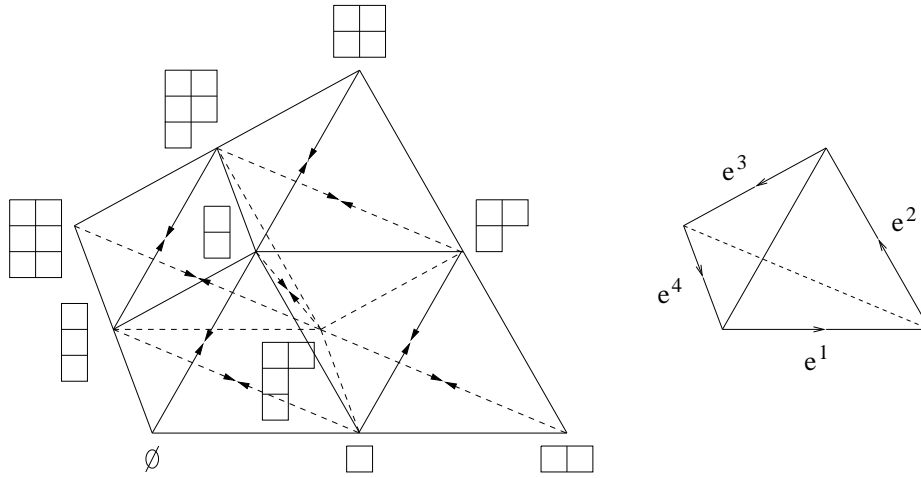

Fig. 7: The set $P_+(4,2)$ and the graph of A_1^2 , which consists of the edges with double arrows.

The higher matrices A_j^r , $j > 1$ cannot be obtained in the same way; one must use the fusion procedure. In the case of rectangular Young tableaux, the matrices A_j^r can be defined by imposing the by now familiar fusion equations

$$A_j^r A_j^r = A_j^{r+1} A_j^{r-1} + A_{j+1}^r A_{j-1}^r \quad (5.6)$$

with the boundary conditions $A_j^0 = A_j^N = A_0^r = 1$. It should be noted that the fusion procedure requires only A_1^1 to build all the other A_j^r ; however, the sole use of eqs. (5.6) requires all the A_1^r , so as to have proper initial conditions to the recursion $A_j^r = f(A_{j-1}^q, A_{j-2}^{q'})$. In

fact one has the following explicit solution in determinant form:

$$A_j^r = \det(A_1^{r-a+b})_{1 \leq a, b \leq j} \quad (5.7)$$

(where $A_1^r \equiv 0$ for $r < 0$ or $r > N$).

One can finally check that the largest eigenvalue of A_j^r , which like all eigenvalues is a $SU(N)$ character, is precisely $\chi_j^r(G_f)$ ⁹.

5.4. The Kondo model.

In the Kondo model, as already mentioned, the two quantum numbers described above naturally appear in the Bethe Ansatz description through the appearance of the j -strings for $1 \leq j < f$ and $j > f$. We shall now try to apply the general method outlined above to the impurity *in interaction* with the electrons, i.e. the (under, over)screened impurity. By inspection of the ground state (section 2), we can infer that the impurity never has both adjacency matrices non-trivial: for the underscreened case only the unrestricted $SU(N)$ adjacency matrix is non-trivial, while the $SU_q(N)$ adjacency matrix is the identity matrix, and the converse statement for the overscreened case. This means that we can hide one of the two quantum numbers inside the degeneracies d_R of the other; as we have already noted that these numbers d_R play no role in the thermodynamic limit, we can blindly apply the results of the two previous subsections:

- Underscreened case ($f < l$). We apply the result of section 5.2 to the impurity, which we assume belongs to the representation $n \times (l - f)$ due to the screening of the electrons. Our procedure gives the correct result that the entropy at zero temperature is the logarithm of the dimension of this representation.

- Overscreened case ($f > l$). We assume that the adjacency matrix corresponding to the impurity is the $SU_q(N)$ truncated tensor product matrix A_l^{N-n} ; this non-trivial adjacency matrix is due to the $(N - n) \times l$ electrons (or more precisely their spin sector component) on the site of the impurity, which are screening it: indeed to completely screen the spin of the impurity (as was found in section 2) one needs precisely $(N - n) \times l$ electrons.

In this case too, one finds the correct result that the entropy is the logarithm of $\chi_l^{N-n}(G_f) = \chi_l^n(G_f)$.

⁹ In the quantum group terminology this number is called the *quantum dimension* of the representation $r \times j$.

where n_0^r is the contribution of R_0 , and $2C^{qr} = 2C^{qr}(\kappa = 0) = 2\delta^{qr} - (\delta^{q^{r+1}} + \delta^{q^{r-1}})$ is the usual Cartan matrix of A_{N-1} . Rewritten explicitly, this gives Eq. (2.6).

To a representation R and an element G of $SU(N)$ (or, by analytic continuation, of $SL(N)$) we associate the character $\chi_R(G)$ defined as the trace of G in the representation R . It satisfies the basic $SU(N)$ invariance property:

$$\chi_R(G) = \chi_R(\Omega G \Omega^{-1}) \quad \forall \Omega \in SU(N)$$

which implies that it only depends on the eigenvalues z^a ($1 \leq a \leq N$) of G . For irreps, one has the following explicit formula:

$$\chi_R(G) = \frac{\det((z^a)^{m^b + N - b})_{a,b=1\dots N}}{\det((z^a)^{N-b})_{a,b=1\dots N}} \quad (\text{A.4})$$

where $\det((z^a)^{N-b}) \equiv \Delta$ is simply the Van der Monde determinant of the z^a .

Let us now suppose that the z^a are real positive, so that one can order them: $z^1 > z^2 > \dots > z^N$. Let us furthermore assume that the representation R becomes large, in the sense that the $n^r \gg 1$. Then one can replace (A.4) with the following estimate:

$$\chi_R(G) \sim \frac{1}{\Delta} \prod_{a=1}^N (z^a)^{m^a + N - a} \quad (\text{A.5})$$

Setting $z^a = \exp(-B^a/T)$ and expressing the m^a in terms of the M^r , one obtains Eq. (3.29).

For a large rectangular Young tableau $r \times j$, we have $n^q = j\delta^{qr}$ so that only $n^r \gg 1$. A more careful estimate gives

$$\chi_j^r(G) \stackrel{j \rightarrow \infty}{\sim} \frac{\Delta_1 \Delta_2}{\Delta} \prod_{a=1}^N (z^a)^{m^a + N - a} \quad (\text{A.6})$$

where Δ_1 (resp. Δ_2) is the Van der Monde of the z^a for $1 \leq a \leq r$ (resp. $r+1 \leq a \leq N$). It is quite close to (A.5) in the sense that the character is still approximated by a constant times the highest weight vector contribution.

More explicitly, for $z^a = \exp(-B^a/T)$, we have

$$\chi_j^r(e^{-B/T}) \stackrel{j \rightarrow \infty}{\sim} e^{-j \sum_{a=1}^r B^a/T} \quad (\text{A.7})$$

(compare with Eq. (3.32)).

Let us finally expand $\chi_R(e^{-B/T})$ for $B \ll T$, i.e. around $\chi_R(1_{SU(N)})$. Due to the $SU(N)$ -invariance, the linear term is necessarily proportional to the only linear invariant $\sum_{a=1}^N B^a$, which in our case is zero. In the same way, there are only two quadratic invariants, $(\sum_{a=1}^N B^a)^2 = 0$ and $\sum_{a=1}^N (B^a)^2$, so that

$$\log \chi_R(e^{-B/T}) = \log \chi_R(1_{SU(N)}) + \frac{C}{2} \sum_{a=1}^N (B^a/T)^2 + \dots \quad (\text{A.8})$$

This motivates the definition of the magnetic susceptibility given in (4.4). To compute the constant C , one uses the well-known identity: $\Delta \chi_r = C_2(R) \chi_R$ where Δ is the Laplacian on $SU(N)$ and $C_2(R)$ is the quadratic Casimir of the irrep R . With the usual normalizations this means that $C = C_2(R)/(N^2 - 1)$.

Appendix B. Computation of the free energy of the electrons

This appendix presents the computation (from the Bethe Ansatz), at given temperature T and magnetic field B , of the free energy per unit length of the electrons

$$\mathcal{F} = -DT \sum_r \int d\Lambda G^{r1} \star s(\Lambda - 1) \log(1 + \eta_f^r(\Lambda)) \quad (\text{B.1})$$

We shall take the scaling limit only at the end of the calculations.

The key observation is that $2\pi D \delta_{j,f} G^{r1} \star s(\Lambda - 1) = (d/d\Lambda) \tilde{g}_j^r$ (cf (2.3), (2.4)); replacing \tilde{g}_j^r with the l.h.s. of (3.7), and inserting this into (B.1) gives

$$\mathcal{F} = -\frac{T^2}{2\pi} \sum_{r,j} \int d\Lambda \frac{d}{d\Lambda} \left(\log(1 + (\eta_j^r)^{-1}) - \sum_{q,k} G^{qr} \star C_{jk} \star \log(1 + \eta_k^q) \right) \log(1 + \eta_j^r(\Lambda)) \quad (\text{B.2})$$

The double integral which appears in (B.2)

$$I \equiv \sum_{j,k,q,r} \int d\Lambda d\Lambda' A_{jk}^{qr}(\Lambda - \Lambda') \log(1 + \eta_j^r(\Lambda)) \log(1 + \eta_k^q(\Lambda')) \quad (\text{B.3})$$

where $A_{jk}^{qr} \equiv (d/d\Lambda)(G^{qr} \star C_{jk})$, would seem to vanish due to the change of sign under the simultaneous transformations $q \leftrightarrow r$, $j \leftrightarrow k$, $\Lambda \leftrightarrow -\Lambda$. In fact it does not, because of the non-uniform convergence of this integral as $\Lambda, \Lambda' \rightarrow \pm\infty$, and the correct result is:

$$I = \frac{1}{2} \sum_{j,k,q,r} G^{qr}(\kappa = 0) C_{jk}(\kappa = 0) \left[\log(1 + \eta_j^r) \log(1 + \eta_k^q) \right]_{-\infty}^{+\infty} \quad (\text{B.4})$$

We now use Eq. (3.1) in the limit $\Lambda \rightarrow \pm\infty$

$$\log(1 + \eta_j^r(\pm\infty)) - \sum_{q,k} C^{qr}(\kappa=0) G_{jk}(\kappa=0) \log(1 + (\eta_k^q(\pm\infty))^{-1}) = \frac{g_j^r(\pm\infty)}{T} \quad (\text{B.5})$$

to express in a more suggestive form I :

$$\begin{aligned} I &= \frac{1}{2} \sum_{j,r} \left[\log(1 + \eta_j^r) \log(1 + (\eta_j^r)^{-1}) \right]_{-\infty}^{+\infty} \\ &+ \frac{1}{2} \sum_{j,k,q,r} G^{qr}(\kappa=0) C_{jk}(\kappa=0) \left[\frac{g_j^r}{T} \log(1 + \eta_k^q) \right]_{-\infty}^{+\infty} \end{aligned} \quad (\text{B.6})$$

The free energy then takes the form

$$\begin{aligned} \mathcal{F} &= -\frac{T^2}{2\pi} \sum_{j,r} \left[-\frac{1}{2} \int [d(\log(1 + (\eta_j^r)^{-1})) \log(1 + \eta_j^r) + d(\log(1 + \eta_j^r)) \log(1 + (\eta_j^r)^{-1})] \right] \\ &+ \frac{T}{4\pi} \sum_{j,k,q,r} G^{qr} C_{jk} \left[g_j^r \log(1 + \eta_k^q) \right]_{-\infty}^{+\infty} \end{aligned} \quad (\text{B.7})$$

($\kappa = 0$ is implied for all kernels now). We shall compute this expression in the scaling limit.

The first term is usually written in terms of Rogers' dilogarithmic function L , by taking $1/(1 + \eta)$ as new variable; in fact one can easily show that, due to cancellations between $\Lambda = +\infty$ and $\Lambda = -\infty$, the quantity between the brackets is precisely equal to the following (known) dilogarithm sum [21]:

$$\sum_{j=1}^f \sum_{r=1}^{N-1} L \left(\frac{1}{1 + \eta_j^r(+\infty)} \right) = \frac{\pi^2}{6} \frac{f}{N+f} (N^2 - 1) \quad (\text{B.8})$$

Concerning the second term, one might be tempted to replace $\sum_{r,j} G^{qr} C_{jk} g_j^r(\pm\infty)$ with its value $\tilde{g}_k^q(\pm\infty)$ and then evaluate the sum, which turns out to be zero. This is in fact incorrect because of the divergences which occur at $j = \infty$ due to the presence of the magnetic field B . The correct procedure is to isolate the term where B appears

$$\mathcal{F}_B \equiv \frac{T}{4\pi} \sum_{q,r} G^{qr} b^r \sum_{k=1}^{\infty} \left[\log(1 + \eta_k^q) \right]_{-\infty}^{+\infty} \sum_{j=1}^J j C_{jk} \quad (\text{B.9})$$

where we have introduced a cutoff J for the last sum (which would naively vanish as $J \rightarrow \infty$). Using $\sum_{j=1}^J j C_{jk} = \delta_{kJ}(J+1)/2 - \delta_{kJ+1}J/2$ and (3.13) we find:

$$\mathcal{F}_B = \frac{T}{4\pi} \lim_{J \rightarrow \infty} \sum_r b^r \left[(J+1) \log \chi_J^r - J \log \chi_{J+1}^r \right]_{-\infty}^{+\infty} \quad (\text{B.10})$$

The explicit expressions $\chi_j^r(-\infty) = \chi_j^r(e^{-B/T})$, $\chi_j^r(+\infty) = \chi_{j-f}^r(e^{-B/T})$ ($j > f$), and the estimate (A.7) allow to compute (B.10); the result is:

$$\mathcal{F}_B = -\frac{1}{4\pi} f \sum_{a=1}^N (B^a)^2 \quad (\text{B.11})$$

Putting (B.8) and (B.11) together, we obtain the final expression for the free energy:

$$\mathcal{F} = -T^2 \frac{\pi}{12} \frac{f}{N+f} (N^2 - 1) - \frac{1}{4\pi} f \sum_{a=1}^N (B^a)^2 \quad (\text{B.12})$$

Let us comment on this result. The first term is the central charge term for a theory with only one chirality and central charge $c = (N^2 - 1)f/(N + f)$: this is what we expect since the spin sector of the electrons is a WZW $SU(N)$ level f theory. Of course once one puts together the spin, flavor and charge sectors, one recovers the total central charge

$$c = (N^2 - 1) \frac{f}{N+f} + (f^2 - 1) \frac{N}{N+f} + 1 = Nf \quad (\text{B.13})$$

for Nf free complex fermions.

The second term can be directly obtained as the free energy of the electrons in the magnetic field B : indeed the flavor and charge sectors do not contribute to it. One has the simple formula

$$\mathcal{F}_B = -Tf \int_{-\mathcal{D}}^{+\infty} \frac{dk}{2\pi} \sum_{a=1}^N \log(1 + e^{-(k+B^a)/T}) \quad (\text{B.14})$$

where \mathcal{D} is some momentum cutoff of the order of D . The factor of f comes from the f flavors. After sending \mathcal{D} to infinity and discarding the divergent T -independent part, one obtains (B.11).

References

- [1] J. Kondo, *Progr. Theor. Phys.* 32 (1964), 37.
- [2] P.W. Anderson, *J. Phys.* C3 (1970), 2346.
- [3] P. Nozières, *Proc. of 14th Int. Conf. on Low Temp. Physics* (1975), Ed. M. Krusius and M. Vuorio.
- [4] K.G. Wilson, *Rev. Mod. Phys.* 47 (1975), 773.
- [5] N. Andrei, *Phys. Rev. Lett.* 45 (1980), 379.
- [6] P. Wiegmann, *Sov. Phys. J.E.T.P. Lett.* 31 (1980), 392.
- [7] P. Nozières and A. Blandin, *J. Phys. (Paris)* 41 (1980), 193.
- [8] B. Coqblin and J. Schrieffer, *Phys. Rev.* 185 (1969), 847.
- [9] P. Nozières and A. Blandin, *J. Phys. (Paris)* 41 (1980), 193.
- [10] N. Andrei and C. Destri, *Phys. Rev. Lett.* 52 (1984), 364.
- [11] A. Tselvik and P. Wiegmann, *J. Phys.* 54 (1984), 201.
- [12] C. Destri, Unpublished Notes (1985).
- [13] N. Andrei, *Integrable Models in Condensed Matter Physics*, in *Series on Modern Condensed Matter Physics - Vol. 6*, 458-551, World Scientific, Lecture Notes of ICTP Summer Course (September 1992). Editors: S. Lundquist, G. Morandi, and Yu Lu.
- [14] A. Jerez, N. Andrei and G. Zarand, in preparation.
- [15] Al. B. Zamolodchikov, *Phys. Lett.* B253 (1991), 391.
- [16] The connection between Y -system and fusion equations for the $SU(2)$ case is implicit in A. Klümper and P. Pearce, *Physica* A183 (1992), 304; and stated in A. Kuniba and T. Nakanishi, *Mod. Phys. Lett.* A7 (1992), 3487; see also V. V. Bazhanov and N. Reshetikhin, *J. Phys* A23 (1990), 1477.
- [17] O. Parcollet and A. Georges, preprint cond-mat/9707337; O. Parcollet, A. Georges, G. Kotliar and A. Sengupta, preprint cond-mat/9711192.
- [18] For a physical introduction to quantum groups, see J. Fuchs, *Quantum groups and affine Lie algebras*, Cambridge University Press (1992).
- [19] P. Fendley, *Phys. Rev. Lett.* 71 (1993), 2485.
- [20] For similar kink structures, see for example T. Klassen and E. Melzer, *Nucl. Phys.* B382 (1992), 441; P. Fendley, H. Saleur, Al.B. Zamolodchikov, *Int. J. Mod. Phys.* A8 (1993), 5751.
- [21] A.N. Kirillov, *Zap. Nauch. Semin. LOMI* 164 (1987), 121.