

Supersymmetric low-energy theory and renormalization group for a clean Fermi gas with a repulsion in arbitrary dimensions.

I. L. Aleiner¹ and K. B. Efetov^{2,3}

¹*Physics Department, Columbia University, New York, NY 10027, USA*

²*Theoretische Physik III, Ruhr-Universität Bochum, 44780 Bochum, Germany*

³*L. D. Landau Institute for Theoretical Physics, 117940 Moscow, Russia*

(Dated: July 4, 2018)

We suggest a new method of calculations for a clean Fermi gas with a repulsion in any dimension. This method is based on writing equations for quasiclassical Green functions and reducing them to equations for collective spin and charge excitations. The spin excitations interact with each other and this leads to non-trivial physics. Writing the solution of the equations and the partition function in terms of a functional integral over supervectors and averaging over fluctuating fields we come to an effective field theory describing the spin excitations. In some respects, the theory is similar to bosonization but also includes the “ghost” excitations which prevents overcounting of the degrees of freedom. Expansion in the interaction reveals logarithmic in temperature corrections. This enables us to suggest a renormalization group scheme and derive renormalization group equations. Solving these equations and using their solutions for calculating thermodynamic quantities we obtain explicit expression for the specific heat containing only an effective amplitude of the backward scattering. This amplitude has a complicated dependence on the logarithm of temperature, which leads to a non-trivial temperature dependence of the specific heat.

PACS numbers: 71.10.Ay, 71.10.Pm

I. INTRODUCTION

Landau theory of the Fermi liquid (FL) suggested 50 years ago¹ is the basis for description of normal metals. Roughly speaking, the main statement of the FL theory is that the low energy behavior of interacting fermions is similar to that for the ideal Fermi gas. This theory explains very successfully properties of a large number of metals and He^3 . It is quite common to discuss experimental systems just forgetting about the interaction and using phenomenological parameters like, *e.g.* effective mass, density of states at the Fermi surface, etc., instead.

Yet, a recent progress in study of unconventional metals like high temperature superconductors, heavy-fermion materials has revealed considerable deviations of their properties from those predicted by the FL theory (for a recent review see, *e.g.* Refs. 2,3. As a result, quite a few theoretical works have appeared recently where the validity of the Landau FL theory was discussed^{4–9}.

At first glance, being phenomenological from the beginning, the Landau theory has been later confirmed by analyzing diagrammatic expansions¹⁰ (see, also Refs. 11–14) and looks very well established. However, a very strong assumption was used in this discussion, namely, that one could single out a singular particle-hole channel and sum proper ladder diagrams. Two particle irreducible vertices entering the ladder diagrams should remain finite and analytic in the limit of small momenta and frequencies. Of course, this is not always true and under certain conditions the system may become superconductor, antiferromagnet, etc. In many cases, the failure of the Fermi liquid description can be checked by a more careful consideration of the perturbation theory

and, *e.g.*, the existence of the superconducting transition can be established in this way^{11–13}.

Nevertheless, it is believed that the system of fermions with a repulsion should behave like a Fermi liquid provided the dimensionality $d > 1$ and there are no van-Hove type singularities on the Fermi surface. Naturally, the similarity between the Fermi liquid and ideal Fermi gas cannot be exact and, clearly, there are corrections at finite temperatures, finite frequencies or momenta. These corrections become especially interesting when they are non-analytic functions of the values of the temperatures, frequencies or momenta.

For the ideal Fermi gas, such quantities as $C(T)/T$ and $\chi(T)$, where $C(T)$ is the specific heat and $\chi(T)$ is the spin susceptibility, can be represented in a form of asymptotic series in T^2/ε_F^2 (ε_F is the Fermi energy). Fermion-fermion interactions lead to additional contributions to these quantities that are not necessarily analytic in T^2 . It is well established that in $D = 3$ next-to-leading term in $C(T)/T$ is $T^2 \ln T$, see Refs. 15–19. It was claimed in Ref. 20 that the non-uniform spin susceptibility, $\chi(Q)$, depends on the momentum Q as $Q^2 \ln Q$. In $2D$, non-analytical corrections to $C(T)/T$ and $\chi(Q, T)$ found so far scale as T , see Refs. 21–24, and $\max\{Q, T\}$, see Refs. 20, 22, 25–28, respectively.

The existence of the non-analytical corrections to the physical quantities is not accidental. In fact, all of the singular corrections to the thermodynamic quantities can be understood in terms of the dynamics of the low lying collective excitations, see *e.g.* Ref. 24, 28. A detailed analysis of non-analytic corrections to the specific heat of a three-dimensional Fermi liquid is given recently in Ref. 18. It was shown in Ref. 28 that all the other contributions contain integrations over the entire Fermi surface

are regular in T^2 , unlike the contributions of the collective modes which contain $2k_F$ scattering.

Explicit calculations for systems such low lying modes are not simple even in the lowest orders of the perturbation theory. This situation is analogous to that in theory of disordered metals, where the low energy behavior of the system is governed by the multiple interference of the electron waves scattered by impurities. In the diagrammatic language, this effect can be expressed in terms of an interaction between electrons and diffusion modes (so called cooperons and diffusons^{29,30}). Calculations in high orders in the diffusion modes (weak localization corrections) using the diagrammatic expansions are also quite involved.

However, another approach has been developed in the theory of disordered metals based on integrating out electron degrees of freedom and deriving an effective Lagrangian describing the diffusion modes. This reduction simplifies calculations because only low lying excitations are left in the theory. The Lagrangian has the form of a so called σ -model, first introduced in the theory of disordered metals in Ref. 31 using the replica trick. Another, supermatrix form of the σ -model, is based on a supervector representation³² of Green functions, and this method has found numerous applications (for a review, see, e.g., Ref. 33).

One can see a certain analogy between calculating the non-analytical corrections for the Fermi gas with interaction and the weak localization corrections in theory of disordered metals. Following this analogy it seems quite natural to try to develop a scheme that would allow us to reduce the initial model of the interacting Fermi gas to a model describing only low lying excitations. Then, we would have in the theory not the initial fermions but the collective excitations like, the zero sound, may be, weakly interacting with each other. Apparently, the latter are bosons and we would have, as a result, a system of bosons instead of the initial fermionic system. Reducing fermion models to boson ones is usually referred to as *bosonization* and we will loosely use this word in the subsequent discussion, though the final theory we derive will be necessarily supersymmetric, and contain also the fermionic degrees of freedom – “ghosts”.

The notion of the supersymmetry appears quite naturally already in the consideration of the leading non-analytic corrections to, say, specific heat, C . Namely, for the spinless electrons, the ring-diagrams correction to C is of the form

$$\begin{aligned} \delta C &= -T \frac{\partial^2 \delta \Omega}{\partial T^2}, \\ \delta \Omega &= \frac{T}{2} \sum_{\omega_n} \int \frac{d^d k d\mathbf{n}}{(2\pi)^d} \ln \left[1 + \hat{\mathbb{F}} \hat{\Pi}(\omega_n, \mathbf{k}) \right]_{\mathbf{nn}}, \end{aligned} \quad (1.1)$$

where the unit vector \mathbf{n} characterizes the position of the momentum on the Fermi surface, and $\omega_n = 2\pi nT$ is a bosonic Matsubara frequency. The quasiparticle polar-

ization operator acts on any function $b(\mathbf{n}, \mathbf{q})$ as

$$\hat{\Pi}(\omega_n, \mathbf{k}) b(\mathbf{n}, \mathbf{k}) = \left[1 - \frac{i\omega_n}{i\omega_n - v_F \mathbf{k} \cdot \mathbf{n}} \right] b(\mathbf{n}, \mathbf{k})$$

with v_F being the Fermi velocity. The operator $\hat{\mathbb{F}}$ is defined as

$$\left[\hat{\mathbb{F}} b \right] (\mathbf{n}_1, \mathbf{k}) = \int d\mathbf{n}_2 \mathbb{F}(\widehat{\mathbf{n}_1 \mathbf{n}_2}) b(\mathbf{n}_2, \mathbf{k})$$

and $\mathbb{F}(\widehat{\mathbf{n}_1 \mathbf{n}_2})$ is the Fermi-liquid function describing the interaction between the quasiparticles moving in directions \mathbf{n}_1 and \mathbf{n}_2 . We can imply the proper normalization of the solid angle, *i.e.*

$$\int d\mathbf{n} = 1, \quad (1.2)$$

when integrating over the momentum directions Equation (1.1) can be re-written identically as

$$\begin{aligned} \delta \Omega &= \Omega_\rho - \Omega_g; \\ \Omega_\rho &= \frac{T}{2} \sum_{\omega_n} \int \frac{d^d k d\mathbf{n}}{(2\pi)^d} \left[\ln \left(i\omega_n - v_F \left(1 + \hat{\mathbb{F}} \right) \mathbf{n} \cdot \mathbf{k} \right) \right]; \\ \Omega_g &= \frac{T}{2} \sum_{\omega_n} \int \frac{d^d k d\mathbf{n}}{(2\pi)^d} \left[\ln \left(i\omega_n - v_F \mathbf{n} \cdot \mathbf{k} \right) \right]. \end{aligned} \quad (1.3)$$

[In all the consideration we will not write factors of volume, whenever they are self-evident for an educated reader]. The form of this expression is quite instructive. The first term, Ω_ρ is nothing but the contribution of the non-interacting bosons, whose spectrum is determined by the kinetic equation in Landau theory. However, those bosons are made out of electrons which are already included in the leading term of the specific heat. That is why the second term, Ω_g , simply subtracts the contribution of the electron-hole pairs in the absence of the interactions to avoid a double counting. Since the contribution of the second term is opposite to the contribution of the physical bosons, it will be natural to treat them as *pseudofermions*, or “ghosts” and include them into the field theory description on equal footing with the bosonic fieldⁱ.

However, one cannot proceed in a direct analogy with the supersymmetry method of Ref. 33 because the latter is essentially based on the use of a sufficiently strong disorder leading to a diffusion motion at not very long distances. Fortunately, the method can be generalized

ⁱ The partition of the low-energy excitations in the Fermi liquid in terms of physical bosons and artificial ghosts (to avoid overcounting of the degrees of freedom) was suggested in Ref. 24, however, the consideration there was limited to the theory of non-interacting bosons only.

to the clean case by writing equations for quasiclassical Green functions and representing their solution in terms of functional integrals. Equations for the quasiclassical Green functions for the disorder problems were introduced in Ref. 34. The authors of Ref. 34 suggested writing their solutions from the condition for a minimum of functional having a form of a ballistic σ -model. This could be written in a form of a functional integral provided this integral could be calculated by the saddle point method. At the same time, it was not clear why the saddle point approximation could work well for the clean or weakly disordered case.

Later it was realized³⁵ that the solution of the quasiclassical equations can be *exactly* written in terms of a functional integral with a Lagrangian having the form of the ballistic σ -model. Within such an approach one reduces the initial electron model to a model describing “collective excitations” and therefore it is relevant to call it loosely bosonization. A smooth potential could be considered in this approach but no interaction was included.

In the present paper we develop a new method for studying clean fermion systems with a fermion-fermion repulsive interaction. It is based on decoupling the interaction by a proper Hubbard-Stratonovich transformation. Both the forward and backward scattering are taken into account and therefore the slow decoupling field $\Phi(\mathbf{r},\tau)$ has a spin structure (where \mathbf{r} is the coordinate and τ is the imaginary time). After the decoupling we derive equations for the quasiclassical Green functions. In order to solve the equations we use a new trick based on a slow dependence of the field $\Phi(\mathbf{r},\tau)$. As a result, we obtain linear non-homogeneous equations for spin and charge excitations. The spin excitations are most important and we represent the solution of the corresponding equation in terms of an integral over supervectors. Averaging over the field Φ , we obtain an effective theory with a $\psi^3 + \psi^4$ interaction. This theory describes collective boson excitations. It is important to emphasize that the ψ^3 and ψ^4 terms arise due to spin-spin interactions. For fermion models containing only a density-density interaction, those terms vanish and the theory becomes free.

Making expansions in the $\psi^3 + \psi^4$ interaction we found that the theory is logarithmic in any dimension, which allowed us to use a renormalization group approach to sum up the parquet series. Writing and solving the RG equations we are able to express the non-analytical contribution to the specific heat with a logarithmic accuracy.

It is relevant to mention that the method we develop now is completely different from the σ -model approach for disordered systems with interaction³⁶ (see also a recent supersymmetric formulation³⁷). In the present approach the collective excitations are described by a Lagrangian with the $\psi^3 + \psi^4$ interaction and not by a σ -model.

Attempts to bosonize fermionic models in the dimensionality $d > 1$ have been undertaken in the past starting from the work³⁸. In this first work the one dimensional bosonization was directly extended to higher di-

mensions. This idea was further developed more recently in a number of publications^{6,7,39–46}. Our approach is completely different and more general. The high dimensional bosonization developed previously can be applicable only for a long range interaction when the backward scattering is absent. In this case the fermion-fermion interaction is replaced by an interaction of the local densities (local in space and in the position on the Fermi surface). This means that effects related to electron spins are beyond the possibility of that method. In contrast, the backward scattering is included in our approach and plays a very important role.

The article is organized as follows:

In Section II, we formulate the model and single out slow pairs in the interaction term. We perform a Hubbard-Stratonovich transformation and reduce the model with the interaction to a model with slowly fluctuating fields. Then we derive quasiclassical equations for electron Green functions.

In Section III, we introduce an eikonal type method (a.k.a. Schwinger Ansatz) for solving the equations. As a result, we obtain equations for effective charges and spins in the presence of fluctuating fields. We express the partition function in terms of the solutions of these equations and calculate it neglecting the interaction between the excitations.

In Section IV, we write the solutions of the equations for the collective modes and the partition function in terms of functional integrals over supervectors. We average over the fluctuating fields and derive an effective field theory containing interaction terms.

Section V contains an explanation how one obtains logarithmic contributions. Then, we develop a RG scheme integrating over fast variables and writing renormalized coupling constants.

In Section VI, we derive renormalization group equations and find their solutions.

Section VII is devoted to calculation of the thermodynamic potential and specific heat using the solutions of the RG equations. Explicit formulae are obtained in two, three and, separately, in one dimensions.

Our findings are discussed in Section VIII.

II. THE MODEL AND BASIC EQUATIONS.

A. Formulation of the model and singling out slow modes

We start with formulating the model we would like to investigate. This is the most general model for fermions with a short range interactionⁱⁱ in an arbitrary dimen-

ⁱⁱ Inclusion of the long-range Coulomb interaction is straightforward and does not lead to any consequences relevant for our study

sion d . The Fermi surface is assumed to have no singularities. In order to avoid unnecessary trivial generality we consider the Fermi surface to be a just d -dimensional sphere.

It will be convenient for us to express the physical quantities in terms of a functional integral over anticommuting variables χ with an Euclidian action \mathcal{S} . In this formulation, one can use imaginary time τ in the interval $0 < \tau < 1/T$, where T is the temperature and write the temperature Green function $G_{\sigma\sigma'}(x, x')$, as follows

$$G_{\sigma\sigma'}(x, x') = Z^{-1} \int \chi_\sigma(x) \chi_{\sigma'}^*(x') \exp(-\mathcal{S}) D\chi D\chi^*, \quad (2.1)$$

where

$$x = (\mathbf{r}, \tau), \quad \int dx \equiv \int d^d\mathbf{r} \int_0^{1/T} d\tau. \quad (2.2)$$

\mathbf{r} is the spatial coordinate, and σ labels the spin.

The partition function Z entering Eq. (2.1) has the form

$$Z = \int \exp(-\mathcal{S}) D\chi D\chi^*. \quad (2.3)$$

The action \mathcal{S} in Eq. (2.1) can be written as

$$\mathcal{S} = \int \mathcal{L}_0 dx + \mathcal{S}_{int}, \quad (2.4)$$

where the term \mathcal{L}_0 ,

$$\mathcal{L}_0 = \sum_\sigma \chi_\sigma^*(x) \left(-\frac{\partial}{\partial\tau} - \hat{H}_0 \right) \chi_\sigma(x), \quad (2.5)$$

$$\hat{H}_0 = \frac{\hat{\mathbf{p}}^2}{2m} - \varepsilon_F \quad (2.6)$$

stands for the Lagrangian density of free fermions (ε_F is the Fermi energy, m is the mass and $\hat{\mathbf{p}}$ is the momentum operator) and \mathcal{S}_{int} describes the fermion-fermion interaction,

$$\begin{aligned} \mathcal{S}_{int} = & \frac{1}{2} \sum_{\sigma, \sigma'} \int dx dx' v(x-x') \\ & \times [\chi_\sigma^*(x) \chi_{\sigma'}^*(x') \chi_{\sigma'}(x') \chi_\sigma(x)], \end{aligned} \quad (2.7)$$

where $v(x-x') = U(\mathbf{r}-\mathbf{r}') \delta(\tau-\tau')$ and $U(\mathbf{r}-\mathbf{r}')$ is the potential of the interaction.

The field variable χ must be antiperiodic in τ with the period $1/T$

$$\chi(\mathbf{r}, \tau) = -\chi(\mathbf{r}, \tau + 1/T). \quad (2.8)$$

The thermodynamic potential Ω can be written as

$$\Omega = -T \ln Z. \quad (2.9)$$

The functional integrals over χ with the Lagrangian \mathcal{L} , Eqs. (2.4)–(2.7), are too complicated to be calculated

exactly and making controllable approximations is inevitable. For performing further formal manipulations we restrict ourselves with the case of a weak interaction, and discuss the changes of the theory for stronger interactions in the end of Sec. III B. As we have mentioned in the Introduction, the most interesting contributions come from the interaction of the fermions with low lying collective excitations and we would like to concentrate on such contributions. Thus, we will try to simplify the interaction term \mathcal{S}_{int} to display these collective modes explicitly.

This can be achieved by singling out in the interaction term \mathcal{S}_{int} pairs of the variables χ slowly varying in space. Using the Fourier representation we write the effective interaction $\tilde{\mathcal{S}}_{int}$ containing the slow pairs as

$$\begin{aligned} \mathcal{S}_{int} \rightarrow \tilde{\mathcal{S}}_{int} = & \frac{1}{2} \sum_{\sigma, \sigma'} \int dP_1 dP_2 dK \\ & \times \left\{ V(\mathbf{k}) \chi_\sigma^*(P_1) \chi_\sigma(P_1 + K) \chi_{\sigma'}^*(P_2) \chi_{\sigma'}(P_2 - K) \right. \\ & \left. - V(\mathbf{p}_{12}) \chi_\sigma^*(P_1) \chi_{\sigma'}(P_1 + K) \chi_{\sigma'}^*(P_2 + K) \chi_\sigma(P_2) \right\}, \end{aligned} \quad (2.10)$$

where

$$V(\mathbf{p}) = \int d\mathbf{r} e^{-i\mathbf{p}\mathbf{r}} U(\mathbf{r}),$$

and $\mathbf{p}_{12} \equiv \mathbf{p}_1 - \mathbf{p}_2$. In Eq. (2.10), $P_i = (\mathbf{p}_i, \varepsilon_{n_i})$, where \mathbf{p}_i is the momentum and $\varepsilon_{n_i} = \pi T(2n_i + 1)$ are Matsubara fermionic frequencies ($i = 1, 2$). Short hand notation K reads $K = (\mathbf{k}, \omega_n)$, where $\omega_n = 2\pi T n$ are Matsubara bosonic frequencies.

The symbol of the integration $\int dP_i$ in Eq. (2.10) reads as

$$\int dP_i(\dots) = T \sum_{\varepsilon_{n_i}} \int \frac{d^d\mathbf{p}}{(2\pi)^d}(\dots) \quad (2.11)$$

whereas the symbol $\int dK$ has the meaning

$$\int dK(\dots) = T \sum_{\omega_n} \int f(\mathbf{k}) \frac{d^d\mathbf{k}}{(2\pi)^d}(\dots). \quad (2.12)$$

In Eq. (2.12) we define the cut-off function

$$f(\mathbf{k}) = f_0(kr_0), \quad k = |\mathbf{k}|. \quad (2.13)$$

The function $f_0(t)$ has the following asymptotics: $f_0(t) = 1$ at $t = 0$ and $f(t) \rightarrow 0$ at $t \rightarrow \infty$. This function is written in order to cut large momenta k . The parameter r_0 is the minimal length in the theory and we assume that r_0 much larger than the Fermi wavelength $\lambda_F = 1/p_F$. In other words, the momenta k are cut by the maximal momentum $k_c = r_0^{-1} \ll p_F$, and the partition (2.13) is not threatened by double counting, see also the discussion in the end of this subsection.

Equation (2.10) permits the further simplifications for the short range interaction potential. In the first term one can neglect the dependence on the transmitted momentum \mathbf{k} ,

$$V(\mathbf{k} \ll p_F) = V_2. \quad (2.14a)$$

In the second term one notices that momenta \mathbf{p}_{12} are close to the Fermi surface, so one can writeⁱⁱⁱ

$$V(\mathbf{p}_{12}) = V_1(\widehat{\mathbf{p}_1\mathbf{p}_2}); \quad V_1(\theta) \equiv V\left(2p_F \sin \frac{\theta}{2}\right). \quad (2.14b)$$

In Eq. (2.10) we recombine the terms with the help of the identity

$$2\delta_{\sigma_1\sigma_4}\delta_{\sigma_2\sigma_3} = \delta_{\sigma_1\sigma_2}\delta_{\sigma_3\sigma_4} + \boldsymbol{\sigma}_{\sigma_1\sigma_2} \cdot \boldsymbol{\sigma}_{\sigma_3\sigma_4},$$

where $\boldsymbol{\sigma} = (\sigma_x, \sigma_y, \sigma_z)$, and σ_i , $i = x, y, z$ are the Pauli matrices. Utilizing definitions (2.14), we re-write Eq. (2.10) as

$$\begin{aligned} \tilde{\mathcal{S}}_{int} = & \frac{1}{2} \int dP_1 dP_2 dK \left[\rho(P_1, K) V_s(\theta_{12}) \rho(P_2, K) \right. \\ & \left. + \sum_{i=x,y,z} S_i(P_1, K) V_t(\theta_{12}) S_i(P_2, K) \right], \end{aligned} \quad (2.15)$$

where, as before, $\theta_{12} = \widehat{\mathbf{p}_1\mathbf{p}_2}$. and the definitions

$$\begin{aligned} \rho(P, K) &= \sum_{\sigma} \chi_{\sigma}^* \left(P + \frac{K}{2}\right) \chi_{\sigma} \left(P - \frac{K}{2}\right) \\ S_i(P, K) &= \sum_{\sigma_1, \sigma_2} \sigma_i^{\sigma_1\sigma_2} \chi_{\sigma_1}^* \left(P + \frac{K}{2}\right) \chi_{\sigma_2} \left(P - \frac{K}{2}\right) \end{aligned} \quad (2.16)$$

are introduced. The functions $V_s(\theta)$ and $V_t(\theta)$ are known as amplitudes of the singlet and triplet scattering, respectively. They are related to the amplitudes V_1 and V_2 as

$$V_s(\theta) = V_2 - \frac{1}{2}V_1(\theta), \quad V_t(\theta) = -\frac{1}{2}V_1(\theta). \quad (2.17)$$

In what follows we assume the operator $\hat{V}_s(\theta)$

$$\left[\hat{V}_{s,t}b\right](\mathbf{n}_1) = \int d\mathbf{n}_2 V_{s,t}(\widehat{\mathbf{n}_1\mathbf{n}_2}) b(\mathbf{n}_2). \quad (2.18)$$

to be positive definite and the operator $\hat{V}_t(\theta)$ to be negative definite. According to Eq. (2.17), those assumptions imply the repulsive interaction.

Equation (2.15) can be recast in a more transparent form. Performing Fourier transform over K in Eq. (2.15), we obtain

$$\begin{aligned} \tilde{\mathcal{S}}_{int} = & \frac{1}{2} \int dP_1 dP_2 \int d\mathbf{r} \int_0^{1/T} d\tau \\ & \times \left[\rho(P_1; \mathbf{r}, \tau) V_s(\theta_{12}) \rho(P_2; \mathbf{r}, \tau) \right. \\ & \left. + \sum_{i=x,y,z} S_i(P_1; \mathbf{r}, \tau) V_t(\theta_{12}) S_i(P_2; \mathbf{r}, \tau) \right]. \end{aligned} \quad (2.19)$$

The entries in Eq. (2.19),

$$\begin{aligned} \rho(P; \mathbf{r}, \tau) &= T \sum_{\omega_n} \int \frac{d^d k}{(2\pi)^d} e^{i\mathbf{k}\mathbf{r} - i\omega_n \tau} f^{1/2}(\mathbf{k}) \rho(P, K); \\ S_j(P; \mathbf{r}, \tau) &= T \sum_{\omega_n} \int \frac{d^d k}{(2\pi)^d} e^{i\mathbf{k}\mathbf{r} - i\omega_n \tau} f^{1/2}(\mathbf{k}) S_j(P, K), \end{aligned} \quad (2.20)$$

have the meaning of the smooth charge and spin density accumulated in the phase space, and Eq. (2.19) is equivalent to the Landau description of the interacting quasiparticles. Appearance of the cutoff function $f(\mathbf{k})$, Eqs. (2.12), (2.13), means that those densities may vary only with the spatial scale much larger than the Fermi wavelength λ_F .

Equations (2.15) – (2.20) constitutes the reduction of the original interaction to the interaction involving the soft electron-hole pair only. These are the only terms that may produce the non-analytic contributions to the observable quantities. In what follows we will manipulate with interaction (2.19) to obtain the low-energy theory in terms of the charge and the spin densities in the phase space.

Closing this subsection, we discuss a very crucial issue that might start worrying an attentive reader at this point – what is the fate of the Cooper channel? Indeed, examination of the scattering processes induced by the Hamiltonian (2.10), see Fig. 1 shows that the vertex V_3 , describing the particle-particle interaction between the pairs $\chi(P_1)\chi(-P_1)$ with $\chi^*(P_2)\chi^*(-P_2)$ is missing. These are just terms that generate Cooperons for the system with the time reversal symmetry^{33,36}.

At first glance, we might miss important contributions because the Cooper channel generates logarithms in any dimension¹¹ and it looks as if we neglected them. However, this is not so, although the reason for necessity to neglect the third vertex V_3 , Fig. 1c is rather non-trivial.

As we will see, the most interesting contributions to interaction vertices and, finally to the thermodynamic quantities originate from the scattering on angle either 0 or π and not from an integral over the entire Fermi surface, so only such scattering amplitudes will be important.

Therefore, we must investigate the effect of the interactions in the Cooper channel on these particular amplitude, see Figs. 2a, 3a. Direct comparison of those contributions with the diagram generated by vertex V_1 , see

ⁱⁱⁱ We borrow the one-dimensional notation of Ref. 47 for the corresponding amplitudes.

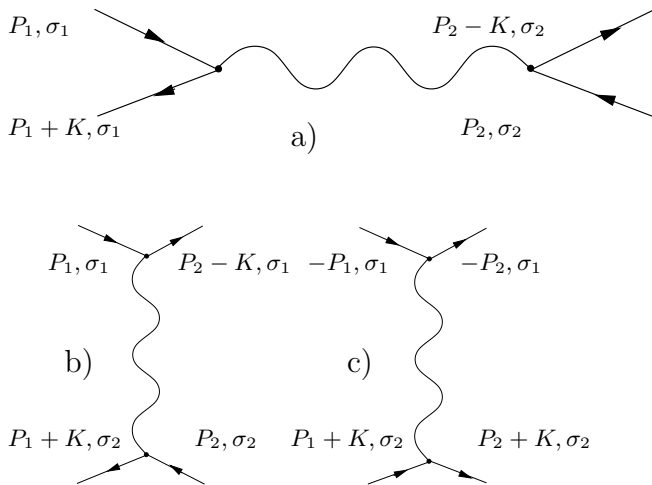

FIG. 1: Vertices describing separation into soft modes, see Eqs. (2.10) or (2.19). Momenta k are small, $k < k_c \ll p_F$. Diagrams a,b) correspond to the first and second terms in Eq. (2.19). The vertex c) was rightfully omitted in the low-energy effective theory, see text.

Figs. 2b, 3b, shows that the perturbation theory in V_1 generate in particular all the terms^{iv} the Cooper channel is responsible for. (These analogies in the two lowest orders of the logarithmic expansion are easily followed to all the higher orders). The only difference is the region of the integration over the intermediate momenta. In the diagrams of Figs. 2a, 3a, integrals over the intermediate momenta $\mathbf{p}_1, \mathbf{p}_2$ span all over the Fermi surface. On the other hand, (due to the condition $|\mathbf{k}| \simeq 1/r_0 \ll p_F$), the change in the momenta in Figs. 2b, 3b is very close to the backscattering. To be concrete, Fig. 3b) describes the region of momenta

$$|\pi - \widehat{\mathbf{p}\mathbf{p}_1}|, |\pi - \widehat{\mathbf{p}\mathbf{p}'_1}|, |\pi - \widehat{\mathbf{p}_2\mathbf{p}'}| \leq \theta_*$$

in Fig. 3a), where the maximal angle appearing in our theory is $\theta_* \simeq (p_F r_0)^{-1}$.

Taking into account the third vertex V_3 in such region of the momentum space would mean double counting the contribution of this region that is most important for our consideration^v. On the other hand, the region with the

^{iv} In fact, those terms will be properly accounted for in the renormalization group treatment of Secs. V and VI.

^v This double counting would not be important if all other regions of the Fermi surface contributed as well. In this case an error due to the double counting would be of order $(r_0 p_F)^{1-d} \ll 1$. In dirty samples, the scattering on impurities leads to such an isotropization and therefore one should include in the effective Lagrangian the third term with the vertex V_3 . The possibility to neglect it is specific for the clean systems considered here. The same approximation has been used in Ref. 22 for computation of diagrams of the conventional perturbation theory.

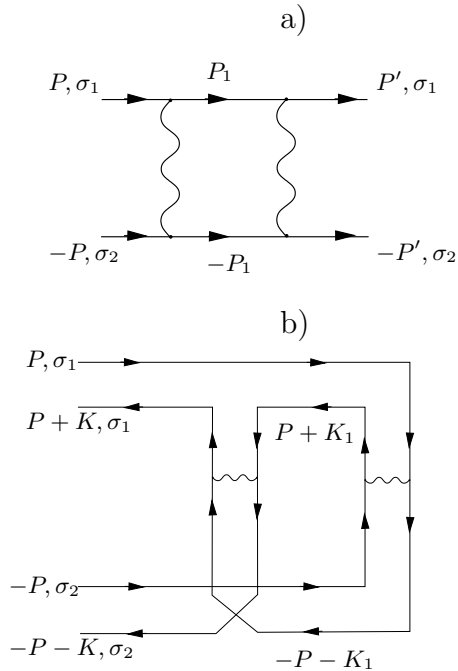

FIG. 2: a) Lowest logarithmic contribution due to the Cooper channel, $\sigma_1 \neq \sigma_2$. b) The same contribution obtained as an interaction of the spin modes generated by vertices Fig. 1b, and $k \ll p_F$. This diagram coincides with the renormalization of the quadratic part of the spin wave Lagrangian, see Fig. 9b) re-written in terms of electronic lines.

scattering angle exceeding θ_* does not appear very interesting. One could integrate over this region from the beginning and this would simply renormalize the coupling constant V_t . As we work in the limit of a weak coupling, this renormalization cannot lead to any non-trivial effects and we assume in the subsequent discussion that it has already been performed. We will return to the discussion of this renormalization in Sec. VII C.

One more uncertainty in the channel separation appears when all four momenta in \mathcal{S}_{int} of Eq. (2.7) are close to each other. In this limit the separation into slowly varying pairs in Eq. (2.10) is ambiguous. We resolve this unecertainty by attributing this region of the momenta to the vertex V_1 . As a consequence, the vertex V_2 of Eq. (2.14a) should vanish for the momenta \mathbf{p}_1 and \mathbf{p}_2 , such that $|\mathbf{p}_1 - \mathbf{p}_2| \simeq k \ll p_F$. However, the vertex V_2 enters only the singlet channel, see Eq. (2.17). As we will see, in integrals for physical quantities containing the singlet channel, the main contribution comes from integration over the momenta p_1 and p_2 well separated from each other on the Fermi surface. The contribution from small $|p_1 - p_2|$ is not singular and is small. So, for dimensionalities $d > 1$, we do not need taking special care about this region when performing calculations for the singlet channel. This argument cannot be used in $d = 1$ but, in this case, the region of the momenta all close to each other does not give logarithms and the contribution coming from this region can be neglected anyway.

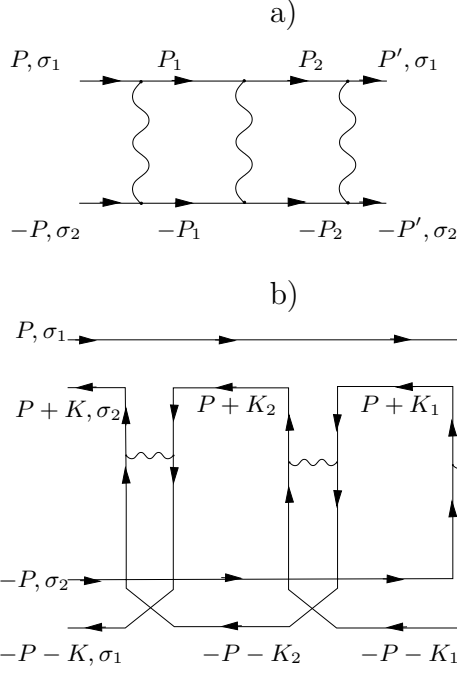

FIG. 3: a) Second order logarithmic contribution due to the Cooper channel, $\sigma_1 \neq \sigma_2$. b) The same contribution obtained as an interaction of the spin modes generated by vertices Fig. 1b, and $k \ll p_F$. This diagram coincides with the renormalization of the quadratic and quartic parts of the spin wave Lagrangian, see Figs. 9 b), 6a) re-written in terms of electronic lines.

Finally, we notice that singling out the small and large angle scattering amplitudes performed here is very similar to the one carried out for one dimensional systems⁴⁷. In 1d the vertices V_1 and V_3 are indistinguishable at all.

B. Hubbard-Stratonovich transformation

Having reduced the interaction \mathcal{L}_{int} , Eq. (2.7), to the interaction $\hat{\mathcal{S}}_{int}$, Eq. (2.15), we can decouple the quartic term by integration over an additional field $\phi_{\sigma, \sigma'}(x; \mathbf{n})$ slowly varying in space. We will still use the notation (2.2), and the unit vector \mathbf{n} labels the direction of the momentum on the Fermi surface. We introduce a matrix operator $\hat{\Phi}$ by defining its action on any function $\eta_{\sigma}(x)$ as

$$\begin{aligned} [\hat{\Phi}\eta]_{\sigma}(x) &= \sum_{\sigma'} \int \frac{dx_1 d^d \mathbf{p}}{(2\pi)^d} e^{i\mathbf{p}(\mathbf{r}-\mathbf{r}_1)} \\ &\times \left\{ \phi_{\sigma, \sigma'} \left(\frac{\mathbf{r}_1 + \mathbf{r}}{2}, \tau; \frac{\mathbf{p}}{|\mathbf{p}|} \right) \eta_{\sigma'}(\mathbf{r}_1, \tau) \right\}. \end{aligned} \quad (2.21)$$

Then we represent the 2×2 matrix in the spin space $\hat{\phi}(x; \mathbf{n})$ in the form

$$\hat{\phi}(x, \mathbf{n}) = i\varphi(x, \mathbf{n}) \mathbf{1}_{\sigma} + \boldsymbol{\sigma} \cdot \mathbf{h}(x, \mathbf{n}), \quad (2.22)$$

where $\mathbf{1}_{\sigma}$ is the 2×2 unit matrix in the spin space, $\varphi(x, \mathbf{n})$ is a real function, $\mathbf{h}(x, \mathbf{n})$ is a three dimensional real vector function $\mathbf{h} = (h_x, h_y, h_z)$, and $\boldsymbol{\sigma}$ is the vector of the Pauli matrices, as it was defined after Eq. (2.14b). The auxiliary fields are defined as bosonic:

$$\hat{\phi}(\mathbf{r}, \tau; \mathbf{n}) = \hat{\phi} \left(\mathbf{r}, \tau + \frac{1}{T}; \mathbf{n} \right). \quad (2.23)$$

Then, the partition function Z , Eq. (2.3), can be re-written as a functional integral over the smooth fields:

$$\begin{aligned} Z &= \frac{1}{Z_{st}} \int Z \{ \hat{\phi} \} W_s \{ \phi \} W_t \{ \mathbf{h} \} D\varphi D\mathbf{h} \\ Z_{st} &= \int W_s \{ \phi \} W_t \{ \mathbf{h} \} D\varphi D\mathbf{h}. \end{aligned} \quad (2.24)$$

Here, the functional $Z \{ \hat{\phi} \}$ is the partition function of the non-interacting fermions subjected to the smooth field $\hat{\phi}$:

$$Z \{ \hat{\phi} \} = \int \exp \left(- \int dx \mathcal{L}_{eff} \{ \hat{\phi} \} \right) D\chi D\chi^*. \quad (2.25)$$

The Lagrangian density \mathcal{L}_{eff} for a given configuration of the fields φ, \mathbf{h} reads

$$\mathcal{L}_{eff} \{ \hat{\phi} \} = \mathcal{L}_0 + \sum_{\sigma} \chi_{\sigma}^*(x) \left[\hat{\Phi} \chi \right]_{\sigma}(x), \quad (2.26)$$

where the Lagrangian density for the fermions \mathcal{L}_0 is defined in Eq. (2.5).

The weights for the bosonic fields W_{st} are of the form

$$W_s = \exp \left\{ -\frac{1}{2} \int \varphi(x, \mathbf{n}) \left[\hat{\mathbf{V}}_s^{-1} \varphi \right](x, \mathbf{n}) dx d\mathbf{n} \right\}, \quad (2.27a)$$

$$W_t = \exp \left\{ -\frac{1}{2} \sum_{i=x,y,z} \int h_i(x, \mathbf{n}) \left[\hat{\mathbf{V}}_t^{-1} h_i \right](x, \mathbf{n}) dx d\mathbf{n} \right\}. \quad (2.27b)$$

Here we use the notation (2.2) and the convention (1.2) for the integration over the direction of the momentum \mathbf{n} .

The operators $\hat{\mathbf{V}}_{s,t}$ in Eqs. (2.27a, 2.27b) are defined by its action on any function $a(x, \mathbf{n})$

$$\left[\hat{\mathbf{V}}_t a \right](x, \mathbf{n}) = \pm \int d\mathbf{r}_1 \bar{f}(\mathbf{r} - \mathbf{r}_1) \left[\hat{\mathbf{V}}_t a \right](\mathbf{r}_1, \tau; \mathbf{n}), \quad (2.28)$$

where $\hat{\mathbf{V}}_{s,t}$ are defined in Eq. (2.18). Different signs for the singlet (+) and triplet (-) channels correspond to the fact that the operator $\hat{\mathbf{V}}_s$ is the positive definite and $\hat{\mathbf{V}}_t$ is the negative definite, see Eq. (2.17). The choice of the weights (2.27) together with the fact that the fields φ, \mathbf{h} must be real is guided by the requirement that the functional integrals to be absolutely convergent. The function $\bar{f}(\mathbf{r})$ is the Fourier transform of the function $f(\mathbf{k})$ defined in Eq. (2.13):

$$\bar{f}(\mathbf{r}) = r_0^{-d} \bar{f}_0(r/r_0) \quad (2.29)$$

and $\bar{f}_0(r)$ is the Fourier transform of $f_0(k)$. The function $\bar{f}(\mathbf{r})$ tends to a constant $r_0^{-d}f_0(0)$ in the limit $|\mathbf{r}|/r_0 \rightarrow 0$ and vanishes in the limit $|\mathbf{r}| \rightarrow \infty$. The role of this function is to regularize the theory at small distances leaving all interesting long distance physics intact.

Notice that Eqs. (2.27)–(2.28) are local in time and, therefore, the factors $Z_{s,t}$ of Eq. (2.24) are not relevant for the determining the properties of the system. Those factors will be usually suppressed in the subsequent formulas.

Thus, we have decoupled the interaction term $\tilde{\mathcal{S}}_{int}$, Eq. (2.15), in the action \mathcal{S} , Eq. (2.4), with the Hubbard-Stratonovich transformation, Eqs. (2.24)–(2.27b). As the field $\hat{\phi}(x, \mathbf{n})$ varies slowly in space, we can apply quasiclassical description for the electron Green functions in such fields.

C. Quasiclassical Green functions

Let us introduce Green functions $G_{\sigma, \sigma'}(x, x' | \{\hat{\phi}\})$ corresponding to the Lagrangian density $\mathcal{L}_{eff}\{\hat{\phi}\}$, Eq. (2.26), as

$$G_{\sigma, \sigma'}(x, x' | \{\hat{\phi}\}) = Z^{-1} \left\{ \hat{\phi} \right\} \times \int \chi_\sigma(x) \chi_{\sigma'}^*(x') \exp \left(- \int dx \mathcal{L}_{eff}[\Phi] \right) D\chi D\chi^*. \quad (2.30)$$

In what follows we will suppress the argument $|\{\hat{\phi}\}$ whenever its presence is self-evident.

The Green function $\hat{G}(x, x' | \{\hat{\phi}\})$, is the matrix 2×2 in the free space, is the functional of real fields φ, \mathbf{h} , and it satisfies the equations

$$\left(-\frac{\partial}{\partial \tau} - \hat{H}_{0\mathbf{r}} \right) \hat{G} + \hat{\Phi} \hat{G} = \delta(x - x') \mathbf{1}_\sigma, \quad (2.31a)$$

$$\left(\frac{\partial}{\partial \tau'} - \hat{H}_{0\mathbf{r}'} \right) \hat{G} + \hat{G} \hat{\Phi} = \delta(x - x') \mathbf{1}_\sigma, \quad (2.31b)$$

where $\hat{H}_{0\mathbf{r}}$, Eq. (2.6), acts on \mathbf{r} . The action of the operator $\hat{\Phi}$ on the Green function is determined by Eq. (2.21) as

$$\begin{aligned} [\hat{\Phi} \hat{G}]_{\sigma\sigma'}(x, x') &= \sum_{\sigma''} \int \frac{dx_1 d^d \mathbf{p}}{(2\pi)^d} e^{i\mathbf{p}(\mathbf{r}-\mathbf{r}_1)} \\ &\times \left\{ \phi_{\sigma, \sigma''} \left(\frac{\mathbf{r}_1 + \mathbf{r}}{2}, \tau; \frac{\mathbf{p}}{|\mathbf{p}|} \right) G_{\sigma'' \sigma'}(\mathbf{r}_1, \tau; x') \right\}; \\ [\hat{G} \hat{\Phi}]_{\sigma\sigma'}(x, x') &= \sum_{\sigma''} \int \frac{dx_1 d^d \mathbf{p}}{(2\pi)^d} e^{i\mathbf{p}(\mathbf{r}_1-\mathbf{r}')} \\ &\times \left\{ G_{\sigma\sigma''}(x; \mathbf{r}_1, \tau') \phi_{\sigma'' \sigma'} \left(\frac{\mathbf{r}_1 + \mathbf{r}'}{2}, \tau'; \frac{\mathbf{p}}{|\mathbf{p}|} \right) \right\}. \end{aligned} \quad (2.31c)$$

The derivation of the equations for the quasiclassical Green functions can be carried out in the same way as

in Ref. 48. Subtracting Eq. (2.31a) from Eq. (2.31b) and making a Wigner transformation

$$G(x; x') = \int \frac{d^d \mathbf{p}}{(2\pi)^d} e^{i\mathbf{p} \cdot \mathbf{r}} G \left(\tau, \tau'; \frac{\mathbf{r} + \mathbf{r}'}{2}, \mathbf{p} \right) \quad (2.32)$$

of the result, we obtain

$$0 = \left(\frac{\partial}{\partial \tau} + \frac{\partial}{\partial \tau'} - \frac{i\mathbf{p} \cdot \nabla_{\mathbf{r}}}{m} \right) \hat{G}(\tau, \tau'; \mathbf{r}, \mathbf{p}) \quad (2.33) \\ + \left[\hat{G}(\tau, \tau'; \mathbf{r}, \mathbf{p}) \hat{\phi}(\mathbf{r}, \tau'; \mathbf{n}) - \hat{\phi}(\mathbf{r}, \tau; \mathbf{n}) \hat{G}(\tau, \tau'; \mathbf{r}, \mathbf{p}) \right].$$

Equation (2.33) is justified provided the dependence of the field $\hat{\phi}(x, \mathbf{n})$ and, hence, of $\hat{G}(\tau, \tau'; \mathbf{r}; \mathbf{p})$ on the coordinate \mathbf{r} is slow on the scale of the order of Fermi wavelength. This is guarded by the cutoff scale r_0 in Eq. (2.13). In principle, one could derive Eq. (2.33) more accurately, which would produce additional terms containing phase space derivatives of the functions ϕ and \hat{G} in the second line. However, the additional derivatives would suppress the infrared singularities we are interested in, and that is why we neglected them. At the same time, no higher derivatives arise in the first bracket in Eq. (2.33) and this term is exact for the quadratic spectrum of the fermions, Eq. (2.6).

The next step is to reduce the Green function $G(\mathbf{p}, \mathbf{r})$ to a function involving the degrees of freedom describing the motion of the system along the Fermi surface. To accomplish this task we linearize the spectrum by putting

$$\frac{\mathbf{p}}{m} \approx v_F \mathbf{n} \quad (2.34)$$

in Eq. (2.33), where \mathbf{n} is the unit vector. The justification of such approximation is that the fluctuating fields can mix the electron states only in the vicinity of the Fermi surface whereas the states deep in the Fermi sea remain intact. After approximation (2.34) the operators in Eq. (2.33) do not depend on the variable

$$\xi = \mathbf{p}^2/2m - \varepsilon_F, \quad (2.35)$$

that describes the evolution perpendicular to the Fermi level and the latter can be integrated over. Then, one obtains^{48,49}

$$0 = \left(\frac{\partial}{\partial \tau} + \frac{\partial}{\partial \tau'} - iv_F \mathbf{n} \cdot \mathbf{p} \nabla_{\mathbf{r}} \right) \hat{g}(\tau, \tau'; \mathbf{r}, \mathbf{n}) \quad (2.36) \\ + \left[\hat{g}(\tau, \tau'; \mathbf{r}, \mathbf{n}) \hat{\phi}(\mathbf{r}, \tau'; \mathbf{n}) - \hat{\phi}(\mathbf{r}, \tau; \mathbf{n}) \hat{g}(\tau, \tau'; \mathbf{r}, \mathbf{n}) \right],$$

where

$$\hat{g}(\tau, \tau'; \mathbf{r}, \mathbf{n} | \{\hat{\phi}\}) \\ = \frac{i}{\pi} \int_{-\infty}^{\infty} \hat{G} \left[\tau, \tau'; \mathbf{r}; \left(p_F + \frac{\xi}{v_F} \right) \mathbf{n} | \{\hat{\phi}\} \right] d\xi. \quad (2.37)$$

The function \hat{g} must obey the antiperiodicity conditions

$$\hat{g}(\tau, \tau'; \mathbf{r}, \mathbf{n}) = -\hat{g}(\tau + 1/T, \tau'; \mathbf{r}, \mathbf{n}) \\ = -\hat{g}(\tau, \tau' + 1/T; \mathbf{r}, \mathbf{n}) \quad (2.38)$$

that follow from Eqs. (2.8), (2.30), (2.32), and (2.37). Clearly, this condition is consistent with Eq. (2.36) for the periodic fluctuating fields $\hat{\phi}$, see Eq. (2.23).

Equation (2.36) is linear and therefore is not sufficient to find $\hat{g}(\tau, \tau'; \mathbf{r}, \mathbf{n})$ unambiguously. In order to define the problem completely, one has to complement Eq. (2.38) with a certain constraint. To derive this constraint, we introduce a new function

$$\begin{aligned} & \hat{B}(\tau, \tau'; \mathbf{r}, \mathbf{n} | \{\hat{\phi}\}) \\ &= \int_0^{1/T} d\tau'' \hat{g}(\tau, \tau''; \mathbf{r}, \mathbf{n} | \{\hat{\phi}\}) \hat{g}(\tau'', \tau'; \mathbf{r}, \mathbf{n} | \{\hat{\phi}\}). \end{aligned} \quad (2.39)$$

Using the definition (2.39), we obtain from Eq. (2.36)

$$\begin{aligned} 0 &= \left(\frac{\partial}{\partial \tau} + \frac{\partial}{\partial \tau'} - iv_F \mathbf{n} \cdot \mathbf{p} \nabla_{\mathbf{r}} \right) \hat{B}(\tau, \tau'; \mathbf{r}, \mathbf{n}) \\ &+ \left[\hat{B}(\tau, \tau'; \mathbf{r}, \mathbf{n}) \hat{\phi}(\mathbf{r}, \tau'; \mathbf{n}) - \hat{\phi}(\mathbf{r}, \tau; \mathbf{n}) \hat{B}(\tau, \tau'; \mathbf{r}, \mathbf{n}) \right]. \end{aligned} \quad (2.40)$$

In the absence of the fluctuating field, $\hat{\phi} = 0$, the Green function can be easily found from Eqs. (2.31a), (2.32) and (2.37)

$$\begin{aligned} \hat{g}(\tau, \tau'; \mathbf{r}, \mathbf{n} | 0) &= \frac{i\mathbb{1}_\sigma T}{\pi} \sum_{\epsilon_n} e^{i\epsilon_n(\tau' - \tau)} \int \frac{d\xi}{i\epsilon_n - \xi} \\ &= -i\mathbb{1}_\sigma \text{Re} \left[\frac{T}{\sin \pi T (\tau - \tau' + i0)} \right]. \end{aligned} \quad (2.41)$$

Substituting Eq. (2.41) into definition Eq. (2.39) and performing the integration, we find

$$\hat{B}(\tau, \tau'; \mathbf{r}, \mathbf{n} | 0) = \mathbb{1}_\sigma \delta(\tau - \tau'). \quad (2.42)$$

Substitution of Eq. (2.42) into Eq. (2.40) shows that Eq. (2.43) remains valid for the arbitrary field ϕ ,

$$\hat{B}(\tau, \tau'; \mathbf{r}, \mathbf{n} | \{\hat{\phi}\}) = \mathbb{1}_\sigma \delta(\tau - \tau'). \quad (2.43)$$

i.e. no perturbation by the Hubbard-Stratonovich fields can violate the condition (2.42).

Equations (2.39) and (2.43) complement Eq. (2.36) and these equations are sufficient to find the function \hat{g} . Eq. (2.36) is much simpler than the original Schrödinger equation (2.31a) as it operates with the smooth quantities and involves only the first derivatives. The further program is to solve Eqs. (2.36), (2.39) and (2.43) for arbitrary configurations of the fields ϕ . After that, in order to calculate physical quantities, one should perform a proper averaging over fields ϕ with the weights defined in Eqs. (2.27). All this is still not a simple task and in the next Sections we will express the solution of these equations in terms of a functional integral over supervectors, in order to obtain the *local* theory in terms of only the bosonic variables describing the collective excitations.

III. CHARGE AND SPIN COLLECTIVE VARIABLES. PARTITION FUNCTION

A. Further simplification of the quasiclassical equations

Solutions of Eqs. (2.36), (2.39), and (2.43) describe collective excitations and our task is to find them at least symbolically in order to facilitate calculation of the partition function $Z\{\phi\}$, see Eq. (2.25) and the averaging over the auxiliary field ϕ .

At first glance, we could simply follow the scheme developed in Ref. 35 writing the solution of these equations in terms of a functional integral over constrained supermatrices. However, in the present situation this scheme is not convenient due to the dependence the Hubbard-Stratonovich field ϕ on τ .

Instead, we look for the solution of Eqs. (2.36), (2.43), and (2.39) in a form

$$\begin{aligned} & \hat{g}(\tau, \tau'; \mathbf{r}, \mathbf{n} | \{\hat{\phi}\}) \\ &= \hat{\mathcal{T}}(\tau; \mathbf{r}, \mathbf{n} | \{\hat{\phi}\}) \hat{g}(\tau, \tau' | 0) \hat{\mathcal{T}}^{-1}(\tau'; \mathbf{r}, \mathbf{n} | \{\hat{\phi}\}) \end{aligned} \quad (3.1)$$

where the Green function for the free electrons, $\hat{g}(\tau, \tau' | 0)$ is defined in Eq. (2.41). The 2×2 matrix in the spin space, $\hat{\mathcal{T}}$ satisfies the condition

$$\hat{\mathcal{T}}(\tau; \mathbf{r}, \mathbf{n} | \{\hat{\phi}\}) = \hat{\mathcal{T}}\left(\tau + \frac{1}{T}; \mathbf{r}, \mathbf{n} | \{\hat{\phi}\}\right) \quad (3.2)$$

so that the antiperiodicity of the Green function (2.38) is preserved. In the remainder of this subsection, we will suppress the argument $|\{\hat{\phi}\}$ whenever it is self-evident.

The representation of the Green function in the form of Eq. (3.1) is nothing but the matrix form of the eikonal approximation, which can also be viewed as a generalization of the Schwinger Ansatz⁵⁰. It is easy to check that the Green function, Eq. (3.1) is consistent with Eqs. (2.43), and (2.39), and what remains to be done is to find the proper matrix $\hat{\mathcal{T}}$, such that Eq. (2.36) is satisfied.

Substituting Eq. (3.1) into Eq. (2.36) we obtain

$$\hat{g}(\tau, \tau' | 0) \left[\hat{K}(\tau, \mathbf{r}, \mathbf{n}) - \hat{K}(\tau', \mathbf{r}, \mathbf{n}) \right] = 0, \quad (3.3)$$

where the 2×2 matrix in the spin space \hat{K} is given by

$$\begin{aligned} \hat{K}(x, \mathbf{n}) &= \hat{\mathcal{T}}^{-1}(x, \mathbf{n}) (\partial_\tau - iv_F \mathbf{n} \nabla_{\mathbf{r}}) \hat{\mathcal{T}}(x, \mathbf{n}) \\ &- \hat{\mathcal{T}}^{-1}(x, \mathbf{n}) \hat{\phi}(x, \mathbf{n}) \hat{\mathcal{T}}(x, \mathbf{n}), \end{aligned} \quad (3.4)$$

and we use the short-hand notation (2.2).

Equation (3.3) must be fulfilled for any τ and τ' . This is possible only for $\partial_\tau \hat{K}(x, \mathbf{n}) = 0$. Using Eq. (3.4), we obtain

$$\begin{aligned} & (-\partial_\tau + iv_F \mathbf{n} \nabla_{\mathbf{r}}) \hat{\mathcal{T}}(x, \mathbf{n}) \\ &= \hat{\mathcal{T}}(x, \mathbf{n}) \hat{A}(\mathbf{r}, \mathbf{n}) - \hat{\phi}(x, \mathbf{n}) \hat{\mathcal{T}}(x, \mathbf{n}) \end{aligned} \quad (3.5a)$$

where $\hat{A}(\mathbf{r}, \mathbf{n})$ is an arbitrary time independent matrix.

We can transform Eq. (3.5a) to a more convenient form writing the corresponding equation for $\hat{\mathcal{T}}^{-1}(x, \mathbf{n})$

$$\begin{aligned} (\partial_\tau - iv_F \mathbf{n} \nabla_{\mathbf{r}}) \hat{\mathcal{T}}^{-1}(x, \mathbf{n}) \\ = \hat{A}(\mathbf{r}, \mathbf{n}) \hat{\mathcal{T}}^{-1}(x, \mathbf{n}) - \hat{\mathcal{T}}^{-1}(x, \mathbf{n}) \hat{\phi}(x, \mathbf{n}) \end{aligned} \quad (3.5b)$$

We differentiate Eq. (3.5a) with respect to τ and post-multiply it by $\hat{\mathcal{T}}^{-1}(x, \mathbf{n})$. Then we pre-multiply Eq. (3.5b) by $\partial_\tau \hat{\mathcal{T}}^{-1}(x, \mathbf{n})$ and subtract thus obtained equations from each other. As the result, we find

$$\begin{aligned} (-\partial_\tau + iv_F \mathbf{n} \nabla_{\mathbf{r}}) \hat{M}(x, \mathbf{n}) \\ + \left[\hat{\phi}(x, \mathbf{n}), M_{\mathbf{n}}(x) \right] = -\partial_\tau \hat{\phi}(x, \mathbf{n}) \end{aligned} \quad (3.6)$$

where

$$\hat{M}(x, \mathbf{n}) = \frac{\partial \hat{\mathcal{T}}(x, \mathbf{n})}{\partial \tau} \hat{\mathcal{T}}^{-1}(x, \mathbf{n}) \quad (3.7)$$

and the symbol $[\dots, \dots]$ stands for the commutator.

Using the representation (2.22) for the matrix $\hat{\phi}(x, \mathbf{n})$, we look for the matrix $\hat{M}(x, \mathbf{n})$ in the form

$$\hat{M}(x, \mathbf{n}) = i\rho(x, \mathbf{n}) \mathbf{1}_\sigma + \mathbf{S}(x, \mathbf{n}) \cdot \boldsymbol{\sigma} \quad (3.8)$$

where $\rho(x, \mathbf{n})$ is a scalar real field and $\mathbf{S}_{\mathbf{n}}(x, \mathbf{n})$ is a real three dimensional vector field. As follows from Eqs. (3.8) and (3.2), those fields are periodic

$$\begin{aligned} \rho(\tau, \mathbf{r}, \mathbf{n}) &= \rho\left(\tau + \frac{1}{T}, \mathbf{r}, \mathbf{n}\right); \\ \mathbf{S}(\tau, \mathbf{r}, \mathbf{n}) &= \mathbf{S}\left(\tau + \frac{1}{T}, \mathbf{r}, \mathbf{n}\right). \end{aligned} \quad (3.9)$$

Substituting Eq. (3.8) into Eq. (3.6) we obtain two independent equations for $\rho(x, \mathbf{n})$ and $\mathbf{S}(x, \mathbf{n})$:

$$\left(-\frac{\partial}{\partial \tau} + iv_F \mathbf{n} \nabla_{\mathbf{r}}\right) \rho_{\mathbf{n}}(x) = -\frac{\partial \varphi(x, \mathbf{n})}{\partial \tau} \quad (3.10a)$$

$$\begin{aligned} \left(-\frac{\partial}{\partial \tau} + iv_F \mathbf{n} \nabla_{\mathbf{R}}\right) \mathbf{S}_{\mathbf{n}}(x) \\ + 2i[\mathbf{h}_{\mathbf{n}}(x) \times \mathbf{S}_{\mathbf{n}}(x)] = -\frac{\partial \mathbf{h}_{\mathbf{n}}(x)}{\partial \tau} \end{aligned} \quad (3.10b)$$

It is easy to see that Eqs. (3.10) are consistent with the periodicity requirements (3.9) and (2.22).

Equations (3.10) are the final quasiclassical equations that will be used for further calculations. We emphasize that Eqs. (3.10) are obtained from Eqs. (2.36), (2.39), (2.43) without making any further approximation. The field $\rho(x, \mathbf{n})$ corresponds to the density fluctuation in the phase space, whereas the field $\mathbf{S}(x, \mathbf{n})$ describes the spin fluctuations.

Equations (3.10a) and (3.10b) determining these fluctuations due to the Hubbard-Stratonovich fields are remarkably different from each other. Equation (3.10a) for

the density is rather simple, and can be solved immediately by the Fourier transform. This is what one obtains using the high dimensional bosonization of Refs. 6,7,39–46 from an eikonal equation. Of course, we could take into account gradients of the field $\varphi(x, \mathbf{n})$ and this would lead to additional terms in the L.H.S. of Eq. (3.10a). However, this does not lead to new physical effects.

In contrast, Eq. (3.10b) is not readily solvable due to the presence of $\mathbf{h}(x, \mathbf{n})$ in the left-hand-side (L.H.S) of this equation. Actually, the L.H.S of Eq. (3.10b) is just the equation of motion of a classical spin-density in the external magnetic field \mathbf{h} . We will see that the presence of this form will result in non-trivial effects that will be considered later. To the best of our knowledge, this difference between the charge and spin excitations in $d > 1$ has not been emphasized in literature.

B. Partition function

Having found the semiclassical representation for the Green functions, we are prepared to express the partition function $Z\{\hat{\phi}\}$ from Eq. (2.25) in terms of the collective variables $\rho(x, \mathbf{n})$ and $\mathbf{S}(x, \mathbf{n})$. Integrating over χ, χ^* in Eq. (2.25) and using Eqs. (2.26), (2.5) for the Lagrangian density $\mathcal{L}_{eff}\{\hat{\phi}\}$, we write $Z\{\hat{\phi}\}$ in the form

$$\ln Z\{\hat{\phi}\} = Tr \int \ln(-\partial_\tau \mathbf{1}_\sigma - H_0 \mathbf{1}_\sigma + \hat{\Phi}), \quad (3.11)$$

where the Hamiltonian H_0 is introduced in Eq. (2.6), operator $\hat{\Phi}$ is defined by Eq. (2.21), and Tr includes the trace in the spin space as well as the integration over \mathbf{r}, τ .

Equation (3.11) can be rewritten using the standard trick of integration over coupling the constant as

$$\begin{aligned} \ln Z\{\hat{\phi}\} - \ln Z\{0\} \\ = \int_0^1 du \partial_u Tr \int \ln(-\partial_\tau \mathbf{1}_\sigma - H_0 \mathbf{1}_\sigma + u \hat{\Phi}) \\ = \int_0^1 du \sum_\sigma \int dx [\hat{\Phi} \hat{G}\{u \hat{\phi}\}]_{\sigma\sigma}(x, x), \end{aligned} \quad (3.12)$$

where the Green function $\hat{\Phi} \hat{G}\{u \hat{\phi}\}$ is obtained from that of Eq. (2.31a) by the rescaling of the Hubbard-Stratonovich fields: $\hat{\Phi} \rightarrow u \hat{\Phi}$, and the action of the operator $\hat{\Phi}$ is defined by Eq. (2.31c). The term $\ln Z\{0\}$ describes the thermodynamics of the non-interacting fermions, and we will suppress this term in all the subsequent formulae.

Using Eqs. (2.31c) and (2.32), we obtain from

Eq. (3.12)

$$\begin{aligned} & \ln Z \left\{ \hat{\phi} \right\} \\ &= \int_0^1 du \int dx \int \frac{d^d \mathbf{p}}{(2\pi)^d} \text{Tr}_{\sigma} \hat{\phi}(x; \mathbf{n}) \hat{G} \left(\tau, \tau; \mathbf{r}, \mathbf{p} \left| \left\{ u \hat{\phi} \right\} \right. \right), \end{aligned} \quad (3.13)$$

where Tr_{σ} denotes the trace in the spin space, and the short hand notation (2.2) is used. We represent the integration over the momentum as

$$\int \frac{d^d \mathbf{p}}{(2\pi)^d} \dots = \int \nu(\xi) d\xi \int d\mathbf{n} \dots,$$

where $\nu(\xi)$ is the density of states (DoS) per one spin orientation, $\xi = 0$ corresponds to the Fermi level and we use the convention (1.2) for the integration over the direction over the momentum on Fermi surface, \mathbf{n} . Neglecting the energy dependence of DoS, we obtain from Eq. (3.13)

$$\begin{aligned} & \ln Z \left\{ \hat{\phi} \right\} \\ &= -i\pi\nu \int_0^1 du \int dx \int d\mathbf{n} \text{Tr}_{\sigma} \hat{\phi}(x; \mathbf{n}) \hat{g} \left(\tau, \tau; \mathbf{r}, \mathbf{n} \left| \left\{ u \hat{\phi} \right\} \right. \right), \end{aligned} \quad (3.14)$$

where $\nu \equiv \nu(\xi = 0)$ is the DoS on the Fermi level per one spin orientation, Green function $\hat{g} \left(\tau, \tau'; \mathbf{r}, \mathbf{p} \left| \left\{ u \hat{\phi} \right\} \right. \right)$ satisfies the constraints (2.39) and (2.43) and satisfies Eq. (2.36) with the rescaling $\hat{\phi} \rightarrow u \hat{\phi}$. According to Eq. (2.41) \hat{g} is a singular function at coinciding time, so that the equal time value should be understood as

$$\hat{g}(\tau, \tau) \equiv \frac{1}{2} \lim_{\delta \rightarrow 0} [\hat{g}(\tau, \tau + \delta) + \hat{g}(\tau, \tau - \delta)]. \quad (3.15)$$

Next, we substitute Eq. (3.1) into Eq. (3.14). Using Eq. (2.41) and the rule (3.15), we find

$$\begin{aligned} & \hat{g} \left(\tau, \tau; \mathbf{r}, \mathbf{n} \left| \left\{ u \hat{\phi} \right\} \right. \right) \\ &= \frac{i}{2} \lim_{\delta \rightarrow 0} \frac{1}{\delta} \left[\hat{\mathcal{T}} \left(\tau; \mathbf{r}, \mathbf{n} \left| \left\{ u \hat{\phi} \right\} \right. \right) \hat{\mathcal{T}}^{-1} \left(\tau + \delta; \mathbf{r}, \mathbf{n} \left| \left\{ u \hat{\phi} \right\} \right. \right) \right. \\ & \quad \left. - \hat{\mathcal{T}} \left(\tau; \mathbf{r}, \mathbf{n} \left| \left\{ u \hat{\phi} \right\} \right. \right) \hat{\mathcal{T}}^{-1} \left(\tau - \delta; \mathbf{r}, \mathbf{n} \left| \left\{ u \hat{\phi} \right\} \right. \right) \right] \\ &= -i \frac{\partial \hat{\mathcal{T}} \left(\tau; \mathbf{r}, \mathbf{n} \left| \left\{ u \hat{\phi} \right\} \right. \right)}{\partial \tau} \hat{\mathcal{T}}^{-1} \left(\tau; \mathbf{r}, \mathbf{n} \left| \left\{ u \hat{\phi} \right\} \right. \right). \end{aligned}$$

Using the definition, Eq. (3.7), the representation (3.8), and equations of motion (3.10), we obtain finally from Eq. (3.14)

$$Z \left\{ \hat{\phi} \right\} = Z_0 Z_{\rho} \{ \varphi \} Z_s \{ \mathbf{h} \}. \quad (3.16a)$$

Here

$$Z_{\rho} = \exp \left[2\nu \int_0^1 du \int \rho(x, \mathbf{n}; u) \varphi(x, \mathbf{n}) dx d\mathbf{n} \right], \quad (3.16b)$$

$$Z_s = \exp \left[-2\nu \int_0^1 du \int \mathbf{S}(x, \mathbf{n}; u) \mathbf{h}(x, \mathbf{n}) dx d\mathbf{n} \right]. \quad (3.16c)$$

The functions $\rho(x, \mathbf{n}; u)$ and $\mathbf{S}(x, \mathbf{n}; u)$ should be found from the equations [cf. Eqs. (3.10)]

$$(-\partial_{\tau} + iv_F \mathbf{n} \nabla_{\mathbf{r}}) \rho(x, \mathbf{n}; u) = -u \partial_{\tau} \varphi(x, \mathbf{n}), \quad (3.17)$$

$$\hat{L}_u \mathbf{S}(x, \mathbf{n}; u) = -u \partial_{\tau} \mathbf{h}(x, \mathbf{n}). \quad (3.18)$$

In Eq. (3.18), the operator \hat{L}_u equals

$$\hat{L}_u = (-\partial_{\tau} + iv_F \mathbf{n} \nabla_{\mathbf{r}}) \mathbf{1}_s + 2iu \hat{h}(x, \mathbf{n}) \quad (3.19)$$

where the matrix \hat{h} has the following form

$$\hat{h}(x, \mathbf{n}) = \begin{pmatrix} 0 & -h_z(x, \mathbf{n}) & h_y(x, \mathbf{n}) \\ h_z(x, \mathbf{n}) & 0 & -h_x(x, \mathbf{n}) \\ -h_y(x, \mathbf{n}) & h_x(x, \mathbf{n}) & 0 \end{pmatrix}_s, \quad (3.20)$$

and h_x, h_y , and h_z are the components of the real vector \mathbf{h} ($\hat{h}\mathbf{a} = [\mathbf{h} \times \mathbf{a}]$ for any vector \mathbf{a}). We will call this space of three dimensional vectors the ‘‘spin space’’ as the 2×2 spin space for the original electron will be no longer needed in further considerations. The functions $\mathbf{S}(x, \mathbf{n}; u)$ and $\rho(x, \mathbf{n}; u)$ satisfy the periodicity condition (3.9).

The operator \hat{L}_u , Eq. (3.19), is antisymmetric

$$\hat{L}_u^T = -\hat{L}_u \quad (3.21)$$

where the transposition ‘‘T’’ includes both the changing of the sign of the derivatives and the transposition of the spin indices. However, this operator is neither Hermitian nor anti-Hermitian. The importance of this subtlety will be underlined in the next section.

Thus, in order to calculate the partition function, Eq. (2.3), for the system of interacting fermions in the quasiclassical approximation, one should solve Eqs. (3.17), (3.18) and substitute their solutions into Eqs. (3.16a)–(3.16c). Then, one should use Eq. (2.24) and average over the fields φ and \mathbf{h} with the weight given by Eq. (2.27).

Before proceeding, we notice that there is a well-known flaw in the quasiclassical approximation (3.14) to the exact Eq. (3.12) (this flaw is usually referred to as an ultraviolet anomaly). In Eq. (3.12), the two times in the Green function are put equal to each other *before* the integration over the momentum is performed, whereas Eqs. (3.14)–(3.15) imply the opposite order of the limits.

Those operations do not commute as they treat contributions from the region far from the Fermi surface differently: in the quasiclassical approximation the information that the electron states are limited from below at $\xi > -\epsilon_F$ is lost. Lost contributions, however, are coming from the transitions with the large energy and therefore are perfectly analytic functions of fields φ , \mathbf{h} , and their gradients. As the result, Eqs. (3.16a) is modified as

$$\begin{aligned} Z\{\hat{\phi}\} &= Z_0 Z_\rho\{\varphi\} Z_\rho^{uv}\{\varphi\} Z_s\{\mathbf{h}\} Z_s^{uv}\{\mathbf{h}\} \\ \ln Z_\rho^{uv} &= -\nu \int dx d\mathbf{n} d\mathbf{n}' \phi(x, \mathbf{n}) d_\rho(\widehat{\mathbf{nn}'}) \phi(x, \mathbf{n}') + \dots \\ \ln Z_s^{uv} &= \nu \int dx d\mathbf{n} d\mathbf{n}' \mathbf{h}(x, \mathbf{n}) d_s(\widehat{\mathbf{nn}'}) \mathbf{h}(x, \mathbf{n}') + \dots, \end{aligned} \quad (3.22)$$

where \dots stand for the terms containing higher gradients of the field or the higher powers of the field. All such terms however will be small as $1/\epsilon_F$ and that is why keeping them would be the overstepping of the accuracy of the quasiclassical equations (2.36).

Functions $d_{\rho,s}(\theta)$ depend on the details of the ultraviolet cut-off [for the weakly interacting gas $d_\rho = d_\sigma$]. One property, however, remains intact – the response of the system on the fields independent on the coordinate but arbitrary periodic function of time $\varphi(\tau)$, $\mathbf{h}(\tau)$; $\int_0^{1/T} \varphi(\tau) d\tau = \int_0^{1/T} \mathbf{h}(\tau) = 0$ should vanish, because the total charge and the total spin commute with the Hamiltonian:

$$Z_\rho\{\varphi(\tau)\} Z_\rho^{uv}\{\varphi(\tau)\} = Z_s\{\mathbf{h}(\tau)\} Z_s^{uv}\{\mathbf{h}(\tau)\} = 1. \quad (3.23)$$

For such fields, Eqs. (3.17) – (3.18) are trivially solved $\rho(\tau, u) = -u\phi(\tau)$, $\mathbf{S}(\tau, u) = -u\mathbf{h}(\tau)$ and we obtain from Eqs. (3.23), (3.16b), (3.16c) and (3.22)

$$\int d_\rho(\widehat{\mathbf{nn}'}) d\mathbf{n} = \int d_s(\widehat{\mathbf{nn}'}) d\mathbf{n} = 1. \quad (3.24)$$

All the other properties of $d_{\rho,s}$ are model dependent and can be established by direct perturbative calculation for stationary fields for which the semiclassical contributions (3.16b)–(3.16c) vanish.

However, it would be a redundant exercise, as Eq. 3.22 have the same form as the weights (2.27), and the role of terms (3.22) is just a renormalization of the constants in those weights. The contribution of the interaction terms with the high-momentum transfer not included into the Hubbard-Stratonovich transformation leads to the similar effects. It means, that the form of the weights for the fields h , φ should be established not from the first principles but from the requirement that the quadratic part of the theory should reproduce the bosonic modes obtained from the kinetic equation in the Landau theory of Fermi liquid. It leads to the replacement of Eqs. (2.27) with

$$\mathcal{W}_s = \exp\left\{-\frac{\nu}{2} \int \varphi(x, \mathbf{n}) \left[\hat{\Gamma}_s^{-1}\varphi\right](x, \mathbf{n}) dx d\mathbf{n}\right\} \quad (3.25a)$$

$$\mathcal{W}_t = \exp\left\{-\frac{\nu}{2} \sum_{i=x,y,z} \int h_i(x, \mathbf{n}) \left[\hat{\Gamma}_t^{-1}h_i\right](x, \mathbf{n}) dx d\mathbf{n}\right\}, \quad (3.25b)$$

where the operators $\hat{\Gamma}_{s,t}$ are defined by its action on any function $a(x, \mathbf{n})$ as

$$2\hat{\Gamma}_s = \hat{f} \frac{\hat{\mathbb{F}}^\rho}{1 + \hat{\mathbb{F}}^\rho} \quad (3.25c)$$

$$2\hat{\Gamma}_t = -\hat{f} \frac{\hat{\mathbb{F}}^\sigma}{1 + \hat{\mathbb{F}}^\sigma}. \quad (3.25d)$$

Here operators \hat{f} and $\hat{\mathbb{F}}$ are defined by their action on an arbitrary function $b(\tau, \mathbf{r}; \mathbf{n})$ as

$$\left[\hat{f}b\right](\mathbf{r}, \tau; \mathbf{n}) = \int d\mathbf{r}_1 \bar{f}(\mathbf{r} - \mathbf{r}_1) b(\mathbf{r}_1, \tau; \mathbf{n}) \quad (3.25e)$$

$$\left[\hat{\mathbb{F}}^{\rho,\sigma}b\right](\mathbf{r}, \tau; \mathbf{n}) = \int d\mathbf{n}_2 \mathbb{F}^{\rho,\sigma}(\widehat{\mathbf{nn}_2}) b(\mathbf{r}, \tau; \mathbf{n}_2),$$

and the convention (1.2) is used. The cutoff function \bar{f} is defined by Eq. (2.29), while the functions $\mathbb{F}^{\rho,\sigma}$ are the Fermi liquid functions describing the interaction between two quasiparticles in the singlet or triplet states. We will see in the next subsection that the choice (3.25) indeed reproduces the correct propagators for the collective modes in the Fermi liquid theory. In what follows we assume the operators $\hat{\Gamma}_{s,t}$ to be positive definite, and the system far from Pomeranchuk instabilities.

With the help of the quasiclassical consideration we can recast Eq. (2.24) to the form

$$\Omega = -T \ln Z = \Omega_0 + \Omega_\rho + \Omega_s \quad (3.26a)$$

where $\Omega_0 = -T \ln Z_0$ describes the leading contribution of the quasiparticles. The leading singular corrections are associated with the collective modes and they are given by

$$\exp\left(-\frac{\Omega_\rho}{T}\right) = \int D\varphi \mathcal{W}_s\{\varphi\} Z_\rho\{\varphi\} \quad (3.26b)$$

$$\exp\left(-\frac{\Omega_s}{T}\right) = \int D\mathbf{h} \mathcal{W}_t\{\mathbf{h}\} Z_s\{\mathbf{h}\}, \quad (3.26c)$$

where the functionals $Z_{\rho,s}$ are given by Eqs. (3.16b)–(3.16c). In writing the expression for the partition function we ignored the terms, [e.g. $Z_s t$ in Eq. (2.24)], which do not lead to change of any observable quantities.

The results of the present Section show that study of the system of the interacting fermions can be reduced to investigation of a system of bosonic charge and spin excitations. Therefore the word “bosonization” is most suitable for our approach. We see that the method should work in any dimension. At the same time, it is more general than the scheme of the high dimensional bosonization of Refs. 6,7,39–46 because we can consider the spin excitations that are much less trivial than the charge ones.

C. Thermodynamics of free modes.

Before we start formulating the proper field theory description for calculating the partition functions (3.26b) – (3.26c), it is instructive to try to determine it by the brute force analysis of Eqs. (3.16b)–(3.16c).

For the charge mode we immediately solve Eq. (3.17) by the Fourier transform:

$$\rho(\omega_n, k; \mathbf{n}) = u \frac{i\omega_n}{i\omega_n - v_F \mathbf{k} \mathbf{n}} \varphi(\omega_n, k; \mathbf{n}). \quad (3.27)$$

where $\omega_n = 2\pi T n$ is the bosonic Matsubara frequency, Eq. (3.9), and

$$\varphi(\omega_n, \mathbf{k}; \mathbf{n}) = \varphi^*(-\omega_n, -\mathbf{k}; \mathbf{n}) \quad (3.28)$$

because the field $\varphi(x; \mathbf{n})$ is real. Substituting Eq. (3.27) into Eq. (3.16b), we find

$$Z_\rho = \exp \left[\nu T \sum_{\omega_n} \int \frac{d^d \mathbf{k} d\mathbf{n}}{(2\pi)^d} \frac{i\omega_n |\varphi(\omega_n, \mathbf{k}; \mathbf{n})|^2}{i\omega_n - v_F \mathbf{k} \mathbf{n}} \right]. \quad (3.29)$$

Both the partition function, Eq. (3.29), and the weight, Eq. ((3.25a)) are the Gaussian functionals and, therefore, the functional integration in Eq. (3.26b) can be readily performed with the result

$$\Omega_\rho = \frac{T}{2} \sum_{\omega_n} \int \frac{d^d \mathbf{k} d\mathbf{n}}{(2\pi)^d} \ln \left[1 + f(\mathbf{k}) \hat{\mathbb{F}}^\rho \frac{v_F \mathbf{k} \mathbf{n}}{-i\omega_n + v_F \mathbf{k} \mathbf{n}} \right]. \quad (3.30)$$

Here, factor of 1/2 originates due to the constraint (3.28), and the action of the interaction function $\hat{\mathbb{F}}^\rho$ is defined by Eq. (3.25e). The function $f(\mathbf{k})$, Eq. (2.13), cuts momenta k exceeding r_0^{-1} . However, its presence in Eq. (3.30) is important only for calculation of corrections to the coefficient in the linear term in the specific heat. Non-trivial contributions to the specific heat C come from the momenta $k \sim T/v_F \ll r_0^{-1}$ and do not depend on the function f . The explicit formulas for the specific heat given by Eq. (3.30) will be derived in Sec. VII, however, here we will give the equivalent representation of Eq. (3.30) more convenient for the comparison with future material:

$$\begin{aligned} \Omega_\rho &= \frac{T}{2} \sum_{\omega_n} \int \frac{d^d \mathbf{k} d\mathbf{n}}{(2\pi)^d} \ln \left[1 + f(\mathbf{k}) \hat{\gamma}^\rho \frac{i\omega_n + v_F \mathbf{k} \mathbf{n}}{-i\omega_n + v_F \mathbf{k} \mathbf{n}} \right]; \\ \hat{\gamma}^\rho &= \frac{\frac{1}{2} \hat{\mathbb{F}}^\rho}{\frac{1}{2} + \hat{\mathbb{F}}^\rho} \end{aligned} \quad (3.30')$$

Equation (3.30) has a very simple form and describes the thermodynamic potential of the collective non-interacting charge mode. In the conventional diagrammatic language, Eq. (3.30) corresponds to the contribution of ring diagrams. The advantage of the derivation here is the explicit demonstration that Eq. (3.30) completely solves the problem of the singular corrections

in the charge channel [which is the only one present for the spinless electrons]. No further terms are present for the linearized spectrum and all of the other corrections have additional smallness of the order of T/ϵ_F in comparison with Eq. (3.30). This means that no further consideration of the singlet channel is necessary.

Let us turn to the triplet channel. One can see that due to the presence of the Hubbard-Stratonovich field \mathbf{h} in the operator (3.19), one can solve Eq. (3.18) only approximately. In particular for $|\mathbf{h}| \rightarrow 0$, one finds [cf. Eq. (3.27)]:

$$\mathbf{S}(\omega_n, k; \mathbf{n}) = u \frac{i\omega_n}{i\omega_n - v_F \mathbf{k} \mathbf{n}} \mathbf{h}(\omega_n, k; \mathbf{n}) + \dots \quad (3.31)$$

where ... stand for the functionals of the second and higher orders in field \mathbf{h} , and

$$\mathbf{h}(\omega_n, \mathbf{k}; \mathbf{n}) = \mathbf{h}^*(-\omega_n, -\mathbf{k}; \mathbf{n}). \quad (3.32)$$

Substitution of Eq. (3.31) into Eq. (3.16c) yields

$$\begin{aligned} Z_s &= \exp \left[-\nu T \sum_{\omega_n} \int \frac{d^d \mathbf{k} d\mathbf{n}}{(2\pi)^d} \right. \\ &\quad \left. \times \frac{i\omega_n}{i\omega_n - v_F \mathbf{k} \mathbf{n}} \sum_{j=x,y,z} |h_j(\omega_n, \mathbf{k}; \mathbf{n})|^2 + \dots \right], \end{aligned} \quad (3.33)$$

where ... denote the functional of the third and higher orders in \mathbf{h} . It is important to emphasize that such non-linear terms do not have any additional smallness in T/ϵ_F in contrast to the singlet channel formula (3.29).

If we ignore those non-linear terms we end up with the Gaussian functional integral in Eq. (3.26c) and we obtain analogously to Eq. (3.30):

$$\Omega_s^{(0)} = \frac{3T}{2} \sum_{\omega_n} \int \frac{d^d \mathbf{k} d\mathbf{n}}{(2\pi)^d} \ln \left[1 + f(\mathbf{k}) \hat{\mathbb{F}}^\sigma \frac{v_F \mathbf{k} \mathbf{n}}{-i\omega_n + v_F \mathbf{k} \mathbf{n}} \right]. \quad (3.34)$$

and the action of the interaction function $\hat{\mathbb{F}}^\sigma$ is defined by Eq. (3.25e). The additional factor of 3 in comparison with Eq. (3.30) stands for the three independent components of the spin density. The equivalent representation for Eq. (3.34) is [cf. Eq. (3.30')]

$$\begin{aligned} \Omega_\rho &= \frac{3T}{2} \sum_{\omega_n} \int \frac{d^d \mathbf{k} d\mathbf{n}}{(2\pi)^d} \ln \left[1 + f(\mathbf{k}) \hat{\gamma} \frac{i\omega_n + v_F \mathbf{k} \mathbf{n}}{i\omega_n - v_F \mathbf{k} \mathbf{n}} \right]; \\ \hat{\gamma} &= -\frac{\frac{1}{2} \hat{\mathbb{F}}^\sigma}{\frac{1}{2} + \hat{\mathbb{F}}^\sigma}. \end{aligned} \quad (3.34')$$

Let us mention for the future comparison with previous works, that for the weakly interacting systems, the kernels γ are the linear function of the scattering amplitudes (2.17)

$$\gamma_\rho = \nu V_s; \quad \gamma = -\nu V_t. \quad (3.35)$$

However, due to the presence of the ignored non-small terms in Eq. (3.33), formulas (3.34),(3.34') are by no means exact or correct low temperature asymptotic expression. The next section present an efficient calculational scheme to deal with this non-linearity.

IV. SUPERSYMMETRY APPROACH FOR THE BOSONIC EXCITATIONS.

As we have already explained, the exact derivation of the functional $Z_s \{\mathbf{h}\}$ determining the thermodynamics of the triplet mode Eq. (3.26c) is not possible. Moreover, obtaining the non-linear terms by the further expansion of the solution in powers of \mathbf{h} is not a correct way to proceed because the resulting theory in terms of \mathbf{h} will be not only non-linear but also *non-local* which would obscure such important features of the theory as its renormalizability.

An analogous problem exists in the theory of disordered metals but in many cases it can be overcome using the supersymmetry method^{32,33}. The main idea of the method is to express the solution of a linear equation with a disorder in terms of a functional integral over auxiliary supervectors containing both conventional complex numbers and anticommuting Grassmann variables. Then, one is able to average over the disorder and reduce the disordered system to a regular model without any disorder but with a *local* effective interaction.

We will borrow these ideas. The role of the disorder here will be played by the field \hat{h} itself, so its imaginary time dependence will lead to certain modifications.

We will discuss the number and the properties of the necessary fields in Subsection IV A in somewhat simpler form and will write down the full-fledged effective Lagrangian in Subsection IV B. The final form of the field theory obtained after the averaging over field \mathbf{h} is given in Subsection IV C and it is generalized further in Subsection IV D.

A. The number of auxiliary fields and Hermitization.

Solution of Eq. (3.18) can still be written in a symbolic form as

$$\mathbf{S}(x, \mathbf{n}; u) = -u \hat{L}_u^{-1} \partial_\tau \mathbf{h}(x, \mathbf{n}) \quad (4.1)$$

where the *local* operator \hat{L}_u is given by Eq. (3.19). Substitution of Eq. (4.1) into Eq. (3.16c) yields

$$Z_s = \exp \left[2\nu \int_0^1 u du \int dx d\mathbf{n} \mathbf{h}(x, \mathbf{n}) \hat{L}_u^{-1} \partial_\tau \mathbf{h}(x, \mathbf{n}) \right], \quad (4.2)$$

and we use the notation (2.2) throughout this section.

The argument of the exponent is non-local and our goal is to get rid of such a non-locality. The standard route

to proceed would be to re-write Eq. (4.2) as a functional integral

$$Z_s \{\mathbf{h}\} \stackrel{?}{=} \int DS^\dagger DS D\chi D\chi^\dagger \exp \left[-2\nu \int_0^1 du \int dx d\mathbf{n} \times \left\{ \mathbf{S}^* \hat{L}_u \mathbf{S} + \chi^* \hat{L}_u \chi + u \hat{S} \partial_\tau \mathbf{h} + \hat{S}^* \mathbf{h} \right\} \right]. \quad (4.3)$$

Here

$$\mathbf{S} = \begin{pmatrix} S_x \\ S_y \\ S_z \end{pmatrix}_s; \quad \chi = \begin{pmatrix} \chi_x \\ \chi_y \\ \chi_z \end{pmatrix}_s; \quad (4.4)$$

$$\mathbf{S}^\dagger = (S_x^*, S_y^*, S_z^*)_s; \quad \chi^\dagger = (\chi_x^*, \chi_y^*, \chi_z^*)_s.$$

The spin space s was introduced after Eq. (3.20). The fields \mathbf{S}^*, \mathbf{S} are the usual complex vector fields and χ, χ^* are anticommuting Grassmann fields needed to cancel out the operator determinant. All the fields are functions of x, \mathbf{n}, u and satisfy the periodicity conditions^{vi}.

$$\mathbf{S}(x, \mathbf{n}, u) = \mathbf{S} \left(\mathbf{r}, \tau + \frac{1}{T}, \mathbf{n}, u \right);$$

$$\mathbf{S}^*(x, \mathbf{n}, u) = \mathbf{S}^* \left(\mathbf{r}, \tau + \frac{1}{T}, \mathbf{n}, u \right); \quad (4.5)$$

$$\chi(x, \mathbf{n}, u) = \chi \left(\mathbf{r}, \tau + \frac{1}{T}, \mathbf{n}, u \right);$$

$$\chi^*(x, \mathbf{n}, u) = \chi^* \left(\mathbf{r}, \tau + \frac{1}{T}, \mathbf{n}, u \right).$$

Because the Grassmann fields are periodic rather than anti-periodic we will call them pseudofermions. The argument of the exponent (4.3) would be, then, the local functional linear in \mathbf{h} , so the integration in Eq. (3.26c) could be easily performed yielding the *local* expression in terms of powers of \mathbf{S} and χ only.

However, Eq. (4.3) is rather deceptive. Indeed, the possibility to write such a functional integral is based on the assumption that the integration over the bosonic fields is defined for an arbitrary configuration of the field \mathbf{h} , in particular the directions of such integrations cannot depend on the field \mathbf{h} at all. Therefore, Eq. (4.3) would be correct only if the operator \hat{L}_u of Eq. (3.19) were positive definite which is not the case. Moreover, as we have

^{vi} Note that although the theory is still Gaussian we had to introduce one more coordinate u , such that the fields depend on u for the representation of the needed determinants. The other possible way would be to use representation (3.7)–(3.8) for \mathbf{S} and write WZNW action for matrices \hat{T} , see *e.g.* Ref. 51. We chose not to pursue this line because of the difficulty of the identification of the manifold of the integration over the matrices \hat{T} such that the “saddle point” matrix \hat{T} solving Eq. (3.5b) would belong to the integration manifold.

mentioned after Eq. (3.21), \hat{L}_u is not even Hermitian and we do not have *a priori* the knowledge about the signs of real and imaginary parts of eigenvalues.

Those complications make expression (4.3) mathematically meaningless. Fortunately, the proper procedure for non-hermitian operators containing first-order derivatives has also been worked out previously⁵² and we will use this method for further calculations.

Let us double the number of the bosonic and pseud-fermionic fields as

$$\begin{aligned} \mathbf{S} &= \begin{pmatrix} \mathbf{S}^1 \\ \mathbf{S}^2 \end{pmatrix}_H; \quad \boldsymbol{\chi} = \begin{pmatrix} \boldsymbol{\chi}^1 \\ \boldsymbol{\chi}^2 \end{pmatrix}_H; \\ \mathbf{S}^\dagger &= ([\mathbf{S}^1]^*, [\mathbf{S}^2]^*)_H; \quad \boldsymbol{\chi}^\dagger = ([\boldsymbol{\chi}^1]^*, [\boldsymbol{\chi}^2]^*)_H, \end{aligned} \quad (4.6)$$

where each element has the structure of Eq. (4.4). We will call the additional space of the two-component vectors “hermitized” space and use the subscript $(\dots)_H$ for the writing explicitly the structure in this space. We define the new operator \hat{M}_u acting in this doubled space

$$\hat{M}_u = \frac{1}{2} \begin{pmatrix} \hat{L}_u + \hat{L}_u^\dagger; & \hat{L}_u - \hat{L}_u^\dagger \\ \hat{L}_u^\dagger - \hat{L}_u; & -\hat{L}_u - \hat{L}_u^\dagger \end{pmatrix}_H, \quad (4.7)$$

where each element of this matrix is a matrix in the spin space, see Eq. (3.19). By construction, the operator, Eq. ((4.7)), is Hermitian, $M = M^\dagger$, and thus the functional

$$\int dx \left(\mathbf{S}^\dagger \hat{M}_u \mathbf{S} \right)$$

is real. Therefore, the identity

$$\begin{aligned} 1 &= \int D\mathbf{S}^\dagger D\mathbf{S} D\boldsymbol{\chi} D\boldsymbol{\chi}^\dagger \exp[-\mathcal{S}_h^{\text{eff}}] \\ \mathcal{S}_h^{\text{eff}} &= -2i\nu \int_0^1 du \int dx d\mathbf{n} \\ &\times \left\{ \mathbf{S}^\dagger \left(\hat{M}_u + i\delta \right) \mathbf{S} + \boldsymbol{\chi}^\dagger \left(\hat{M}_u + i\delta \right) \boldsymbol{\chi} \right\}. \end{aligned} \quad (4.8)$$

holds for an arbitrary configuration of the field \mathbf{h} as the integral over the bosonic fields is always convergent. Here δ is a positive real number and the limit $\delta \rightarrow +0$ is to be taken at the end of the calculation. The fields satisfy the periodicity conditions, Eq. ((4.5)). Finally, using Eq. (4.8) and obvious formula

$$\frac{1}{\hat{M}_u} = \frac{1}{2} \begin{pmatrix} \frac{1}{\hat{L}_u} + \frac{1}{\hat{L}_u^\dagger}; & \frac{1}{\hat{L}_u} - \frac{1}{\hat{L}_u^\dagger} \\ \frac{1}{\hat{L}_u^\dagger} - \frac{1}{\hat{L}_u}; & -\frac{1}{\hat{L}_u} - \frac{1}{\hat{L}_u^\dagger} \end{pmatrix}_H,$$

we obtain instead of Eq. (4.3)

$$\begin{aligned} Z_s \{ \mathbf{h} \} &= \int D\bar{\mathbf{S}} D\mathbf{S} D\bar{\boldsymbol{\chi}} D\boldsymbol{\chi} \exp[-\mathcal{S}_0^h] \\ &\exp \left[\nu \sqrt{2i} \int_0^1 du \int dx d\mathbf{n} \right. \\ &\times \left. \left\{ u \left(\hat{\mathbf{S}}^1 + \hat{\mathbf{S}}^2 \right) \partial_\tau \mathbf{h} + \left([\hat{\mathbf{S}}^1]^* - [\hat{\mathbf{S}}^2]^* \right) \mathbf{h} \right\} \right]. \end{aligned} \quad (4.9)$$

Equations (4.8)–(4.9) is the final result of this subsection. We have succeeded in rewriting the original *non-local* expression written in terms of the Hubbard-Stratonovich field \mathbf{h} into the theory local in terms of the new fields $\mathbf{S}, \boldsymbol{\chi}$. As this action is a linear functional in \mathbf{h} , we will be able to integrate it out and obtain the action in terms of those new fields $\mathbf{S}, \boldsymbol{\chi}$ only. Before doing so, we will recast Eqs. (4.8)–(4.9) in a more compact form.

B. Supervectors and the effective Lagrangian.

We introduce the superspace (graded space) as the space of vectors having the same number of complex and Grassmann components³³. In particular, the field introduced in Eq. (4.6) can be compactified as one supervector^{vii}

$$\boldsymbol{\varphi} = \begin{pmatrix} \boldsymbol{\chi} \\ \mathbf{S} \end{pmatrix}_g; \quad \boldsymbol{\varphi}^\dagger = (\boldsymbol{\chi}^\dagger, \mathbf{S}^\dagger)_g \quad (4.10)$$

where subscript g stands for the graded space, and each element has the structure of Eq. (4.6), so the fields are defined in a linear space obtained as a direct product of Hermitized (H) spin (s) and superspace (g). In other words, notation $\boldsymbol{\varphi}$ means the 12-component supervector defined in a linear space $s \otimes H \otimes g$.

Using notation (4.10) the action from Eq. (4.8) can be re-written in a short form

$$\mathcal{S}_h^{\text{eff}} = -2i\nu \int_0^1 du \int dx d\mathbf{n} \left[\boldsymbol{\varphi}^\dagger \left(\hat{M}_u \otimes \mathbb{1}_g + i\delta \right) \boldsymbol{\varphi} \right]. \quad (4.11)$$

where $\mathbb{1}_g$ is the 2×2 unit matrix acting in the superspace.

We will see shortly that the most interesting contribution will come from the scattering terms where the direction of the spin changes its direction to opposite. Anticipating this fact, we will join $\boldsymbol{\varphi}(\mathbf{n})$ and $\boldsymbol{\varphi}(-\mathbf{n})$ in one vector of the larger dimensionality

$$\boldsymbol{\phi}(\mathbf{n}) = \begin{pmatrix} \boldsymbol{\varphi}(\mathbf{n}) \\ \boldsymbol{\varphi}(-\mathbf{n}) \end{pmatrix}_n; \quad \boldsymbol{\phi}^\dagger(\mathbf{n}) = \left(\boldsymbol{\varphi}^\dagger(\mathbf{n}); \boldsymbol{\varphi}^\dagger(-\mathbf{n}) \right)_n, \quad (4.12)$$

^{vii} Using the same notation for the supervector here and for the Hubbard-Stratonovich field in Sec. II should not lead to a confusion as the latter will not appear in any further consideration.

where each element has the structure of Eq. (4.10). and keep integration over \mathbf{n} in all of the subsequent formulas over the d -dimensional hemisphere, say $n_x > 0$. The final answers definitely will not depend on particular choice of the hemisphere. From now on the integration over the momentum direction will mean

$$\int d\mathbf{n} \dots \equiv \int_{n_x > 0} d\mathbf{n} \dots; \quad \int 1 d\mathbf{n} = \frac{1}{2}. \quad (4.13)$$

We will call two-dimensional space defined in Eq. (4.11) the “left-right” space, using the analogy with the one-dimensional systems and will denote it by subscript n .

The final step in the definition of the supervector is once again performed for the calculational convenience, and it is equivalent to the introduction of the Gorkov-Nambu spinors in the theory of the superconductivity⁵³. We increase the size of the supervector as

$$\psi = \frac{1}{\sqrt{2}} \begin{pmatrix} \phi^* \\ \phi \end{pmatrix}_{eh}, \quad \psi^\dagger = \frac{1}{\sqrt{2}} ([\phi^*]^*; \phi^*)_{eh}, \quad (4.14)$$

where each component has the structure of Eq. (4.12). We will call the corresponding space “electron-hole space” and denote it by the subscript eh when written explicitly. The benefit of this doubling of the size of the supervector will become apparent when the perturbation theory for the resulting model is developed in Section V. To avoid misunderstanding, we emphasize that the “electron-hole” introduced here has nothing to do with the electrons and holes in the original system and introduced here to label the fields of the spin excitations only.

Using the standard convention for the complex conjugate of the Grassmann variables,

$$[\chi^*]^* = -\chi, \quad (4.15)$$

and definitions (4.12) – (4.14) we rewrite Eq. (4.11) as

$$\mathcal{S}_{\mathbf{h}}^{\text{eff}} = -2i\nu \int_0^1 du \int dx d\mathbf{n} \left[\psi^\dagger \left(\hat{\mathcal{M}}_u \otimes \mathbb{1}_g + i\delta \right) \psi \right]. \quad (4.16)$$

Here $\hat{\mathcal{M}}_u$ is the matrix in the $H \otimes n \otimes eh$ space and it has the structure

$$\hat{\mathcal{M}}_u = \begin{pmatrix} \hat{\mathbf{M}}_u & 0 \\ 0 & [\hat{\mathbf{M}}_u]^T \end{pmatrix}_{eh}; \quad (4.17)$$

$$\hat{\mathbf{M}}_u(\mathbf{n}) = \begin{pmatrix} \hat{M}_u(\mathbf{n}) & 0 \\ 0 & \hat{M}_u(-\mathbf{n}) \end{pmatrix}_n,$$

with matrix \hat{M}_u given by Eq. (4.7).

To make the notation consistent with the previous work^{32,33,52}, we introduce the conjugated supervector as

$$\bar{\psi} = \psi^\dagger \hat{\Lambda}; \quad \hat{\Lambda} = \mathbb{1}_g \otimes \mathbb{1}_n \otimes \mathbb{1}_s \otimes \mathbb{1}_{eh} \otimes \begin{pmatrix} 1 & 0 \\ 0 & -1 \end{pmatrix}_H. \quad (4.18)$$

Using the explicit structure of the supervectors, Eq. ((4.14)), and the convention (4.15) one can verify that the conjugated supervector $\bar{\psi}$ is related to ψ as

$$\begin{aligned} \bar{\psi} &= (\hat{C}\psi)^T, \\ \hat{C} &= \mathbb{1}_s \otimes \mathbb{1}_n \otimes \begin{pmatrix} \hat{C}_0 & 0 \\ 0 & -\hat{C}_0 \end{pmatrix}_H, \quad C_0 = \begin{pmatrix} \hat{c}_1 & 0 \\ 0 & \hat{c}_2 \end{pmatrix}_g, \\ \hat{c}_1 &= \begin{pmatrix} 0 & -1 \\ 1 & 0 \end{pmatrix}_{eh}, \quad \hat{c}_2 = \begin{pmatrix} 0 & 1 \\ 1 & 0 \end{pmatrix}_{eh}. \end{aligned} \quad (4.19)$$

Accordingly, the conjugation of supermatrices is introduced as

$$\bar{A} = CA^T C^T \quad (4.20)$$

for an arbitrary supermatrix A acting in $s \otimes g \otimes H \otimes n \otimes eh$ space. For the two supervectors $\psi_{1,2}$ of the structure (4.14) one finds

$$(\bar{\psi}_1 A \psi_2) = (\bar{\psi}_2 \bar{A} \psi_1). \quad (4.21)$$

Substituting definition (4.18) into Eq. (4.16) and finding explicit form of $\hat{\mathcal{M}}_u$ from Eqs. (4.17), (4.7) and (3.19)– (3.21), we obtain

$$\mathcal{S}_{\mathbf{h}}^{\text{eff}} = -2i\nu \int \bar{\psi}(X) \hat{\mathcal{L}}_{\mathbf{h}} \psi(X) dX, \quad (4.22)$$

where we use the short hand notation

$$\begin{aligned} X &= (\mathbf{r}, \tau, \mathbf{n}, u); \\ \int dX \dots &= \int d\mathbf{r} \int_0^{1/T} d\tau \int d\mathbf{n} \int_0^1 du \dots \end{aligned} \quad (4.23)$$

and the convention (4.13) for the angular integration.

The Lagrangian in Eq. (4.22) is given by

$$\hat{\mathcal{L}}_{\mathbf{h}} = \hat{\mathcal{L}}_0 - 2i\nu \hat{\tau}_3 \delta \hat{\mathcal{L}}_{\mathbf{h}} - i\delta \hat{\Lambda}, \quad (4.24)$$

where the matrix in the spin space \hat{h} is defined in Eq. (3.20) and the free propagation Lagrangian has the form

$$\begin{aligned} \mathcal{L}_0 &= -iv_F (\mathbf{n} \nabla) \hat{\tau}_3 \hat{\Sigma}_3 - \partial_\tau \hat{\Lambda}_1, \\ \mathcal{L}_0^\dagger &= -iv_F (\mathbf{n} \nabla) \hat{\tau}_3 \hat{\Sigma}_3 + \partial_\tau \hat{\Lambda}_1, \end{aligned} \quad (4.25)$$

The rotation of the spin excitation by the Hubbard-Stratonovich field [cf. Eq. (3.20)] is described by

$$\begin{aligned} \delta \hat{\Lambda}_{\mathbf{h}}(x, \mathbf{n}) &= \begin{pmatrix} 0 & -\hat{\mathbb{H}}_z(x, \mathbf{n}) & \hat{\mathbb{H}}_y(x, \mathbf{n}) \\ \hat{\mathbb{H}}_z(x, \mathbf{n}) & 0 & -\hat{\mathbb{H}}_x(x, \mathbf{n}) \\ -\hat{\mathbb{H}}_y(x, \mathbf{n}) & \hat{\mathbb{H}}_x(x, \mathbf{n}) & 0 \end{pmatrix}_s, \\ \hat{\mathbb{H}}_\gamma(x, \mathbf{n}) &= \mathbb{1}_g \otimes \mathbb{1}_H \otimes \mathbb{1}_{eh} \otimes \begin{pmatrix} h_\gamma(x, \mathbf{n}) & 0 \\ 0 & h_\gamma(x, -\mathbf{n}) \end{pmatrix}_n. \end{aligned} \quad (4.26)$$

The supermatrices in Eqs. (4.25) and (4.26) are introduced as

$$\begin{aligned}\hat{\tau}_3 &= \mathbf{1}_s \otimes \mathbf{1}_g \otimes \mathbf{1}_H \otimes \mathbf{1}_n \otimes \begin{pmatrix} 1 & 0 \\ 0 & -1 \end{pmatrix}_{eh}, \\ \hat{\Sigma}_3 &= \mathbf{1}_s \otimes \mathbf{1}_g \otimes \mathbf{1}_H \otimes \begin{pmatrix} 1 & 0 \\ 0 & -1 \end{pmatrix}_n \otimes \mathbf{1}_{eh}, \\ \hat{\Lambda}_1 &= \mathbf{1}_s \otimes \mathbf{1}_g \otimes \begin{pmatrix} 0 & 1 \\ 1 & 0 \end{pmatrix}_H \otimes \mathbf{1}_n \otimes \mathbf{1}_{eh},\end{aligned}\quad (4.27)$$

The action $\mathcal{S}_h^{\text{eff}}$ is supersymmetric, i.e. invariant with respect to all possible homogeneous rotations in g -space.

To complete the derivation, we have to express the exponent in Eq. (4.9) in terms of the supervector ψ . Those are only terms that break the supersymmetry and thus lead to finite contributions to physical quantities. Using the definitions (4.14), (4.12), (4.6), (4.4), we find

$$\begin{aligned}& \int_0^1 du \int dxd\mathbf{n} \left([\hat{\mathbf{S}}^1]^* - [\hat{\mathbf{S}}^2]^* \right) \mathbf{h} \\ &= 2 \int dX \left(\bar{\psi}_\gamma(X) \mathbf{F}^1(X) \right) \\ F_\gamma^1 &= \frac{1}{\sqrt{2}} \begin{pmatrix} 0 \\ 1 \end{pmatrix}_g \otimes \begin{pmatrix} 1 \\ 1 \end{pmatrix}_H \otimes \begin{pmatrix} 0 \\ 1 \end{pmatrix}_{eh} \otimes \begin{pmatrix} h_\gamma(\mathbf{n}) \\ h_\gamma(-\mathbf{n}) \end{pmatrix}_n,\end{aligned}\quad (4.28a)$$

and, analogously,

$$\begin{aligned}& \int_0^1 du \int dxd\mathbf{n} \left(\hat{\mathbf{S}}^1 + \hat{\mathbf{S}}^2 \right) \mathbf{h} \\ &= 2 \int dX \left(\bar{\psi}_\gamma(X) \mathbf{F}^2(X) \right) \\ F_\gamma^2 &= \frac{1}{\sqrt{2}} \begin{pmatrix} 0 \\ 1 \end{pmatrix}_g \otimes \begin{pmatrix} 1 \\ -1 \end{pmatrix}_H \otimes \begin{pmatrix} 1 \\ 0 \end{pmatrix}_{eh} \otimes \begin{pmatrix} u\partial_\tau h_\gamma(\mathbf{n}) \\ u\partial_\tau h_\gamma(-\mathbf{n}) \end{pmatrix}_n.\end{aligned}\quad (4.28b)$$

where Eq. (4.23) is used, and $\gamma = x, y, z$ labels the components in the spin space.

Equations (4.28) and (4.22) enable us to obtain a representation of formulas (4.8)–(4.9) in supersymmetric notations

$$\begin{aligned}Z_s \{ \mathbf{h} \} &= \int D\psi \exp \left[-\mathcal{S}_h^{\text{eff}} \right] \\ &\times \exp \left[2\nu\sqrt{2i} \int \bar{\psi}(X) \mathbf{F}(X) dX \right],\end{aligned}\quad (4.29)$$

where $\mathcal{S}_h^{\text{eff}}$ is given by Eq. (4.22) and

$$\mathbf{F}(X) = \mathbf{F}^1(X) + \mathbf{F}^2(X).\quad (4.30)$$

The superfields in Eq. (4.29) satisfy the periodic boundary conditions

$$\psi(\tau, \mathbf{r}, \mathbf{n}; u) = \psi(\tau + 1/T, \mathbf{r}, \mathbf{n}; u).\quad (4.31)$$

Equation (4.29) is a main result of this subsection and will be used for the further manipulations.

It is worthwhile to notice that the functional (4.29) has an interesting symmetry. Let us make a shift of the variables

$$\bar{\psi} \rightarrow \bar{\psi} - (1 - \alpha) \frac{u}{\sqrt{2i}} \mathbf{F}_1^T \quad (4.32)$$

in the functional integral (4.29), where α is an arbitrary constant. Using Eqs. (4.28), we find for the transformation

$$\begin{aligned}2\nu\sqrt{2i} \int \bar{\psi}(X) \mathbf{F}(X) dX &\rightarrow 2\nu\sqrt{2i} \int \bar{\psi}(X) \mathbf{F}(X) dX \\ &+ (1 - \alpha)\nu \int dxd\mathbf{n} \left[\mathbf{h}^2(\mathbf{n}) + \mathbf{h}^2(-\mathbf{n}) \right],\end{aligned}\quad (4.33)$$

where the notation (2.2) and the convention (4.13) for the angular integration are used. Analogously using

$$\hat{h}\mathbf{h} = 0$$

that can easily be checked using the definition of \hat{h} , Eq. (3.20), one obtains from Eq. (4.22)

$$\begin{aligned}\int \bar{\psi}(X) \hat{\mathcal{L}}_h \psi(X) dX &\rightarrow \int \bar{\psi}(X) \hat{\mathcal{L}}_h \psi(X) dX \\ &- (1 - \alpha) \frac{2u}{\sqrt{2i}} \int \bar{\psi}(X) \hat{\mathcal{L}}_0 \psi \hat{C} \mathbf{F}^1(X) dX.\end{aligned}\quad (4.34)$$

The extra term appearing in Eq. (4.33) has the same functional form as the interaction (3.25b) and can be incorporated into renormalization of the interaction constant, whereas the extra term in Eq. (4.34) can be accommodated into redefinition of the operator $F^2(X) \rightarrow F^2(X; \alpha)$ in Eq. (4.28b) as

$$\begin{aligned}F_\gamma^2(X; \alpha) &= \frac{1}{\sqrt{2}} \begin{pmatrix} 0 \\ 1 \end{pmatrix}_g \otimes \begin{pmatrix} 1 \\ -1 \end{pmatrix}_H \otimes \begin{pmatrix} 1 \\ 0 \end{pmatrix}_{eh} \\ &\otimes \begin{pmatrix} u[\alpha\partial_\tau + i(1 - \alpha)v_F \mathbf{n} \nabla] h_\gamma(x, \mathbf{n}) \\ u[\alpha\partial_\tau - i(1 - \alpha)v_F \mathbf{n} \nabla] h_\gamma(x, -\mathbf{n}) \end{pmatrix}_n.\end{aligned}\quad (4.35)$$

Accordingly, the low-energy representation of Eq. (3.26c) can be written for an arbitrary parameter α as

$$\exp \left(-\frac{\Omega_s}{T} \right) = \int D\mathbf{h} \mathcal{W}_t(\{ \mathbf{h} \}; \alpha) Z_s(\{ \mathbf{h} \}; \alpha) \quad (4.36)$$

where [cf. Eqs. (3.25b), (3.25c)]

$$\begin{aligned}\mathcal{W}_t(\alpha) &= \exp \left\{ -\frac{\nu}{2} \int \mathbf{h}(x, \mathbf{n}) \left[\hat{\Gamma}_t^{-1}(\alpha) \mathbf{h} \right] (x, n) dxd\mathbf{n} \right\}, \\ 2\hat{\Gamma}_t(\alpha) &= -\hat{f} \frac{\hat{\mathbb{F}}^\sigma}{1 + \alpha \hat{\mathbb{F}}^\sigma},\end{aligned}\quad (4.37)$$

and the angular integration over the whole d -dimensional sphere is meant, and convention (1.2) is implied.

The partition function $Z_s(\alpha)$ is a generalization of Eq. (4.29):

$$\begin{aligned} Z_s \{ \mathbf{h}, \alpha \} &= \int D\psi \exp [-\mathcal{S}_{\mathbf{h}}^{\text{eff}}] \\ &\times \exp \left[2\nu\sqrt{2i} \int \bar{\psi}(X) \mathbf{F}(X; \alpha) dX \right], \quad (4.38) \\ \mathbf{F}(X; \alpha) &= \mathbf{F}^1(X) + \mathbf{F}^2(X; \alpha), \end{aligned}$$

where vectors $\mathbf{F}^1, \mathbf{F}^2(\alpha)$ are given by Eqs. (4.28a) and (4.35), respectively. A particular choice of the parameter α is merely a matter of a convenience.

Closing this subsection, we recast the supersymmetry breaking terms in Eq. (4.38) into a form more convenient for further application. We introduce a 16-component supervector \mathcal{F}_0

$$\begin{aligned} \mathcal{F}_0 &= \frac{1}{\sqrt{2}} \begin{pmatrix} 0 \\ 1 \end{pmatrix}_g \otimes \begin{pmatrix} 1 \\ 1 \end{pmatrix}_n \otimes \begin{pmatrix} \begin{pmatrix} 1 \\ 1 \\ -1 \\ 1 \end{pmatrix}_{eh} \\ H \end{pmatrix}; \\ \bar{\mathcal{F}}_0 &= \frac{1}{\sqrt{2}} (0 \ 1)_g \otimes (1 \ 1)_n \otimes \left((1 \ 1)_{eh} (-1 \ 1)_{eh} \right)_H; \end{aligned} \quad (4.39)$$

and the operator $\hat{l}_{u,\alpha}$ is given by

$$\begin{aligned} \hat{l}_{u,\alpha} &= \frac{u}{2} \left[(2\alpha - 1) \hat{\mathcal{L}}_0 - \hat{\mathcal{L}}_0^\dagger \right] \tau_+ + \tau_-; \\ \hat{l}_{u,\alpha} &= \frac{u}{2} \left[(2\alpha - 1) \hat{\mathcal{L}}_0 - \hat{\mathcal{L}}_0^\dagger \right] \tau_- + \tau_+, \quad (4.40) \\ \hat{\tau}_\pm &= \frac{1 \pm \hat{\tau}_3}{2}, \end{aligned}$$

and $\hat{\mathcal{L}}_0, \hat{\mathcal{L}}_0^\dagger$ are defined in Eq. (4.25). The conjugation for the matrix operator is given by Eq. (4.20), and the supermatrix $\hat{\tau}_3$ is given by Eq. (4.27). Then it is easy to check by explicit calculation that Eqs. (4.38), (4.28a) and (4.35) can be re-written as

$$\begin{aligned} \int \bar{\psi}(X) \mathbf{F}(X; \alpha) dX &= \int \bar{\psi}_\gamma(X) \hat{l}_{u,\alpha} \hat{\mathbb{H}}_\gamma(X) \mathcal{F}_0 dX \\ &= \int \bar{\mathcal{F}}_0 \hat{\mathbb{H}}_\gamma(X) \hat{l}_{u,\alpha} \psi_\gamma(X) dX \end{aligned} \quad (4.41)$$

where operator $\hat{\mathbb{H}}_\gamma$ is given by Eq. (4.26), and summation over the repeated index $\gamma = x, y, z$ is implied^{viii}. The latter formula is the most convenient for the integration over \mathbf{h} which will be performed in the next subsection.

C. Averaging over the Hubbard-Stratonovich field.

The argument of the exponential in Eq. (4.38) is a linear functional of the Hubbard-Stratonovich field \mathbf{h} , and thus the integral over \mathbf{h} in Eq. (4.36) is purely Gaussian. The field \mathbf{h} enters both the function \mathbf{F} and the Lagrangian (4.24). This means that the new effective field theory will contain quadratic, cubic and quartic in ψ terms. The quartic term originates from the averaging of the supersymmetric part of the action, and therefore, it preserves the supersymmetry, whereas the quadratic and cubic terms lift it.

Performing Gaussian integration over \mathbf{h} in Eq. (4.36) with the help of Eqs. (4.41) and (4.26), we find the contribution of the spin modes to the thermodynamic potential

$$\Omega_s = -T \ln \left[\int \exp(-\mathcal{S}[\psi]) D\psi \right] \quad (4.42)$$

with

$$\mathcal{S}[\psi] = \mathcal{S}_0 \{ \psi \} + \mathcal{S}_2 [\{ \psi \}; \alpha] + \mathcal{S}_3 [\{ \psi \}, \alpha] + \mathcal{S}_4 [\{ \psi \}; \alpha]. \quad (4.43)$$

In Eq. (4.43), the free supersymmetric part of the action can be written as

$$\mathcal{S}_0[\psi] = -2i\nu \int \bar{\psi}_\gamma(X) \left[\hat{\mathcal{L}}_0 - i\delta\hat{\Lambda} \right] \psi_\gamma(X) dX \quad (4.44)$$

where $\hat{\mathcal{L}}_0$ is given by Eq. (4.25), the summation is implied over the repeated spin subscripts γ , [see also footnote after Eq. (4.41)], variables X are defined in Eq. (4.23), and the convention (4.13) is used for the angular integration.

The term \mathcal{S}_4 describes the quartic interaction and it takes the form

$$\begin{aligned} \mathcal{S}_4[\{ \psi \}; \alpha] &= -4\nu \varepsilon_{\delta\beta\gamma} \varepsilon_{\delta\beta_1\gamma_1} \sum_{i,j=1}^2 \lambda_{ij} \int dX \\ &\times \left(\bar{\psi}_\beta(X) \hat{\tau}_3 \hat{\Pi}_j \psi_\gamma(X) u \right) \hat{\Gamma}_i \left(u \bar{\psi}_{\beta_1}(X) \hat{\tau}_3 \hat{\Pi}_j \psi_{\gamma_1}(X) \right) \end{aligned} \quad (4.45)$$

where

$$\hat{\lambda} = \begin{pmatrix} 1 & 1 \\ 1 & -1 \end{pmatrix}, \quad (4.46)$$

and we introduced the 16×16 self-conjugated supermatrices [see Eqs. (4.18), (4.27), and footnote after Eq. (4.41)]

$$\hat{\Pi}_1 = 1, \hat{\Pi}_2 = \hat{\Sigma}_3, \hat{\Pi}_3 = \hat{\Lambda}_1 \hat{\tau}_3, \hat{\Pi}_4 = \hat{\Lambda}_1 \hat{\tau}_3 \hat{\Sigma}_3. \quad (4.47)$$

The significance of matrices $\hat{\Pi}_{3,4}$ will become clear in the next subsection.

The operators $\hat{\Gamma}_i$ here are slight modification of $\hat{\Gamma}_i(\alpha)$ in Eqs. (4.37), (3.25c):

$$\hat{\Gamma}_i(\alpha) = \hat{f} \hat{\gamma}_i(\alpha); \quad (4.48a)$$

^{viii} When we write the index in the spin space explicitly, we imply that matrix $\mathbb{1}_s$ should be dropped from definitions (4.27) and the relevant supermatrices have the dimensionality 16×16

where action of the cut-off operator \bar{f} is defined in Eq. (3.25e) and the operators $\hat{\gamma}_i(\alpha)$ are defined by

$$[\hat{\gamma}_i b](X) = \int d\mathbf{n}_1 \int_0^1 du_1 \gamma_i(\widehat{\mathbf{nn}}_1; u, u_1) b(\mathbf{r}, \tau, \mathbf{n}_1, u_1). \quad (4.48b)$$

Hereinafter, the convention (4.13) is used for the angular integration. The kernels in Eq. (4.48b) are given by

$$\begin{aligned} \gamma_1(\widehat{\mathbf{nn}}_1; u, u_1; \alpha) &= -\frac{1}{2} \left\langle \mathbf{n} \left| \frac{\mathbb{F}^\sigma}{\alpha + \mathbb{F}^\sigma} \right| \mathbf{n}_1 \right\rangle \equiv \gamma_f^0; \\ \gamma_2(\widehat{\mathbf{nn}}_1; u, u_1; \alpha) &= -\frac{1}{2} \left\langle -\mathbf{n} \left| \frac{\hat{\mathbb{F}}^\sigma}{\alpha + \hat{\mathbb{F}}^\sigma} \right| \mathbf{n}_1 \right\rangle \equiv \gamma_b^0; \end{aligned} \quad (4.49)$$

and they are independent on the parameters u, u_1 . We will see that this will change when we consider the fluctuation corrections to the bare action (4.45). As we will see later, the most interesting effects will come from $\mathbf{n} \simeq \mathbf{n}_1$ so that the notation $\gamma_{f(b)}$ for the forward (backward) scattering will be self-evident.

The tensor $\varepsilon_{\alpha\beta\gamma}$ is the antisymmetric tensor of the third rank ($\varepsilon_{123} = 1$) and the summation over repeated indices is implied in Eq. (4.45). Also, the relation

$$\varepsilon_{\alpha\beta\gamma} \varepsilon_{\alpha\beta_1\gamma_1} = \delta_{\beta\beta_1} \delta_{\gamma\gamma_1} - \delta_{\beta\gamma_1} \delta_{\beta_1\gamma} \quad (4.50)$$

holds.

The term $\mathcal{S}_3[\{\psi\}, \alpha]$ describes the cubic interaction and we write it as

$$\begin{aligned} \mathcal{S}_3[\{\psi\}, \alpha] &= -4\nu\sqrt{2i\varepsilon_{\delta\beta\gamma}} \sum_{i,j=1}^2 \lambda_{ij} \int dX \\ &\times \left(\bar{\psi}_\beta(X) \hat{\tau}_3 \hat{\Pi}_j \psi_\gamma(X) u \right) \hat{\Gamma}_i \left(\bar{\mathcal{F}}_0 \hat{l}_{u,\alpha} \tau_3 \hat{\Pi}_j \psi_\delta(X) \right), \end{aligned} \quad (4.51)$$

where operator $\hat{l}_{u,\alpha}$ and supervector \mathcal{F}_0 are given by Eqs. (4.40) and (4.39) respectively.

At last, the quadratic term $\mathcal{S}_2[\{\psi\}; \alpha]$ reads

$$\begin{aligned} \mathcal{S}_2[\{\psi\}; \alpha] &= -2i\nu \sum_{i,j=1}^2 \lambda_{ij} \int dX \\ &\times \left(\bar{\mathcal{F}}_0 \hat{l}_{u,\alpha} \tau_3 \hat{\Pi}_j \psi_\delta(X) \right) \hat{\Gamma}_i \left(\bar{\mathcal{F}}_0 \hat{l}_{u,\alpha} \tau_3 \hat{\Pi}_j \psi_\delta(X) \right). \end{aligned} \quad (4.52)$$

Equations (4.42)–(4.52) completely specify the field theory that describes the collective spin excitations. We will see that the interaction between the modes given by the terms $\mathcal{S}_{3,4}$, leads in the limit $T \rightarrow 0$ to logarithmically divergent terms of the perturbation theory in these interactions. These divergencies make the theory non-trivial and interesting. The logarithmic contributions can be summed up using a renormalization group (RG) theory. This will be done in Sec. V. Before doing so, however, we will slightly generalize the action to a form reproducing itself under the renormalization group procedure.

D. Further generalization of the theory.

We start with generalization of the quartic interaction by including all the matrices $\hat{\Pi}_k$, see Eq. (4.47), to the interaction part of the action. We increase the dimensionality of matrix $\hat{\lambda}$ of Eq. (4.46) as

$$\hat{\lambda} = \begin{pmatrix} 1 & 1 & -1 & -1 \\ 1 & 1 & 1 & 1 \\ 1 & -1 & 1 & -1 \\ 1 & -1 & -1 & 1 \end{pmatrix} \quad (4.53)$$

with the properties

$$\sum_{i=1}^4 \lambda_{ik} = 4\delta_{k1}; \quad \sum_{k=1}^4 \lambda_{ik} = 4\delta_{i2}. \quad (4.54)$$

Then, Eq. (4.45) can be re-written as

$$\begin{aligned} \mathcal{S}_4[\{\psi\}; \alpha] &= -2\nu\varepsilon_{\delta\beta\gamma}\varepsilon_{\delta\beta_1\gamma_1} \sum_{i,j=1}^4 \lambda_{ij} \int dX \\ &\times \left(\bar{\psi}_\beta(X) \hat{\tau}_3 \hat{\Pi}_j \psi_\gamma(X) u \right) \hat{\Gamma}_i \left(u \bar{\psi}_{\beta_1}(X) \hat{\tau}_3 \hat{\Pi}_j \psi_{\gamma_1}(X) \right), \end{aligned} \quad (4.55)$$

where the operators $\hat{\Gamma}_i$ are defined by their action on any function $b(X)$ as [cf. Eqs. (4.48)]

$$\begin{aligned} [\hat{\Gamma}_i b](X) &= \int d\mathbf{n}_1 \int_0^1 du_1 \int d\mathbf{r}_1 \bar{f}(\mathbf{r}_1) \\ &\times \Gamma_i(\widehat{\mathbf{nn}}_1; u, u_1; \mathbf{r}_1^\perp) b(\mathbf{r} + \mathbf{r}_1, \tau, \mathbf{n}_1, u_1), \end{aligned} \quad (4.56)$$

where

$$\mathbf{r}_\perp(\mathbf{n}) \equiv \mathbf{r} - \mathbf{n}(\mathbf{r} \cdot \mathbf{n}) \quad (4.57)$$

denotes the coordinate transverse to the direction of the momentum, the cut-off function $\bar{f}(\mathbf{r})$ is defined in Eq. (2.29), and [cf. Eq. (4.49)]

$$\begin{aligned} \Gamma_1(\theta; u, u_1; \mathbf{r}_\perp) &= \Gamma_2(\theta; u, u_1; \mathbf{r}_\perp) = \gamma_f^0(\theta); \\ \Gamma_3(\theta; u, u_1; \mathbf{r}_\perp) &= \Gamma_4(\theta; u, u_1; \mathbf{r}_\perp) = \gamma_b^0(\theta). \end{aligned} \quad (4.58)$$

Analogously, we rewrite Eq. (4.51) as

$$\begin{aligned} \mathcal{S}_3[\{\psi\}, \alpha] &= -2\nu\sqrt{2i\varepsilon_{\beta\gamma\delta}} \sum_{i,j=1}^4 \lambda_{ij} \sum_{\sigma=\pm} \int dX \\ &\times \left(\bar{\psi}_\beta(X) \hat{\tau}_3 \hat{\Pi}_j \psi_\gamma(X) u \right) \hat{\mathcal{B}}_i^\sigma \left(\bar{\mathbb{D}}_\sigma \tau_3 \hat{\Pi}_j \psi_\delta(X) \right), \end{aligned} \quad (4.59)$$

$$\bar{\mathbb{D}}_\pm \equiv \bar{\mathcal{F}}_0 \hat{l}_{u,\alpha} \hat{\tau}_\pm; \quad \mathbb{D}_\pm \equiv \hat{\tau}_\mp \hat{l}_{u,\alpha} \mathcal{F}_0$$

where, similarly to Eq. (4.56)

$$\begin{aligned} [\hat{\mathcal{B}}_i^\sigma b](X) &= \int d\mathbf{n}_1 \int_0^1 du_1 \int d\mathbf{r}_1 \bar{f}(\mathbf{r}_1) \\ &\times \mathcal{B}_i^\sigma(\widehat{\mathbf{nn}}_1; u, u_1; \mathbf{r}_1^\perp) b(\mathbf{r} + \mathbf{r}_1, \tau, \mathbf{n}_1, u_1), \end{aligned} \quad (4.60)$$

operator $\hat{l}_{u,\alpha}$ and matrices $\hat{\tau}_\pm$ are defined in Eq. (4.40), and the bare value of the coupling functions are

$$\mathcal{B}_i^\sigma(\theta; u, u_1; \mathbf{r}_\perp) = \Gamma_i(\theta; u, u_1; \mathbf{r}_\perp). \quad (4.61)$$

Finally, the quadratic term, Eq. (4.52), is recast as

$$\begin{aligned} \mathcal{S}_2[\{\psi\}; \alpha] = & -i\nu \sum_{i,j=1}^4 \lambda_{ij} \sum_{\sigma_{1,2}=\pm} \int dX \\ & \times \left(\overline{\psi}_\delta(X) \hat{\Pi}_j \tau_3 \mathbb{D}_{\sigma_1} \right) \hat{\Delta}_i^{\sigma_1 \sigma_2} \left(\overline{\mathbb{D}}_{\sigma_2} \tau_3 \hat{\Pi}_j \psi_\delta(X) \right), \end{aligned} \quad (4.62)$$

where \mathbb{D}_σ are defined in Eq. (4.59). (The different overall sign in comparison with Eq. (4.52) appears because the matrix $\hat{\tau}_3$ is anticonjugate, $\hat{\tau}_3 = -\hat{\tau}_3$).

Though it appears that four coupling matrices $\hat{\Delta}_i^{\sigma_1 \sigma_2}$, $i = 1, 2, 3, 4$ may be present in Eq. (4.62), only two of them actually give a non vanishing contribution. Indeed, using Eqs. (4.59), (4.39) and (4.47), we find $\hat{\Pi}_3 \hat{\mathbb{D}} \otimes \hat{\mathbb{D}} \hat{\Pi}_3 = \hat{\Pi}_1 \hat{\mathbb{D}} \otimes \hat{\mathbb{D}} \hat{\Pi}_1$, $\hat{\Pi}_2 \hat{\mathbb{D}} \otimes \hat{\mathbb{D}} \hat{\Pi}_2 = \hat{\Pi}_4 \hat{\mathbb{D}} \otimes \hat{\mathbb{D}} \hat{\Pi}_4$, which leads using Eq. (4.53), to

$$\sum_{k=1}^4 \lambda_{ik} \hat{\Pi}_k \hat{\mathbb{D}} \otimes \hat{\mathbb{D}} \hat{\Pi}_k = 0, \quad i = 1, 4. \quad (4.63)$$

The non-vanishing operators $\hat{\Delta}_i^{\sigma_1 \sigma_2}$, $i = 2, 3$, in Eq. (4.62) are defined as [cf. Eqs. (4.56), (4.60)]

$$\begin{aligned} \left[\hat{\Delta}_i^{\sigma_1 \sigma_2} b \right] (X) = & \int d\mathbf{n}_1 \int_0^1 du_1 \int d\mathbf{r}_1 \bar{f}(\mathbf{r}_1) \\ & \times \Delta_i^{\sigma_1 \sigma_2} \left(\widehat{\mathbf{nn}}_1; u, u_1; \mathbf{r}_1^\perp \right) b(\mathbf{r} + \mathbf{r}_1, \tau, \mathbf{n}_1, u_1). \end{aligned} \quad (4.64)$$

Equations (4.62)–(4.64) reproduce Eq. (4.52) for

$$\Delta_i^{\sigma_1 \sigma_2}(\theta; u, u_1; \mathbf{r}_\perp) = \Gamma_i(\theta; u, u_1; \mathbf{r}_\perp), \quad i = 2, 3; \quad (4.65)$$

We will see that the form of the action (4.55), (4.59), (4.62) for $\alpha = 1/2$ will be reproduced by the renormalization group but the relation between constants (4.58), (4.61), (4.65) will be violated, so that Eqs. (4.58), (4.61), (4.65) will serve as initial conditions for the renormalization group flow of Sec. V.

The reason for the introduction of the Π_k matrices (4.47) into the definition of the interaction actions is that they separate the combination of the supervectors which may transform the free Lagrangian $\hat{\mathcal{L}}_0$, Eq. (4.25), into $\hat{\mathcal{L}}_0^\dagger$. We will in the next section that it will be a necessary condition to give rise to the logarithmic divergence.

To understand such partition, note that any supermatrix \hat{P} can be represented as

$$\hat{P} = \sum_{i=1}^4 \hat{P}^{(i)} \quad (4.66)$$

where $\hat{P}^{(i)}$ are supermatrices such as

$$\begin{aligned} \left[\hat{P}^{(1)}, \hat{\Sigma}_3 \right] = 0, \quad \left\{ \hat{P}^{(1)}, \hat{\tau}_3 \hat{\Lambda}_1 \right\} = 0 \\ \left[\hat{P}^{(2)}, \hat{\Sigma}_3 \right] = 0, \quad \left[\hat{P}^{(2)}, \tau_3 \hat{\Lambda}_1 \right] = 0 \\ \left\{ \hat{P}^{(3)}, \hat{\Sigma}_3 \right\} = 0, \quad \left[\hat{P}^{(3)}, \tau_3 \hat{\Lambda}_1 \right] = 0 \\ \left\{ \hat{P}^{(4)}, \hat{\Sigma}_3 \right\} = 0, \quad \left\{ \hat{P}^{(4)}, \tau_3 \hat{\Lambda}_1 \right\} = 0 \end{aligned} \quad (4.67)$$

where $[\dots, \dots]$ stands for the commutator, $\{\dots, \dots\}$ for the anticommutator, and the relevant supermatrices are defined in Eq. (4.27).

It is not difficult to invert Eq. (4.66):

$$\hat{P}^{(i)} = \frac{1}{4} \sum_{k=1}^4 \lambda_{ik} \hat{\Pi}_k \hat{P} \hat{\Pi}_k, \quad (4.68)$$

where the 4×4 matrix $\hat{\lambda}$ is given by Eq. (4.53). Eq. (4.68) can easily be checked by using the property (4.54) and the commutation relations of the matrices Π_k .

One can see that

$$\begin{aligned} \text{Str} \left(\hat{P}^{(i)} \hat{P}^{(j)} \right) = & \delta_{ij} \text{Str} \left(\hat{P}^{(i)} \right)^2, \\ \text{Str} \left(\hat{P} \hat{Q} \right) = & \sum_k \text{Str} \left(\hat{P}^{(k)} \hat{Q}^{(k)} \right) \end{aligned} \quad (4.69)$$

for arbitrary supermatrices \hat{P} and \hat{Q} , where the supertrace operation is defined³³ as

$$\text{Str} \begin{pmatrix} \hat{a} & \hat{\rho} \\ \hat{\sigma} & \hat{b} \end{pmatrix}_g = \text{Tr} \hat{a} - \text{Tr} \hat{b}. \quad (4.70)$$

We note that the following very useful relation

$$\begin{aligned} & \sum_{i_1, i_2, k_1, k_2=1}^4 a_{i_1} b_{i_2} \lambda_{i_1 k_1} \lambda_{i_2 k_2} \text{Str} \left(\hat{A} \hat{\Pi}_{k_1} \hat{\Pi}_{k_2} \hat{B} \hat{\Pi}_{k_1} \hat{\Pi}_{k_2} \right) \\ & = 4 \sum_{i, k=1}^4 a_i b_i \lambda_{ik} \text{Str} \left(\hat{A} \hat{\Pi}_k \hat{B} \hat{\Pi}_k \right) \end{aligned} \quad (4.71)$$

is valid for arbitrary coefficients a_i and b_i . One can prove Eq. (4.71) by a direct calculation using the fact that a product of two matrices (4.47) is once again one of the matrices (4.47). Finally, combining relations (4.68) and (4.71), one finds

$$\text{Str} \left(\hat{P}^{(i)} \hat{Q}^{(j)} \right) = \frac{\delta_{ij}}{4} \sum_{k=1}^4 \lambda_{ik} \text{Str} \left(\hat{P} \hat{\Pi}_k \hat{Q} \hat{\Pi}_k \right) \quad (4.72)$$

V. PERTURBATION THEORY AND RENORMALIZATION GROUP.

This section contains the perturbative analysis of the field theory derived in the previous section. We will start

in Sec. V A with the brief formulation of the rules of the diagrammatic technique¹¹ emphasizing the aspects different from the conventional models. We will show the origin of the logarithmic divergence in Sec. V B and formulate the renormalization group (RG) procedure of summation the leading logarithmic series in Sec. V C. We will be able to derive the RG equation for the coupling constant Eqs. (4.55), (4.59), (4.62). The solution of the RG equation will be done in Sec. VI.

A. Rules of perturbation theory.

As usual, we would like to construct the expansion of the observable quantities in terms of the interaction vertices produced by Eqs. (4.55), (4.59), (4.62) and the Green functions (in our case supermatrices) of the free motion

$$\hat{G}_0(X_1, X_2) = -4i\nu \langle \psi(X_1) \otimes \bar{\psi}(X_2) \rangle_0 \quad (5.1)$$

where variables X are defined in Eq. (4.23), and the averaging means

$$\langle \dots \rangle_0 = \int \dots \exp(-\mathcal{S}_0[\psi]) D\psi, \quad (5.2)$$

the free action is defined in Eq. (4.44), and the normalization is trivial due to the supersymmetry:

$$\int \exp(-\mathcal{S}_0[\psi]) D\psi = 1.$$

The factor $-4i\nu$ is introduced in Eq. (5.2) for the sake of convenience. All the higher order averages are, then, to be found using the Wick theorem and Eq. (5.1).

Using Eqs. (4.44), (4.25), one easily finds

$$\begin{aligned} \hat{G}_0(X_1, X_2) &= \delta(u_1 - u_2) \delta(\mathbf{n}_1; \mathbf{n}_2) \\ &\times T \sum_{\omega_n} \int \frac{d^d k}{(2\pi)^d} e^{-i\omega_n(\tau_1 - \tau_2) + i\mathbf{k}(\mathbf{r}_1 - \mathbf{r}_2)} \hat{G}_0(\omega_n, \mathbf{k}; \mathbf{n}_1); \\ \hat{G}_0(\omega, \mathbf{k}; \mathbf{n}) &= \frac{1}{i\omega \hat{\Lambda}_1 + v_F \mathbf{k} \mathbf{n} \hat{\Sigma}_3 - i\delta \hat{\Lambda}} \\ &= \frac{-i\omega \hat{\Lambda}_1 + v_F \mathbf{k} \mathbf{n} \hat{\Sigma}_3 + i\delta \hat{\Lambda}}{\omega^2 + v_F^2 (\mathbf{k} \mathbf{n})^2 + \delta^2}. \end{aligned} \quad (5.3)$$

From Eq. (5.3) we see that terms involving $\delta \rightarrow 0$ are dangerous only for zero Matsubara frequency contribution. These contributions are associated with the real scattering event with the energy transfer much smaller than temperature. Such processes, though determining the kinetic of the system, are not interesting for equilibrium thermodynamics, and will be considered elsewhere⁵⁷. For the logarithmic contributions considered further in this paper, the real processes are not important and we will put $\delta = 0$ from now on.

Let us discuss peculiar features of the perturbation theory. First of all, due to the supersymmetry of \mathcal{S}_0 , the averages of the operators \hat{A}_1 not perturbing the supersymmetry vanish

$$\langle (\bar{\psi} \hat{A} \psi) \rangle_0 = 0; \quad \langle (\bar{\psi} \hat{A}_1 \psi) (\bar{\psi} \hat{A}_2 \psi) \rangle_0 = 0; \dots \quad (5.4)$$

This leads to the cancellation of the closed loop contributions, see *e.g.* Fig. 6b).

Second feature originates from the dependence of the supervectors ψ , $\bar{\psi}$ on each other, see Eq. (4.19). This mutual dependence makes the rules of the Wick contractions of the supervectors very similar to ones for the real fields (so that the arrow in the Green function loses its meaning). To illustrate this point, consider the connected average ($\hat{Q}_{1,2}$ are the arbitrary self-conjugated supermatrices, $\hat{Q}_{1,2} = \hat{Q}_{1,2}^\dagger$):

$$\langle (\bar{\psi} \hat{Q}_1 \psi) (\bar{\psi} \hat{Q}_2 \psi) \rangle_0 = \overbrace{(\bar{\psi} \hat{Q}_1 \psi) (\bar{\psi} \hat{Q}_2 \psi)} \quad (5.5a)$$

$$+ \underbrace{(\bar{\psi} \hat{Q}_1 \psi) (\bar{\psi} \hat{Q}_2 \psi)}, \quad (5.5b)$$

where over- and underbrackets stand for the Wick contractions. The line (5.5b) can be transformed with the help of Eq. (4.21) as

$$(5.5b) = \overbrace{(\bar{\psi} \hat{Q}_1 \psi) (\bar{\psi} \hat{Q}_2 \psi)},$$

which coincides with the first term in the right-hand-side of Eq. (5.5), because \hat{Q}_1 is self-conjugate. As the result, we obtain

$$\langle (\bar{\psi} \hat{Q}_1 \psi) (\bar{\psi} \hat{Q}_2 \psi) \rangle_0 = -2 \text{Str} \left[\hat{Q}_1 \hat{G}_0 \hat{Q}_2 \hat{G}_0 \right], \quad (5.6)$$

where we omitted the trivial factors of proportionality between the averages and the Green function, Eq. (5.1). The appearance of the factor of 2 in such an average is the feature of the real fields. The minus sign in Eq. (5.6) originates from the definition of the supertrace operation, Eq. (4.70), where the commuting sector is taken with the negative sign.

To further utilize the analogy with the real fields, let us consider a connected average involving eight fields but with only four fields contracted (such an averaging appears *e.g.* as a correction to the interaction constant for the quartic scattering term)

$$\begin{aligned} \mathcal{J}_1 &= \left[\overbrace{(\bar{\psi} \hat{Q}_1 \psi) (\bar{\psi} \hat{Q}_1 \psi)} \right] \left[\overbrace{(\bar{\psi} \hat{Q}_2 \psi) (\bar{\psi} \hat{Q}_2 \psi)} \right]; \\ \mathcal{J}_2 &= \left[\overbrace{(\bar{\psi} \hat{Q}_1 \psi) (\bar{\psi} \hat{Q}_1 \psi)} \right] \left[\overbrace{(\bar{\psi} \hat{Q}_2 \psi) (\bar{\psi} \hat{Q}_2 \psi)} \right]; \end{aligned} \quad (5.7)$$

If ψ were usual fermionic field, contributions \mathcal{J}_1 and \mathcal{J}_2 would be responsible for different processes (particle-hole

and particle-particle, respectively). For the superfields, however, we can transform \mathcal{J}_2 [cf. derivation of Eq. (5.6)] and thus obtain

$$\mathcal{J}_2 = \left[\overline{(\psi \hat{Q}_1 \psi)} \overline{(\psi \hat{Q}_1 \psi)} \right] \left[\overline{(\psi \hat{Q}_2 \psi)} \overline{(\psi \hat{Q}_2 \psi)} \right] = \mathcal{J}_1;$$

i.e. the construction \mathcal{J}_2 describes precisely the same contributions. Analogously one finds

$$\left[\overline{(\psi \hat{Q}_1 \psi)} \overline{(\psi \hat{Q}_1 \psi)} \right] \left[\overline{(\psi \hat{Q}_2 \psi)} \overline{(\psi \hat{Q}_2 \psi)} \right] = \mathcal{J}_1;$$

$$\left[\overline{(\psi \hat{Q}_1 \psi)} \overline{(\psi \hat{Q}_1 \psi)} \right] \left[\overline{(\psi \hat{Q}_2 \psi)} \overline{(\psi \hat{Q}_2 \psi)} \right] = \mathcal{J}_1;$$

so that the permutations of the fields in the vertices do not give rise to any new effects but simply lead to the multiplication by a factor of 4 – number of trivial symmetries of the interaction vertex. That decrease of the number of different contractions is a great simplification in a further derivation.

This observation enable us to formulate the simple diagrammatic rules for the generation of the perturbation expansion, see Fig. 4.

As usual the summation of the non-fixed by the external legs or conservation laws coordinates $\omega_i, \mathbf{k}_i, \mathbf{n}_i, u_i$, must be performed, and the supermatrix product to be calculated. The closed loop of the supersymmetric Green functions bring $-\text{Str}$ of the product of all the terms in the loop, [cf. comment after Eq. (5.6)].

B. Identification of logarithmic divergence.

Having established the basic rules of the diagrammatic technique we are ready to demonstrate the logarithmic singularity in any dimensions.

As usual in the logarithmic series, one has to look at the perturbation theory for the interaction vertices. The lowest order diagram of interest is shown on Fig. 5 and all the remaining terms are enumerated and discussed in Sec. V C.

According to the rules of the diagrammatic technique, Fig. 4, the term of Fig. 5, (let us denote it by \mathcal{J}_5) can schematically be presented as

$$\begin{aligned} \mathcal{J}_5^{ij} &= -\frac{4T}{\nu} \sum_{\omega_n \neq 0} \int \frac{d^d \mathbf{k}}{(2\pi)^d} f(\mathbf{k} - \mathbf{k}_f) f(\mathbf{k} - \mathbf{k}_i) \\ &\times \gamma_i(\widehat{\mathbf{n}_1 \mathbf{n}_2}) \gamma_j(\widehat{\mathbf{n}_1 \mathbf{n}_2}) \\ &\times \text{Str}(\hat{\tau}_3 \hat{Q}_1 \hat{G}_0(\omega_n, \mathbf{k}; \mathbf{n}_1) \hat{\tau}_3 \hat{Q}_2 \hat{G}_0(\omega_n, \mathbf{k}; \mathbf{n}_2)), \end{aligned} \quad (5.8)$$

where the supermatrices $\hat{Q}_{1,2}$ indicate all the combinations of the supermatrices and direct products of the supervectors standing on the left and on the right of the Green functions, see Fig. 5. The only important point is that we will neglect their momentum dependence, which

$$\underline{\omega, k, n, u} = \frac{i}{4\nu} \hat{G}_0(\omega, \mathbf{k}, \mathbf{n})$$

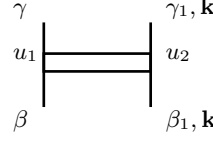

$$= [8] \times 2\nu f(q) \varepsilon_{\delta\beta\gamma} \varepsilon_{\delta\beta_1\gamma_1} \sum_{i,j=1}^4 \lambda_{ij} \hat{\tau}_3 \hat{\Pi}_j \cdot (u_1 \hat{\Gamma}_i u_2) \hat{\tau}_3 \hat{\Pi}_j$$

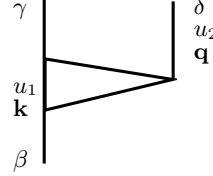

$$= [2] \times 2\nu f(q) \sqrt{2i} \varepsilon_{\beta\gamma\delta} \sum_{i,j=1}^4 \sum_{\sigma=\pm} \lambda_{ij} \hat{\tau}_3 \hat{\Pi}_j \cdot (u_1 \hat{B}_i^\sigma) \mathbb{D}_\sigma \hat{\tau}_3 \hat{\Pi}_j$$

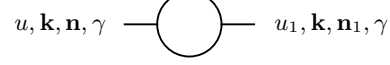

$$= [2] \times i\nu f(k) \sum_{\sigma_{1,2}=\pm} \lambda_{ij} \hat{\Pi}_j \tau_3 \mathbb{D}_{\sigma_1} \hat{\Delta}_i^{\sigma_1 \sigma_2} \mathbb{D}_{\sigma_2} \tau_3 \hat{\Pi}_j$$

FIG. 4: Basic element for the diagrammatic technique, External legs of the vertex are amputated. The expression for the interaction vertices are found from Eqs. (4.55), (4.59), (4.62), and the additional symmetry factors (in brackets) are discussed in text. The lines in the analytic expressions for the diagrams indicate the directions of the insertion of the Green function G_0 . Expressions for \mathbb{D}_\pm are obtained from Eqs. (4.59) and (4.40) with $\mathcal{L}_0 = i\omega \hat{\Lambda}_1 + v_F(\mathbf{k}\mathbf{n}) \hat{\Sigma}_3 \hat{\tau}_3$, $\mathcal{L}_0^\dagger = -i\omega \hat{\Lambda}_1 + v_F(\mathbf{k}\mathbf{n}) \hat{\Sigma}_3 \hat{\tau}_3$. Cut-off function f is defined in Eq. (2.13).

suffices our aim for the logarithmic accuracy. The extra matrix $\hat{\tau}_3$ and the numerical coefficient in front are introduced for the convenience.

Substituting Eq. (5.3) into Eq. (5.8), and keeping only non-vanishing terms, we find

$$\begin{aligned} \mathcal{J}_5^{ij} &= -\frac{4T}{\nu} \sum_{\omega_n \neq 0} \int \frac{d^d \mathbf{k}}{(2\pi)^d} f(\mathbf{k} - \mathbf{k}_f) f(\mathbf{k} - \mathbf{k}_i) \\ &\times \frac{\gamma_i(\widehat{\mathbf{n}_1 \mathbf{n}_2}) \gamma_j(\widehat{\mathbf{n}_1 \mathbf{n}_2})}{\left(\omega_n^2 + v_F^2 (k_1^\parallel)^2\right) \left(\omega_n^2 + v_F^2 (k_2^\parallel)^2\right)} \\ &\times \left(v_F^2 k_1^\parallel k_2^\parallel \text{Str} \hat{Q}_1 \hat{\Sigma}_3 \hat{Q}_2 \hat{\Sigma}_3 - \omega_n^2 \text{Str} \hat{Q}_1 \hat{\tau}_3 \hat{\Lambda}_1 \hat{\tau}_3 \hat{Q}_2 \hat{\Lambda}_1 \right); \\ k_{1,2}^\parallel &\equiv \mathbf{k} \cdot \mathbf{n}_{1,2}. \end{aligned} \quad (5.9)$$

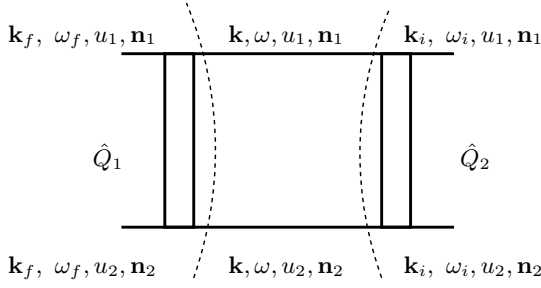

FIG. 5: Lowest order correction to the quartic interaction vertex (external legs are amputated). This contribution logarithmically diverge at $T \rightarrow 0, \mathbf{n}_1 \rightarrow \mathbf{n}_2$, independently on dimensionality. Objects separated by dotted arcs are named $Q_{1,2}$ in Eq. (5.8).

Direct examination of Eq. (5.9) shows that the integral can exhibit logarithmic divergence for $\mathbf{n}_1 \rightarrow \mathbf{n}_2$ only if the two terms in the last factor have the same sign. The last condition is conveniently taken care of by representing each Q matrix in the form of Eq.(4.66), and using the relations (4.67). To facilitate further manipulations, we introduce

$$\begin{aligned} \mathbf{n} &= (\mathbf{n}_1 + \mathbf{n}_2)/2; & \delta\mathbf{n} &= \mathbf{n}_1 - \mathbf{n}_2; \\ k_{\parallel} &= \mathbf{k} \cdot \mathbf{n}; & \mathbf{k}_{\perp} &= \mathbf{k} - k_{\parallel} \mathbf{n}, \end{aligned} \quad (5.10)$$

and consider $|\delta\mathbf{n}| \ll 1$. After integration over k_{\parallel} in Eq. (5.9), one finds [using the decomposition (4.66)]

$$\begin{aligned} \mathcal{J}_5^{ij} &= \gamma_i(|\delta\mathbf{n}|)\gamma_j(|\delta\mathbf{n}|)\text{Str} \left[\hat{Q}_1^{(3)}\hat{Q}_2^{(3)} - \hat{Q}_1^{(1)}\hat{Q}_2^{(1)} \right] \\ &\times \frac{4T}{v v_F} \sum_{\omega_n > 0}^{[v_F/r_0]} \int \frac{d^{d-1}\mathbf{k}_{\perp}}{(2\pi)^{d-1}} \frac{4\omega_n f(\mathbf{k}_{\perp} - \mathbf{k}_f) f(\mathbf{k}_{\perp} - \mathbf{k}_i)}{4\omega_n^2 + v_F^2(\delta\mathbf{n}\mathbf{k}_{\perp})^2}, \end{aligned} \quad (5.11)$$

where the upper limit on the frequency summation appears because we neglected k_{\parallel} dependence of the cut-off function f and the typical momenta contributing to the integral are of the order of ω_n/v_F .

Summation over Matsubara frequency leads immediately to a logarithmic result independently on the dimensionality of the system:

$$\begin{aligned} \mathcal{J}_5^{ij} &= \gamma_i(|\delta\mathbf{n}|)\gamma_j(|\delta\mathbf{n}|)\text{Str} \left[\hat{Q}_1^{(3)}\hat{Q}_2^{(3)} - \hat{Q}_1^{(1)}\hat{Q}_2^{(1)} \right] \\ &\times f^{(2)}(\mathbf{k}_f; \mathbf{k}_i) \ln \left(\frac{v_F}{r_0 \tilde{\epsilon}} \right), \end{aligned} \quad (5.12)$$

where the infrared cut-off of the logarithm is determined by

$$\tilde{\epsilon} = \max \{ T, |\delta n| v_F r_0^{-1} \} \ll \frac{v_F}{r_0}. \quad (5.13)$$

The supertrace in Eq. (5.12) can be re-expressed using Eq. (4.72) as

$$\begin{aligned} &\text{Str} \left[\hat{Q}_1^{(3)}\hat{Q}_2^{(3)} - \hat{Q}_1^{(1)}\hat{Q}_2^{(1)} \right] \\ &= -\frac{1}{4} \sum_{i=1,3} \sum_{k=1}^4 (-1)^{\frac{i-1}{2}} \lambda_{ik} \text{Str} \left[\hat{Q}_1 \hat{\Pi}_k \hat{Q}_2 \hat{\Pi}_k \right]. \end{aligned} \quad (5.14)$$

Although the logarithmic divergence (5.12) is present in any dimension, the coefficient in front of the logarithm in Eq. (5.12) is determined by the dimensionality and the details of the ultraviolet cutoff:

$$f^{(2)}(\mathbf{k}_f; \mathbf{k}_i) = \frac{2}{\pi \nu v_F} \int \frac{d^{d-1}\mathbf{k}_{\perp}}{(2\pi)^{d-1}} f(\mathbf{k}_{\perp} - \mathbf{k}_f) f(\mathbf{k}_{\perp} - \mathbf{k}_i), \quad (5.15)$$

where the cut-off function $f(\mathbf{k})$ is given by Eq. (2.13). For $d = 1$ there is no integration over the transverse momentum, $f(k)$ cuts the logarithmic divergence only, so

$$f_{d=1}^{(2)} = \mu_1 = 2 \quad (5.16a)$$

for $\mathbf{k}_{f,i} \lesssim (1/r_0)$ and decreases rapidly for the larger momenta. For $d = 2, 3$ we notice that logarithmic contributions originate from the region $|k_{\parallel}| \ll |\mathbf{k}_{\perp}| \ll 1/r_0$, and this feature will persist in all the further terms of the perturbation theory. Neglecting the parallel components in Eq. (5.15), we find

$$\begin{aligned} f^{(2)}(\mathbf{k}_f; \mathbf{k}_i) &= \mu_d \int \frac{d^{d-1}\mathbf{r}}{(r_0)^{d-1}} e^{i(\mathbf{k}_i - \mathbf{k}_f)\mathbf{r}} \left[\bar{f}_{\perp} \left(\frac{|\mathbf{r}|}{r_0} \right) \right]^2; \\ \mu_2 &= 4 (p_F r_0)^{-1}; & \mu_3 &= 4\pi (p_F r_0)^{-2}; \\ \bar{f}_{\perp} \left(\frac{|\mathbf{r}|}{r_0} \right) &= r_0^{d-1} \int \frac{d^{d-1}\mathbf{k}_{\perp}}{(2\pi)^{d-1}} e^{i\mathbf{k}_{\perp}\mathbf{r}} f(\mathbf{k}), \end{aligned} \quad (5.16b)$$

where the coordinate integration is in the plane $\mathbf{r} \cdot \mathbf{n} = 0$, The significance of \bar{f}_{\perp} is the regularization of the fields that are otherwise singular functions of the transverse coordinates.

Equation (5.12) demonstrates that the field theory under study is logarithmic in any dimensions. The corrections coming from the interaction diverge in the limit $\{T, |\delta\mathbf{n}|\} \rightarrow 0$. Therefore, we can use a renormalization group scheme for calculation of physical quantities. This can be done in the limit of small Γ considered here.

A remarkable feature of the corrections is that the main contribution comes from configurations with either parallel or antiparallel alignment of the vectors \mathbf{n} . To some extent, the spin degrees of freedom of the electron system have a tendency to forming a one dimensional structure and this happens in all dimensions.

C. Integration over fast variables

This subsection is devoted to summation of the perturbation series in the leading logarithmic approxima-

tion. It means that the expansion for a physical quantity y is classified not in powers of a coupling constant $y = \sum_n a_n \gamma^n$ but as an expansion of the type $y = \sum_n [\gamma \ln(\dots)]^n a_n(\gamma)$. The renormalization group (RG) corresponds to the Taylor series expansion of each function $a_n(\gamma)$, whereas the value of the logarithmic factor itself can be large.

Following the conventional scheme, see e.g., Ref. 58, we subdivide the supervectors ψ into a slow, $\Psi(X)$, and fast, $\Upsilon(X)$, parts

$$\psi(X) = \Psi(X) + \Upsilon(X), \quad (5.17)$$

and integrate over the fast variable $\Upsilon(X)$ using the perturbation theory in the effective interaction.

One should be careful defining the fast and slow variables because, as we saw from Eqs. (5.9)–(5.12), the logarithmic contributions originate from the configuration of the fields highly anisotropic in space (smooth along directions of the momentum \mathbf{n} and sharp in the transverse direction). Therefore, we can not separate the fast and slow variables considering the moduli of the momenta^{ix}.

Fortunately, this problem can be avoided because we can define the fast and slow variables with respect to frequencies only. As the main contribution in the integral over k_{\parallel} , see Eqs. (5.9), (5.11), comes from $k_{\parallel} \sim \omega/v_F$, this type of the separation is sufficient. As concerns the perpendicular components k_{\perp} , they do not participate in the renormalization group treatment entering equations as a parameter (like the other variable u).

After decomposition (5.17) the action acquires the form

$$\mathcal{S}\{\Psi, \Upsilon\} = \mathcal{S}_0\{\Psi\} + \mathcal{S}_0^{\Upsilon}\{\Upsilon\} + \mathcal{S}_2\{\psi\} + \mathcal{S}_{\text{int}}\{\Psi, \Upsilon\}, \quad (5.18)$$

where

$$\mathcal{S}_{\text{int}}\{\Psi, \Upsilon\} = \mathcal{S}_2\{\Upsilon\} + \mathcal{S}_3\{\Psi + \Upsilon\} + \mathcal{S}_4\{\Psi + \Upsilon\}. \quad (5.19)$$

The free action for the fast fields has the form, cf. Eq. (4.44),

$$\mathcal{S}_0^{\Upsilon}\{\Upsilon\} = -2i\nu \int \bar{\Upsilon}_{\gamma} \left[\hat{\mathcal{L}}_0 - i(\varkappa\omega_c) \hat{\Lambda} \right] \Upsilon_{\gamma} dX, \quad (5.20)$$

where $\hat{\mathcal{L}}_0$ is given by Eq. (4.25). The second term in brackets leaves the contribution only from frequencies

$$\varkappa\omega_c \lesssim |\omega|. \quad (5.21)$$

where ω_c is the running cutoff-of the problem, so that $|\omega| \lesssim \omega_c$ and $\varkappa < 1$.

With such a choice, one step of renormalization group transforms the running cut-off as

$$\omega_c \rightarrow \varkappa\omega_c. \quad (5.22)$$

Our goal is to obtain the correction to the action of the slow variables Ψ arising due to the interaction with the fast fluctuations:

$$\delta\mathcal{S}_{\Psi} = -\ln \langle \exp[-\mathcal{S}_{\text{int}}\{\Psi, \Upsilon\}] \rangle_{\Upsilon} - \mathcal{S}_{\text{int}}\{\Psi, 0\}. \quad (5.23)$$

Hereinafter, the averaging over the fast fields Υ is defined as cf. Eq. (5.2)

$$\langle \dots \rangle_{\Upsilon} = \int \dots \exp(-\mathcal{S}_0\{\Upsilon\}) D\Upsilon. \quad (5.24)$$

The integration over the fast field $\{\Upsilon\}$ is performed using the Wick theorem and, thus, all the machinery of V A is still applicable. The only difference is that in the intermediate lines one has to replace $\hat{G}_0 \rightarrow \hat{G}_{\Upsilon}$, where

$$\hat{G}_{\Upsilon}(\omega, \mathbf{k}; \mathbf{n}) = \frac{f_1\left(\frac{|\omega|}{\omega_c}\right)}{i\omega\hat{\Lambda}_1 + v_F\mathbf{k}\mathbf{n}\hat{\tau}_3\hat{\Sigma}_3 - i\hat{\Lambda}\omega_c\varkappa} \quad (5.25)$$

which differs from Eq. (5.25) by the regularization term restricting the domain of the frequency integration from below, $\hat{\Lambda}\omega_c$, and from above $f_1\left(\frac{|\omega|}{\omega_c}\right)$. Smooth function $f_1(x)$ has the asymptotic behavior $f_1(x) \rightarrow 1$, $x \ll 1$ and $f(x \rightarrow \infty) \rightarrow 0$ ^x.

Analogously to the bare action, its correction can be decomposed

$$\delta\mathcal{S}_{\Psi} = \delta\mathcal{S}_4 + \delta\mathcal{S}_3 + \delta\mathcal{S}_2 + \delta\mathcal{S}_0. \quad (5.26)$$

We will consider each of those contributions separately.

1. Renormalization of the quartic term, $\delta\mathcal{S}_4\{\Psi\}$.

The first loop diagrams leading to the renormalization of the quartic interaction are shown in Fig. 6. Only the diagram, Fig. 6a), may produce a logarithm. Indeed, the diagram Fig. 6b) contains a closed loop and vanishes because of supersymmetry, see Eq. (5.4). The diagram 6c) does not produce a logarithm because of the locations of the poles in the corresponding Green functions, as it will be more formally discussed in the end of this subsection.

To obtain the analytic expression for the diagram 6a), we apply the rules of Fig. 4 and notice that the result

^{ix} It should be contrasted to the consideration of Ref. 5 where RG language was merely used to reformulate known^{1,10,11} results. In the RG language, the Fermi liquid constants arise in $d > 1$ as the dimensionally irrelevant couplings and, thus, RG procedure for calculating their values is useless.

^x The particular functional form of the cut-off will be not important in at least first loop renormalization group calculation, though it might be that the more accurate choice will be required for the higher loop calculations [we did not investigate such loops in details].

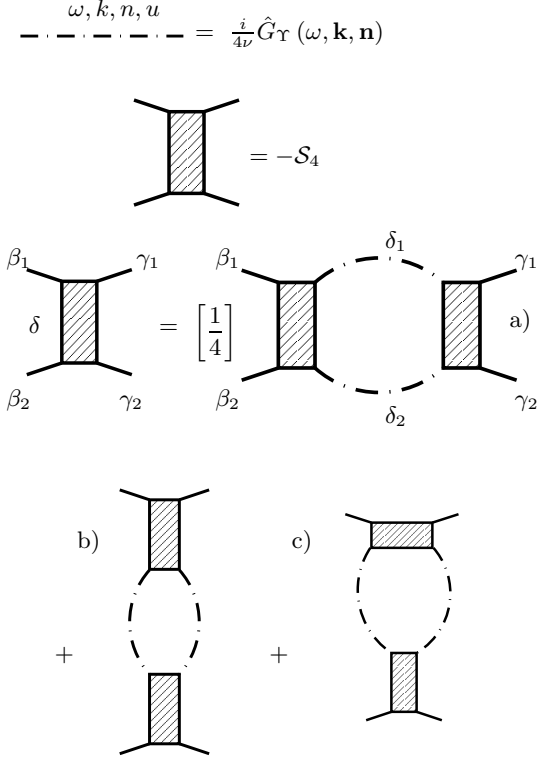

FIG. 6: First loop renormalization of the quartic interaction. The notation is introduced in Fig. 4, and filling means the vertices with renormalized interaction constants γ_i . The Green function for the fast fields, \hat{G}_Υ , is introduced in Eq. (5.25). Factor $[1/4]$ in diagram a) account for the symmetries of the diagram. Diagram (b) vanishes because of the supersymmetry, see Eq. (5.4). Diagram (c) does not produce logarithmic contribution, see Eqs. (5.31) – (5.30).

has the structure of Eq. (5.8), see also Fig. 5, with the replacement of $\hat{G}_0 \rightarrow \hat{G}_\Upsilon$ and

$$\begin{aligned} \left[\hat{Q}_{1,2} \right]_{\delta_1 \delta_2}^i &= \sqrt{\nu} \sum_{k=1}^4 \lambda_{ik} \epsilon_{\alpha\beta_1\delta_1} \epsilon_{\alpha\beta_2\delta_2} \\ &\times u \hat{\Pi}_k \Psi_{\beta_1} \otimes \bar{\Psi}_{\beta_2} \hat{\Pi}_k u \hat{\tau}_3 \end{aligned} \quad (5.27)$$

where the indices in the spin space are written explicitly, and index $i = 1, 2, 3, 4$ labels the coupling constant in Eq. (5.8).

It is easy to see that the appearance of the cut-offs in Eq. (5.25) leads to the replacement of $\ln\left(\frac{v_F}{r_0\epsilon}\right) \rightarrow \ln(1/\varkappa)$ in Eq. (5.12) without affecting the matrix structure of the latter. Using Eq. (5.14) and applying Eq. (4.71) twice,

we find

$$\begin{aligned} \delta\mathcal{S}_4 &= 2\nu \Xi_{\beta_1\gamma_1}^{\beta_2\gamma_2} \sum_{i,j=1}^4 \lambda_{ij} \int dX \left(\bar{\Psi}_{\gamma_1}(X) \hat{\tau}_3 \hat{\Pi}_j \Psi_{\beta_1}(X) u \right) \\ &\times \delta\hat{\Gamma}_i \left(u \bar{\Psi}_{\beta_2}(X) \hat{\tau}_3 \hat{\Pi}_j \Psi_{\gamma_2}(X) \right), \end{aligned} \quad (5.28)$$

where the action of the operator $\delta\hat{\Gamma}_i$ is defined by Eq. (4.56) with the kernels

$$\begin{aligned} \delta\Gamma_2 &= \delta\Gamma_4 = 0; \\ \delta\Gamma_1(\theta; u, u_1; \mathbf{r}_\perp) &= -\mu_d u u_1 \bar{f}_\perp(\mathbf{r}_\perp) \ln \varkappa [\Gamma_1(\dots)]^2; \\ \delta\Gamma_3(\theta; u, u_1; \mathbf{r}_\perp) &= \mu_d u u_1 \bar{f}_\perp(\mathbf{r}_\perp) \ln \varkappa [\Gamma_1(\dots)]^2, \end{aligned} \quad (5.29)$$

where we suppressed the arguments in the right hand side implying that they are the same as in the left hand side. Equation (5.29) is valid for $|\theta| \lesssim \omega_c r_0 / v_F$, otherwise the logarithmic renormalization vanish. The function $\bar{f}_\perp(\mathbf{r}_\perp)$ is defined in Eq. (5.16b).

The tensor $\Xi_{\beta_1\gamma_1}^{\beta_2\gamma_2}$ is given by

$$\begin{aligned} \Xi_{\beta_1\gamma_1}^{\beta_2\gamma_2} &= 2\epsilon_{\alpha_1\beta_1\delta_1} \epsilon_{\alpha_1\beta_2\delta_2} \epsilon_{\alpha_2\beta_1\delta_1} \epsilon_{\alpha_2\beta_2\delta_2} \\ &= 2\delta_{\gamma_1\gamma_2} \delta_{\beta_1\beta_2} + 2\delta_{\gamma_1\beta_1} \delta_{\gamma_2\beta_2} \\ &= \epsilon_{\alpha\beta_1\gamma_1} \epsilon_{\alpha\beta_2\gamma_2} + \delta \Xi_{\beta_1\gamma_1}^{\beta_2\gamma_2}; \\ \delta \Xi_{\beta_1\gamma_1}^{\beta_2\gamma_2} &= 2\delta_{\gamma_1\beta_1} \delta_{\gamma_2\beta_2} + \delta_{\gamma_1\gamma_2} \delta_{\beta_1\beta_2} + \delta_{\gamma_1\beta_2} \delta_{\beta_1\gamma_2}. \end{aligned} \quad (5.30)$$

As matrices (4.47) are self-conjugate and $\hat{\tau}_3$ is anticonjugate, one finds using Eqs. (4.20)– (4.21)

$$\left(\bar{\Psi}_{\beta_1}(X) \hat{\tau}_3 \hat{\Pi}_j \Psi_{\gamma_1}(X) \right) = - \left(\bar{\Psi}_{\gamma_1}(X) \hat{\tau}_3 \hat{\Pi}_j \Psi_{\beta_1}(X) \right),$$

and the contribution proportional to $\delta\Xi$ will vanish after substitution in Eq. (5.31).

Therefore, the resulting action (5.28) is nothing but the original quartic interaction (4.55) with the couplings $\hat{\Gamma}_i$ renormalized according to Eq. (4.65). This is sufficient to write down the renormalization group equation. We will do it in the next section after we consider the transformation of the remaining terms in the action under the RG step.

Closing our consideration of the quartic interaction, let us give a formal proof that the diagram Fig. 6c does not give a logarithmic contribution. Once again, we apply the rules of Fig. 4 and notice that the result has the structure of Eq. (5.8) with [cf. Eq. (5.27)]

$$\begin{aligned} \left[\hat{Q}_2 \right]_{\delta_1 \delta_2}^i &= \sqrt{\nu} u_1 \sum_{k=1}^4 \lambda_{ik} \epsilon_{\alpha\beta_1\delta_1} \epsilon_{\alpha\beta_2\delta_2} \\ &\times \hat{\Pi}_k \Psi_{\beta_1} \otimes \bar{\Psi}_{\beta_2} \hat{\Pi}_k \hat{\tau}_3; \\ \left[\hat{Q}_1 \right]_{\delta_1 \delta_2}^i &= \sqrt{\nu} u_1 \sum_{k=1}^4 \lambda_{ik} \epsilon_{\alpha\beta_1\delta_1} \epsilon_{\alpha\beta_2\delta_2} \\ &\times \hat{\Pi}_k \left(\bar{\Psi}_{\beta_2} \hat{\Pi}_k \hat{\tau}_3 \Psi_{\beta_1} \right), \end{aligned} \quad (5.31)$$

Using Eq. (5.14), we find

$$\begin{aligned}
& \text{Str} \left[\hat{Q}_1^{(3)} \hat{Q}_2^{(3)} - \hat{Q}_1^{(1)} \hat{Q}_2^{(1)} \right] \\
& \propto \sum_{i=1,3} \sum_{k=1}^4 (-1)^{\frac{i-1}{2}} \lambda_{ik} \text{Str} \left[\hat{\Pi}_i \hat{\Pi}_k \hat{Q}_2 \hat{\Pi}_k \right] \\
& = \sum_{i=1,3} \sum_{k=1}^4 (-1)^{\frac{i-1}{2}} \lambda_{ik} \text{Str} \left[\hat{\Pi}_i \hat{Q}_2 \right] = 0,
\end{aligned} \tag{5.32}$$

as the matrices $\hat{\Pi}_k$, see Eq. (4.47), commute with each other, $[\hat{\Pi}_k]^2 = 1$, and second of the properties (4.54) is used.

2. Renormalization of the cubic term, $\delta\mathcal{S}_3\{\Psi\}$.

The first loop diagrams leading to the renormalization of the cubic interaction are shown on Fig. 7. Similarly to what we saw when calculating $\delta\mathcal{S}_4$, only the diagram Fig. 7a) produces a logarithm and we turn to the calculation of this contribution now.

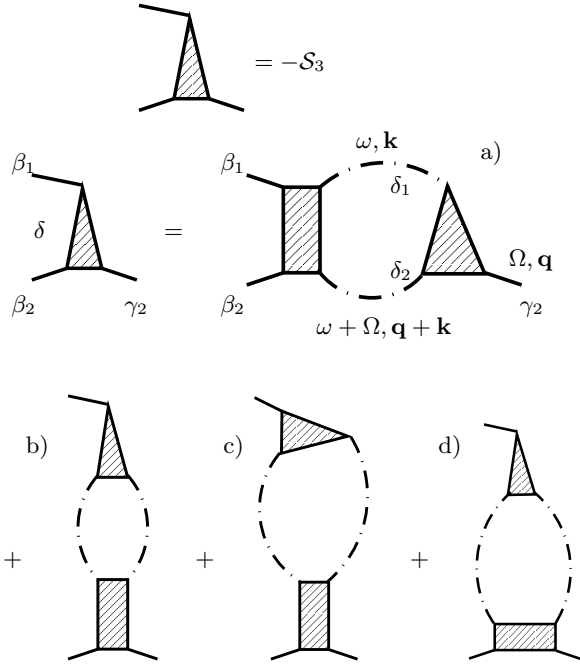

FIG. 7: First loop renormalization of the cubic interaction. The notation is introduced in Figs. 4, 6 and the filling means the vertices with renormalized interaction constants β_i . Diagram (b) vanishes due to the supersymmetry, similarly to Fig. 6b. Diagrams (c) d) do not contain logarithmic contribution, similarly to Fig. 6c.

The only difference in this calculation from the one for

the quartic term is the presence of the differential operator \mathbb{D}_- in the expression for the vertex. Using Eqs. (4.59) and (4.40) we write

$$\begin{aligned}
\mathbb{D}_-(\omega, \mathbf{k}) &= \frac{u}{2} \overline{\mathcal{F}}_0 \left[(2\alpha - 1) \hat{\mathcal{L}}_0(\omega, \mathbf{k}) - \hat{\mathcal{L}}_0^\dagger(\omega, \mathbf{k}) \right] \hat{\tau}_- \\
&= \frac{u}{2} \overline{\mathcal{F}}_0 \left[(2\alpha - 1) \hat{\mathcal{L}}_0(\omega, \mathbf{k}) - \hat{\mathcal{L}}_0^\dagger(\omega + \Omega, \mathbf{q} + \mathbf{k}) \right] \hat{\tau}_- \\
&\quad - \frac{u}{2} \overline{\mathcal{F}}_0 \hat{\mathcal{L}}_0^\dagger(-\Omega, -\mathbf{k}) \hat{\tau}_-.
\end{aligned} \tag{5.33}$$

where frequencies and momenta are arranged as in Fig. 7a).

The terms in the second line cancel the small denominator in one of the Green function. Integration over ω, \mathbf{k} does not produce terms $\propto \ln \varkappa$ because

$$\begin{aligned}
& \int d\omega dk_{\parallel} \hat{A} \hat{\mathcal{L}}_0^\dagger(\omega, k_{\parallel}) \hat{G}_\Upsilon(\omega, k_{\parallel}) \hat{B} \hat{G}_\Upsilon^\dagger(\omega, k_{\parallel}) \\
& \simeq \int d\omega dk_{\parallel} \hat{A} \hat{B} \hat{G}_\Upsilon(\omega, k_{\parallel}) \simeq -i(\kappa\omega_c \ln \kappa) \hat{\Lambda},
\end{aligned} \tag{5.34}$$

i.e, it is determined by the lower limit of the integration and must be excluded from RG scheme.

The term in the last line is not affected by the integration, so the result can be once again recast in the form of Eq. (5.8), and the calculation proceeds similarly as it was done for the quartic term. Instead of Eq. (5.27), we find

$$\begin{aligned}
\left[\hat{Q}_1 \right]_{\delta_1 \delta_2}^{i, \sigma} &= \sqrt{2i\nu} \epsilon_{\delta_1 \gamma_2 \delta_2} \sum_{k=1}^4 \lambda_{ik} \hat{\Pi}_k \Psi_{\gamma_2} \otimes \overline{\mathbb{D}}_\sigma \hat{\Pi}_k \hat{\tau}_3 \\
\left[\hat{Q}_2 \right]_{\delta_1 \delta_2}^i &= \sqrt{\nu} \sum_{k=1}^4 \lambda_{ik} \epsilon_{\alpha \beta_1 \delta_1} \epsilon_{\alpha \beta_2 \delta_2} \\
&\quad \times u \hat{\Pi}_k \Psi_{\beta_1} \otimes \overline{\Psi}_{\beta_2} \hat{\Pi}_k u \hat{\tau}_3,
\end{aligned} \tag{5.35}$$

where we introduced the notation

$$\overline{\mathbb{D}}_\sigma \equiv \overline{\mathbb{D}}_\sigma (\alpha = 1/2). \tag{5.36}$$

Repeating the same steps as when deriving Eq. (5.28) and using the identity

$$(\epsilon_{\alpha \beta_1 \delta_1} \epsilon_{\alpha \delta_2 \beta_2}) \epsilon_{\delta_2 \gamma_2 \delta_1} = \epsilon_{\beta_1 \beta_2 \gamma}, \tag{5.37}$$

we obtain, [cf. Eq. (4.59)]

$$\delta\mathcal{S}_3 = \delta\mathcal{S}_3^+ + \delta\mathcal{S}_3^- \tag{5.38a}$$

$$\begin{aligned}
\delta\mathcal{S}_3^+ &= -2\nu\sqrt{2i}\epsilon_{\beta\gamma\delta} \sum_{i,j=1}^4 \lambda_{ij} \sum_{\sigma=\pm} \int dX \\
&\quad \times \left(\overline{\Psi}_\beta(X) \hat{\tau}_3 \hat{\Pi}_j \Psi_\gamma(X) u \right) \delta\hat{\mathcal{B}}_i^+ \left(\overline{\mathbb{D}}_+ \tau_3 \hat{\Pi}_j \Psi_\delta(X) \right),
\end{aligned} \tag{5.38b}$$

$$\begin{aligned}
\delta\mathcal{S}_3^- &= 4\nu\sqrt{2i}\epsilon_{\beta\gamma\delta} \sum_{i,j=1}^4 \lambda_{ij} \sum_{\sigma=\pm} \int dXu \\
&\quad \times \text{Str} \left[\hat{\Pi}_j \Psi_\gamma(X) \otimes \delta\hat{\mathcal{B}}_i^- \overline{\mathbb{D}}_- \hat{\tau}_3 \right] \left[\hat{\Pi}_j \Psi_\delta(X) \otimes \overline{\Psi}_\beta(X) \hat{\tau}_3 \right],
\end{aligned} \tag{5.38c}$$

where the sign difference between Eqs. (5.38b) and (5.38c) appears because of the definition of the supertrace (4.70).

The action of the operators $\delta\mathcal{B}_i^\pm$ in Eqs. (5.38) are defined by Eq. (4.60) with the kernels given by [cf. Eq. (5.29)]

$$\begin{aligned}\delta\mathcal{B}_2^\pm &= \delta\mathcal{B}_4^\pm = 0; \\ \delta\mathcal{B}_1^+ &= -2\mu_d u u_1 \bar{f}_\perp(\mathbf{r}_\perp) \ln \varkappa \Gamma_1 \mathcal{B}_1^+; \\ \delta\mathcal{B}_1^- &= -\mu_d u u_1 \bar{f}_\perp(\mathbf{r}_\perp) \ln \varkappa \Gamma_1 \mathcal{B}_1^- \\ \delta\mathcal{B}_3^+ &= 2\mu_d u u_1 \bar{f}_\perp(\mathbf{r}_\perp) \ln \varkappa \Gamma_3 \mathcal{B}_3^+; \\ \delta\mathcal{B}_3^- &= \mu_d u u_1 \bar{f}_\perp(\mathbf{r}_\perp) \ln \varkappa \Gamma_3 \mathcal{B}_3^-\end{aligned}\quad (5.39)$$

for $|\theta| \lesssim \omega_c r_0 / v_F$, otherwise the logarithmic renormalizations vanish. We did not write the arguments of the kernels implying that they are the same as in the left-hand side of Eq. (5.29).

Equation (5.38c) is apparently not of the original form (4.59) yet as the differentiation in Eq. (5.38c) acts on two fields on its right whereas the derivative of only one field is present in Eq. (4.59). However, it can be transformed using

$$\varepsilon_{\beta\gamma\delta} \bar{\Psi}_\delta \hat{\tau}_3 \hat{\Pi} \partial_z \Psi_\gamma = \frac{\varepsilon_{\beta\gamma\delta}}{2} \partial_z \left[\bar{\Psi} \hat{\tau}_3 \hat{\Pi}_\delta \partial_z \Psi_\gamma \right]$$

(as matrix $\hat{\tau}_3$ is anticonjugated), and z denote either τ or \mathbf{r} . We, thus, re-write (5.38c) as

$$\begin{aligned}\delta\mathcal{S}_3^- &= 4\nu\sqrt{2i\varepsilon_{\beta\gamma\delta}} \sum_{i,j=1}^4 \lambda_{ij} \sum_{\sigma=\pm} \int dX \\ &\times \left[\left(\bar{\Psi}_\beta(X) \hat{\tau}_3 \hat{\Pi}_j \Psi_\gamma(X) u \right) \delta\hat{\mathcal{B}}_i^- \left(\overline{\mathbb{D}}_- \tau_3 \hat{\Pi}_j \Psi_\delta(X) \right) \right. \\ &\left. + \frac{1}{2} \left(\bar{\Psi}_\beta(X) \hat{\tau}_3 \hat{\Pi}_j \Psi_\gamma(X) u \right) \delta\hat{\mathcal{B}}_i^- \left(\overleftarrow{\mathbb{D}}_- \tau_3 \hat{\Pi}_j \Psi_\delta(X) \right) \right],\end{aligned}\quad (5.40)$$

where the notation $\overleftarrow{\mathbb{D}}$ means that the differential operators included in \mathbb{D} act on the left:

$$c \overleftarrow{\partial}_z d \equiv (\partial_z c) d \quad (5.41)$$

for arbitrary functions c, d . After integration by parts in the last term we obtain

$$\begin{aligned}\delta\mathcal{S}_3^- &= 2\nu\sqrt{2i\varepsilon_{\beta\gamma\delta}} \sum_{i,j=1}^4 \lambda_{ij} \sum_{\sigma=\pm} \int dX \\ &\times \left(\bar{\Psi}_\beta(X) \hat{\tau}_3 \hat{\Pi}_j \Psi_\gamma(X) u \right) \delta\hat{\mathcal{B}}_i^- \left(\overline{\mathbb{D}}_- \tau_3 \hat{\Pi}_j \Psi_\delta(X) \right)\end{aligned}\quad (5.42)$$

that has the same form as Eq. (4.59) for the particular choice of the parameter α

$$\alpha = \frac{1}{2}. \quad (5.43)$$

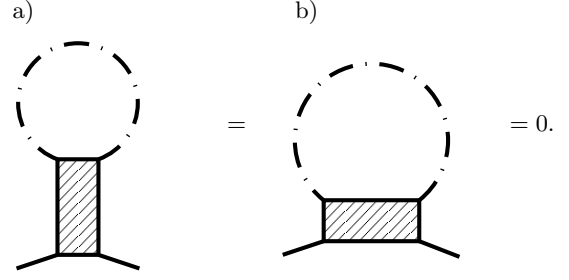

FIG. 8: First order corrections to the quadratic term. Diagram a) vanishes due to the supersymmetry. Diagram b) vanishes after ω, \mathbf{k} integration, see Eq. (5.34).

In what follows we will use only this value of α .^{xi}

Equations (5.38), (5.42) shows that the cubic term is reproduced under the RG step and Eq. (5.39) determines the new values of the coupling constants.

3. Renormalization of the quadratic interaction, $\delta\mathcal{S}_2\{\Psi\}$ and free action $\delta\mathcal{S}_0\{\Psi\}$.

The one loop diagrams that may change the values of $\delta\mathcal{S}_{0,2}\{\Psi\}$ are shown on Figs. 8–10.

One immediately notices that all the diagrams of the first order in quartic interactions, Fig. 8, vanish. Indeed, diagram of Fig. 8a) vanishes because of the supersymmetry. Diagram of Fig. 8b) vanishes because it involves integration of one Green function only and cannot produce a logarithmic divergence, see Eq. (5.34).

Among the diagrams of the second order, Figs. 9,10, only Fig. 9 a,b) gives the logarithmic contribution into the quadratic interaction. We transform contributions involving $\overline{\mathbb{D}}_-(\omega, \mathbf{k})$, $\mathbb{D}_-(\omega, \mathbf{k})$ on diagrams Fig. 9a according to Eq. (5.33), for $\alpha = 1/2$. Then, the contributions from the last line of Eq. (5.33) are not affected by the integration, so the result can be once again recast in the form of Eq. (5.8) with [cf. Eqs. (5.35), (5.27)]

$$\left[\hat{Q}_{1,2} \right]_{\delta_1 \delta_2}^{i, \sigma} = \frac{1}{2} \sqrt{i\nu} \varepsilon_{\delta_1 \gamma_2 \delta_2} \sum_{k=1}^4 \lambda_{ik} \hat{\Pi}_k \Psi_{\gamma_2} \otimes \overline{\mathbb{D}}_\sigma \hat{\Pi}_k \hat{\tau}_3 u. \quad (5.44)$$

The first line of Eq. (5.33) for the quadratic interaction does not produce any logarithmic divergence for terms involving either $\overline{\mathbb{D}}_+(\omega, \mathbf{k}) \dots \mathbb{D}_-(\omega, \mathbf{k})$ or $\overline{\mathbb{D}}_+(\omega, \mathbf{k}) \dots \mathbb{D}_-(\omega, \mathbf{k})$ due to the integral Eq. (5.34). The term involving $\overline{\mathbb{D}}_-(\omega + \Omega, \mathbf{k} + \mathbf{q}) \dots \mathbb{D}_-(\omega, \mathbf{k})$ have all the denominators cancelled and the integral is ultraviolet divergent. This ultraviolet divergence will be discussed

^{xi} Other choices of α would require additional shifts of the fields in order to reproduce the cubic term in the RG. Therefore, the choice (5.43) is the most convenient for the sake of the calculation though the final physical answers can not depend on α at all

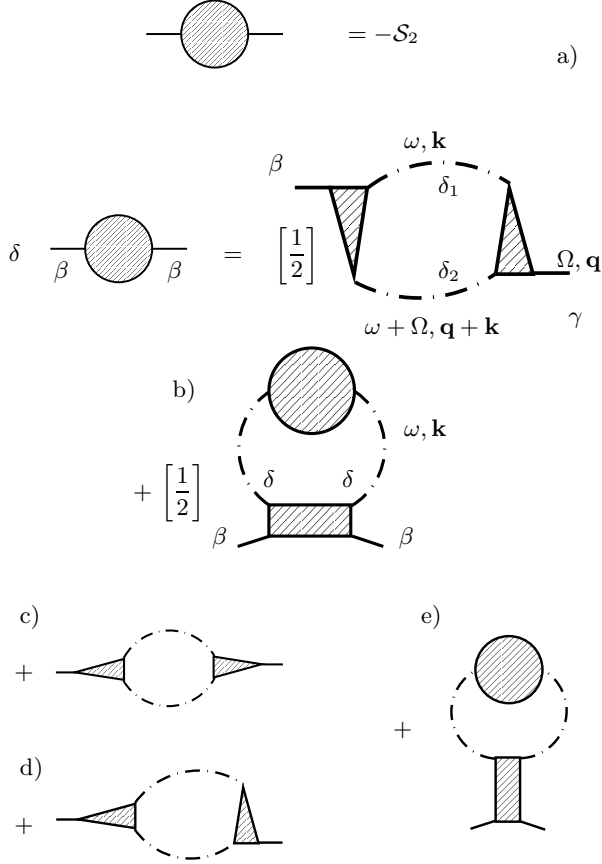

FIG. 9: First loop corrections to the quadratic term S_2 . The notation is introduced in Figs. 4, 6 and the filling means the vertices with renormalized interaction constants $\Delta_i^{\sigma_1\sigma_2}$. Diagrams a,b) are logarithmic. Diagram c) vanishes due to the supersymmetry, similarly to Figs. 6b, 7b. Diagrams d) e) do not contain the logarithmic contribution, similarly to Figs. 6c, 7c,d. The factor $[1/2]$ on the panels a,b) appears because of the symmetry of the diagrams,

later on in this subsection after we complete the derivation of the logarithmic terms.

In the diagram Fig. 9b only the terms involving $\overline{\mathbb{D}}_+(\omega, \mathbf{k}) \dots \mathbb{D}_+(\omega, \mathbf{k})$ are logarithmic. Diagrams involving $\overline{\mathbb{D}}_+(\omega, \mathbf{k}) \dots \mathbb{D}_-(\omega, \mathbf{k})$ and $\overline{\mathbb{D}}_-(\omega, \mathbf{k}) \dots \mathbb{D}_+(\omega, \mathbf{k})$ are of the type of Eq. (5.34) and do not contribute to the logarithmic renormalization group. Finally, the term $\overline{\mathbb{D}}_-(\omega, \mathbf{k}) \dots \mathbb{D}_-(\omega, \mathbf{k})$ gives rise to the ultraviolet divergence which will be discussed shortly, see Eq. (5.51). The

logarithmic part of Fig. 9b is of the form (5.8) with

$$\begin{aligned} [\hat{Q}_1]_{\delta_1\delta_2}^i &= \frac{1}{2}\sqrt{\nu} \sum_{k=1}^4 \lambda_{ik} \epsilon_{\alpha\beta_1\delta_1} \epsilon_{\alpha\beta_2\delta_2} \\ &\quad \times u \hat{\Pi}_k \Psi_{\beta_1} \otimes \overline{\Psi}_{\beta_2} \hat{\Pi}_k u \hat{\tau}_3 \\ [\hat{Q}_2]_{\delta_1\delta_2}^i &= \frac{1}{2}\sqrt{\nu} i \epsilon_{\delta_1\gamma_2\delta_2} \sum_{k=1}^4 \lambda_{ik} \hat{\Pi}_k \mathbb{D}_+ \otimes \overline{\mathbb{D}}_+ \hat{\Pi}_k \hat{\tau}_3. \end{aligned} \quad (5.45)$$

Collecting all the logarithmic contributions from Fig. 9a,b) with the help of Eqs. (5.8), (5.44), (5.45) and the identity

$$\epsilon_{\alpha\beta_1\gamma} \epsilon_{\alpha\beta_2\gamma} = 2\delta_{\beta_1\beta_2}, \quad (5.46)$$

we obtain [cf. Eq. (4.62)]

$$\begin{aligned} \delta S_2[\{\psi\}; \alpha] &= -i\nu \sum_{i,j=1}^4 \lambda_{ij} \sum_{\sigma_{1,2}=\pm} \int dX \\ &\quad \times \left(\overline{\psi}_\delta(X) \hat{\Pi}_j \tau_3 \mathbb{D}_{\sigma_1} \right) \delta \hat{\Delta}_i^{\sigma_1\sigma_2} \left(\overline{\mathbb{D}}_{\sigma_2} \tau_3 \hat{\Pi}_j \psi_\delta(X) \right). \end{aligned} \quad (5.47)$$

The action of the operators $\delta \hat{\Delta}_i^{\pm\pm}$ for $i = 2, 3$ are given by Eq. (4.64) with the kernels [cf. Eqs. (5.29), (5.39)]

$$\begin{aligned} \delta \Delta_2^{\sigma_1\sigma_2} &= 0; \\ \delta \Delta_3^{++} &= 2\mu_d u u_1 \bar{f}_\perp(\mathbf{r}_\perp) \ln \varkappa \left[\Gamma_3 \Delta_3^{++} + (\mathcal{B}_3^+)^2 \right]; \\ \delta \Delta_3^{+-} &= \delta \Delta_3^{-+} = 2\mu_d u u_1 \bar{f}_\perp(\mathbf{r}_\perp) \ln \varkappa \mathcal{B}_3^- \mathcal{B}_3^+. \end{aligned} \quad (5.48)$$

and

$$\delta \Delta_3^{- -} \stackrel{?}{=} 2\mu_d u u_1 \bar{f}_\perp(\mathbf{r}_\perp) \ln \varkappa (\mathcal{B}_3^-)^2. \quad (5.49)$$

Equation (5.48) is valid for $|\theta| \lesssim \omega_c r_0 / v_F$, otherwise, the logarithmic renormalizations vanish. Once again, we did not write the arguments of the kernels implying that they are the same as those in the left-hand side of Eq. (5.29). The reason why the correction $\delta \Delta_3^{- -}$ is written separately from all the other couplings will be explained momentarily.

To complete the calculation of the correction to the quadratic interaction, we have to compute actually the ultraviolet divergent terms in 9a-b. We found

$$[\text{Fig. 9a} + \text{Fig. 9b}]_{uv} \simeq \sum_{i=2,3} \mathcal{O}(\omega_c^2) \left\{ [\beta_i^-]^2 - \gamma_i \Delta_i^{- -} \right\}. \quad (5.50)$$

The ultraviolet divergences cancel each other for the initial couplings (4.61), (4.65). In fact, the vanishing of such divergences precludes the formation of the gap in the spectrum of the excitations forbidden by the spin rotational symmetry, and should be valid in any order of the perturbation theory. On the other hand, the accuracy of our renormalization group procedure does not allow us

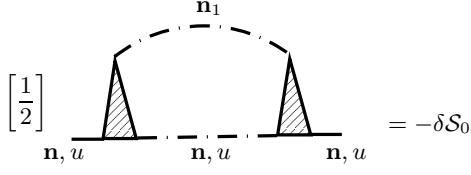

FIG. 10: First loop correction to the free action, \mathcal{S}_0 . This correction is logarithmic only for $d = 1$. For $d > 1$, the logarithmic divergence vanish due to the integration over $\widehat{\mathbf{m}\mathbf{n}_1}$.

to the determine finite logarithmic terms from the uncertainty “ $\infty - \infty$ ”. This makes the correction (5.49) meaningless. Fortunately, we can use the symmetry of the system forbidding the formation of such ultraviolet divergences to fix this coupling constant. Requiring the most divergent part of the ultraviolet divergence to cancel at any stage of the RG procedure, we find

$$\Gamma_3 \Delta_3^{--} = (\mathcal{B}_3^-)^2 \quad (5.51)$$

and use this equation for the further RG flow.

The last interesting diagram is shown in Fig. 10. As it conserves both the momentum direction \mathbf{n} and the value of the coordinates ω, \mathbf{k}, u , it is natural to classify it as the correction to the free action, $\delta\mathcal{S}_0$. The pole structure of the Green functions allows for the logarithmic divergence at $\mathbf{n}_1 \rightarrow \mathbf{n}$. Calculation is performed using the formula

$$\begin{aligned} \mathbb{K}_k^{\sigma_1\sigma_2} &\equiv \left(\overline{\mathbb{D}}_{\sigma_1}(\omega, \mathbf{k}, \mathbf{n}; u) \hat{\Pi}_k \hat{\mathcal{G}}_0(\omega, \mathbf{k}, \mathbf{n}) \mathbb{D}_{\sigma_2}(\omega, \mathbf{k}, \mathbf{n}; u) \right); \\ \mathbb{K}_3^{\sigma_1\sigma_2} &= -\mathbb{K}_1^{\sigma_1\sigma_2}; \quad \mathbb{K}_4^{\sigma_1\sigma_2} = -\mathbb{K}_2^{\sigma_1\sigma_2}; \\ \mathbb{K}_k^{++} &= \mathbb{K}^{--} = 0; \\ \mathbb{K}_1^{+-}(\omega, \mathbf{k}, \mathbf{n}; u) &= \mathbb{K}_1^{-+}(\omega, \mathbf{k}, \mathbf{n}; u) = u \frac{\omega^2 - v_F^2(\mathbf{n} \cdot \mathbf{k})^2}{\omega^2 + v_F^2(\mathbf{n} \cdot \mathbf{k})^2}; \\ \mathbb{K}_2^{+-}(\omega, \mathbf{k}, \mathbf{n}; u) &= \mathbb{K}_2^{-+}(\omega, \mathbf{k}, \mathbf{n}; u) = u \frac{2iv_F\omega(\mathbf{n} \cdot \mathbf{k})}{\omega^2 + v_F^2(\mathbf{n} \cdot \mathbf{k})^2}, \end{aligned} \quad (5.52)$$

that can be checked directly using definitions (5.3) and (4.59) for $\alpha = 1/2$. However, for $d = 2, 3$ integration over \mathbf{n}_1 cancels out this logarithmic divergence. For $d = 1$, one finds

$$\begin{aligned} \delta\mathcal{S}_0 &\simeq i\nu \ln \varkappa \int \overline{\Psi}_\gamma(X) \left[\hat{\mathcal{L}}_0 \hat{R} \right] \Psi_\gamma(X) dX, \\ \hat{R} &\simeq \mathcal{B}_1^+ \mathcal{B}_1^- \left(1 - \hat{\Pi}_3 \right) + \mathcal{B}_3^+ \mathcal{B}_3^- \left(1 + \hat{\Pi}_3 \right). \end{aligned}$$

This correction can be eliminated by the rescaling of the fields $\Psi \rightarrow [1 - (\ln \varkappa) \hat{R}] \Psi$. This rescaling will give the third order correction to the coupling constants in the interaction part of the action, and thus has to be taken into account only in the two loop RG equation. As we do not consider such loop in the present paper, we will have to disregard $\delta\mathcal{S}_0$ even for $d = 1$.

Equations (5.28), (4.65), (5.38) – (5.42), (5.47)–(5.48) are the main results of this section. They show that the functional form of the interaction part of the action is

reproduced after integration over the fast variables and, moreover, describe the changes of the of the coupling constants in Eqs. (4.55), (4.59), (4.62), under the renormalization. This will enable us to write proper renormalization group equations in a standard way. These equations and their solutions are presented in the next Section.

VI. RENORMALIZATION GROUP EQUATIONS AND THEIR SOLUTION.

A. General structure of RG equations.

We have demonstrated in the previous section that the functional form of the interaction part of the action (4.55), (4.59), (4.62), is reproduced after integration over the fast variables, Υ . On the other hand, each integration over the fast variables corresponds to the transform (5.22) of the high-energy cut-off

$$\ln \omega_c \rightarrow \ln \varkappa + \ln \omega_c. \quad (6.1)$$

This enables us to write a most general form of the RG equations as

$$\begin{aligned} \frac{d\hat{\Gamma}_i}{d \ln \omega_c} &= \hat{\mathfrak{B}}_{\Gamma_i} \left(\hat{\Gamma}_j; \hat{\mathcal{B}}_j; \hat{\Delta}_j \right); \\ \frac{d\hat{\mathcal{B}}_i}{d \ln \omega_c} &= \hat{\mathfrak{B}}_{\mathcal{B}_i} \left(\hat{\Gamma}_j; \hat{\mathcal{B}}_j; \hat{\Delta}_j \right); \\ \frac{d\hat{\Delta}_i}{d \ln \omega_c} &= \hat{\mathfrak{B}}_{\Delta_i} \left(\hat{\Gamma}_j; \hat{\mathcal{B}}_j; \hat{\Delta}_j \right). \end{aligned} \quad (6.2)$$

The renormalization group flow starts from $\omega_c \simeq v_F/r_0$ with the initial conditions (4.58), (4.61), (4.65) and it should stop at $\omega_c \simeq \max(T, |\theta|v_F/r_0)$. One sees immediately a significant difference between the standard RG scheme and the problem in hand. In our case, the entire coupling operators may be renormalized, its renormalization is a functional of all the other operators, etc. Thus, we are dealing with the *functional renormalization group*.

Surprisingly, in the one loop approximation, the functional RG equations can be obtained explicitly and solved in a closed form.

B. One loop RG equations.

The one loop equations for the kernels Γ_i , \mathcal{B}_i , Δ_i in Eqs. (4.56), (4.60), (4.64) are obtained by dividing both sides of Eqs. (5.29), (5.39), (5.48), and (5.51) by $\ln \varkappa$ and taking the limit $\ln \varkappa = d \ln \omega_c \rightarrow 0$. As the result, we find

$$\begin{aligned}
\frac{d\Gamma_1(\theta; u, u_1; \mathbf{r}_\perp)}{d \ln \omega_c} &= -\mu_d u u_1 \bar{f}_\perp(\mathbf{r}_\perp) [\Gamma_1(\theta; u, u_1; \mathbf{r}_\perp)]^2; \\
\frac{d\mathcal{B}_1^+(\dots)}{d \ln \omega_c} &= -2\mu_d u u_1 \bar{f}_\perp(\mathbf{r}_\perp) \Gamma_1(\dots) \mathcal{B}_1^+(\dots); \\
\frac{d\mathcal{B}_1^-(\dots)}{d \ln \omega_c} &= -\mu_d u u_1 \bar{f}_\perp(\mathbf{r}_\perp) \Gamma_1(\dots) \mathcal{B}_1^-(\dots); \\
\frac{d\Gamma_4}{d \ln \omega_c} &= \frac{d\mathcal{B}_4^\sigma}{d \ln \omega_c} = 0.
\end{aligned} \tag{6.3a}$$

for the set of couplings not having counterpart in the quadratic part of the action. Here (...) is the short hand notation for the omitted arguments $(\theta; u, u_1; \mathbf{r}_\perp)$.

For the couplings affecting the quadratic part of the action, we find

$$\begin{aligned}
\frac{d\Gamma_3(\theta; u, u_1; \mathbf{r}_\perp)}{d \ln \omega_c} &= \mu_d u u_1 \bar{f}_\perp(\mathbf{r}_\perp) [\Gamma_3(\theta; u, u_1; \mathbf{r}_\perp)]^2; \\
\frac{d\mathcal{B}_3^+(\dots)}{d \ln \omega_c} &= 2\mu_d u u_1 \bar{f}_\perp(\mathbf{r}_\perp) \Gamma_3(\dots) \mathcal{B}_3^+(\dots); \\
\frac{d\mathcal{B}_3^-(\dots)}{d \ln \omega_c} &= \mu_d u u_1 \bar{f}_\perp(\mathbf{r}_\perp) \Gamma_3(\dots) \mathcal{B}_3^-(\dots); \\
\frac{d\Delta_3^{++}(\dots)}{d \ln \omega_c} &= 2\mu_d u u_1 \bar{f}_\perp(\mathbf{r}_\perp) \\
&\quad \times \left\{ \Gamma_3(\dots) \Delta_3^{++}(\dots) + [\mathcal{B}_3^+(\dots)]^2 \right\}; \\
\frac{d\Delta_3^{-+}(\dots)}{d \ln \omega_c} &= \frac{d\Delta_3^{+-}(\dots)}{d \ln \omega_c} \\
&= 2\mu_d u u_1 \bar{f}_\perp(\mathbf{r}_\perp) \mathcal{B}_3^+(\dots) \mathcal{B}_3^-(\dots); \\
\Gamma_3(\dots) \Delta_3^{--}(\dots) &= [\mathcal{B}_3^-(\dots)]^2; \\
\frac{d\Gamma_2}{d \ln \omega_c} &= \frac{d\beta_2^\sigma}{d \ln \omega_c} = \frac{d\Delta_2^{\sigma_1\sigma_2}}{d \ln \omega_c} = 0.
\end{aligned} \tag{6.3b}$$

The form of Eqs. (6.3) suggests immediately the following scaling form for the coupling kernels

$$\begin{aligned}
\Gamma_i(\theta; u, u_1; \mathbf{r}_\perp) &= \gamma_i \left[\xi(\theta; u, u_1; \mathbf{r}_\perp); \gamma_i^0(\theta) \right] \\
\mathcal{B}_i^\sigma(\theta; u, u_1; \mathbf{r}_\perp) &= \beta_i^\sigma \left[\xi(\theta; u, u_1; \mathbf{r}_\perp); \gamma_i^0(\theta) \right] \\
\Delta_i^{\sigma_1\sigma_2}(\theta; u, u_1; \mathbf{r}_\perp) &= \Delta_i^{\sigma_1\sigma_2} \left[\xi(\theta; u, u_1; \mathbf{r}_\perp); \gamma_i^0(\theta) \right] \\
\xi(\theta; u, u_1; \mathbf{r}_\perp) &= u u_1 \mu_d \bar{f}_\perp(\mathbf{r}_\perp) \ln \left[\min \left(\frac{1}{\theta}, \frac{v_F}{r_0 T} \right) \right]
\end{aligned} \tag{6.4}$$

where $\gamma_1^0 = \gamma_2^0 = \gamma_f$, $\gamma_3^0 = \gamma_4^0 = \gamma_b$, see Eqs. (4.49),

(4.58). Comparing Eq. (6.4) with Eqs. (6.3), we obtain

$$\begin{aligned}
\frac{d\gamma_1(\xi)}{d\xi} &= [\gamma_1(\xi)]^2; \\
\frac{d\beta_1^+(\xi)}{d\xi} &= 2\gamma_1(\xi) \beta_1^+(\xi); \\
\frac{d\beta_1^-(\xi)}{d\xi} &= \gamma_1(\xi) \beta_1^-(\xi); \\
\frac{d\gamma_4}{d\xi} &= \frac{d\beta_4^\sigma}{d\xi} = 0,
\end{aligned} \tag{6.5a}$$

and

$$\begin{aligned}
\frac{d\gamma_3(\xi)}{d\xi} &= -[\gamma_3(\xi)]^2; \\
\frac{d\beta_3^+(\xi)}{d\xi} &= -2\gamma_3(\xi) \beta_3^+(\xi); \\
\frac{d\beta_3^-(\xi)}{d\xi} &= -\gamma_3(\xi) \beta_3^-(\xi); \\
\frac{d\Delta_3^{++}(\xi)}{d\xi} &= -2\Delta_3^{++}(\xi) \gamma_3(\xi) - 2[\beta_3^+(\xi)]^2 \\
\frac{d\Delta_3^{-+}(\xi)}{d\xi} &= \frac{d\Delta_3^{+-}(\xi)}{d\xi} = -2\beta_3^-(\xi) \beta_3^+(\xi) \\
\Delta_3^{--}(\xi) \gamma_3(\xi) &= [\beta_3^-(\xi)]^2 \\
\frac{d\gamma_2}{d\xi} &= \frac{d\beta_2^\sigma}{d\xi} = \frac{d\Delta_2^{\sigma_1\sigma_2}}{d\xi} = 0,
\end{aligned} \tag{6.5b}$$

Equations (6.5a) – (6.5b) have to be solved with the initial conditions [cf. Eqs. (4.58), (4.61), (4.65)]

$$\gamma_i(\xi=0) = \beta_i^\pm(\xi=0) = \Delta_i^\pm(\xi=0) = \gamma_i^0, \tag{6.5c}$$

where $\gamma_1^0 = \gamma_2^0 = \gamma_f$, $\gamma_3^0 = \gamma_4^0 = \gamma_b$.

There is a good intuitive reason to separate the equations for the coupling constants for $i = 1, 4$ from those for $i = 2, 3$. The latter group contains the quadratic interaction breaking the supersymmetry. Moreover, this would be the only group if we did not introduce the hermitization procedure of Sec. IV A. Those are the modes that will directly contribute to the observable quantities, see next Section, and we will call this sector “physical”.

The coupling constants with $i = 1, 4$ are related to the fields that appear as a result of the Hermitization procedure. Their quadratic parts remain supersymmetric and that is why this sector by itself does not contribute to any observables. This is the reason why we will call this sector “non-physical”.

In the one loop approximation, Eq. (6.5) these two sectors do not talk to each other and we will consider them separately.

C. Solution of RG equations in the “physical” sector.

Equations (6.5b) is the system of the first order non-linear equations with the triangular structure (there is

no feedback of constants Δ , β into evolution of the four particle vertex γ). As such, it can be easily solved with the initial conditions, Eqs. (6.5c):

$$\begin{aligned}
\gamma_2(\xi) &= \beta_2^\pm(\xi) = \Delta_2^{\pm\pm}(\xi) = \gamma_f(\theta); \\
\gamma_3(\xi) &= \frac{1}{\xi_b^* + \xi}; \\
\beta_3^+(\xi) &= \frac{\xi_b^*}{(\xi_b^* + \xi)^2}; \\
\beta_3^-(\xi) &= \frac{1}{\xi_b^* + \xi}; \\
\Delta_3^{++}(\xi) &= \frac{2\xi_b^{*2}}{(\xi_b^* + \xi)^3} - \frac{\xi_b^*}{(\xi_b^* + \xi)^2}; \\
\Delta_3^{--}(\xi) &= \frac{1}{\xi_b^* + \xi}; \\
\Delta_3^{+-}(\xi) &= \Delta_3^{-+}(\xi) = \frac{\xi_b^*}{(\xi_b^* + \xi)^2},
\end{aligned} \tag{6.6}$$

where we introduced the notation

$$\xi_b^*(\theta) \equiv \frac{1}{\gamma_b(\theta)} > 0. \tag{6.7}$$

and the backscattering amplitude γ_b^0 is defined in Eq. (4.49).

From Eq. (6.6) we see that the forward scattering amplitude is not renormalized in contrast to the backscattering ones. As we consider the repulsive case, the amplitudes $\gamma_3, \beta_3, \delta_3$ tend to zero in the limit $T, |\theta| \rightarrow 0$ and this is a “zero charge” situation. This behavior should, in principle, be seen using the conventional diagrammatic analysis. However, as the spin excitations considered here correspond to two particle electron Green functions, one should consider four particle electron Green functions in order to identify the behavior described by Eq. (6.6). Such interactions in four particles Green functions have not been studied previously and the result of Eq. (6.6) is a major and decisive step in this direction. The “zero charge” behavior does not indicate any drastic changes of the ground state of the system but is interesting on its own because it is definitely not present in the orthodox Fermi liquid picture.

As the result corresponds to the zero-charge flow, the one loop renormalization group and Eq. (6.6) would solve the problem completely. The renormalized amplitudes Δ can be used for calculating the thermodynamic properties of the system, as it will be done in the next section. On this route, however, a potential reef may rise and we turn to the statement of this problem now.

D. Solution of RG in “non-physical” sector and possible instability.

Solving Eq. (6.5a) with the initial conditions (6.5c)

$$\begin{aligned}
\gamma_1(\xi) &= \beta_1^\pm(\xi) = \gamma_f; \\
\text{we obtain} \\
\gamma_1(\xi) &= \frac{1}{\xi_f^* - \xi}; \\
\beta_1^+(\xi) &= \frac{\xi_f^*}{(\xi_f^* - \xi)^2}; \\
\beta_1^-(\xi) &= \frac{1}{\xi_f^* - \xi},
\end{aligned} \tag{6.8}$$

where we introduced the notation

$$\xi_f^*(\theta) \equiv \frac{1}{\gamma_f(\theta)} > 0, \tag{6.9}$$

and forward the scattering amplitude γ_f^0 is defined in Eq. (4.49).

The behavior of the amplitude $\gamma_1(\xi)$ from Eq. (6.8) comes as a real surprise because it demonstrates the existence of a logarithmic pole. This pole should be reached at $\xi = \xi_f$ and may signal on an instability of the ground state because, at first glance, the scenario looks similar to the one leading to the BCS theory of superconductivity. Does the logarithmic pole in Eq. (6.9) lead to a phase transition? We do not try to answer this question in this paper but the situation looks more complicated than usual because, within the RG scheme, the scattering amplitude γ_1 does not enter thermodynamic quantities like e.g. the specific heat, see the next section, and it does not couple to the physical sector at least on the level of one loop renormalization group.

We can envision two different scenarios that may follow from the existence of the pole in γ_1 in Eq. (6.9):

1. The amplitude $\gamma_1(\xi)$ does not enter any physical quantity and, therefore, the pole does not mean anything. In this case, we would be able to use all the equations for the backscattering amplitudes down to $\xi = 0$, which would allow us to go in temperature down to $T = 0$. This would mean that there are non-analytical corrections to the Fermi liquid but otherwise the Landau theory of Fermi liquid is a correct low-temperature limit.
2. The logarithmic pole means that at $\xi = \xi_f^*$ a reconstruction of the ground state (either in a form of phase transition or sharp crossover) occurs at a critical temperature T_c , which would manifest itself in a formation of the gap in the non-physical sector, that would affect physical degrees of freedom. In this case the ground state would change

and one would expect formation of an order parameter. Then, the present RG treatment of the effective action would be applicable for $T > T_c$ only. The formation of the gap means a breakdown of the Fermi liquid description for the spin excitations. As concerns the charge degrees of freedom, we have seen that they decouple from the spin ones on the very early stage, see Sec. III, and the Landau kinetic equation is applicable for them for arbitrary small temperatures.

It is still to be seen which of these two scenarios corresponds to the original action and we relegate this question to the further study⁵⁷. We emphasize, however, that the answer may differ for $d = 1$ and $d > 1$, because there is a large set of diagrams logarithmic in $1D$ and non-logarithmic for $d = 2,3$, see *e.g.* Fig. 10.

VII. SPECIFIC HEAT

We have performed the renormalization group calculations for the case when the vectors \mathbf{n} and \mathbf{n}' of two spin excitations were close to each other (parallel or antiparallel motion). Only in this limit one obtains large logarithms that determined the renormalization of the vertices. A crucial question is whether or not this narrow region of the phase space can bring an important contribution to thermodynamics or other physical quantities. This is not quite trivial question because the system was not assumed to be one- or quasi-one-dimensional, and one could imagine that all the effect of the singularities in the vertices would be washed out after the summation over the whole phase space.

In fact, this almost parallel motion of the spin excitations does not contribute much into the thermodynamic potential $\Omega_s(T)$ itself. Fortunately, this is not a very interesting quantity and what one would like to know are derivatives of the thermodynamic potential with respect to temperature or other sources. In the present paper, we restrict ourselves with the specific heat

$$C = -T \frac{\partial^2 \Omega}{\partial T^2}. \quad (7.1)$$

Our goal is to identify the non-analytic contributions to the specific heat using the properties of the effective theory established in the previous sections.

As we will show, our low-energy field theory is applicable for the calculation of

$$\delta \Omega_s(T) = \Omega_s(T) - \Omega_s(T=0), \quad (7.2)$$

and we will focus in this section on the calculation of the latter quantity.

We will present the main approximations and manipulations suitable for any dimensions in Sec. VII A. We will collect the final results for two- and three- dimensional systems in Sec. VII B and discuss their relation to

the contribution of the Cooper channel in VII D. For one dimensional systems approximations of Secs. VII A, will turn out not to be sufficient and we will have to take additional terms into account specific for one-dimensional systems, see Sec. VIII D.

A. General formulae.

Using the diagrammatic method of the calculations one can always cut one of the Green functions and express the thermodynamic potential $\Omega(T)$ in terms of a sum over bosonic Matsubara frequencies $\omega_n = 2\pi T n$ transmitted through this particular Green function:

$$\Omega_s(T) = T \sum_{\omega_n} \mathbb{R}(\omega_n) \quad (7.3)$$

where $\mathbb{R}(\omega_n)$ is a function of the frequency to be calculated later.

The sums of the type (7.3) are very often divergent at high frequencies if one uses expressions available from a low energy effective theory. This problem can be avoided calculating the quantity $\delta \Omega(T)$ from Eq. (7.2). Using the Poisson formula, we represent $\delta \Omega(T)$ in the form

$$\delta \Omega(T) = \sum_{l \neq 0} \int \mathbb{R}(\omega) \exp\left(-\frac{il\omega}{T}\right) \frac{d\omega}{2\pi}, \quad (7.4)$$

which improves the convergence significantly. The essential frequencies in Eq. (7.4) are of the order of T and are smaller than those frequencies that form logarithms in the vertices. That is why the renormalized vertices calculated in the previous section become useful.

To proceed with actual calculation, we notice that if we kept in the action $\mathcal{S}\{\psi\}$ only the supersymmetric part $\mathcal{S}_0\{\psi\} + \mathcal{S}_4\{\psi\}$, see Eqs. (4.44), (4.45), (4.55) only, we would obtain unity for the partition function and, thus, no contribution to the thermodynamic potential Ω . The interaction terms $\mathcal{S}_2\{\psi\}$ and $\mathcal{S}_3\{\psi\}$, see Eqs. (4.51), (4.59), (4.52), (4.62) violate the supersymmetry and, as a result, one obtains finite contribution to Ω_s only when expanding in such terms.

As all the high-frequency $\omega \gtrsim T$ contributions are already included into the renormalized value of the vertices, the thermodynamic potential $\Omega(T)$ can be expanded in terms of the renormalized action $\mathcal{S}_2\{\Psi\}$, Eq. (4.62), and the lowest non-vanishing orders take the form

$$\begin{aligned} \Omega_s(T) &= \Omega_1(T) + \Omega_2(T); \\ \Omega_1(T) &= T \langle \mathcal{S}_2\{\psi\} \rangle_0; \\ \Omega_2(T) &= -\frac{T}{2} \langle [\mathcal{S}_2\{\psi\}]^2 \rangle_0, \end{aligned} \quad (7.5)$$

and $\langle \dots \rangle_0$ was defined in Eq. (5.2). The corresponding diagrams are depicted in Fig. 11a,b).

It will turn out that correction Ω_1 is analytic function of temperature whereas the most interesting term, Ω_2 is

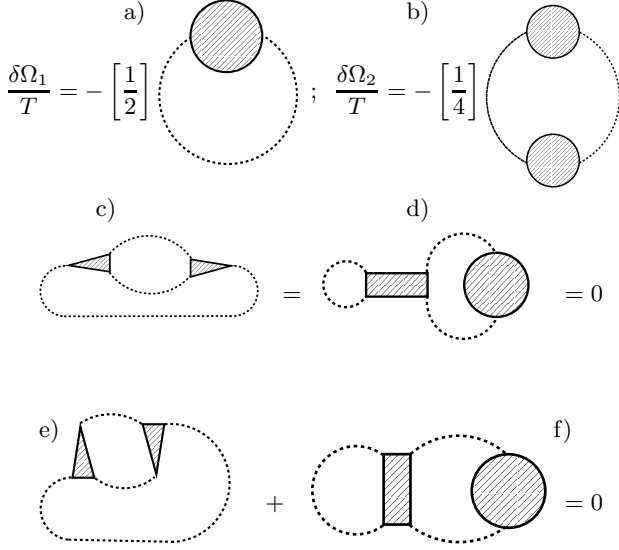

FIG. 11: Lowest order corrections to the temperature dependent part of the thermodynamic potential $\delta\Omega(T)$. The notations are explained in Sec. V, see Figs. 4 – 9. The coefficients in the brackets correspond to the number of symmetries of the diagram. The dotted line for the Green function means that summation over the frequency of this line is performed with Eq. (7.4) replacing the summation (7.3). Diagrams c,d vanish due to the supersymmetry. Diagrams e,f are separately of higher order in the forward scattering amplitude and, moreover, cancel each other.

non-analytic. For the pedagogical reasons, we will consider an analytic correction first and then use the gained knowledge for more involved analysis of the non-analytic contribution.

1. Analytic contribution.

Using the rules of the diagrammatic technique of Sec. V we can obtain analytic expression for $\Omega_1(T)$ (for unit volume) in terms of the function \mathbb{K} introduced in Eq. (5.52):

$$\Omega_1 = \frac{3T}{4} \sum_{\omega_n} \sum_{i=2,3} \sum_{j=1}^4 \lambda_{ij} \int_0^1 du \int d\mathbf{n} \int \frac{d^d \mathbf{k}}{(2\pi)^d} \times \sum_{\sigma_1 \sigma_2 = \pm} \mathbb{K}_1^{\sigma_1 \sigma_2}(\omega, \mathbf{k}, \mathbf{n}; u) \Delta_i^{\sigma_1 \sigma_2}(\theta = 0; u, u; \mathbf{k});$$

$$\mathbf{k}_\perp = \mathbf{k} - \mathbf{n}(\mathbf{k} \cdot \mathbf{n}), \quad \mathbf{r}_\perp = \mathbf{r} - \mathbf{n}(\mathbf{r} \cdot \mathbf{n})$$

$$\Delta_i^{\sigma_1 \sigma_2}(\theta; u, u; \mathbf{k}_\perp) = \int d^d \mathbf{r} e^{-i\mathbf{k}\mathbf{r}} \Delta_i^{\sigma_1 \sigma_2}(\theta; u, u; \mathbf{r}_\perp) \bar{f}(|\mathbf{r}|), \quad (7.6)$$

where the cutoff function $\bar{f}(\mathbf{r})$ is defined by Eq. (2.29), all the other entries were introduced in Secs. IV, V, and

the convention (4.13) for the angular integration is used. Replacing the summation over the Matsubara frequency with the integrations according to Eqs. (7.3)–(7.4), and using λ_{ij} from Eq. (4.53), we obtain

$$\delta\Omega_1(T) = 3 \int_0^1 u du \int d\mathbf{n} \sum_{l=1}^{\infty} \int \frac{d\omega}{2\pi} \exp\left(\frac{-i\omega}{T}\right) \times \int \frac{f(\mathbf{k}) d\mathbf{k}}{(2\pi)^d} \left(\frac{i\omega + v_F \mathbf{k}\mathbf{n}}{i\omega - v_F \mathbf{k}\mathbf{n}}\right) \Delta_2^{+-}(\theta = 0), \quad (7.7)$$

and the value of Δ_2^{+-} is given by Eq. (6.6). The integral in Eq. (7.7) contains integration over all directions of the unit vector \mathbf{n} with the normalization of Eq. (1.2). As we obtained in the previous section, Δ_2^{+-} is not renormalized by interaction and it is given by its bare value $\gamma_f \equiv \gamma_f(\theta) = 0$. Nevertheless, the remaining integral in Eq. (7.7) gives a temperature dependent contribution and let us show how one can calculate this integral.

The integration over u is trivial and gives 1/2. The integration over \mathbf{k} can be performed separately for the component k_\parallel parallel to \mathbf{n} and \mathbf{k}_\perp perpendicular to \mathbf{n} . Essential k_\parallel are of the order of T/v_F , whereas k_\perp are of the order of the maximum momentum $k_c \simeq r_0^{-1}$. Therefore, we can neglect k_\parallel in the cutoff function. Integration over k_\parallel is, then, immediately performed with the result

$$\delta\Omega_1(T) = \lim_{\eta \rightarrow +0} \sum_{l=1}^{\infty} \int \frac{d\omega}{2\pi} |\omega| \exp\left(-i\frac{l\omega}{T} - \eta|\omega|\right) \times \frac{3\gamma_f}{2v_F} \int f_0(k_\perp r_0) \frac{d^{d-1} \mathbf{k}_\perp}{(2\pi)^{d-1}} \quad (7.8)$$

The small parameter η in the exponential is added to provide the convergence of the integral over ω .

Expression in the first line of Eq. (7.8) takes after the ω -integration the following form:

$$\lim_{\eta \rightarrow 0} \sum_{l=1}^{\infty} \left[\frac{1}{(\eta + \frac{i}{T})^2} + \frac{1}{(\eta + \frac{-i}{T})^2} \right] = -\frac{(\pi T)^2}{3}. \quad (7.9)$$

Substituting Eqs. (7.8)–(7.9) into Eq. (7.1) we obtain the corresponding contribution $\delta C_1(T)$ to the specific heat

$$\frac{\delta C_1}{T} = \frac{\pi(3\gamma_f)}{6v_F \lambda_0^{d-1}}, \quad \lambda_0^{1-d} = \int f_0(k_\perp r_0) \frac{d^{d-1} \mathbf{k}_\perp}{(2\pi)^{d-1}}. \quad (7.10)$$

The parameter $\lambda_0 \simeq 1/r_0$ becomes of the order of k_F^{-1} in the limit of the applicability of the theory.

We see from Eq. (7.10) that the correction $\delta C_1(T)$ does not change the linear dependence of the specific heat on temperature.

Let us discuss the significance of this result and its relation to the free mode consideration of Sec. III C. First of all, direct comparison shows that Eq. (7.7) is equivalent

to the first term in the perturbative expansion of temperature dependent parts of Eqs. (3.34'), (3.30'). Therefore, the singlet contribution (3.30') also has to be taken into account in Eq. (7.10), which leads to the replacement $(3\gamma_f) \rightarrow (3\gamma_f - \gamma_f^\rho)$, where $\gamma_f^\rho \equiv \gamma^\rho(\theta = 0)$.

Equation (7.10) gives the contribution which does not depend on the cutoff in one dimension. In this case it describes the renormalization of the velocities of the spin and charge modes in Luttinger liquid regime. In contrast, in higher dimensions, $d > 1$, the coefficient does depend on the cut-off. However, all this contribution coming from the small distances can be ascribed to the renormalization of the effective mass and included into the partition function of non-interacting quasiparticles, [Z_0 from Eq. (3.12)].

The effective theory of the interacting collective modes being the effective low energy theory does not describe such ultraviolet corrections and that is why we cannot identify the numerical coefficient from our theory. However, the effective low energy theory^{xiii} does describe the non-analytic corrections as the latter are associated with the spatial scales $\simeq v_F/T \gg 1/k_F$. We turn to the derivation of such non-analytic corrections now.

2. Non-analytic contribution.

The analytic expression for the diagram Fig. 11b reads [see Eq. (7.6) for the notations]

$$\begin{aligned} \Omega_2 &= -\frac{3T}{4} \sum_{\omega_n} \sum_{i=2,3} \sum_{j=1}^4 \lambda_{ij} \iint_0^1 du_1 du_2 \iint d\mathbf{n}_1 d\mathbf{n}_2 \\ &\times \int \frac{d^d \mathbf{k}}{(2\pi)^d} \sum_{\sigma_1, \dots, \sigma_4 = \pm} \\ &\times \left\{ \mathbb{K}_j^{\sigma_1 \sigma_2}(\omega, \mathbf{k}, \mathbf{n}_1; u_1) \Delta_i^{\sigma_2 \sigma_3}(\widehat{\mathbf{n}_1 \mathbf{n}_2}; u_1, u_2; \mathbf{k}_\perp) \right. \\ &\times \left. \mathbb{K}_j^{\sigma_3 \sigma_4}(\omega, \mathbf{k}, \mathbf{n}_2; u_2) \Delta_i^{\sigma_4 \sigma_1}(\widehat{\mathbf{n}_2 \mathbf{n}_1}; u_2, u_1; \mathbf{k}_\perp) \right\}; \end{aligned} \quad (7.11)$$

where the convention (4.13) for the angular integration is implied, and in definition of \mathbf{k}_\perp , the direction \mathbf{n} means $\mathbf{n} = (\mathbf{n}_1 + \mathbf{n}_2)/2$. Using Eqs. (5.52) and (4.53), keeping only terms with the pole location such that the result does not vanish after integration over $k_\parallel = \mathbf{k} \cdot \mathbf{n}$, and

using replacements Eqs. (7.3)–(7.4), we find

$$\begin{aligned} \delta\Omega_2(T) &= -6 \lim_{\eta \rightarrow +0} \sum_{l=1}^{\infty} \int \frac{d\omega}{(2\pi)} \exp\left(-i\frac{l\omega}{T} - \eta|\omega|\right) \\ &\times \int d\mathbf{n}_1 d\mathbf{n}_2 \int \frac{d^d \mathbf{k}}{(2\pi)^d} Y(\widehat{\mathbf{n}_1 \mathbf{n}_2}; \mathbf{k}_\perp; k_\parallel) \mathcal{P}_d(\omega, \mathbf{k}; \mathbf{n}_1, \mathbf{n}_2), \end{aligned} \quad (7.12)$$

and the convention (4.13) for the angular integration is implied. The function $Y(\theta; \mathbf{k}_\perp)$ defined as

$$\begin{aligned} Y(\theta; \mathbf{k}_\perp, k_\parallel) &= \iint_0^1 u_1 u_2 du_1 du_2 \\ &\times \left\{ [\Delta_3^{+-}(\theta; u_1, u_2; \mathbf{k}_\perp, k_\parallel)]^2 \right. \\ &\left. + \Delta_3^{++}(\theta; u_1, u_2; \mathbf{k}_\perp, k_\parallel) \Delta_3^{--}(\theta; u_1, u_2; \mathbf{k}_\perp, k_\parallel) \right\} \end{aligned} \quad (7.13)$$

will be the most important entry in the final expression for the specific heat. In Eq. (7.13), we wrote explicitly the transverse and the longitudinal momenta of \mathbf{k} , see Eq. (7.7), as their role will be different.

The formfactor

$$\mathcal{P}_d(\omega, \mathbf{k}; \mathbf{n}_1, \mathbf{n}_2) = \frac{(i\omega + v_F \mathbf{k} \mathbf{n}_2)(i\omega - v_F \mathbf{k} \mathbf{n}_1)}{(i\omega - v_F \mathbf{k} \mathbf{n}_2)(i\omega + v_F \mathbf{k} \mathbf{n}_1)} \quad (7.14)$$

depends on the dimensionality of the system and it describes basically the free propagation of the two spin excitations in almost opposite directions.

If one used the bare values of Δ , see Eq. (4.65), we would obtain the second term in the expansion of Eq. (3.34') in powers of γ . The main advantage of Eq. (7.14) is that it accounts for the logarithmic renormalization of the quadratic interaction obtained in Secs. V, VI, see Eq. (6.7).

The non-analytic contributions originate from the small region of the phase space $|\mathbf{n}_1 - \mathbf{n}_2| \ll 1$. It enables us to introduce [cf. Sec. VB]

$$\begin{aligned} \mathbf{n} &= (\mathbf{n}_1 + \mathbf{n}_2)/2; & \delta\mathbf{n} &= \mathbf{n}_1 - \mathbf{n}_2; \\ k_\parallel &= \mathbf{k} \cdot \mathbf{n}; & \mathbf{k}_\perp &= \mathbf{k} - k_\parallel \mathbf{n}, \end{aligned} \quad (7.15)$$

and integrate over k_\parallel in Eq. (7.13).

To facilitate the integration we introduce the function

$$\begin{aligned} \mathcal{P}_d(\delta\mathbf{n}; k_\perp) &\equiv \lim_{\eta \rightarrow +0} \sum_{l=1}^{\infty} \int \frac{d\omega dk_\parallel}{(2\pi)^2} \exp\left(-i\frac{l\omega}{T} - \eta|\omega|\right) \\ &\times \frac{1}{2} \sum_{\pm} \mathcal{P}_d\left(\omega, \pm\mathbf{k}_\perp + k_\parallel \mathbf{n}; \mathbf{n} + \frac{\delta\mathbf{n}}{2}, \mathbf{n} - \frac{\delta\mathbf{n}}{2}\right). \end{aligned} \quad (7.16)$$

Using

$$\lim_{\eta \rightarrow +0} \sum_{l=1}^{\infty} \int d\omega \exp\left(-i\frac{l\omega}{T} - \eta|\omega|\right) \left(\int dk_\parallel f^2(\mathbf{k})\right) = 0,$$

^{xiii} Without any drawbacks one can formulate the effective low-energy theory for the Fermi liquid function such that $3\gamma_f = \gamma_f^\rho$. The ultraviolet correction to the specific heat does not appear in this case at all.

we obtain

$$\mathcal{P}_{d=1} = 0, \quad (7.17a)$$

which means that for one dimensional systems there is no contribution to the specific heat of the second order in the backscattering amplitude in accord with known results⁵⁵. This does not mean, however that there are no logarithmic contributions to the specific heat in $1d$ at all. Corrections of the third order in the effective amplitude will be recovered in Sec. VIII D.

For the higher dimensions we obtain

$$\begin{aligned} \mathcal{P}_{d=2,3} &= \lim_{\eta \rightarrow +0} \sum_{l=1}^{\infty} \int \frac{d\omega}{(2\pi)} \exp\left(-i\frac{l\omega}{T} - \eta|\omega|\right) \\ &\times \left(|\omega| - \frac{4|\omega|^3}{4\omega^2 + (\delta\mathbf{k}_{\perp}\mathbf{n})^2 v_F^2} \right). \end{aligned} \quad (7.17b)$$

The first term in Eq. (7.17b) is similar to Eq. (7.8) and produces only analytic contribution to the specific heat. We will disregard this term and focus only on the second contribution. This is this contribution that quantifies the effect of the small region of the phase space where the interaction renormalization is strong. It is worth noting that the characteristic k_{\parallel} contributing into the result where of the order of T/v_F and, therefore, the separation of the integration on the transverse and longitudinal parts is well justified.

Substituting Eq. (7.17b) in Eq. (7.13) and performing the Fourier transform in the transverse direction we find for $d > 1$

$$\begin{aligned} \delta\Omega_2(T) &= -\frac{12}{v_F^2} \iint \frac{d\mathbf{n}d\delta\mathbf{n}}{|\delta\mathbf{n}|} \int dx \bar{Y}(|\delta\mathbf{n}|; x) \\ &\times \lim_{\eta \rightarrow +0} \sum_{l=1}^{\infty} \int \frac{\omega^2 d\omega}{2\pi} \exp\left(-\frac{2|\omega x|}{|\delta\mathbf{n}|v_F} - \frac{i\omega l}{T} - \eta|\omega|\right), \end{aligned} \quad (7.18)$$

where the integration over \mathbf{n} and $\delta\mathbf{n}$ are performed using conventions (4.13) and (1.2) respectively, and

$$\bar{Y}(\theta; |\mathbf{r}_{\perp}|) = \int \frac{d^{d-1}\mathbf{k}_{\perp}}{(2\pi)^{d-1}} e^{i\mathbf{k}_{\perp}\mathbf{r}_{\perp}} Y(\theta; \mathbf{k}_{\perp}; \mathbf{k}_{\parallel} = 0). \quad (7.19)$$

Integration over ω and \mathbf{n} in Eq. (7.18) can be immediately performed with the result

$$\begin{aligned} \delta\Omega_2(T) &= -\frac{6T^3}{\pi^2 v_F^2} \sum_{l=1}^{\infty} \int \frac{d^{d-1}\delta\mathbf{n}}{2^{d-2}|\delta\mathbf{n}|} \int dx \\ &\times \bar{Y}(|\delta\mathbf{n}|; x) \text{Re} \left(\frac{1}{il + \frac{2T|x|}{|\delta\mathbf{n}|v_F}} \right)^3, \end{aligned} \quad (7.20)$$

where integration over $\delta\mathbf{n}$ has to be understood as integration over usual $d-1$ dimensional vector with $|\delta n| \lesssim 1$.

The remaining integrations in Eq. (7.18) are slightly different for $d = 2, 3$ and we will describe them separately. For $d = 2$, $\delta\mathbf{n}$ is a one-dimensional variable. After obvious rescaling, Eq. (7.20) gives

$$\begin{aligned} \delta\Omega_2^{d=2}(T) &= -\frac{12T^3}{\pi^2 v_F^2} \sum_{l=1}^{\infty} \frac{1}{l^3} \int dx \\ &\times \text{Re} \int_0^{\frac{lv_F}{2|x|T}} \frac{d\phi \phi^2 \bar{Y}\left(\frac{2\phi|x|T}{lv_F}; x\right)}{(i\phi + 1)^3}. \end{aligned} \quad (7.21)$$

The integral in Eq. (7.21) convergent at $\phi \simeq 1$. Because $x \simeq r_0$, and $T \ll v_F/r_0$, the upper limit in the integral can be put to infinity. On the other hand, according to Eq. (6.4), $Y(\theta)$ does not depend on θ at $\theta < Tr_0/v_F$, therefore, we can put the first argument in \bar{Y} equal to zero. The remaining integral takes the form

$$\int_0^{\infty} \frac{d\phi \phi^2}{(i\phi + 1)^3} = -\frac{\pi}{2},$$

The sum over l is trivial, and we obtain

$$\delta\Omega_2^{d=2}(T) = \frac{6\zeta(3)T^3}{\pi v_F^2} Y(\theta = 0), \quad (7.22)$$

where $\zeta(3) \approx 1.202\dots$ is the Riemann ζ -function and

$$Y(\theta) \equiv Y(\theta; \mathbf{k} = 0), \quad (7.23)$$

see Eq. (7.13). The value $\theta = 0$ in the function $Y(\theta)$ entering Eq. (7.22) corresponds to the exactly backward scattering.

Let us consider, now the three-dimensional case. The result turns to be logarithmic with the main contribution from $Tx/v_F \lesssim |\delta n| \gg 1$. Expanding the last factor in Eq. 7.20 and keeping only the first non-vanishing contribution we find

$$\delta\Omega_2^{d=3}(T) = \frac{36T^4}{\pi^2 v_F^3} \sum_{l=1}^{\infty} \frac{1}{l^4} \int \frac{d^2\delta\mathbf{n}}{|\delta\mathbf{n}|^2} \int_0^{\frac{v_F|\delta n|}{T}} dx x \bar{Y}(|\delta\mathbf{n}|; x), \quad (7.24)$$

As the integrand decays rapidly at $x \simeq r_0$, the upper limit in the last integral can be put to infinity for $\theta = |\delta\mathbf{n}| \gtrsim Tr_0/v_F$. Using

$$2\pi \int_0^{\infty} dx x \bar{Y}(\theta; x) = Y(\theta),$$

see Eq. (7.23), we obtain

$$\delta\Omega_2^{d=3}(T) = \frac{2\pi^2 T^4}{5v_F^3} \int_{\frac{Tr_0}{v_F}}^1 \frac{d\theta Y(\theta)}{\theta}. \quad (7.25)$$

Equations (7.22) and (7.25) are the main results of this subsection. They show that the thermodynamic potential for the both two and three dimensional systems can be expressed in terms of the function $Y(\theta)$, that has to be determined from Eqs. (7.13), and (6.6). Carrying on this program and obtaining the final expressions for the specific heat will be subject of the next subsection. Here, we just emphasize the difference between Eqs. (7.22) and (7.25). Namely, in $2d$ case one has to take the function Y at strictly $\theta = 0$, whereas in $3d$ it involves integrals over all angles. At the same time, even in $3D$, the main contribution comes with the logarithmic accuracy from small angles $\theta \lesssim 1$, that describe again the scattering close to backward one.

B. Final results for two- and three- dimensional systems.

From now on we will concentrate only on the non-analytic contribution $\delta\Omega_2^{d=2,3}$ and that is why we will omit the subscript. Before writing the final results in a general form, it is instructive to perform the calculation replacing the quadratic interaction constants $\Delta^{\pm\pm}$ in Eqs. (7.13) and (7.23) with their bare values (4.65). After integration over $u_{1,2}$ in Eq. (7.13) one obtains

$$Y^{(0)}(\theta) = \frac{1}{2} [\gamma_b(\theta)]^2 f^2(0) = \frac{1}{2} \gamma_b^2(\theta), \quad (7.26)$$

where $\gamma_b(\theta)$ is defined in Eq. (4.49), and $f(\mathbf{k})$ is given by Eq. (2.13). Substitution of Eq. (7.26) into Eqs. (7.22) and (7.25) yields

$$\delta\Omega_{(t,\text{bare})}^{d=2}(T) = 3 [\gamma_b]^2 \frac{\zeta(3) T^3}{\pi v_F^2}; \quad \gamma_b \equiv \gamma_b(\theta = 0), \quad (7.27a)$$

where we restored the explicit subscript ‘‘t’’ for the triplet contribution. If $Y^{(0)}(\theta)$ is a smooth function for $\theta \rightarrow 0$, the three-dimensional thermodynamic potential reads with the logarithmic accuracy

$$\delta\Omega_{(t,\text{bare})}^{d=3}(T) = 3 [\gamma_b]^2 \frac{\pi^2 T^4}{15 v_F^3} \ln \frac{\varepsilon_F}{T}. \quad (7.27b)$$

Similarly to Eq. (7.10), formula (7.27) is equivalent to the second term in the perturbative expansion of temperature dependent parts of Eqs. (3.34’), (3.30’). Therefore, the singlet contribution (3.30’) has also to be taken into account in Eq. (7.27), which leads to the replacement $(3\gamma_b^2) \rightarrow (3\gamma_b^2 + [\gamma_b^\rho]^2)$, where $\gamma_b^\rho \equiv \gamma^\rho(\theta = \pi)$. Unlike the analytic contribution, Eqs. (7.27) do not contain the ultraviolet cut-off and their contribution can not be ascribed to the renormalization of the effective mass. These are clear effects of the contribution of the bosonic collective modes of the Fermi liquid into the thermodynamics of the system.

Using Eqs. (7.27) in Eq. (7.1) and introducing the density of particles

$$N_{d=2} = \frac{p_F^2}{2\pi}, \quad N_{d=3} = \frac{p_F^3}{3\pi^2} \quad (7.28)$$

we write the correction to the specific heat per particle $\delta c = \delta C/N$ as

$$\delta c_{d=2}^{(\text{bare})} = -\frac{3\zeta(3)}{\pi} \left(\frac{T}{\varepsilon_F}\right)^2 (3\gamma_b^2 + [\gamma_b^\rho]^2); \quad (7.29a)$$

$$\delta c_{d=3}^{(\text{bare})} = -\frac{3\pi^4}{10} \left(\frac{T}{\varepsilon_F}\right)^3 \ln\left(\frac{\varepsilon_F}{T}\right) (3\gamma_b^2 + [\gamma_b^\rho]^2 + \mathcal{O}(\gamma^3)). \quad (7.29b)$$

[The last term in Eq. (7.29) is the contribution of the third order in coupling constant which was obtained in Ref. 28 and we refer the reader to this reference for the explicit form of the coefficients in this term and will not write explicitly in the subsequent considerations.] It is worth reminding that p_F is not renormalized by interaction, whereas $\varepsilon_F \equiv v_F p_F/2$ is significantly affected¹. Actually, v_F has the meaning only as a quantity describing the slope in a leading linear in temperature quasiparticle contribution to the specific heat.

Equations (7.29) agree with the corresponding expressions obtained previously in a number of works using conventional diagrammatic expansions (see *e.g.* Refs. 18,28, for the latest developments consisting in accurate evaluation of the angular and q integrals in expressions similar to Eqs. (3.30), (3.34) and obtaining correct analytic expressions for the first time)^{xiii}.

Using the conventional diagrammatic technique one can hardly go beyond the first orders, which would be definitely enough for the singlet channel. At the same time, using the present bosonization scheme we have found for the first time the logarithmic contributions discussed in the previous Sections and have derived and solved proper renormalization group equations. Now we can include the logarithmic contributions into the formulas for the specific heat. The only thing that remains to be done is to calculate the function $Y(\theta)$ from Eqs. (7.23), (7.13).

Using the explicit expressions (6.6) for the couplings $\Delta_3^{\pm\pm}$, and the formula

$$\begin{aligned} & \iint_0^1 du_1 du_2 (u_1 u_2)^2 \left[\frac{(1+x_1 u_1 u_2)^2 + (1+x_2 u_1 u_2)^2}{(1+x_1 u_1 u_2)^3 (1+x_2 u_1 u_2)^3} \right. \\ & \quad \left. - \frac{(x_1+x_2) u_1 u_2}{2(1+x_1 u_1 u_2)^2 (1+x_2 u_1 u_2)^2} \right] \\ & = \frac{1}{2(1+x_1)(1+x_2)}, \end{aligned}$$

^{xiii} The definitions of the coupling constants γ , Eq. (3.35), differs by the factor 2 from the one of Ref. 18,28 because we used the density of states ν per one spin orientation but not the total density of states.

we reduce Eq. (7.13) to the form

$$Y(\theta) = \frac{\gamma_b^2(\theta)}{2} \left[\int \frac{d^{d-1}\mathbf{r}_\perp}{r_0^{(d-1)}} \frac{\bar{f}_\perp\left(\frac{|\mathbf{r}_\perp|}{r_0}\right)}{1 + \bar{f}_\perp\left(\frac{|\mathbf{r}_\perp|}{r_0}\right)\mathcal{X}(\theta)} \right]^2, \quad (7.30)$$

where function $\bar{f}_\perp(r_\perp/r_0)$ is given by Eq. (5.16b). The variable \mathcal{X} is defined as

$$\begin{aligned} \mathcal{X}(\theta) &= -\mu_d \gamma_b(\theta) \ln[\max\{\theta, T/\varepsilon_0\}]; \\ \mathcal{X}(T) &\equiv \mathcal{X}(\theta=0) = \mu_d \gamma_b \ln\left(\frac{\varepsilon_0}{T}\right), \end{aligned} \quad (7.31)$$

with the parameter μ_d given by Eq. (5.16), and the cut-off energy defined as $\varepsilon_0 = \frac{v_F}{r_0} \simeq \varepsilon_F$.

Equation (7.30) gives the most general form of the function $Y(\theta)$ for any function f . The asymptotics of the function $Y(\theta)$ in the limit $X \ll 1$ can easily be written as

$$Y(\theta) = \gamma_b^2(\theta) \left(\frac{1}{2} - \mathcal{X}(\theta) r_0^{d-1} \int f^2(\mathbf{k}_\perp) \frac{d^{d-1}\mathbf{k}_\perp}{(2\pi)^{d-1}} \right), \quad (7.32)$$

where the cutoff function $f(\mathbf{k})$ is given Eq. (2.13).

The first term in Eq. (7.32) is what has been used when deriving Eqs. (7.29). The second term leads to an additional logarithm in the T^d -dependence of the specific heat in both two and three dimensional systems. Notice, that the latter term depends on the form of the ultraviolet cut-off $f(\mathbf{k})$. As the function $f(\mathbf{k})$ has been introduced in our theory phenomenologically, the complete results depend on its form, which is a deficiency of our low energy bosonization approach, where the bare coupling constants were introduced independently of the ultraviolet cutoff. At the same time, we will see that it gives at least a good qualitative description of the interesting temperature behavior, and will address the issue of the dependence of the coupling constants vs. the cutoff function in the next subsection.

A simple expression for the specific heat for arbitrary \mathcal{X} can be obtained if we choose the function $\bar{f}_\perp(r_\perp/r_0)$, Eq. (5.16a) as

$$\bar{f}_\perp(r_\perp/r_0) = \exp(-r_\perp/r_0) \quad (7.33)$$

The choice (7.33) in the coordinate space corresponds to

$$f_{d=2}(\mathbf{k}) = \frac{1}{1 + \mathbf{k}^2 r_0^2}; \quad f_{d=3}(\mathbf{k}) = \frac{1}{(1 + \mathbf{k}^2 r_0^2)^{3/2}} \quad (7.34)$$

in the momentum space.

Substituting Eq. (7.33) into Eq. (7.30), and performing the remaining integration, we obtain

$$\begin{aligned} Y_{d=2}(\theta) &= \frac{\gamma_b^2 \{\ln[1 + \mathcal{X}(\theta)]\}^2}{2[\mathcal{X}(\theta)]^2}; \\ Y_{d=3}(\theta) &= \frac{\gamma_b^2 \left\{ \text{Li}_2[-\mathcal{X}(\theta)]^2 \right\}}{2[\mathcal{X}(\theta)]^2}, \end{aligned} \quad (7.35)$$

where $\text{Li}_2(x) = \sum_{k=1}^{\infty} x^k/k^2$ is the polylogarithm function. Using Eq. (7.35) we can write the asymptotics of the function $Y(\theta)$ for $X \gg 1$ as

$$Y_{d=2}(\theta) \simeq \frac{\gamma_b^2 \ln^2 \mathcal{X}}{2\mathcal{X}^2}; \quad Y_{d=3}(\theta) \simeq \frac{\gamma_b^2 \ln^4 \mathcal{X}}{8\mathcal{X}^2}. \quad (7.36)$$

The asymptotic behavior \mathcal{X}^{-2} in Eq. (7.36) is not very sensitive to the form of the function $f(\mathbf{k})$, although the power of $\ln \mathcal{X}$ is not universal. On the other hand, more accurate treatment of those double logarithmic temperature dependencies would be an overstepping of the accuracy of the one loop approximation anyway.

The final formula for the specific heat δc per particle can be written with the logarithmic accuracy as

$$\delta c_{d=2} = -\frac{3\zeta(3)T^2}{\pi\varepsilon_F^2} \left\{ [\gamma_b^\rho]^2 + \frac{3\gamma_b^2 \{\ln[1 + \mathcal{X}(T)]\}^2}{2[\mathcal{X}(T)]^2} \right\}; \quad (7.37a)$$

$$\begin{aligned} \delta c_{d=3} &= -\frac{3\pi^4}{10} \left(\frac{T}{\varepsilon_F} \right)^3 \\ &\times \left\{ [\gamma_b^\rho]^2 \ln \frac{\varepsilon_F}{T} + \frac{3\gamma_b}{2\mu_3} \int_0^{\mathcal{X}(T)} \frac{dz}{z^2} [\text{Li}_2(-z)]^2 \right\}; \end{aligned} \quad (7.37b)$$

where the variable $\mathcal{X}(T)$ is defined in Eq. (7.31). Equations (7.37) refine Eqs. (7.29) by including all the leading logarithmic corrections originating from the interaction of the spin modes.

Equations (7.31), (7.32), (7.35), (7.36) give the final results for different cases and demonstrate non-trivial logarithmic dependencies on temperature. This behavior is more complicated than what one usually expects for the Fermi liquid picture. The unusual behavior is due to the interaction between the spin excitations. As concerns the charge excitations, they contribute in a more simple way, and their contribution is completely expressible in terms of the Fermi-liquid interaction function.

C. On the role of the Cooper channel and choice of ultraviolet cut-off function.

Strictly speaking, all the results we present here can be justified for $r_0 p_F \gg 1$, where r_0 has been introduced as the shortest length of our low energy theory. However, we hope that they remain relevant for the initial model of the Fermi gas with a repulsion. The scale r_0 in this case has to be found from the explicit calculation of the logarithmic corrections in original model of the interacting fermions rather than in the reduced model (2.10). Such calculation will not be done in the present paper, however, we will try to outline the steps which should be performed, without claiming too much rigor.

It is well known¹¹ that the Fermi liquid functions experience the strong logarithmic renormalization for scattering directions close to backwards. (Such a logarithmically

divergent term for the Fermi liquid function has been obtained for the first time in Ref. 59.) This is because the Cooper channel, see Fig. 12, at such angles has a strong mixing with the electron-hole channel. If the logarithmic renormalization were present only in the Cooper channel the result would read

$$\begin{aligned} \hat{\gamma}_c(\mathbf{Q}, \omega) &= \frac{\hat{\gamma}_0}{1 + \hat{\gamma}_0 \mathcal{L}}; \\ \mathcal{L} &= \ln \left[\frac{\epsilon_F}{\max(|\omega|, v_F |\mathbf{Q}|)} \right], \end{aligned} \quad (7.38)$$

i.e., one had a zero-charge situation provided operator $\hat{\gamma}_0$ is positive definite. The needed function $\hat{\gamma}_c(\theta; Q, \omega)$ are defined as kernels of the operator $\hat{\gamma}_c$. Notice, however, that the result depends on all of the angular harmonics of the bare interaction $\hat{\gamma}_0$.

There is a region in the phase space, however, where the Cooper channel and the triplet channel cannot be distinguished from each other, see also Figs. 2, 3, and this is the region that was studied in previous sections. Even though the structure of the results (7.37), indicate that, indeed, the result can be factorized to the logarithmic renormalization of the backscattering amplitudes as it was argued in Ref. 18, however, it does not mean that they coincide with the renormalization by the Cooper channel only.

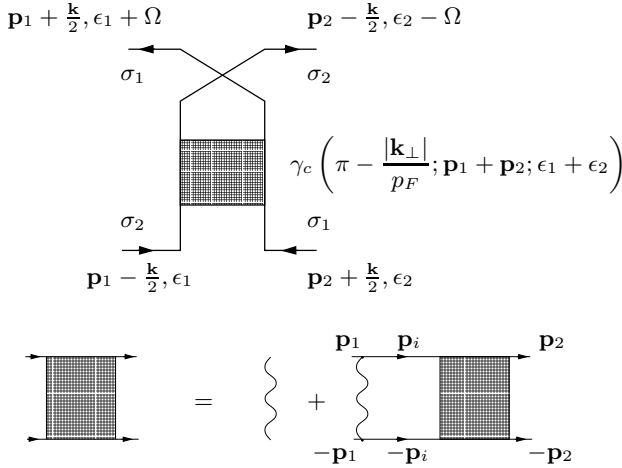

FIG. 12: Leading logarithmic renormalization of the vertex γ_b . The integration over the intermediate momenta P_i has to exclude the region $|\mathbf{p}_i - \mathbf{p}_{1,2}| \lesssim 1/r_0$ as the latter has already been included in the effective energy theory for the spin excitations, see also Figs. 2, 3.

Closing this section, we notice that the main contribution in the Kohn-Luttinger⁶⁰ scenario of the superconducting instability also originates from the region of the phase space studied in our paper. As in this region the Cooper channel intervenes the particle-hole channel, the simple use of the second order screened interaction in the Cooper channel⁶⁰ does not appear to be justified.

D. Peculiarities for one dimensional systems.

The purpose of this subsection is to find the leading singular correction to the specific heat in one-dimensional case and compare the result with the one obtained in Ref. 55 for the spin chain. The low-energy properties of the latter model are the same as for the spin dynamics for the interacting electrons.

We represent the temperature dependent part of the desired correction as [cf. Eq. (7.4)]

$$\begin{aligned} \delta\Omega_3(T) &= \sum_{l \neq 0} \int \frac{d\omega_2}{2\pi} \exp\left(-\frac{i l \omega_2}{T}\right) \\ &\quad \times [\mathbb{R}_a(\omega_2) + \mathbb{R}_b(\omega_2) + \mathbb{R}_c(\omega_2)] \\ &+ \sum_{\substack{l_1, l_2 \neq 0 \\ l_1 \neq l_2}} \iint \frac{d\omega_1 d\omega_2}{(2\pi)^2} \exp\left(\frac{i l_1 \omega_1}{T} + \frac{i l_2 \omega_2}{T}\right) \mathbb{R}_e(\omega_1, \omega_2), \end{aligned} \quad (7.39)$$

where the subscripts a, b, c, e indicate the analytic expression for the corresponding diagrams on Fig. 13.

Summation over the matrix indices is performed using the formula analogous to Eq. (5.52) with the result

$$\begin{aligned} \mathbb{R}_{a,b} &= -\frac{6}{\nu} \sum_{\sigma_{1,2}=\pm} Y^{\sigma_1 \sigma_2} \mathcal{R}_{a,b,e}^{\sigma_1 \sigma_2}(\omega_2); \\ \mathcal{R}_a^{\sigma_1 \sigma_2}(\omega_2) &= 2 \lim_{\eta_1 \rightarrow 0} \lim_{\eta_2 \rightarrow \eta_1} \int \frac{d\omega_1}{2\pi} \int \frac{dk_1 dk_2}{(2\pi)^2} \\ &\quad \times \cos(k_1 \eta_1 + k_2 \eta_2) \mathcal{R}^{\sigma_1 \sigma_2}(\omega_1, \omega_2; k_{1,2}), \\ \mathcal{R}_b^{\sigma_1 \sigma_2}(\omega_2) &= \lim_{\eta_1 \rightarrow 0} \lim_{\eta_2 \rightarrow \eta_1} \int \frac{d\omega_1}{2\pi} \int \frac{dk_1 dk_2}{(2\pi)^2} \\ &\quad \times \cos(k_1 \eta_1 + k_2 \eta_2) \mathcal{R}^{\sigma_1 \sigma_2}(\omega_2 - \omega_1, \omega_1; k_{1,2}); \\ \mathcal{R}_e^{\sigma_1 \sigma_2}(\omega_2) &= \lim_{\eta_1 \rightarrow 0} \lim_{\eta_2 \rightarrow \eta_1} \int \frac{dk_1 dk_2}{(2\pi)^2} \\ &\quad \times \cos(k_1 \eta_1 + k_2 \eta_2) \mathcal{R}^{\sigma_1 \sigma_2}(\omega_2 - \omega_1, \omega_1; k_{1,2}); \end{aligned} \quad (7.40)$$

where $Y^{\sigma_1 \sigma_2}$ depends on the interaction constants only:

$$Y^{\sigma_1 \sigma_2} = \iint_0^1 (u_1 u_2)^2 du_1 du_2 [\Delta_3^{\sigma_1 \sigma_2} \beta_3^{-\sigma_1} \beta_3^{-\sigma_2}]. \quad (7.41)$$

The most interesting factors $\mathcal{R}^{\sigma_1 \sigma_2}(\omega_1, \omega_2; k_{1,2})$ are given

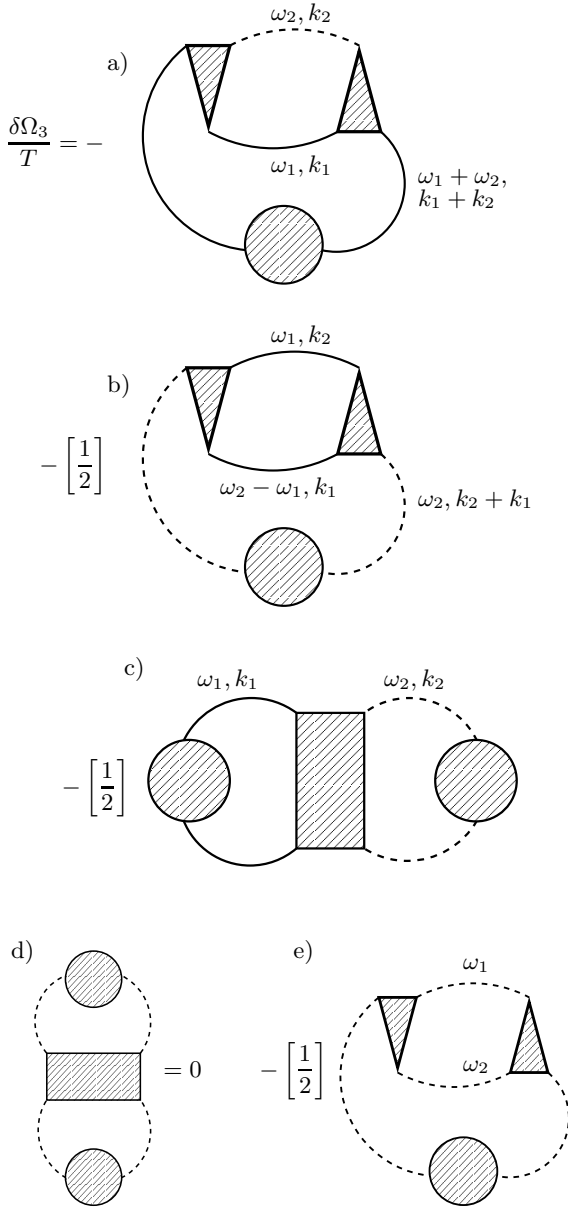

FIG. 13: Diagrams of the third order, $\delta\Omega_3(T) \propto \gamma_b^3$, giving the leading logarithmic contribution in the one-dimensional case. The notation are introduced in Sec. V, see Figs. 4 – 9. The coefficients in brackets corresponds to the number of symmetries of the diagram. The dotted line for the Green function means that the summation over the frequency of this line is performed with Eq. (7.4) replacing the summation (7.3). The solid line implies the simple integration over frequency as at $T = 0$. Diagram d) does not contribute to the specific heat.

by

$$\mathcal{R}^{++} = \frac{(i\omega_2 + k_2)(i\omega_1 - k_1)}{\mathcal{D}(\omega_{1,2}; k_{1,2})}; \quad (7.42a)$$

$$\mathcal{R}^{+-} = \frac{(i\omega_2 + k_2)[i(\omega_1 + \omega_2) - (k_2 + k_1)]}{\mathcal{D}(\omega_{1,2}; k_{1,2})}; \quad (7.42b)$$

$$\mathcal{R}^{-+} = \frac{[i(\omega_1 + \omega_2) + (k_2 + k_1)](i\omega_1 - k_1)}{\mathcal{D}(\omega_{1,2}; k_{1,2})}; \quad (7.42c)$$

$$\mathcal{R}^{--} = \frac{[i(\omega_1 + \omega_2) + (k_2 + k_1)][i(\omega_1 + \omega_2) - (k_2 + k_1)]}{\mathcal{D}(\omega_{1,2}; k_{1,2})}; \quad (7.42d)$$

$$\begin{aligned} \mathcal{D}(\omega_{1,2}; k_{1,2}) &= (i\omega_1 + v_F k_1)(i\omega_2 - v_F k_2) \\ &\quad \times [i(\omega_1 + \omega_2) - v_F(k_1 + k_2)] \\ &\quad \times [i(\omega_1 + \omega_2) + v_F(k_1 + k_2)]. \end{aligned}$$

Finally,

$$\begin{aligned} \mathbb{R}_c &= \frac{12}{\nu} \iint_0^1 du_1 du_2 (u_1 u_2)^2 \gamma_3 \Delta_3^{-+} \Delta_3^{+-} \lim_{\eta_1 \rightarrow 0} \lim_{\eta_2 \rightarrow \eta_1} \\ &\quad \times \iint \frac{dk_1 dk_2}{(2\pi)^2} \int \frac{d\omega_1}{2\pi} \frac{\cos(k_1 \eta_1 - k_2 \eta_2)}{(i\omega_1 - v_F k_1)(i\omega_2 + v_F k_2)}, \end{aligned} \quad (7.43)$$

and all the other contributions \mathbb{R}_c either vanish or produce contributions independent on ω_2 .

As usual for one-dimensional system with the linearized spectrum, the integrals (7.40), with the integrands (7.42), and Eq. (7.43) have the anomalous character: each term could be eliminated by the shifts of the momentum if such arbitrary shifts were allowed. That is why the chosen order of limits is very crucial for the complete definition of the action. In terms of the original model, it corresponds to the regularization of the singular terms $(\phi_L^\dagger(x)\phi_L(x))\phi_R^\dagger(x)$, and $(\phi_L^\dagger(x)\phi_L(x))(\phi_R^\dagger(x)\phi_R(x))$, etc. in notation of Eq. (4.10), by shifting the coordinate of the left (right) movers by $\eta_1(-\eta_2)$. Such shifts eliminate all the divergent terms.

Calculating the integrals (7.40) we find

$$\mathcal{R}_a^{++} = \mathcal{R}_b^{++} = -\frac{|\omega_2|}{2\pi v_F^2}; \quad (7.44a)$$

$$\mathcal{R}_a^{--} = \mathcal{R}_b^{--} = -\frac{|\omega_2|}{4\pi v_F^2}; \quad (7.44b)$$

$$\mathcal{R}_e^{--} = -\frac{\text{sgn}\omega_1 \text{sgn}\omega_2}{4v_F^2}; \quad \mathcal{R}_e^{++} = 0; \quad (7.44c)$$

$$\mathcal{R}_{a,b,e}^{+-} + \mathcal{R}_{a,b,e}^{-+} = \mathcal{R}_{a,b,e}^{++} + \mathcal{R}_{a,b,e}^{--}, \quad (7.44d)$$

and

$$\mathbb{R}_c = \left(\frac{|\omega_2|}{4\pi v_F^2}\right) \frac{12}{\nu} \iint_0^1 du_1 du_2 (u_1 u_2)^2 \gamma_3 \Delta_3^{-+} \Delta_3^{+-}. \quad (7.44e)$$

Substituting Eqs. (7.44) into Eq. (7.39), using Eq. (7.9), the explicit form of the coupling constants,

Eq. (6.6), $\mu_1 = 2$, $\nu = 1/(\pi v_F)$, and the formula

$$\int \int_0^1 du_1 du_2 (u_1 u_2)^2 \left[\frac{4}{(1 + x u_1 u_2)^5} - \frac{1}{(1 + x u_1 u_2)^4} \right] = \frac{1}{3(1+x)^3},$$

we find the leading logarithmical contribution to the thermodynamic potential

$$\delta\Omega_3(T) = -\frac{\pi T^2}{16v_F} \left[\frac{2\gamma_b}{1 + 2\gamma_b \ln \frac{\epsilon_F}{T}} \right]^3. \quad (7.45)$$

This correction agrees with the one previously obtained one for the spin chains (see Eq. (3.17) of Ref. 55) and we conclude that the supersymmetric low energy theory developed in this paper reproduces all of the known physical results despite the fact that the intermediate degrees of freedom apparently differ from those for the conventional bosonization.

One can also prove by the explicit calculation that there is no contribution to the specific heat proportional to $\gamma_f \gamma_b^2$. Corresponding diagrams are shown on Fig. 14.

VIII. DISCUSSION

We have considered thermodynamics of an electron gas with a repulsion in arbitrary dimensions. This model belongs to the class of systems that should manifest a Fermi liquid behavior, which implies that the temperature behavior of thermodynamic quantities is similar to the one of an ideal Fermi gas.

In order to investigate low lying excitations like spin or charge ones we developed a new method of bosonization that allows us to replace the initial electron model by a model for low lying excitations. Our approach is based on a method of quasiclassical Green functions and differs from earlier high dimensional bosonization schemes^{6,7,39-46}. In contrast to the latter approaches we can consider not only charge excitations but also spin ones. This advantage is crucial because the spin excitations are much more interesting than the charge ones. The importance of the spin excitations is seen from Eqs. (3.10a, 3.10b). In contrast to the charge excitations, the spin ones interact with each other via the fluctuational magnetic field \mathbf{h} .

Studying the low lying spin excitations we have discovered non-trivial logarithmic contributions to thermodynamic quantities originating from their interaction and succeeded in summing them using a renormalization group scheme. The logarithmic contributions come from momenta of the two excitations parallel or antiparallel to each other (forward [which does not contribute to the physical quantities studied in this paper] and backward scattering). To some extent, the system manifests one dimensional properties even if we work in two or three dimensions.

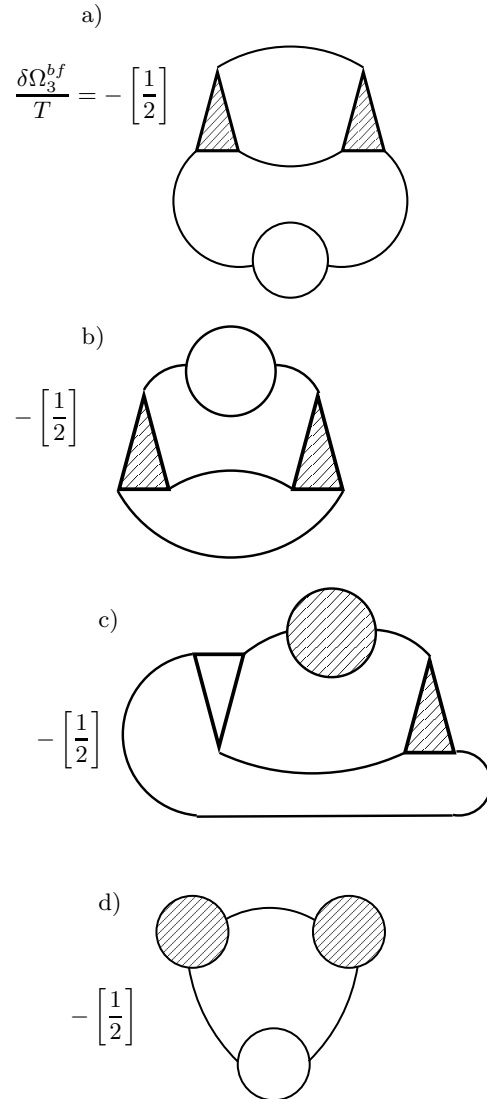

FIG. 14: Diagrams of the third order, $\delta\Omega_3^{bf}(T) \propto \gamma_b^2 \gamma_f$. Those diagrams do not contribute to the specific heat. Non-filled vertices correspond to the physical forward scattering amplitudes which are not renormalized. Diagram b) vanishes due to the supersymmetry. Diagram a) vanishes separately.

In principle, we could solve Eq. (3.10b) using a perturbation theory in the effective field \mathbf{h} . Then, substituting such a solution into Eq. (3.11) we would be able to calculate the thermodynamic quantities. However, this is not a completely safe scheme. The problem is that the linear operator acting on the variable \mathbf{S}_n is Eq. (3.10b) is not Hermitian because it contains linear derivatives in time and coordinates. It is well established^{52,56} that linear derivatives in the operators can lead to a new physics because, the non-hermitian operators may have complex eigenvalues. This problem can be avoided by the process of the hermitization⁵² and everything can be reformulated in terms of a field theory containing supervectors.

This is why we developed a supersymmetric scheme and used it for the calculations. This gives also advantages because we can demonstrate the renormalizability of the theory, which is difficult using the perturbation theory.

The method we developed is applicable also for one dimensional systems and it exactly reproduced the known result for the logarithmic correction to the specific heat. It gave us a great deal of confidence in the correctness of our procedure, However, our main interest is the higher dimensional systems and we do not intend to compete with the very well developed methods in $1d$.

Using the method of the renormalization group we calculated all relevant vertices of the theory, which allowed us to calculate the thermodynamic potential and the specific heat, Eqs. (7.37a, 7.37b). In the lowest order one neglects the interaction between the spin excitations and obtains Eqs. (7.29a, 7.29b) that have been obtained previously by conventional diagrammatic expansions (see the latest works^{18,28} and references therein). These corrections are already non-analytic in T^2 , which was the main motivation for their previous study. We see from the results obtained here that the problem is even more interesting and the temperature behavior of the thermodynamic quantities in really non-trivial.

We derived the results in the weak coupling limit and the approximations we used are justified. Although we cannot apply the results in the strong coupling limit, it is difficult to imagine that the non-trivial temperature dependence would not be relevant in that region. This can lead to complicated effects near quantum critical points.

The application of the RG scheme we developed has lead us to a very unusual result, namely, the amplitude γ_1 describing the forward scattering of the spin excita-

tions has a logarithmic pole, Eq. (6.8), and can diverge below a critical temperature. We emphasize that the appearance of this diverging vertex is a consequence of the hermitization procedure we used for the derivation of the field theory and its existence cannot be noticed using conventional diagrammatic expansions.

Very often divergencies of scattering amplitudes lead to a phase transition as, e.g., in theory of superconductivity. At the same time, the logarithmic pole in the Kondo problem does not lead to any phase transition. The situation now is even more tricky because the forward scattering amplitude does not enter the thermodynamic quantities in the perturbation theory and the RG scheme at all. Therefore, even if it diverges, this does not necessarily mean a phase transition because it may drop out from physical quantities. Clarifying this situation is the most challenging continuation of the present study.

IX. ACKNOWLEDGMENTS

We enjoyed interesting discussions with A. Chubukov, G. Schiwiete and R. Teodorescu. We are grateful to F. Essler and A.A. Nersesyan for bringing Ref. 55 to our attention. We are grateful to D. Basko, G. Catelani, A. Chubukov, L. Glazman, D. Maslov, and A. Millis for reading the manuscript and valuable remarks. K.B. Efetov is thankful to Columbia Physics Department for the kind hospitality and to grant *Transregio 12 "Symmetries and Universality in Mesoscopic Systems"* of the German Research for financial support.

-
- ¹ L.D. Landau, Zh. Eksp. Teor. Fiz. **30**, 1058 (1956) (Sov. Phys. JETP, **3**, 920 (1956)); *ibid* **32**, 59 (1957) (Sov Phys. JETP **5**, 101, (1957)).
- ² T. Timusk and B. Statt, Rep. Prog. Phys. **62**, 61 (1999).
- ³ M. Norman and C. Pepin, Rep. Prog. Phys. **66**, 1547 (2003).
- ⁴ P.W. Anderson, Phys. Rev. Lett. **66**, 3226 (1991).
- ⁵ R. Shankar, Rev. Mod. Phys. **66**, 129 (1994).
- ⁶ W. Metzner, C. Castellani and C. Di Castro, Adv. Phys. **47**, 317 (1998).
- ⁷ A. Houghton, H.-J. Kwon, and B. Marston, Adv. Phys. **49**, 141 (2000).
- ⁸ J. Kim and D. Coffey, Phys. Rev. B **62**, 4288 (2000).
- ⁹ A. Abanov, A. Chubukov, and J. Schmalian, Adv. Phys. **52**, 119 (2003).
- ¹⁰ L.D. Landau, Zh. Eksp. Teor. Fiz. **35**, 97 (1958) (Sov. Phys. JETP, **8**, 70 (1959)).
- ¹¹ A.A. Abrikosov, L.P. Gorkov, and I.E. Dzyaloshinskii, *Methods of Quantum Field Theory in Statistical Physics*, (Prentice Hall, New York, 1963).
- ¹² D. Pines and P. Nozieres, *The Theory of Quantum Liquids*, (Benjamin, New York, 1996).
- ¹³ A.L. Fetter and D. L. Walecka, *Quantum Theory of Many-Particle Systems*, (MacGraw-Hill, New York, 1971).
- ¹⁴ G. Baym and C. Pethick, *Landau Fermi liquid Theory*, (Wiley, New York, 1991).
- ¹⁵ G.M. Eliashberg, Sov. Phys. JETP **16**, 780 (1963).
- ¹⁶ S. Doniach and S. Engelsberg, Phys. Rev. **17**, 750 (1966).
- ¹⁷ W.F. Brinkman and S. Engelsberg, Phys. Rev. **169**, 417 (1968).
- ¹⁸ A.V. Chubukov, D.I. Maslov, and A. Millis, cond-mat/0509163.
- ¹⁹ D.J. Amit, J.W. Kane, and H. Wagner, Phys. Rev. **175**, 313 (1968); *ibid* **175**, 326 (1968).
- ²⁰ D. Belitz, T.R. Kirkpatrick, and T. Vojta, Phys. Rev. B **55**, 9452 (1997).
- ²¹ D. Coffey and K.S. Bedell, Phys. Rev. Lett. **71**, 1043 (1993).
- ²² A.V. Chubukov and D.L. Maslov, Phys.Rev. B **68**, 155113 (2003); *ibid* **69**, 121102 (2004).
- ²³ V.M. Galitski and S. Das Sarma, Phys. Rev. B **70**, 035111 (2004).
- ²⁴ G. Catelani and I.L. Aleiner, Zh. Exp. Teor. Fiz. **127**, 372 (2005); [JETP, **100**, 331 (2005)].
- ²⁵ M.A. Baranov, M.Yu. Kagan, and M.S. Mar'enko, JETP Lett. **58**, 709 (1993).

- ²⁶ G.Y. Chitov and A.J. Millis, Phys. Rev. Lett. **86**, 5337 (2001); Phys. Rev. **B64**, 054414 (2001).
- ²⁷ A.V. Chubukov, C. Pepin, and J. Rech, Phys. Rev. Lett. **92**, 147003 (2004).
- ²⁸ A.V. Chubukov, D.L. Maslov, S. Gangadharaiah, and L.I. Glazman, Phys. Rev. B **71**, 205112 (2005).
- ²⁹ L.P. Gorkov, A.I. Larkin, and D.E. Khmel'nitskii, Pis'ma Zh. Eksp. Teor. Fiz. **30**, 248 (1979) [Sov. Phys. JETP Lett. **30**, 228 (1979)].
- ³⁰ E. Abrahams, P.W. Anderson, and T.V. Ramakrishnan, Phil. Mag. **42**, 827 (1980).
- ³¹ F. Wegner, Z. Phys. B **35**, 207 (1979).
- ³² K.B. Efetov, Adv. in Phys., **32**, 53 (1983).
- ³³ K.B. Efetov, *Supersymmetry in Disorder and Chaos*, (Cambridge Univ. Press, New York, 1997).
- ³⁴ B. A. Muzykantskii and D. E. Khmel'nitskii, Pis'ma Zh. Eksp. Theo. Fiz. **62** 68 (1995) [JETP Lett. **62** 76 (1995)].
- ³⁵ K. B. Efetov, V. R. Kogan, Phys. Rev. B **67**, 245312 (2003).
- ³⁶ A.M. Finkel'stein, Zh. Eksp. Teor. Fiz. **84**, 168 (1983) (Sov. Phys. JETP **57**, 97 (1983)); A.M. Finkel'stein, in *Electron Liquid in Disordered Conductors*, edited by I.M. Khalatnikov, Soviet Scientific Reviews, Vol. 14 (Harwood, London, 1990).
- ³⁷ G. Schwiete and K.B. Efetov, Phys. Rev. B **71**, 134203 (2005).
- ³⁸ A. Luther, Phys. Rev. B **19**, 320 (1979).
- ³⁹ F.D.M. Haldane, Helv. Phys. Acta. **65**, 152 (1992).
- ⁴⁰ A. Houghton and J.B. Marston, Phys. Rev. B **48**, 7790 (1993); A. Houghton, H.-J. Kwon, and J.B. Marston, Phys. Rev. **B50**, 1351 (1994).
- ⁴¹ A.H. Castro Neto and E. Fradkin, Phys. Rev. Lett. **72**, 1393 (1994); Phys. Rev. B **49**, 10877 (1994).
- ⁴² P. Kopietz and K. Schönhammer, Z. Phys. **B100**, 259 (1996).
- ⁴³ P. Kopietz, *Bosonization of Interacting Fermions in Arbitrary Dimensions*, (Springer Verlag, Berlin, 1997).
- ⁴⁴ D.V. Khveshchenko, R. Hlubina, and T.M. Rice, Phys. Rev. **B48**, 10766 (1994).
- ⁴⁵ D.V. Khveshchenko, Phys. Rev. B **49**, 16893 (1994); *ibid.* **52**, 4833 (1995).
- ⁴⁶ C. Castellani, C. Di Castro, and W. Metzner, Phys. Rev. Lett. **72**, 316 (1994).
- ⁴⁷ I.E. Dzyaloshinskii and A.I. Larkin, Zh. Eksp. Teor. Fiz. **61**, 791 (1971) [Sov. Phys. JETP **34**, 422 (1972)].
- ⁴⁸ A. I Larkin and Yu. N. Ovchinnikov, Zh. Eksp. Teor. Fiz. **55**, 2262 (1968) [Sov. Phys. JETP **28**, 1200 (1969)]; *Nonequilibrium superconductivity*, (Elsevier, Amsterdam, 1984).
- ⁴⁹ G. Eilenberger, Z. Phys. **214**, 195 (1968).
- ⁵⁰ J. Schwinger, Phys. Rev. **128**, 2425 (1962).
- ⁵¹ A.O. Gogolin, A.A. Nersesyan, and A.M. Tsvelik, *Bosonization and Strongly Correlated Systems*, (Cambridge University Press, UK, 1998), Chap. 14.
- ⁵² K.B. Efetov, Phys. Rev. Lett. **79**, 491 (1997); Phys. Rev. B **56**, 9630 (1997).
- ⁵³ L.P. Gorkov, Zh. Eksp. Teor. Fiz. **34**, 735 (1958) [Sov. Phys. JETP **7**, 505 (1958)]; Y. Nambu, Phys. Rev. **117**, 648 (1960).
- ⁵⁴ F. Essler and A. A. Nersesyan, Private communications.
- ⁵⁵ S. Lukyanov, Nucl. Phys. B **522**, 533 (1998).
- ⁵⁶ N. Hatano and D. Nelson, Phys. Rev. Lett. **77**, 570 (1996)
- ⁵⁷ K.B. Efetov and I.L. Aleiner (work in progress).
- ⁵⁸ K.G. Wilson and J. Kogut, Phys. Rep. **C12**, 75 (1974).
- ⁵⁹ A.A. Abrikosov and I.M. Khalatnikov, Sov. Phys. JETP, **6**, 888 (1958).
- ⁶⁰ W. Kohn and J.M. Luttinger, Phys. Rev. Lett., **15**, 524 (1965); J.M. Luttinger, Phys. Rev., **150**. 202 (1966).