

Phase diffusion and fractional Shapiro steps in superconducting quantum point contacts

Raphaël Duprat and Alfredo Levy Yeyati

*Departamento de Física Teórica de la Materia Condensada,
Facultad de Ciencias C-V, Universidad Autónoma de Madrid, E-28049 Madrid, Spain*

(Dated: September 18, 2018)

We study the influence of classical phase diffusion on the fractional Shapiro steps in resistively shunted superconducting quantum point contacts. The problem is mapped onto a Smoluchowski equation with a time dependent potential. A numerical solution for the probability density of the phase difference between the leads gives access to the mean current and the mean voltage across the contact. Analytical solutions are derived in some limiting cases. We find that the effect of temperature is stronger on fractional than on integer steps, in accordance with preliminary experimental findings. We further extend the analysis to a more general environment including two resistances and a finite capacitance.

PACS numbers: 74.50.+r, 73.63.Rt

I. INTRODUCTION

Shapiro steps¹ in superconducting tunnel junctions are a clear evidence of the a.c. Josephson effect², *i.e.* the flow of an alternating current through the junction under a finite dc voltage. Shapiro steps appear as a consequence of the beating between an applied microwave field and this alternating current. Their observation thus provides an indirect test of the sinusoidal current-phase relation. For the case of highly transmissive junctions, like atomic size contacts, the presence of higher harmonics in the current-phase relation leads to fractional Shapiro steps³.

In contrast to conventional tunnel junctions, atomic contacts are characterized by a reduced set of conduction channels whose transmissions τ_n can take arbitrary values between 0 and 1⁴. The channel content of a given contact can be determined experimentally with high accuracy by analyzing the subgap structure of the *IV* characteristic in the superconducting state⁵. Moreover, the electromagnetic environment of the contact can be designed by means of lithographic techniques⁶. Due to all these properties atomic contacts can be considered as ideal systems to test theoretical predictions on mesoscopic electron transport under controlled conditions⁴.

Shapiro steps in a superconducting atomic contact of arbitrary transmission were analyzed in Ref. 3 within a fully microscopic approach in which an ideal voltage bias on the contact was assumed. However, a more realistic description of this phenomenon requires to take into account environmental effects, the most important being certainly the effect of phase diffusion caused by thermal noise in the circuit in which the contact is embedded.

The influence of thermal fluctuations on the current-voltage characteristics in tunnel junctions has been traditionally analyzed by means of the so-called resistively and capacitively shunted junction (RCSJ) model⁷. The starting point of this approach is to write down a Langevin equation for the phase difference across the junction^{8,9}. In this article, we generalize this model to the case of highly transmissive junctions in the presence of a mi-

crowave field in order to study the effect of temperature on fractional Shapiro steps in atomic size contacts. Our work is also motivated by experiments underway in the Quantronics group at the C.E.A. in Saclay. Their preliminary results seem to indicate that fractional steps are more affected by thermal fluctuations than the integer ones¹⁰.

This study will be based on two main assumptions: 1) the external frequencies and thus the range of voltages considered are small compared to the superconducting gap on the contact leads. This would allow us to assume an *adiabatic* response of the contact following its static current-phase relation and 2) the resistances in the circuit containing the contact are small compared to the resistance quantum so as to neglect quantum effects in our treatment. As we discuss below, low values of the shunting resistances are also necessary in order to observe well defined Shapiro steps even when thermal fluctuations are negligible.

The paper is organized as follows: In the first section we present our generalization of the RCSJ model for contacts of arbitrary transmission in the presence of microwave radiation. The second section describes how to solve the stochastic equation of the problem and shows the numerical results for the current-voltage characteristics. In the third section we discuss some limiting cases in which analytical results can be obtained. In the last section we consider a more general electromagnetic environment including two resistances and a finite capacitance and discuss its effect on the supercurrent peak in the absence of radiation. We finally present some concluding remarks.

II. THE MODEL

A. Electrical circuit

We consider the standard RCSJ model, to which we add a microwave field. The equivalent circuit is shown on

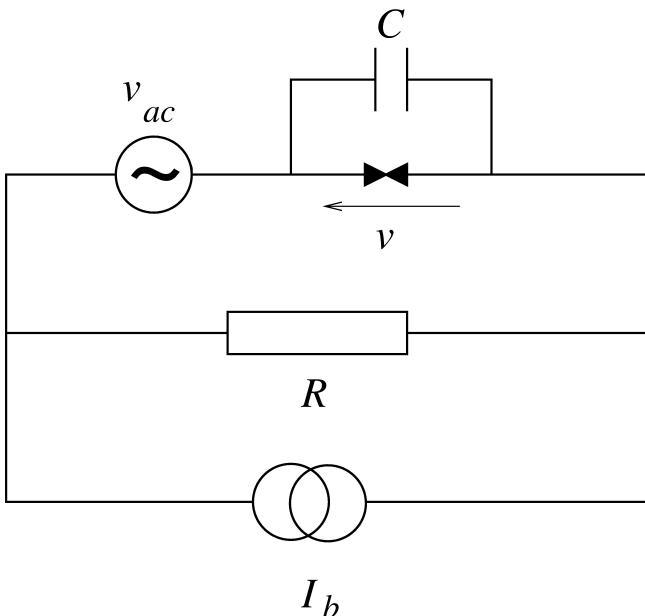

FIG. 1: Equivalent circuit of the resistively and capacitively shunted junction (RCSJ) model in presence of a microwave field $v_{ac} \cos \omega t$.

the figure 1. The parallel combination of the contact with a resistance R and a capacitance C is current polarized by a current source I_b . The microwave field introduces an additional ac voltage, v_{ac} on the branch containing the contact. We denote by θ the superconducting phase difference across the contact and by $I(\theta)$ the corresponding current-phase relation. Dissipation in the resistance will cause Johnson-Nyquist noise $L(t)$. Conservation of the current implies that

$$I_b = C \frac{dv}{dt} + I(\theta) + \frac{V}{R} + L(t), \quad (1)$$

with $V = v + v_{ac} \cos \omega t$. The voltage across the contact is related to the phase via the usual relation $v = \phi_0 \dot{\theta}$ ($\phi_0 \equiv \hbar/2e$ being the reduced flux quantum).

In order to stress the analogy with the Brownian motion of a particle in a time-dependent potential, we follow Ref. 9 and define $M \equiv \phi_0^2 C$, $p \equiv \phi_0 v C$, $\eta \equiv 1/RC$, $r(t) \equiv -\phi_0 L(t)/\eta M$ and

$$U(\theta, t) \equiv \phi_0 \theta \left[I_b - \frac{v_{ac}}{R} \cos \omega t \right] - \phi_0 \int_0^\theta I(\theta) d\theta. \quad (2)$$

The originality of this work lies in the explicit time dependence of the potential $U(\theta, t)$ and the non-trivial form of the current-phase relation $I(\theta)$ which we describe in more detail below. When the capacitance is negligible, we are in the strong damping regime $\eta p \gg \dot{p}$, and (1) takes the form of a simple Langevin equation

$$\frac{p}{M} = \frac{1}{\eta M} \frac{\partial U}{\partial \theta} + r(t). \quad (3)$$

We consider a gaussian white noise, that is

$$\langle r(t) \rangle = 0 \quad (4)$$

$$\langle r(t)r(t') \rangle = \delta(t' - t) \frac{2T}{\eta M} \quad (5)$$

$$\mathcal{P}[r(t)] = \exp \left[-\frac{\eta M}{4T} \int r^2(t) dt \right], \quad (6)$$

where we have set the Boltzmann constant equal to one. From the overdamped Langevin equation (3), one can derive a Smoluchowski equation for the probability density of the phase $\sigma(\theta, t)$ (see Ref. 12 for instance):

$$\frac{d\sigma}{dt} = \frac{1}{\eta M} \frac{\partial}{\partial \theta} \left[-\frac{\partial U}{\partial \theta} \sigma + T \frac{\partial \sigma}{\partial \theta} \right]. \quad (7)$$

Notice that the coefficients in this equation are not dependent on the contact capacitance, as expected for the strong damping regime. Floquet's theorem then tells us that its general solution has the form

$$\sigma(\theta, t) = e^{-\lambda t} \tilde{\sigma}(\theta, t) \quad (8)$$

The exponential factor represents the relaxation towards the stationary solution $\tilde{\sigma}$ with a time constant λ^{-1} . Note that in our case, owing to the time dependence of the potential U , the stationary solution oscillates in time with the external frequency ω . The characteristic frequency given by $\omega_c = RI_c/\phi_0$, where $I_c = \max[I(\theta)]$ is the critical current, can be considered as the typical relaxation rate of the system in the absence of thermal fluctuations¹¹. As it is well known for current biased tunnel junctions¹¹, the observation of well defined Shapiro steps in the IV curves requires $\omega > \omega_c$. Notice on the other hand that for the validity of the adiabatic approximation discussed in Sect. II-B we are requiring $\omega \ll \Delta_A$. In the rest of this work we will only consider stationary solutions ($\lambda = 0$) and will thus identify σ with $\tilde{\sigma}$.

B. Current-phase relation

A crucial ingredient of the model is the current-phase relation $I(\theta)$. For simplicity we consider a contact with one conduction channel of transmission $\tau \in [0, 1]$ (extension of the theory to the multichannel case is straightforward). As it is well known from the mesoscopic theory of the Josephson effect¹³ the current through the contact is carried by the so-called Andreev states with energies given by

$$\epsilon_{\pm}(\theta) = \pm \Delta_{SC} \sqrt{1 - \tau \sin^2 \frac{\theta}{2}}, \quad (9)$$

(Δ_{SC} being the superconducting gap) whose separation at $\theta = \pi$ is $\Delta_A = 2\Delta_{SC}\sqrt{1 - \tau}$. Note that this Andreev gap closes in the ballistic limit $\tau \rightarrow 1$ (figure 2). When the voltage is much smaller than the Andreev gap ($eV \ll \Delta_A$), one can assume the system to remain in the state of

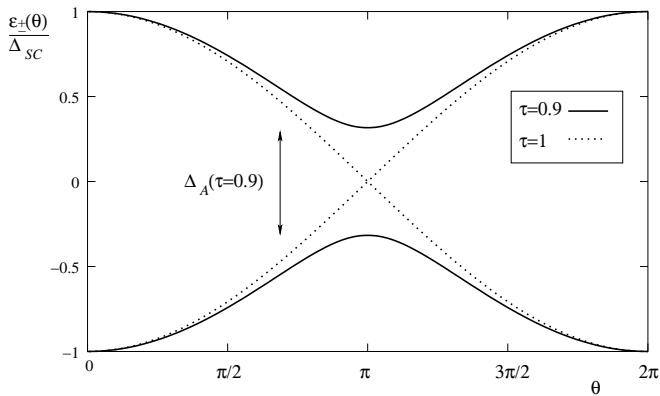

FIG. 2: Andreev levels as a function of the phase difference for $\tau = 0.9$ and $\tau = 1$.

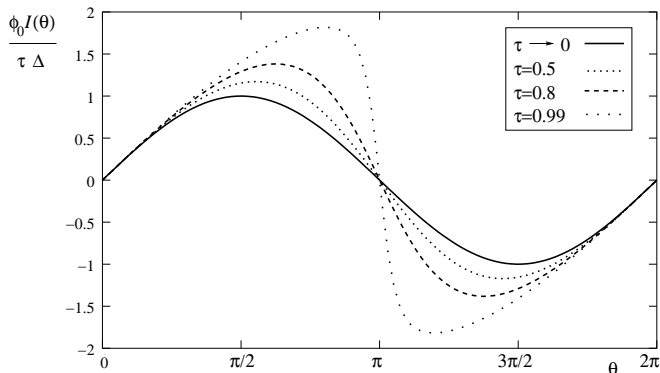

FIG. 3: Evolution of the adiabatic current-phase relation (10) with the transmission τ at zero temperature.

lowest energy (this is the *adiabatic approximation*) and obtain the following current-phase relation¹³:

$$I(\theta) = \frac{\Delta_{SC}}{4\phi_0} \frac{\tau \sin \theta}{\sqrt{1 - \tau \sin^2 \frac{\theta}{2}}} \tanh \left(\frac{\Delta_{SC}}{2T} \sqrt{1 - \tau \sin^2 \frac{\theta}{2}} \right). \quad (10)$$

When τ is small, one recovers the usual sinusoidal relation for tunnel junctions with an expression of the critical current that matches Ambegaokar-Baratoff formula¹⁴. On the other hand, when the contact is strongly transmissive the contribution of higher harmonics can no longer be neglected and the current-phase gradually approaches the $\sin(\theta/2)$ behavior characteristic of the ballistic limit (figure 3). These higher harmonics give rise to fractional Shapiro steps when a microwave field is applied.

An estimate of the size of these steps at zero temperature can be obtained assuming that the total bias voltage V remains constant. The phase evolution is then given by $\theta(t) = Vt/\phi_0 - v_{ac} \sin(\omega t)/\phi_0\omega + \theta_0$. In this limit and within the adiabatic approximation one can thus obtain an expression for the size of the fractional Shapiro steps by introducing this phase evolution into the current-phase relation (10) and performing its Fourier

decomposition. The step at $V = \phi_0\omega n/k$ is then given by¹⁵

$$I_{\frac{n}{k}} = \sum_{m=1}^{\infty} I_{m \times k} J_{m \times n}(2mk\alpha) \sin mk\theta_0 (-1)^{mn}, \quad (11)$$

where I_m denotes the harmonics in the current-phase relation, J_n are the integer order Bessel functions and $\alpha = ev_{ac}/\hbar\omega$.

When the voltage is comparable to the Andreev gap, the adiabatic approximation breaks down since one can no longer assume the system to stay in the lowest Andreev level. In the present work we shall restrict our analysis to the adiabatic approximation and concentrate on the effects of phase fluctuations in the current-voltage characteristics.

III. CURRENT-VOLTAGE CHARACTERISTICS

This section is divided into three parts. In the first one we derive the expression of the mean current and the mean voltage in terms of the solution of the Smoluchowski equation. In the second one we derive an expression for this solution in terms of a matrix continued fraction. In the third part we show the numerical results for the $I - V$ characteristics.

A. Expressions of the mean current and the mean voltage

If we define $w \equiv -\frac{1}{\eta M} [-\frac{\partial U}{\partial \theta} \sigma + T \frac{\partial \sigma}{\partial \theta}]$, we can rewrite (7) as:

$$\frac{\partial \sigma}{\partial t} + \frac{\partial w}{\partial \theta} = 0 \quad (12)$$

This equation can be seen as a conservation law for the probability (which always holds for stationary solutions). Henceforth, w is a probability current and must be given by:

$$w = \sigma \frac{d\theta}{dt} = \sigma \frac{v}{\phi_0} \quad (13)$$

Let us denote by $\overline{(\dots)}$ the mean value of a quantity with respect to the phase and $\langle \dots \rangle$ its mean value with respect to time. Our aim is to calculate the current-voltage characteristics, that is $\langle \overline{I(\theta)} \rangle$ as a function of $\langle \overline{v} \rangle$, where

$$\langle \overline{I(\theta)} \rangle = \int_0^{2\pi} d\theta \int_{-\infty}^{\infty} dt \sigma(\theta, t) I(\theta) \quad (14)$$

$$\langle \overline{v} \rangle = \phi_0 \int_0^{2\pi} d\theta \int_{-\infty}^{\infty} dt w(\theta, t). \quad (15)$$

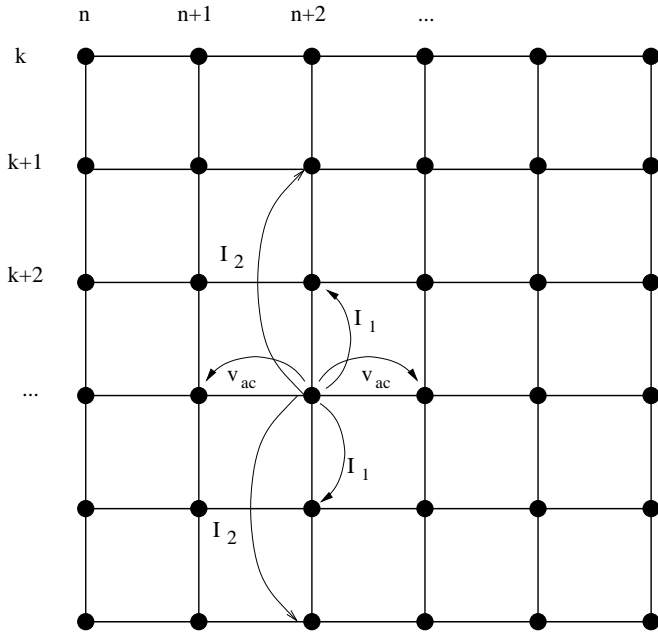

FIG. 4: Lattice representation of the Fourier-space Smoluchowski equation. The amplitude of the microwave v_{ac} couples the n -chains, while the harmonics of the current-phase relation couple the k -chains.

The Smoluchowski equation (7) is periodic in time and phase, and so must be the density $\sigma(\theta, t)$ and the probability current $w(\theta, t)$. They can thus be expanded in double Fourier series:

$$\sigma(\theta, t) = \sum_{n,k \in \mathbb{Z}} \sigma_{n,k} e^{ik\theta + in\omega t} \quad (16)$$

$$w(\theta, t) = \sum_{n,k \in \mathbb{Z}} w_{n,k} e^{ik\theta + in\omega t} . \quad (17)$$

The normalization condition for the probability density then imposes that

$$\sigma_{n,0} = \delta_{n,0}/2\pi . \quad (18)$$

In Fourier space, the Smoluchowski equation (7) reads

$$in\omega\sigma_{n,k} = \frac{1}{\eta M} \left[-k^2 T \sigma_{n,k} - ik\phi_0 I_b \sigma_{n,k} + ik\phi_0 \sum_m I_m (\sigma_{n,k-m} - \sigma_{n,k+m}) + k\phi_0 \frac{v_{ac}}{2R} (\sigma_{n+1,k} + \sigma_{n-1,k}) \right] . \quad (19)$$

It is worth noticing that this set of equations can be associated with a (non-hermitian) lattice model for particles in a square lattice. Each component of the density $\sigma_{n,k}$ can be associated with a site (n, k) in a $\mathbb{Z} \times \mathbb{Z}^*$ square lattice. The coupling between chains n and $n \pm 1$ is proportional to the ac-voltage v_{ac} , while the coupling between chains k and $k \pm m$ is proportional to the m -th harmonic of the Josephson current $I(\theta)$ (see figure 4). This analogy will be useful for deriving approximate analytical solutions as discussed in Sect. IV.

Note, on the other hand, that temperature appears in Eq. (19) with a factor k^2 . We will see later that in the limit of large ac voltage $k^2 T$ actually plays the role of an effective temperature for Shapiro steps of order n/k .

Making use of the orthogonality of circular functions, one can easily show that

$$\langle \bar{v} \rangle = 2\pi\phi_0 w_{0,0} = R \left(I_b - \sum_{k \in \mathbb{Z}} \sigma_{0,k} I_{-k} \right) \quad (20)$$

$$\langle \overline{I(\theta)} \rangle = \sum_{k \in \mathbb{Z}} \sigma_{0,k} I_{-k} . \quad (21)$$

Thus, in order to calculate the current-voltage characteristics, we only need to know the $\sigma_{0,k}$'s. A Shapiro step of order n/k in the IV characteristics is precisely due to the presence of a jump in $\sigma_{0,k}$ as a function of the bias current.

B. Recursive solution of the Smoluchowski equation

We now expose how to solve (19) numerically in order to obtain the Fourier components of the probability density.

It is convenient to introduce the vectors $\vec{\sigma}_n \equiv (\dots, \sigma_{n,2}, \sigma_{n,1}, \sigma_{n,-1}, \sigma_{n,-2}, \dots)$, $\vec{I} \equiv (\dots, I_{-2}, I_{-1}, I_1, I_2, \dots)$ and the matrices \mathbf{A}_n defined by :

$$(\mathbf{A}_n)_{kk'} \equiv \left(\frac{n\omega\eta M}{k} - ikT + \phi_0 I_b \right) \delta_{kk'} - I_m \phi_0 (\delta_{k',k-m} - \delta_{k',k+m}) . \quad (22)$$

We can then rewrite (19) in a more compact form,

$$\mathbf{A}_n \vec{\sigma}_n = \phi_0 \frac{v_{ac}}{2R} (\vec{\sigma}_{n+1} + \vec{\sigma}_{n-1}) + \delta_{n,0} \frac{\phi_0}{2\pi} \vec{I}. \quad (23)$$

From now on, we take $n > 0$, and define $\underline{n} \equiv -n$. If we define the matrices \mathbf{S}_n and $\mathbf{S}_{\underline{n}}$ by

$$\mathbf{S}_{n+1} \vec{\sigma}_n = \phi_0 \frac{v_{ac}}{2R} \vec{\sigma}_{n+1} \quad (24)$$

$$\mathbf{S}_{\underline{n+1}} \vec{\sigma}_{\underline{n}} = \phi_0 \frac{v_{ac}}{2R} \vec{\sigma}_{\underline{n+1}}, \quad (25)$$

we obtain that

$$\vec{\sigma}_0 = \left[\mathbf{A}_0 - \mathbf{S}_1 - \mathbf{S}_{\underline{1}} \right]^{-1} \frac{\phi_0}{2\pi} \vec{I}, \quad (26)$$

with

$$\mathbf{S}_{1(\underline{1})} = - \left(\frac{v_{ac}}{2R} \phi_0 \right)^2 \frac{1}{\mathbf{A}_{1(\underline{1})} - \left(\frac{v_{ac}}{2R} \phi_0 \right)^2 \frac{1}{\mathbf{A}_{2(\underline{2})} - \left(\frac{v_{ac}}{2R} \phi_0 \right)^2 \frac{1}{\mathbf{A}_{3(\underline{3})} - \dots}}. \quad (27)$$

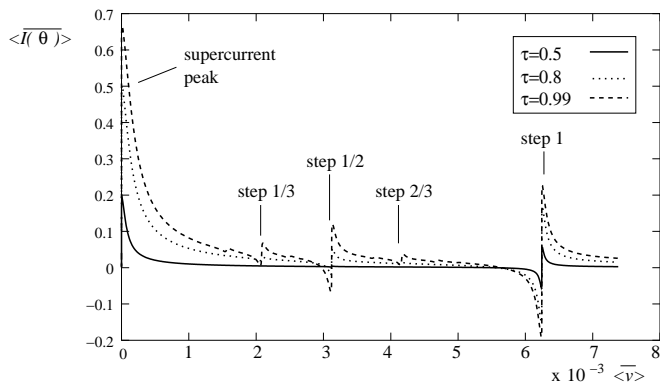

FIG. 5: Mean current as a function of the mean voltage across the contact, for three different values of the transmission and the following parameters (expressed in reduced units as indicated in the text): $R = 10^{-4}$, $T = 10^{-2}$, $v_{ac} = 4.4 \times 10^{-3}$, $\omega/2\pi = 12.5 \times 10^{-3}$.

A recursive numerical solution of this last equation enables us to find $\vec{\sigma}_0$, and thus the mean voltage $\langle \bar{v} \rangle$ and the mean current $\langle I(\theta) \rangle$. The accuracy of the results depends on the number of harmonics considered (in both, phase and time), that is on the size of the matrices (k_{max}) and the cut-off in the continued fraction (n_{max}). As the temperature is lowered and the ac voltage is increased the values of n_{max} and k_{max} required to get a good precision increase. The numerical results exposed below were obtained with $n_{max} = 100$ and $k_{max} = 50$ which were found to be sufficient to get reliable results at the lower temperatures considered.

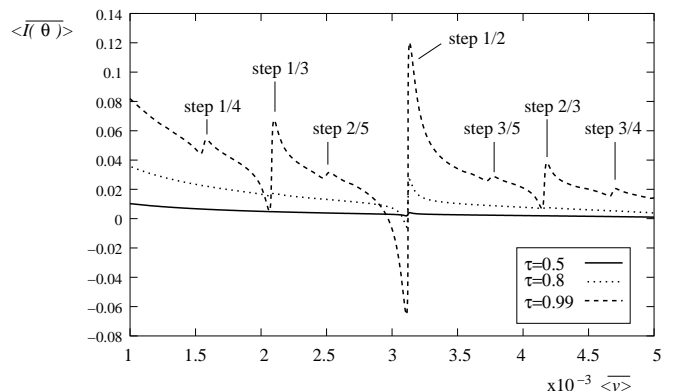

FIG. 6: Zoom of FIG. 5.

C. Numerical results

In order to illustrate the type of results that are obtained by the numerical solution of Eq. (19) we have chosen parameters which roughly correspond to a possible experiment based on Al atomic contacts¹⁰. The energy scale in such an experiment is set by the superconducting gap $\Delta_{SC} \simeq 180 \mu eV$. Typical microwave frequencies used in experiments are $\hbar\omega \sim 10^{-2} - 10^{-1} \Delta_{SC}$. On the other hand, as we stated in the introduction, the series resistance should be small compared to the resistance quantum $R_Q = h/4e^2$ in order to neglect Coulomb blockade effects at small temperatures¹⁶. Moreover, the observability of the fractional steps requires that $\omega > RI_c/\phi_0$, i.e. much larger than the typical relaxation rate in Eq. (7). As $I_c \sim \Delta_{SC}/\phi_0$, this condition implies that $R < 10^{-2} R_Q$. Figure 5 shows the current-voltage characteristics for different values of the transmission for a set of parameters chosen according to this criterium.

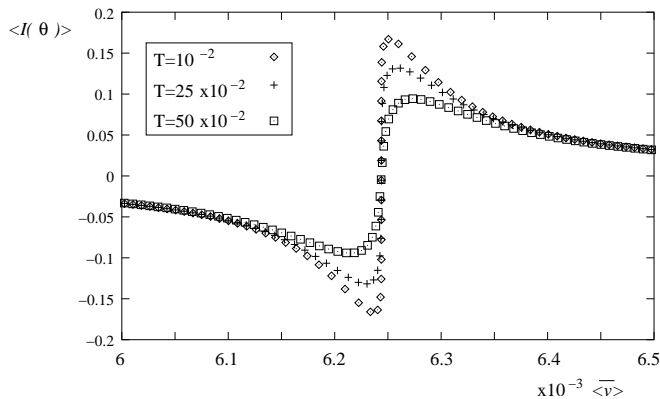

FIG. 7: Evolution of step 1 with temperature.

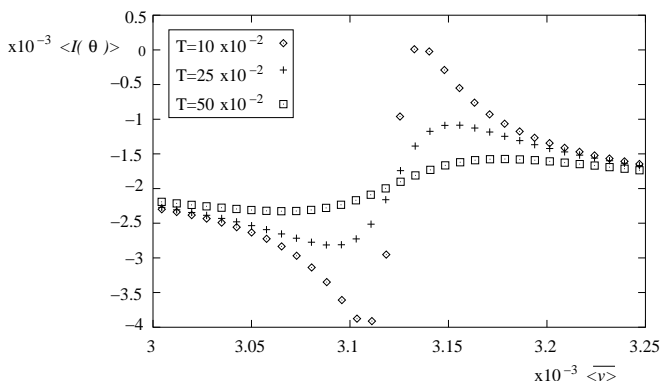

FIG. 8: Evolution of step 1/2 with temperature. The decrease of the amplitude is clearly much stronger than for step 1.

Resistance is measured in units of R_Q and all energies in units of the superconducting gap Δ_{SC} (e.g. in units of Δ_{SC}/e for the voltage and Δ_{SC}/ϕ_0 for the current). Naturally, the overall current increases with the transmission τ . As expected, additional Shapiro steps appear as τ raises. Close to perfect transmission ($\tau = 0.99$), one can clearly distinguish steps 1, 1/2, 1/3, 2/3, 1/4, 3/4, 2/5 and 3/5 (figure 6).

The temperature dependence of the I-V characteristic is illustrated in Figs. 7 and 8 showing the behavior of steps 1 and 1/2 respectively. As already anticipated, a stronger suppression is observed for the 1/2 step. We shall analyze the scaling of the fractional steps with temperature in more detail in the next section.

IV. APPROXIMATE ANALYTICAL SOLUTIONS

In the quest for analytical expressions for $\sigma(\theta)$ it is useful to have in mind the lattice representation of Eq. (19). We shall consider two limiting cases corresponding to situations in which the *vertical* (i.e. labelled by n) or *hor-*

izontal (i.e. labelled by k) chains are nearly decoupled, that is when the ac-voltage (resp., the Josephson current) is small. Notice that for the typical choice of parameters discussed in the previous section $RI(\theta) \ll v_{ac}$, which corresponds to this last case. The spirit of this approach is to decouple the n and k dependences of the Fourier components of the probability density. This decoupling will then lead to recurrence relations between the harmonics that resemble to those of Bessel and modified Bessel functions:

$$\frac{2\nu}{z} \mathcal{J}_\nu(z) = \mathcal{J}_{\nu-1}(z) + \mathcal{J}_{\nu+1}(z) \quad (28)$$

$$\frac{2\nu}{z} \mathcal{I}_\nu(z) = \mathcal{I}_{\nu-1}(z) - \mathcal{I}_{\nu+1}(z). \quad (29)$$

Like in Ref. 8, this analogy can be used to obtain analytical solutions within this weak interchain coupling approximation.

A. Limit of small ac-voltage and low transmission

Let us define $\{\lambda_k; k \in \mathbb{Z}^*\}$ as the solution of the Smoluchowski equation (19) in the absence of microwaves ($v_{ac} = \omega = 0$). In the tunnel limit $I(\theta) = I_c \sin \theta$, it obeys the equation

$$(-ikT + \phi_0 I_b) \lambda_k = \phi_0 \frac{I_c}{2i} (\lambda_{k-1} - \lambda_{k+1}). \quad (30)$$

Ivanchenko and Zil'berman⁸ found its solution by noting the analogy with the recurrence relation for modified Bessel functions $\mathcal{I}_\nu(z)$:

$$\lambda_k = \Theta(-k) \frac{\mathcal{I}_{k+i \frac{\phi_0 I_b}{T}} \left(\frac{\phi_0 I_c}{T} \right)}{\mathcal{I}_{i \frac{\phi_0 I_b}{T}} \left(\frac{\phi_0 I_c}{T} \right)} + \Theta(k) \frac{\mathcal{I}_{k-i \frac{\phi_0 I_b}{T}} \left(\frac{\phi_0 I_c}{T} \right)}{\mathcal{I}_{-i \frac{\phi_0 I_b}{T}} \left(\frac{\phi_0 I_c}{T} \right)}. \quad (31)$$

To arrive to this expression, one has to impose that the probability density is real and normalized (Θ represents the Heavyside function). If we now introduce a weak coupling v_{ac} between the n -chains, we can try the following ansatz for the Fourier components: $\sigma_{n,k} = \kappa_{n,k} \lambda_k$, with $\kappa_{n,k} \simeq \kappa_{n,k \pm 1}$. The $\kappa_{n,k}$'s are then solution of

$$\frac{2n \omega \phi_0}{k v_{ac}} \kappa_{n,k} = \kappa_{n-1,k} + \kappa_{n+1,k}. \quad (32)$$

Making use of the analogy with the recurrence relation of Bessel functions $\mathcal{J}_\nu(z)$, we obtain

$$\kappa_{n,k} \propto \mathcal{J}_n(2k\alpha). \quad (33)$$

We thus obtain a generalized expression of the Ivanchenko-Zil'berman solution for the normalized prob-

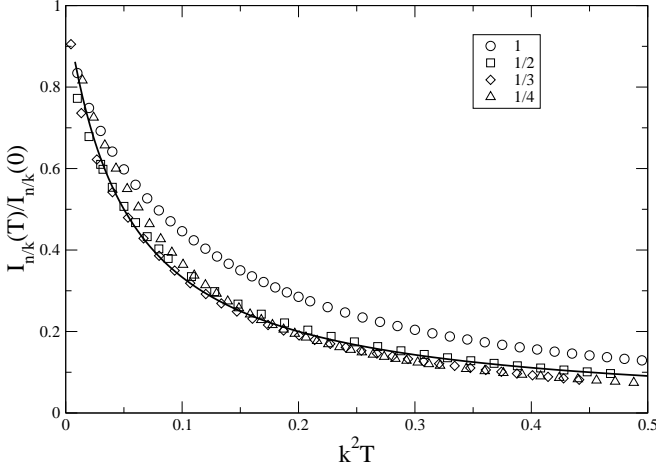

FIG. 9: Scaling of the size of Shapiro steps of order n/k with temperature for a contact with $\tau = 0.99$ at fixed $k\alpha = 2.5$ and $R = 10^{-3}$. The full line corresponds to a fit of the form $1/(1 + ak^2T)$.

ability density in the limit of small α :

$$\sigma_{n,k} = \frac{\mathcal{J}_n(2k\alpha)}{2\pi} \left[\Theta(-k) \frac{\mathcal{I}_{k+i\frac{\phi_0 I_b}{T}}\left(\frac{\phi_0 I_c}{T}\right)}{\mathcal{I}_{i\frac{\phi_0 I_b}{T}}\left(\frac{\phi_0 I_c}{T}\right)} + \Theta(k) \frac{\mathcal{I}_{k-i\frac{\phi_0 I_b}{T}}\left(\frac{\phi_0 I_c}{T}\right)}{\mathcal{I}_{-i\frac{\phi_0 I_b}{T}}\left(\frac{\phi_0 I_c}{T}\right)} \right]. \quad (34)$$

B. Limit of small Josephson current

In this limit the coupling between k chains is negligible. To zero order in the Josephson current the Fourier components of the probability density satisfy the equation

$$\left(\frac{n\omega\eta M}{k} - ikT + I_b\phi_0 \right) \sigma_{n,k}^{(0)} = \frac{v_{ac}}{2R} \phi_0 \left(\sigma_{n+1,k}^{(0)} + \sigma_{n-1,k}^{(0)} \right) \quad (35)$$

Hence $\sigma_{n,k}^{(0)}$ is simply given by $J_{n+\nu_k}(2k\alpha)/2\pi$, where $\nu_k = (-ik^2RT + kRI_b\phi_0)/(\omega\phi_0^2)$. From (20) and (21) we see that, in order to calculate the $I - V$ curves we only need $\sigma_{0,k}^{(0)}$ and that it is the only quantity involving temperature. Thus, the mean current within this approximation is given by

$$\langle I(\theta) \rangle \approx \frac{1}{2\pi} \sum_k J_{\nu_k}(2k\alpha) I_{-k}. \quad (36)$$

Within this approximation a Shapiro step of order n/k arise from the terms in $I_{\pm k}$ when $RI_b \approx n\omega\phi_0/k$. The above expression suggests that the size of the step should scale as $J_{\nu_k}(2k\alpha)$, i.e. a universal temperature behaviour should be observed when the size of the step is plotted against k^2T for fixed $k\alpha$.

This approximate scaling is illustrated in Fig. 9. As can be observed, the exact numerical results in this limit fulfil reasonably this predicted universal behavior. At large temperatures this can be well approximated by a universal function of the form $1/(1 + ak^2T)$, shown as a full line in Fig. 9. However, it should be noticed that some deviation from universality is always observed due to the finite coupling between the k -chains not included in the approximation given by Eq. (36). This deviation is more pronounced for the first Shapiro step ($k = 1$) which arises from the larger component of the current phase relation.

V. A MORE REALISTIC CIRCUIT

Neglecting the capacitance in the usual RCSJ model leads to considerable simplification of the circuit equations. However this may result in a rather crude description of the electromagnetic environment in an actual experiment. We consider in this section a more realistic circuit with two resistors and a capacitance as shown in Fig. 10. This model reduces to the previous one when $r = 0$. The presence of two resistors means that there are now two sources of thermal noise. We thus have to deal with two coupled Langevin equations:

$$C \frac{dV}{dt} = I_b - I(\theta) - \frac{V}{R} - L_R(t) \quad (37)$$

$$\phi_0 \frac{d\theta}{dt} = V - rI(\theta) - v_{ac} \cos \omega t - rL_r(t). \quad (38)$$

Using standard techniques (see Ref. 17 for instance), we can derive from them a Fokker-Planck equation for the probability density $W(\theta, V, t)$:

$$\frac{\partial W}{\partial t} = -\frac{\partial}{\partial \theta} \left[\frac{V - v_{ac} \cos \omega t - rI(\theta)}{\phi_0} W \right] - \frac{\partial}{\partial V} \left[\frac{RI_b - rI(\theta) - V}{RC} W \right] + \frac{T}{RC^2} \frac{\partial^2 W}{\partial \theta^2} + \frac{rT}{\phi_0^2} \frac{\partial^2 W}{\partial V^2}. \quad (39)$$

Setting $r = 0$ and noting that in the strong damping limit $\frac{\partial}{\partial V} = \frac{1}{\eta\phi_0} \frac{\partial}{\partial \theta}$, one easily recovers the Smoluchowski

equation (7).

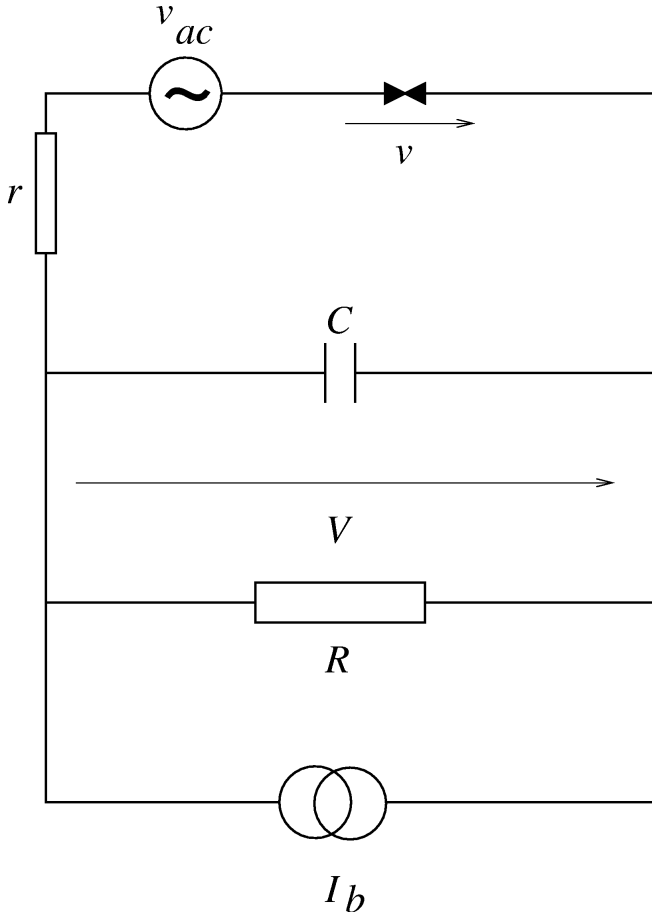

FIG. 10: Generalization of the RCSJ model.

In order to solve the Fokker-Planck equation (39), we need to find on which basis to expand the V dependent part of the distribution function W . Following Ref. 17, we split the Fokker-Planck operator in a reversible and an irreversible part, and note that the V -dependent term of the latter coincides with the Hamiltonian of a harmonic oscillator when brought to an hermitian form. This suggests to consider Hermite polynomials $H_k(z)$. More precisely, we will use the following orthonormal basis,

$$\psi_{k \in \mathbb{N}}(V) = e^{-\frac{CV^2}{4T}} H_k\left(V \sqrt{\frac{C}{2T}}\right) [k! 2^k \sqrt{2\pi MT}]^{-\frac{1}{2}}. \quad (40)$$

The distribution will then read

$$W(\theta, V, t) = \psi_0(V) \sum_{nmk} \psi_k(V) e^{in\omega t + im\theta} W_{nmk}, \quad (41)$$

and the normalization implies

$$W_{n00} = \frac{\delta_{n,0}}{2\pi}. \quad (42)$$

The expressions of the mean voltage across the resistance R and of the mean current and voltage across the contact are then

$$\langle\langle \bar{V} \rangle\rangle = \sqrt{\frac{T}{C}} W_{001} \quad (43)$$

$$\langle\langle \bar{I}(\theta) \rangle\rangle = \sum_m I_m W_{0,-m,0} \quad (44)$$

$$\langle\langle \bar{v} \rangle\rangle = \langle\langle \bar{V} \rangle\rangle - r \sum_m I_m W_{0,-m,0}, \quad (45)$$

where $\langle\langle \bar{\dots} \rangle\rangle \equiv \int \int \int dt dV d\theta (\dots)$ represents the mean value over the time, the voltage and the phase. Thus, again, the knowledge of the $n = 0$ component of the distribution is sufficient to evaluate the quantities of interest.

The irreversible part of the Fokker-Planck operator being diagonal in the basis $\{\psi_k(z); k \in \mathbb{N}\}$, we can anticipate a simple recurrence relation between the components of the distribution in the voltage sub-space, which should lead to a continued fraction of matrix continued fractions generalizing (26).

Making use of the orthogonality of circular and ψ_k functions, together with the recurrence relation for Hermite polynomials,

$$H_k(z) = 2zH_{k-1}(z) - 2(k-1)H_{k-2}(z), \quad (46)$$

we can rewrite the Fokker-Planck equation as

$$\begin{aligned} in\hbar\omega W_{n,m,k} &= A_{m,m'}^{k,k} W_{n,m',k} + A_{m,m}^{k,k+1} W_{n,m,k+1} + A_{m,m'}^{k,k-1} W_{n,m',k-1} \\ &+ imev_{ac} (W_{n+1,m,k} + W_{n-1,m,k}) \end{aligned} \quad (47)$$

where

$$\begin{aligned} A_{m,m'}^{k,k} &= -\delta_{m,m'} \left(\frac{2k}{\pi} \frac{R_Q}{R} \frac{e^2}{C} + 2\pi \frac{r}{R_Q} T m^2 \right) + \\ &(1 - \delta_{m,m'}) 2\pi i m \frac{r}{R_Q} \phi_0 I_{m-m'} \end{aligned} \quad (48)$$

$$A_{m,m'}^{k,k-1} = \delta_{m,m'} \left(2\phi_0 I_b \sqrt{\frac{e^2}{CT}} k - 2im \sqrt{\frac{e^2}{C} T k} \right) -$$

Exploiting its block-tridiagonal structure the set of equations (47) can be evaluated using a recursive algorithm similar to the one discussed in Sect. III. In order to illustrate the effect of this more complex environment

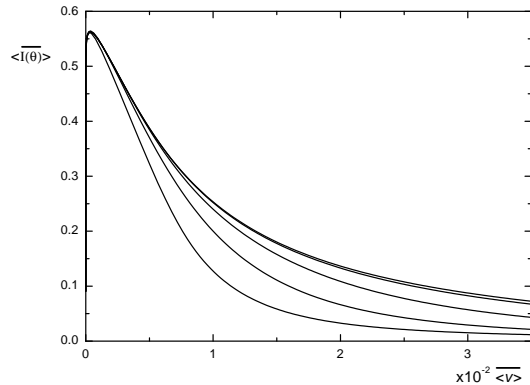

FIG. 11: Supercurrent peak for a contact with $\tau = 0.9$ in the circuit of Fig. 10 with $R = 0.001$, $r = R/10$, $T = 0.02$ and $e^2/C = 0.0001, 0.0002, 0.0004, 0.0008$ and 0.0016 from bottom to top. As can be observed the results converge to an asymptotic curve corresponding to the RSJ model.

we concentrate in the analysis of the supercurrent peak in the absence of microwaves¹⁸. Figure 11 shows the current-voltage characteristic around zero bias for a contact with $\tau = 0.9$, $r = R/10$ and different values of the capacitance in the circuit. As can be observed the width of the supercurrent peak tends to increase as the size of the capacitance is reduced. At the same time the height of the peak exhibits a slight reduction, which is almost negligible at low temperatures. The shape of the supercurrent peak approaches the one found in the standard RSJ model when $e^2/C \geq 2\pi R$.

VI. CONCLUSION

We have studied the effect of classical phase diffusion on fractional Shapiro steps in quantum point contacts.

For this purpose we have generalized the standard RCSJ model to superconducting contacts with arbitrary transmission in the presence of a microwave field. In the overdamped limit the circuit equations can be mapped into a Smoluchowski equation for the probability density of the phase difference across the contact. We have presented an efficient algorithm for the numerical evaluation of this equation. It has been shown that the fractional steps exhibit a stronger suppression with temperature than the interger ones in agreement with preliminary experimental findings¹⁰. In the limit of large microwave amplitude Shapiro steps of order n/k exhibit an approximate universal behavior as a function of an effective temperature $T_{eff} = k^2 T$ and an effective microwave parameter $\alpha_{eff} = k\alpha$. We have also considered the case of a more realistic environment including two resistances and a finite capacitance for which we derived the corresponding Fokker-Plank equation. Our numerical results indicate that the main effect of the finite capacitance is to reduce the width of the supercurrent peak. We expect that the theoretical analysis presented in this work may be useful for the proper interpretation of future experiments.

Acknowledgments

The authors would like to thank J. Ankerhold, M. Chauvin, J.C. Cuevas, D. Estève, P. Joyez, A. Martín-Rodero, P. vom Stein and C. Urbina for interesting discussions and suggestions. This work was supported by the European Union through the DIENOW Research Training Network and by the Spanish CICYT through a Picasso contract.

¹ S. Shapiro, Phys. Rev. Lett. **11**, 80 (1963).

² B. D. Josephson, Phys. Lett **1**, 251 (1962).

³ J. C. Cuevas, J. Heurich, A. Martín-Rodero, A. Levy Yeyati and G. Schön, Phys. Rev. Lett. **88**, 157001 (2002).

⁴ For a review see, N. Agraït, A. Levy Yeyati and J.M. van Ruitenbeek, Phys. Rep. **377**, 81 (2003).

⁵ E. Scheer, P. Joyez, D. Esteve, C. Urbina and M.H. Devoret, Phys. Rev. Lett., **78**, 3535 (1997); E. Scheer, N. Agraït, J.C. Cuevas, A. Levy Yeyati, B. Ludoph, A. Martín-Rodero, G. Rubio Bollinger, J.M. van Ruitenbeek and C. Urbina, Nature **394**, 154 (1998).

⁶ M. F. Goffman, R. Cron, A. Levy Yeyati, P. Joyez, M. H. Devoret, D. Esteve and C. Urbina, Phys. Rev. Lett. **85**, 170 (2000).

⁷ M. Tinkham, *Introduction to superconductivity* (McGraw-Hill, New-York, 1996).

⁸ Yu. M. Ivanchenko and L. A. Zil'berman, Sov. Phys.-JETP **28**, 1272 (1969).

⁹ V. Ambegaokar and B. I. Halperin, Phys. Rev. Lett. **22**, 1364 (1969).

¹⁰ P. Vom Stein, M. Chauvin, R. Duprat, A. Levy Yeyati, M. E. Huber, D. Esteve, and C. Urbina, to be published in *Proceedings of the Vth Rencontres de Moriond in Mesoscopic Physics*.

¹¹ P. Russer, J. Appl. Phys. **43**, 320 (1972); C. Vanneste et al, Phys. Rev. B **31**, 4230 (1985).

¹² F. Schwabl, *Statistical mechanics*, (Springer, Berlin, 2002).

¹³ C.W.J. Beenakker in *Proceedings of the 14th Taniguchi International Symposium on Transport Phenomena in Mesoscopic Systems*, edited by H. Fukuyama and T. Ando (Springer-Verlag, Berlin, 1992), p. 235.

¹⁴ V. Ambegaokar and A. Baratoff, Phys. Rev. Lett. **10**, 486,

(1963).

¹⁵ B. Carvello and C. Urbina, unpublished.

¹⁶ See for instance G.-L. Ingold and Yu.V. Nazarov in *Single Charge Tunneling*, edited by H. Grabert and M.N. Devoret (Plenum Press, New York, 1992).

¹⁷ H. Risken, *The Fokker-Planck equation* (Springer-Verlag,

Berlin 1989).

¹⁸ For the Shapiro steps we expect a qualitatively similar effect due to the finite capacitance as for the supercurrent peak.