

Off equilibrium fluctuations in a polymer glass.

L. Buisson, S. Ciliberto

Ecole Normale Supérieure de Lyon, Laboratoire de Physique ,
C.N.R.S. UMR5672,
46, Allée d'Italie, 69364 Lyon Cedex 07, France

June 17, 2018

Abstract

The fluctuation-dissipation relation (FDR) is measured on the dielectric properties of a polymer glass (polycarbonate). It is observed that the fluctuation dissipation theorem is strongly violated after a quench from above to below the glass transition temperature. The amplitude and the persistence time of this violation are decreasing functions of frequency. Around $1Hz$ it may persist for several hours. The origin of this violation is a highly intermittent dynamics characterized by large fluctuations and strongly non-Gaussian statistics. The intermittent dynamics depends on the quenching rate and it disappears after slow quenches. The relevance of these results for recent models of aging are discussed.

PACS: 75.10.Nr, 77.22Gm, 64.70Pf, 05.20-y.

1 Introduction

Glasses are materials that play an important role in many industrial and natural processes. One of the most puzzling properties of these materials is the very slow relaxation towards equilibrium, named aging, that presents an interesting and unusual phenomenology. More specifically when a glassy system is quenched from above to below the glass transition temperature T_g any response function of the material depends on the time t_w elapsed from the quench[1]. For obvious reasons related to industrial applications, aging has been mainly characterized by the study of the slow time evolution of response functions, such as the dielectric and elastic properties of these materials. It has been observed that these systems may present very complex effects, such as memory and rejuvenation[1, 2, 3, 4], in other words their physical properties depend on the thermal history of the sample. Many models and theories have been constructed in order to explain the observed phenomenology, which is not yet completely understood. These models either predict or assume very different dynamical behaviours of the systems during aging. These dynamical behaviours can be directly related

to the thermal noise features of these aging systems and the study of response functions alone is unable to give definitive answers on the models that are the most adapted to explain the aging of a specific material. Thus it is important to associate the measure of thermal noise to that of response functions. The measurement of fluctuations is also related to another important aspect of aging dynamics, that is the definition of an effective temperature in these systems which are weakly, but durably, out of equilibrium. Indeed recent theories[5] based on the description of spin glasses by a mean field approach proposed to extend the concept of temperature using a Fluctuation Dissipation Relation (FDR) which generalizes the Fluctuation Dissipation Theorem (FDT) for a weakly out of equilibrium system (for a review see Ref.[6, 7, 8]).

For all of these reasons, in recent years, the study of the thermal noise of aging materials has received a growing interest. However in spite of the large amount of theoretical studies there are only a few experiments dedicated to this problem [9]-[18]. The available experimental results are in some way in contradiction and they are unable to give definitive answers. Therefore new experiments are necessary to increase our knowledge on the thermal noise properties of the aging materials.

We present in this paper measurements of the dielectric susceptibility and of the polarization noise, in the range $20mHz - 100Hz$, of a polymer glass: polycarbonate. These results demonstrate the appearance of a strong intermittency of the noise when this material is quickly quenched from the molten state to below its glass-transition temperature. This intermittency produces a strong violation of the FDT at very low frequency. The violation is a decreasing function of the time and of the frequency and it is observed at $\omega t_w \gg 1$ and it may last for more than $3h$ for $f > 1Hz$. We have also observed that the intermittency is a function of the cooling rate of the sample and it almost disappears after a slow quench. In this case the violation of FDT remains but it is very small.

The paper is organized in the following way. In section 2 we describe the experimental set up and the measurement procedure. In section 3 we report the results of the noise and response measurements. The statistical analysis of the noise is performed in section 4. In section 5 the dependence on the quench speed of the FDT violation is discussed. The temporal behaviour of the effective temperature after a slow quench is described in section 6. In section 7 we first compare the experimental results with the theoretical ones before concluding.

2 Experimental setup

The polymer used in this investigation is Makrofol DE 1-1 C, a bisphenol A polycarbonate, with $T_g \simeq 419K$, produced by Bayer in form of foils. We have chosen this material because it has a wide temperature range of strong aging[1] (see appendix). This polymer is totally amorphous: there is no evidence of crystallinity[19]. Nevertheless, the internal structure of polycarbonate changes and relaxes as a result of a change in the chain conformation by molecular motions[1],[20],[21]. Many studies of the dielectric susceptibility of this material exist, but none had an interest on the problem of noise measurements.

In our experiment polycarbonate is used as the dielectric of a capacitor. The capacitor is composed by 14 cylindrical capacitors in parallel in order to reduce the resistance of the

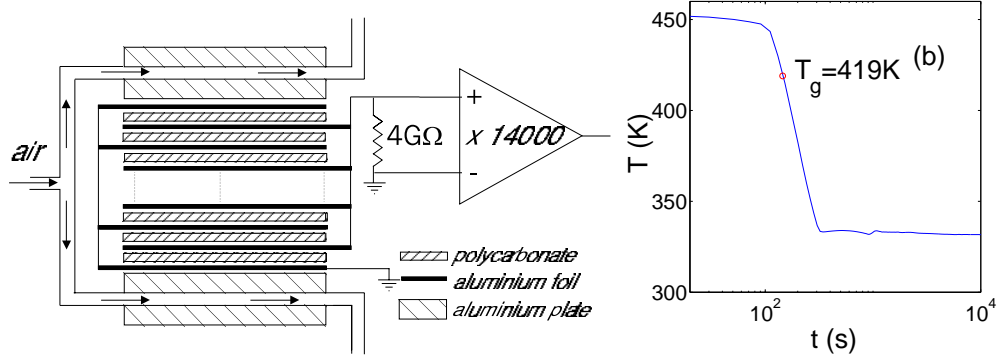

Figure 1: **Polycarbonate experimental set-up**(a) Design of polycarbonate capacitance cell. (b) Typical temperature quench: from $T_i = 453 K$ to $T_f = 333 K$, the origin of t_w is set at $T = T_g$.

sample and to increase its capacity (see appendix). Each capacitor is made of two aluminum electrodes, $12\mu m$ thick, and by a disk of polycarbonate of diameter $12cm$ and thickness $125\mu m$. The experimental set-up is shown in Fig. 1(a). The 14 capacitors are sandwiched together and put inside two thick aluminum plates which contain an air circulation used to regulate the sample temperature. This mechanical design of the capacitor is very stable and gives very reproducible results even after many temperature quenches. The capacitor is inside 4 Faraday screens to insulate it from external noise. The temperature of the sample is controlled within a few percent. Fast quench of about $1K/s$ are obtained by injecting Nitrogen vapor in the air circulation of the aluminum plates. The electrical impedance of the capacitor is $Z(\omega, t_w) = R/(1 + i\omega R C)$, where C is the capacitance and R is a parallel resistance which accounts for the complex dielectric susceptibility. This is measured by a lock-in amplifier associated with an impedance adapter (see appendix). The noise spectrum $S_Z(\omega, t_w)$ of the impedance $Z(\omega, t_w)$ is:

$$S_Z(f, t_w) = 4 k_B T_{eff}(f, t_w) Re[Z(\omega, t_w)] = \frac{4 k_B T_{eff}(f, t_w) R}{1 + (\omega R C)^2} \quad (1)$$

where k_B is the Boltzmann constant and T_{eff} is the effective temperature of the sample. This effective temperature takes into account the fact that FDT(Nyquist relation for electric noise) can be violated because the polymer is out of equilibrium during aging, and in general $T_{eff} > T$, with T the temperature of the thermal bath. Of course when FDT is satisfied then $T_{eff} = T$. In order to measure $S_Z(f, t_w)$, we have made a differential amplifier based on selected low noise JFET(2N6453 InterFET Corporation), whose input has been polarized by a resistance $R_i = 4G\Omega$. Above $2Hz$, the input voltage noise of this amplifier is $5nV/\sqrt{Hz}$ and the input current noise is about $1fA/\sqrt{Hz}$. The output signal of the amplifier is directly acquired by a NI4462 card. It is easy to show that the measured spectrum at the amplifier input is:

$$S_V(f, t_w) = \frac{4 k_B R R_i (T_{eff}(f, t_w) R_i + T_R R + S_\xi(f) R R_i)}{(R + R_i)^2 + (\omega R R_i C)^2} + S_\eta(f) \quad (2)$$

where T_R is the temperature of R_i and S_η and S_ξ are respectively the voltage and the current noise spectra of the amplifier. In order to reach the desired statistical accuracy of $S_V(f, t_w)$, we averaged the results of many experiments. In each of these experiments the sample is first heated to $T_i = 1.08T_g$. It is maintained at this temperature for several hours in order to reinitialize its thermal history. Then it is quenched from T_i to the working final temperature T_f where the aging properties are studied. The maximum quenching rate from T_i to T_f is $1K/s$. A typical thermal history of a fast quench is shown in Fig. 1(b). The reproducibility of the capacitor impedance, during this thermal cycle is always better than 1%. The origin of aging time t_w is the instant when the capacitor temperature is at $T_g \simeq 419K$, which of course may depend on the cooling rate. However adjustment of T_g of a few degrees will shift the time axis by at most $30s$, without affecting our results.

3 Response and noise measurements

Before discussing the time evolution of the dielectric properties and of the thermal noise at T_f we show in Fig. 2 the dependence of R and C measured at $1Hz$ as a function of temperature, which is ramped as a function of time as indicated in the inset of Fig. 2(a). We notice a strong hysteresis between cooling and heating. In the figure T_α is the temperature of the α relaxation at $1Hz$. The other circles on the curve indicate the T_f where the aging has been studied. We have performed measurements at $T_f = 0.79T_g, 0.93T_g, 0.98T_g$ using fast and slow quenches. The cooling rate is $1K/s$ and $0.06K/s$ for the fast and slow quenches respectively. As at $T_f = 0.98T_g$ the dielectric constant strongly depends on temperature (see Fig.2), the temperature stability has to be much better at $0.98T_g$ than at the two other smaller T_f . Because of this good temperature stability needed at $T_f = 0.98T_g$ it is impossible to reach this temperature too fast. Therefore at $0.98 T_g$ we have performed only measurements after a slow quench.

We first describe the results after a fast quench at the smallest temperature, that is $T_f = 0.79T_g$. In Fig. 3(a) and (b), we plot the measured values of R and C as a function of f at $T_i = 1.08T_g$ and at T_f for $t_w \geq 200s$. The dependence of R , at $1Hz$, as a function of time is shown in Fig. 3(c). We see that the time evolution of R is logarithmic in time for $t > 300s$ and that the aging is not very large at $T_f = 0.79T_g$, it is only 10% in 3 hours. At higher temperature close to T_g aging is much larger.

Looking at Fig. 3(a) and (b), we see that lowering temperature R increases and C decreases. As at $0.79T_g$ aging is small and extremely slow for $t_w > 200s$ the impedance can be considered constant without affecting our results. From the data plotted in Fig. 3 (a) and (b) one finds that $R = 10^{10}(1 \pm 0.05) f^{-1.05 \pm 0.01} \Omega$ and $C = (21.5 \pm 0.05)nF$. In Fig. 3(a) we also plot the total resistance at the amplifier input which is the parallel of the capacitor impedance with R_i . We see that at T_f the input impedance of the amplifier is negligible for $f > 10Hz$, whereas it has to be taken into account at slower frequencies.

Fig. 4(a) represents the evolution of $S_V(f, t_w)$ after the fast quench. Each spectrum is obtained as an average in a time window starting at t_w . The time window increases with t_w to reduce the statistical errors for large t_w . The results of 7 quenches have been averaged. At the longest time ($t_w = 1 \text{ day}$) the equilibrium FDT prediction (continuous line) is quite well satisfied. We clearly see that FDT is strongly violated for all frequencies

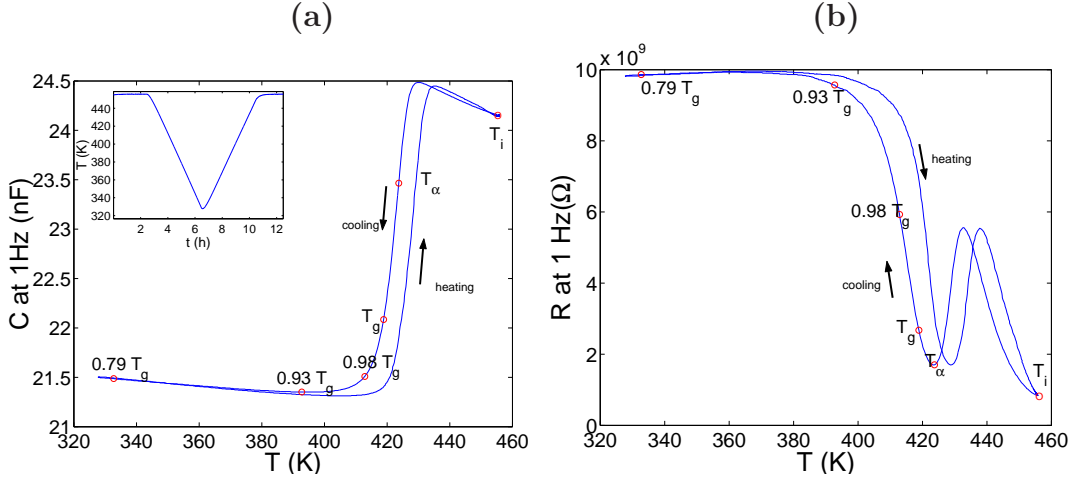

Figure 2: **Polycarbonate response function at 1Hz**(a) Dependence of C , measured at $1Hz$, on temperature, when T is changed as function of time as indicated in the inset. (b) Dependence of R , measured at $1Hz$, on T . T_α is the temperature of the α relaxation at $1Hz$, T_g is the glass transition temperature. The other circles on the curve indicate the T_f where aging has been studied.

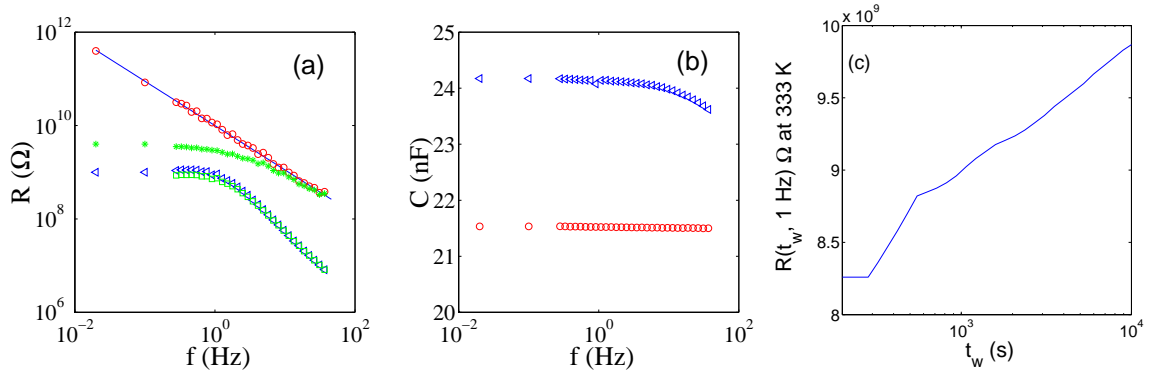

Figure 3: **Polycarbonate response function**(a) Polycarbonate resistance R as a function of frequency measured at $T_i = 1.08T_g$ (\triangleleft) and at $T_f = 0.79T_g$ (\circ)(after a fast quench). The effect of the $4G\Omega$ input resistance in parallel with the polycarbonate impedance is also shown at $T_i = 433K$ (\square) and at $T_f = 333K$ ($*$). (b) Polycarbonate capacitance versus frequency measured at $T_i = 433K$ (\triangleleft) and at $T_f = 333K$ (\circ). (c) Typical aging of R measured at $1Hz$ as a function of t_w

at short times. Then high frequencies relax on the FDT, but there is a persistence of the violation for lower frequencies. The amount of the violation can be estimated by the best fit of $T_{eff}(f, t_w)$ in eq.2 where all other parameters are known. We started at very large t_w when the system is relaxed and $T_{eff} = T$ for all frequencies. Inserting the values in eq.2 and using the S_V measured at $t_w = 1day$ we find that, within error bars, $T_{eff} \simeq 333K$ for all frequencies (see Fig. 4b). At short t_w data show that $T_{eff}(f, t_w) \simeq T_f$ for f larger than a

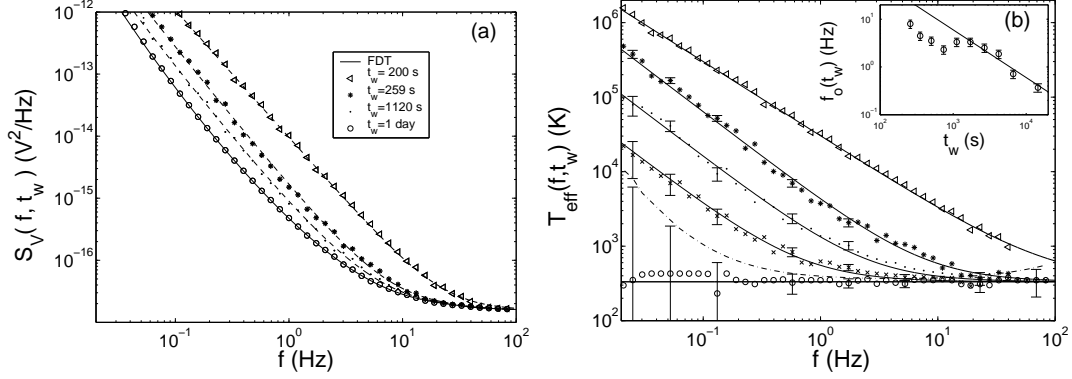

Figure 4: **Voltage noise and effective temperature in polycarbonate after a fast quench**(a) Noise power spectral density $S_V(f, t_w)$ measured at $T_f = 0.79T_g$ and different t_w . The spectra are the average over seven quenches. The continuous line is the FDT prediction. Dashed lines are the fit obtained using eq.2 and eq.3 (see text for details). (b) Effective temperature vs frequency at $T_f = 0.79T_g$ for different aging times: (\triangleleft) $t_w = 200$ s, ($*$) $t_w = 260$ s, \bullet $t_w = 2580$ s, (\times) $t_w = 6542$ s, (\circ) $t_w = 1$ day. The continuous lines are the fits obtained using eq.3. The horizontal straight line is the FDT prediction. The dot dashed line corresponds to the limit where the FDT violation can be detected. In the inset the frequency $f_o(t_w)$, defined in eq.3, is plotted as a function of t_w . The continuous line is not a fit, but it corresponds to $f_o(t_w) \propto 1/t_w$.

cutoff frequency $f_o(t_w)$ which is a function of t_w . In contrast, for $f < f_o(t_w)$ we find that T_{eff} is: $T_{eff}(f, t_w) \propto f^{-A(t_w)}$, with $A(t_w) \simeq 1$. This frequency dependence of $T_{eff}(f, t_w)$ is quite well approximated by

$$T_{eff}(f, t_w) = T_f \left[1 + \left(\frac{f}{f_o(t_w)} \right)^{-A(t_w)} \right] \quad (3)$$

where $A(t_w)$ and $f_o(t_w)$ are the fitting parameters. We find that $1 < A(t_w) < 1.2$ for all the data set. Furthermore for $t_w \geq 250$, it is enough to keep $A(t_w) = 1.2$ to fit the data within error bars. For $t_w < 250$ s we fixed $A(t_w) = 1$. Thus the only free parameter in eq.3 is $f_o(t_w)$. The continuous lines in Fig. 4(a) are the best fits of S_V found inserting eq.3 in eq.2.

In Fig. 4(b) we plot the estimated $T_{eff}(f, t_w)$ as a function of frequency at different t_w . We see that just after the quench $T_{eff}(f, t_w)$ is much larger than T_f in all the frequency interval. High frequencies rapidly decay towards the FDT prediction whereas at the smallest frequencies $T_{eff} \simeq 10^5 K$. Moreover we notice that low frequencies decay more slowly than high frequencies and that the evolution of $T_{eff}(f, t_w)$ towards the equilibrium value is very slow. From the data of Fig. 4(b) and eq.3, it is easy to see that $T_{eff}(f, t_w)$ can be superposed onto a master curve by plotting them as a function of $f/f_o(t_w)$. The function $f_o(t_w)$ is a decreasing function of t_w , but the dependence is not a simple one, as it can be seen in the inset of Fig. 4(b). The continuous straight line is not fit, it represents $f_o(t_w) \propto 1/t_w$ which seems a reasonable approximation for these data for $t > 1000$ s. For $t_w > 10^4$ s we find the $f_o < 1$ Hz. Thus we cannot follow the evolution of T_{eff} anymore because the contribution

of the experimental noise on S_V is too big, as it is shown in Fig. 4(b) by the increasing of the error bars for $t_w = 1 \text{ day}$ and $f < 0.1 \text{ Hz}$.

We do not show the same data analysis for the other working temperature after a fast quench, because the same scenario appears in the range $0.79T_g < T < 0.93T_g$, where the low frequency dielectric properties are almost temperature independent (see Fig. 2(b)). The only important difference to mention here is that aging becomes faster and more pronounced as the temperature increases. At $T_f = 0.93T_g$, the losses of the capacitor change of about 50% in about $3h$, but all the spectral analysis performed after a fast quench gives the same evolution. We can just notice that T_{eff} for $T = 0.93T_g$ is higher than that at $T = 0.79T_g$. At $T = 0.93T_g$, T_{eff} is well fitted by eq.3. It is enough to keep $A(t_w) = 1$ for all t_w and $f_o(t_w) \sim 1/t_w^{1.5}$, see Fig.5a). We notice that at $0.93T_g$ the power law behaviour is well established, whereas it was more doubtful at $0.73T_g$. The dependence of T_{eff} as a function of t_w is plotted in Fig.5 for two values of f and has also a power law dependence on t_w .

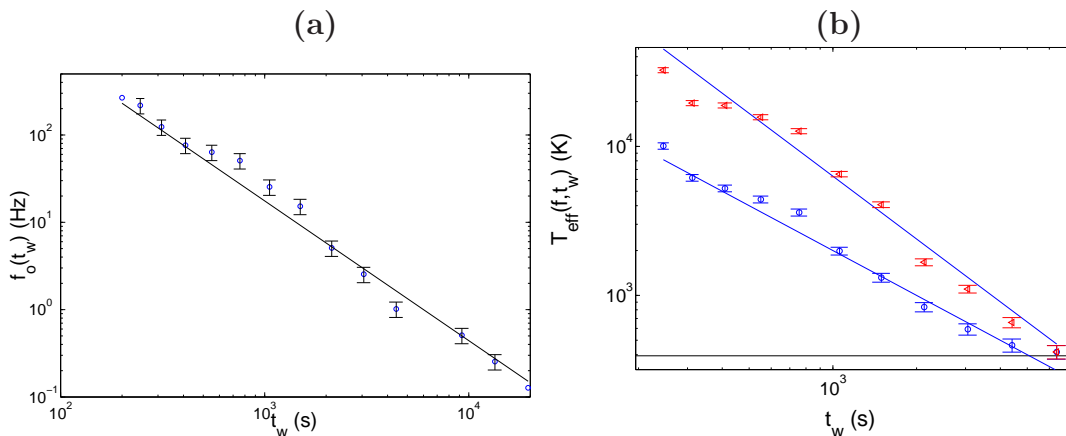

Figure 5: f_o and T_{eff} as a function of t_w at $T_f = 0.93T_g$ after a fast quench. (a) f_o defined in eq.3 as a function of t_w (b) Evolution of T_{eff} at two different frequencies (\circ) 7 Hz and (\triangleleft) 2 Hz

For $T > 0.93T_g$ fast quenches cannot be performed for the technical reasons mentioned at the beginning of section 3). The results are indeed quite different. Thus we will not consider, for the moment, the measurement at $T_f = 0.98T_g$ and we will mainly focus on the measurements done in the range $0.79T_g < T < 0.93T_g$ with fast quenches. For these measurements the spectral analysis on the noise signal indicates that Nyquist relation (FDT) is strongly violated for a long time after the quench. The question is now to understand the reasons of this violation.

4 Statistical analysis of the noise

In order to understand the origin of such large deviations in our experiment we have analyzed the noise signal. We find that the signal is characterized by large intermittent events which produce low frequency spectra proportional to $f^{-\alpha}$ with $\alpha \simeq 2$. Two typical signals recorded

at $T_f = 0.79T_g$ for $1500\text{ s} < t_w < 1900\text{ s}$ and $t_w > 75000\text{ s}$ are plotted in Fig. 6. We clearly see that in the signal recorded for $1500\text{ s} < t_w < 1900\text{ s}$ there are very large bursts which are the origin of the frequency spectra discussed in the previous section. In contrast in the signal (Fig. 6b), which was recorded at $t_w > 75000\text{ s}$ when FDT is not violated, the bursts are totally disappeared.

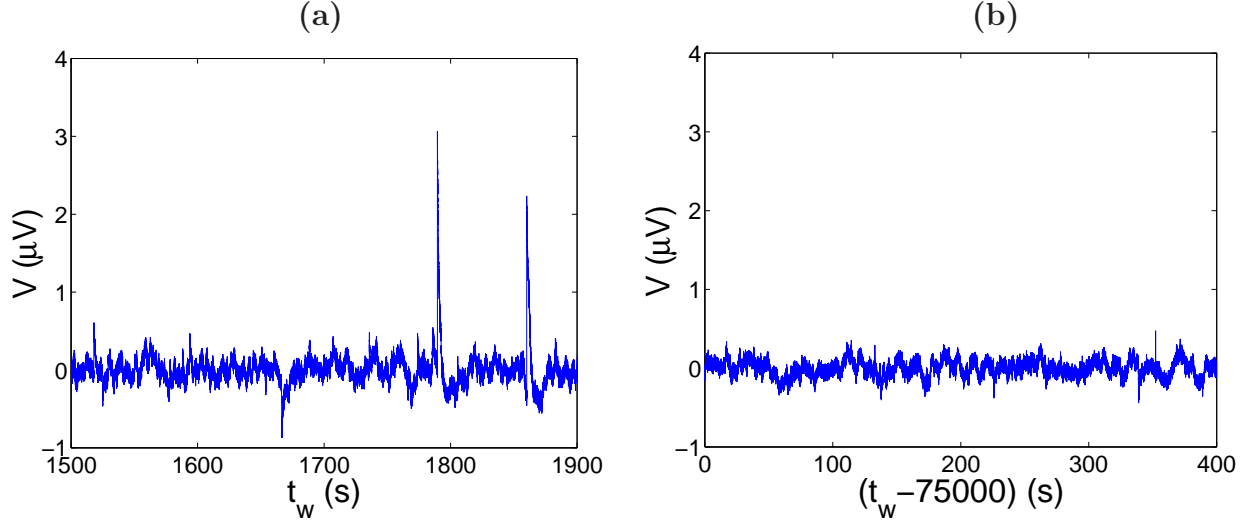

Figure 6: **Noise signal in polycarbonate after a fast quench** Typical noise signal of polycarbonate measured at $T_f = 0.79T_g$ for $1500\text{ s} < t_w < 1900\text{ s}$ (a) and $t_w > 75000\text{ s}$ (b)

The probability density function (PDF) of these signals is shown in Fig. 7 (a). We clearly see that the PDF, measured at small t_w , has very high tails which becomes smaller and smaller at large t_w . Finally the Gaussian profiles is recovered after 24 h . The PDF are very symmetric in their gaussian parts, *i.e.* 3 standard deviations. The tails of the PDF are exponential and are a decreasing function of t_w .

The time interval τ between two successive pulses is power law distributed. In order to study the distribution $\Psi(\tau, t_w)$ of τ , we have first selected the signal fluctuations with amplitude larger than a fixed threshold, which has been chosen between 3 and 4 standard deviations of the equilibrium noise, *i.e.* the noise predicted by the FDT. We have then measured the time intervals τ between two successive large fluctuations. The histograms $\Psi(\tau, t_w)$ computed for $t_w < 20\text{ min}$ and for $20\text{ min} < t_w < 3\text{ h}$ are plotted in Fig.8. We clearly see that $\Psi(\tau, t_w)$ is a power law, specifically $\Psi(\tau) \propto \frac{1}{\tau^{1+\mu}}$ with $\mu \simeq 0.4 \pm 0.1$. These results agree with one of the hypothesis of the trap model[23]-[22], which presents non-trivial violation of FDT associated to an intermittent dynamics. In the trap model τ is a power-law-distributed quantity with an exponent $1+\mu$ that, in the glass phase, is smaller than 2. However, there are important differences between the dynamics of our system and that of the trap model, which presents short and large τ for any t_w . This property is in contrast with those of our system where the probability of finding short τ decreases as a function of t_w . However this reduction could be partially induced by the threshold imposed to detect the intermittent bursts which may be lost if they are too small. The burst amplitude decreases

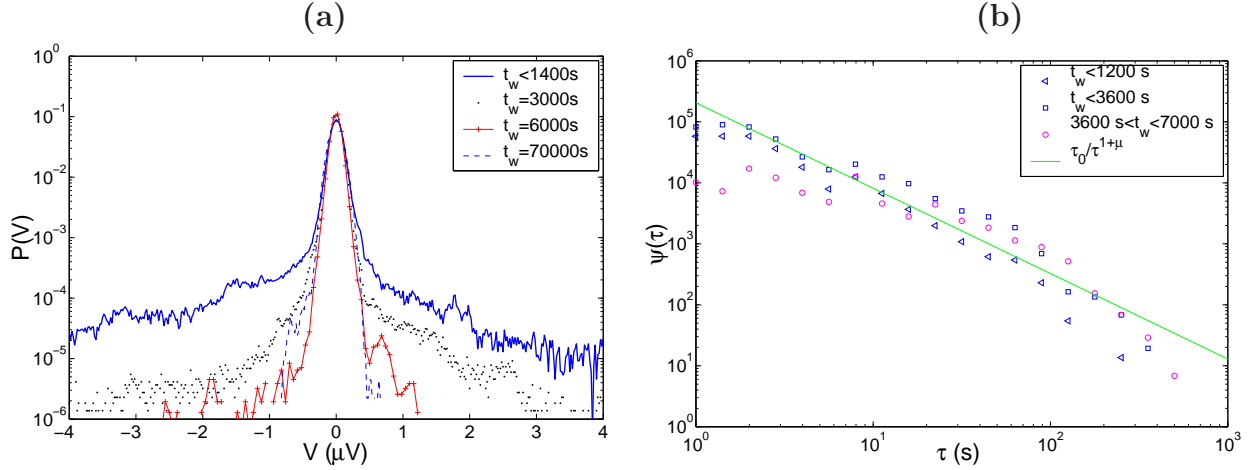

Figure 7: **PDF of the noise in polycarbonate after a fast quench at $T_f = 0.79T_g$.** (a) The large tails of the PDF at early t_w are a signature of strong intermittency. (b) Histogram of time interval τ between two successive pulses: $\Psi(\tau, t_w)$. At early t_w , $\Psi(\tau, t_w)$ is power law distributed.

as a function of t_w and there is no direct correlation between the τ and the amplitude of the associated bursts. Finally, the maximum distance τ_{max} between two successive pulses grows as a function of t_w logarithmically, that is $\tau_{max} = [10 + 152\log(t_w/300)]s$ for $t_w > 300s$. This slow relaxation of the number of events per unit of time shows that the intermittency is related to aging.

The same behaviour is observed at $T_f = 0.93T_g$ after a fast quench. The PDF of the signals measured at $T_f = 0.93T_g$ are shown in Fig. 8(a). They look very similar to those at $T_f = 0.79T_g$ (see Fig. 7), but the relaxation rate towards the Gaussian distribution is faster in this case, because the aging effects are larger at this temperature. From these measurements one concludes that after a fast quench the electrical thermal noise is strongly intermittent and non-Gaussian. The number of intermittent events increases with the temperature : for $T_f = 0.93T_g$, T_{eff} is higher than for $T_f = 0.79T_g$ and PDF tails are more important. The histograms $\Psi(\tau, t_w)$ are shown Fig. 8 (b). They have a power law dependence as those at $0.79T_g$ but $\mu = 0.93$ at this temperature. By comparing $\Psi(\tau, t_w)$ for short τ and short t_w there are more events at $0.93T_g$ (Fig. 8 (b)) than at $0.79T_g$ (Fig. 7 (b)). This is consistent with an activation processes for the aging dynamics. Indeed the probability of jumping from a potential well to another increases with temperature. Thus one expects to find more events at high temperature than at low temperature.

Another kind of statistical analysis, proposed in ref.[35, 36], can be performed on the time interval τ . This statistical analysis concerns the quantity τ/t_w and the probability $P(\tau/t_w < X)$ of finding $\tau/t_w < X$. The prediction of the model proposed in ref.[35, 36] is that:

$$P(\tau/t_w < X) = 1 - (\beta + X)^{-\gamma} \quad (4)$$

where in ref.[35] $\beta = 1$ and $\gamma = 2.3$ for a particular class of energy valley distribution. The results of the analysis performed on the data at $T_f = 0.79T_g$ is plotted in fig.9 The function

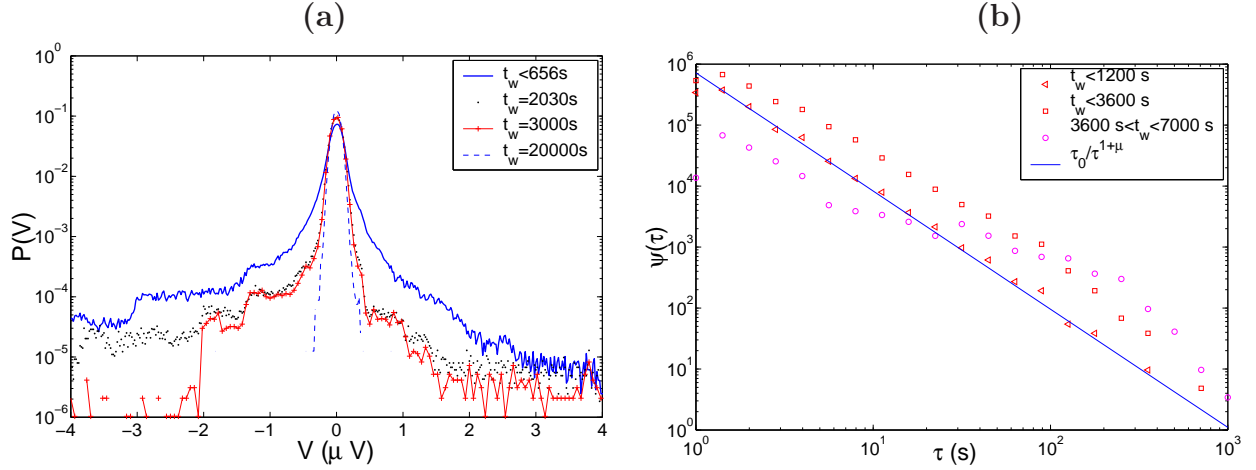

Figure 8: **PDF of the noise in polycarbonate after a fast quench at $0.93T_g$** (a) PDF of the noise signal of polycarbonate measured at various t_w . (b) Histograms $\Psi(\tau, t_w)$, here $\mu = 0.93$.

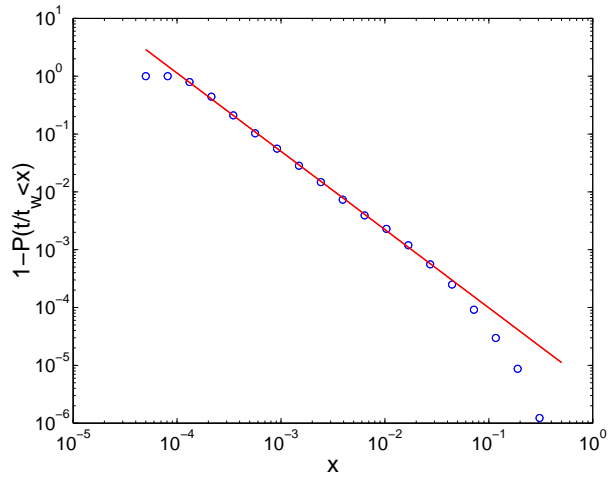

Figure 9: **Time interval statistics of the noise of polycarbonate after a fast quench at $0.79T_g$** One minus the probability of finding $\tau/t_w < X$ (\circ). The continuous line is a power law best fit $X^{-1.4}$ in the interval $10^{-4} < X < 5 \cdot 10^{-2}$

$CP = 1 - P(\tau/t_w < X)$ obtained from the data analysis follows the functional form predicted in ref.[35] only qualitatively because the function $(\beta + X)^{-\gamma}$ is only a good approximation of the data. However for large X we find a power law behaviour as suggested by eq.4, but the α is different from the one proposed in ref.[35], that it is not surprising as this exponent depends on the energy valley distribution. Furthermore there is another important difference between the experimental results and the model predictions. In the model, the probability of finding $\tau/t_w \gg 1$ is high. In contrast in the experiment τ/t_w is always smaller than one as can be seen in fig.9. Probably this difference could be taken into account with a suitable

renormalisation of the residence time in the model. Finally we find that α and $\beta \simeq 10^{-4}$ do not depend on T_f within experimental errors, but much more statistics will be necessary to clarify this point. In spite of these discrepancies between the theoretical predictions and the experimental results, the model of ref.[35] catches several aspects of the experiment. The most interesting is that the probability of finding short τ between intermittent events decreases with t_w . This is in contrast with the prediction of the trap model of ref.[22] where the probability of finding short τ remains large even at large t_w . This seems not to be the case, but the fact that a threshold is used in order to detect the large events may influence the statistics at large t_w . In section 7), we will discuss in more details the relevance for the experiment of the different trap models.

5 Influence of the quench speed.

The intermittent behaviour described in the previous sections depends on the quench speed. In Fig. 10(a) we plot the PDF of the signals measured after a slow quench ($3.6 K/min$). We see that the PDF are very different. Intermittency has almost disappeared and the violation of FDT is now very small, about 15%. The comparison between the fast quench and the slow quench merits a special comment. During the fast quench $T_f = 0.93T_g$ is reached in about 100 s after the passage of T at T_g . For the slow quench this time is about 1000 s. Therefore one may wonder whether after 1000s of the fast quench one recovers the same dynamics of the slow quench. By comparing the PDF of Fig. 8(a) with those of Fig. 10(a) we clearly see that this is not the case. Furthermore, by comparing the histograms of Fig. 8(b) with those of Fig.10(b), we clearly see that there are less events separated by short τ for the slow quench. Therefore one deduces that the polymer is actually following a completely different dynamics after a fast or a slow quench [41, 42]. This is a very important observation that can be related to well known effects of response function aging. The famous Kovacs effect is an example[2] where the isothermal compressibility presents a completely different time evolution depending on the cooling rate.

6 T_{eff} after a slow quench

In the previous section we have shown that the intermittent aging dynamics is strongly influenced by the cooling rate. We discuss in this section the behaviour of the effective temperature after a slow quench. We use for this purpose the measurement at $T_f = 0.98T_g$. The time evolution of the response function is much larger at $0.98T_g$ than at $T_f = 0.79T_g$ as it can be seen in Fig.11. It is about 50% at the small frequencies, therefore it has to be kept into account in the evaluation of FDT. The spectrum of the capacitance noise measured at $0.98T_g$ is plotted for two different times in Fig.12. The continuous lines represents the FDT predictions computed using the measured response function reported in Fig.11.

We clearly see that the experimental points are very close to the FDT predictions, thus the violation of FDT, if it exists, is very small. To check this point, we have computed T_{eff} in the range $[1Hz - 10Hz]$, which is plotted as a function of time in Fig.13. Although the error bars are rather large, we clearly see that T_{eff} decreases logarithmically as a function

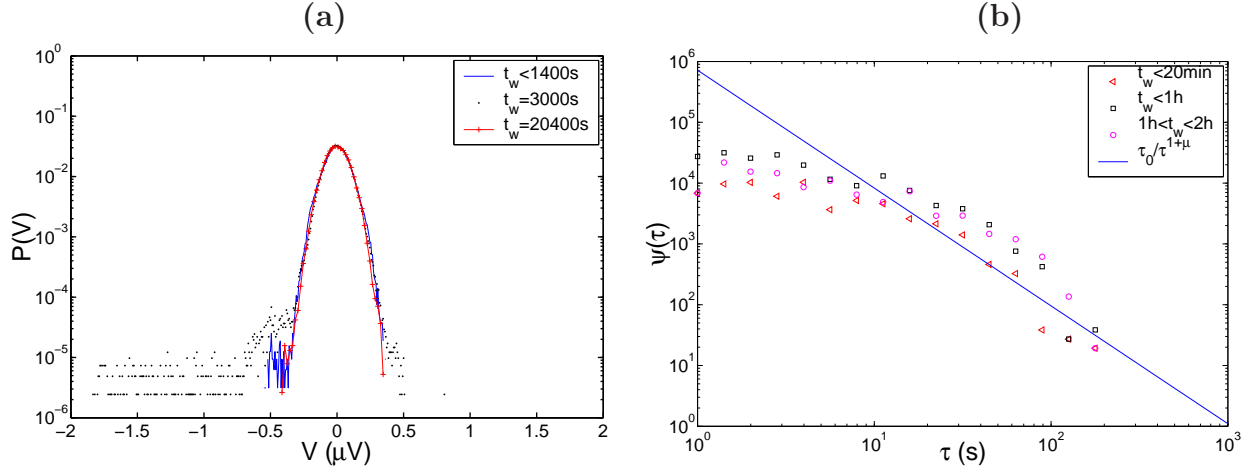

Figure 10: **PDF of the noise in polycarbonate after a slow quench at $T_f = 0.93T_g$.** (a) No intermittency is visible after a slow quench at $3.6K/min$. (b) Histograms $\Psi(\tau, t_w)$ after a slow quench. We choose $\mu = 0.93$.

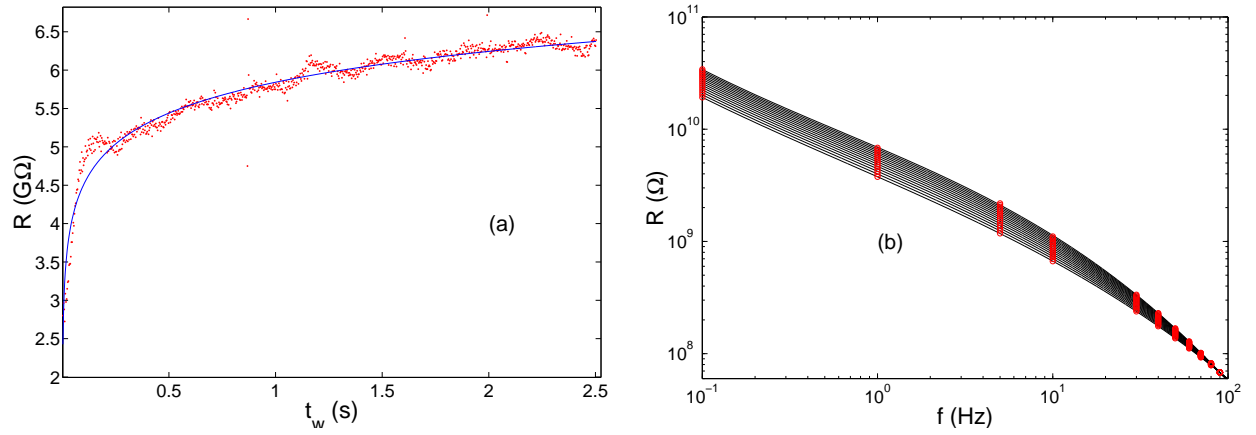

Figure 11: **Capacitance losses at $T_f = 0.98T_g$ after a slow quench.** (a) R as a function of t_w measured at $1Hz$. The continuous line is a logarithmic fit of the data. (b) Resistance as a function of frequency for different t_w from $t_w = 100s$ (lower curve) to $t_w = 14400s$ (upper curve).

of time. We also notice that the maximum violation at short times is about 25% which is much smaller than that measured at smaller T_f after a fast quench. The PDF of the noise signal at $0.98T_g$ are plotted in Fig.14a) and they do not show very large tails as in the case of the intermittent dynamics. The statistics of the time intervals τ between two large events does not present any power law (see Fig.14b). Thus the signal statistics look much more similar to those measured at $0.93T_g$ after a slow quench than to the intermittent ones. These measurements show that independently of the final temperature the intermittent behaviour is induced by a fast quench and that the FDT violation is cooling rate dependent.

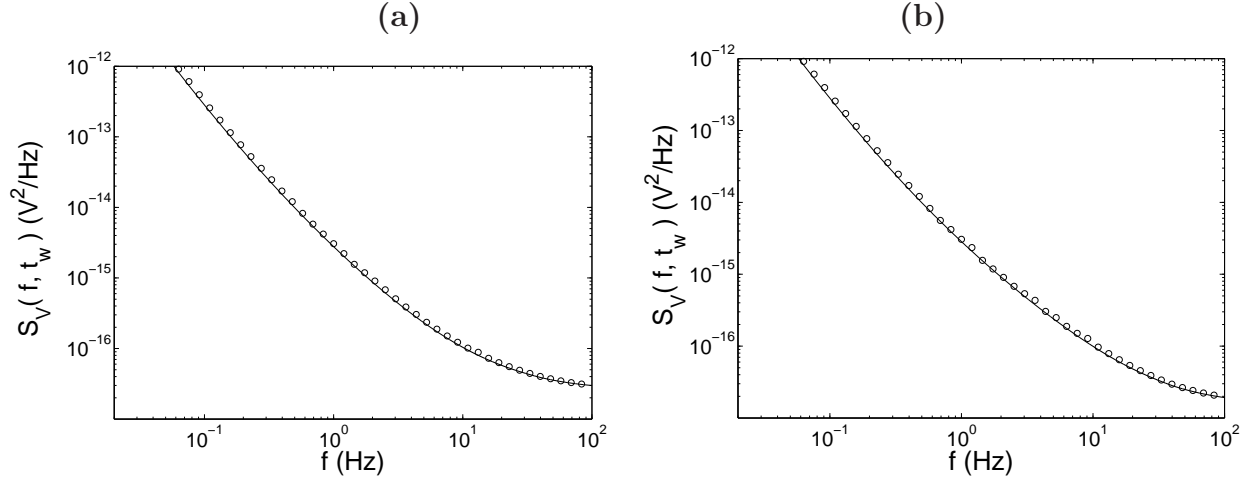

Figure 12: **Power spectral density of the capacitance noise at $T_f = 0.98T_g$ after a slow quench.** $S_V(f, t_w)$ as a function of f for two different times: (a) $t_w = 200s$, (b) $t_w = 7200s$

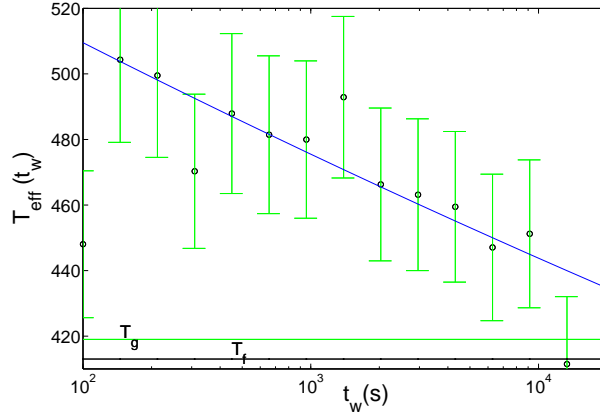

Figure 13: T_{eff} as a function of time at $T_f = 0.98T_g$ after a slow quench. T_{eff} averaged in the frequency band $[1Hz - 10Hz]$. It has been computed from the spectra $S_V(f, t_w)$ and the measured (R, C) using eq.2

7 Discussion and conclusions

Let us review the main results of the experiments described in the previous sections. We have seen that dielectric measurements of polycarbonate, after a fast temperature quench, show a strong violation of FDT. In agreement with theoretical prediction the amplitude and the persistence time of the FDT violation is a decreasing function of frequency and time. The effective temperature defined by eq.1 is huge at small f and t_w and slowly relaxes towards the bath temperature. The violation is observed even at $\omega t_w \gg 1$ and it may last for more than $3h$ for $f > 1Hz$. The cut-off frequency $f_o(t_w)$ below which the violation is observed

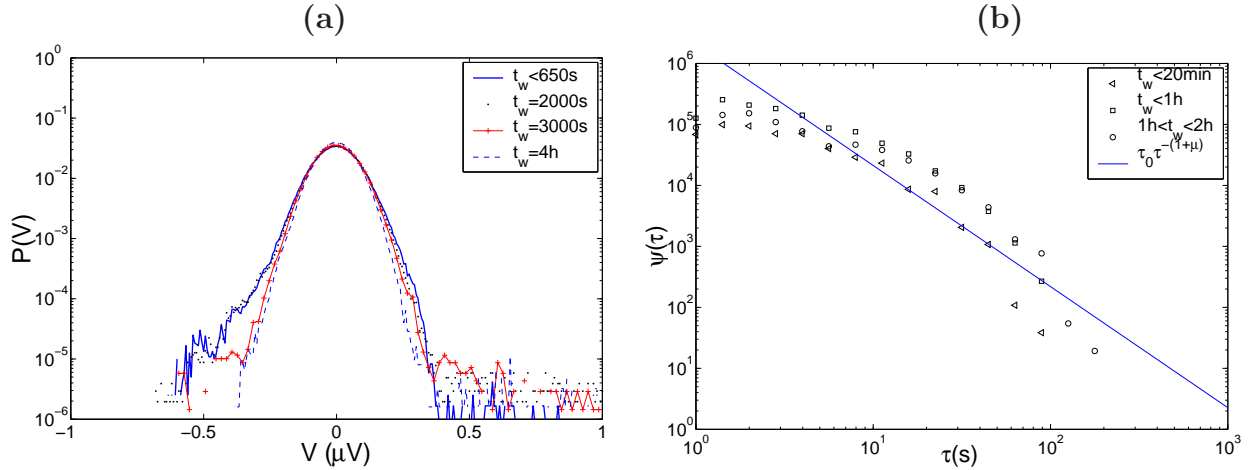

Figure 14: **PDF of the noise signal at $T_f = 0.98T_g$ after a slow quench.** (a) PDF of the signal. (b) Histograms $\Psi(\tau, t_w)$ after a slow quench. We choose $\mu = 1 + T_f/T_g$ to compare with the theoretical estimation for the trap model

has a power law dependence on t_w .

We have then investigated the behavior of the noise signals and we have shown that the huge T_{eff} is produced by very large intermittent bursts which are at the origin of the low frequency power law decay of noise spectra. Furthermore we have also shown that the statistic of this event is strongly non Gaussian when FDT is violated and it slowly relaxes to a Gaussian one at very long t_w . Thus this material has a relaxation dynamics, characterized by a strong intermittency. The time intervals τ between two intermittent events are power law distributed with an exponent which depends on T_f .

However the relaxation dynamics of polycarbonate depends on the quenching rate. Indeed we have seen that the behaviour of the system is quite different after a slow quench. In such a case the intermittency disappears, the noise signal PDF are much close to a Gaussian and the time between two large fluctuations is not power law distributed. Furthermore the violation of FDT is much smaller after a slow quench than after a fast one.

The main results of the experiments described in this paper are:

- At the very beginning of aging the noise amplitude is much larger than what predicted by Nyquist relations. In other words Nyquist relations, or generally FDT, are violated because the material are out of equilibrium : they are aging.
- The noise slowly relaxes to the usual value after a very long time.
- There is a large difference between fast and slow quenches. In the first case the thermal signal is strongly intermittent, in the second case this feature almost disappears.
- The effective temperature estimated using FDR is huge after a fast quench and it is about 20% larger than T_f after a slow quench.

- The statistics of time between two large events is strongly influenced by the cooling rate.

The first striking result which merits to be discussed is the huge T_{eff} measured in polycarbonate. Such a large T_{eff} is not specific to our system but it has been observed in domain growth models[8, 30]. The behaviour of these models is not consistent with that of our system, because in the case of domain growth the huge temperature is given by a weak response not by an increase of the noise signal. Other models which may present large T_{eff} are the trap models [22, 35, 36, 37, 38, 39]. Their basic ingredient is an activation process and aging is associated to the fact that deeper and deeper valleys are reached as the system evolves. These models predict non trivial violation of FDT associated to an intermittent dynamics. The dynamics in these models has to be intermittent because either nothing moves or there is a jump between two traps. This contrasts, for example, with mean field dynamics which is continuous in time[5]. Furthermore two very recent theoretical models predict skewed PDF both for local [44] and global variable [36]. This is a very important observation, because it is worth noticing that one could expect to find intermittency in local variables but not in global. Indeed in macroscopic measurements, fluctuations could be smoothed by the volume average and therefore the PDF would be Gaussian. This is not the case both for our experiments and for the numerical simulations of aging models[36]. In order to push the comparisons with these models of intermittency on a more quantitative level one should analyze more carefully the PDF of the time between events, which is very different in the various models[22, 35, 36]. In sect.4) we have seen that the time statistics present features of the model of ref.[22] and of that of ref.[35]. The probability $\Psi(\tau, t_w)$ has a power law dependence with an exponent μ which is a function of T_f but it does not depend on t_w . This is coherent with the assumptions of the trap model of ref.[22], although the dependence of μ on T_f does not seem to be the correct one for small T_f . Furthermore in the experiment at large t_w the number of short τ decreases. This is in contrast with the trap model of ref.[22] but it is coherent with the model of ref.[35], for which the probability of finding short τ between intermittent events decreases with t_w . However this effect has to be studied in more details because the fact that a threshold is used in order to detect the large events may influence the statistics of τ at large t_w where the amplitude of the intermittent burst is much smaller than that at short t_w . The ratio τ/t_w is always smaller than 1 in the experiment. This is not the case for the model of ref.[35] for which τ/t_w can be much larger than one. However this model predicts a functional form of $P(\tau/t_w < X)$ which is a good approximation for the experimental one. Thus we see that the experiments present different features observed in different models. Our statistics is not yet enough accurate to give clear answers on this point and much more measurements are necessary to make a quantitative comparison between theory and experiment.

It is important to mention that intermittent dynamics is not observed in our system only. For example it is reminiscent of the intermittency observed in the local measurements of polymer dielectric properties. [11]. Recent measurements done, using time resolved correlation in diffusing wave spectroscopy, have shown a strong intermittency in the slow relaxation dynamics of a colloidal gel[17]. Furthermore dielectric measurements in a colloidal glass (Laponite) also show intermittency [12, 13]. The intermittent rate depends in the case of Laponite, on the concentration of the colloidal particles into the solvent. Indeed

the concentration in this colloidal glass plays the role of the the quenching rate [43], because the higher is the concentration the faster is the sol-gel transition. Thus there is a strong analogies between polycarbonate and Laponite: in both materials intermittency is related to fast quenches

After a slow quench the behavior of polycarbonate is quite different. In order to discuss the problem related to this difference it is important to recall that the zero of t_w is defined as the instant in which the temperature crosses T_g . The first question that one may ask, already discussed in section 5, is whether the behaviour of the system at the same t_w after a slow and a fast quenches is the same. This is certainly not the case because the system takes about $20min$ during a slow quench to reach T_f and we have seen that after a fast quench the signal remains intermittent for many hours, whereas after a slow quench intermittency is never observed. Thus one concludes that the different dynamics are not produced by a time delay between fast and slow quenches but they are related to the quenching rate. This is consistent with the recent work on the trap model which explains the Kovacs effect with the existence of a completely different dynamics after the fast and slow quenches [41].

The main consequence of these observations in the electric measurements is that the definition of T_{eff} based on FDR depends on the cooling rate (on the concentration for the colloid) and probably on T_f . In Fig.15 we have summarized the T_{eff} obtained by electric measurements performed on glycerol[9] and on polycarbonate (Sec.2) and by magnetic measurements performed on a spin glass [14]. Specifically we plot T_{eff}/T_g versus T_f/T_g . The straight line is the FDT prediction for T_{eff} . Looking at this figure we see that the situation is rather confused. However it becomes more clear if one takes into account the cooling rate. As the T_g is quite different in the various materials we define a relative cooling rate $Q = \frac{\partial T}{\partial t} \frac{1}{T_g}$, which takes the following values: 0.5 min^{-1} for the spin glass, 0.12 min^{-1} for the polycarbonate fast quenches ($T_f/T_g = 0.93$ and 0.79), 0.009 min^{-1} for the polycarbonate slow quenches ($T_f/T_g = 0.98$) and 0.012 min^{-1} for the glycerol experiment. Thus by considering the relative cooling rate it is clear that in the fast quenches T_{eff} is very large and in the slow quenches it is small independently of the material. However a dependence on T_f seems to be present too. Many more measurements are certainly necessary to confirm this dependence of T_{eff} on T_f and on the cooling rate.

A very important and general question remains open. Indeed it is either the speed in which T_g is crossed that determines the dynamics or the time in which T_f is approached. This question has been already studied in the context of response functions, but never in the context of noise. This article clearly shows the importance of associating thermal noise and response measurements. As we have already pointed out in the introduction the standard techniques, based on response measurements and on the application of thermal perturbations to the sample, are certainly important to fix several constrains for the phase space of the system. However they do no give informations on the dynamics of the sample, which can be obtained by the study of FDR and of the signal PDF.

Acknowledgments We acknowledge useful discussion with J.L. Barrat, L. Bellon, J. P. Bouchaud, S. Franz and J. Kurchan. We thank P. Metz, F.Vittoz and D.Le Tourneau for technical assistance. This work has been partially supported by the DYGLAGEMEM contract of EEC.

Appendix: The choice of the material and the signal to noise ratio

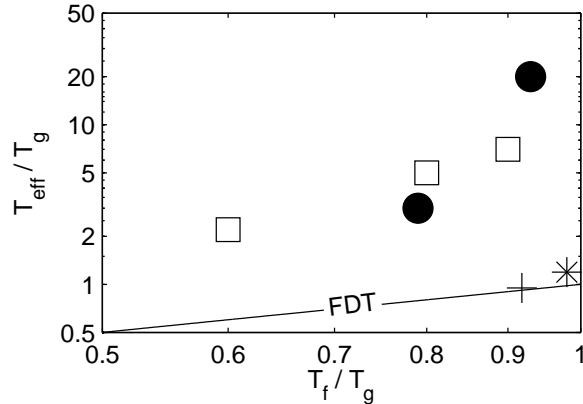

Figure 15: T_{eff} as a function of T_f . T_{eff} measured in several experiments on different types of glasses at the beginning of the aging regime. (+) glycerol ($f = 7Hz$) [9], (□) spin glass ($q = q_{min}$) [14], (●) polycarbonate ($f = 7Hz$, fast quench), (*) polycarbonate ($f = 7Hz$, slow quench)

Polycarbonate has been chosen for the wide interval of temperature where this material presents aging. Indeed the logarithmic dependence on time of polycarbonate dielectric susceptibility can still be observed even at temperatures smaller than $0.7 T_g$ [1]. As polycarbonate is an extremely good dielectric (very low losses) the accurate measure of the response $Z(\omega)$ presents several problems due to the very high value of R at small frequencies (see Figs. 2,3). These problems have been solved by the use of an impedance adapter (current amplifier), developed in our laboratory, associated with two lock-in amplifiers [40]. This system has been calibrated with a Novocontrol impedance analyzer, which, in the frequency band of our interest, is more noisy than our electronics. The value of the capacitance C can be modified by changing the diameter and the number of the capacitors sandwiched in the capacitance cell described in Fig1. The choice of C is very important in order to optimize the signal to noise ratio in the frequency band of our interest. Indeed what we are interested in is $S_z(\omega)$ (eq.1) but we measure $S_V(\omega)$ (eq.2). The ratio $SNR = S_V(\omega) / [S_V(\omega) - S_Z(\omega)]$ has been computed at $T_{eff} = T_f$ for different values of C and $R \simeq 1000 / (C\omega)$, which is a rather good approximation for the losses of polycarbonate in our measuring range. The computed values of SNR are plotted in Fig.16 as a function of f . We see that at $T_f = 333K$ and for $5nF < C < 10nF$ the signal to noise ratio is about 2 but is much better at large T_f . Thus we built a capacitance with $C \simeq 10nF$ which corresponds to a sandwich of 14 capacitances as described in section 2. More details can be found in reference [40].

References

- [1] L.C. Struick, *Physical aging in amorphous polymers and other materials* (Elsevier, Amsterdam, 1978).

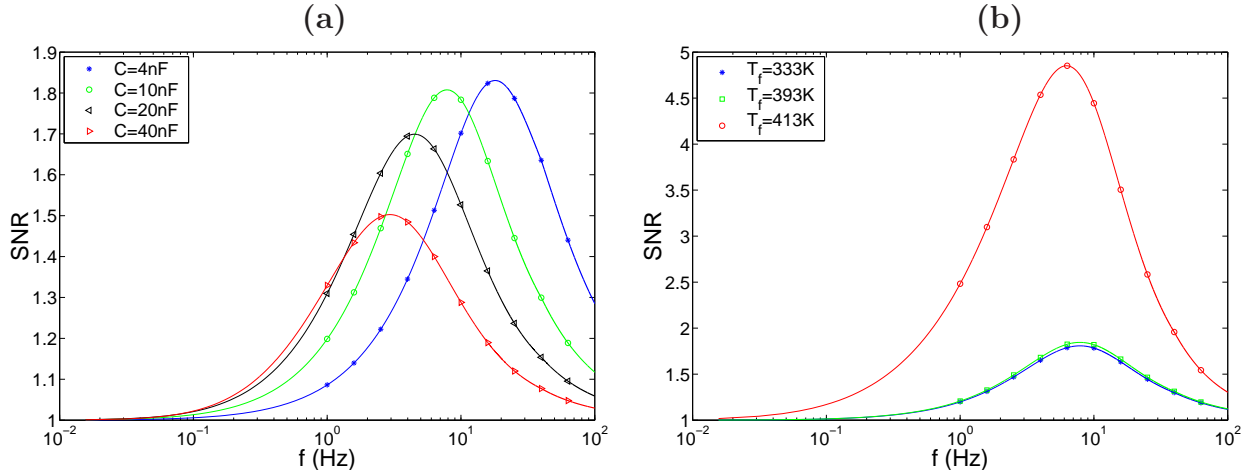

Figure 16: **Signal to noise ratio as a function of C and T_{eff} .** (a) The signal to noise ratio of the spectrum, computed for $T_f = 333K$, is plotted as a function of f for different values of C . (b) Evolution of the SNR for various T_f , with $C = 10nF$.

- [2] A.J. Kovacs, *La contraction isotherme du volume des polymres amorphes*, *Journal of polymer science*, **30**, p.131-147, (1958).
- [3] K. Jonason, E. Vincent, J. Hamman, J. P. Bouchaud, *Memory and chaos effects in spin glasses*, *Phys. Rev. Lett.*, **81**, 3243 (1998).
- [4] L. Bellon, S. Ciliberto, C. Laroche, *Advanced Memory effects in the aging of a polymer glass*, *Eur. Phys. J. B.*, **25**, 223, (2002).
- [5] L. Cugliandolo, J. Kurchan, *Analytical Solution of the Off Equilibrium Dynamics of a Long Range Spin Glass Model*, *Phys. Rev. Lett.*, **71**, p.173, (1993).
- [6] J.P. Bouchaud, L. F. Cugliandolo, J. Kurchan, M. Mézard, *Out of equilibrium dynamics in Spin Glasses and other glassy systems*, in *Spin Glasses and Random Fields*, ed A.P. Young (World Scientific, Singapore 1998). (also in cond-mat/9702070)
- [7] L. Cugliandolo, *Effective temperatures out of equilibrium*, to appear in *Trends in Theoretical Physics II*, eds. H Falomir et al, Am. Inst. Phys. Conf. Proc. of the 1998 Buenos Aires meeting, cond-mat/9903250
- [8] L. Cugliandolo, J. Kurchan, L. Peliti, *Energy flow, partial equilibration and effective temperatures in systems with slow dynamics*, *Phys. Rev. E*, **55**, p.3898 (1997).
- [9] T. S. Grigera, N. Israeloff, *Observation of Fluctuation-Dissipation-Theorem Violations in a Structural Glass*, *Phys. Rev. Lett.*, **83**, p.5038 (1999).
- [10] W.K.Kegel, A.van Blaaderen *Direct observation of dynamical heterogeneities in colloidal hard-sphere suspensions*, *Science*, **287**, p.290, (2000).

- [11] E. Vidal Russel, N. E. Israeloff, *Direct observation of molecular cooperativity near the glass transition*, *Nature*, **408**,695 (2000).
- [12] L. Bellon, S. Ciliberto, C. Laroche, *Violation of fluctuation dissipation relation during the formation of a colloidal glass*, *Europhys. Lett.*, **53**, 511 (2001).
- [13] L.Bellon, S. Ciliberto, *Experimental study of fluctuation dissipation relation during the aging process*, *Physica D*, **168**, 325 (2002).
- [14] D. Herrisson, M. Ocio, *Fluctuation-dissipation ratio of a spin glass in the aging regime*, *Phys. Rev. Lett.*, **88**, 257702 (2002).
- [15] E.R.Weeks, D.A.Weitz *Properties of cage rearrangements observed near the colloidal glass transition*, *Phys.Rev.Lett.*, **89**, p.95704, (2002).
- [16] L. Buisson, A. Garcimartin, S. Ciliberto, *Intermittent origin of the large fluctuation-dissipation relations in an aging polymer glass*, *Europhys. Lett.*, **63**, p.603, (2003).
- [17] L. Cipelletti, H. Bissig, V. Trappe, P. Ballestat, S. Mazoyer, *Direct observation of dynamical heterogeneities in colloidal hard-sphere suspensions*, *J. Phys: Condens. Matter*, **15**, p.S257, (2003).
- [18] H. Bissig, V. Trappe, S. Romer, Luca Cipelletti, *Intermittency and non-Gaussian fluctuations in the dynamics of aging colloidal gels*, submitted *Phys.Rev.Lett.*
- [19] C.G. Robertson, G. L. Wilkes, *Long term volume relaxation of bisphenol A polycarbonate and atactic polystyrene*, *Macromolecules* **33**, 3954 (2000).
- [20] L. Saviot, E. Duval, J.F. Jal, A.J. Dianoux, *Very fast relaxation in polycarbonate glass* *Eur. Phys. J. B.*, **17** (4), 661, (2000).
- [21] R. Quinson, *Caractrisation et modlisation de la dformation non lastique des polymres amorphes l'tat solide,Ph.D. thesis, (INSA), (1998).*
- [22] J.P. Bouchaud, D. S. Dean, *Aging on Parisi's tree*, *J. Phys. I France*, **5**, 265 (1995).
- [23] J.P.Bouchaud, *Weak ergodicity breaking and aging in disordered systems*, *J.Phys. I France*, **2**, p.1705, (1992).
- [24] D. S. Fisher, D. A Huse, *Ordered phase of short range ising spin-glasses*, *Phys. Rev. Lett.*, 56, 1601 (1986); D. S. Fisher, D. A Huse, *Nonequilibrium dynamics in spin glasses*, *Phys. Rev. B*, 38, 373, (1988).
- [25] J.M.Bertin, J.P.Bouchaud, *J. Phys. A: Math. Gen.* 35, 309 (2002).
- [26] S.R. de Groot, P. Mazur, *Non equilibrium thermodynamics*, (Dover, 1984)
- [27] G. Parisi, *Off-Equilibrium Fluctuation-Dissipation Relation in Fragile Glasses* *Phys. Rev. Lett.*, **79**, p.3660 (1997).

- [28] W. Kob, J. L. Barrat, *Aging effects in a Lennard Jones Glass*, Phys. Rev. Lett., **78**, p.4581 (1997);
- [29] J. L. Barrat, W. Kob, *Fluctuation dissipation ratio in an aging Lennard-Jones* Europhys. Lett., bf 46, p.637 (1999).
- [30] A. Barrat, *Monte-Carlo simulations of the violation of the fluctuation-dissipation theorem in domain growth processes*, Phys. Rev.,**E57**, p. 3629 (1998).
- [31] M. Sellitto, *Fluctuation dissipation ratio in lattice-gas models with kinetic constraints*, European Physical Journal,**B4**, p.135 (1998).
- [32] E. Marinari, G. Parisi, F. Ricci-Tersenghi, J. J. Ruiz-Lorenzo, *Violation of the Fluctuation Dissipation Theorem in Finite Dimensional Spin Glasses*, J. Phys. A: Math. Gen.,**31**, p.2611 (1998)
- [33] L. Berthier, J. L. Barrat, J. Kurchan, *Two-times scales, two temperature scenario for nonlinear rheology*,Phys. Rev. E,**61**, 5464 (2000).
- [34] L. Berthier, J. P. Bouchaud,*Geometrical Aspects of Aging and Rejuvenation in the Ising Spin Glass: A Numerical Study*, Physical Review B cond-mat/0202069v1
- [35] P. Sibani, and J. Dell, *Europhys. Lett. 64*, p. 8, 2003.
- [36] P. Sibani, H. J. Jensen, *Intermittency, aging and record fluctuations*,cond-mat/0403212
- [37] A. Perez-Madrid, D. Reguera, J.M. Rubi, *Origin of the Violation of the Fluctuation-Dissipation Theorem in Systems with Activated Dynamics*. Physica A, 329, 357 (2003).
- [38] M. Nasprea, D. Reguera, A. Perez-Madrid, J.M. Rubi, *Glassy dynamics: effective temperatures and intermittenicies from a two-state model*, cond-mat/0411063
- [39] S. Fielding, P. Sollich, *Observable dependence of Fluctuation dissipation relation and effective temperature*, Phys. ReV Lett., 88, 50603-1, (2002).
- [40] L. Buisson,*Intermittence pendant le vieillissement et relation de fluctuation dissipation*,Phd Thesis ENS de Lyon (2003).
- [41] E.M.Bertin, J.P.Bouchaud, J. M. Drouffe, C. Godreche, *The Kovacs effect in model glasses*, J. Phys. A: Math. Gen 36, 10701 (2003).
- [42] S. Mossa, F. Sciortino, *Kovacs effects in aging molecular liquid*, Phys. Rev. Lett. 92, 045504 (2004).
- [43] L. Buisson, M. Ciccotti, L. Bellon, S. Ciliberto,*Electrical noise properties in aging materials.*, In: Fluctuations and Noise in Materials, edited by D. Popovic, M.B. Weissman and Z.A. Racz. Proceedings of SPIE Vol. 5469 (SPIE, Bellingham, WA, 2004). Invited paper. pp. 150-163.
- [44] A. Crisanti, and F. Ritort, *Intermittency of Glassy relaxation and the emergence of non-equilibrium spontaneous measure in the aging regime*, Europhys. Lett. **66** (2): 253(2004).

