

Crash Avoidance in a Complex System

Michael L. Hart*, David Lamper and Neil F. Johnson
Physics Department, Oxford University, Oxford OX1 3PU, U.K.

November 6, 2018

Abstract

Complex systems can exhibit unexpected large changes, e.g. a crash in a financial market. We examine the large endogenous changes arising within a non-trivial generalization of the Minority Game: the Grand Canonical Minority Game (GCMG). Using a Markov Chain description, we study the many possible paths the system may take. This ‘many-worlds’ view not only allows us to predict the start and end of a crash in this system, but also to investigate how such a crash may be avoided. We find that the system can be ‘immunized’ against large changes: by inducing small changes today, much larger changes in the future can be prevented.

PACS: 01.75.+m; 02.50.Le; 05.40.+j; 87.23.Ge

Keywords: Complex adaptive systems; Econophysics; Agent-based models

* Corresponding author. Tel +44-1865-272356. Fax +44-1865-272400.
E-mail address: michael.hart@physics.ox.ac.uk (Michael L. Hart)

1 Introduction

The ability to produce large, unexpected changes represents one of the most remarkable dynamical features of complex systems [1]. Examples include crashes in financial markets, jams in traffic and data networks, and the collapse of the immune system in humans. The large changes arising in real-world systems might be exogenous and hence triggered by some event in the environment which is external to the system - however the most intriguing case concerns the *endogenous* large changes which seem to arise ‘out of nowhere’ and cannot be blamed on any particular external cause. The bursting of the dot-com bubble around April 2000 represents a recent finance-related example of an endogenous large change. The practical motivation for studying large changes or so-called ‘extreme events’ is obvious: they are rare, but the damage they cause can be catastrophic. Present practice in assessing the risk of such events is purely statistical [2]. This has two shortcomings. First, these events are rare and hence reliable statistics are difficult to determine. Second, large events such as crashes arise from subtle temporal correlations in the time-series and hence can last over many time-steps. Such changes are therefore not easily captured by examining probability distribution functions involving a fixed number of time-steps [1]. The academic motivation is equally strong, since large changes provide a visible demonstration of the system’s internal dynamics and correlations. Reference [1] quotes Bacon from *Novum Organum*: “Whoever knows the ways of Nature will more easily notice her deviations; and, on the other hand, whoever knows her deviations will more accurately describe her ways”. In short, the largest changes will tend to ‘scrape the barrel’ in some way: hence they may provide new insight into the structure of the barrel (i.e. the system) and contents (i.e. the constituent parts and their interactions).

In this paper, we examine large changes using a simple, yet highly non-trivial, model for a complex system comprising a population of objects or ‘agents’ repeatedly competing for a limited global resource. In particular, we study the many possible paths the multi-agent system may take in the vicinity of a possible large change. This ‘many-worlds’ view allows us not only to predict the start and end of a large change in this system, but also to investigate how such a large change might be avoided. We find that the system can be ‘immunized’: by provoking a small response today, the future robustness of the system against large changes can be boosted.

Agent-based models are becoming a standard tool for investigating complex system behavior across many disciplines[3]. Typically each agent has access to a limited set of recent global outcomes of the system; she then combines this information with her limited strategy set, chosen randomly at the start of the game (i.e. quenched disorder) in order to decide an action at the given timestep. These decisions by the N agents feed back to generate the system’s output. The Minority Game (MG) introduced by Challet and Zhang[4] offers possibly the simplest paradigm for such a complex, adaptive system and has therefore been the subject of much research activity [3]. Most studies of the MG have focused on a calculation of both time and configuration (i.e. quenched disorder) averaged

quantities - in particular the ‘volatility’ σ , where σ is the standard deviation of the number of agents taking a given decision. Our previous work has shown that the variation of this averaged σ as a function of memory size m can be quantitatively explained in terms of ‘crowd-anticrowd’ collective behavior [5, 6]. In common with other MG theories [3], our crowd-anticrowd theory implicitly assumes both time-averaging and configuration-averaging.

The approach of studying realization-averaged quantities is standard in physics. It yields meaningful results for a wide range of physical systems because of the natural self-averaging which occurs in many-particle systems over the time-scales and length-scales of a typical experiment. However it is arguably of limited use in the study of real-world complex systems. This is because the observed evolution of a complex system only provides a *single* realization of the many possible paths that the dynamics can take. A financial market, for example, evolves with the knowledge that a crash happened at a specific moment in the past: there is a definite pre- and post-crash dynamics which will tend to condition the possible future paths. For example, the future behavior of the financial markets is dictated in part by the spectre of the recent dot-com boom and bust. In the context of human evolution, social revolutions dominate the subsequent dynamics within a society. Consequently one would gain little insight into the present state of the world by including all possible scenarios from the past, such as ones where the dinosaurs did not become extinct or ones where US did not gain independence. With this in mind, we have recently introduced two alternative theoretical approaches to analyse the MG, both of which focus on the dynamics for a *single* realization of the quenched disorder. The first approach [7] views the MG as a stochastically perturbed deterministic system. Averaging over the sources of stochasticity, in particular the coin-tosses used to break ties in strategy scores, yields a set of deterministic mapping equations [7]. Hence, in this system any particular realization of the quenched disorder will give rise to a single path for the future dynamics. The second approach takes a complementary, stochastic viewpoint based on a Markov Chain analysis [8]. It is this latter theoretical approach which we will build upon in the present paper, focusing on the effect that the stochasticity can have in creating alternative future paths in the system’s evolution. A further distinguishing feature of the present work is therefore its ‘many worlds’ view of the future evolution of a multi-agent system. The underlying motivation for such an approach is our desire to understand the degree to which information about an upcoming large change is already ‘encoded’ in the system, and hence the degree to which the large change itself might be avoidable.

2 Grand Canonical Minority Game (GCMG)

The basic MG [3, 4] comprises an odd number of agents N (e.g. traders or drivers) choosing repeatedly between option 0 (e.g. sell or choose route 0) and option 1 (e.g. buy or choose route 1). The winners are those in the minority group; e.g. sellers win if there is an excess of buyers, drivers choosing route 0

encounter less traffic if most other drivers choose route 1. The outcome at each timestep represents the winning decision, 0 or 1. A common bit-string of the m most recent outcomes is made available to the agents at each timestep [3, 4]. The agents randomly pick s strategies at the beginning of the game, with repetitions allowed. This initial strategy allocation represents a quenched disorder. Each strategy is a bit-string of length 2^m which predicts the next outcome for each of the 2^m possible histories. After each turn, the agent assigns one (virtual) point to each strategy which would have predicted the correct outcome. At each turn of the game, the agent uses the most successful strategy, i.e. the one with the most virtual points, among her s strategies. Any ties between equally successful strategies are resolved by the toss of a coin.

Our Grand Canonical Minority Game (GCMG) was first presented in Ref. [9]. The main generalizations from the basic MG are as follows: (i) an agent only participates if she possesses a strategy that has a score equal to, or greater than, a predefined threshold r , and (ii) the strategy performance is only recorded over the previous τ timesteps. The GCMG hence incorporates the following real-world effects: (i) agents (e.g. traders) only participate if they have a certain level of confidence in the strategies that they possess, and (ii) the agents will tend to forget (or consider irrelevant) results that lie too far back in history. These seemingly trivial modifications of the basic MG yield a dynamical system with surprisingly rich dynamics. These dynamics depend strongly on whether the participants are fed real (as opposed to random) history strings, and on the nature of the quenched disorder corresponding to the initial conditions. We focus on the low m regime because of the richer dynamics, however our formalism can be applied for all m .

The number of agents holding a particular combination of strategies can be written as a $D \times D \times \dots$ (s terms) dimensional tensor Ω , where D is the total number of available strategies. For $s = 2$ strategies per agent, this is simply a $D \times D$ matrix where the entry (i, j) represents the number of agents who picked strategy i and then j . The strategy labels are given by the decimal representation of the strategy plus unity, for example the strategy 0101 for $m = 2$ has strategy label $5+1=6$. This quenched disorder Ω is fixed at the beginning of the game and is written using the full strategy space [8]. The value of a_R^μ describes the prediction of strategy R given the history μ , where μ is the decimal number corresponding to the m -bit binary history string [4]. Hence $a_R^\mu = -1$ denotes a prediction of option ‘0’ while $a_R^\mu = 1$ denotes a prediction of option ‘1’.

As discussed in Sec. I, we are interested in the detailed dynamics of the game for a given realization of the initial quenched disorder Ω . Hence we imagine that a particular Ω has already been chosen. Since the game involves a coin-toss to break ties in strategy scores, this stochasticity also means that different runs for a given Ω will also differ - we return to this point below. The number of traders making decision 1 (the ‘instantaneous crowd’) minus the number of traders making decision 0 (the ‘instantaneous anticrowd’) defines the net ‘attendance’ $A[t]$ at a given timestep t of the game. This attendance $A[t]$ is made up of two groups of traders at any one timestep [8]:

(a) $A_D[t]$ traders who act in a ‘decided’ way, i.e. they do not require the toss of a coin to decide which option to choose. This is because they have one strategy that is better than their other playable strategies, or because their highest-scoring strategies are tied *but* give the same response as each other to the history μ_t at that turn of the game.

(b) $A_U[t]$ traders who act in an ‘undecided’ way, i.e. they require the toss of a coin to decide which option to choose. This is because they have two (or more) tied, highest-scoring strategies *and* these give different responses to the history μ_t at that turn of the game.

Hence the attendance at timestep t is given by

$$A[t] = A_D[t] + A_U[t] \quad . \quad (1)$$

The state of the game at the beginning of timestep t depends on the strategy score vector \underline{s}_t and history μ_t . Henceforth we will drop the variable t from the notation, but note that it remains an implicit variable through the time-dependence of \underline{s} and μ . We also focus on $s = 2$ strategies per agent, although the formalism can be generalized in a straightforward way. At timestep t , A_D is given exactly by

$$A_D(\underline{s}, \mu) = \sum_{R, R'} a_R^\mu (1 + \text{Sgn}[s_R - s_{R'}]) \text{H}[s_R - r] \underline{\Psi}_{R, R'} \quad (2)$$

where the symmetrized matrix $\underline{\Psi} = \frac{1}{2}(\underline{\Omega} + \underline{\Omega}^T)$ with $\underline{\Omega}$ representing the quenched disorder. The element $\underline{\Omega}_{R, R'}$ gives the number of agents picking strategy R and then R' . The function $\text{H}[\dots]$ is the Heaviside function. The number of undecided traders N_U is given exactly by

$$N_U(\underline{s}, \mu) = \sum_{R, R'} \delta(s_R - s_{R'}) [1 - \delta(a_R^\mu - a_{R'}^\mu)] \text{H}[s_R - r] \underline{\Omega}_{R, R'} \quad (3)$$

and therefore the attendance of undecided traders A_U is distributed binomially as follows:

$$A_U(\underline{s}, \mu) \equiv 2 \text{B}[N_U(\underline{s}, \mu), \frac{1}{2}] - N_U(\underline{s}, \mu) \quad (4)$$

where the term ‘ $\text{B}[N_U(\underline{s}, \mu), \frac{1}{2}]$ ’ is standard notation to denote a binomial distribution in which there are $N_U(\underline{s}, \mu)$ trials with probability 1/2 of obtaining a given outcome [10]. Having obtained $A_D(\underline{s}, \mu)$ and $N_U(\underline{s}, \mu)$, it is now possible to calculate the probability $P(w = 0 | \underline{s}, \mu)$ that the next winning decision is a 0, given knowledge of \underline{s} and μ . This probability is given as follows:

$$P(w = 0 | \underline{s}, \mu) = \left(\frac{1}{2}\right)^{1+N_U} \sum_{i=0}^{i=N_U} N_U C_i (1 + \text{Sgn}[A_D + 2i - N_U]) \quad (5)$$

We note that Eqs. (1)-(5) represent a generalization to the GCMG, of the equations presented in Ref. [8] to describe the basic MG within the Markov Chain formalism.

3 Analysis of a Crash

The dynamics of the GCMG are rich, and exhibit large changes [9]. Here we look in detail at a typical (randomly-chosen) large change. In particular we are going to look at the many paths along which the system can evolve, starting well before the large change itself.

The quenched disorder is defined by Ω . The exact numerical form of Ω is too cumbersome to show but can be obtained from the authors. The initial conditions are defined by the score vector \underline{s} and the corresponding history state μ . For the purpose of calculating the values of \underline{s} and μ in subsequent timesteps, we also define the last $\tau + m$ winning outcomes of the GCMG. The specific initial conditions employed were taken from a typical run of the game, once initial transients had disappeared.

Equation (5) states the probability that the next winning outcome is a 0, given knowledge of \underline{s} and μ . It is possible to go further than this, by stating the mean attendance given that the attendance is positive (i.e. winning decision of 0) and/or the mean attendance given that the attendance is negative (i.e. winning decision of 1). Note that given a state of \underline{s} and μ , $P(w = 0|\underline{s}, \mu)$ may be greater than 0 but less than 1, and as such both winning decisions are possible for this state. If however $P(w = 0|\underline{s}, \mu)$ has a value of 0 or 1, then there is only one winning decision via which the complex system may evolve at that time-step. The system is therefore deterministic at this time-step.

There are several scenarios for A_D and N_U that can be examined. If $A_D \neq 0$ and $N_U = 0$ then the price change is given by the value of A_D , hence only one winning outcome is possible. If $A_D = 0$ and $N_U = 0$, then the winning outcome has equal probability of being 0 or 1. In this case the recorded attendance is zero: however the two possible winning outcomes are noted for the purpose of calculating the outcomes for subsequent timesteps. If $N_U \neq 0$ and $N_U < |A_D|$, then the attendance A can take $N_U + 1$ possible values, each with their associated probabilities calculated using simple binomial theory in a similar way to Eq. (5). The magnitude of the attendance at $t = \gamma$ has no significance for the future states of the system at times $t > \gamma$. Only information concerning the sign of the attendance is carried forward, via the winning outcome. It is therefore sufficient to record the attendance for that timestep as being the average possible value, i.e. $A = A_D$ if $N_U \neq 0$ and $N_U < |A_D|$. Showing all $N_U + 1$ possible price changes will not provide us with any extra useful information concerning the system - instead, showing the average value will enable us to present a less cluttered image of the many worlds (see later). If $N_U \neq 0$ and $N_U > |A_D|$, then both winning outcomes 0 and 1 are possible. For ease of calculation we shall approximate the binomial distribution in A_U using a Normal distribution. Hence we can extract two possible values for the attendance: one corresponding to a winning outcome of 0, and the other a winning outcome of 1. To calculate these attendances, one should split the Normal distribution into two parts with the dividing line at the point of cut-off in terms of determining the winning outcome. If the winning outcome is to be a 0, then the corresponding attendance contributed by N_U becomes the first moment of the distribution above the

cut-off. Figure 1 shows an example of this scenario, and indicates the two corresponding attendances that are to be calculated.

We define a ‘path’ as the trajectory of the complex system during one possible run of the game. The game is set up with $N = 101$ agents, each with two $m = 3$ strategies scored over the last $\tau = 60$ timesteps. The agents have identical confidence levels given by $r = 0.52 * \tau = 31.2$. Figure 2a shows all 949 different paths in terms of the cumulative attendance (e.g. price in a financial market). that this complex system can take over 56 timesteps, starting from the given initial conditions. Figure 2b indicates the probabilities of occurrence of the paths in one run of the game, as a function of the paths’ end points. Figure 2c shows a measure of the spread in price-increment between all the different paths as a function of time. This measure of the spread in price-increment is defined as follows:

$$\lambda = \frac{1}{2} \sum_i \left[\sum_j (x_j - x_i)^2 P(x_j) \right] P(x_i) \quad (6)$$

where x_α is the price change between neighboring timesteps for a price path denoted by α . The probability that path x_α occurs, given the initial conditions, is given by $P(x_\alpha)$. We note that for the basic MG, λ would take a value of 99.4 if the attendances were random. In the present GCMG case, the random limit would be larger due to the fluctuation in the total number of agents playing at a given time-step.

It becomes very difficult to resolve the different paths in Fig. 2a after timestep 40, even though it is only the average, historically-distinct paths which have been shown. The thick line shows the weighted average of *all* these paths. [Equation (5) allows us to calculate the probability of each path being the actual path taken in a single run of the game]. It is easy to identify by eye that a large change (i.e. so-called drawdown or crash) occurs between time-steps 33 and 50. Figure 2c shows that λ takes a very small value at the start of the crash: this signifies that the price-changes are similar at this point in time, in terms of the direction and size of movement, for the large majority of separate paths. Similarly at the end of the crash the quantity λ takes a very large value, signifying a point in time where there is great disparity in the sign and size of price-changes between separate paths. We note that λ is zero for the first 12 steps, since there is only one path possible up until timestep 13. Figure 2c demonstrates that it is possible to identify the start of a crash ahead of time, by the collective movements of the ‘parallel worlds’. In the case shown, the start of the crash is indicated by the collective crashes of the large majority of the many parallel worlds. Furthermore, it is possible in this system to identify the point in time when the system is released from the crash by observing when there is significant disparity between the parallel-world path movements. Starting from a time 33 steps prior to the start of the crash, it can be seen that a crash is highly likely.

Despite being highly likely, such a crash is not however inevitable. In order to gain insight into how the crash may be managed, reduced or even avoided,

we now turn to investigate the differences between the paths which perform better/worse than the many-world average. We will take ‘better than’ as being a path that has an end value that is numerically greater than that of the mean at timestep 56 (c.f. Fig. 2a) - similarly for ‘worse than’. Hence we shall split up the paths into these two corresponding groups: better-than-the-mean shall be labelled Set A, and worse-than-the-mean shall be labelled Set B.

Figure 3a shows the probability tree of a path belonging to Set A, for the first 33 timesteps. Each branching in this figure corresponds to a branching in Fig. 2a. Measuring the cumulative sign of attendance (i.e. price in a financial market) at timestep 33, one gets three values for the particular initial conditions: 0, 2 and 4. It is interesting to segregate those paths that have a cumulative movement of 0, 2, and 4, and plot the equivalent graphs to those shown in Fig. 3a together with their weighted means. Figure 3b shows those paths with a net movement of 0. Figure 3c shows those paths with a net movement of 2. Figure 3d shows those with a net movement of 4. The mean probability of ending up as a member of Set A is *greater* for those paths with a net movement of 2 as compared to those with 4. Similarly, the mean probability of ending up as a member of Set A is *greater* for those paths with a net movement of 0 as compared to those with 2.

We next compare weighted histograms of the cumulative *sign* of attendance during a period prior to the crash, and during a period after the crash. This will reinforce our findings concerning the differences between the paths in Set A and Set B. To do this, we set the period prior to the crash as timesteps 11 to 35, and the period after the crash as timesteps 36 to 56. Figure 4a shows the histogram for Set A prior to the crash. Figure 4b shows the histogram for Set B prior to the crash. It can be seen that the paths in Set B generally have *greater* cumulative signs of attendance than the paths in Set A. Figure 4c shows the histogram for Set A after the crash, while Fig. 4d shows the histogram for Set B also after the crash. Now the paths in Set B generally have *smaller* cumulative signs of attendance than the paths in Set A.

We now examine the occurrence of $(m+1)$ -bit words contained in the sequence of winning outcomes during the period from timestep 11 to 35, for the paths in Set A and Set B. [Studying the occurrence of $(m+1)$ -bit words is equivalent to studying the occurrence of a 0 or a 1 following an m -bit history]. Figure 5 shows the frequency of occurrence of an $(m+1)$ -bit word for Set A, divided by that for Set B. This indicates how much more likely a particular $(m+1)$ -bit word is in Set A as compared to Set B, prior to the crash. Hence it is just over twice as likely that 000 will be followed by a 0 in a path belonging to Set A, as compared to a path belonging to Set B. The period preceding the crash can therefore be seen as one of ‘imbalance’ or ‘tension’, which is subsequently released by the crash.

Figure 6 shows an $m = 3$ de-Bruijn graph [8]. The edges represent transitions between history states. Transitions having peak values above 1.15 in Fig. 5, are shown with darker arrows. Transitions that are particularly weak are represented by dashed arrows. The paths which are members of Set A, i.e. those which perform *better* than the mean, tend to have more *down* movements

in their history prior to the crash. By contrast, those paths which are members of Set B, i.e. those which perform *worse* than the mean, tend to have more *up* movements in their history prior to the crash. If one therefore wanted to avoid the crash in a run of the game, then it would be wise to force the system to undergo *down* movements prior to the crash, so as to relax the build up of any unwanted bias in the strategy scores. This would then keep the system to the left-hand side of the De-Bruijn graph where the arrows are darker, as seen in Figure 6. A controlling force or ‘complex systems manager’ could intervene at moments where there is little cost in order to manipulate a winning outcome, i.e. at time-steps where it may require as little as one agent to change the path of the system. In this way the controlling force could avoid the crash with minimal effort or investment.

This result that a large change can be prevented by creating an earlier, smaller movement *in the same direction*, reminds us of the idea of ‘immunization’. Injecting a small amount of a virus provokes a minor response which ‘primes’ the system’s defences against a much larger, and potentially fatal, response later on. In the same way, a small crash induced today, can be used to prevent a much larger crash from arising later on.

It has recently been shown that the large endogenous changes which arise in the GCMG complex system, exhibit a degree of predictability [7, 11]. Information signaling an increased threat of a large change is ‘encoded’ in the system’s microstructure well in advance. The present results for the GCMG are therefore consistent with these earlier findings [7, 11]. In real-world complex systems, such encoding would clearly be far more complicated to unravel. However there is the hope that *if* the system is viewed with the right ‘spectacles’, such signals might be uncovered. We refer the reader to the large body of work of Sornette et al. (see Ref. [1] and references therein) for the fascinating proposal of a log-periodic signature prior to large changes in a range of physical and natural systems, including financial markets.

Finally, we would like to draw attention to the nature of the large change studied in this paper. This event is described by a convergence of the many ‘world lines’ which project into the immediate future. This convergence arises in spite of the stochastic fluctuations which occur along each ‘world line’. It is this effect that gives the system its predictability, and enables us to identify the birth of the crash. We note that if an observer was limited to knowledge of just a single ‘world line’, then little could be said about the crash’s appearance until it became completely obvious. Irrespective of the fact that a crash arose, there is arguably a more fundamental ‘event’ which occurred in the system’s dynamics. This ‘event’ is the seemingly spontaneous convergence of the diversity of world-lines into the same direction. This convergence underlies the robustness of the resulting large change and hence the inevitability of the crash - in short the crash happened because of ‘fate’ as opposed to chance. This leads us to speculate that an ‘event’ in which a wide range of world-lines converge, may be fairly universal in complex systems, and Nature in general. In short, the reality that is observed in the physical world might correspond to robust ‘events’ involving convergence of world-lines, and as such is relatively unaffected by external noise/fluctuations.

4 Conclusion

We have investigated large changes in the Grand Canonical Minority Game (GCMG). The GCMG provides a simple, yet highly non-trivial, model for a complex system comprising a population of objects or ‘agents’ repeatedly competing for a limited global resource. We have focused on the many possible paths the multi-agent system may take in the vicinity of a possible large change. This ‘many-worlds’ view allowed us not only to predict the start and end of a large change, but also to investigate how such a large change might be avoided. We uncover the remarkable result that the complex system can be ‘immunized’ in order to protect it against large changes. In particular we find that by provoking a small response today in the system, we can protect it against much larger responses in the future.

References

- [1] A. Johansen and D. Sornette, preprint xxx.lan.gov/cond-mat/0010050.
- [2] J. Bouchaud, Theory of Financial Risks, Cambridge University Press (2000).
- [3] See <http://www.unifr.ch/econophysics> for a detailed account of previous work on agent-based games such as the Minority Game.
- [4] D. Challet and Y.C. Zhang, Physica A **246**, 407 (1997); *ibid.* **256**, 514 (1998); *ibid.* **269**, 30 (1999); B.W. Arthur, Am. Econ. Assoc. Papers and Proc **84**, 406, (1994); D. Challet and M. Marsili, Phys. Rev. E **60**, R6271 (1999); D. Challet, M. Marsili, and R. Zecchina, Phys. Rev. Lett. **84**, 1824 (2000); M. Marsili, D. Challet and R. Zecchina cond-mat/9908480; M Marsili and D. Challet cond-mat/0102257; R. Savit, R. Manuca and R. Riolo, Phys. Rev. Lett. **82**, 2203 (1999); R. D'Hulst and G.J. Rodgers, Physica A **270**, 514 (1999); A. Cavagna, J.P. Garrahan, I. Giardina and D. Sherrington, Phys. Rev. Lett. **83**, 4429 (1999); J.A.F. Heimerl and A.C.C. Coolen, cond-mat/0012045.
- [5] M. Hart, P. Jefferies, N.F. Johnson and P.M. Hui, cond-mat/0003486; Phys. Rev. E **63**, 017102 (2001); Physica A **298**, 537 (2001); Eur. J. Phys. B 2001 **20**, 547-550; P. Jefferies, M. Hart, N.F. Johnson and P.M. Hui, J. Phys. A: Math. Gen. **33** L409 (2000).
- [6] N.F. Johnson, P.M. Hui, D. Zheng and M. Hart, J. Phys. A: Math. Gen. **32** L427 (1999); N.F. Johnson, M. Hart and P.M. Hui, Physica A **269**, 1 (1999).
- [7] P. Jefferies, M. Hart and N.F. Johnson, Phys. Rev. E **65**, 016105 (2002).
- [8] M.L. Hart, P. Jefferies and N.F. Johnson, to appear in Physica A. cond-mat/0102384.
- [9] N.F. Johnson, M.L. Hart, P.M. Hui and D. Zheng, Theoretical and Applied Finance. **3**, 3, (2000).
- [10] Probability and Random Processes, G.R. Grimmett and D.R. Stirzaker, OUP (2000).
- [11] P. Jefferies, D. Lamper and N.F. Johnson, cond-mat/0201540

FIG. 1. Demonstration of the two possible values for the attendance given that $N_U \neq 0$ and $N_U > |A_D|$. Note that the area under the distribution between 0 and $A|\uparrow$, is equal to the area between $A|\uparrow$ and the top edge of the distribution. Similarly the area between 0 and $A|\downarrow$, is equal to the area between $A|\downarrow$ and the bottom edge of the distribution.

FIG. 2a. The 949 paths that the GCMG can take over 56 timesteps around the crash. The thick line shows the mean path, accounting for the differing probabilities of the paths.

FIG. 2b. The probabilities for the 949 paths, calculated using Eq. (5).

FIG. 2c. The measure λ of the spread in price-increments between all separate paths, as a function of time. Calculated using Eq. (6).

FIG. 3a. Probability tree for the first 33 timesteps, showing the probability of a path belonging to Set A, i.e. doing better than the mean at timestep 56.

FIG. 3b. The paths of the probability tree that have a cumulative movement of 0 up to timestep 33. Thick line shows the weighted mean.

FIG. 3c. The paths of the probability tree that have a cumulative movement of 2 up to timestep 33. Thick line shows the weighted mean.

FIG. 3d. The paths of the probability tree that have a cumulative movement of 4 up to timestep 33. Thick line shows the weighted mean.

FIG. 4a. The weighted histogram of cumulative sign of attendance for Set A, prior to the crash between timesteps 11 and 35.

FIG. 4b. The weighted histogram of cumulative sign of attendance for Set B, prior to the crash between timesteps 11 and 35.

FIG. 4c. The weighted histogram of cumulative sign of attendance for Set A, after the crash between timesteps 35 and 56.

FIG. 4d. The weighted histogram of cumulative sign of attendance for Set B, after the crash between timesteps 35 and 56.

FIG. 5. The $(m+1)$ -bit frequencies for Set A divided by Set B, in the period prior to the crash between timesteps 11 and 35.

FIG. 6. An $m = 3$ De-Bruijn graph. The edges show transitions between history states. Those edges with peak values above 1.15 in Fig. 5, have darker arrows. The transitions that are particularly weak are represented by dashed arrows.

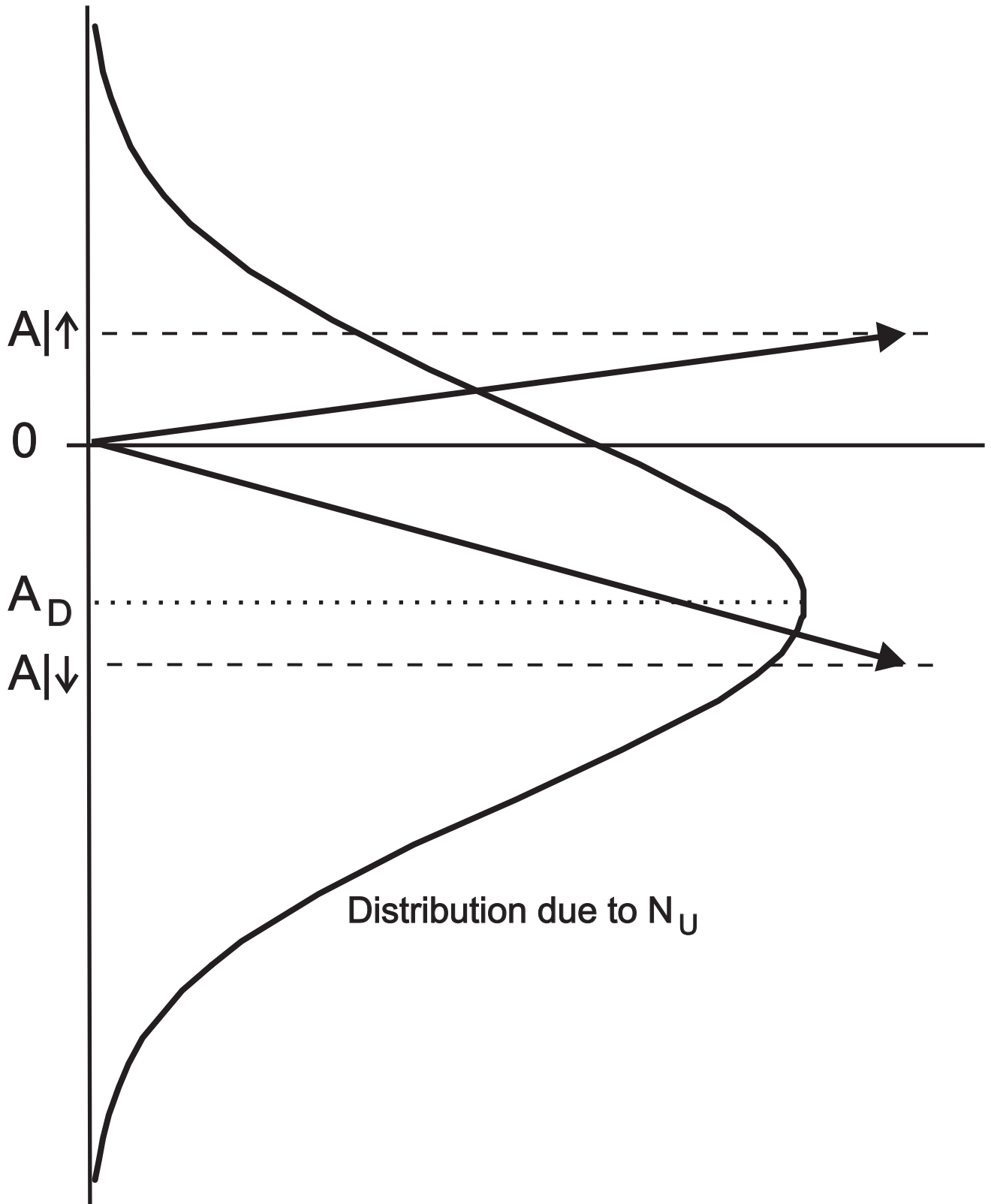
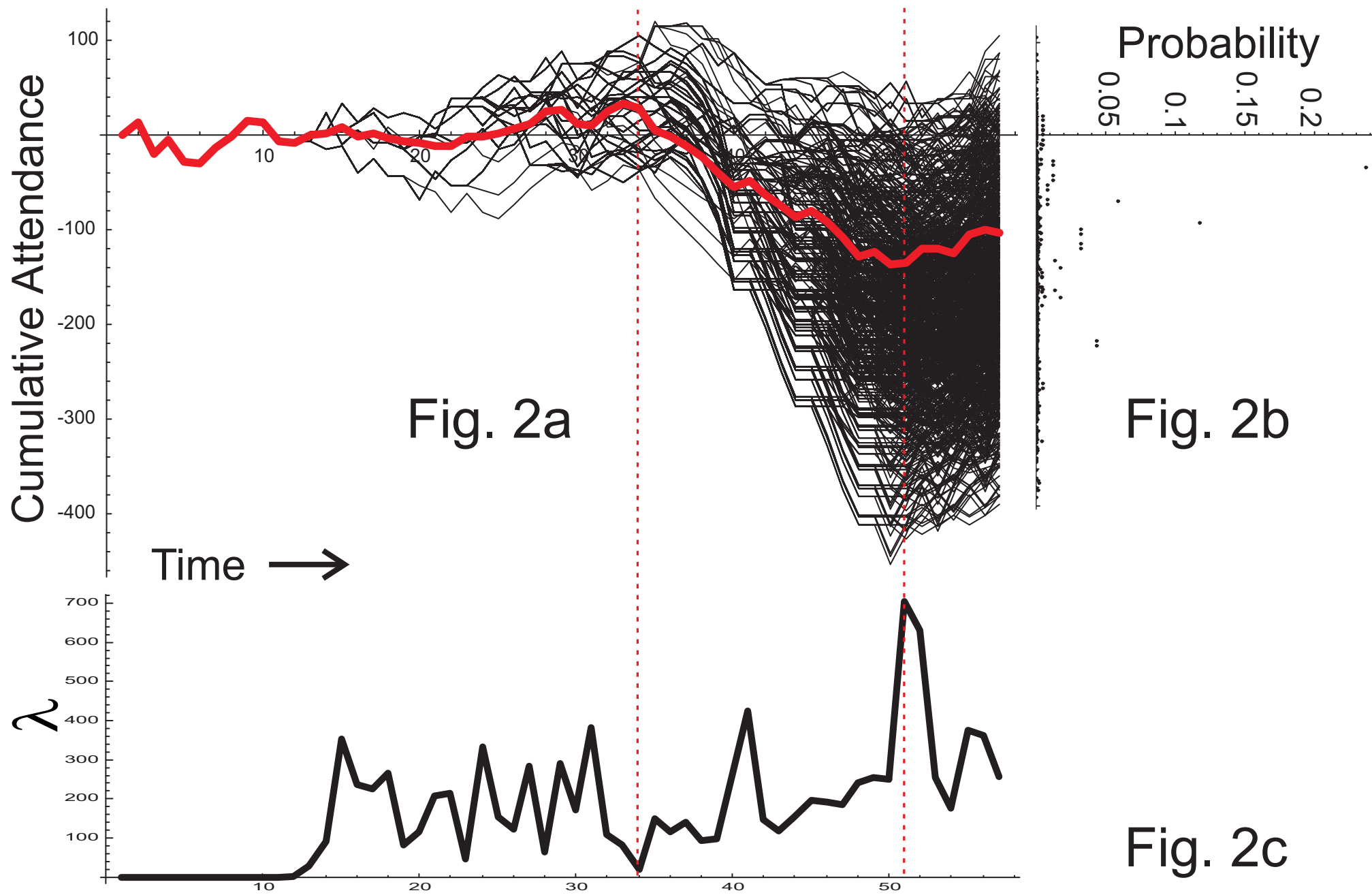
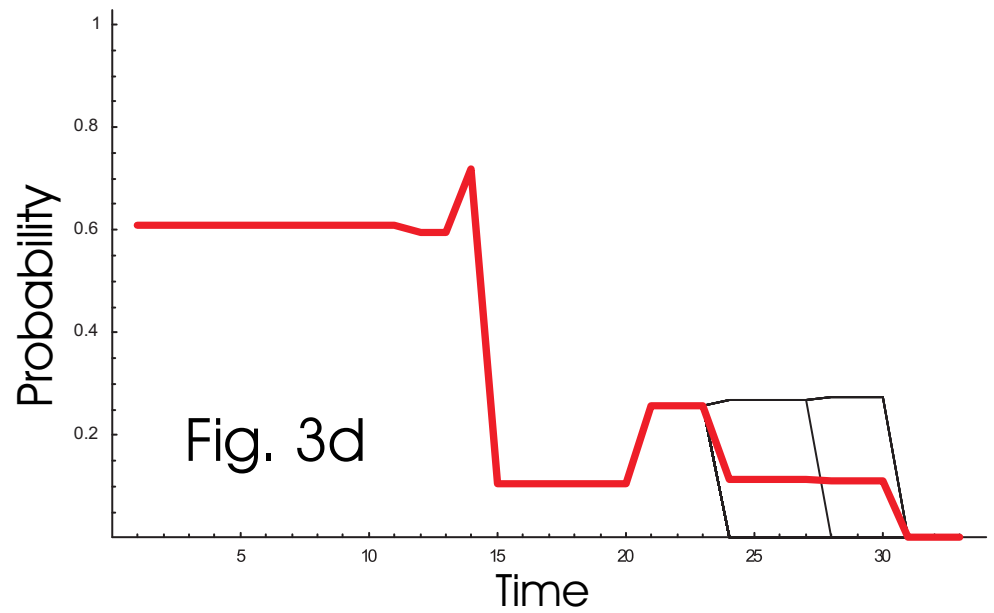
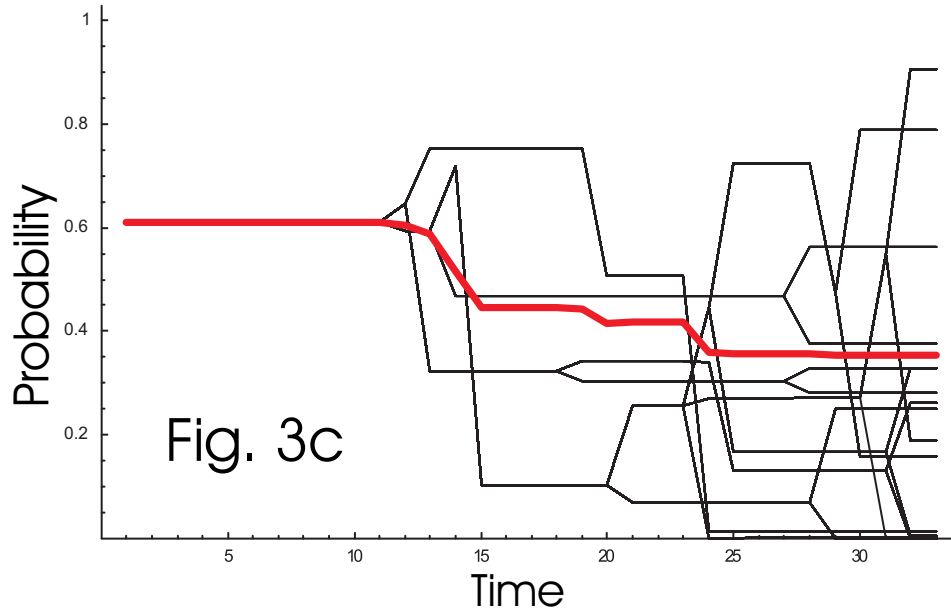
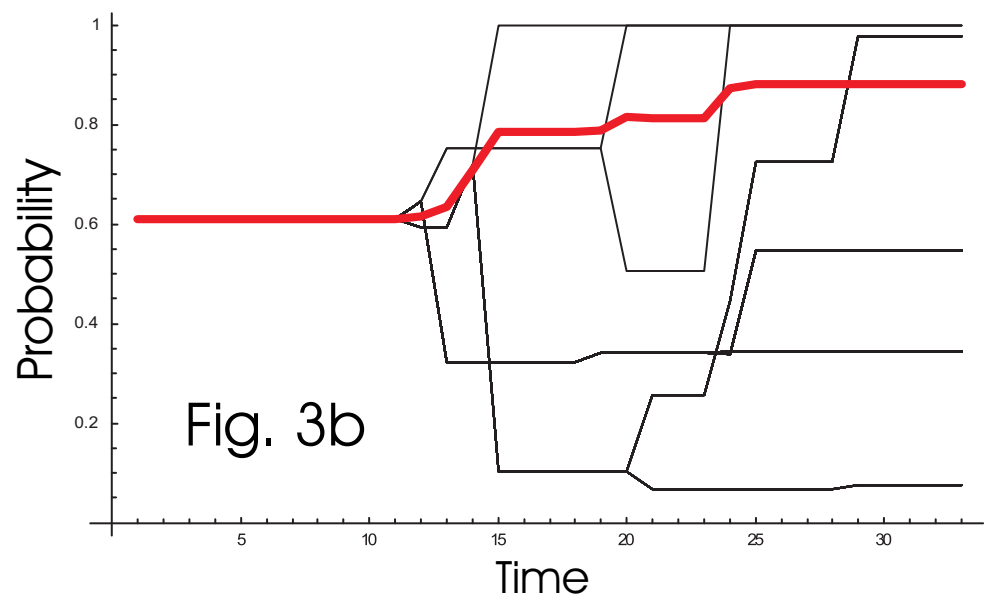
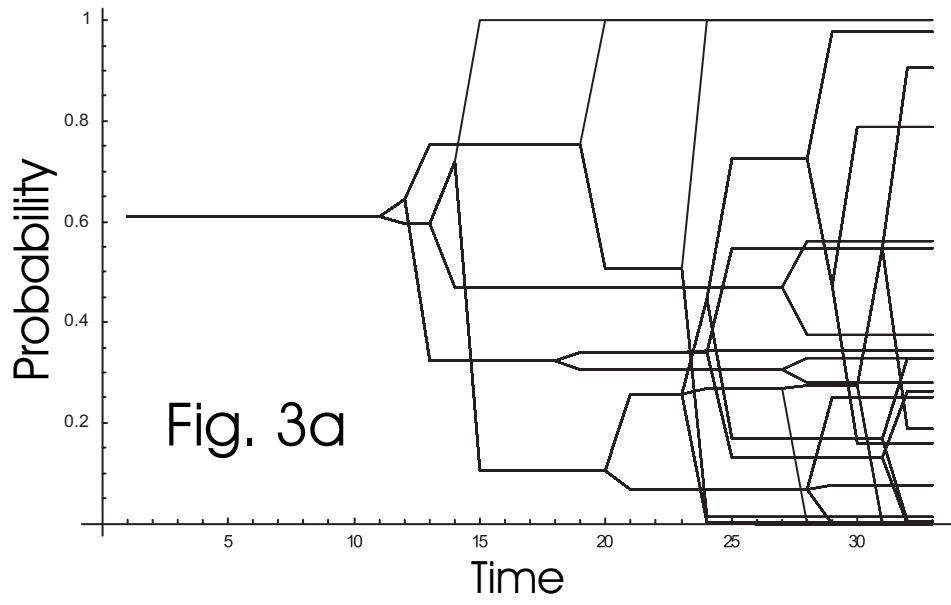
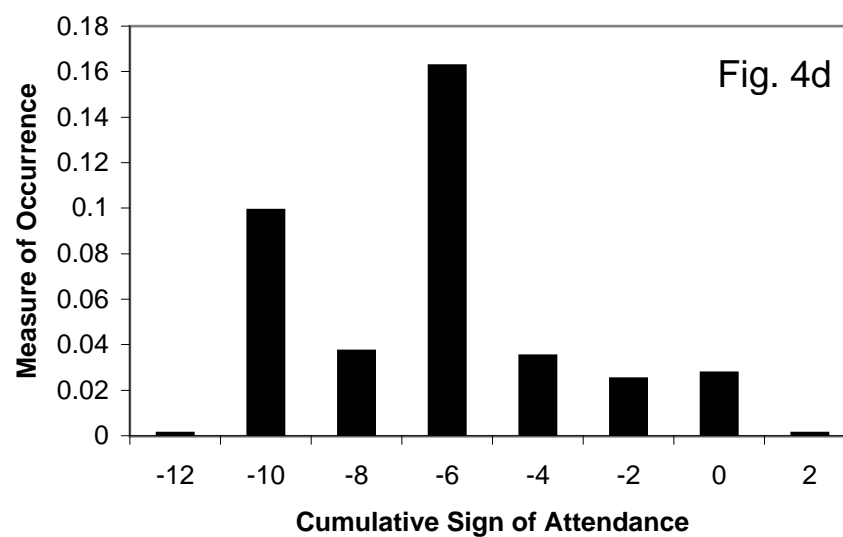
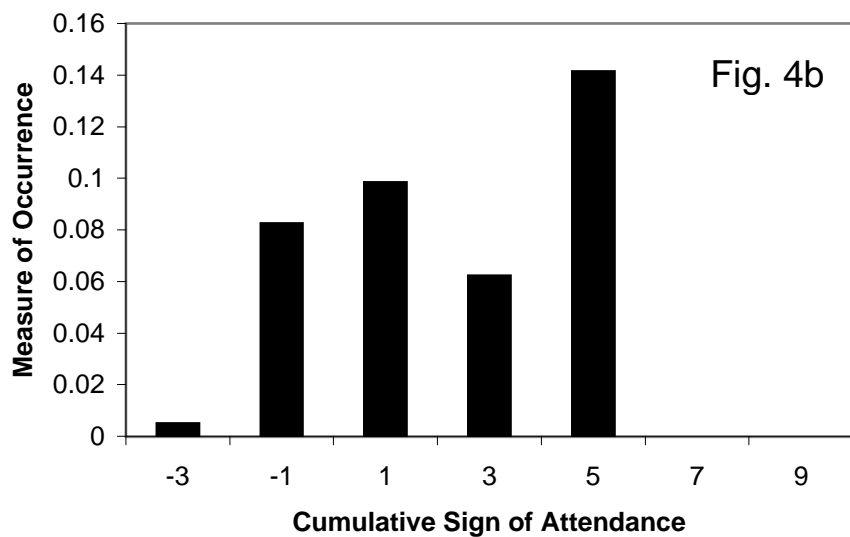
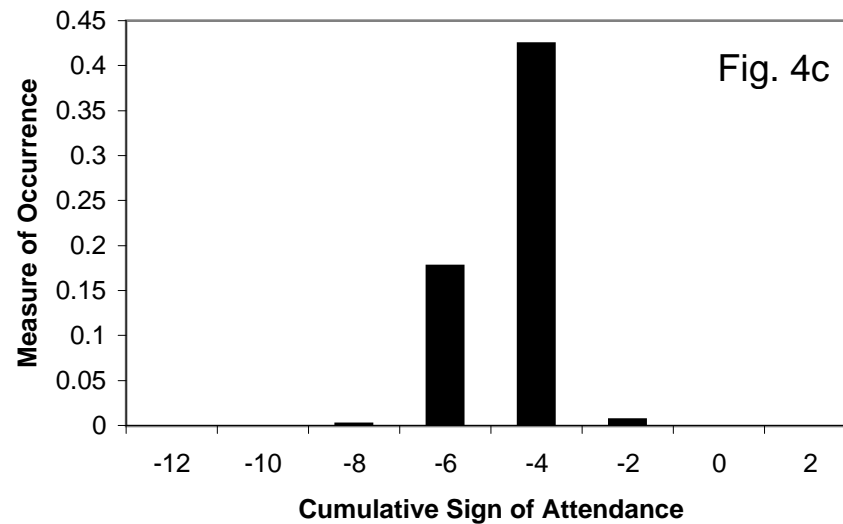
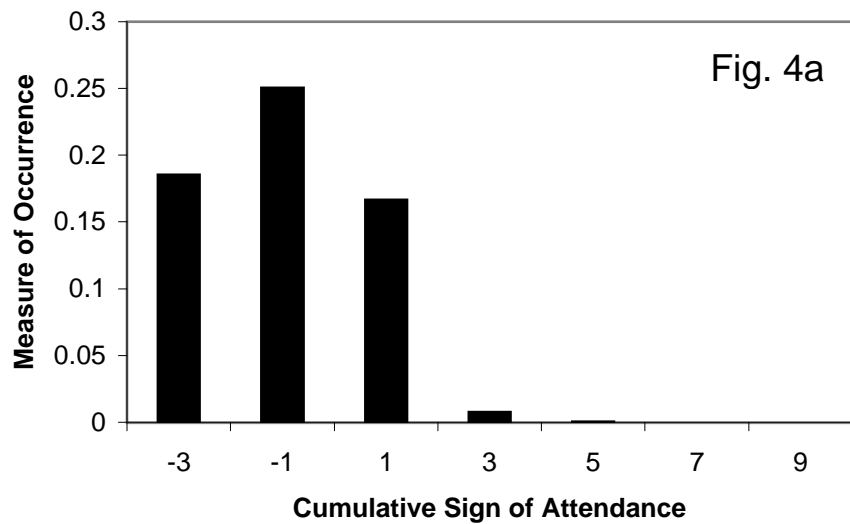

Fig. 1







Relative occurrence of a Word between sets A and B

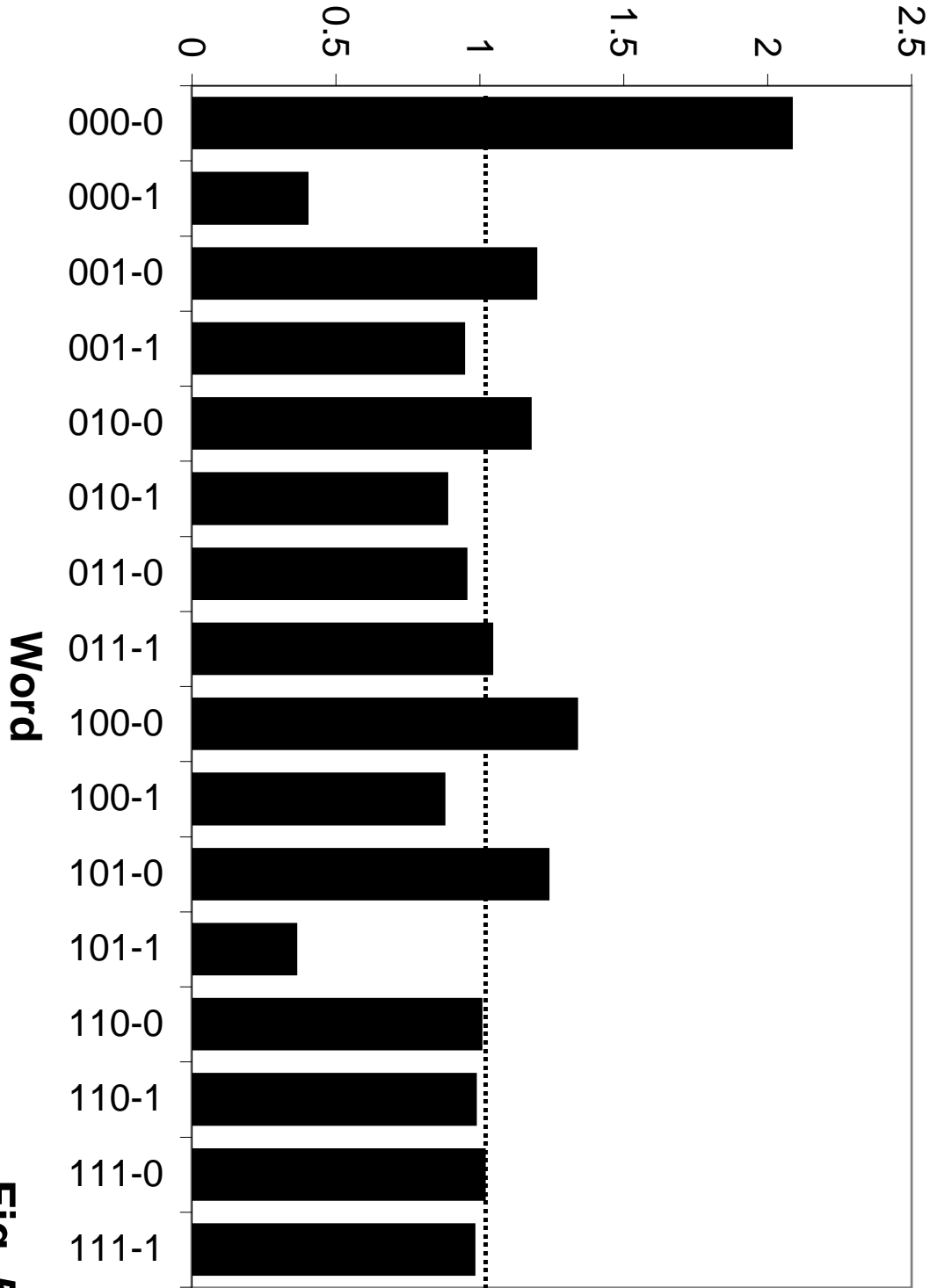

Fig. 5

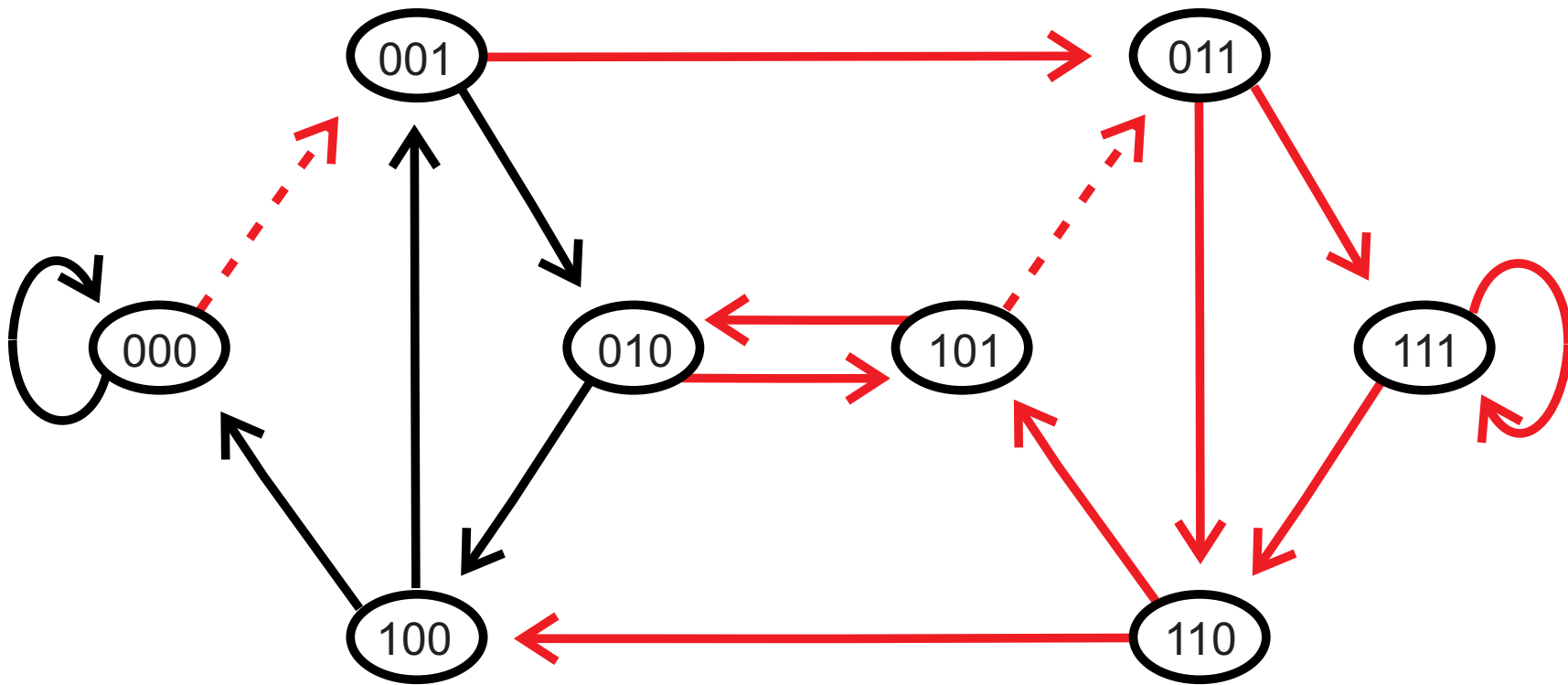

Fig.6