

# A FADC-based Data Acquisition System for the KASCADE-Grande Experiment

W. Walkowiak, T. Antoni, W.D. Apel, F. Badea, K. Bekk, A. Bercuci, M. Bertaina, H. Blümer, H. Bozdog, I.M. Brancus, M. Brüggemann, P. Buchholz, C. Büttner, A. Chiavassa, K. Daumiller, F. di Piero, P. Doll, R. Engel, J. Engler, F. Feßler, P.L. Ghia, H.J. Gils, R. Glasstetter, A. Haungs, D. Heck, J.R. Hörandel, K.-H. Kampert, H.O. Klages, Y. Kolotaev, G. Maier, H.J. Mathes, H.J. Mayer, J. Milke, B. Mitrica, C. Morello, M. Müller, G. Navarra, R. Obenland, J. Oehlschläger, S. Ostapchenko, S. Over, M. Petcu, S. Plewnia, H. Rebel, A. Risse, M. Roth, H. Schieler, J. Scholz, M. Stümpert, T. Thouw, G. Toma, G.C. Trinchero, H. Ulrich, S. Valchierotti, J. van Buren, A. Weindl, J. Wochele, J. Zabierowski, S. Zagromski, and D. Zimmermann

## Abstract

We present the design and first test results of a new FADC-based data acquisition (DAQ) system for the Grande array of the KASCADE-Grande experiment. The original KASCADE experiment at the Forschungszentrum Karlsruhe, Germany, has been extended by 37 detector stations of the former EAS-TOP experiment (Grande array) to provide sensitivity to energies of primary particles from the cosmos of up to  $10^{18}$  eV. The new FADC-based DAQ system will improve the quality of the data taken by the Grande array by digitizing the scintillator signals with a 250 MHz sampling rate.

The signals of each of the 37 detector stations are continuously recorded using interleaved 12-bit Flash Analog-to-Digital Converters (FADCs) located on custom-made digitizer boards at each station. The digitizer boards feature a self-triggering mechanism, initiating the data transmission to the Grande DAQ station using programmable thresholds, a timestamp mechanism, and optical data transmission. The control logic is implemented using Field Programmable Gate Arrays (FPGAs).

Five optical receiver and temporary storage modules receive the data from up to eight stations each (at an approximate rate of 2.5 MB/s per station) and transfer them into the memory of one of five PCs via a customized PCI interface card. Running on a master PC, the data acquisition software searches for coincidences in the timestamps, incorporates triggers generated by the other KASCADE-Grande components, and builds air shower events from the data of the individual stations. Completed Grande events are sent to the central DAQ of KASCADE-Grande at an approximate rate of a few air shower events per second.

Two Grande stations have been equipped with the FADC-based data acquisition system and first data are shown.

## Index Terms

Astroparticle physics instrumentation, FADC-based readout systems, KASCADE-Grande, Programmable logic

## I. INTRODUCTION

### A. The KASCADE-Grande Experiment

The KASCADE-Grande experiment [1] is an astroparticle physics experiment located at the site of the Forschungszentrum Karlsruhe, Germany, at 110 m above sea level comprising a large collection area of about  $0.5 \text{ km}^2$ . KASCADE-Grande has been

W. Walkowiak was the presenter at the IEEE 2004 Nuclear Science Symposium and is the corresponding author (e-mail: walkowiak@hep.physik.uni-siegen.de).

A. Bercuci, I. M. Brancus, B. Mitrica, M. Petcu and G. Toma are with National Institute of Physics and Nuclear Engineering, 7690 Bucharest, Romania.

A. Risse and J. Zabierowski are with Soltan Institute for Nuclear Studies, 90950 Lodz, Poland.

T. Antoni, H. Blümer, C. Büttner, J. R. Hörandel, M. Roth and M. Stümpert are with Institut für Experimentelle Kernphysik, Universität Karlsruhe, 76021 Karlsruhe, Germany.

W. D. Apel, F. Badea, K. Bekk, H. Blümer, H. Bozdog, K. Daumiller, P. Doll, R. Engel, F. Feßler, H. J. Gils, A. Haungs, D. Heck, H. O. Klages, G. Maier, H. J. Mathes, H. J. Mayer, J. Milke, M. Müller, R. Obenland, J. Oehlschläger, S. Ostapchenko, S. Plewnia, H. Rebel, H. Schieler, J. Scholz, T. Thouw, H. Ulrich, J. van Buren, A. Weindl, J. Wochele and S. Zagromski are with Institut für Kernphysik, Forschungszentrum Karlsruhe, 76021 Karlsruhe, Germany.

M. Brüggemann, P. Buchholz, Y. Kolotaev, S. Over, W. Walkowiak and D. Zimmermann are with Fachbereich Physik, Universität Siegen, 57068 Siegen, Germany.

M. Bertaina, A. Chiavassa, F. di Piero, G. Navarra and S. Valchierotti are with Dipartimento di Fisica Generale dell'Università, 10125 Torino, Italy.

P. L. Ghia, C. Morello and G. C. Trinchero are with Istituto di Fisica dello Spazio Interplanetario, CNR, 10133 Torino, Italy.

R. Glasstetter and K.-H. Kampert are with Fachbereich Physik, Universität Wuppertal, 42097 Wuppertal, Germany.

F. A. Badea is on leave of absence from Nat. Inst. of Phys. and Nucl. Engineering, Bucharest, Romania.

G. Maier is now at University Leeds, LS2 9JT Leeds, United Kingdom.

S. Ostapchenko is on leave of absence from Moscow State University, 119899 Moscow, Russia.

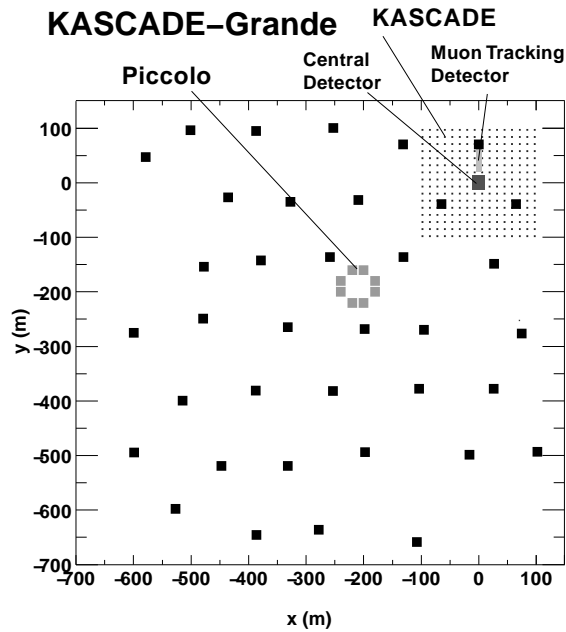

Fig. 1

LAYOUT OF THE KASCADE-GRANDE EXPERIMENT [1].

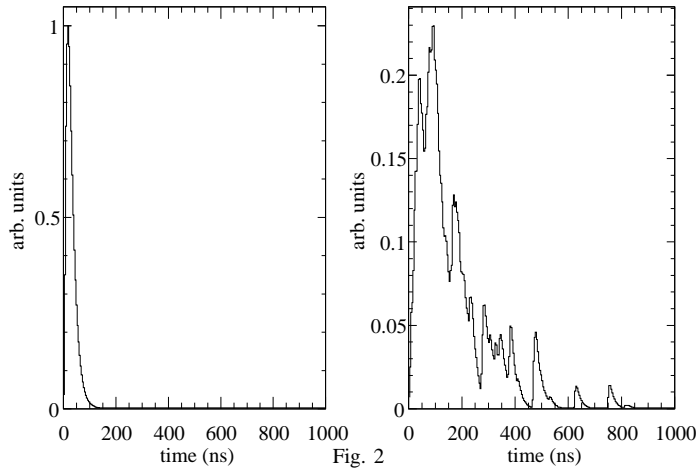

Fig. 2

SIMULATED SIGNAL SHAPE IN A SINGLE STATION FOR A  $10^{18}$  eV IRON INDUCED SHOWER AT 66.5 M (LEFT) AND 493.8 M (RIGHT) DISTANCE FROM THE SHOWER CORE.

designed to study extensive air showers induced by primary particles in the energy range of  $E_0 = 10^{14}$  to  $10^{18}$  eV. The major goal of the KASCADE-Grande experiment is the determination of the chemical composition of the primary particles in the energy range of the so-called “knee” in the cosmic-ray energy spectrum. Specifically, high quality data are needed to clearly identify the expected knee in the iron spectrum at about  $10^{17}$  eV. The measurement of the iron spectrum in this region will allow KASCADE-Grande to e.g. distinguish between different models for acceleration mechanisms of high-energy particles in the cosmos.

KASCADE-Grande [1] (fig. 1) consists of the KASCADE experiment [3], the Grande array with 37 stations of  $10 \text{ m}^2$  scintillation counters each – re-used from the former EAS-TOP experiment [4] – at an average mutual distance of approximately 137 m, and the trigger scintillator array Piccolo. The Piccolo array is placed between the centers of the Grande and KASCADE arrays and provides a common trigger to both, resulting in full detection efficiency for  $E_0 > 10^{16}$  eV. The KASCADE experiment consists of a square grid ( $200 \times 200 \text{ m}^2$ ) of 252 electron and muon detectors, an underground muon tracking detector for reconstructing the muon direction with an accuracy of  $\sigma \approx 0.35^\circ$ , and the central detector, which is mainly used for hadron measurements [5].

## B. The Grande DAQ System

Each Grande station contains 16 ( $80 \times 80 \text{ cm}^2$ ) plastic scintillator plates read out by photomultipliers with low and high gain resulting in a combined dynamic range of 0.3 to 30 000 vertical muons per station. In the current implementation the signals are amplified and then shaped inside the individual stations, transmitted to the central Grande DAQ station via 700 m long shielded cables, and digitized by peak sensing ADCs, thus providing a single value per station corresponding to the total energy deposit in this station. For triggering purposes, the Grande array is electronically subdivided into 18 overlapping hexagonal clusters of 7 stations each. For a 4-fold coincidence within each cluster a trigger rate of  $\sim 0.3 \text{ Hz}$  per cluster and of  $\sim 5.9 \text{ Hz}$  for the total of the Grande array has been measured [6]. The single muon rate per station has been measured to be approximately 2.2 kHz [2].

In the new implementation, in order to record the full time-evolution of energy deposits in the Grande stations induced by air showers, a new self-triggering, dead-time free FADC-based DAQ system with continuous 4 ns-sampling has been developed. Using the fine-grained sampling of the shower shapes we will gain additional information about shower characteristics, e.g. about the particle density development in the shower front or about the distance of a specific Grande station with respect to the shower core, since the expected pulse shapes for showers far from the shower core clearly differ from those close to the shower core (fig. 2). The 250 MHz sampling rate will provide a measurement of the shower front arrival time with an accuracy of about 1 ns or less [7].

## II. THE HARDWARE OF THE FADC-BASED DAQ SYSTEM

The new self-triggering FADC-based DAQ system features high time resolution of the signal shapes and an optical data transfer (fig. 3).

The scintillator pulses of a Grande detector are digitized on the digitizer board (KGEMD) by FADCs running in interleaved mode with an effective sampling rate of 250 MHz.

Fig. 4 depicts the part of the FADC data acquisition system which is being installed in the Grande DAQ station. The system consists of five optical receiver modules (KGEMS) which serve up to eight detector stations each, five DAQ computers with customized PCI interface cards (KGEMP) for temporary storage, and a master PC which is responsible for the event building. The DAQ computers are connected to the master PC via a private 1000 MBit/s ethernet.

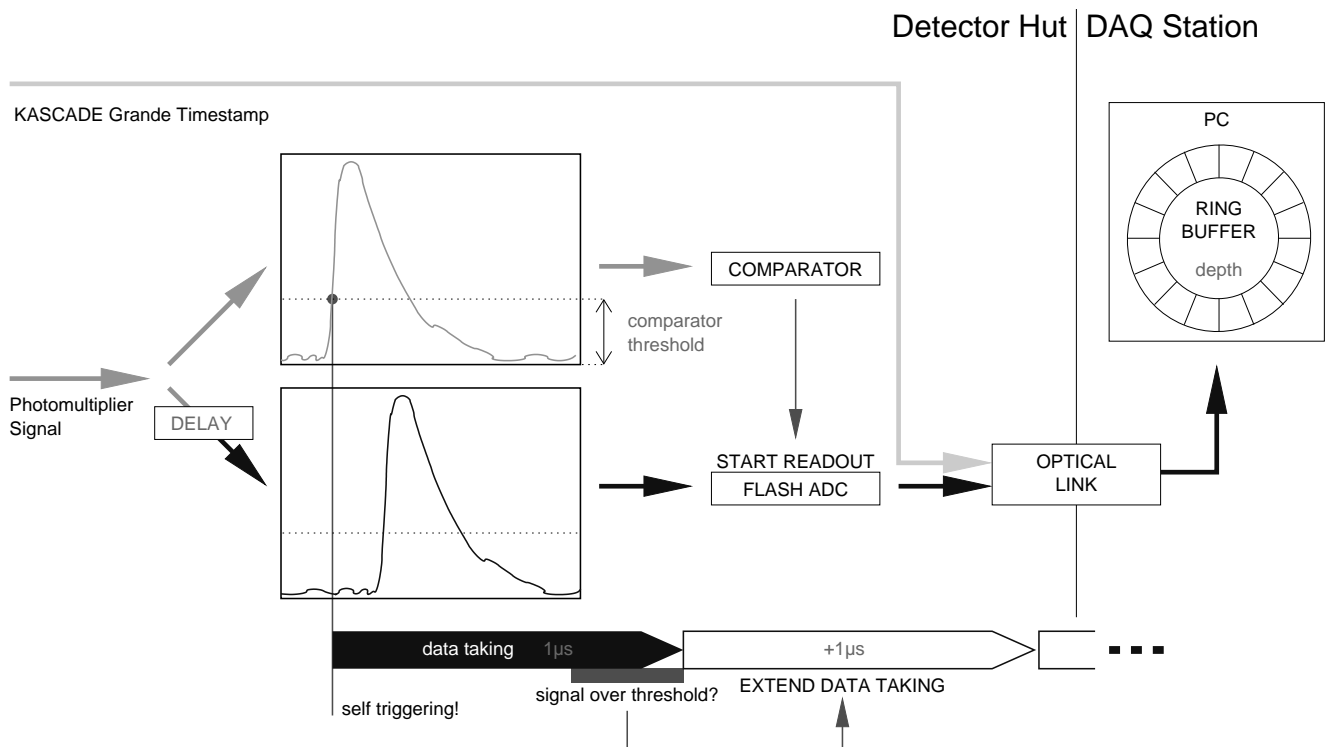

Fig. 3

CONCEPT OF THE FADC-BASED DATA ACQUISITION SYSTEM. [2]

## DAQ Station

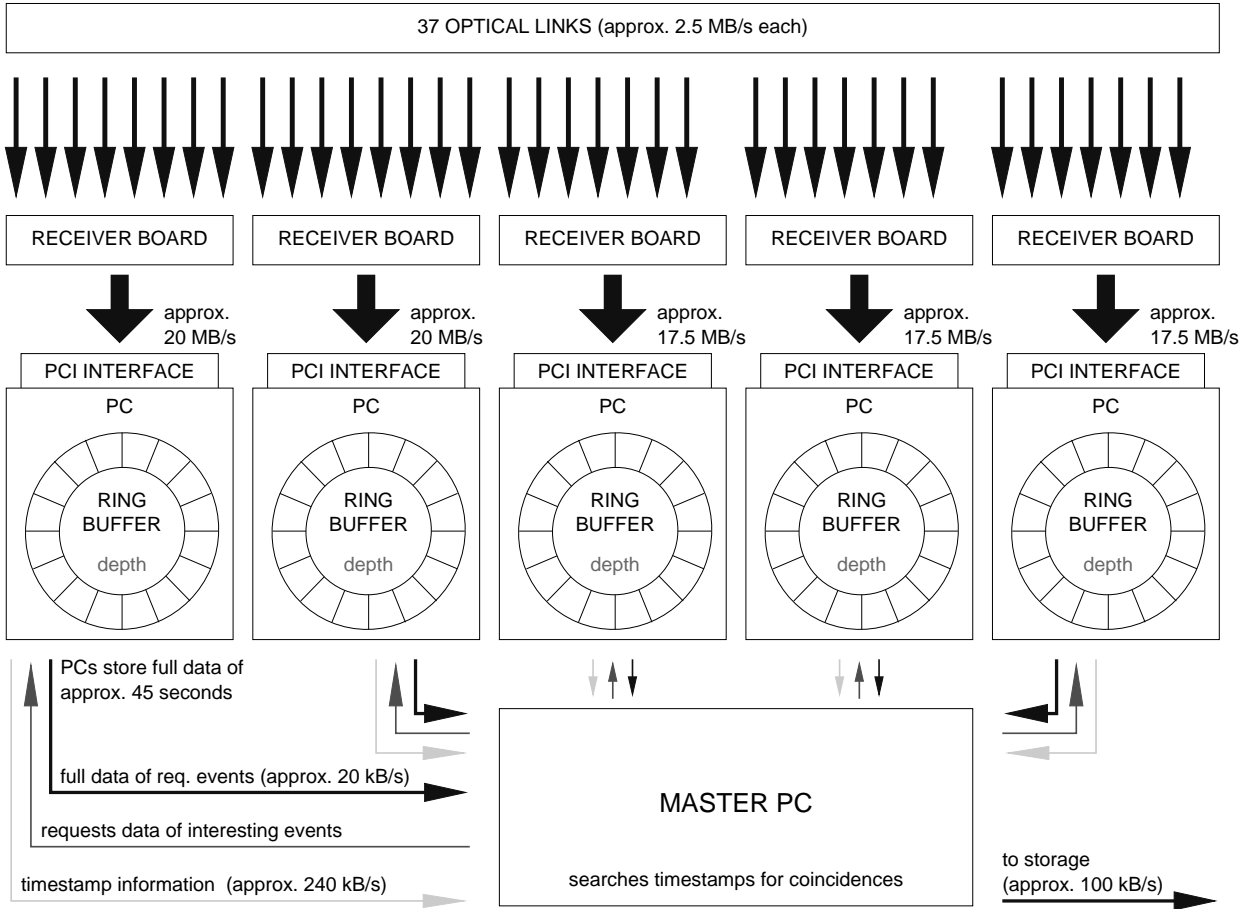

Fig. 4

DATA COLLECTION AND EVENT BUILDING IN THE DAQ STATION. [2]

### A. Event Digitization in the Grande Stations

The KGEMD (fig. 5) consists of two times four 12-bit FADCs (one set of four per gain range) running at 62.5 MHz and Field-Programmable-Gate-Arrays (FPGAs) which provide the necessary logic for the data management at readout and the generation of time stamps from external 1 Hz and 5 MHz signals [3]. The four FADCs per channel are operated in interleaved mode, i.e. with a relative time offset of 4 ns (corresponding to 90 degree phase shifted sampling clocks), such that the effective sampling rate of 250 Msamples/s is obtained. While the FADCs are continuously digitizing the waveform, their data are only transferred to buffering FIFOs once the adjustable comparator threshold is crossed. Taking advantage of the internal delay of the FADC, which corresponds to 7 clock cycles, the recorded signal waveform contains data for up to 112 ns ahead of the threshold crossing time. The signal waveform has a typical length of about  $1 \mu\text{s}$ . Time stamp information of several counters, which are synchronized by external 1 Hz and 5 MHz signals, and an identifier for the station number are added to the data packet before it is transmitted to the Grande DAQ station via an optical link (1300 nm laser diode, distance up to 800 m, data transfer rate of 1.25 GBaud). The data packet for a single  $1 \mu\text{s}$  long event containing both, high and low gain data, consists of 512 16-bit words, i.e. a total of 1 kByte data per event. In case the input signal exceeds the threshold during the last part (typically the last 200 ns) of the previous  $1 \mu\text{s}$  period, another  $1 \mu\text{s}$  long data packet is seamlessly added.

### B. Data Collection and Event Building in the DAQ station

Fig. 6 shows a photograph of the 9U VME receiver module, KGEMS. In order to derandomize the incoming data, each of the eight optical input channels (left side) is buffered by a FIFO, which can hold up to 16 full single station event data packets. These are multiplexed onto one output buffer using FPGAs and passed on to the PCI interface card via a 32-bit wide LVDS link. The VME bus is used to upload the configuration and for debugging purposes.

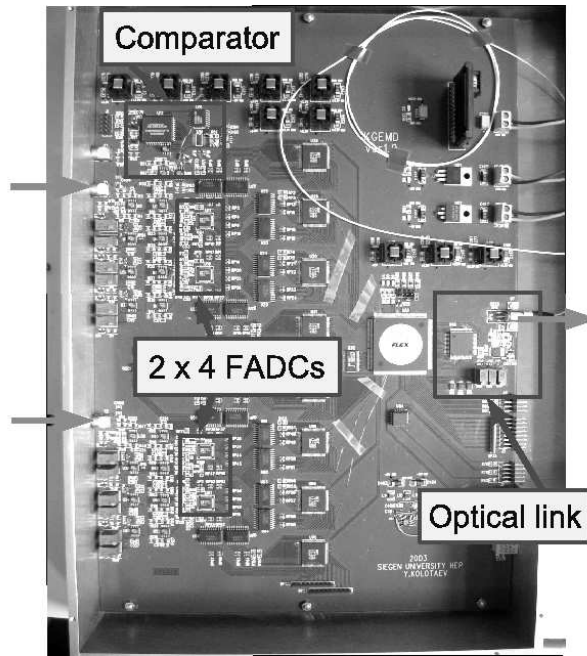

Fig. 5

PHOTOGRAPH OF THE DIGITIZER BOARD (KGEMD). THE HIGH AND LOW GAIN INPUTS ARE INDICATED ON THE LEFT HAND SIDE.

The PCI interface (fig. 7) consists of a commercial PCI prototyping board and a custom made piggy-back card, which receives the data via the LVDS link from the receiver board. The PCI-interface uses the Direct Memory Access (DMA) mechanism to write the data to a ring buffer inside the DAQ computer. While 128 MB of the 1 GB memory of the DAQ computer have been reserved for the Linux operating system, the major part (896 MB) is used for incoming events. A custom-written driver enables user space programs to access this ring buffer as events become available [2]. Data transfer rates to the PC's memory of 85 MByte/s have been achieved, while on average a rate of 20 MByte/s is needed. At this nominal rate the ring buffer memory may hold up to 45 s of event data. In addition, the DAQ PCs have the capability to generate high statistic histograms for any desired quantity based on single station events, such as distributions related to the energy per event deposited in a single station. The typical shape of the latter provides input to an energy calibration of the Grande detector stations (by comparison with the expected shape from a Monte Carlo simulation).

The master PC only obtains the timestamp information from the DAQ PCs (approximate rate of 30 kB/s) and scans it for coincidences. It requests the corresponding data from the DAQ computers for interesting events only. After event building the events are put to mass storage and can be forwarded to the central DAQ of KASCADE-Grande at an approximate rate of 100 kByte/s. The system allows for a flexible definition of the selection criteria. More sophisticated criteria than simple coincidences in time may be implemented in the future.

### III. SYSTEM INSTALLATION

Recently, two Grande detector stations have been equipped with one digitizer board each. One receiver module servicing the corresponding two optical links has been set up in conjunction with the necessary PC and its PCI-interface card. Single station events have been recorded at an approximate rate of 2.5 kHz per station. A sample event is shown in (fig. 8). The different markers denote the data taken by the four different FADCs of each channel, which have been intercalibrated in order to account for slightly different gains and offsets of the individual FADCs. This picture nicely demonstrates the need for the high- and low-gain channels: While the high gain channel is saturated by the peak, there is still ample room for even taller signal peaks in the low gain channel.

Production of the necessary components for the full system for all 37 detector stations is progressing. The completion of the FADC DAQ system is envisaged for 2005. Using the input from the two detector stations already equipped, the event building software is currently being implemented.

#### IV. CONCLUSIONS

A self-triggering, dead-time free FADC-based DAQ system with a 4 ns sampling and high resolution of 12 bits in two input gain ranges each has been designed for the KASCADE-Grande experiment and is being built. The system will provide KASCADE-Grande with the full pulse shape information covering the entire thickness of the shower front. This additional information will greatly improve the data quality and prove valuable for the reconstruction of extensive air showers as new (or improved) observables are identified.

Recently, two Grande stations of KASCADE-Grande have been equipped with FADC-based digitizer boards and the DAQ chain up to the first DAQ computer has been operated successfully. In 2005 data taking with the FADC system for all 37 detector stations is scheduled to commence.

## V. ACKNOWLEDGEMENTS

The authors would like to thank the technical staff at Siegen and at the Forschungszentrum Karlsruhe, who have been working on the design, production, testing and installation of the FADC system. Their dedication made it possible for us to begin with the installation of the system during the summer of 2004.

The KASCADE-Grande experiment is supported by the Federal Ministry of Education and Research (BMBF) of Germany, the Polish State Committee for Scientific Research (KBN grant for the years 2004 to 2006) and the Romanian National Academy for Science, Research and Technology.

## REFERENCES

- [1] G. Navarra et al. (KASCADE-Grande collaboration), "KASCADE-Grande: a large acceptance, high-resolution cosmic-ray detector up to  $10^{18}$  eV," *Nucl. Instrum. Meth.*, vol. A518, pp. 207–209, 2004.
- [2] S. Over, "Development and commissioning of data acquisition systems for the KASCADE-Grande experiment," *diploma thesis*, Siegen, Germany, 2004.
- [3] T. Antoni et al. (KASCADE collaboration), "The cosmic-ray experiment KASCADE," *Nucl. Instrum. Meth.*, vol. A513, pp. 490–510, 2003.
- [4] M. Aglietta *et al.*, "UHE cosmic ray event reconstruction by the electromagnetic detector of EAS-TOP," *Nucl. Instrum. Meth.*, vol. A336, pp. 310–321, 1993.
- [5] T. Engler et al., "A warm-liquid calorimeter for cosmic-ray hadrons," *Nucl. Instrum. Meth.*, vol. A427, pp. 528–542, 1999.
- [6] K.-H. Kampert et al. (KASCADE-Grande collaboration), "Status of the KASCADE-Grande experiment," *Nucl. Phys. B (Proc. Suppl.)*, vol. 122, pp. 422–426, 2003.
- [7] V. Andrei, "Reconstruction algorithms for the FADC DAQ system of the KASCADE-Grande experiment," *diploma thesis*, Siegen, Germany, 2004.

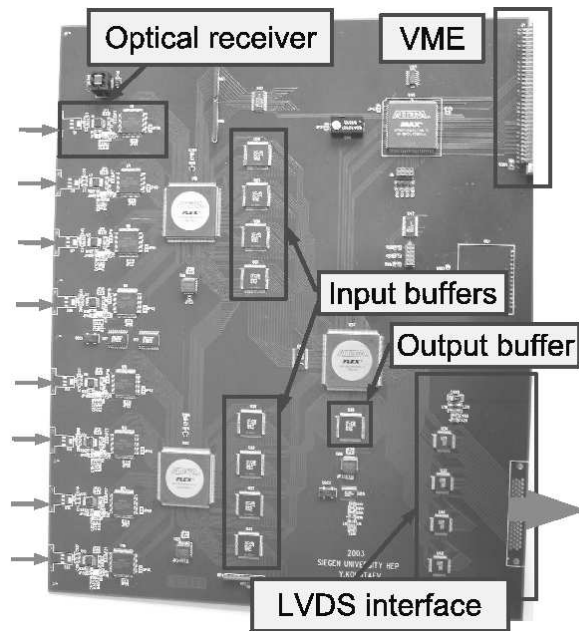

Fig. 6

PHOTOGRAPH OF THE RECEIVER MODULE BOARD (KGEMS). THE OPTICAL INPUTS FROM UP TO EIGHT DETECTOR STATIONS ARE INDICATED ON THE LEFT HAND SIDE.

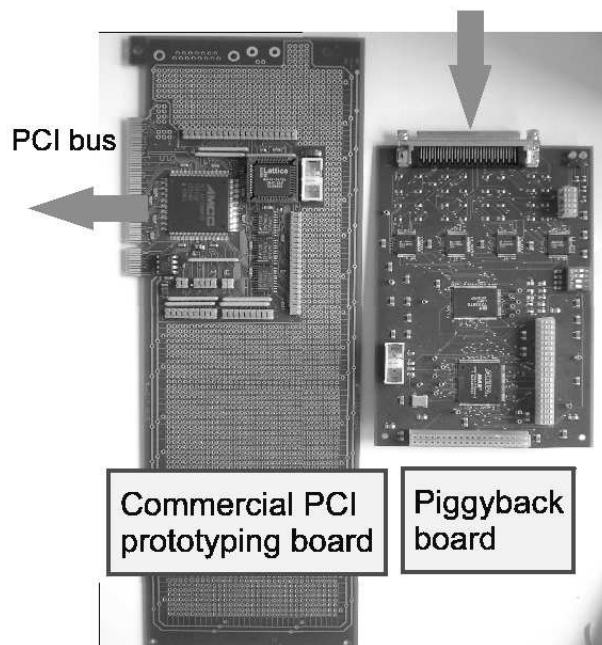

Fig. 7

PHOTOGRAPH OF THE PCI INTERFACE CARD (KGEMP). THE LVDS INPUT FROM THE ONE RECEIVER BOARD SERVICING UP TO EIGHT DETECTOR STATIONS IS INDICATED IN THE UPPER RIGHT CORNER.



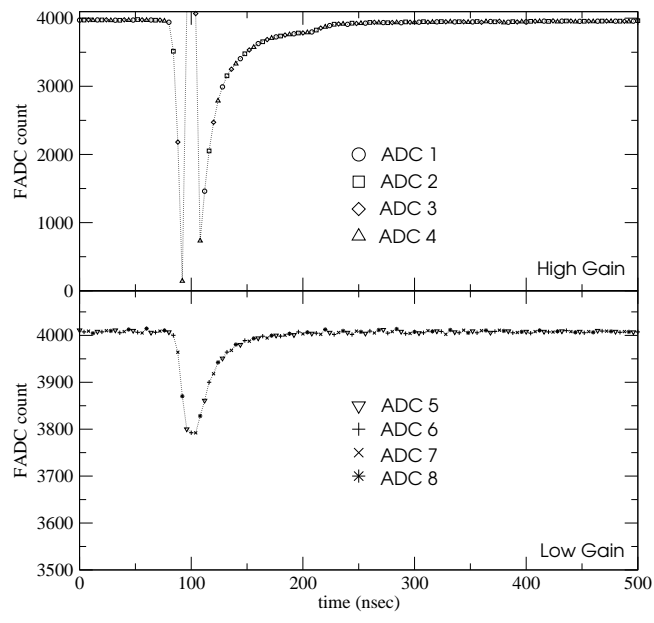

Fig. 8

SAMPLE SIGNAL EVENT IN THE HIGH AND LOW GAIN CHANNELS FOR ONE STATION. THE DATA OF THE FOUR INTERLEAVED FADCs PER CHANNEL ARE MARKED BY DIFFERENT SYMBOLS.