

Polar fields for AB Doradus

T. McIvor¹, M. Jardine¹, A. Collier Cameron¹, K. Wood¹ and J.-F. Donati² *

¹*School of Physics and Astronomy, Univ. of St Andrews, St Andrews, Scotland KY16 9SS*

²*Laboratoire d'Astrophysique, Observatoire Midi-Pyrénées, 14 Av. E. Belin, F-31400 Toulouse, France*

Received; accepted

ABSTRACT

Polar spots are often observed on rapidly-rotating cool stars, but the nature of the magnetic field in these spots is as yet unknown. While Zeeman-Doppler imaging can provide surface magnetic field maps over much of the observed stellar surface, the Zeeman signature is suppressed in the dark polar regions. We have determined the effect on the global coronal structure of three current models for this polar field: that it is composed (a) of unipolar field, (b) of bipolar regions or (c) of nested rings of opposite polarity. We take as an example the young, rapid rotator AB Dor ($P_{\text{rot}} = 0.514$ days). By adding these model polar fields into the surface field maps determined from Zeeman-Doppler imaging, we have compared the resulting coronal structure with the observable properties of the corona - the magnitude and rotational modulation of the X-ray emission measure and the presence of slingshot prominences trapped in the corona around the Keplerian co-rotation radius. We find that only the presence of a unipolar spot has any significant effect on the overall coronal structure, forcing much of the polar field to be open.

Key words: stars: activity – stars: imaging – stars: individual: AB Dor – stars: coronae – stars: spots

1 INTRODUCTION

Since the advent of Doppler imaging it has been possible to map the distributions of starspots on rapidly-rotating stars. This has revealed that starspots are typically found not only at the low latitudes where sunspots emerge, but also at very high latitudes, extending all the way to the pole (Strassmeier 1996). At present there is no consensus on the origins of these high-latitude spots. The only thing that is clear is that rapid rotation seems to play an important role.

Three possible models have been proposed to explain the latitudinal distribution of starspots. As early as 1992, Schuessler & Solanki (1992) proposed that flux tubes formed deep in the stellar convective zone would be deflected poleward by Coriolis forces as they attempted to rise buoyantly to the surface (Granzer et al. 2000). This would result in a polar cap that was formed of mixed polarity regions of a similar nature to those at lower latitudes. More recently, Schrijver & Title (2001) have presented a model for flux emergence on rapid rotators. A poleward meridional flow carries bipoles towards the poles while at the same time diffusion attempts to disperse them. The inclination of these

bipoles to the equator causes the trailing polarities to reach the pole first, leading to a flux distribution which resembles concentric rings of alternating polarity encircling the pole. Finally, Kellett et al. (2002) have suggested on the basis of radio observations that the polar caps are formed of unipolar field, perhaps part of a large-scale dipole.

In all of these scenarios, the polar caps would appear dark in a Doppler image if the polar fields were strong enough to suppress convection. What these Doppler images cannot reveal is whether the polar field is composed of closed loop structures which may be bright in X-rays, or open field regions which may contribute to the stellar wind. This question becomes of importance when considering the processes of angular momentum loss in a stellar wind, which has traditionally been modelled on the basis of an aligned dipole field where most of the open (wind-bearing) field lines emerge from near the stellar pole. It is also relevant to studies of disk-magnetosphere interaction and channeled accretion flows in young stars.

The purpose of this paper is to determine if there are any observational tests that could distinguish between these three different models for the nature of the polar field. We do this by modelling the effect of these different models on

* E-mail: tm29@st-and.ac.uk

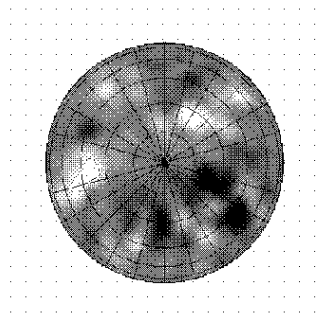

(a)

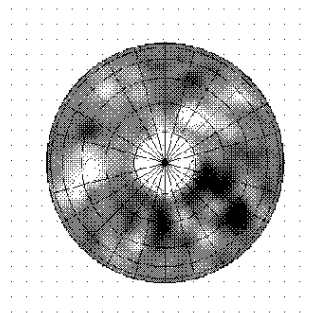

(b)

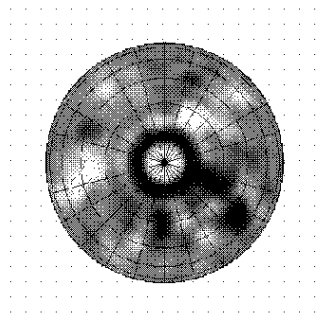

(c)

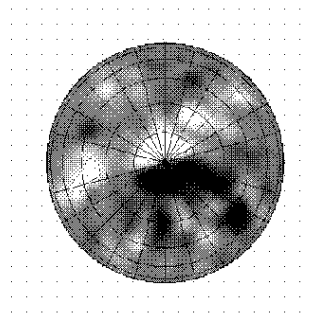

(d)

Figure 1. Surface maps of the magnetic field for AB Dor for Dec 1995 shown from a viewpoint looking down on the rotation pole. Fig 1a shows the surface magnetic field as it is observed with no field added to the polar region. Fig 1b has a large unipolar spot, Fig 1c, concentric rings of opposite polarity and fig 1d, the bipolar configuration. The strength of the field added to each model is 1KG.

the structure of the coronal magnetic field and the nature of its X-ray emission.

2 AB DORADUS

We take as our example star the young rapid rotator AB Doradus which has been studied in depth for the last decade or so. Surface brightness maps have been collected annually since 1988 (Collier-Cameron & Unruh 1994; Unruh et al. 1995; Collier Cameron 1995). In the last seven years Zeeman-Doppler maps of the surface magnetic field have been secured on an annual basis. Long term studies of the star's X-ray variability have shown a small rotational modulation (5-13 %) and a large emission measure of $10^{52-53} \text{ cm}^{-3}$ (Vilhu et al. 1993). This implies that AB Dor has either a very extended or very dense corona. AB Dor has an inclination of 60° and therefore much information about the lower hemisphere is lost. In the upper hemisphere however, the pole remains in view constantly and X-ray emission from high latitudes would therefore suffer little rotational modulation. BeppoSax observed a flare (Maggio et al. 2000) that showed no rotational modulation over a period greater than the rotation period of the star. Modelling of the flare decay showed that the flaring loops must be small and hence must be situated at latitudes above 60° in order to remain in view.

Complementary to these observations are spectroscopic studies of the star's X-ray emission from which the thermal structure, abundance stratification, and densities of the corona can be investigated. Recent studies with XMM showed coronal densities to be extremely high ranging from $3 \times 10^{10} \text{ cm}^{-3}$ (Güdel et al. 2001) to 10^{12} cm^{-3} . This high density immediately suggests that the emitting loops would be relatively small and compact. If this is the case, to explain the lack of rotational modulation, these loops would have to be located at latitudes high enough to remain in view as the star rotates. High latitude magnetic loops are consistent with Doppler images of AB Dor where we can see dark polar spots along with spots at lower latitudes. Zeeman-Doppler images show magnetic flux to be present all over the surface of AB Dor apart from at the poles where the surface brightness is so low that the Zeeman signal is suppressed (Donati & Collier Cameron 1997).

Any model applied for the field at the pole will have to explain the lack of rotational modulation in the X-ray emission as well as being consistent with the observations of large prominences that form preferentially at or just beyond the Keplerian co-rotation radius, which for AB Dor is at 2.7 stellar radii from the rotation axis (Collier Cameron & Robinson 1989a,b). As many as six prominences may be present at any one time in the observable hemisphere of the star. Since they co-rotate with the star, they must be held in place by the coronal magnetic field. This suggests that at least some fraction of the coronal field is in the form of closed loops even at these large distances.

The structure of the large scale coronal magnetic field of AB Dor was investigated by Jardine et al. (2002a). They took the surface magnetic field determined from Zeeman-Doppler imaging and extrapolated it into the corona, assuming it to be potential. They found that the closed field

regions of the corona extended over the polar regions. By filling the corona with isothermal plasma in hydrostatic equilibrium, they determined the spatial distribution of the coronal X-ray emission (Jardine et al. 2002b). Much of this emission came from high-latitude regions where it was never rotationally self-eclipsed. This naturally gave a low rotational modulation in X-rays, similar to the observed value. The derived magnitude of the emission measure and the emission-measure weighted mean density were also consistent with observations. Jardine *et al* also explored the effect on the X-ray emission of adding in a global dipole and determined that because this would cause the polar regions to be open (and hence dark in X-rays) this could not be reconciled with the BeppoSAX flare observations that suggest the presence of closed loops at high latitudes (Maggio et al. 2000).

In this paper, we consider the impact of some alternative models that may explain the dark polar caps. Rather than a global dipole which extends over the whole surface, we consider a single unipolar spot at the pole which covers a limited surface area. We also consider two possibilities for mixed-polarity regions at the pole: either a single bipole or concentric rings of alternating polarity. These configurations were added to the poles of the 1995-1996 mixed map of AB Dor. In each case the global field was extrapolated and the positions of stable points which are possible prominence formation sites and the X-ray emission were determined. The effects on these properties were examined for different strengths of polar field ranging from 500G to 2000G. Below this upper limit, polar fields would escape detection. Although the polar areas on AB Dor are dark and the Zeeman signal is thus suppressed, Donati & Collier Cameron (1997) have shown that if the polar region was to have a field in excess of a few thousand Gauss there would be some signal of the polar field detected by Zeeman-Doppler imaging.

3 EXTRAPOLATING THE CORONAL FIELD

The extrapolation of the field is the same as used in Jardine, Collier Cameron & Donati (2002). Since the method is the same we refer to the previous mentioned paper for a detailed description of the calculations involved. We write the magnetic field \mathbf{B} in term of a flux function Ψ such that $\mathbf{B} = -\nabla\Psi$ and the condition that the field is potential ($\nabla \times \mathbf{B} = 0$) is satisfied automatically. The condition that the field is divergence-free then reduces to Laplace's equation $\nabla^2\Psi = 0$. A solution in terms of spherical harmonics can then be found:

$$\Psi = \sum_{l=1}^N \sum_{m=-l}^l [a_{lm}r^l + b_{lm}r^{-(l+1)}]P_{lm}(\theta)e^{im\phi}, \quad (1)$$

where the associated Legendre functions are denoted by P_{lm} . The coefficients a_{lm} and b_{lm} are determined by imposing the radial field at the surface from the Zeeman-Doppler maps and assuming that at some height R_s above the surface the field becomes radial. Due to the presence of large slingshot prominences observed around the co-rotation radius which lies at $2.7R_*$ from the rotation axis, we believe that much of the corona is closed out to those heights and so we set the value of R_s to $3.4R_*$. In order to calculate the field we

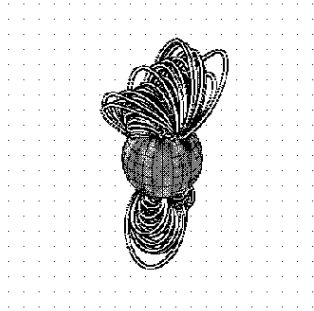

(a)

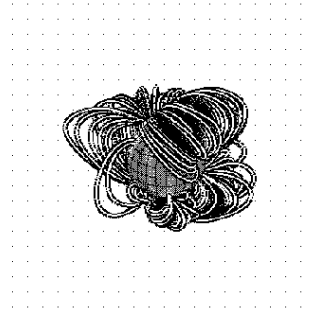

(b)

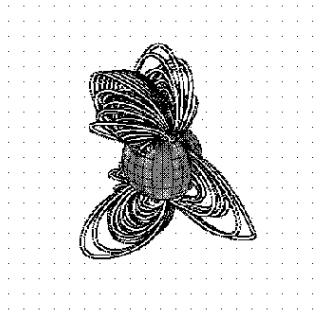

(c)

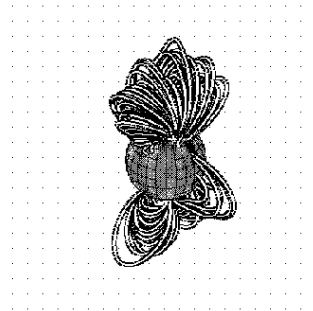

(d)

Figure 2. Closed field emerging only from the polar regions where we have added flux. Strong similarities can be seen between the original image, concentric rings and bipole models. In these cases the field lines from the polar region connect primarily to the surface at high latitudes. Only in the case of a unipolar spot (b) do the field lines connect to the rest of the stellar surface.

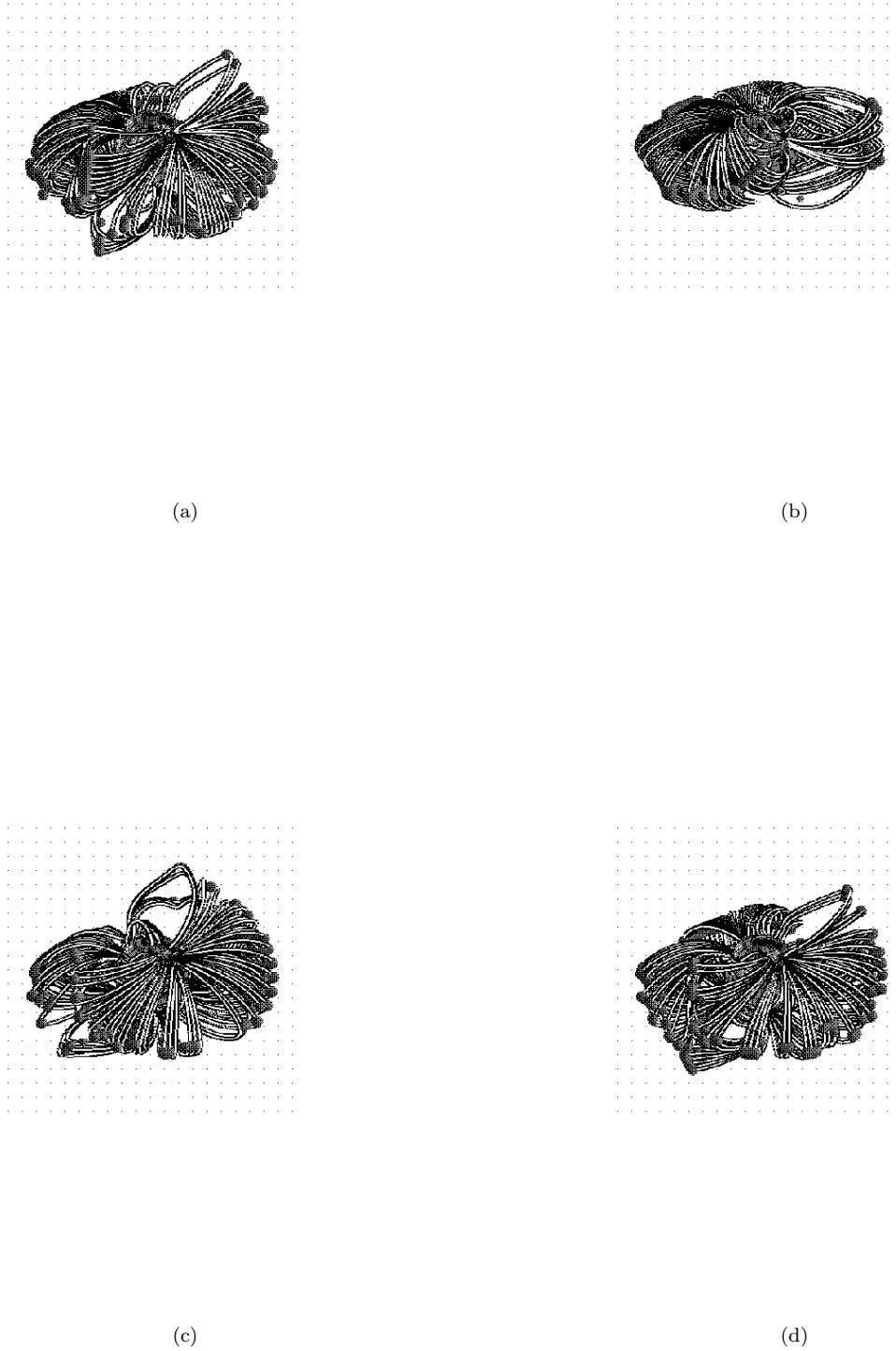
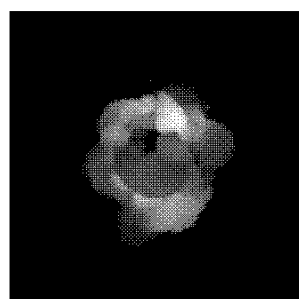
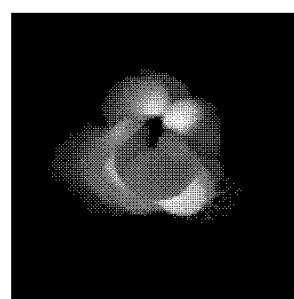

Figure 3. Surfaces with closed field lines show possible locations of prominences. At each of these points the effective gravity along the field line is zero and the point lies at a potential minima. moving from top left to bottom right, polar configurations considered are: nothing at the pole (a), global dipole (b), concentric rings (c), bipole at the pole (d). Each polar cap added has field strengths of $1kG$ used



(a)



(b)

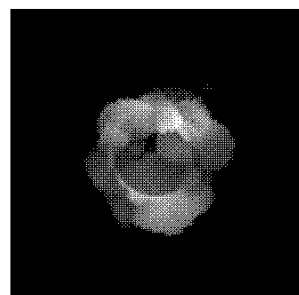

(c)

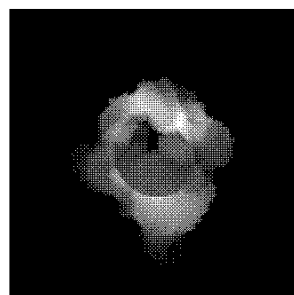

(d)

Figure 4. X-ray images of the stellar corona for each model. Same layout as previous figures. The X-ray emissions are all calculated for a coronal temperature $T=10^7$ K.

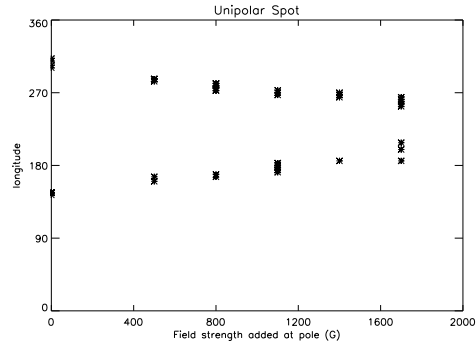

(a)

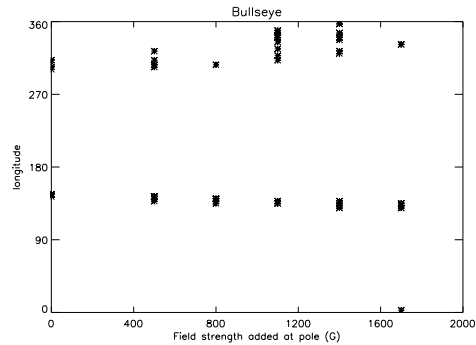

(b)

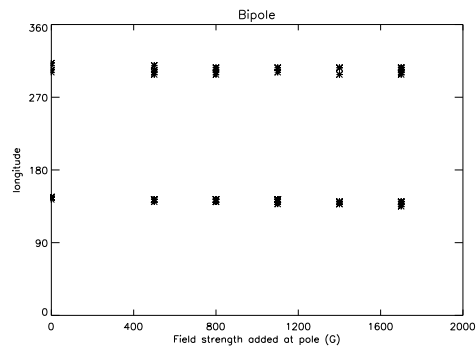

(c)

Figure 5. The graphs above shows the longitude for stable points where possible prominences may form and would pass in front of the star so they may be detected. The results here are fairly conclusive showing that all three models have roughly two regions of longitude where prominences could be detected.

used a code originally developed by van Ballegoijen et al. (1998).

4 CALCULATING THE POSITION OF PROMINENCES

The numerical method for determining the locations of stable potential minima along field lines is discussed in detail by Pointer et al. (2002) and will only be given a brief review here. For a possible prominence formation site to exist the

component of effective gravity along the magnetic field must be zero, i.e. $\mathbf{B} \cdot \mathbf{g}_{eff} = 0$. For this position of equilibrium to be stable we also require it to be a potential minimum. Thus the equilibrium must satisfy the condition

$$(\mathbf{B} \cdot \nabla)(\mathbf{B} \cdot \mathbf{g}_{eff}) < 0. \quad (2)$$

Such stable points may be favoured positions for prominence formation as any gas condensing at this point would neither fall towards the surface nor be centrifugally expelled. The fact that prominences on AB Dor are observed around the co-rotation radius suggests that such minima in the

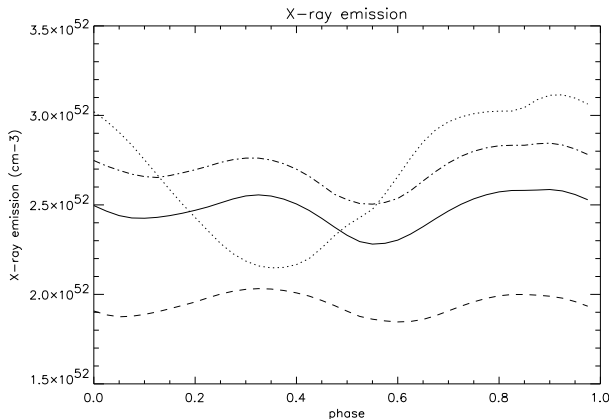

Figure 6. Graph showing the X-ray emission measure as it varies with phase for each model. All models here do not differ too much in magnitude and certainly the original data (solid line), concentric rings (dashed line) and Bipole (dash-dots) show a remarkably similar curve in emission over a whole cycle. This is also reflected in their rotational modulation which shows little variation between these three models and fits into the range of values predicted by observations of 5-13% (Kuerster et al. 1997). The Unipolar spot model (dotted line) shows a much higher rotational modulation of 31.52%.

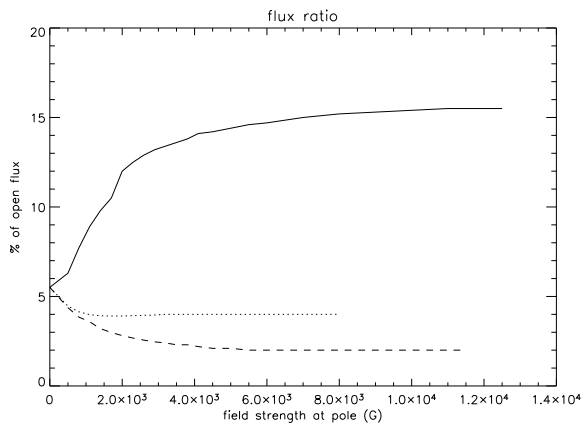

Figure 7. The graph shows the change in the amount of open magnetic flux as we increase the field strength at the poles of the various models. Any flux that reaches the source surface is considered open hence we calculate the amount of open flux as a ratio of total flux emerging at the stellar surface: $\sum_A |B_r(R_s, \theta, \phi)| / \sum_A |B_r(R_s, \theta, \phi)|$. The solid line shows the change for the unipolar spot model, the dotted line represents the concentric rings model and the dashed line the bipolar model. Again the similarities between the concentric rings and bipole models is easily seen, both slowly decreasing in open flux as we increase the strength of the polar field. The unipolar spot model on the other hand shows a reasonable growth in open flux with increasing field strength at the poles. It should be noted that although we have shown the flux ratios for magnetic fields up to 12kG these fields are much too strong to be considered non-decayable and are only shown to display the saturation each of the models has on the open flux.

gravitational-centrifugal potential do have a role to play in determining where prominences form. The existence of such stable points does not however guarantee prominence formation. In fact, at distances as far out as the co-rotation radius, the curvature of the field lines would need to be much smaller in order to overcome the centrifugal acceleration acting on a prominence. Prominences are observed as transient H_α absorption features and so can only be seen when they occult the stellar disk. We therefore select out of all possible stable points those that transit in front of the disk. Hence due to the stellar inclination any points that will transit the disk must satisfy the condition

$$R \cos(\theta + 60) < 1 \quad (3)$$

where R is the radial height of the stable point and θ is the latitude. If a star has a purely dipolar field, all such stable

points would lie in the equatorial plane and so would be unobservable (Jardine et al. 2001). We anticipate with our unipolar spot model that as the field strength in the polar cap is increased, the polar field will eventually dominate over the low-latitude field and the global topology will resemble that of a dipole. In this case no stable points in the corona would be observable. For each of our polar field models, we have therefore investigated the number of stable points that could be observed. Fig.5 shows the longitudes of these stable points.

5 X-RAY EMISSION

The X-ray emission was determined from the closed field regions. First of all the pressure structure of the corona was

calculated assuming it to be isothermal and in hydrostatic equilibrium. Thus the pressure at any point is

$$p = p_0 e^{\int g_s ds} \quad (4)$$

where $g_s = (\mathbf{g} \cdot \mathbf{B})/|\mathbf{B}|$ is the component of gravity along the field and

$$\mathbf{g}(r, \theta) = \left(-GM_*/r^2 + \omega^2 r \sin^2 \theta, \omega^2 r \sin \theta \cos \theta \right), \quad (5)$$

with ω the stellar rotation rate. The plasma pressure is scaled to the magnetic pressure at the loop footpoints i.e. $p \propto B_0^2$ where the constant of proportionality is chosen to match the observed emission measure. As we move out to larger heights from the star the gas pressure is greater than the magnetic pressure and thus forces field lines to open up. We have included this effect in our model by setting the plasma pressure to zero wherever it is greater than the magnetic pressure i.e. where $\beta > 1$. From the pressure, the corona's density could be calculated assuming it to be an ideal gas. Using a Monte Carlo radiative transfer code we can then determine the X-ray emission.

6 RESULTS

The magnetic fields added to the star are depicted in Fig.1 as is the original surface field map. All three additional fields have a strength of 1kG. This is a reasonable estimate for the field at the pole as it is strong enough to suppress convection yet not so strong as to be detectable in the star's Zeeman-Doppler images.

As can be seen in Fig.2, where we have shown only those field lines that are anchored at points within the polar region in question, the unipolar spot model has the greatest effect on the global field topology. Closed loops from the polar region are forced down to lower latitudes due to the presence of strong open field at the pole. This is unlike the other two models with the concentric rings and bipole, which show a strikingly similar appearance to the original data set of having large closed loops crossing directly over the pole. In these models there is almost no open field emerging from the polar region. The concentric rings and bipole models show greater consistency in the lack of rotational modulation of the flaring X-ray emission seen in BeppoSAX observation.

The difference in the topology of the field that is added at the pole can be seen in Fig (7) which shows the fraction of the surface flux that is open. In the case of a single unipolar spot added to the pole, this fraction increases as the strength of the polar field is increased, reaching a maximum value of 15%. This is less than the corresponding value of 44% for a dipolar field with the same source surface imposed (Jardine et al. 2002a) but still represents a significant factor. The open field regions extend down to a latitude of 75° with the result that much of the polar regions would be dark in X-rays. For the other two types of polar field, however, most of the polar field lines are closed (see Fig (2)) and so very few of them contribute to the flux of open field. In this case, the fraction of open field decreases as the polar field strength increases. This is due to the field at the pole being able to connect locally.

Positions of possible prominences are less affected by the addition of a polar field. Again the unipolar spot has the greatest effect forcing the stable points toward the equatorial

plane of the star (Fig.3). Many of these points which lie in or near the equatorial plane cannot be observed crossing the star along our line of sight. Observations of prominences are possible only if the prominences transit our line of sight to the star causing absorption dips in the $H\alpha$ profile. Strangely however the number of stable points for the dipole model is not that much less than any of the other models, although there does seem to be some convergence of longitudes as we increase the field strength at the pole for this model. The concentric rings and bipole models reproduce the same pattern of sites as the original image. In all three models we find that the stable points are grouped into two regions where arcades of predominantly east-west field span a range of longitudes. The imposition of the polar field disturbs the summits of these structures, pushing them toward longitude 220° in the unipolar case, and away from longitude 220° in the concentric case.

Clearly, none of these models can fully explain the number of prominences that are observed (up to six in the observable hemisphere at any one time). One possibility is that these stable points are not reliable indicators of prominence formation sites. Alternatively, as suggested by Schrijver & Title (2001) it could be that the prominences are formed in the sheared field produced when differential rotation stretches out the unipolar field of the dark polar cap to produce an azimuthal field. Such fields have been observed on AB Dor for some time (Donati & Collier Cameron 1997). Recently, Hussain et al. (2002) have fitted non-potential magnetic fields to the observed Stokes profiles. They have shown that the currents (which mark the regions where the field departs from its lowest-energy state) are confined to the high latitude regions at the edge of the dark polar cap. The positions of the stable points in these field extrapolations, however, were not significantly different from those determined for a potential field.

Pointer et al. (2002) performed a potential field extrapolation from a Zeeman-Doppler image of AB Dor with a dipolar field added into the map. They showed that differential rotation acting on such a field would produce a high latitude ring of azimuthal field similar to that observed (Donati & Collier Cameron 1997). It is possible that the field produced by the flux emergence model of Schrijver & Title (2001) would have a similar effect. Here the differential rotation between the concentric rings of opposite polarity would shear the field crossing this boundary producing an azimuthal field. A third possibility is that, as suggested by Hussain et al. (2002), the closed corona is in fact confined to within $1.6R_*$ and the prominences are confined in the very cusps of helmet streamers, much further out than the rest of the corona.

The other observable quantity is the X-ray emission. This was calculated for each model with polar fields of 1kG. Looking at the X-ray images of the stellar corona (Fig.4) for each model it is clear that the original image, the concentric rings and bipole models all show a strong similarity with a predominant X-ray emission from the polar region. The unipolar spot does show some emission from the polar region although not nearly as much structure as the other models. The average emission measure did not vary significantly between the models, ranging from $1.9 \times 10^{52} \text{cm}^{-3}$ for the concentric rings to $2.73 \times 10^{52} \text{cm}^{-3}$ for the bipole. The unipolar spot model has the highest emission measure with a value of

$3 \times 10^{52} \text{cm}^{-3}$ but it has such a large rotational modulation (31.5%) that its average emission lies at $2.61 \times 10^{52} \text{cm}^{-3}$. The other models all show a level of rotational modulation (9 to 11%) that fits the values predicted by observations of 5 to 13% (Kuerster et al. 1997). Something else worth noting here is that the models, excluding the unipolar spot, all showed very similar X-ray light curves. This again strongly suggests that the presence of a mixed-polarity field at the pole has little effect on the overall structure of the star.

7 CONCLUSIONS

Using Zeeman-Doppler images of the surface magnetic field of the young, rapidly rotating dwarf AB Dor, we have investigated the effect on the coronal field structure of the three most popular models for the polar fields of young stars. We find that the addition of a mixed-polarity region at the pole results in more small-scale local flux tubes at the pole, but has little effect on the large-scale field structure. Consequently, observations of the magnitude or rotational modulation of the X-ray emission are not sufficient to discriminate between these types of models. Observations of the “sling-shot prominences” trapped in the coronae of these stars do not provide an observational discriminant either. We have determined possible prominence-bearing structures by calculating the sites of stable mechanical equilibrium. All three models showed no more than 2 structures that can transit the stellar disc, but the observations show condensations at all longitudes. Due to the nature of alternating magnetic polarity at the surface of the star it is thought that a helmet streamer model could provide us with more regions of longitude for possible prominence formation sites where each prominence site would lie above and between these regions of opposite polarity (Linker et al. 2001).

The large-scale field structure is affected rather more by the addition of a unipolar region at the pole. This forces more of the polar field lines to be open (and hence dark in X-rays). This gives a larger rotational modulation as the closed-field regions that are bright in X-rays are now at lower latitudes and so are subject to rotational self-eclipse.

A polar spot extending down to latitude 75° gives a rotational modulation of 31.5%, greater than the observed value of 5-13% (Kuerster et al. 1997). It also forces up to 15% of the flux that emerges through the surface to be open, compared to only 5% when no field is added at the pole. This has potential implications for the angular momentum lost in the stellar wind, not only because it changes the amount of open flux, but also because it affects the distribution in latitudes. The addition of a polar spot introduces many more high-latitude open field lines. The winds from high latitude regions remove significantly less angular momentum from the star because of the reduced lever arm of the fieldlines. Schuessler & Solanki (1992) showed that this may explain the apparent slow-down of the angular momentum loss in young rapid rotators.

The change in the global field structure brought about by adding a polar spot may also be relevant to studies of disk-magnetosphere coupling in young stars. The addition of a polar spot means that the largest scale field lines (the ones that would intersect a disk) originate from the poles. In this case, any material accreting from a disk would reach

the stellar surface at the poles. In the absence of a polar spot (or in the case where the polar field was of mixed polarity) the accretion process would be more likely to be in the form of discrete accretion funnels, which would intersect the stellar surface in low-latitude ‘hot spots’.

While the nature of the polar field - whether single or mixed polarity - clearly makes a difference to the global field structure, the available observations of the X-ray emission measure and the prominence distribution are not sufficient to discriminate between types of polar field. We can however rule out the possibility of the unipolar spot model because the results show the modulation amplitude in the X-ray emission to be much too large. Only the degree of modulation of the X-ray emission can be used, but this requires long-term monitoring to eliminate the effects of short-term variability in flares. Phase-resolved observations of line shifts that indicate the presence of a stellar wind would perhaps be a good proof of the field structure, but it may be that it will only be with the advent of Zeeman-Doppler imaging in molecular lines that we will be able to determine the nature of the polar fields.

8 REFERENCES

REFERENCES

- Collier Cameron A., 1995, New limits on starspot lifetimes for AB Doradus, *mnras*, **275**, 534–544
- Collier Cameron A., Robinson R.D., 1989a, Fast H-alpha variations on a rapidly rotating cool main sequence star. I - Circumstellar clouds, *mnras*, **236**, 57–87
- , 1989b, Fast H-alpha variations on a rapidly rotating, cool main-sequence star. II - Cloud formation and ejection, *mnras*, **238**, 657–674
- Collier-Cameron A., Unruh Y.C., 1994, Doppler Images of Ab-Doradus in 1992JAN, *mnras*, **269**, 814–+
- Donati J.F., Collier Cameron A., 1997, Differential rotation and magnetic polarity patterns on AB Doradus, *mnras*, **291**, 1–19
- Güdel M., Audard M., Briggs K., Haberl F., Magee H., Maggio A., Mewe R., Pallavicini R., Pye J., 2001, The XMM-Newton view of stellar coronae: X-ray spectroscopy of the corona of μ ASTROBJ ζ AB Doradus/ μ ASTROBJ ζ , *aap*, **365**, L336–L343
- Granzer T., Schüssler M., Caligari P., Strassmeier K.G., 2000, Distribution of starspots on cool stars. II. Pre-main-sequence and ZAMS stars between $0.4M_\odot$ and $1.7M_\odot$, *aap*, **355**, 1087–1097
- Hussain G.A.J., van Ballegooijen A.A., Jardine M., Cameron A.C., 2002, The Coronal Topology of the Rapidly Rotating K0 Dwarf AB Doradus. I. Using Surface Magnetic Field Maps to Model the Structure of the Stellar Corona, *apj*, **575**, 1078–1086
- Jardine M., Collier Cameron A., Donati J.F., 2002a, The global magnetic topology of AB Doradus, *mnras*, **333**, 339–346
- Jardine M., Collier Cameron A., Donati J.F., Pointer G.R., 2001, Prominence support in potential field configurations around rotating stars, *mnras*, **324**, 201–205
- Jardine M., Wood K., Collier Cameron A., Donati J.F., Mackay D.H., 2002b, Inferring X-ray coronal structures from Zeeman-Doppler images, *mnras*, **336**, 1364–1370

- Kellett B.J., Bingham R., Cairns R.A., Tsikoudi V., 2002, Can late-type active stars be explained by a dipole magnetic trap?, *mnras*, **329**, 102–108
- Kuerster M., Schmitt J.H.M.M., Cutispoto G., Dennerl K., 1997, ROSAT and AB Doradus: the first five years., *aap*, **320**, 831–839
- Linker J.A., Lionello R., Mikić Z., Amari T., 2001, Magneto-hydrodynamic modeling of prominence formation within a helmet streamer, *jgr*, **106**, 25165–25176
- Maggio A., Pallavicini R., Reale F., Tagliaferri G., 2000, Twin X-ray flares and the active corona of AB Dor observed with BeppoSAX, *aap*, **356**, 627–642
- Pointer G.R., Jardine M., Collier Cameron A., Donati J.F., 2002, Modelling surface magnetic field evolution on AB Doradus due to diffusion and surface differential rotation, *mnras*, **330**, 160–166
- Schrijver C.J., Title A.M., 2001, On the Formation of Polar Spots in Sun-like Stars, *apj*, **551**, 1099–1106
- Schuessler M., Solanki S.K., 1992, Why rapid rotators have polar spots, *aap*, **264**, L13–L16
- Strassmeier K.G., Observational evidence for polar spots, in: IAU Symp. 176: Stellar Surface Structure, S. 289–+ (1996)
- Unruh Y.C., Collier Cameron A., Cutispoto G., 1995, The Evolution of Surface Structures on Ab-Doradus, *mnras*, **277**, 1145–+
- van Ballegooijen A.A., Cartledge N.P., Priest E.R., 1998, Magnetic Flux Transport and the Formation of Filament Channels on the Sun, *apj*, **501**, 866–+
- Vilhu O., Tsuru T., Collier Cameron A., Budding E., Banks T., Slee B., Ehrenfreund P., Foing B.H., 1993, Multifrequency observations of AB Doradus. X-ray flaring and rotational modulation of a young star, *aap*, **278**, 467–477