

XXX-XXXXX
YYY-YYYYYY
August 23, 2019

Archeops: CMB Anisotropies Measurement from Large to Small Angular Scale

ALEXANDRE AMBLARD, ON BEHALF OF THE ARCHEOPS COLLABORATION

*PCC, Collège de France
Paris, France*

Archeops, a balloon-borne experiment, will provide a measurement of CMB anisotropies from large to small angular scale thanks to its large sky coverage (30%), its high angular resolution (10 arcminutes), and its high signal-to-noise ratio due to high sensitivity 100 mK cooled bolometers. We will therefore be able to put strong constraints on the value of the cosmological parameters. Archeops flew already twice, once in Sicily for a technical flight in 1999, and once from Sweden for its first scientific flight in January 2001. I describe here Archeops' main characteristics, the preliminary results from the scientific flight, the expected precision of this flight for power spectrum measurements, and perspectives for the next flights this winter.

PRESENTED AT

COSMO-01
Rovaniemi, Finland,
August 29 – September 4, 2001

1 Introduction

The Cosmic Microwave Background (CMB) was discovered by Penzias and Wilson [1] in 1965, and interpreted by Dicke et al. [2]. This radiation comes from the first moments of our Universe, and was first predicted by Gamow, Alpher and Hermann [3] in 1948, in the context of the Big Bang theory. The Big Bang theory predicted that our Universe was in expansion, which was first observed by Hubble [4] in 1929, via the redshift of galaxies. As a consequence of the expansion, the Universe also cools down, meaning that at earlier times it was hotter. Going back in the past, our Universe was so hot that matter and photons were tightly coupled with each other. They formed a plasma in thermal equilibrium. As the Universe cooled down, the photon energy became too small to ionise the matter, below 0.1 eV (below 13.6 eV due to the high photon to electron ratio), the mean free path of the photons became larger than the horizon. The photons were free to cross the Universe towards our detectors. The blackbody distribution and spatial properties of these photons remain unchanged due to their negligible cross-section with matter, the blackbody temperature is just cooled to 2.7 K due to the Universe expansion. Through this radiation, we obtain a picture of our Universe 300 000 years after the Big Bang.

2 Motivations

After the extremely accurate CMB spectrum measurement by the COBE satellite in 1989, proving that the radiation was a perfect blackbody [6, 7], and the first detection of deviations [5] from the perfect homogeneity at the level of 10^{-5} K, most experiments have concentrated on improving the measurement of the anisotropies. In most theories and with consistent available data, the statistical distribution of the CMB anisotropies is Gaussian. The anisotropies are therefore represented by their spherical harmonic power spectrum (non-Gaussianity is nevertheless looked for). The most accurate results are from COBE on large angular scale (> 7 degrees) and on small angular scales (< 2 degrees) from Boomerang [8], Maxima [9], and DASI [10] (see Figure 1). The intermediate angular scales, between COBE and the other experiments, lack measurements, due to the small sky coverage of these experiments. The main Archeops goal is to link COBE and Boomerang-Maxima-DASI angular scales, with high-sensitivity detectors covering a large fraction of sky (30% of the sky). Archeops is also a testbed for Planck-HFI, using the same type of cryogenic system and detectors; and it measures dust and galactic sources in a polarized frequency band.

3 Instrument and Scan-strategy

A complete description of Archeops can be found in [11] or on <http://www.archeops.org>, but the main characteristics of Archeops are:

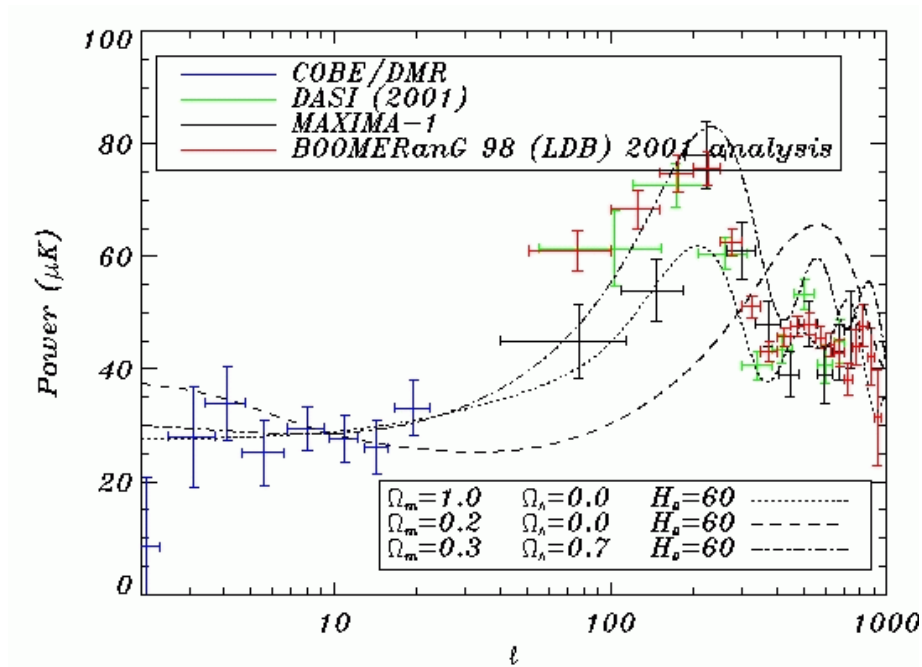

Figure 1: Most accurate available results, taken by the COBE satellite, and the experiments Boomerang, Maxima, DASI. We note the lack of measurements between COBE and other experiments. Archeops' main goal is to link these data sets with one single measurement. Three different inflationary models are also plotted, showing the influence of the cosmological parameters on the power spectrum.

- high angular resolution (10 arcminutes), due to a large primary mirror of 1.5 meters and to our horns, which guide the radiation to our bolometers;
- 30% sky coverage due to a scan-strategy consisting of making large circles on the sky. Associated with the first characteristic, this allows Archeops to measure the CMB power spectrum from angular scales of about 20 degrees ($l=30$) down to 10 arcminutes ($l=800$);
- bolometers cooled to 100 mK, by the same type of cryogenic system which will be used by Planck HFI, and does not rely on gravity;
- a frequency band, the 353 GHz band, polarized using OMT, is dedicated to the measurement of Galactic dust and point sources polarization.

The Archeops telescope is an off-axis gregorian telescope (see Figure 2), pointed at 41 degrees elevation, which defines the size of our circles on the sky at about 200 degrees. To make circle on the sky the gondola spins at constant elevation, and as the earth rotates, the center of the circle describes also a circle on the sky. This describes a typical ring or

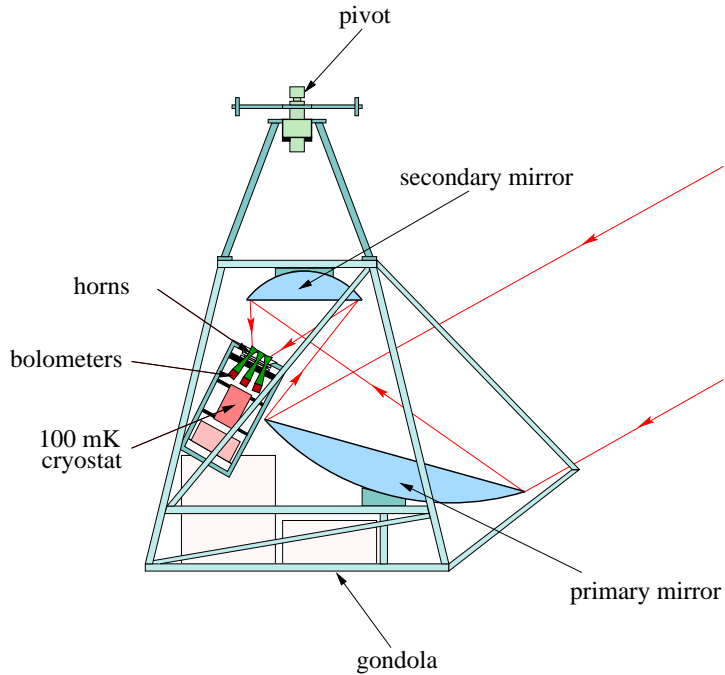

Figure 2: Schematic drawing of the gondola: the off-axis Gregorian telescope, the cryostat, and the bolometers with their feeding horns. The pivot on the top of the gondola spins the payload.

donut-like sky coverage (see Figure 3). For Archeops (41 degrees elevation and 68 degrees of latitude), the sky coverage is about 30% for a 24 hour flight.

After the secondary mirror, the radiation goes through a polypropylene membrane (see Figure 4), and enters the horns, which define the part of the sky seen by each bolometer; they play a crucial role for the angular resolution of the experiment.

The detectors are spiderweb bolometers (Figure 5), which have a small calorific capacity so a fast response time, and are less sensitive to cosmic ray hits. These bolometers are cooled to 100 mK by a ^3He - ^4He dilution, which is produced in capillary tubes placed around the focal plane (see Figure 5). The focal plane is filled with 22 bolometers, with the following frequency band distribution :

- 8 detectors at 143 GHz, where the CMB is the dominant emission at large galactic latitude;
- 6 detectors at 217 GHz, where the CMB is still dominant but dust contamination is larger;
- 6 detectors at 353 GHz, where the dust and atmospheric emission are dominant; these 6 channels are polarized using OMT : 3 pairs of 2 detectors share the same horn, the signal being separated into 2 orthogonal polarized components;

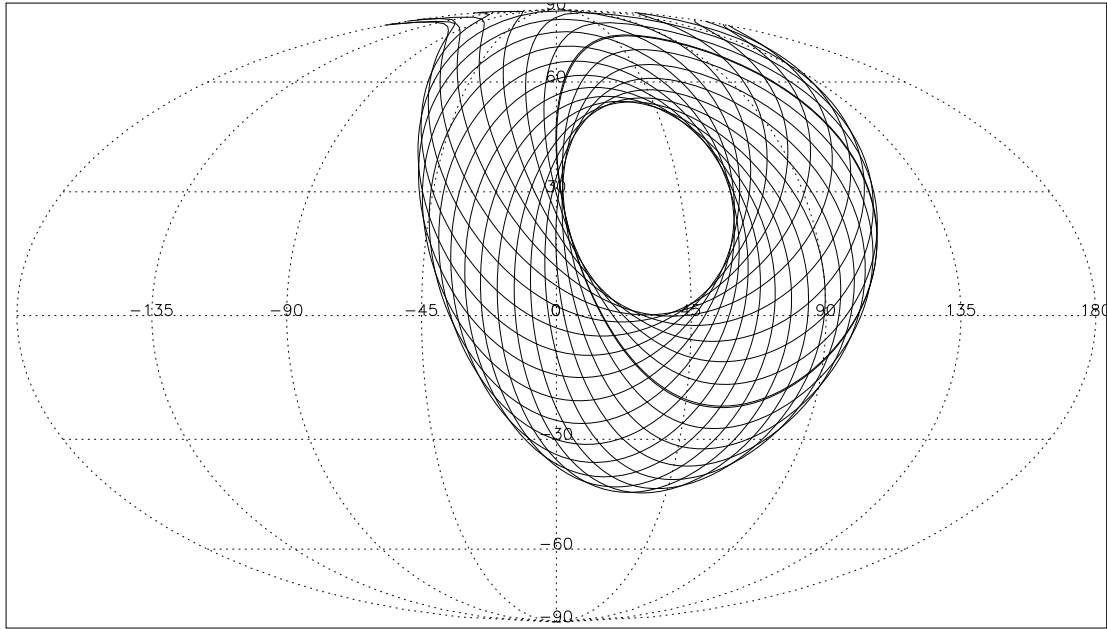

Figure 3: Typical Archeops sky coverage : each line represents a circle, the time separation between the circles is 1 hour.

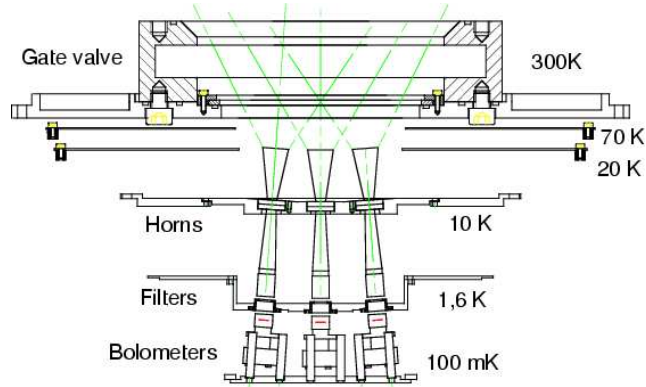

Figure 4: Optical path after the secondary mirror, from the membrane to the bolometers. The light passes through the horns and filters, to be received by the bolometers.

- 2 detectors at 545 GHz, where dust and atmospheric emission are dominant.

This frequency distribution is used to distinguish the different contributions of astrophysical origin or from parasitic signals, such as atmospheric emission; this is illustrated in Figure 6.

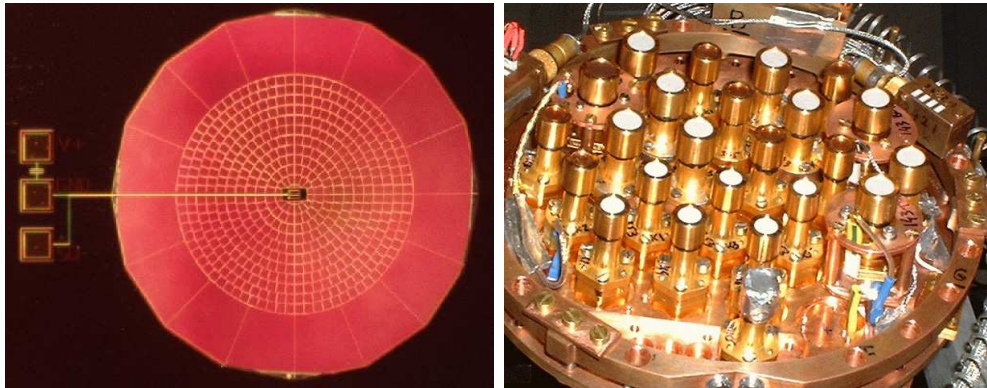

Figure 5: Spider web bolometer (left) with mesh size about 1 mm, the Archeops focal plane (right) filled with its 22 bolometers. This stage corresponds to the lower (100 mK) stage of Figure 4.

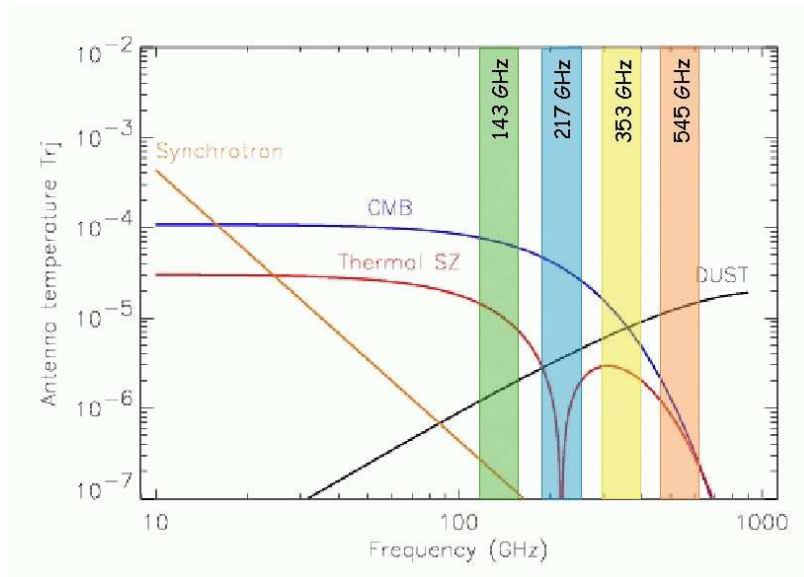

Figure 6: Frequency bands of Archeops, with the spectrum of different astrophysical processes, estimated around a galactic latitude of 70 degrees, and a galactic longitude of 340 degrees (adapted from [12]). The different bands allow us to separate different emission sources, as they have different spectral shape.

4 Flights

The Archeops experiment has already flown twice, once for a technical flight launched in Trapani (Sicily, Italy) crossing the mediterranean sea towards Spain in July 1999, producing 4 hours of night data, but with only 4 detectors. The second flight started

from Esrange, a SSC (Swedish Space Corporation) base, near Kiruna (Lapland in the north of Sweden). The gondola was launched by the CNES (Centre National d'Etudes Spatiales*) on January, 29th 2001 at 2pm (local time) and landed in Russia at Syktyvkar around midnight.

The flight was shortened due to strong stratospheric winds (about 400km/h), which pushed the gondola too rapidly towards the east. We however obtained 7.5 hours of scientific data (during night and at a float altitude of 31.5 km), covering 22.7% of the sky. The cryostat remained below 100 mK during the entire flight.

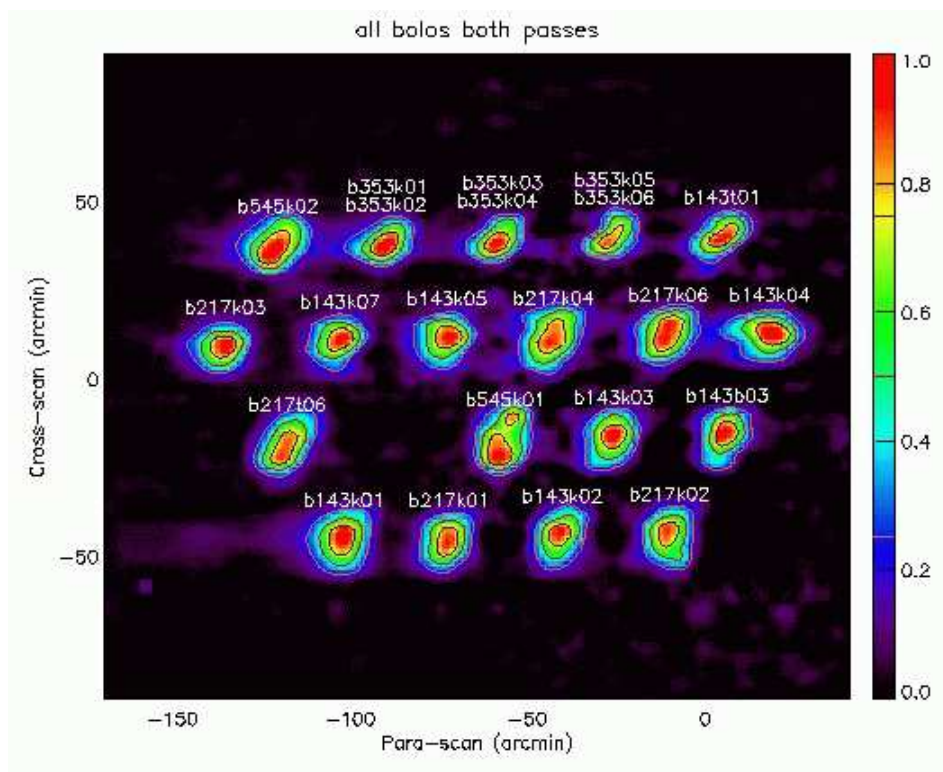

Figure 7: Archeops beams (angular sensitivity distribution), projected on the sky, obtained using Jupiter’s signal.

The average size of our optical beam is around 8 arcminutes, the average effective beam size is around 12 arcminutes because of the bolometers time response. Some beams are also a bit asymmetric, but this only impacts the very smallest angular scales, not attainable by Archeops for this flight (see Figure 8). The quality of the data was excellent, and will allow us to compute an accurate CMB anisotropies spectrum, especially on the low ℓ edge of the first acoustic peak.

*The French National Space Agency

5 Expected performance and future prospects

The data analysis is not yet finished, with various tests to check the power spectrum estimation still to be performed. Using the complete data processing pipeline and the known noise properties of our data, we have performed simulations for 10 detectors, based on the noise power spectrum (in the time domain) of our best channel. The power spectrum estimated from these simulations is shown in Figure 8. It is the average of power spectra given by each detector, weighted by their correlation matrices. In addition we performed an average over several simulations to check that the method was not biased.

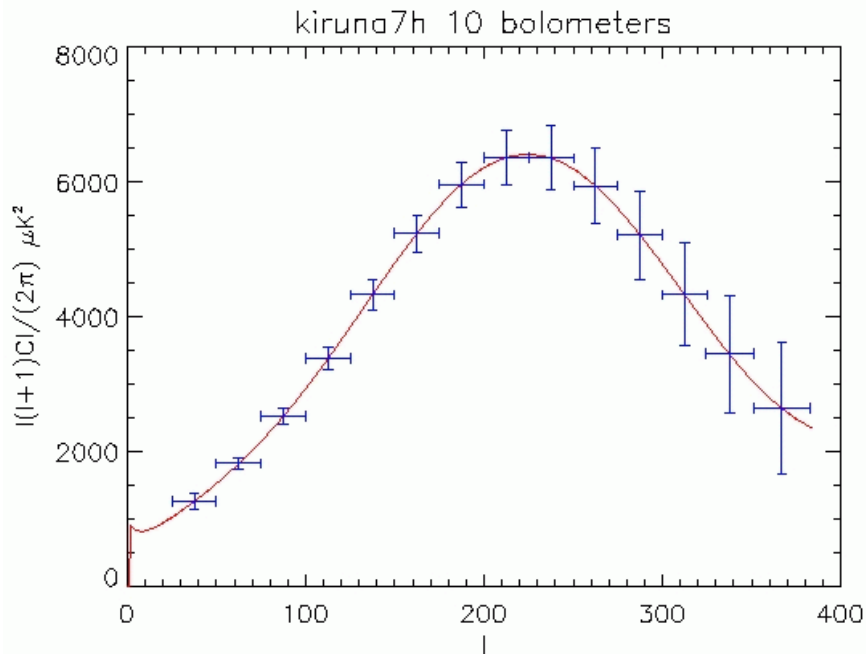

Figure 8: Power spectrum estimated from simulations, using 10 detectors with our best noise level, and averaging their power spectra using their correlation matrices. The estimation is centered on the input model as it is the average of one thousand realizations, showing that the method is unbiased. Error bars are very small at large angular scale before the first acoustic peak at $l=200$ due to our large sky coverage, but increase quite fast afterwards on small angular scale due to the short duration of our flight.

The error bars are very small (smaller than available measurement) on large angular scale, because of our large sky coverage, and then increase after the first acoustic peak because of the small signal-to-noise ratio due to the small integration time. This is the motivation for a longer duration flight of at least 24 hours, as the signal-to-noise ratio increases nearly quadratically after the first 10 hours (because the sky coverage does not increase further). Two flights are therefore scheduled for next Winter (December 2001 - January 2002), from

Esrange, with the same configuration. The expected performance for a 24 hour flight with 10 bolometers is shown in Figure 9.

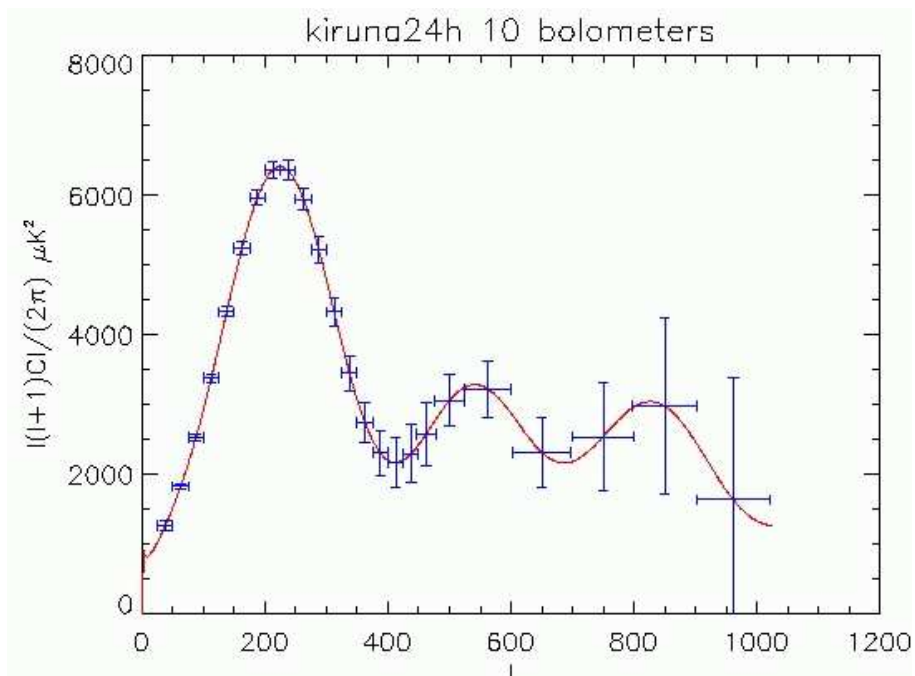

Figure 9: Power spectrum estimated from simulation : same method as for Figure 8, but for a 24 hours flight. The determination of the first peak is nearly perfect, and the measurement is good until the second peak.

The power spectrum estimated this way (Figure 9) is very accurate up to the end of the first peak and gives good constraints on the second one, allowing precise estimation of cosmological parameters.

6 Conclusions

Archeops is a balloon-borne experiment, designed to measure the CMB anisotropies from large (about 10 degrees) to small angular scales (about 10 arcminutes). Archeops is also a testbed for Planck HFI, and will provide useful information on galactic dust and point source polarisation. The balloon has already flown twice successfully: once during a test flight and another time for its first scientific flight from Kiruna. The first scientific flight yielded 7.5 hours of scientific data, with 14 detectors dedicated to CMB measurements. Results from this flight will come soon, and we showed that it will give good constraints on large angular scale, but less constraining on small angular scale due to the short duration of the flight. Archeops will fly again this Winter, in order to increase the accuracy on large scales and measure the small scales.

References

- [1] A. Penzias and R. Wilson *Astrophys. J. Lett.* **142** (1965) 419.
- [2] R. Dicke, J. Peebles, P. Roll and D. Wilkinson *Astrophys. J. Lett.* **142** (1965) 383.
- [3] R. Alpher and R. Herman *Nature* **162** (1948) 774; G. Gamow *Nature* **162** (1948) 680.
- [4] E.P. Hubble *Proc. N.A.S.***15** (1929) 168.
- [5] G. Smooth *et al.* *Astrophys. J. Lett.* **396** (1992) L1.
- [6] J. Mather *et al.* *Astrophys. J. Lett.* **420** (1994) 439.
- [7] D. Fixsen *et al.* *Astrophys. J. Lett.* **473** (1996) 576.
- [8] C.B. Netterfield *et al.* *astro-ph/0104460*.
- [9] S. Hanany *et al.* *Astrophys. J.* **545** (2000) L5.
- [10] N.W. Halverson *et al.* *astro-ph/0104489*.
- [11] A. Benoit *et al.* *astro-ph/0106152*, accepted in *AstroParticle Physics*.
- [12] J. Delabrouille, G. Patanchon, and E. Audit *astro-ph/0109187*, accepted in *MNRAS*.