

ANTI-VIETORIS–RIPS METRIC THICKENINGS AND BORSUK GRAPHS

HENRY ADAMS, ALEX ELCHESEN, SUCHARITA MALLICK, AND MICHAEL MOY

ABSTRACT. For X a metric space and $r \geq 0$, the *anti-Vietoris–Rips metric thickening* $\text{AVR}^m(X; r)$ is the space of all finitely supported probability measures on X whose support has spread at least r , equipped with an optimal transport topology. We study the anti-Vietoris–Rips metric thickenings of spheres. We have a homeomorphism $\text{AVR}^m(S^n; r) \cong S^n$ for $r > \pi$, a homotopy equivalence $\text{AVR}^m(S^n; r) \simeq \mathbb{R}\mathbb{P}^n$ for $\frac{2\pi}{3} < r \leq \pi$, and contractibility $\text{AVR}^m(S^n; r) \simeq *$ for $r = 0$. For an n -dimensional compact Riemannian manifold M , we show that the covering dimension of $\text{AVR}^m(M; r)$ is at most $(n + 1)p - 1$, where p is the packing number of M at scale r . Hence the k -dimensional Čech cohomology of $\text{AVR}^m(M; r)$ vanishes in all dimensions $k \geq (n + 1)p$. We prove more about the topology of $\text{AVR}^m(S^n; \frac{2\pi}{3})$, which has vanishing cohomology in dimensions $2n + 2$ and higher. We explore connections to chromatic numbers of Borsuk graphs, and in particular we prove that for $k > n$, no graph homomorphism $\text{Bor}(S^k; r) \rightarrow \text{Bor}(S^n; \alpha)$ exists when $\alpha > \frac{2\pi}{3}$.

CONTENTS

1. Introduction	1
2. Related work	3
3. Background and notation	6
4. Anti-VR complexes and metric thickenings	9
5. Anti-VR thickenings of spheres with large thresholds	11
6. The covering dimension of the anti-VR thickening of a compact manifold	16
7. Anti-VR thickenings of spheres at scale $r = \frac{2\pi}{3}$	19
8. The total anti-VR complex and thickening	22
9. Chromatic numbers of Borsuk graphs	24
10. Nonexistence of graph homomorphisms between Borsuk graphs	27
11. Conclusion and open questions	33
Acknowledgements	35
References	35
Appendix A. Proof of Lemma 3.1	38
Appendix B. Generalization of Lemma 4.5	39

1. INTRODUCTION

Given a metric space (X, d) and a scale parameter $r > 0$, the Vietoris–Rips simplicial complex $\text{VR}(X; r)$ has vertex set X , and as simplices all finite subsets of X of diameter at most r . In applied topology, Vietoris–Rips complexes have been used to find the “shape” of datasets using persistent

homology [30]. In these settings, the dataset is often thought of as a finite sample drawn from a manifold. Latschev’s result [64] supports the use of Vietoris–Rips complexes in this way. Indeed, Latschev proves that if a dataset X is Gromov–Hausdorff close to a manifold M , then $\text{VR}(X; r)$ recovers the homotopy type of M for scale parameters r that are sufficiently small compared to the curvature of the manifold and sufficiently large compared to the density of the sample.

If a dataset X is sampled from a manifold M , then as more and more points are drawn, the persistent homology of the dataset X converges to the persistent homology of the manifold M . But what is the persistent homology of a manifold? Hausmann’s result guarantees that at small scales, the Vietoris–Rips complex $\text{VR}(M; r)$ is homotopy equivalent to the manifold M . But, in persistent homology, the idea is to let the scale grow from small to large, instead of trying to guess which scales are sufficiently small. What is the persistent homology of manifolds at larger scales? The only known complete answer is when the manifold M is the circle S^1 , in which case $\text{VR}(S^1; r)$ obtains the homotopy types of the circle S^1 , the 3-sphere S^3 , the 5-sphere S^5 , the 7-sphere S^7 , \dots as the scale increases [2]. But, this remains a difficult problem for other manifolds, including Vietoris–Rips complexes of higher-dimensional spheres.

Vietoris–Rips *metric thickenings* (denoted as $\text{VR}^m(X; r)$) were introduced in [3] in order to advance our understanding of Vietoris–Rips complexes of manifolds. Indeed, the topology of Vietoris–Rips metric thickenings is often better behaved, in part because the inclusion $M \hookrightarrow \text{VR}^m(M; r)$ into the metric thickening is continuous, whereas the inclusion $M \hookrightarrow \text{VR}(M; r)$ into the simplicial complex is discontinuous for M a manifold of dimension at least one. The persistent homology of Vietoris–Rips metric thickenings agrees with the persistent homology of Vietoris–Rips complexes, so long as we ignore whether endpoints of intervals are open or closed [11, 52]. The paper [3] gives the first new homotopy type $S^n * \frac{\text{SO}(n+1)}{A_{n+2}}$ appearing for Vietoris–Rips metric thickenings of the n -sphere S^n for all n . The paper [73] provides the homotopy types of $\text{VR}^m(S^1; r)$ for all values of the scale parameter r , which are again $S^1, S^3, S^5, S^7, \dots$ as the scale parameter increases, now proven using more geometric and Morse-theoretic techniques; see also [10]. In a similar fashion, in this paper we will study the homotopy types of the *anti*-Vietoris–Rips thickenings on n -spheres.

What is the anti-Vietoris–Rips (or anti-VR) thickening of a metric space? If X is a metric space and $r \geq 0$ is a scale parameter, then the *anti-Vietoris–Rips metric thickening* $\text{AVR}^m(X; r)$ consists of all finitely-supported probability measures on X whose support has spread at least r . A subset $\sigma \subseteq X$ has *spread* at least r if $d(x, x') \geq r$ for all $x, x' \in \sigma$ with $x \neq x'$. If r is larger than the diameter of X , then $\text{AVR}^m(X; r)$ consists of all Dirac delta measures, and hence is isometric to X . However, as r decreases below the diameter of X , the homotopy type of $\text{AVR}^m(X; r)$ may change. We note that the r -packing number of X places an upper bound on the number of points that may be in the support of a probability measure in $\text{AVR}^m(X; r)$. Once r has decreased down to zero, then $\text{AVR}(X; 0)$ is the space of all finitely supported probability measures in X , which is contractible. See [45, 60, 61, 83] and Section 2 for information on the closely-related anti-Vietoris–Rips simplicial complexes.

We consider in particular the case of n -spheres. We equip the n -sphere S^n with the geodesic metric, so that S^n has diameter π (but all of our results have analogues if the sphere is instead equipped with the Euclidean metric). If $r > \pi$, then $\text{AVR}^m(S^n; r)$ is isometric to S^n . We prove in

Theorem 5.1 that if $\frac{2\pi}{3} < r \leq \pi$, then $\text{AVR}^m(S^n; r)$ is homotopy equivalent to \mathbb{RP}^n . In Theorem 6.1 we show that for an n -dimensional Riemannian manifold M , the covering dimension of $\text{AVR}^m(M; r)$ is at most $(n+1)p-1$, where the packing number $p = \text{pack}_M(r)$ is the largest number of points that can be placed in M so that any two points are at distance at least r apart. Thus $\text{AVR}^m(M; r)$ has no cohomology in dimensions $(n+1)p$ and higher. In Theorem 7.1, we also give initial information on the topology of $\text{AVR}^m(S^n; \frac{2\pi}{3})$, which has vanishing cohomology in dimensions $2n+2$ and higher. The homotopy types of $\text{AVR}^m(S^n; r)$ for $0 < r < \frac{2\pi}{3}$ remain mysterious.

We will also see that the homotopy types of anti-VR thickenings can be used as obstructions to the existence of certain graph homomorphisms between Borsuk graphs. Using the homotopy type of $\text{AVR}^m(S^n; r)$, we show in Theorem 10.3 that graph homomorphisms from a Borsuk graph on a higher-dimensional sphere to a Borsuk graph on lower dimensional sphere cannot exist unless the scale of the codomain is sufficiently relaxed. Indeed, for all $k > n$ and $r < \pi$, we show there is no graph homomorphism $f: \text{Bor}(S^k; r) \rightarrow \text{Bor}(S^n; \alpha)$ when $\alpha \geq \frac{2\pi}{3}$. This improves upon the result implied by what is known about the chromatic numbers of these graphs.

Our paper is organized as follows. We survey related work in Section 2, and cover background material in Section 3. In Section 4, we define anti-VR simplicial complexes and metric thickenings. In Section 5, we prove that the anti-VR thickening of the n -sphere S^n , for scales $\frac{2\pi}{3} < r \leq \pi$, is homotopy equivalent to the n -dimensional real projective space \mathbb{RP}^n . In Section 6 we bound the covering dimension of anti-VR thickenings of compact manifolds, and hence the highest dimension in which cohomology can appear for these spaces. In Section 7 we give some information about the topology of $\text{AVR}(S^n; r)$ at the first scale small enough so that the homotopy type is no longer \mathbb{RP}^n . In Section 8, we introduce total anti-VR complexes and thickenings. We describe a connection to chromatic numbers, especially of Borsuk graphs, in Section 9. Then, using the homotopy equivalences from Sections 5 and 8, we prove a no-graph-homomorphism result for Borsuk graphs in Section 10. We conclude with a list of open questions in Section 11.

2. RELATED WORK

We give a short survey of Vietoris–Rips complexes and metric thickenings, which are well-studied. After that, we move on to anti-Vietoris–Rips complexes. We end by surveying some papers that make use of anti-Vietoris–Rips perspectives, even if they may not be directly related.

Vietoris–Rips complexes and thickenings. Vietoris–Rips complexes are commonly used tools in applied topology for estimating the “shape” of data [30]. Given a metric space X and a scale $r \geq 0$, the Vietoris–Rips complex $\text{VR}(X; r)$ contains a simplex for each finite set of X of diameter at most r . They were introduced by Vietoris [91] in order to define a cohomology theory for metric spaces, and used by Rips in geometric group theory (for example, Rips proved that the Vietoris–Rips complex of a δ -hyperbolic group is contractible if the scale is chosen to be at least 4δ [54]).

Hausmann proves that for a closed Riemannian manifold M , when the scale r is sufficiently small compared to the injectivity radius of M , the Vietoris–Rips complex $\text{VR}(M; r)$ is homotopy equivalent to M [57]. Latschev further proves that if a space X is Gromov-Hausdorff close to M and the scale parameter r is in the right range, then $\text{VR}(X; r)$ recovers the homotopy type of M [64]. In

practice, to recover the homology groups of M , one looks at the persistent homology of $\text{VR}(X; r)$ as the scale r varies. The stability of persistent homology [34, 33] implies that if X is close to M in the Gromov–Hausdorff distance, then the persistent homology of $\text{VR}(X; -)$ is close to the persistent homology of $\text{VR}(M; -)$.

In order to use the persistent homology of $\text{VR}(X; -)$ to recover the homology of M , one typically uses the principle that features that persist for a long range of scales r detect the homology or the homotopy type of M [35]. By contrast, short-lived persistent homology features are indicative of local geometry. Indeed, [27] shows that the short-lived features or “noise” can be used to detect curvature of disks from which points have been sampled, and [82, 68, 4, 86, 87] consider definitions of fractal dimension using persistence homology. Both types of features, long- and short-lived, have found use in machine learning applications [26, 7, 20, 59, 76, 76, 12].

As mentioned in the introduction, Vietoris–Rips metric thickenings $\text{VR}^m(X; r)$ were introduced in [3] because they are often better behaved than Vietoris–Rips simplicial complexes (the inclusion $X \hookrightarrow \text{VR}^m(X; r)$ is continuous). Furthermore, the algebraic invariants of Vietoris–Rips metric thickenings have been closely related to those of Vietoris–Rips simplicial complexes; see [72, 11, 8, 51, 52]. In particular, for totally bounded metric spaces X , the persistent homology of Vietoris–Rips and Čech metric thickenings are stable under perturbations with respect to the Gromov–Hausdorff distance on the underlying metric space X . The paper [3] gives the first new homotopy type $S^n * \frac{\text{SO}(n+1)}{A_{n+2}}$ appearing for Vietoris–Rips metric thickenings of the n -sphere S^n for all n . The paper [73] provides the homotopy types of $\text{VR}^m(S^1; r)$ for all values of the scale parameter r , which are $S^1, S^3, S^5, S^7, \dots$ as the scale parameter increases.

Anti Vietoris–Rips complexes. The perspective taken with *anti*-Vietoris–Rips simplicial complexes $\text{AVR}(X; r)$ is instead to connect vertices in X when they are “far apart”. Indeed, the simplices in $\text{AVR}(X; r)$ are all finite subsets of X that have spread at least r , i.e. all finite $\{x_0, \dots, x_k\} \subseteq X$ with $d(x_i, x_j) \geq r$ for all $i \neq j$. Compared to Vietoris–Rips complexes, there are relatively fewer references on anti-Vietoris–Rips complexes. We survey the ones that we know about.

In [45], Engström proves two main results about anti-VR complexes. First, in [45, Proposition 4.2] Engström gives a recursive formula for the homotopy type of the anti-VR complex of any finite subset of the real line, in terms of wedge sums of suspensions of smaller anti-VR complexes. Second, in [45, Proposition 4.3] Engström proves that if $X \subseteq \mathbb{Z}^2$ has n vertices, then $\text{AVR}(X; r)$ is $\lfloor \frac{n-9}{6} \rfloor$ -connected for $1 < r < \sqrt{2}$.

Consider an unweighted graph G with the shortest path metric. The r -th graph power $G^{(r)}$ is a graph which has vertices $V(G)$ and two vertices are adjacent if the distance between them is at most r in the shortest path metric [45]. Note that $G^{(1)} = G$. Also, notice that the independence complex of the r -th graph power $I(G^{(r)})$ is the same as $\text{AVR}(G; r+1)$ (and so in particular, $I(G) = \text{AVR}(G; 2)$). For further references on independence complexes, see for example [21, 43, 44, 63], including filtered variants [1, 39].

In statistical physics, solutions to certain hard-particle models can be translated to the enumeration of independent sets of a certain square grid graph G . Looking at the hard-particle model at “activity -1 ” on these graphs is the same as the difference of the number of odd and even cardinality

independent sets. This is the same as computing the Euler characteristic of $\text{AVR}(G; 2)$; see [24] for further details.

We refer the reader to [60] for a video by Jefferson introducing anti-VR complexes; see also [61]. From a dataset (a finite sample of points from a circle, an ellipse, a square, etc.), Jefferson forms an anti-Vietoris–Rips complex. Then, the author computes the persistent homology of filtrations given by these anti-VR complexes as the scale is relaxed.

In his PhD thesis [83], Roehm studies anti-geometric persistence. He discusses dissimilarity matrices and computes barcodes from them, which he calls “anti-barcodes”. An example of a dissimilarity matrix would be any distance matrix — large entries correspond to dissimilar data points. But, in a dissimilarity matrix, you do not necessarily assume that the triangle inequality is satisfied. By contrast, in a *similarity* matrix, large entries correspond to similar data points (think highly correlated data points). For example, when measuring neuron firings, it might be most natural to first construct a notion of similarity which is the correlation between two firing patterns. Roehm makes the point well that when data is presented in the form of a similarity matrix, you might want to proceed directly and construct the anti-VR complex (which will connect similar data points first), instead of first transforming your similarity matrix into a dissimilarity matrix¹ and then computing a Vietoris–Rips complex. Roehm studies anti-Vietoris–Rips complexes of certain finite metric spaces, such as evenly spaced points on a line, evenly spaced points on a circle, or a finite subset of a sphere.

By contrast, we focus our attention on anti-Vietoris–Rips metric thickenings of *infinite* metric spaces, such as the entire n -sphere. Though Vietoris–Rips metric thickenings of infinite metric spaces (such as spheres) are closely related to Vietoris–Rips simplicial complexes of finite samples thereof, it is our impression that anti-Vietoris–Rips metric thickenings of infinite metric spaces are more related to *total* anti-Vietoris–Rips simplicial complexes of finite samples thereof; see Section 8.

We note that if X is an unbounded metric space, then $\text{AVR}(X; r)$ is contractible for any $r > 0$. Indeed, we show that $\pi_i(\text{AVR}(X; r))$ is trivial for all $i \geq 0$. By compactness, any map $f: S^i \rightarrow \text{AVR}(X; r)$ lands in a finite subcomplex with finite vertex set V . Since V is finite, there is some vertex $x \in X \setminus V$ at distance greater than r from each vertex of V . Therefore, the image of f lives in a cone on vertex x , and hence f is nullhomotopic. By Whitehead’s theorem, it follows that $\text{AVR}(X; r)$ is contractible. So, when studying anti-Vietoris–Rips complexes, it is most interesting to restrict attention to bounded metric spaces.

Chapter 5 of the fourth author’s PhD thesis [74] is a follow-up project based on this paper, even though it appeared earlier. In the case of S^1 , Moy proves that the homotopy types of $\text{AVR}^m(S^1; r)$ are $S^1, S^1, S^3, S^3, S^5, S^5, S^7, S^7, \dots$ as one decreases the scale parameter, until $\text{AVR}^m(S^1; r)$ is finally contractible when $r = 0$. Why is each odd-dimensional sphere listed twice? One has $\text{AVR}^m(S^1; r) \simeq S^1$ for $\frac{2\pi}{3} < r$, although for $\frac{2\pi}{3} < r' \leq \pi < r$ the inclusion $\text{AVR}^m(S^1; r) \hookrightarrow \text{AVR}^m(S^1; r')$ yields a degree two map $S^1 \rightarrow S^1$. This degree two map can be seen as the natural 2-fold covering map $S^1 \rightarrow \mathbb{RP}^1 = S^1$ (compare Theorem 5.1). More generally

¹There are several ways (such as $x \mapsto \frac{1}{x}$ or $x \mapsto e^{-x}$) but no canonical way to turn a similarity matrix into a dissimilarity matrix. Also, one can turn a dissimilarity matrix into a nearby metric space using multidimensional scaling (MDS) or related techniques; see [22, 36, 53, 5, 38].

for $k \geq 2$, $\text{AVR}^m(S^1; r) \simeq S^{2k-1}$ for $\frac{2\pi}{2k+1} < r \leq \frac{2\pi}{2k-1}$, and when $\frac{2\pi}{2k+1} < r' \leq \frac{2\pi}{2k} < r \leq \frac{2\pi}{2k-1}$, the inclusion $\text{AVR}^m(S^1; r) \hookrightarrow \text{AVR}^m(S^1; r')$ yields a degree two map $S^{2k-1} \rightarrow S^{2k-1}$.

Other related papers. In [84] Sankar uses a notion of discrete homotopy in order to study questions (and threshold parameters) related to the existence of graph homomorphisms. In one such example, the vertices of a discrete path lie in an n -sphere, and adjacent vertices on the path are required to be nearly antipodal, i.e. within an ε error bound of being antipodal. Note that each step in such a path moves along an edge of the anti-VR complex of the sphere at scale $\pi - \varepsilon$. For this reason, this discrete homotopy theory feels related to anti-VR type thickenings. See [81, 80, 28, 40, 16, 14, 15, 32] for other variants of discrete homotopy theories.

We ask if there is a relationship between anti-Vietoris–Rips complexes and configurations spaces of balls of positive radii; see for example [31, 18, 13]. Indeed, whenever the open balls $\{B(x_i; \frac{r}{2})\}_{i=0}^k$ are disjoint in a geodesic space X , then $\{x_0, \dots, x_k\}$ will be a simplex in the anti-Vietoris–Rips complex $\text{AVR}(X; r)$.

We also refer the reader to Barmak’s paper [17], especially Theorem 6.2 and Corollary 6.8 within. Theorem 6.2 gives the bound $\chi(G) \geq \text{Cat}(I(G)) + 1$. Here the *strong Lusternik–Schnirelmann category* $\text{Cat}(Y)$ of a space Y is one less than the minimum number of contractible subcomplexes which are needed to cover some CW complex homotopy equivalent to Y . It is known that $\text{Cat}(Y)$ is bounded from below by the cup-length of Y . Since the independence complex of a graph is the clique complex of the graph complement, the independence complex of the Borsuk graph is a Vietoris–Rips complex of a sphere. This provides additional motivation for understanding the homotopy types and Lusternik–Schnirelmann categories of Vietoris–Rips complexes of spheres. That said, Corollary 6.8 of [17] shows that the clique number $\omega(G)$ is bounded in-between ($\chi(G) \geq \omega(G) \geq \text{Cat}(I(G)) + 1$), meaning we do not expect this bound to be tight in many cases.

3. BACKGROUND AND NOTATION

In this section we define existing concepts and set notation for metric spaces, simplicial complexes, optimal transport, metric thickenings, and fiber bundles.

Let X and Y be topological spaces. A *map* $f: X \rightarrow Y$ is a continuous function. Also, let $I = [0, 1]$ be the unit interval.

Metric spaces and spread. Let X be a metric space with distance function $d: X \times X \rightarrow \mathbb{R}$. We let $B(x, r) = \{x' \in X \mid d(x, x') < r\}$ denote the ball of radius $r > 0$ centered at $x \in X$.

For $A \subseteq X$, we define the *diameter* of A to be $\text{diam}(A) := \sup\{d(x, x') \mid x, x' \in A\}$. The diameter is zero if A is a singleton.

Similarly, we define the *spread* of A to be

$$\text{spread}(A) := \inf\{d(x, x') \mid x \neq x', x, x' \in A\}.$$

In the case when A is a singleton set, we are taking the infimum of the empty set, and thus the spread of a singleton set is ∞ . In this paper, we will mostly be considering the spread of finite subsets.

A metric space (X, d) is said to be *totally bounded* if for every $\varepsilon > 0$, there exist a finite set of points $F = \{x_1, x_2, \dots, x_n\} \subseteq X$ such that $X \subseteq \bigcup_{i=1}^n B(x_i, \varepsilon)$. The inclusion $X \subseteq \bigcup_{i=1}^n B(x_i, \varepsilon)$ means that every point $x \in X$ is less than ε away from F , i.e., $\min_i d(x, x_i) < \varepsilon$. Such a set F is called an ε -*net* on X .

Simplicial complexes and Vietoris–Rips complexes. Let K be a simplicial complex on vertex set V . Even if V is infinite, we remind the reader that a simplex $\sigma \in K$ is required to be a finite subset of V . We identify abstract simplicial complexes with their geometric realizations.

Given a metric space (X, d) and $r > 0$, the Vietoris–Rips complex $\text{VR}(X; r)$ is the simplicial complex with vertex set X and with simplices all finite subsets of X of diameter at most r .

Optimal transport distances. We follow [92]. Let (X, d) be a metric space. A Borel measure μ is said to be a *Radon measure* if it is inner regular, i.e., $\mu(B) = \sup\{\mu(K) \mid K \text{ compact, } K \subseteq B\}$, and locally finite, i.e., for every $x \in X$ there exist a neighborhood U of x such that $\mu(U) < \infty$. Let $\mathcal{P}(X)$ be set of all probability Radon measures such that there exists some $y \in X$ with $\int_X d(x, y) d\mu < \infty$.

The Wasserstein or Kantorovich [90] metric is a metric defined on $\mathcal{P}(X)$. Given $\mu, \nu \in \mathcal{P}(X)$, let $\Pi(\mu, \nu) \subseteq \mathcal{P}(X \times X)$ be the set of all probability Radon measures π with marginals μ and ν , i.e., for any Borel set $E \subseteq X$ we have $\pi(E \times X) = \mu(E)$ and $\pi(X \times E) = \nu(E)$. We refer to $\pi \in \Pi(\mu, \nu)$ as a *transport plan* between μ and ν . To see that the set $\Pi(\mu, \nu)$ is non-empty, consider the product measure $\mu \times \nu \in \Pi(\mu, \nu)$. For $\mu, \nu \in \mathcal{P}(X)$, the 1-*Wasserstein* (or *optimal transport*) metric W_1 is defined as

$$W_1(\mu, \nu) := \inf_{\pi \in \Pi(\mu, \nu)} \int_{X \times X} d(x, y) d\pi.$$

Here, $\int_{X \times X} d(x, y) d\pi$ is the *cost* associated to the transport plan π , which we denote by $\text{cost}(\pi)$. The infimum in this definition is attained and the infimum gives the solution to the Monge–Kantorovich problem. The 1-Wasserstein distance is therefore the cost of an optimal transport plan.

In a sense, the optimal transport metric W_1 generalizes the metric d in X . For any $x \in X$, let δ_x be the Dirac delta measure supported on x , so $\delta_x \in \mathcal{P}(X)$. Then $x \mapsto \delta_x$ is an isometry, i.e., for any $x, y \in X$, $W_1(\delta_x, \delta_y) = d(x, y)$.

If π_1 and π_2 are two transport plans between μ and ν , then for any $0 \leq \lambda \leq 1$, so is $\lambda\pi_1 + (1-\lambda)\pi_2$. Also,

$$\text{cost}(\lambda\pi_1 + (1-\lambda)\pi_2) = \lambda\text{cost}(\pi_1) + (1-\lambda)\text{cost}(\pi_2).$$

We will find use for partial transport plans in Section 6, indeed to prove Theorem 6.1. A *partial transport plan* between $\mu, \nu \in \mathcal{P}(X)$ is a Radon measure σ such that for any Borel set $E \subseteq X$, we have $\sigma(E \times X) \leq \mu(E)$ and $\sigma(X \times E) \leq \nu(E)$. The *mass* of a partial transport plan σ is $\text{mass}(\sigma) = \int_{X \times X} d\sigma$. The mass is always less than or equal to one, and strict inequality is possible. If a partial transport plan has mass one, then it is a transport plan. The *cost* of the partial transport plan σ is $\int_{X \times X} d(x, y) d\sigma$. Though partial transport plans are relevant for the optimal partial transport problem (see [29, 48]), we will not consider that problem here. Instead, we use partial transport plans to bound the cost of (full) transport plans in spaces of bounded diameter, as per the following lemma.

Lemma 3.1. *Let (X, d) be a metric space with $\text{diam}(X) < \infty$, let $\mu, \nu \in \mathcal{P}(X)$, and let σ be a partial transport plan between μ and ν . Then σ can be extended to a (full) transport plan $\tilde{\sigma}$ between μ and ν with*

$$\text{cost}(\tilde{\sigma}) \leq \text{cost}(\sigma) + (1 - \text{mass}(\sigma)) \text{diam}(X).$$

See Appendix A for the proof.

Metric thickenings and Vietoris–Rips metric thickenings. Given a metric space (X, d) and $r \geq 0$, the *Vietoris–Rips metric thickening* $\text{VR}^m(X; r)$ is the space consisting of probability measures $\sum_{i=1}^k \lambda_i \delta_{x_i}$ with $\lambda_i > 0$, with $\sum_{i=1}^k \lambda_i = 1$, with $x_i \in X$ for all i , and with $\text{diam}\{x_1, \dots, x_k\} \leq r$ [3]. Here, δ_{x_i} is a Dirac delta measure at x_i and the set $\{x_1, \dots, x_k\}$ is said to be the *support* of $\sum_{i=1}^k \lambda_i \delta_{x_i}$. The space $\text{VR}^m(X; r)$ is equipped with the optimal transport topology. For convenience, we use the 1-Wasserstein distance W_1 , although this choice is not critical since the p -Wasserstein distance W_p induces the same topology for all $1 \leq p < \infty$ [23, 50].

The homotopy types of Vietoris–Rips simplicial complexes and Vietoris–Rips metric thickenings are tightly connected. If X is finite then $\text{VR}(X; r)$ and $\text{VR}^m(X; r)$ are homeomorphic ([3, Proposition 6.2]; see also [55, Equation 1.B(c)]). Adams, Moy, Mémoli, and Wang proved that for X totally bounded, the persistent homology modules of $\text{VR}(X; r)$ and $\text{VR}^m(X; r)$ are ε -interleaved for any $\varepsilon > 0$ [11, 72]. Next, Adams, Virk, and Frick proved that if X is totally bounded, then $\text{VR}(X; r)$ and $\text{VR}^m(X; r)$ (both with the $<$ convention) have isomorphic homotopy groups [8], but they do not show that they are weakly homotopy equivalent (they do not find a single map inducing these isomorphisms). Gillespie proved that they have isomorphic homology groups [51]. This sequence of results was notably strengthened in [52], when Gillespie proved that the natural continuous map $|\text{VR}(X; r)| \rightarrow \text{VR}^m(X; r)$ (both with the $<$ convention) defined by $\sum_i \lambda_i x_i \mapsto \sum_i \lambda_i \delta_{x_i}$ induces an isomorphism on all homotopy groups, and hence is a weak homotopy equivalence. This implies that the persistent homology modules of $\text{VR}(X; r)$ and $\text{VR}^m(X; r)$ are not only ε -interleaved for any $\varepsilon > 0$, but are furthermore isomorphic.

Fiber bundles and fibrations. A *fiber bundle* is a tuple (E, B, π, F) , where E , B , and F are topological spaces and $\pi: E \rightarrow B$ is a continuous map satisfying the following *local triviality condition*: for each $b \in B$, there exists a neighborhood U of b , and a homeomorphism $h: \pi^{-1}(U) \rightarrow U \times F$ such that the following diagram commutes, where p_1 is the projection to the first coordinate:

$$\begin{array}{ccc} \pi^{-1}(U) & \xrightarrow{h} & U \times F \\ \pi \downarrow & \swarrow p_1 & \\ U & & \end{array}$$

Here E , B , and F are called the *total space*, *base space*, and *fiber*, respectively.

A mapping $\pi: E \rightarrow B$ between topological spaces E and B satisfies the *homotopy lifting property* for a space X if, for every homotopy $H: X \times I \rightarrow B$ and for every lift \tilde{H}_0 of $H_0 := H|_{X \times 0}$ to E (i.e., $\pi \circ \tilde{H}_0 = H_0$), there exists a lift $\tilde{H}: X \times I \rightarrow E$ of H (i.e., $\pi \circ \tilde{H} = H$) which satisfies $\tilde{H}|_{X \times 0} = \tilde{H}_0$.

$$\begin{array}{ccc}
X \times \{0\} & \xrightarrow{\tilde{H}_0} & E \\
\downarrow & \nearrow \tilde{H} & \downarrow \pi \\
X \times I & \xrightarrow{H} & B
\end{array} \tag{1}$$

A mapping $\pi : E \rightarrow B$ is called a (*Hurewicz*) *fibration* if it satisfies the homotopy lifting property for every space X . It is called a *Serre fibration* if it satisfies the homotopy lifting property for all CW complexes.

4. ANTI-VR COMPLEXES AND METRIC THICKENINGS

The main goal of this section is to introduce anti-Vietoris–Rips metric thickenings. We first define anti-Vietoris–Rips simplicial complexes, then introduce anti-Vietoris–Rips metric thickenings, and then explain how anti-VR thickenings are related to more general metric thickenings.

4.1. Anti-VR complexes. We begin with the previously-introduced anti-Vietoris–Rips simplicial complexes.

Definition 4.1. Let (X, d) be a metric space and $r \geq 0$. The *anti-Vietoris-Rips (or anti-VR) complex* is the simplicial complex $\text{AVR}(X; r)$ with

- vertex set X
- simplices of the form $\{x_0, \dots, x_k\}$ such that $d(x_i, x_j) \geq r$ for all $0 \leq i, j \leq k$ with $i \neq j$.

Though other authors have used the $> r$ convention (see for example [45]), we use the $\geq r$ convention in this paper.

4.2. Anti-VR metric thickenings. We let $\text{AVR}^m(X; r)$ denote the associated *anti-VR metric thickening*:

Definition 4.2. Let (X, d) be a metric space and $r \geq 0$. The *anti-Vietoris–Rips (or anti-VR) metric thickening* $\text{AVR}^m(X; r)$ is the set of all finitely-supported probability measures on X whose support has spread at least r . That is,

$$\begin{aligned}
\text{AVR}^m(X; r) &= \left\{ \sum_{i=0}^k \lambda_i \delta_{x_i} \mid k \geq 0, \lambda_i > 0, \sum_i \lambda_i = 1, d(x_i, x_j) \geq r \ \forall i \neq j \right\} \\
&= \left\{ \sum_{i=0}^k \lambda_i \delta_{x_i} \mid k \geq 0, \lambda_i > 0, \sum_i \lambda_i = 1, \text{spread}(\{x_0, \dots, x_k\}) \geq r \right\},
\end{aligned}$$

equipped with the 1-Wasserstein distance.

When $r > \text{diam}(X)$, then the only measures whose support have spread at least r are the Dirac delta measures. Therefore, when $r > \text{diam}(X)$, the anti-VR metric thickening $\text{AVR}^m(X; r)$ is the set of all Dirac delta measures in X , and hence is isometric to X . When $r = 0$, the anti-VR metric thickening $\text{AVR}^m(X; r)$ is the space of all finitely supported measures in X , which is contractible (via a linear homotopy to any point in this space). But, for $0 < r < \text{diam}(X)$, the homotopy types of $\text{AVR}^m(X; r)$ are in general not well-understood.

Let (X, d) be a metric space. A subset $S \subseteq X$ is said to be an r -packing of X if $d(x, x') \geq r$ for all $x, x' \in S$ with $x \neq x'$. The *packing number*, $\text{pack}_X(r)$, is the largest cardinality of an r -packing S of X . The packing number $\text{pack}_X(r)$ of a metric space X determines the maximum number of points in the support of a measure in $\text{AVR}^m(X; r)$.

As explained in Section 3, the topology of Vietoris–Rips simplicial complexes and metric thickenings are closely related. In the case when the metric space X is finite, the anti-VR complex $\text{AVR}(X; r)$ and the anti-VR metric thickening $\text{AVR}^m(X; r)$ are still homeomorphic by [3, Proposition 6.2]. However, when X is infinite, we believe that the topologies of $\text{AVR}(X; r)$ and of $\text{AVR}^m(X; r)$ will often diverge considerably. Indeed, suppose that X is a Riemannian manifold with a finite packing number $p := \text{pack}_X(r)$. Then $\text{AVR}(X; r)$ will be a simplicial complex of dimension $p - 1$. It will typically be the case that $\text{AVR}(X; r)$ has uncountably many (maximal) $(p - 1)$ -dimensional simplices. In this setting, we expect the rank of the $(p - 1)$ -dimensional homology $H_{p-1}(\text{AVR}(X; r))$ of the anti-VR simplicial complex to be much larger than the more natural homology $H_{p-1}(\text{AVR}^m(X; r))$ of the anti-VR metric thickening. As an example, the simplicial complex $\text{AVR}(S^1; \frac{2\pi}{3})$ has an uncountable number of maximal 2-dimensional simplices. We expect that $H_2(\text{AVR}(S^1; \frac{2\pi}{3}))$ has uncountable rank (though this requires further exploration), even though we show in Theorem 5.1 that $\text{AVR}^m(S^1; \frac{2\pi}{3}) \simeq S^3$ and hence $H_2(\text{AVR}^m(S^1; \frac{2\pi}{3})) = 0$ is much smaller.

We next show, in Lemma 4.3, that the anti-VR metric thickening of a compact metric space is compact. This is in stark contrast to Vietoris–Rips metric thickenings, which need not preserve compactness (see [3, Remark 3.4 and Appendix D]).

Lemma 4.3. *Let $r > 0$. If (X, d) is a compact metric space, then $\text{AVR}^m(X; r)$ is compact.*

Proof. Since X is compact, $(\mathcal{P}(X), W_1)$ is also compact [93, Remark 6.19]. We will show that $\text{AVR}^m(X; r)$ is closed in $\mathcal{P}(X)$. Let (μ_n) be a sequence in $\text{AVR}^m(X; r)$ converging to some $\mu \in \mathcal{P}(X)$. We will show that $\mu \in \text{AVR}^m(X; r)$, i.e., that $\text{spread}(\text{supp}(\mu)) \geq r$. Suppose to the contrary that there exist distinct points $x, y \in \text{supp}(\mu)$ with $0 < d(x, y) < r$. For any $\varepsilon > 0$, there is an N such that $W_1(\mu, \mu_N) < \varepsilon \min\{\mu(B_\varepsilon(x)), \mu(B_\varepsilon(y))\}$, where the right side is necessarily positive because $x, y \in \text{supp}(\mu)$. Then μ_N must have a support point x_N within 2ε of x , since otherwise a transport plan between μ and μ_N would need to move mass $\mu(B_\varepsilon(x))$ at least distance ε , costing more than $W_1(\mu, \mu_N)$. Similarly, μ_N must have a support point y_N within 2ε of y . Therefore, $d(x, y) \geq d(x_N, y_N) - d(x, x_N) - d(y, y_N) \geq r - 4\varepsilon$, and since this holds for any $\varepsilon > 0$, we can conclude $d(x, y) \geq r$. \square

We will use Lemma 4.3 in Theorem 6.1 when we bound the covering dimension of anti-VR metric thickenings of compact manifolds.

4.3. Metric thickenings. More generally, we can define the metric thickening of any simplicial complex whose vertex set is a metric space [3].

Definition 4.4. Let X be a metric space and let K be a simplicial complex with vertex set X . The metric thickening K^m is the following subspace of $\mathcal{P}(X)$, equipped with the restriction of the

1-Wasserstein metric:

$$K^m = \left\{ \sum_{i=0}^k \lambda_i \delta_{x_i} \in \mathcal{P}(X) \mid k \geq 0, \lambda_i > 0, \sum_i \lambda_i = 1, \{x_0, \dots, x_k\} \in K \right\}.$$

In particular, $\text{AVR}^m(X; r) := (\text{AVR}(X; r))^m$.

Lemma 4.5. *Let X, Y be compact metric spaces, and let K, L be simplicial complexes with vertex sets $V(K) = X, V(L) = Y$. Let $f: X \rightarrow Y$ be a map of metric spaces such that the induced map $\tilde{f}: K^m \rightarrow L^m$ on metric thickenings exists. If f is continuous then \tilde{f} is continuous.*

Proof. Since every compact metric space is a Polish space and in a Polish space W_1 convergence is equivalent to weak convergence [93, Theorem 6.9]), we do the following. We need to show that $W_1(\tilde{f}(\mu_n), \tilde{f}(\mu)) \rightarrow 0$ whenever $W_1(\mu_n, \mu) \rightarrow 0$. For this, it suffices to show that $\int_Y g d\tilde{f}(\mu_n) \rightarrow \int_Y g d\tilde{f}(\mu)$ for every bounded continuous function $g: Y \rightarrow \mathbb{R}$. Now since $g \circ f: X \rightarrow \mathbb{R}$ is bounded,

$$\int_Y g d\tilde{f}(\mu_n) = \int_X g \circ f d\mu_n \rightarrow \int_X g \circ f d\mu = \int_Y g d\tilde{f}(\mu). \quad \square$$

The compactness assumption on X and Y can be relaxed. See Lemma B.1 in Appendix B for a more general result.

Corollary 4.6. *Let X and Y be two metric spaces with X finite. Let K and L be simplicial complexes with vertex sets $V(K) = X$ and $V(L) = Y$. If $f: X \rightarrow Y$ is a map such that the induced map $\tilde{f}: K^m \rightarrow L^m$ exists, then \tilde{f} is continuous.*

Proof. Since the finite space X is compact and a function from a finite metric space to another space is always continuous, $\text{im}(f)$ is also compact. Let $L' \subset L$ be the induced subcomplex with vertex set $\text{im}(f)$, meaning $L' = \{\sigma \subseteq \text{im}(f) \mid \sigma \in L\}$. By Lemma 4.5, $\tilde{f}: K^m \rightarrow (L')^m \hookrightarrow L^m$ is continuous. \square

We use Lemma 4.5 and Corollary 4.6 in the proof of Theorem 10.3.

The following lemma on continuity of homotopies will be used in the proofs of Lemma 5.3 and Proposition 8.3.

Lemma 4.7 (Lemma 3.9 of [3]). *Suppose K^m is a metric thickening and $f: K^m \rightarrow K^m$ is a continuous map such that $H: K^m \times [0, 1] \rightarrow K^m$ given by $H(\mu, t) = (1-t)\mu + tf(\mu)$ is well-defined. Then H is continuous.*

5. ANTI-VR THICKENINGS OF SPHERES WITH LARGE THRESHOLDS

We connect the anti-VR metric thickenings of spheres at large scales to projective spaces, first directly, and afterwards using fiber bundles.

5.1. Homotopy type of $\text{AVR}^m(S^n; r)$ for $\frac{2\pi}{3} < r$. Let S^n be the n -sphere with geodesic metric and with diameter π . Let real projective space $\mathbb{RP}^n = S^n/(x \sim -x)$ be the quotient space obtained by identifying antipodal points. For $x \in S^n$, we let $[x] \in \mathbb{RP}^n$ denote the corresponding equivalence class. The purpose of this subsection is to prove the following theorem.

Theorem 5.1. $\text{AVR}^m(S^n; r) \simeq \mathbb{RP}^n$ for all $\frac{2\pi}{3} < r \leq \pi$.

In the case $r = \pi$ and $n = 1$, the anti-VR metric thickening $\text{AVR}^m(S^1; \pi)$ is homeomorphic to the Möbius band (see Figure 1). The deformation retract we describe in our proof is the well-known deformation retract of the Möbius band to its central core, which in this setting is the circle $\{\frac{1}{2}\delta_x + \frac{1}{2}\delta_{-x} \mid x \in S^1\}$.

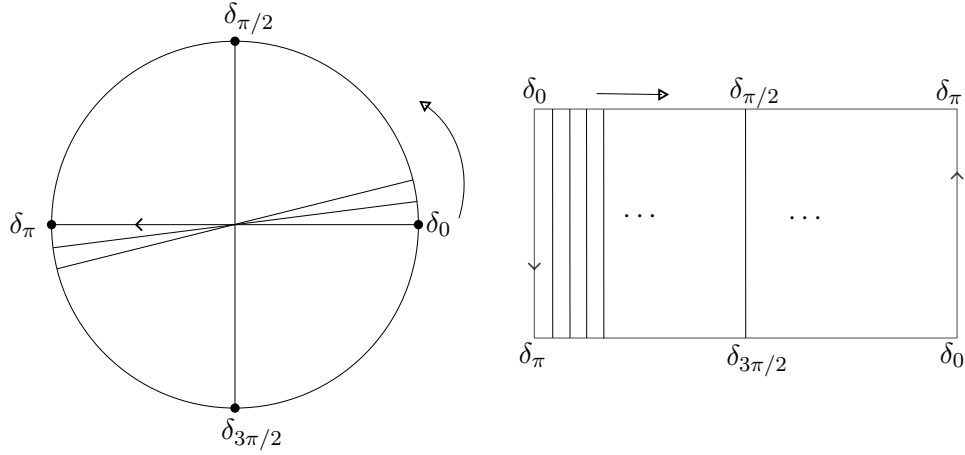

FIGURE 1. $\text{AVR}^m(S^1; \pi)$ (left) is homeomorphic to the Möbius band (right).

Similarly, $\text{AVR}^m(S^n; \pi)$ is homeomorphic to the “Möbius \mathbb{RP}^n ” (the total space of a nontrivial fiber bundle over \mathbb{RP}^n where each fiber is a unit interval), which deformation retracts to the projective space \mathbb{RP}^n .

Before proving Theorem 5.1, we will need the following results.

Proposition 5.2. *The map $\phi: \mathbb{RP}^n \rightarrow \text{AVR}^m(S^n; \pi)$ defined by $\phi([x]) = \frac{1}{2}\delta_x + \frac{1}{2}\delta_{-x}$ is an embedding of \mathbb{RP}^n into $\text{AVR}^m(S^n; \pi)$.*

Proof. To see that this is an embedding, consider the map $\phi' : S^n \rightarrow \text{AVR}^m(S^n; \pi)$ given by $\phi'(x) = \frac{1}{2}\delta_x + \frac{1}{2}\delta_{-x}$. This map satisfies $\phi'(x) = \phi'(-x)$ for all $x \in S^n$ and $\phi \circ p = \phi'$, where $p: S^n \rightarrow \mathbb{RP}^n$ is the quotient map. This shows that ϕ is continuous. Since ϕ is injective, since \mathbb{RP}^n is compact, and since $\text{AVR}^m(S^n; \pi)$ is Hausdorff, we conclude ϕ is a homeomorphism onto its image, [75, Theorem 26.6]. Thus, ϕ is an embedding. \square

For $0 < r < \pi$, there exists a natural inclusion $\text{AVR}^m(S^n; \pi) \hookrightarrow \text{AVR}^m(S^n; r)$. Thus for $0 < r \leq \pi$, there exists an embedded copy of \mathbb{RP}^n inside $\text{AVR}^m(S^n; r)$ given by the map $[x] \mapsto \frac{1}{2}\delta_x + \frac{1}{2}\delta_{-x}$. We are going to refer this copy of \mathbb{RP}^n inside of $\text{AVR}^m(S^n; r)$ as the *central core*.

Lemma 5.3. $\text{AVR}^m(S^n; \pi) \simeq \mathbb{RP}^n$ for all $n \geq 1$.

Proof. We will construct a deformation retraction of $\text{AVR}^m(S^n; \pi)$ onto the central core \mathbb{RP}^n . Define $H: \text{AVR}^m(S^n; \pi) \times I \rightarrow \text{AVR}^m(S^n; \pi)$ as follows. For $\mu = \lambda\delta_x + (1 - \lambda)\delta_{-x} \in \text{AVR}^m(S^n; \pi)$ with

$0 \leq \lambda \leq 1$, define

$$H(\mu, t) = (1-t)\mu + t(\frac{1}{2}\delta_x + \frac{1}{2}\delta_{-x}) = (\lambda(1-t) + \frac{t}{2})\delta_x + ((1-\lambda)(1-t) + \frac{t}{2})\delta_{-x}.$$

Note that for $\nu = \frac{1}{2}\delta_x + \frac{1}{2}\delta_{-x} \in \phi(\mathbb{R}\mathbb{P}^n)$, we have $H(\nu, t) = \nu$ for all $t \in I$. Moreover, for $\mu = \lambda\delta_x + (1-\lambda)\delta_{-x}$, we have $H(\mu, 0) = \mu$ and $H(\mu, 1) = \frac{1}{2}\delta_x + \frac{1}{2}\delta_{-x} \in \phi(\mathbb{R}\mathbb{P}^n)$. Since H is well-defined and since $\mu \mapsto \frac{1}{2}\delta_x + \frac{1}{2}\delta_{-x}$ is continuous, the map H is continuous by Lemma 4.7. Therefore, H is a deformation retraction of $\text{AVR}^m(S^n; \pi)$ onto $\phi(\mathbb{R}\mathbb{P}^n) \cong \mathbb{R}\mathbb{P}^n$, completing the proof. \square

Remark 5.4. We will refer to the map $H(\cdot, 1): \text{AVR}^m(S^n; \pi) \rightarrow \text{AVR}^m(S^n; \pi)$ given by $\lambda\delta_x + (1-\lambda)\delta_{-x} \mapsto \frac{1}{2}(\delta_x + \delta_{-x})$ as *projection to the central core*.

In Subsection 5.2, we describe a fiber bundle structure on $\text{AVR}^m(S^n; \pi)$. Using fibrations and Whitehead's theorem, we also give an alternate proof of Lemma 5.3.

We are now prepared to prove Theorem 5.1.

Proof of Theorem 5.1. We must show that $\text{AVR}^m(S^n; r) \simeq \mathbb{R}\mathbb{P}^n$ for all $\frac{2\pi}{3} < r \leq \pi$. We will accomplish this by showing that $\text{AVR}^m(S^n; r)$ is homotopy equivalent to $\text{AVR}^m(S^n; \pi)$, which is homotopy equivalent to $\mathbb{R}\mathbb{P}^n$ by Lemma 5.3.

We have the canonical inclusion $\iota: \text{AVR}^m(S^n; \pi) \hookrightarrow \text{AVR}^m(S^n; r)$. We define a homotopy inverse for ι , denoted $\rho: \text{AVR}^m(S^n; r) \rightarrow \text{AVR}^m(S^n; \pi)$, as follows. First, for measures supported on antipodal points, we define $\rho(\lambda_0\delta_{x_0} + (1-\lambda_0)\delta_{-x_0}) = \lambda_0\delta_{x_0} + (1-\lambda_0)\delta_{-x_0}$ for all $x_0 \in S^n$ and $0 \leq \lambda_0 \leq 1$. In general, let $\mu = \lambda_0\delta_{x_0} + (1-\lambda_0)\delta_{x'_0}$, where $x_0, x'_0 \in S^n$, and where $r \leq d(x_0, x'_0) \leq \pi$. Since S^n sits inside the (convex) Euclidean space \mathbb{R}^{n+1} , we can consider the associated point $\tilde{\mu} = \lambda_0x_0 + (1-\lambda_0)x'_0 \in \mathbb{R}^{n+1}$. Since $\frac{2\pi}{3} < r \leq d(x_0, x'_0) \leq \pi$, there is a unique² great circle in S^n passing through x_0 and x'_0 . Let N be the “north pole” point on that great circle, by which we mean that N is the point on the great circle such that $d(N, x_0) = d(N, x'_0) = \frac{d(x_0, x'_0)}{2}$. Also, let x_1 and $-x_1$ be the points on the great circle such that $d(N, x_1) = d(N, -x_1) = \frac{\pi}{2}$; note that the line in \mathbb{R}^{n+1} between x_0 and x'_0 is parallel to the line in \mathbb{R}^{n+1} between x_1 and $-x_1$. We join N with $\tilde{\mu}$ via a straight line in \mathbb{R}^{n+1} . If the line intersects a point on the diameter $\{tx_1 + (1-t)(-x_1) \in \mathbb{R}^{n+1} \mid 0 \leq t \leq 1\}$, then let the intersection point be $\lambda_1x_1 + (1-\lambda_1)(-x_1)$, and define $\rho(\mu) = \lambda_1\delta_{x_1} + (1-\lambda_1)\delta_{-x_1}$. Otherwise, let v be the unique point where this line intersects $S^n \setminus N$, and then define $\rho(\mu) = \delta_v$. Even though it is defined in piecewise manner, $\rho: \text{AVR}^m(S^n; r) \rightarrow \text{AVR}^m(S^n; \pi)$ is a continuous function. The map ρ is depicted in Figure 2 (left).

We claim the following:

- $\rho \circ \iota = id_{\text{AVR}^m(S^n; \pi)}$ (trivial from the definition)
- $\iota \circ \rho \simeq id_{\text{AVR}^m(S^n; r)}$.

To prove the second bullet point, consider the homotopy $H: \text{AVR}^m(S^n; r) \times I \rightarrow \text{AVR}^m(S^n; r)$, defined as follows. Let $\tilde{\rho}(\mu) \in \mathbb{R}^{n+1}$ be the point in Euclidean space corresponding to the measure $\rho(\mu) \in \text{AVR}^m(S^n; \pi)$, meaning either $\tilde{\rho}(\mu) = \lambda_1x_1 + (1-\lambda_1)(-x_1)$ or $\tilde{\rho}(\mu) = v$, according to the two

²When $x'_0 = -x_0$, meaning $d(x_0, x'_0) = \pi$, there is no *unique* great circle passing through x_0 and x'_0 , in fact, there are infinitely many. But the image $\rho(\mu)$ is not dependent on which great circle is chosen.

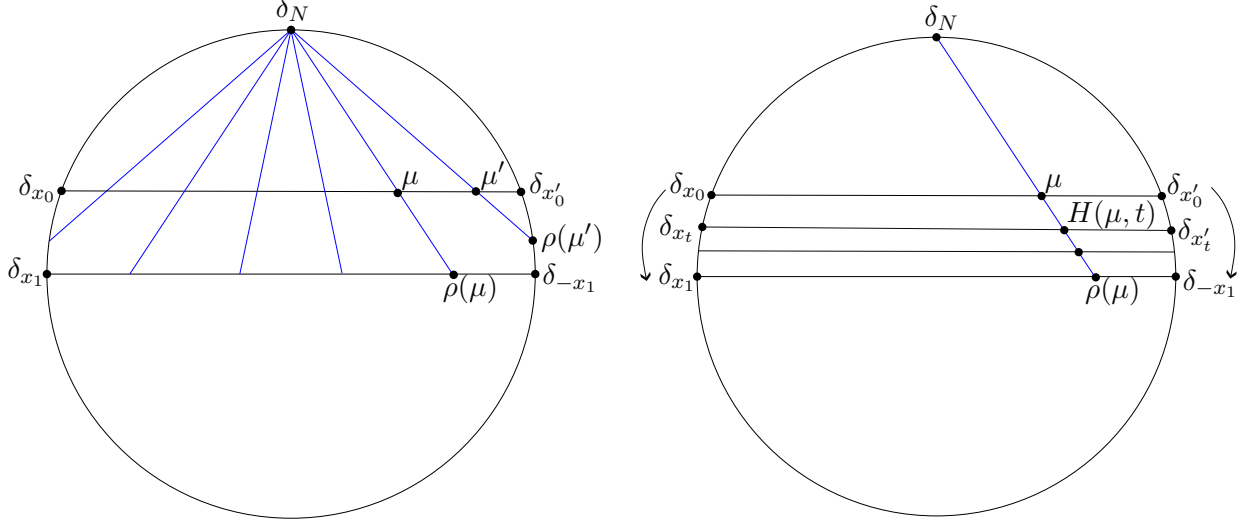

FIGURE 2. (Left) The map $\rho: \text{AVR}^m(S^n; r) \rightarrow \text{AVR}^m(S^n; \pi)$ in the proof of Theorem 5.1, with $n = 1$. There are the two cases for how ρ is defined. In one case, $\mu = \lambda_0\delta_{x_0} + (1 - \lambda_0)\delta_{x'_0}$ and $\rho(\mu) = \lambda_1\delta_{x_1} + (1 - \lambda_1)\delta_{-x_1}$. In the other case, $\rho(\mu') = \delta_v$. (Right) A depiction of the flashlight homotopy H between $\text{id}_{\text{AVR}^m(S^n; r)}$ and ρ . Here $H(\mu, t) = \lambda_t\delta_{x_t} + (1 - \lambda_t)\delta_{x'_t}$.

cases in the definition of ρ . For $t \in I$, let $\tilde{H}(\mu, t) \in \mathbb{R}^{n+1}$ be defined by $\tilde{H}(\mu, t) = t\tilde{\mu} + (1 - t)\tilde{\rho}(\mu)$. Note that $\tilde{H}(\mu, t)$ can be uniquely expressed as a convex combination $\tilde{H}(\mu, t) = \lambda_t x_{t,\mu} + (1 - \lambda_t)x'_{t,\mu}$ where $x_{t,\mu} \in S^n$ is a point on the geodesic arc from x_0 to x_1 , where $x'_{t,\mu}$ is a point on the geodesic arc from x'_0 to $-x_1$, and where the line segment from $x_{t,\mu}$ to $x'_{t,\mu}$ is parallel to the line segment from x_0 to x'_0 . We emphasize that $x_{t,\mu}$ and $x'_{t,\mu}$ are dependent on both t and μ , which justifies the subscripts. We note $x_0 = x_{0,\mu}$, $x'_0 = x'_{0,\mu}$, $x_1 = x_{1,\mu}$, and $-x_1 = x'_{1,\mu}$. And, when it is clear from context, we may write $x_{t,\mu}$ simply as x_t , and $x'_{t,\mu}$ as x'_t , as we do for example in Figure 2. We define $H(\mu, t) = \lambda_t\delta_{x_t} + (1 - \lambda_t)\delta_{x'_t}$. We refer to this as the *flashlight homotopy*; see Figure 2 (right). We note that the homotopy H satisfies $H(\cdot, 0) = \text{id}_{\text{AVR}^m(S^n; r)}$ and $H(\cdot, 1) = \iota \circ \rho$, as desired.

We are going to show that H is a continuous function. Since $\text{AVR}^m(S^n; r) \times I$ is a metric space it suffices to show that for every convergent sequence $(\mu_n, t_n) \rightarrow (\mu, t)$, we have a convergent sequence $H(\mu_n, t_n) \rightarrow H(\mu, t)$. We can use the metric defined via $d((\mu_1, t_1), (\mu_2, t_2)) = \max(W_1(\mu_1, \mu_2), |t_1 - t_2|)$. Also, we note that W_1 metrizes weak convergence [93, Theorem 6.9]. This means that $\mu_n \xrightarrow{w} \mu$ (μ_n converges weakly to μ), i.e., $\int f d\mu_n \rightarrow \int f d\mu$ for all continuous functions $f: S^n \rightarrow \mathbb{R}$, if and only if $W_1(\mu_n, \mu) \rightarrow 0$.

Suppose $(\mu_n, t_n) \rightarrow (\mu, t)$. We want to show that $H(\mu_n, t_n) \rightarrow H(\mu, t)$. Since $(\mu_n, t_n) \rightarrow (\mu, t)$, we have $|t_n - t| \rightarrow 0$ and $W_1(\mu_n, \mu) \rightarrow 0$, and thus $\int f d\mu_n \rightarrow \int f d\mu$ for all continuous functions $f: S^n \rightarrow \mathbb{R}$. Now

$$W_1(H(\mu_n, t_n), H(\mu, t)) = W_1(\underbrace{\lambda_{t_n}\delta_{x_{t_n, \mu_n}} + (1 - \lambda_{t_n})\delta_{x'_{t_n, \mu_n}}}_{\nu_{t_n}}, \underbrace{\lambda_t\delta_{x_t, \mu} + (1 - \lambda_t)\delta_{x'_t, \mu}}_{\nu_t}).$$

Let $f: S^1 \rightarrow \mathbb{R}$ be a continuous function. Note

$$\begin{aligned} \int f d\nu_{t_n} &= \lambda_{t_n} f(x_{t_n, \mu_n}) + (1 - \lambda_{t_n}) f(x'_{t_n, \mu_n}) \\ &\rightarrow \lambda_t f(x_{t, \mu}) + (1 - \lambda_t) f(x'_{t, \mu}) = \int f d\nu \end{aligned}$$

since $\lambda_{t_n} \rightarrow \lambda_t$, since $x_{t_n, \mu_n} \rightarrow x_{t, \mu}$, and since f is continuous. Hence $H(\mu_n, t_n) \rightarrow H(\mu, t)$, and so H is continuous. \square

We can do even better. At scale $r = \frac{2\pi}{3}$, if we ignore all the measures that are supported on 3 points, the resulting space $\text{AVR}^m(S^n; \frac{2\pi}{3}) \setminus W$, where W is the set of all measures supported on 3 points, is homotopy equivalent to \mathbb{RP}^n . We will use the following lemma in Theorem 7.1.

Lemma 5.5. *Let $W = \{\lambda_1 \delta_{x_1} + \lambda_2 \delta_{x_2} + \lambda_3 \delta_{x_3} \in \text{AVR}^m(S^n; \frac{2\pi}{3}) \mid \lambda_i > 0 \forall i\}$. Then $\text{AVR}^m(S^n; \frac{2\pi}{3}) \setminus W \simeq \mathbb{RP}^n$.*

Note that $\text{AVR}^m(S^n; \frac{2\pi}{3})$ has measures supported on at most 3 points. If a measure in $\text{AVR}^m(S^n; \frac{2\pi}{3})$ is supported on 3 points, the support is the set of vertices of an equilateral triangle. The set of these measures is exactly the set W in Lemma 5.5.

Proof of Lemma 5.5. We have natural inclusion $\iota: \text{AVR}^m(S^n; \pi) \hookrightarrow \text{AVR}^m(S^n; \frac{2\pi}{3}) \setminus W$. Again, the homotopy inverse of ι is $\rho: \text{AVR}^m(S^n; \frac{2\pi}{3}) \setminus W \rightarrow \text{AVR}^m(S^n; \pi)$, as defined in the proof of Theorem 5.1. The map ρ can be defined the same way, since all measures in $\text{AVR}^m(S^n; \frac{2\pi}{3}) \setminus W$ have support on at most two points. \square

5.2. A fiber bundle perspective on anti-VR thickenings. In this subsection we give a fiber bundle structure of $\text{AVR}^m(S^n; \pi)$. Note that $\text{AVR}^m(S^n; \pi)$ is a fiber bundle over \mathbb{RP}^n with fibers homeomorphic to I . Define $p: \text{AVR}^m(S^n; \pi) \rightarrow \mathbb{RP}^n$ by $t\delta_x + (1-t)\delta_{-x} \mapsto [x]$. Note $p^{-1}([x]) = \{t\delta_x + (1-t)\delta_{-x} \mid t \in I\} \cong I$. To see that this is a fiber bundle, consider $[x] \in \mathbb{RP}^n$. Let $x \in S^n$, and let V be a neighborhood of x in S^n that does not contain any antipodal pair. Let U be the image of V under the antipodal identification. Then $p^{-1}(U)$ consists of all of the points $t\delta_x + (1-t)\delta_{-x}$ with $[x] \in U$. Define $h: p^{-1}(U) \rightarrow U \times I$ by $t\delta_x + (1-t)\delta_{-x} \mapsto ([x], t)$. Now h is a continuous map with continuous inverse $([x], t) \mapsto t\delta_x + (1-t)\delta_{-x}$.

We note a similarity with the tautological line bundle γ_n on projective space \mathbb{RP}^n . Recall that the total space of γ_n consists of the points $\{([x], tx) \in \mathbb{RP}^n \times \mathbb{R}^{n+1} \mid t \in \mathbb{R}\}$. That means the fibers are homeomorphic to \mathbb{R} , but in the case of $p: \text{AVR}^m(S^n; \pi) \rightarrow \mathbb{RP}^n$, the fibers are instead homeomorphic to the unit interval.

Also, if we compose the map $S^n \rightarrow \text{AVR}^m(S^n; \pi)$ defined by $x \mapsto \delta_x$ with the map $p: \text{AVR}^m(S^n; \pi) \rightarrow \mathbb{RP}^n$, then we obtain the 2-fold universal covering map $S^n \rightarrow \mathbb{RP}^n$ defined via $x \mapsto [x]$.

Note the following facts:

- Every fiber bundle is Serre fibration.
- Let $p: E \rightarrow B$ be a (Hurewicz) fibration, with base space B path connected. If B and $F = p^{-1}(b)$ have the homotopy type of a CW complex for every $b \in B$, then E has the homotopy type of a CW complex [49, Theorem 5.4.2].

- For every Serre fibration $p: E \rightarrow B$, there exists a long exact sequence in homotopy groups. For $b \in B$, $x \in p^{-1}(b) = F$ we have

$$\dots \rightarrow \pi_n(F, x) \rightarrow \pi_n(E, x) \rightarrow \pi_n(B, b) \rightarrow \pi_{n-1}(F, x) \rightarrow \dots,$$

where $\pi_n(F, x) \rightarrow \pi_n(E, x)$ is induced by the inclusion map and $\pi_n(E, x) \rightarrow \pi_n(B, b)$ is induced by p .

In the case of $p: \text{AVR}^m(S^n; \pi) \rightarrow \mathbb{R}\mathbb{P}^n$, the fibers are contractible. Using the second fact, we conclude that $\text{AVR}^m(S^n; \pi)$ has the homotopy type of a CW complex. Using the first and third fact, we get that $\pi_n(\text{AVR}^m(S^n; \pi)) \cong \pi_n(\mathbb{R}\mathbb{P}^n)$ for all n . From Whitehead's theorem, we conclude that $\text{AVR}^m(S^n; \pi) \simeq \mathbb{R}\mathbb{P}^n$, giving another proof of Lemma 5.3.

See Section 10 for yet another proof of Lemma 5.3, using properties of mapping cylinders.

6. THE COVERING DIMENSION OF THE ANTI-VR THICKENING OF A COMPACT MANIFOLD

Let M be a compact n -dimensional Riemannian manifold. Recall the r -packing number $p := \text{pack}_M(r)$ is the maximal number of points that can be placed in M such that any two points are at distance at least r . So any probability measure in $\text{AVR}^m(M; r)$ has support of size at most p . Is there some sense in which $\text{AVR}^m(M; r)$ has dimension at most $(n+1)p - 1 = (p-1) + np$? This back-of-the-envelope guess at a numeric bound arises since a simplex on p points is $(p-1)$ -dimensional, and if the vertices of a simplex live in an n -dimensional manifold then each of the p vertices has n degrees of freedom; see Figure 3.

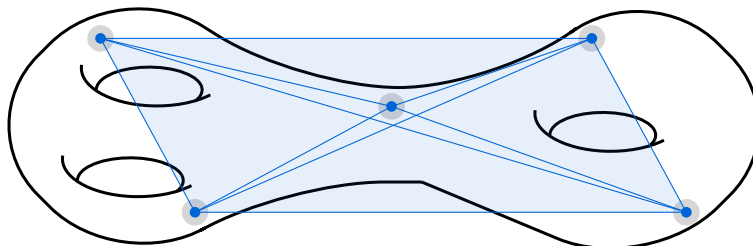

FIGURE 3. For M a compact n -dimensional manifold with $p = \text{pack}_M(r)$, the covering dimension of $\text{AVR}^m(M; r)$ is at most $(n+1)p - 1 = (p-1) + np$. Above is a manifold M of dimension $n = 2$ with $r > 0$ such that $p = \text{pack}_M(r) = 5$. In blue is a single $(p-1)$ -dimensional simplex in $\text{AVR}^m(M; r)$. The gray open neighborhoods show that each of the p vertices of this simplex have n degrees of freedom. Hence we expect $\text{AVR}^m(M; r)$ to have dimension $(p-1) + np = 4 + 2 \cdot 5 = 14$.

In Theorem 6.1 we show the answer is yes: the *covering dimension* of $\text{AVR}^m(M; r)$ is at most $(n+1)p - 1$. As a consequence, in Corollary 6.2 we conclude that the cohomology $H^k(\text{AVR}^m(M; r))$ vanishes for all $k > (n+1)p - 1$.

The *covering dimension* of a topological space X is at most m if for every open cover \mathcal{U} of X , there is an open refinement $\mathcal{U}' \subseteq \mathcal{U}$ of multiplicity at most $m + 1$; see [75, Section 50] and [89,

Page 152]. The refinement \mathcal{U}' is said to have multiplicity at most $m + 1$ if no point in X is contained in more than $m + 1$ sets in \mathcal{U}' .

We use an equivalent definition of the covering number for compact metric spaces. For X a compact metric space, the *covering dimension* of X is at most m if for any $\varepsilon > 0$, there is a cover of multiplicity at most $m + 1$ by open sets of diameter at most ε . Indeed, this follows from [42, Theorem 2.2(2)], which instead presents a cover of multiplicity at most $m + 1$ as an $(m + 1)$ -fold union $\mathcal{U}^0 \cup \dots \cup \mathcal{U}^m$ where each \mathcal{U}^i is a family of disjoint sets.

The following result is related to [47, (3.1)] and [19].

Theorem 6.1. *Let M be a compact Riemannian manifold of dimension n , with $p = \text{pack}_M(r)$. Then the covering dimension of $\text{AVR}^m(M; r)$ is at most $(n + 1)p - 1$.*

Proof. Let $\varepsilon > 0$. Since M is compact, by Lemma 4.3 we know that $\text{AVR}^m(M; r)$ is compact. Therefore, it suffices to show there exists a cover of $\text{AVR}^m(M; r)$ of multiplicity at most $(n + 1)p$ by open sets of diameter at most ε .

We know that the compact n -dimensional manifold M has covering dimension n [75, Corollary 50.7]. Therefore, there exists a cover \mathcal{U} of M of multiplicity at most $n + 1$ by open sets of diameter less than $\frac{\varepsilon}{2}$. Since M is compact, we can take this open cover \mathcal{U} to be finite.

It suffices to restrict attention to ε satisfying $0 < \varepsilon < r$, which we do. It therefore follows that given any $\mu \in \text{AVR}^m(M; r)$ and $U \in \mathcal{U}$, the intersection $\text{supp}(\mu) \cap U$ consists of at most one point.

Let K be the simplicial complex with vertex set \mathcal{U} whose simplices are the subsets $\{U_0, \dots, U_k\} \subseteq \mathcal{U}$ such that there is some $\mu \in \text{AVR}^m(M; r)$ with $\mu(U_i) > 0$ for all $0 \leq i \leq k$. Since each $\mu \in \text{AVR}^m(M; r)$ has support of size at most p , and since each point in M is contained in at most $n + 1$ sets in \mathcal{U} , each simplex in K has at most $(n + 1)p$ vertices. Hence the simplicial complex K is of dimension at most $(n + 1)p - 1$.

Any point $w \in |K|$ in the geometric realization of K is a collection of nonnegative weights $\{w_U\}_{U \in \mathcal{U}}$, at most $(n + 1)p$ of them positive, whose sum is 1. We might refer to $w \in |K|$ as a *weight sequence*. Equip the geometric realization $|K|$ with the metric of barycentric coordinates ([25, Section 7A.5] and [41]). In general, the metric of barycentric coordinates only preserves the weak homotopy type of a simplicial complex, but here it preserves the space up to homeomorphism since K is finite. Let $\varepsilon' > 0$. Since the geometric realization of a simplicial complex of dimension at most $(n + 1)p - 1$ has covering dimension at most $(n + 1)p - 1$ [89, Page 152], there exists an open cover \mathcal{W} of $|K|$ by sets of diameter at most ε' such that each point of $|K|$ belongs to at most $(n + 1)p$ sets in the cover. We choose $\varepsilon' < \frac{\varepsilon}{2 \text{diam}(M)}$, where $\text{diam}(M) < \infty$ since M is compact. Unravelling the definition of the metric of barycentric coordinates, this means that within each set $W \in \mathcal{W}$ in the cover, the sum of weight differences at all of the vertices $U \in \mathcal{U}$ is less than ε' . In symbols, for any $w, w' \in W \in \mathcal{W}$, we have $\sum_{U \in \mathcal{U}} |w_U - w'_U| < \varepsilon'$.

Let $\{\rho_U\}_{U \in \mathcal{U}}$ be a partition of unity subordinate to \mathcal{U} , which means that each $\rho_U: M \rightarrow \mathbb{R}_{\geq 0}$ satisfies $\text{supp}(\rho_U) \subseteq U$, and each $x \in M$ satisfies $\sum_{U \in \mathcal{U}} \rho_U(x) = 1$. For a measure $\mu \in \text{AVR}^m(M; r)$ we have that $U \cap \text{supp}(\mu)$ is either a single point or the emptyset, since $\varepsilon < r$. Therefore, any

measure $\mu \in \text{AVR}^m(M; r)$ can be written as

$$\mu = \sum_{\{U \in \mathcal{U}: \mu(U) > 0\}} \mu(U) \rho_U(x_U) \delta_{x_U} = \sum_{U \in \mathcal{U}} \mu(U) \rho_U(x_U) \delta_{x_U},$$

where x_U is the unique point in $U \cap \text{supp}(\mu)$ for all $U \in \mathcal{U}$ with $\mu(U) > 0$ (and where the location of x_U is irrelevant if $\mu(U) = 0$).

We define a continuous map $h: \text{AVR}^m(M; r) \rightarrow |K|$ using this partition of unity subordinate to the cover \mathcal{U} . Indeed, let $\mu = \sum_{U \in \mathcal{U}} \mu(U) \rho_U(x_U) \delta_{x_U} \in \text{AVR}^m(M; r)$ map to the weight sequence $\{h(\mu)_U\}_{U \in \mathcal{U}} \in |K|$ defined by $h(\mu)_U = \mu(U) \rho_U(x_U)$, where again the location of x_U is irrelevant if $\mu(U) = 0$. Note that $\{h(\mu)_U\}_{U \in \mathcal{U}}$ is a weight sequence since μ is a probability measure.

Now, define the open cover \mathcal{V} of $\text{AVR}^m(M; r)$ by $\mathcal{V} = \{h^{-1}(W)\}_{W \in \mathcal{W}}$. Since \mathcal{W} covers $|K|$, we have that \mathcal{V} covers $\text{AVR}^m(M; r)$. Since the sets $W \in \mathcal{W}$ are open in $|K|$ and since h is continuous, the sets $h^{-1}(W)$ are open in $\text{AVR}^m(M; r)$. So \mathcal{V} is an *open* cover of $\text{AVR}^m(M; r)$. We furthermore claim that the multiplicity of \mathcal{V} is at most the multiplicity of \mathcal{W} , which is at most $(n+1)p$. Indeed, note that if the sets $h^{-1}(W_1), \dots, h^{-1}(W_k) \in \mathcal{V}$ have nonempty intersection at a point $\mu \in \text{AVR}^m(M; r)$, then the sets W_1, \dots, W_k have nonempty intersection at the point $h(\mu) \in |K|$.

We now show how to bound the diameter of a set $V_W \in \mathcal{V}$. Let $\mu = \sum_{U \in \mathcal{U}} \mu(U) \rho_U(x_U) \delta_{x_U}$ be an arbitrary measure in $\text{AVR}^m(M; r)$, where x_U is the unique point in $U \cap \text{supp}(\mu)$ for all $U \in \mathcal{U}$ with $\mu(U) > 0$. Similarly, let $\mu' = \sum_{U \in \mathcal{U}} \mu'(U) \rho_U(x'_U) \delta_{x'_U} \in \text{AVR}^m(M; r)$, where $x'_U \in U$ is defined similarly. Suppose $\mu, \mu' \in V_W$ for some $V_W \in \mathcal{V}$. So $h(\mu), h(\mu') \in W$ for some $W \in \mathcal{W}$. Since W has diameter at most ε' , this means that

$$\varepsilon' > \sum_{U \in \mathcal{U}} |h(\mu)_U - h(\mu')_U| = \sum_{U \in \mathcal{U}} |\mu(U) \rho_U(x_U) - \mu'(U) \rho_U(x'_U)|.$$

We construct a transport plan in $\mathcal{P}(M \times M)$ with marginals μ and μ' as follows. First, we define a *partial transport plan* (which may have mass less than one) by $\sigma = \sum_{U \in \mathcal{U}} \sigma_U \delta_{(x_U, x'_U)}$, where for $U \in \mathcal{U}$ we set

$$\sigma_U = \min\{\mu(U) \rho_U(x_U), \mu'(U) \rho_U(x'_U)\}.$$

We note that the cost of the partial transport plan σ satisfies $\text{cost}(\sigma) \leq \frac{\varepsilon}{2}$, since σ only ever matches mass at points x_U and x'_U that lie in a common open set in \mathcal{U} , and each such set has diameter less than $\frac{\varepsilon}{2}$. The mass of the partial transport plan σ satisfies

$$\begin{aligned} \text{mass}(\sigma) &= \sum_{U \in \mathcal{U}} \sigma_U = \sum_{U \in \mathcal{U}} \min\{\mu(U) \rho_U(x_U), \mu'(U) \rho_U(x'_U)\} \\ &\geq \sum_{U \in \mathcal{U}} (\mu(U) \rho_U(x_U) - |\mu(U) \rho_U(x_U) - \mu'(U) \rho_U(x'_U)|) \\ &= \sum_{U \in \mathcal{U}} \mu(U) \rho_U(x_U) - \sum_{U \in \mathcal{U}} |\mu(U) \rho_U(x_U) - \mu'(U) \rho_U(x'_U)| \\ &> 1 - \varepsilon' \end{aligned}$$

Therefore by Lemma 3.1, σ can be completed to a (full) transport plan $\tilde{\sigma} \in \mathcal{P}(M \times M)$ with marginals μ and μ' whose cost is at most

$$\begin{aligned} \text{cost}(\tilde{\sigma}) &\leq \text{cost}(\sigma) + (1 - \text{mass}(\sigma))\text{diam}(M) \\ &\leq \frac{\varepsilon}{2} + \varepsilon' \text{diam}(M) \\ &\leq \frac{\varepsilon}{2} + \frac{\varepsilon}{2\text{diam}(M)} \text{diam}(M) = \varepsilon. \end{aligned}$$

Hence the diameter of a set $V_W \in \mathcal{V}$ is at most ε . We have shown the covering dimension of $\text{AVR}^m(M; r)$ is at most $(n+1)p - 1$. \square

Corollary 6.2. *Let M be a compact Riemannian manifold of dimension n , with $p = \text{pack}_M(r)$. Then the Čech cohomology $\check{H}^k(\text{AVR}^m(M; r))$ vanishes in all dimensions $k \geq (n+1)p$.*

Proof. It follows from the definition of Čech cohomology that if a topological space has covering dimension at most d , then that space has vanishing Čech cohomology in all dimensions $k > d$. \square

Example 6.3. By Theorem 6.1 the covering dimension of $\text{AVR}^m(S^n; r)$ is at most $(n+1)\text{pack}_{S^n}(r)$, and by Corollary 6.2 the cohomology of $\text{AVR}^m(S^n; r)$ vanishes in all dimensions $k \geq (n+1)\text{pack}_{S^n}(r)$.

Example 6.4. Let us apply Theorem 6.1 to $\text{AVR}^m(S^1; r)$ for $\frac{2\pi}{3} < r < \pi$. We have that S^1 is a compact Riemannian manifold of dimension $n = 1$, with $p = \text{pack}_{S^1}(r) = 2$ for r in this range. Therefore, Theorem 6.1 states that the covering dimension of $\text{AVR}^m(S^1; r)$ is at most $(n+1)p - 1 = 3$. We note this bound is tight, since $\text{AVR}^m(S^1; r)$ for $\frac{2\pi}{3} < r < \pi$ is a 3-dimensional space (which can be thought of as a 2-parameter family of edges) for r in this range.

Example 6.5. However, for $r = \pi$, Theorem 6.1 only implies that $\text{AVR}^m(S^1; \pi)$ has covering dimension at most 3, even though (as a Möbius band) it has covering dimension 2. This is because the points in S^1 which support edges in $\text{AVR}^m(S^1; \pi)$ are necessarily antipodal points, and hence can't be varied independently in small neighborhoods without decreasing the distance below π .

In the specific case of $\text{AVR}^m(S^n; \frac{2\pi}{3})$, from Theorem 6.1, we conclude that the covering dimension will be at most $(n+1) \cdot 3 - 1 = 3n + 2$. Thus cohomology will vanish in dimension $3n + 3$ and higher. In the following section, we strengthen these bounds, showing the (co)homology of $\text{AVR}^m(S^n; \frac{2\pi}{3})$ vanishes in dimensions $2n + 2$ and higher.

7. ANTI-VR THICKENINGS OF SPHERES AT SCALE $r = \frac{2\pi}{3}$

Recall that $\text{AVR}^m(S^n; r)$ is homeomorphic to S^n for all $r > \pi$. Also, from Theorem 5.1, we know that $\text{AVR}^m(S^n; r)$ is homotopy equivalent to $\mathbb{R}\mathbb{P}^n$ for all $\frac{2\pi}{3} < r \leq \pi$. In this section we give some initial information about the topology of $\text{AVR}(S^n; r)$ at the first scale, $r = \frac{2\pi}{3}$, when the homotopy type is no longer $\mathbb{R}\mathbb{P}^n$. Specifically, Theorem 7.1 shows that $\text{AVR}^m(S^n; \frac{2\pi}{3})$ has vanishing homology and cohomology in dimensions $2n + 2$ and higher.

Intuitively, this result is obtained by recognizing pieces of $\text{AVR}^m(S^n; \frac{2\pi}{3})$ of known dimensions as follows. Up to homotopy, we start with $\mathbb{R}\mathbb{P}^n$. To this space, we glue on a $(2n - 1)$ -parameter family of solid triangles (disks), which is $(2n + 1)$ -dimensional. The $2n - 1$ parameter family arises since the planes in \mathbb{R}^{n+1} are parametrized by $\text{Gr}(2, n+1)$, a manifold of dimension $2 \cdot (n+1 - 2) = 2n - 2$,

and within each plane we have a circle's worth of triangles, increasing the dimension by 1. We formalize this intuition in the remainder of this section.

Theorem 7.1. *We have vanishing cohomology $H^k(\text{AVR}^m(S^n; \frac{2\pi}{3})) \cong 0$ and vanishing homology $H_k(\text{AVR}^m(S^n; \frac{2\pi}{3})) \cong 0$ for all $n \geq 1$ and all $k \geq 2n + 2$.*

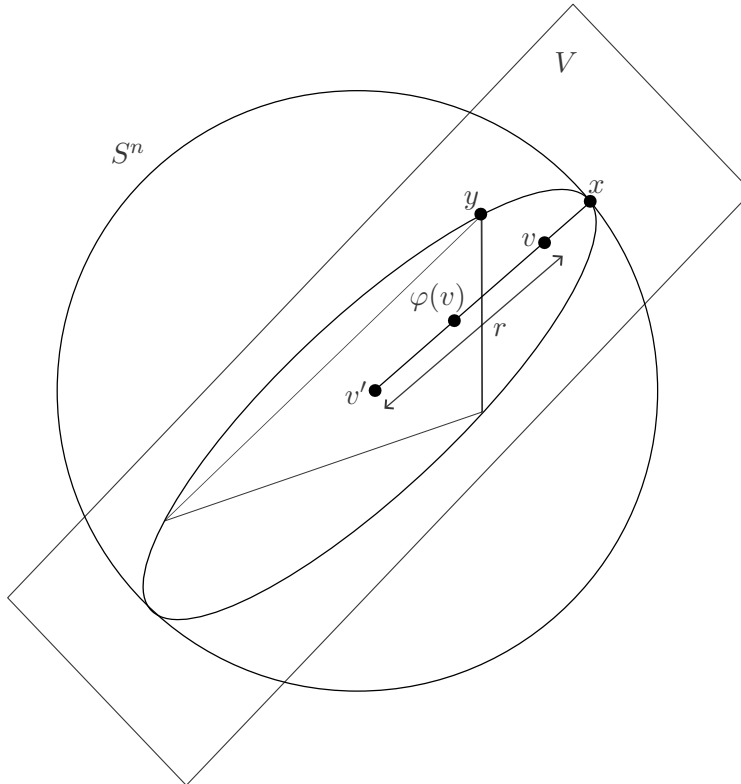

FIGURE 4. A *pictorial* representation of an element v of $Z \times I$ and its image under the map $\varphi: Z \times I \rightarrow \text{AVR}^m(S^n; \frac{2\pi}{3})$. Note that $v = (V, y, x, r)$ and $v' = (V, y, x, 0)$ live in the space $Z \times I$ and $\varphi(v)$ lives in a different space $\text{AVR}^m(S^n; \frac{2\pi}{3})$.

Proof. We begin by introducing spaces that will allow us to parameterize the families of triangles described above:

$$Z = \{(V, y, x) \in \text{Gr}(2, n+1) \times S^n \times S^n \mid y, x \in V\}$$

$$C = \{(V, y) \in \text{Gr}(2, n+1) \times S^n \mid y \in V\}.$$

Both are compact, as they are closed subsets of products of compact spaces (in fact, we will see below that both are closed manifolds). We define a map $\varphi: Z \times I \rightarrow \text{AVR}^m(S^n; \frac{2\pi}{3})$ as follows. For a given $(V, y, x, r) \in Z \times I$, there is a unique equilateral triangle centered at the origin that has y as a vertex and is contained in V ; let y' and y'' be its other vertices. Let z be the point on the boundary of this triangle that lies on the line passing through the origin and x . Then the point rz can be written uniquely as a convex combination $ay + a'y' + a''y''$ where $a, a', a'' \geq 0$ and

$a + a' + a'' = 1$; we define $\varphi(V, y, x, r) = a\delta_y + a'\delta_{y'} + a''\delta_{y''}$, see Figure 4. In effect, this treats x and r as polar coordinates within the triangle specified by V and y .

Since $Z \times I$ is compact and $\text{AVR}^m(S^n; \frac{2\pi}{3})$ is Hausdorff, φ is a closed map and thus a quotient map onto its image. The map φ identifies points $(V, y, x, 0)$ and $(V, y, x', 0)$ for all x and x' , and further identifies points (V, y, x, t) and (V, y', x, t) when the dot product is $\langle y, y' \rangle = -\frac{1}{2}$, i.e. when y and y' differ in angle by $\frac{2\pi}{3}$. Letting W be defined as in Lemma 5.5, the image of φ is the closure of W , and the points mapped by φ into the closed set $\text{AVR}^m(S^n; \frac{2\pi}{3}) \setminus W$ are exactly those of the form $(V, y, x, 1)$. Therefore, $\text{AVR}^m(S^n; \frac{2\pi}{3})$ is homeomorphic to the quotient

$$\left((Z \times I) \sqcup \text{AVR}^m(S^n; \frac{2\pi}{3}) \setminus W \right) / \sim,$$

where \sim is generated by $(V, y, x, t) \sim (V, y', x, t)$ if $\langle y, y' \rangle = -\frac{1}{2}$, $(V, y, x, 0) \sim (V, y, x', 0)$, and $(V, y, x, 1) \sim \varphi(V, y, x, 1)$. This is equivalently a double mapping cylinder of a pair of maps

$$\tilde{C} \xleftarrow{\psi} \tilde{Z} \xrightarrow{\varphi_1} \text{AVR}^m(S^n; \frac{2\pi}{3}) \setminus W.$$

Here \tilde{C} and \tilde{Z} are quotients of C and Z formed by respectively identifying (V, y) with (V, y') and (V, y, x) with (V, y', x) when $\langle y, y' \rangle = -\frac{1}{2}$, the map $\psi: \tilde{Z} \rightarrow \tilde{C}$ sends (V, y, x) to (V, y) , and we define $\varphi_1(V, y, x) = \varphi(V, y, x, 1)$.

We will check below that \tilde{C} and \tilde{Z} are closed, connected manifolds of dimensions $2n - 1$ and $2n$ respectively; assuming this for now, we can get partial information about the homology of $\text{AVR}^m(S^n; \frac{2\pi}{3})$. This double mapping cylinder above, homeomorphic to $\text{AVR}^m(S^n; \frac{2\pi}{3})$, can be written as the union of two mapping cylinders M_ψ and M_{φ_1} with intersection homeomorphic to $\tilde{Z} \times I$, and we thus get Meyer–Vietoris sequences on homology and cohomology. Since $\text{AVR}^m(S^n; \frac{2\pi}{3}) \setminus W \simeq \mathbb{R}\mathbb{P}^n$, we get the following long exact sequence on homology.

$$\dots \longrightarrow H_k(\tilde{C}) \oplus H_k(\mathbb{R}\mathbb{P}^n) \longrightarrow H_k(\text{AVR}^m(S^n; \frac{2\pi}{3})) \longrightarrow H_{k-1}(\tilde{Z}) \longrightarrow H_{k-1}(\tilde{C}) \oplus H_{k-1}(\mathbb{R}\mathbb{P}^n) \longrightarrow \dots$$

Since \tilde{C} has dimension $2n - 1$, we have $H_k(\tilde{C}) \oplus H_k(\mathbb{R}\mathbb{P}^n) \cong 0$ for $k \geq 2n$, so $H_k(\text{AVR}^m(S^n; \frac{2\pi}{3})) \cong H_{k-1}(\tilde{Z})$ for all $k \geq 2n + 1$. In particular, since \tilde{Z} is a manifold of dimension $2n$, this shows $H_k(\text{AVR}^m(S^n; \frac{2\pi}{3})) \cong 0$ for all $k \geq 2n + 2$. The analogous argument using the Meyer–Vietoris sequence for cohomology shows $H^k(\text{AVR}^m(S^n; \frac{2\pi}{3})) \cong 0$ for all $k \geq 2n + 2$.

We now return to check that \tilde{C} and \tilde{Z} are closed, connected manifolds. We begin with the spaces C and Z , which we will in fact show are fiber bundles (see Section 3 for background). The space C is defined similarly to the tautological vector bundle over $\text{Gr}(2, n + 1)$, in which the fiber over $V \in \text{Gr}(2, n + 1)$ is V itself. With this motivation, we check explicitly that the projection $\pi: C \rightarrow \text{Gr}(2, n + 1)$ is a circle bundle. We give \mathbb{R}^{n+1} the usual inner product in order to work with orthogonal projections and orthogonal complements. For a given $V \in \text{Gr}(2, n + 1)$, let $P_V: \mathbb{R}^{n+1} \rightarrow V$ be the orthogonal projection, and let $U_V \subset \text{Gr}(2, n + 1)$ be the open set of subspaces mapped bijectively onto V by P_V . Then for each $X \in U_V$, the map $X \cap S^n \rightarrow V \cap S^n$ given by $x \mapsto \frac{P_V(x)}{\|P_V(x)\|}$ is a homeomorphism, so we have a homeomorphism $\pi^{-1}(U_V) \cong U_V \times (V \cap S^n)$ that sends (X, x) to $(X, \frac{P_V(x)}{\|P_V(x)\|})$. Since $V \cap S^n \cong S^1$, this shows C is a fiber bundle over $\text{Gr}(2, n + 1)$ with fiber S^1 . An analogous argument shows that Z is a fiber bundle over $\text{Gr}(2, n + 1)$ with fiber $S^1 \times S^1$, and in particular, this implies Z and C are closed, connected manifolds of dimensions $2n$

and $2n - 1$, respectively. They further inherit smooth structures from the Grassmanian and the circle.

The quotient map $C \rightarrow \tilde{C}$ identifies each point (V, y) with (V, y') and (V, y'') , where y, y' , and y'' are the vertices of an equilateral triangle lying in V . We check that *locally*, this map can be realized by quotienting by a group action that permutes the vertices of such triangles. Beginning with the homeomorphism $\pi^{-1}(U_V) \cong U_V \times (V \cap S^n)$ above, fix an orientation of $(V \cap S^n) \cong S^1$ and assign each fiber $\pi^{-1}(X)$ the corresponding orientation under the homeomorphism. For each $X \in U_V$, let T_X be the linear transformation that rotates X by an angle $\frac{2\pi}{3}$ in the positively oriented direction and leaves the orthogonal complement of X fixed. For any $(X, x) \in \pi^{-1}(U_V)$, the vector x^\perp that lies in X and is at an angle of $\frac{\pi}{2}$ from x in the positively oriented direction depends smoothly on (X, x) : it can be found by choosing a positively oriented orthonormal basis in V containing $\frac{P_V(x)}{\|P_V(x)\|}$, applying the homeomorphism above to get a positively oriented basis in X containing x , and applying the Gram–Schmidt process. Since $T_X(x)$ can be written as a linear combination of x and x^\perp , it is a smooth function of (X, x) . We thus get a smooth action³ of $\mathbb{Z}/3\mathbb{Z}$ on $\pi^{-1}(U_V)$ by setting $[n] \cdot (X, x) = (X, T_X^n x)$. The quotient $\pi^{-1}(U_V)/(\mathbb{Z}/3\mathbb{Z})$ of $\pi^{-1}(U_V)$ by this group action identifies exactly those sets of points in $\pi^{-1}(U_V)$ that are identified by the quotient map $C \rightarrow \tilde{C}$, and furthermore the quotient manifold theorem ([65, Theorem 21.10]) shows that $\pi^{-1}(U_V)/(\mathbb{Z}/3\mathbb{Z})$ is a manifold of dimension $2n - 1$. Therefore the class of any point (V, y) in \tilde{C} has a neighborhood that is homeomorphic to \mathbb{R}^{2n-1} , so we conclude that \tilde{C} is a closed, connected manifold of dimension $2n - 1$. An analogous argument shows \tilde{Z} is a closed, connected manifold of dimension $2n$, as required in our work above, completing the proof of Theorem 7.1. \square

We conjecture that the results of this section could be strengthened to show $\text{AVR}^m(S^n; \frac{2\pi}{3})$ is in fact homotopy equivalent to a CW complex of dimension $2n + 1$, since the fact that \tilde{C} and \tilde{Z} are manifolds imply they have CW structures (see [56, Corollary A.12] or [71, Theorem 3.5]).

8. THE TOTAL ANTI-VR COMPLEX AND THICKENING

We now introduce the *total anti-VR simplicial complex* and the *total anti-VR metric thickening*, whose definitions and behavior are related to anti-VR complexes and thickenings. The results in this section will be useful when proving Theorem 10.3 on the non-existence of graph homomorphisms between Borsuk graphs. Indeed, the total anti-VR constructions allow more flexibility (than the anti-VR constructions) when working with the possibly discontinuous functions that arise in the context of graph homomorphisms.

Definition 8.1. Let X be a metric space and $r \geq 0$. The *total anti-VR complex* is the simplicial complex $\text{TAVR}(X; r)$ with

- vertex set X
- simplices of the form $\{x_1, \dots, x_k, y_1, \dots, y_l\}$, where we require that $k, l \geq 1$, and that $d(x_i, y_j) \geq r$ for $1 \leq i \leq k$ and $1 \leq j \leq l$ (and all faces of these simplices).

We let $\text{TAVR}^m(X; r)$ denote the associated *total anti-VR metric thickening* from Definition 4.4.

³Note that this group action cannot be extended to all of C , since then it is not possible to assign consistent orientations to all fibers.

As we described in Section 4.2, in settings where the input metric space X is not discrete, the topology of anti-VR metric thickenings does not seem to be so closely related to the topology of anti-VR simplicial complexes. We expect, however, that the topology of the total anti-VR complex is more closely related to that of the anti-VR metric thickening. Variants of the total anti-VR complexes which generalize from two sets $\{x_i\}_i$ and $\{y_j\}_j$ to more sets may be useful when considering anti-VR complexes and thickenings of spheres for scales below $\frac{2\pi}{3}$.

Lemma 8.2. *Let X be a metric space and $r \geq 0$. Then we have inclusions $\text{AVR}(X; r) \hookrightarrow \text{TAVR}(X; r)$ and $\text{AVR}^m(X; r) \hookrightarrow \text{TAVR}^m(X; r)$.*

Proof. It suffices to prove the simplicial complex case, which then implies the metric thickening case. By definition, X is the vertex set of $\text{TAVR}(X; r)$, and it is also the vertex set of $\text{AVR}(X; r)$. Now, to see that every simplex of dimension at least one in $\text{AVR}(X; r)$ is a simplex in $\text{TAVR}(X; r)$, suppose $\{x_0, x_1, \dots, x_k\}$ is a simplex in $\text{AVR}(X; r)$ with $k \geq 1$. This means that $d(x_i, x_j) \geq r$ for $0 \leq i, j, \leq k$ with $i \neq j$. Hence if we let $y_1 = x_0$, we see that $\{x_0, x_1, \dots, x_k\} = \{y_1, x_1, \dots, x_k\}$ is a simplex in $\text{TAVR}(X; r)$, since $d(x_i, y_1) \geq r$ for all $1 \leq i \leq k$. \square

The following proposition will be used in the proof of the no-graph-homomorphism result in Theorem 10.3.

Proposition 8.3. $\text{TAVR}^m(S^n; r) \simeq \mathbb{RP}^n$ for $\frac{2\pi}{3} < r \leq \pi$.

Proof. We will show that $\text{TAVR}^m(S^n; r) \simeq \text{AVR}^m(S^n; r)$ for all r in this range, and then the result will follow since $\text{AVR}^m(S^n; r) \simeq \mathbb{RP}^n$ by Theorem 5.1. Let $\mu = \sum_{i=1}^k \mu_i \delta_{x_i} + \sum_{j=1}^\ell \mu'_j \delta_{y_j} \in \text{TAVR}^m(S^n; r)$ with $\text{supp}(\mu) = \{x_1, \dots, x_k, y_1, \dots, y_\ell\}$ satisfying $d(x_i, y_j) \geq r$ for all $1 \leq i \leq k$ and $1 \leq j \leq \ell$.

Let $\overline{\mu_x} = \sum_{i=1}^k \tilde{\mu}_i x_i \in \mathbb{R}^{n+1}$ and $\overline{\mu_y} = \sum_{j=1}^\ell \tilde{\mu}'_j y_j \in \mathbb{R}^{n+1}$, where $\tilde{\mu}_i = \mu_i / \sum_k \mu_k$ and $\tilde{\mu}'_j = \mu'_j / \sum_k \mu'_k$. Consider the radial projections $\mu_x^* = \overline{\mu_x} / \|\overline{\mu_x}\| \in S^n$ and $\mu_y^* = \overline{\mu_y} / \|\overline{\mu_y}\| \in S^n$. Define $\rho: \text{TAVR}^m(S^n; r) \rightarrow \text{AVR}^m(S^n; r)$ by $\mu \mapsto (\sum_{i=1}^k \mu_i) \delta_{\mu_x^*} + (\sum_{j=1}^\ell \mu'_j) \delta_{\mu_y^*}$. To see that ρ is well-defined, we must show that $d(\mu_x^*, \mu_y^*) \geq r$. Let $\theta_{ij} = d(x_i, y_j)$ for each i and j . Then $\theta_{ij} \geq r$ for $\frac{2\pi}{3} < r \leq \pi$, giving that $\langle x_i, y_j \rangle = \cos(\theta_{ij}) \leq \cos(r)$. Hence, using the fact that $\sum_i \sum_j \tilde{\mu}_i \tilde{\mu}'_j = 1$, we have

$$\begin{aligned} \langle \overline{\mu_x}, \overline{\mu_y} \rangle &= \langle \sum_{i=1}^k \tilde{\mu}_i x_i, \sum_{j=1}^\ell \tilde{\mu}'_j y_j \rangle = \sum_i \sum_j \tilde{\mu}_i \tilde{\mu}'_j \langle x_i, y_j \rangle \\ &\leq \sum_i \sum_j \tilde{\mu}_i \tilde{\mu}'_j \cos(r) = \cos(r) \left(\sum_i \tilde{\mu}_i \cdot \sum_j \tilde{\mu}'_j \right) = \cos(r)(1 \cdot 1) = \cos(r). \end{aligned}$$

Since $\cos(r) < 0$ for $\frac{2\pi}{3} < r \leq \pi$ and since $\|\overline{\mu_x}\| \|\overline{\mu_y}\| \leq 1$, we thus have $\langle \overline{\mu_x}, \overline{\mu_y} \rangle \leq \cos(r) \leq \|\overline{\mu_x}\| \|\overline{\mu_y}\| \cos(r)$. It follows that $\langle \mu_x^*, \mu_y^* \rangle \leq \cos(r)$ and hence $d(\mu_x^*, \mu_y^*) \geq r$, as desired. Since μ_x^* and μ_y^* vary continuously with μ , the map ρ is continuous.

Let $\iota: \text{AVR}^m(S^n; r) \hookrightarrow \text{TAVR}^m(S^n; r)$ be the inclusion from Lemma 8.2. We claim that ρ and ι are homotopy inverses. Note that $\rho \circ \iota$ is the identity on $\text{AVR}^m(S^n; r)$. For the other composition, we must show that $\iota \circ \rho$ is homotopic to the identity map on $\text{TAVR}^m(S^n; r)$. To see this, consider

the linear homotopy $H: \text{TAVR}^m(S^n; r) \times I \rightarrow \text{TAVR}^m(S^n; r)$ defined by

$$\begin{aligned} H(\mu, t) &= (1-t)\mu + t \cdot \iota(\rho(\mu)) \\ &= (1-t) \sum_{i=1}^k \mu_i \delta_{x_i} + t \left(\sum_{i=1}^k \mu_i \right) \delta_{\mu_x^*} + (1-t) \sum_{j=1}^{\ell} \mu'_j \delta_{y_j} + t \left(\sum_{j=1}^{\ell} \mu'_j \right) \delta_{\mu_y^*}. \end{aligned}$$

when $0 < t < 1$, the support of $H(\mu, t)$ is $\{x_1, \dots, x_k, \mu_x^*, y_1, \dots, y_\ell, \mu_y^*\}$. To see that H is well-defined, we need to show $d(\mu_x^*, y_j) \geq r$ for $1 \leq j \leq \ell$ and $d(x_i, \mu_y^*) \geq r$ for $1 \leq i \leq k$.

Using the fact that $\sum_{i=1}^k \tilde{\mu}_i = 1$, we get

$$\langle \overline{\mu_x}, y_j \rangle = \left\langle \sum_{i=1}^k \tilde{\mu}_i x_i, y_j \right\rangle = \sum_{i=1}^k \tilde{\mu}_i \langle x_i, y_j \rangle \leq \sum_{i=1}^k \tilde{\mu}_i \cos(r) = \cos(r) \leq \|\overline{\mu_x}\| \cos(r).$$

Thus, $\langle \mu_x^*, y_j \rangle \leq \cos(r)$, which proves that $d(\mu_x^*, y_j) \geq r$ for all $1 \leq j \leq \ell$. A similar argument shows $d(x_i, \mu_y^*) \geq r$.

The map H is continuous by Lemma 4.7. Hence H gives a homotopy from the identity map on $\text{TAVR}^m(S^n; r)$ to $\iota \circ \rho$. We have shown $\text{TAVR}^m(S^n; r) \simeq \text{AVR}^m(S^n; r)$. \square

We are interested in possible connections between total anti-Vietoris–Rips complexes, neighborhood complexes [67], and box complexes [37, 69, 70].

9. CHROMATIC NUMBERS OF BORSUK GRAPHS

This section contains a discussion of chromatic numbers in Section 9.1, Borsuk graphs in Section 9.2, and circular chromatic numbers and their relationship with Borsuk graphs in Section 9.3.

9.1. Chromatic numbers. Let $G = (V, E)$ be a simple graph, meaning that there are no loops and no multiple edges.

Definition 9.1. A *graph homomorphism* $f: G \rightarrow H$ from a graph G to a graph H is a function from the vertices of G to the vertices of H such that if (u, v) is an edge in G , then $(f(u), f(v))$ is an edge in H .

The *chromatic number* of G , $\chi(G)$ is the minimum integer k such that the vertex set V can be colored with k different colors, such that no two adjacent vertices have the same color. Let K_n be the complete graph on n vertices. Then in terms of graph homomorphisms,

$$\chi(G) = \inf\{n \mid \text{there is a graph homomorphism } G \rightarrow K_n\}.$$

For example, $\chi(K_n) = n$.

9.2. Borsuk graphs. Let S^n be the n -sphere, equipped with the geodesic metric. For any $0 < \alpha < \pi$, let $G(S^n; \alpha)$ be the graph whose vertex set is the sphere $V = S^n$, and whose edge set is all pairs of vertices at distance exactly α apart. Similarly, let $\text{Bor}(S^n; \alpha)$ be the graph whose vertex set is the sphere $V = S^n$, and whose edge set is all pairs of vertices at distance *at least* α apart. In different references, both the graph $G(S^n; \alpha)$ and the graph $\text{Bor}(S^n; \alpha)$ have been given the name of the *Borsuk graph* [67, 66, 78, 79]. The papers [62, 77] contain nice summaries as well. The chromatic number of $G(S^n; \alpha)$ and of $\text{Bor}(S^n; \alpha)$ now depend on the value of α .

What are the chromatic numbers of $G(S^n; \alpha)$ and of $\text{Bor}(S^n; \alpha)$ for $0 < \alpha < \pi$? In 1981, Erdős conjectured that for any fixed $0 < \alpha < \pi$, the chromatic numbers $\chi(G(S^n; \alpha))$ go to infinity as $n \rightarrow \infty$ [46]. This conjecture was proven by Lovász using topological techniques [66]. We also refer the reader to Lovász' famous proof of the chromatic numbers of Kneser graphs [67], which gave birth to the field of topological combinatorics, and which mention Borsuk graphs as a more geometric analogue of the combinatorially-defined Kneser graphs. Since $G(S^n; \alpha) \subseteq \text{Bor}(S^n; \alpha)$, it is therefore also true that $\chi(\text{Bor}(S^n; \alpha)) \rightarrow \infty$ as $n \rightarrow \infty$. Indeed, Lovász shows that $\chi(\text{Bor}(S^n; \alpha)) = n + 2$ for all α sufficiently close to π [66]. For the remainder of this paper, we will focus attention on $\text{Bor}(S^n; \alpha)$ instead of $G(S^n; \alpha)$.

Raigarodskii [78, 79] points out that one of Lovász' claims in [66] is not correct (even though his result $\chi(\text{Bor}(S^n; \alpha)) \rightarrow \infty$ still is)⁴. Indeed, let $r_n = \arccos(-\frac{1}{n+1})$ be the diameter of a regular $(n + 1)$ -dimensional simplex inscribed in S^n . Also, let s_n be the diameter of the *radial projection* of a single n -dimensional face of a regular $(n + 1)$ -dimensional simplex inscribed in S^n . From [85] (after plugging $\cos \ell = -\frac{1}{n+1}$ into (2.17) and (2.18)), we have

$$s_n = \begin{cases} \arccos(-\frac{n+1}{n+3}) & \text{for } n \text{ odd} \\ \arccos(-\sqrt{\frac{n}{n+4}}) & \text{for } n \text{ even.} \end{cases}$$

Note $r_1 = s_1$ and $r_n < s_n$ for all $n \geq 2$. Also, s_n is an *increasing* function of n (see Figure 5), and we have $s_n \rightarrow \pi$ as $n \rightarrow \infty$. Though Lovász claimed $\chi(\text{Bor}(S^n; \alpha)) = n + 2$ for all $r_n < \alpha < \pi$, Raigarodskii shows that his proof technique in fact only gives $\chi(\text{Bor}(S^n; \alpha)) = n + 2$ for all $s_n < \alpha < \pi$ [78, 79].

For any graph $G = (V, E)$, let $N(G)$ be the *neighborhood simplicial complex* of G , defined as follows. The vertex set of $N(G)$ is V , i.e. the same as the vertex set of G . A finite subset $\{v_0, \dots, v_k\} \subseteq V$ forms a simplex of $N(G)$ if there is vertex $w \in V$ that is adjacent to each of v_0, \dots, v_k , i.e. if v_0, \dots, v_k share a common neighbor in V . In [67, Theorem 1], Lovász proves that if the first k homotopy groups of $N(G)$ vanish, then the chromatic number of G is at least $k + 3$ (see also [69, Theorem 5.9.4]). In the case when $G = \text{Bor}(S^n; \alpha)$ is a Borsuk graph, then the neighborhood complex $N(G)$ is a Čech complex built on S^n at scale $\pi - \alpha$, which for $\frac{\pi}{2} < \alpha < \pi$ is homotopy equivalent to S^n by the nerve lemma; see [9]. Hence for $\frac{\pi}{2} < \alpha < \pi$, the neighborhood complex $N(\text{Bor}(S^n; \alpha))$ has its first $n - 1$ homotopy groups vanishing, and the chromatic number of $\text{Bor}(S^n; \alpha)$ is at least $n + 2$.

Lemma 9.2 ([78, 79, 66]). $\chi(\text{Bor}(S^n; \alpha)) = n + 2$ for $s_n < \alpha < \pi$.

Proof. As per the last paragraph, $\chi(\text{Bor}(S^n; \alpha)) \geq n + 2$ for $\alpha < \pi$. We only need to show that $\chi(\text{Bor}(S^n; \alpha)) \leq n + 2$ for $\alpha > s_n$. Consider the regular $n + 1$ -simplex inscribed in S^n and project the $n + 2$ faces of it onto S^n . The diameter of such image of the faces is s_n . Since $\alpha > s_n$, the vertices of any edge in $\text{Bor}(S^n; \alpha)$ are more than s_n apart. Thus if we use different colors for vertices in each different such set, we get an $(n + 2)$ -coloring of $\text{Bor}(S^n; \alpha)$. \square

⁴Raigarodskii furthermore shows that $\chi(\text{Bor}(S^n; \alpha))$ grows exponentially fast in n , for any fixed $0 < \alpha < \pi$.

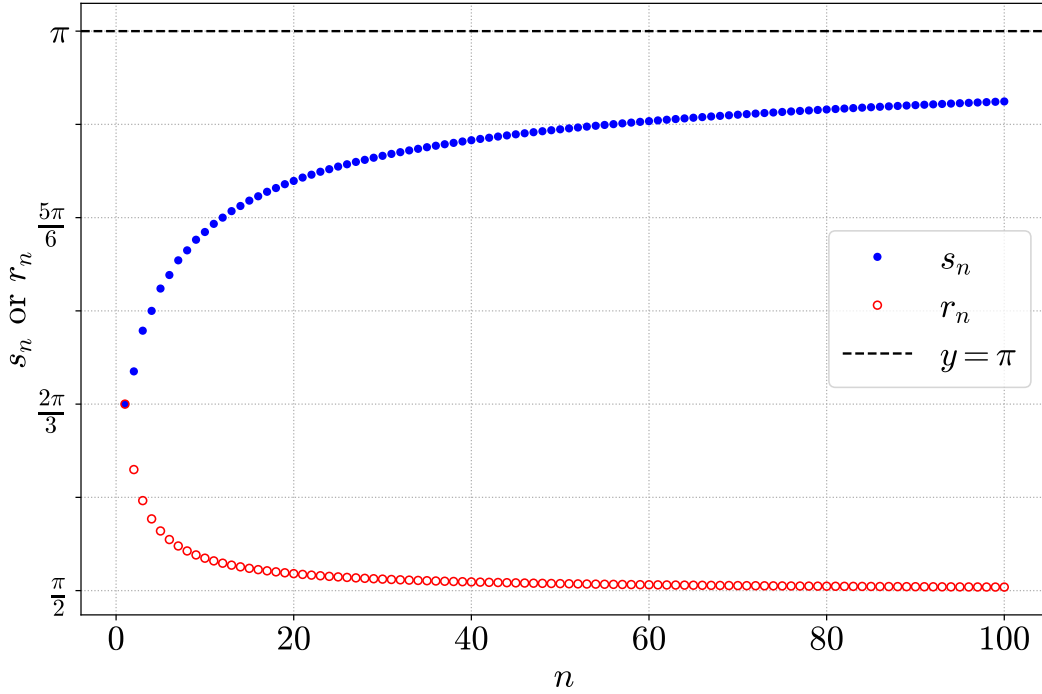

FIGURE 5. Plot of s_n and r_n vs. n for $n = 1$ to 100 , where r_n is the diameter of the vertex set of an inscribed regular $(n+1)$ -simplex in S^n , and where s_n is the diameter of a radially projected n -face.

How do the chromatic numbers of $\text{Bor}(S^n; \alpha)$ change as the value of $0 < \alpha < s_n$ decreases? Some asymptotics for the chromatic number of $\text{Bor}(S^n; \alpha)$ as the scale α decreases towards zero are given in [74], but we are also interested in exact values.

9.3. Circular Chromatic Numbers. Borsuk graphs are naturally related to chromatic numbers of graphs via a related quantity, the circular chromatic number. All of the material in this section on circular chromatic numbers is standard, and can be found in [94, 58].

The circular chromatic number of a graph $G = (V(G), E(G))$ can be defined as follows. For $r \geq 1$, an r -coloring of a graph G is a function $\psi: V(G) \rightarrow S^1$ such that $d(\psi(v), \psi(v')) \geq \frac{2\pi}{r}$ whenever v, v' are adjacent in G (here, d denotes the geodesic distance on S^1). Then the *circular chromatic number* of G is

$$\chi_C(G) := \inf\{r \geq 1 \mid \text{there exists an } r\text{-coloring of } G\}.$$

Lemma 9.3. *For any graph G ,*

$$\begin{aligned} \chi_C(G) &= \inf\{r \geq 1 \mid \text{there exists a graph homomorphism } \phi: G \rightarrow \text{Bor}(S^1; \frac{2\pi}{r})\} \\ &= \inf\{\frac{2\pi}{\alpha} \geq 1 \mid \text{there exists a graph homomorphism } \phi: G \rightarrow \text{Bor}(S^1; \alpha)\}. \end{aligned}$$

Proof. If the graph G is r -colorable, then there exists a function $\psi: V(G) \rightarrow S^1$ such that $d(\psi(v), \psi(v')) \geq \frac{2\pi}{r}$ whenever v, v' are adjacent in G . Thus, ψ is a graph homomorphism from G to $\text{Bor}(S^1; \frac{2\pi}{r})$. The converse follows similarly. Hence, we get the first equality. The second equality is clear after replacing $\frac{2\pi}{r}$ with α . \square

Recall that, n -coloring of a graph G can be viewed as a graph homomorphism $G \rightarrow K_n$, where K_n is the complete graph on n vertices. An r -coloring replaces K_n with the Borsuk graph $\text{Bor}(S^1; \frac{2\pi}{r})$ by Lemma 9.3. The name of the circular chromatic number is justified by its relationship to the usual chromatic number, given in the following lemma.

Lemma 9.4. *For any graph G with finite chromatic number, we have $\chi(G) = \lceil \chi_C(G) \rceil$.*

Proof. Let $n \geq 1$. It is sufficient to show there exists a pair of graph homomorphisms $K_n \rightarrow \text{Bor}(S^1; \frac{2\pi}{n})$ and $\text{Bor}(S^1; \frac{2\pi}{n}) \rightarrow K_n$. Indeed, this will show there exists a graph homomorphism $G \rightarrow K_n$ if and only if there exists a graph homomorphism $G \rightarrow \text{Bor}(S^1; \frac{2\pi}{n})$, and thus $\chi_C(G) \leq n$ if and only if $\chi(G) \leq n$.

Let $\{0, 1, \dots, n-1\}$ be the vertices of K_n and write points on the circle as angles in $[0, 2\pi)$. A homomorphism $K_n \rightarrow \text{Bor}(S^1; \frac{2\pi}{n})$ is given by $k \mapsto \frac{2\pi k}{n}$, since two distinct points on the circle of the form $\frac{2\pi k}{n}$ and $\frac{2\pi k'}{n}$ are at a distance of at least $\frac{2\pi}{n}$. A homomorphism $\text{Bor}(S^1; \frac{2\pi}{n}) \rightarrow K_n$ is given by sending any point on the circle in $[\frac{2\pi k}{n}, \frac{2\pi(k+1)}{n})$ to k , since then any two points at distance greater than $\frac{2\pi}{n}$ are sent to different vertices in K_n . \square

10. NONEXISTENCE OF GRAPH HOMOMORPHISMS BETWEEN BORSUK GRAPHS

In this section we will prove a nonexistence result regarding graph homomorphisms between Borsuk graphs. Recall from Definition 9.1 that a graph homomorphism is a function between vertex sets that sends edges to edges. Therefore, a graph homomorphism $f: \text{Bor}(S^k; r) \rightarrow \text{Bor}(S^n; \alpha)$ is a function $S^k \rightarrow S^n$ that sends points at distance $\geq r$ to points at distance $\geq \alpha$. We prove in Theorem 10.3 that if $f: \text{Bor}(S^k; r) \rightarrow \text{Bor}(S^n; \alpha)$ is a graph homomorphism with $k > n$ and $r < \pi$, then necessarily $\alpha \leq \frac{2\pi}{3}$. We prove the result using the topology of anti-Vietoris–Rips thickenings.

A weaker version of this result can be deduced from the known chromatic numbers of Borsuk graphs of spheres at scale parameters bigger than s_n . Recall that $\chi(\text{Bor}(S^k; r)) \geq k + 2$ for $r < \pi$. Also, from Lemma 9.2, $\chi(\text{Bor}(S^n; \alpha)) = n + 2$ when $s_n < \alpha < \pi$. A graph homomorphism $f: \text{Bor}(S^k; r) \rightarrow \text{Bor}(S^n; \alpha)$ for $\alpha > s_n$ would imply $k + 2 \leq \chi(\text{Bor}(S^k; r)) \leq n + 2$, which is impossible since $k > n$. From that, we can deduce that if such a graph homomorphism exists, then necessarily $\alpha \leq s_n$. Since s_n is an increasing function with $s_1 = \frac{2\pi}{3}$ and $s_n \rightarrow \pi$ as $n \rightarrow \infty$, this conclusion from chromatic numbers is strictly weaker than our Theorem 10.3 for $n \geq 2$.

First, we want to make an observation related to mapping cylinders that will appear in the proof of this theorem. The *mapping cylinder* M_f of a continuous function $f: X \rightarrow Y$ is the quotient space

$$M_f = \frac{(X \times I) \amalg Y}{(x, 1) \sim f(x)}.$$

The mapping cylinder M_f is always homotopy equivalent to Y , simply by contracting $X \times I$ down to $X \times \{1\}$, which has been identified with its image in Y .

As an example, consider the mapping cylinder of the 2-to-1 covering space map $f: S^n \rightarrow \mathbb{RP}^n$ defined by $f(x) = \{x, -x\}$ for all $x \in S^n$. In this case, M_f is homeomorphic to $\text{AVR}^m(S^n; \pi)$, via the homeomorphism $h: M_f \rightarrow \text{AVR}^m(S^n; \pi)$ defined by $h((x, t)) = (1 - \frac{t}{2})\delta_x + \frac{t}{2}\delta_{-x} \in \text{AVR}^m(S^n; \pi)$ for all $x \in S^n$ and $t \in I$.⁵ This observation implies $\text{AVR}^m(S^n; \pi) \cong M_f \simeq \mathbb{RP}^n$, giving another proof of Lemma 5.3.

We now describe a well-known fact about maps between projective spaces, which we will later use as our topological obstruction to the existence of graph homomorphisms between Borsuk graphs.

Lemma 10.1. *Let $k > n$, and let $f: \mathbb{RP}^k \rightarrow \mathbb{RP}^n$ be a continuous map. Then the induced map $f_*: \pi_1(\mathbb{RP}^k) \rightarrow \pi_1(\mathbb{RP}^n)$ is trivial.*

Though this lemma is well-known, we give a proof for completeness. Our proof uses the ring structure on cohomology, but more elementary proofs can be obtained using covering spaces [88].

Proof. Towards a contradiction, suppose the induced map $f_*: \pi_1(\mathbb{RP}^k) \rightarrow \pi_1(\mathbb{RP}^n)$ is non-trivial. For $n \geq 2$, we have $\pi_1(\mathbb{RP}^n) \cong \mathbb{Z}/2$. Since the fundamental group is abelian, it is isomorphic to the integral (first) homology group by the Hurewicz theorem. Thus we have an isomorphism $f_*: \mathbb{Z}/2 \rightarrow \mathbb{Z}/2$. Using universal coefficient theorem, we have $H^1(\mathbb{RP}^n; \mathbb{Z}/2) \cong \text{Hom}(H_1(\mathbb{RP}^n; \mathbb{Z}), \mathbb{Z}/2)$. Thus we obtain an isomorphism $f^*: H^1(\mathbb{RP}^n; \mathbb{Z}/2) \rightarrow H^1(\mathbb{RP}^k; \mathbb{Z}/2)$ or $f^*: \mathbb{Z}/2 \rightarrow \mathbb{Z}/2$. This contradicts Exercise 3(a) of Section 3.2 of [56], which says there is no map $\mathbb{RP}^k \rightarrow \mathbb{RP}^n$ inducing a non-trivial map on H^1 if $k > n$. For a sketch of this exercise, let $H^*(\mathbb{RP}^n; \mathbb{Z}/2) \cong (\mathbb{Z}/2)[\alpha]/(\alpha^{n+1})$ where α is the generator of $H^1(\mathbb{RP}^n; \mathbb{Z}/2)$. Similarly, $H^*(\mathbb{RP}^k; \mathbb{Z}/2) \cong (\mathbb{Z}/2)[\beta]/(\beta^{k+1})$ where β is the generator of $H^1(\mathbb{RP}^k; \mathbb{Z}/2)$. If $f^*: H^1(\mathbb{RP}^n; \mathbb{Z}/2) \rightarrow H^1(\mathbb{RP}^k; \mathbb{Z}/2)$ is an isomorphism, then $f^*(\alpha) = \beta$. But this would give the contradiction $0 = f^*(0) = f^*(\alpha^{n+1}) = (f^*(\alpha))^{n+1} = \beta^{n+1} \neq 0$.

For the edge case $n = 1$, at the level of fundamental groups we have the map $f_*: \mathbb{Z}/2 \rightarrow \mathbb{Z}$, which is already trivial. Thus for $k > n$, any continuous map $f: \mathbb{RP}^k \rightarrow \mathbb{RP}^n$ induces the trivial map on fundamental groups. \square

The proof of Theorem 10.3 will rely on the following lemma. We remind the reader that total anti-VR thickenings are defined in Definition 8.1.

Lemma 10.2. *Let (Y, d) be a totally bounded metric space. For $\varepsilon > 0$, let X be a finite $\frac{\varepsilon}{2}$ -net in Y . Then for any $r > 0$, there exists a continuous map $\phi: \text{TAVR}^m(Y; r + \varepsilon) \rightarrow \text{TAVR}^m(X; r)$ such that $\text{supp}\{\phi(\mu)\} \subseteq B(\text{supp}(\mu); \frac{\varepsilon}{2}) = \cup_{z \in \text{supp}(\mu)} B(z; \frac{\varepsilon}{2})$ for any measure $\mu \in \text{TAVR}^m(Y; r + \varepsilon)$.*

Proof. Since Y is a metric space, there exists a partition of unity $\{\rho_x: Y \rightarrow I\}_{x \in X}$ subordinate to the open cover $\{B(x; \frac{\varepsilon}{2})\}_{x \in X}$ of Y . So, for all $y \in Y$ we have $\sum_{x \in X} \rho_x(y) = 1$ with only finitely many $\rho_x(y)$ nonzero, and we have $\rho_x(y) = 0$ if $y \notin B(x; \frac{\varepsilon}{2})$. Define $\phi: \text{TAVR}^m(Y; r + \varepsilon) \rightarrow \text{TAVR}^m(X; r)$ in the following manner. For $\delta_y \in \text{TAVR}^m(Y; r + \varepsilon)$ a measure supported on the singleton set $\{y\}$,

⁵Since f is surjective, we do not need to specify where the homeomorphism maps points in $Y \subseteq M_f$, since that is already determined by where the homeomorphism maps the points in $X \times \{1\}$. Indeed, $\{x, -x\} \in Y = \mathbb{RP}^n$ is identified in M_f with both of the points $(x, 1), (-x, 1) \in S^n \times \{1\}$, and hence gets identified under our homeomorphism with $h((x, 1)) = h((-x, 1)) = \frac{1}{2}\delta_x + \frac{1}{2}\delta_{-x} \in \text{AVR}^m(S^n; \pi)$.

we define

$$\phi(\delta_y) = \sum_{x \in X} \rho_x(y) \delta_x \in \text{TAVR}^m(X; r).$$

Clearly, $\text{supp}(\phi(\delta_y)) \subseteq B(y; \frac{\varepsilon}{2})$. We then extend ϕ linearly to all of $\text{TAVR}^m(Y; r + \varepsilon)$, meaning

$$\sum_i \lambda_i \delta_{y_i} + \sum_j \gamma_j \delta_{z_j} \mapsto \sum_i \lambda_i \phi(\delta_{y_i}) + \sum_j \gamma_j \phi(\delta_{z_j}).$$

Note that if $\phi(\delta_y)$ has non-zero weight on x , then $d(x, y) < \frac{\varepsilon}{2}$. Thus for a general measure $\mu = \sum_i \lambda_i \delta_{y_i} + \sum_j \gamma_j \delta_{z_j} \in \text{TAVR}^m(Y; r + \varepsilon)$, the image $\phi(\mu)$ has support $\text{supp}(\phi(\mu))$ contained in $B(\text{supp}(\mu); \frac{\varepsilon}{2}) := \cup_{z \in \text{supp}(\mu)} B(z; \frac{\varepsilon}{2})$. Since the $\{y_i\}$ and $\{z_j\}$ clusters are at least $r + \varepsilon$ apart, the clusters in the image will be at least r apart. Hence ϕ is well-defined.

We next show that ϕ is continuous. Since Y is totally bounded and hence bounded, by [11, Corollary A.2] or [23, 50], it suffices to show that for every bounded, continuous function $f: Y \rightarrow \mathbb{R}$ and for any sequence (μ_n) converging to $\mu \in \text{TAVR}^m(Y; r + \varepsilon)$, we have $\int_Y f d\phi(\mu_n) \rightarrow \int_Y f d\phi(\mu)$. Given a bounded, continuous function $f: Y \rightarrow \mathbb{R}$, define $\tilde{f}: Y \rightarrow \mathbb{R}$ by $\tilde{f}(y) := \sum_{x \in X} \rho_x(y) f(x)$. Then \tilde{f} is bounded and continuous and $\int_Y f d\phi(\nu) = \int_Y \tilde{f} d\nu$ for every $\nu \in \text{TAVR}^m(Y; r + \varepsilon)$. Since $\mu_n \rightarrow \mu$, we have $\int_Y f d\phi(\mu_n) = \int_Y \tilde{f} d\mu_n \rightarrow \int_Y \tilde{f} d\mu = \int_Y f d\phi(\mu)$, as desired.

We recall that a graph homomorphism $f: \text{Bor}(S^k; r) \rightarrow \text{Bor}(S^n; \alpha)$ is equivalent to a possibly discontinuous function $f: S^k \rightarrow S^n$ such that $d(x, x') \geq r$ implies $d(f(x), f(x')) \geq \alpha$ for all $x, x' \in S^k$. \square

Theorem 10.3. *For all $k > n$ and $r < \pi$, there is no graph homomorphism $f: \text{Bor}(S^k; r) \rightarrow \text{Bor}(S^n; \alpha)$ when $\alpha > \frac{2\pi}{3}$.*

Proof. If we can prove Theorem 10.3 in the special case $\frac{2\pi}{3} < r < \pi$, then the result follows for all $r < \pi$. Indeed, for $r \leq \frac{2\pi}{3}$, this follows simply by considering the composition $\text{Bor}(S^k; \frac{2\pi}{3}) \hookrightarrow \text{Bor}(S^k; r) \rightarrow \text{Bor}(S^n; \alpha)$. Hence we will prove the theorem for $\frac{2\pi}{3} < r < \pi$.

Suppose there exists a graph homomorphism $f: \text{Bor}(S^k; r) \rightarrow \text{Bor}(S^n; \alpha)$ with $\frac{2\pi}{3} < r < \pi$ and $\alpha > \frac{2\pi}{3}$; we will derive a topological contradiction. For expository purposes, for the moment assume that $f: S^k \rightarrow S^n$ is a *continuous* map. After explaining this simpler case of the proof, we will then relax this assumption and allow $f: S^k \rightarrow S^n$ to be an arbitrary function.

If f is continuous, then we get the following diagram of continuous maps:

$$\mathbb{R}\mathbb{P}^k \simeq \text{AVR}^m(S^k; r) \xrightarrow{f} \text{AVR}^m(S^n; \alpha) \simeq \mathbb{R}\mathbb{P}^n.$$

The first homotopy equivalence above is since $\frac{2\pi}{3} < r < \pi$, and the second is since $\frac{2\pi}{3} < \alpha < \pi$; see Theorem 5.1. The induced map in the middle is continuous by Lemma 4.5.

Let $x \in S^k$ and let $\omega: I \rightarrow S^k$ be a geodesic in S^k from $-x$ to x . Consider the following loop γ in $\text{AVR}^m(S^k; r)$ starting and ending at δ_x , depicted in blue in $\text{AVR}^m(S^k; r)$ in Figure 6(top left).

$$\gamma(t) = \begin{cases} (1 - 2t)\delta_x + 2t\delta_{-x} & 0 \leq t \leq \frac{1}{2} \\ \delta_{\omega(2t-1)} & \frac{1}{2} \leq t \leq 1, \end{cases} \quad (2)$$

Now, f maps γ to a loop $f(\gamma)$ in $\text{AVR}^m(S^n; \alpha)$ going through $\delta_{f(x)}$ and $\delta_{f(-x)}$.

$$f(\gamma(t)) = \begin{cases} (1-2t)\delta_{f(x)} + 2t\delta_{f(-x)} & 0 \leq t \leq \frac{1}{2} \\ \delta_{f(\omega(2t-1))} & \frac{1}{2} \leq t \leq 1. \end{cases}$$

Note that $d(f(x), f(-x)) \geq \alpha$, i.e., $f(x)$ and $f(-x)$ are nearly antipodal in S^n .

We will use the flashlight homotopy as in the proof of Theorem 5.1, namely $H: \text{AVR}^m(S^n; \alpha) \times I \rightarrow \text{AVR}^m(S^n; \alpha)$ with $h_0 := H(\cdot, 0) = \text{id}_{\text{AVR}^m(S^n; \alpha)}$ and $h_1 := H(\cdot, 1): \text{AVR}^m(S^n; \alpha) \rightarrow \text{AVR}^m(S^n; \pi)$, which exists since $\alpha > \frac{2\pi}{3}$. Note $h_1(f(\gamma))$ is a loop in $\text{AVR}^m(S^n; \pi)$,

$$h_1(f(\gamma(t))) = \begin{cases} \delta_{\omega_{f(x),y}(t)} & 0 \leq t \leq t_* \\ \frac{1}{1/2-2t_*}[(t-t_*)\delta_{-y} + (1/2-t_*-t)\delta_y] & t_* \leq t \leq \frac{1}{2} - t_* \\ \delta_{\omega_{-y,f(-x)}(t)} & \frac{1}{2} - t_* \leq t \leq \frac{1}{2} \\ \delta_{f(\omega(2t-1))} & \frac{1}{2} \leq t \leq 1, \end{cases}$$

where we need to explain this notation. Here y and $-y$ are the antipodal pair whose diameter is parallel to the line joining $f(x)$ and $f(-x)$ (in Figure 2, compare $f(x), f(-x), y, -y$ with $x_0, x'_0, x_1, -x_1$, respectively). Here $\omega_{f(x),y}: [0, t_*] \rightarrow S^n$ is the geodesic from $f(x)$ to y , and $\omega_{-y,f(-x)}: [\frac{1}{2} - t_*, \frac{1}{2}] \rightarrow S^n$ is the geodesic from $-y$ to $f(-x)$ on S^n , where we choose $0 < t_* < \frac{1}{4}$.

We then use the projection to the central core map in Lemma 5.3, $(1-t)\delta_x + t\delta_{-x} \mapsto \frac{1}{2}(\delta_x + \delta_{-x})$, to get a loop in the central core (which is identified with \mathbb{RP}^n , i.e., we identify the point $\frac{1}{2}(\delta_x + \delta_{-x})$ with $\{\pm x\} \in \mathbb{RP}^n$). We call this loop γ' .

$$\gamma'(t) = \begin{cases} \{\pm\omega_{f(x),y}(t)\} & 0 \leq t \leq t_* \\ \{\pm y\} & t_* \leq t \leq \frac{1}{2} - t_* \\ \{\pm\omega_{-y,f(-x)}(t)\} & \frac{1}{2} - t_* \leq t \leq \frac{1}{2} \\ \{\pm f(\omega(2t-1))\} & \frac{1}{2} \leq t \leq 1. \end{cases}$$

Choose $\{\pm y\} \in \mathbb{RP}^n$ on γ' to be the base point. Reparametrize $\gamma': [0, 1] \rightarrow \mathbb{RP}^n$ as $\gamma': [t_*, 1+t_*] \rightarrow \mathbb{RP}^n$ by taking all inputs modulo 1, so that γ' now starts and ends at $\{\pm y\}$, shown as the blue loop in Figure 6(bottom left). We claim that when we lift the loop γ' to the covering space S^n of \mathbb{RP}^n , we get a *path* from $-y$ to y , or vice versa. (Recall that lifts of paths are unique once a lift of the basepoint has been chosen.) For instance, one of the lifts $\tilde{\gamma}: [t_*, 1+t_*] \rightarrow S^n$ has the form

$$\tilde{\gamma}(t) = \begin{cases} -y & t_* \leq t \leq \frac{1}{2} - t_* \\ \omega_{-y,f(-x)}(t) & \frac{1}{2} - t_* \leq t \leq \frac{1}{2} \\ f(\omega(2t-1)) & \frac{1}{2} \leq t \leq 1 \\ \omega_{f(x),y}(t) & t_* \leq t \leq 1+t_*, \end{cases}$$

which is shown as the green path in Figure 6(bottom left). The other lift (in red) is a path from y to $-y$ in S^n . This proves that the loop γ' based at $\{\pm y\} \in \mathbb{RP}^n$ is non-trivial in $\pi_1(\mathbb{RP}^k)$ by [75, Lemma 54.6(c)], since S^n is the universal cover of \mathbb{RP}^n .

Since the loop γ' in \mathbb{RP}^n lifts to a path between antipodal points in S^n , this means that f induces a continuous map from $\mathbb{RP}^k \rightarrow \mathbb{RP}^n$ for $k > n$ that is non-trivial on π_1 . This contradicts the algebraic

fact that any continuous map $\mathbb{RP}^k \rightarrow \mathbb{RP}^n$ with $k > n$ must be trivial on π_1 (Lemma 10.1). Hence α can be at most $\frac{2\pi}{3}$.

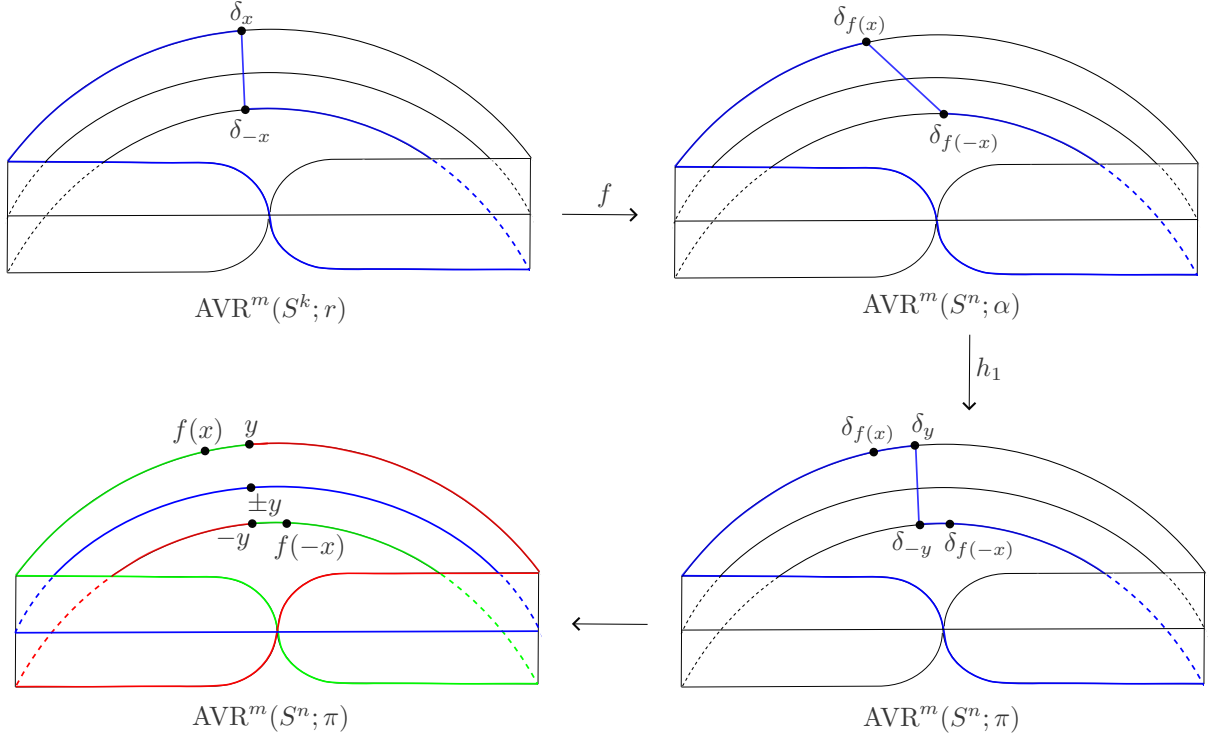

FIGURE 6. Non-trivial loop when f is continuous. The last arrow is the projection to the central core in Lemma 5.3.

Now, let us consider the general case when f need not be continuous. Suppose for a contradiction that there exists a graph homomorphism $f: \text{Bor}(S^k; r) \rightarrow \text{Bor}(S^n; \alpha)$ with $\frac{2\pi}{3} < r < \pi$ and $\alpha > \frac{2\pi}{3}$. Choose $\varepsilon > 0$ such that $r + \varepsilon < \pi$ and choose a finite $X \subseteq S^k$ that is an $\frac{\varepsilon}{2}$ -net, i.e., any point on S^k is within distance at most $\frac{\varepsilon}{2}$ from some point in X . Then we have the following diagram of continuous maps:

$$\mathbb{RP}^k \simeq \text{TAVR}^m(S^k; r + \varepsilon) \xrightarrow{\phi} \text{TAVR}^m(X; r) \xrightarrow{f} \text{TAVR}^m(S^n; \alpha) \simeq \mathbb{RP}^n.$$

The first homotopy equivalence above is since $\frac{2\pi}{3} < r < \pi$, and the last one is since $\frac{2\pi}{3} < \alpha < \pi$ (see Proposition 8.3). The first map ϕ exists by the partition of unity argument in Lemma 10.2. The second map is induced by f , as follows: $\sum_i \lambda_i \delta_{x_i} + \sum_j \lambda_j \delta_{y_j} \in \text{TAVR}^m(X; r)$, where $d(x_i, y_j) \geq r \forall i, j$, is sent to $\sum_i \lambda_i \delta_{f(x_i)} + \sum_j \lambda_j \delta_{f(y_j)} \in \text{TAVR}^m(S^n; \alpha)$. As X is finite, f induces a continuous map from $\text{TAVR}^m(X; r)$ to $\text{TAVR}^m(S^n; \alpha)$ by Corollary 4.6.

Now we show that $f\phi$ induces a non-trivial map on π_1 . Without loss of generality, assume that there exists an antipodal pair $\{x, -x\} \in X$; this can be achieved simply by replacing X with $X \cup (-X)$. Note that the anti-VR thickening is included in the total anti-VR thickening (see Lemma 8.2), and consider the loop γ in $\text{AVR}^m(S^k; r + \varepsilon) \subseteq \text{TAVR}^m(S^k; r + \varepsilon)$ defined as in Equation (2). By adjusting the sample X if necessary, we can assume there is a sequence of points

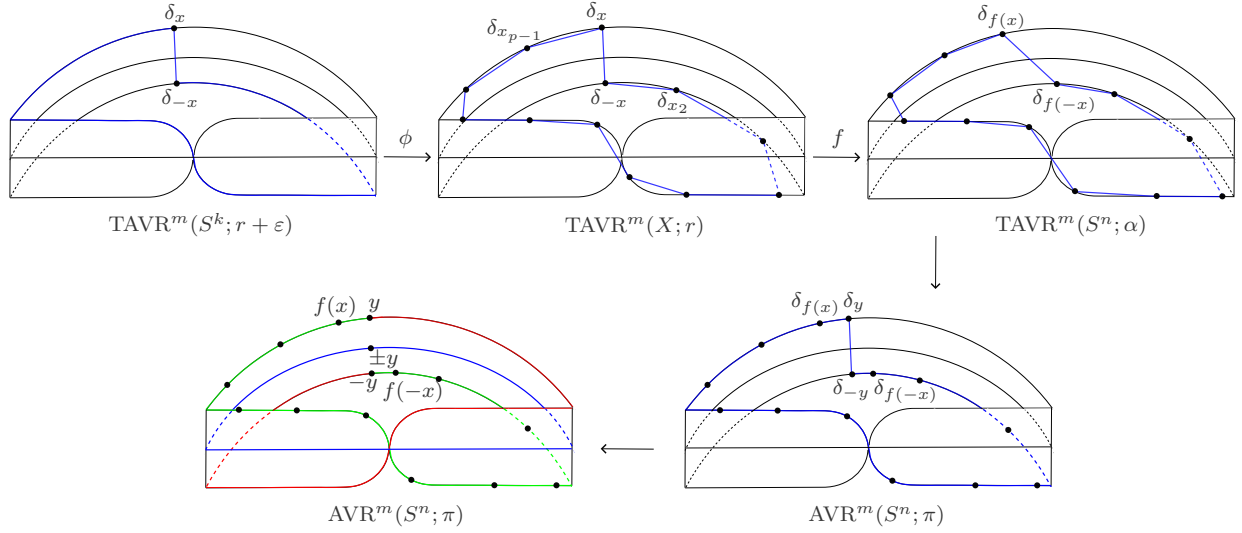

FIGURE 7. Non-trivial loop when f may not be continuous. The second-to-last arrow is the map ρ as in Proposition 8.3, followed by the flashlight homotopy h_1 . The last arrow is the projection to the central core.

$x_1, \dots, x_p \in X$ on ω with $x_1 = -x$ and $x_p = x$ such that for any point $\omega(t)$ on the geodesic ω , the intersection $B(\omega(t); \frac{\varepsilon}{2}) \cap X$ is equal to either $\{x_i\}$ for some $1 \leq i \leq p$ or to $\{x_i, x_{i+1}\}$ for some $1 \leq i \leq p-1$. We further assume that $-x_i \in X$ for all $1 \leq i \leq p$. Let $\frac{1}{2} = t_1 < t_2 < \dots < t_p = 1$ be such that $\gamma(t_i) = \delta_{x_i}$. Then a reparametrized loop $(\phi \circ \gamma)(t)$ in $\text{TAVR}^m(X; r)$ has the following form:

$$(\phi \circ \gamma)(t) = \begin{cases} (1-2t)\delta_x + 2t\delta_{-x} & 0 \leq t \leq \frac{1}{2} \\ \frac{t_{i+1}-t}{t_{i+1}-t_i}\delta_{x_i} + \frac{t-t_i}{t_{i+1}-t_i}\delta_{x_{i+1}} & t_i \leq t \leq t_{i+1} \text{ for } 1 \leq i \leq p-1. \end{cases}$$

After applying f , we get that the loop $f \circ \phi \circ \gamma$ in $\text{TAVR}^m(S^n; \alpha)$ has the following form:

$$(f \circ \phi \circ \gamma)(t) = \begin{cases} (1-2t)\delta_{f(x)} + 2t\delta_{f(-x)} & 0 \leq t \leq \frac{1}{2} \\ \frac{t_{i+1}-t}{t_{i+1}-t_i}\delta_{f(x_i)} + \frac{t-t_i}{t_{i+1}-t_i}\delta_{f(x_{i+1})} & t_i \leq t \leq t_{i+1} \text{ for } 1 \leq i \leq p-1. \end{cases}$$

Note that $d(x_i, x_{i+1}) < \varepsilon < \pi - r$ and $d(-x_i, x_i) = \pi$. Thus $d(-x_i, x_{i+1}) > r$. Hence

$$d(f(-x_i), f(x_{i+1})) \geq \alpha, \quad (3)$$

since f is a graph homomorphism from $\text{Bor}(S^k; r)$ to $\text{Bor}(S^n; \alpha)$. Also, $d(-x_i, x_i) = \pi > r$, thus

$$d(f(-x_i), f(x_i)) \geq \alpha. \quad (4)$$

From (3) and (4), we conclude there exists a measure in $\text{TAVR}^m(S^n; \alpha)$ with non-zero weight on all three of $f(x_i)$, $f(x_{i+1})$, $f(-x_i)$, with $f(x_i)$ and $f(x_{i+1})$ in one cluster and $f(-x_i)$ in the other cluster.

Let $\omega_i: [t_i, t_{i+1}] \rightarrow S^n$ be the geodesic from $f(x_i)$ to $f(x_{i+1})$ for $1 \leq i \leq p-1$. The map $\rho: \text{TAVR}^m(S^n; \alpha) \rightarrow \text{AVR}^m(S^n; \alpha)$ in Proposition 8.3 maps the line joining $\delta_{f(x_i)}$ and $\delta_{f(x_{i+1})}$, (i.e., measures of the form $c\delta_{f(x_i)} + (1-c)\delta_{f(x_{i+1})}$) to Dirac delta measures $\delta_{\omega_i(t)}$ on the geodesic ω_i .

Thus after applying ρ , we get a loop in $\text{AVR}^m(S^n; \alpha)$ as follows:

$$(\rho \circ f \circ \phi \circ \gamma)(t) = \begin{cases} (1-2t)\delta_{f(x)} + 2t\delta_{f(-x)} & 0 \leq t \leq \frac{1}{2} \\ \delta_{\omega_i(t)} & t_i \leq t \leq t_{i+1} \text{ for } 1 \leq i \leq p-1. \end{cases}$$

Once again, after applying the flashlight homotopy h_1 , we get the following loop in $\text{AVR}^m(S^n; \pi)$:

$$(h_1 \circ \rho \circ f \circ \phi \circ \gamma)(t) = \begin{cases} \delta_{\omega_{f(x),y}(t)} & 0 \leq t \leq t_* \\ \frac{1}{1/2-2t_*}[(t-t_*)\delta_{-y} + (1/2-t_*-t)\delta_y] & t_* \leq t \leq \frac{1}{2} - t_* \\ \delta_{\omega_{-y,f(-x)}(t)} & \frac{1}{2} - t_* \leq t \leq \frac{1}{2} \\ \delta_{\omega_i(t)} & t_i \leq t \leq t_{i+1} \text{ for } 1 \leq i \leq p-1. \end{cases}$$

Then we apply the projection to the central core map to get a loop γ' in \mathbb{RP}^n as follows:

$$\gamma'(t) = \begin{cases} \{\pm\omega_{f(x),y}(t)\} & 0 \leq t \leq t_* \\ \{\pm y\} & t_* \leq t \leq \frac{1}{2} - t_* \\ \{\pm\omega_{-y,f(-x)}(t)\} & \frac{1}{2} - t_* \leq t \leq \frac{1}{2} \\ \{\pm\omega_i(t)\} & t_i \leq t \leq t_{i+1} \text{ for } 1 \leq i \leq p-1. \end{cases}$$

As before, γ' can be reparametrized $\gamma': [t_*, 1+t_*] \rightarrow \mathbb{RP}^n$ so that it starts and ends at $\{\pm y\}$. When we lift γ' to S^n we get the path $\tilde{\gamma}: [t_*, 1+t_*] \rightarrow S^n$ which has the following form:

$$\tilde{\gamma}(t) = \begin{cases} -y & t_* \leq t \leq \frac{1}{2} - t_* \\ \omega_{-y,f(-x)}(t) & \frac{1}{2} - t_* \leq t \leq \frac{1}{2} \\ \omega_i(t) & t_i \leq t \leq t_{i+1} \text{ for } 1 \leq i \leq p-1 \\ \omega_{f(x),y}(t) & t_* \leq t \leq 1+t_*. \end{cases}$$

This lift is a path in S^n from $-y$ to y , depicted as the green path in Figure 7(bottom left). (The red path is the other lift of $\tilde{\gamma}$.) This once again proves that f induces a continuous map $\mathbb{RP}^k \rightarrow \mathbb{RP}^n$, which is non-trivial on π_1 , contradicting Lemma 10.1. Hence for $k > n$ and $r < \pi$, there is no graph homomorphism $f: \text{Bor}(S^k; r) \rightarrow \text{Bor}(S^n; \alpha)$ when $\alpha > \frac{2\pi}{3}$. \square

11. CONCLUSION AND OPEN QUESTIONS

In this paper, we introduce and study anti-Vietoris–Rips metric thickenings, which are related to the previously studied anti-Vietoris–Rips simplicial complexes [45, 60, 61, 83]. However, since anti-Vietoris–Rips complexes of bounded manifolds are finite-dimensional, whereas Vietoris–Rips complexes of bounded manifolds are infinite dimensional, the relationship between anti-Vietoris–Rips complexes and metric thickenings has a different flavor than the relationship between Vietoris–Rips complexes and metric thickenings. We have identified the first homotopy types of the anti-Vietoris–Rips metric thickenings of the n -sphere for all n , and we bound the covering dimension of anti-Vietoris–Rips metric thickenings of manifolds.

We end with a list of open questions.

Question 11.1. Can we identify a set $C \subsetneq [0, \pi]$ of potential *critical* scale parameters satisfying the “first Morse lemma” property that if $(s, s') \cap C = \emptyset$ for $s < s'$, then the inclusion $\text{AVR}^m(S^n; r') \hookrightarrow \text{AVR}^m(S^n; r)$ is a homotopy equivalence for all $s < r \leq r' < s'$?

Question 11.2. Define $r_k = \arccos(-\frac{1}{k+1})$ to be the diameter of the inscribed regular $(k+1)$ -simplex in S^k . Recall that $r_1 = \frac{2\pi}{3}$. Does the homotopy type of $\text{AVR}^m(S^n; r)$ change as r passes through the scales $\pi > r_1 > r_2 > \dots > r_{n-1} > r_n$?

Question 11.3. What is $\text{conn}(\text{AVR}^m(S^n; r))$ for $0 < r < \frac{2\pi}{3}$? Here $\text{conn}(Y)$ is the largest dimension k such that the homotopy groups $\pi_i(Y)$ are trivial for $i \leq k$. Is $\text{conn}(\text{AVR}^m(S^n; r))$ a non-increasing function of $r > 0$?

See Theorem 3.13 and Proposition 4.3 of [45] for a related result.

Question 11.4. Can we show that $\text{AVR}^m(S^n; r)$ is not contractible for $r > 0$?

One way to do this would be by giving an upper bound on $\text{conn}(\text{AVR}^m(S^n; r))$. Indeed, if $\text{conn}(Y) \leq k$, then $\pi_i(Y)$ is nontrivial for some $i \geq k+1$, and hence Y is not contractible. We note that the equivariant techniques of [6, Theorem 3] cannot immediately be applied, since the natural action of $\mathbb{Z}/2$ on $\text{AVR}^m(S^n; r)$ is not free for $r \leq \pi$ (due to fixed points of the form $\frac{1}{2}\delta_x + \frac{1}{2}\delta_{-x}$.)

Question 11.5. What is $\text{hdim}(\text{AVR}^m(S^n; r))$ for $0 < r < \frac{2\pi}{3}$? Here, for a topological space Y , $\text{hdim}(Y)$ is the largest dimension k in which the homology group $H_k(Y)$ is nonzero. Is $\text{hdim}(\text{AVR}^m(S^n; r))$ a non-increasing function of $r > 0$?

Question 11.6. Is $\text{AVR}^m(S^n; \frac{2\pi}{3})$ homotopy equivalent to a $(2n+1)$ -dimensional CW complex? See Theorem 7.1.

Question 11.7. Assuming so, can we use cellular homology to determine the homology groups of $\text{AVR}^m(S^n; \frac{2\pi}{3})$?

Question 11.8. For M a compact manifold, when is $\text{AVR}^m(M; r)$ a CW complex?

Question 11.9. Given $k > n$ and a fixed $r < \pi$, what is the largest value of α such that a graph homomorphism $\text{Bor}(S^k; r) \rightarrow \text{Bor}(S^n; \alpha)$ exists?

In Theorem 10.3, we showed that for all $k > n$ and $r < \pi$, there is no graph homomorphism $\text{Bor}(S^k; r) \rightarrow \text{Bor}(S^n; \alpha)$ when $\alpha > \frac{2\pi}{3}$. But this bound on α does not depend on k or n , and it does not decrease as $k-n$ grows, as we would expect it to.

Question 11.10. What are the chromatic numbers of the Borsuk graphs $\text{Bor}(S^n; \alpha)$ and $G(S^n; \alpha)$ the scale parameter α decreases? We remind the reader that for α sufficiently close to π , the chromatic number of $\text{Bor}(S^n; \alpha)$ is equal to $n+2$ [67, 66, 78, 79, 66, 85]. Some asymptotics for the chromatic number of $\text{Bor}(S^n; \alpha)$ as the scale α decreases towards zero are given in [74], but we are also interested in exact values.

Question 11.11. In light of the relationship between the circular chromatic number and the usual chromatic number (Lemma 9.4), is there a useful definition of an n -th *spherical* chromatic number based graph homomorphisms into $\text{Bor}(S^n; \alpha)$? Relating such a spherical chromatic number to the usual chromatic number will require a better understanding of the chromatic numbers of $\text{Bor}(S^n; \alpha)$ as α varies, as in the previous question.

ACKNOWLEDGEMENTS

We would like to thank Chris Peterson for interesting conversations related to Question 11.11.

REFERENCES

- [1] Fred M Abdelmalek, Priyavrat Deshpande, Shuchita Goyal, Amit Roy, and Anurag Singh. Chordal graphs, higher independence and vertex decomposable complexes. *International Journal of Algebra and Computation*, 33(03):481–498, 2023.
- [2] Michał Adamaszek and Henry Adams. The Vietoris–Rips complexes of a circle. *Pacific Journal of Mathematics*, 290:1–40, 2017.
- [3] Michał Adamaszek, Henry Adams, and Florian Frick. Metric reconstruction via optimal transport. *SIAM Journal on Applied Algebra and Geometry*, 2(4):597–619, 2018.
- [4] Henry Adams, Manuchehr Aminian, Elin Farnell, Michael Kirby, Joshua Mirth, Rachel Neville, Chris Peterson, and Clayton Shonkwiler. A fractal dimension for measures via persistent homology. In Nils A. Baas, Gunnar E. Carlsson, Gereon Quick, Markus Szymik, and Marius Thauale, editors, *Topological Data Analysis*, pages 1–31. Springer, 2020.
- [5] Henry Adams, Mark Blumstein, and Lara Kassab. Multidimensional scaling on metric measure spaces. *Rocky Mountain Journal of Mathematics*, 50:397–413, 2020.
- [6] Henry Adams, Johnathan Bush, and Florian Frick. The topology of projective codes and the distribution of zeros of odd maps. *Accepted to appear in Michigan Mathematical Journal*, 2022.
- [7] Henry Adams, Sofya Chepushtanova, Tegan Emerson, Eric Hanson, Michael Kirby, Francis Motta, Rachel Neville, Chris Peterson, Patrick Shipman, and Lori Ziegelmeier. Persistence images: A vector representation of persistent homology. *Journal of Machine Learning Research*, 18(8):1–35, 2017.
- [8] Henry Adams, Florian Frick, and Žiga Virk. Vietoris thickenings and complexes have isomorphic homotopy groups. *Journal of Applied and Computational Topology*, 7(2):221–241, 2023.
- [9] Henry Adams, Ekansh Jauhari, and Sucharita Mallick. Homotopy connectivity of Čech complexes of spheres. *arXiv preprint arXiv:2502.00122*, 2025.
- [10] Henry Adams, Evgeniya Lagoda, Michael Moy, Nikola Sadovek, and Aditya De Saha. Persistent equivariant cohomology. *arXiv preprint arXiv:2408.17331*, 2024.
- [11] Henry Adams, Facundo Mémoli, Michael Moy, and Qingsong Wang. The persistent topology of optimal transport based metric thickenings. *Algebraic & Geometric Topology*, 4:393–447, 2024.
- [12] Henry Adams and Michael Moy. Topology applied to machine learning: From global to local. *Frontiers in Artificial Intelligence*, 4:668302, 2021.
- [13] Hannah Alpert, Matthew Kahle, and Robert MacPherson. Configuration spaces of disks in an infinite strip. *Journal of Applied and Computational Topology*, 5(3):357–390, 2021.
- [14] Eric Babson, Hélène Barcelo, Mark de Longueville, and Reinhard Laubenbacher. A homotopy theory for graphs. *arXiv preprint math/0403146*, 2004.
- [15] Hélène Barcelo, Valerio Capraro, and Jacob A. White. Discrete homology theory for metric spaces. *Bulletin of the London Mathematical Society*, 46(5):889–905, 2014.
- [16] Hélène Barcelo, Xenia Kramer, Reinhard Laubenbacher, and Christopher Weaver. Foundations of a connectivity theory for simplicial complexes. *Advances in Applied Mathematics*, 26(2):97–128, 2001.
- [17] Jonathan A Barmak. Star clusters in independence complexes of graphs. *Advances in Mathematics*, 241:33–57, 2013.
- [18] Yuliy Baryshnikov, Peter Bubenik, and Matthew Kahle. Min-type Morse theory for configuration spaces of hard spheres. *International Mathematics Research Notices*, 2014(9):2577–2592, 2014.
- [19] VN Basmanov. Covariant functors, retracts, and dimension. In *Doklady Akademii Nauk*, volume 271, pages 1033–1036. Russian Academy of Sciences, 1983.

- [20] Paul Bendich, James S Marron, Ezra Miller, Alex Pieloch, and Sean Skwerer. Persistent homology analysis of brain artery trees. *The annals of applied statistics*, 10(1):198, 2016.
- [21] Marko Berghoff. On the homology of independence complexes. *arXiv preprint arXiv:2008.06267*, 2020.
- [22] JM Bibby, JT Kent, and KV Mardia. *Multivariate analysis*. Academic Press, London, 1979.
- [23] Vladimir I. Bogachev. *Weak convergence of measures*. American Mathematical Society Providence, RI, 2018.
- [24] Mireille Bousquet-Mélou, Svante Linusson, and Eran Nevo. On the independence complex of square grids. *J. Algebraic Combin.*, 27(4):423–450, 2008.
- [25] Martin R Bridson and André Haefliger. *Metric spaces of non-positive curvature*, volume 319. Springer Science & Business Media, 2011.
- [26] Peter Bubenik. Statistical topological data analysis using persistence landscapes. *The Journal of Machine Learning Research*, 16(1):77–102, 2015.
- [27] Peter Bubenik, Michael Hull, Dhruv Patel, and Benjamin Whittle. Persistent homology detects curvature. *Inverse Problems*, 36(2):025008, 2020.
- [28] Peter Bubenik and Nikola Milićević. Homotopy, homology and persistent homology using Čech’s closure spaces. *arXiv preprint arXiv:2104.10206*, 2021.
- [29] Luis A Caffarelli and Robert J McCann. Free boundaries in optimal transport and Monge-Ampere obstacle problems. *Annals of mathematics*, pages 673–730, 2010.
- [30] Gunnar Carlsson. Topology and data. *Bulletin of the American Mathematical Society*, 46(2):255–308, 2009.
- [31] Gunnar Carlsson, Jackson Gorham, Matthew Kahle, and Jeremy Mason. Computational topology for configuration spaces of hard disks. *Physical Review E*, 85(1):011303, 2012.
- [32] Daniel Carranza and Chris Kapulkin. Cubical setting for discrete homotopy theory, revisited. *arXiv preprint arXiv:2202.03516*, 2022.
- [33] Frédéric Chazal, David Cohen-Steiner, Leonidas J Guibas, Facundo Mémoli, and Steve Y Oudot. Gromov–Hausdorff stable signatures for shapes using persistence. In *Computer Graphics Forum*, volume 28, pages 1393–1403, 2009.
- [34] Frédéric Chazal, Vin de Silva, and Steve Oudot. Persistence stability for geometric complexes. *Geom. Dedicata*, 173:193–214, 2014.
- [35] Frédéric Chazal and Steve Oudot. Towards persistence-based reconstruction in Euclidean spaces. In *Proceedings of the 24th Symposium on Computational Geometry*, pages 232–241. ACM, 2008.
- [36] Trevor F Cox and Michael AA Cox. *Multidimensional scaling*. CRC press, 2000.
- [37] Péter Csorba. Homotopy types of box complexes. *Combinatorica*, 27(6):669–682, 2007.
- [38] Enrico De Santis, Alessio Martino, and Antonello Rizzi. On component-wise dissimilarity measures and metric properties in pattern recognition. *PeerJ Computer Science*, 8:e1106, 2022.
- [39] Priyavrat Deshpande, Samir Shukla, and Anurag Singh. Distance r -domination number and r -independence complexes of graphs. *European Journal of Combinatorics*, 102:103508, 2022.
- [40] Anton Dochtermann. Hom complexes and homotopy theory in the category of graphs. *European Journal of Combinatorics*, 30(2):490–509, 2009.
- [41] Clifford H Dowker. Topology of metric complexes. *American Journal of Mathematics*, 74(3):555–577, 1952.
- [42] Alexander N. Dranishnikov. Dimension of compact metric spaces. *Indagationes Mathematicae*, 29(1):429–449, 2018.
- [43] Richard Ehrenborg and Gábor Hetyei. The topology of the independence complex. *European Journal of Combinatorics*, 27(6):906–923, 2006.
- [44] Alexander Engström. Independence complexes of claw-free graphs. *European Journal of Combinatorics*, 29(1):234–241, 2008.
- [45] Alexander Engström. Complexes of directed trees and independence complexes. *Discrete Mathematics*, 309(10):3299–3309, 2009.
- [46] P Erdős and RL Graham. Problem proposed at the 6th hungarian combinatorial conference. *Eger, July*, 1981.
- [47] Vitalii V Fedorchuk. Probability measures in topology. *Russian Mathematical Surveys*, 46(1):45, 1991.

- [48] Alessio Figalli. The optimal partial transport problem. *Archive for rational mechanics and analysis*, 195(2):533–560, 2010.
- [49] Rudolf Fritsch and Renzo Piccinini. Cambridge Studies in Advanced Mathematics. Cambridge University Press, 1990.
- [50] Alison L. Gibbs and Francis E. Su. On choosing and bounding probability metrics. *International statistical review*, 70(3):419–435, 2002.
- [51] Patrick Gillespie. A homological nerve theorem for open covers. *arXiv preprint arXiv:2210.00388*, 2022.
- [52] Patrick Gillespie. Vietoris thickenings and complexes are weakly homotopy equivalent. *Journal of Applied and Computational Topology*, 8(1):35–53, 2024.
- [53] PJ Groenen and Ingwer Borg. Past, present, and future of multidimensional scaling. *Visualization and verbalization of data*, pages 95–117, 2014.
- [54] M. Gromov. Hyperbolic groups. In *Essays in group theory*, volume 8 of *Math. Sci. Res. Inst. Publ.*, pages 75–263. Springer, New York, 1987.
- [55] Mikhaïl Gromov. Geometric group theory, volume 2: Asymptotic invariants of infinite groups. *London Mathematical Society Lecture Notes*, 182:1–295, 1993.
- [56] Allen Hatcher. *Algebraic Topology*. Cambridge University Press, Cambridge, 2002.
- [57] Jean-Claude Hausmann. On the Vietoris–Rips complexes and a cohomology theory for metric spaces. In *Prospects in topology (Princeton, NJ, 1994)*, volume 138 of *Ann. of Math. Stud.*, pages 175–188. Princeton Univ. Press, Princeton, NJ, 1995.
- [58] Pavol Hell and Jaroslav Nešetřil. *Graphs and Homomorphisms*. Oxford University Press, 2004.
- [59] Yasuaki Hiraoka, Takenobu Nakamura, Akihiko Hirata, Emerson G Escobar, Kaname Matsue, and Yasumasa Nishiura. Hierarchical structures of amorphous solids characterized by persistent homology. *Proceedings of the National Academy of Sciences*, 113(26):7035–7040, 2016.
- [60] Brett Jefferson. A fun intro to the anti-Rips complex. <https://youtu.be/cz3kWX6ZChY>, 2021. AATRN Tutorial-a-thon.
- [61] Brett A. Jefferson. Survey of antihomology research. 9 2017.
- [62] Matthew Kahle and Francisco Martinez-Figueroa. The chromatic number of random Borsuk graphs. *Random Structures & Algorithms*, 56(3):838–850, 2020.
- [63] Dmitry N Kozlov. *Combinatorial Algebraic Topology*, volume 21 of *Algorithms and Computation in Mathematics*. Springer, 2008.
- [64] Janko Latschev. Vietoris–Rips complexes of metric spaces near a closed Riemannian manifold. *Archiv der Mathematik*, 77(6):522–528, 2001.
- [65] John M Lee. *Introduction to Smooth Manifolds*. Springer, 2013.
- [66] László Lovász. Self-dual polytopes and the chromatic number of distance graphs on the sphere. *Acta Scientiarum Mathematicarum*, 45(1-4):317–323, 1983.
- [67] László Lovász. Kneser’s conjecture, chromatic number, and homotopy. *Journal of Combinatorial Theory, Series A*, 25(3):319–324, 1978.
- [68] Robert MacPherson and Benjamin Schweinhart. Measuring shape with topology. *Journal of Mathematical Physics*, 53(7):073516, 2012.
- [69] Jiří Matoušek. *Using the Borsuk–Ulam theorem*. Springer Science & Business Media, 2008.
- [70] Takahiro Matsushita and Shun Wakatsuki. Dominance complexes, neighborhood complexes and combinatorial Alexander duals. *Journal of Combinatorial Theory, Series A*, 211:105978, 2025.
- [71] John Willard Milnor. *Morse Theory*. Number 51 in Annals of Mathematics Studies. Princeton University Press, 1963.
- [72] Michael Moy. Persistence stability for metric thickenings. Master’s thesis, Colorado State University, 2021.
- [73] Michael Moy. Vietoris–Rips metric thickenings of the circle. *Journal of Applied and Computational Topology*, 7(4):831–877, 2023.
- [74] Michael Moy. *Persistence and simplicial metric thickenings*. PhD thesis, Colorado State University, 2024.

- [75] James R. Munkres. *Topology: a first course*. Prentice-Hall, Inc., Englewood Cliffs, NJ, 1975.
- [76] Takenobu Nakamura, Yasuaki Hiraoka, Akihiko Hirata, Emerson G Escolar, and Yasumasa Nishiura. Persistent homology and many-body atomic structure for medium-range order in the glass. *Nanotechnology*, 26(30):304001, 2015.
- [77] Roman Prosanov. Chromatic numbers of spheres. *Discrete Mathematics*, 341(11):3123–3133, 2018.
- [78] AM Raigorodskii. On the chromatic numbers of spheres in Euclidean spaces. In *Doklady Mathematics*, volume 81, pages 379–382. Springer, 2010.
- [79] Andrei M Raigorodskii. On the chromatic numbers of spheres in \mathbb{R}^n . *Combinatorica*, 32(1):111–123, 2012.
- [80] Antonio Rieser. Vietoris–Rips homology theory for semi-uniform spaces. *arXiv preprint arXiv:2008.05739*, 2020.
- [81] Antonio Rieser. Čech closure spaces: A unified framework for discrete and continuous homotopy. *Topology and its Applications*, 296:107613, 2021.
- [82] Vanessa Robins. *Computational topology at multiple resolutions: Foundations and applications to fractals and dynamics*. PhD thesis, University of Colorado, 2000.
- [83] Jerome Roehm. *Reconstruction of stimulus spaces from neural activation sequences and anti-geometric persistence*. PhD thesis, University of Delaware, 2023.
- [84] Maya Sankar. Homotopy and the homomorphism threshold of odd cycles. *arXiv preprint arXiv:2206.07525*, 2022.
- [85] L. A. Santaló. Convex regions on the n -dimensional spherical surface. *Ann. of Math. (2)*, 47:448–459, 1946.
- [86] Benjamin Schweinhart. Persistent homology and the upper box dimension. *Discrete & Computational Geometry*, pages 1–34, 2019.
- [87] Benjamin Schweinhart. Fractal dimension and the persistent homology of random geometric complexes. *Advances in Mathematics*, 372:107291, 2020.
- [88] Shana. Prove that any continuous map $f: \mathbb{R}P^n \rightarrow \mathbb{R}P^m$, $m < n$, induces trivial homomorphism between fundamental groups. Mathematics Stack Exchange. <https://math.stackexchange.com/q/3669362>.
- [89] Edwin H Spanier. *Algebraic topology*. Springer Science & Business Media, 1989.
- [90] Anatoly Moiseevich Vershik. Long history of the Monge–Kantorovich transportation problem. *The Mathematical Intelligencer*, 35(4):1–9, 2013.
- [91] L. Vietoris. Über den höheren Zusammenhang kompakter Räume und eine Klasse von zusammenhangstreuen Abbildungen. *Math. Ann.*, 97(1):454–472, 1927.
- [92] C. Villani. *Topics in Optimal Transportation*. Graduate studies in mathematics. American Mathematical Society, 2003.
- [93] Cédric Villani. *Optimal transport*, volume 338 of *Grundlehren der mathematischen Wissenschaften [Fundamental Principles of Mathematical Sciences]*. Springer-Verlag, Berlin, 2009. Old and new.
- [94] Xuding Zhu. Circular chromatic number: a survey. *Discrete Mathematics*, 229(1):371–410, 2001.

APPENDIX A. PROOF OF LEMMA 3.1

We give the proof of Lemma 3.1.

Proof of Lemma 3.1. Let σ_1 and σ_2 be the marginals of σ , i.e., $\sigma_1(E) := \sigma(E \times X)$ and $\sigma_2(E) := \sigma(X \times E)$ for every Borel set $E \subseteq X$. Thus

$$\text{mass}(\sigma) = \int_{X \times X} d\sigma = \sigma(X \times X) = \sigma_1(X) = \sigma_2(X).$$

Note that for any Borel set $E \subseteq X$, we have $\sigma_1(E) \leq \mu(E)$ and $\sigma_2(E) \leq \nu(E)$. Hence $\mu - \sigma_1$ and $\nu - \sigma_2$ are Radon measures on X . Define a (full) transport plan between μ and ν via $\tilde{\sigma} = \sigma + \frac{1}{1 - \text{mass}(\sigma)}(\mu - \sigma_1) \times (\nu - \sigma_2) \in \mathcal{P}(X \times X)$. For any Borel set $\tilde{E} \subseteq X \times X$ we have $\sigma(\tilde{E}) \leq \tilde{\sigma}(\tilde{E})$,

and thus $\tilde{\sigma}$ is an extension of σ . Furthermore

$$\begin{aligned}
\text{mass}(\tilde{\sigma}) &= \text{mass}(\sigma) + \frac{1}{1-\text{mass}(\sigma)} \int_{X \times X} d((\mu - \sigma_1) \times (\nu - \sigma_2)) \\
&= \text{mass}(\sigma) + \frac{1}{1-\text{mass}(\sigma)} (\mu - \sigma_1)(X) \cdot (\nu - \sigma_2)(X) \\
&= \text{mass}(\sigma) + \frac{1}{1-\text{mass}(\sigma)} (\mu(X) - \sigma_1(X)) \cdot (\nu(X) - \sigma_2(X)) \\
&= \text{mass}(\sigma) + \frac{1}{1-\text{mass}(\sigma)} (1 - \text{mass}(\sigma)) \cdot (1 - \text{mass}(\sigma)) \\
&= \text{mass}(\sigma) + (1 - \text{mass}(\sigma)) = 1.
\end{aligned}$$

Also, for any Borel set $E \subseteq X$,

$$\begin{aligned}
\tilde{\sigma}(E \times X) &= \sigma(E \times X) + \frac{1}{1-\text{mass}(\sigma)} [(\mu - \sigma_1) \times (\nu - \sigma_2)](E \times X) \\
&= \sigma_1(E) + \frac{1}{1-\text{mass}(\sigma)} (\mu - \sigma_1)(E) \cdot (\nu - \sigma_2)(X) \\
&= \sigma_1(E) + \frac{1}{1-\text{mass}(\sigma)} (\mu(E) - \sigma_1(E)) \cdot (1 - \text{mass}(\sigma)) \\
&= \sigma_1(E) + \mu(E) - \sigma_1(E) = \mu(E).
\end{aligned}$$

Similarly, for any Borel set $E \subseteq X$, we have $\tilde{\sigma}(X \times E) = \nu(E)$. Hence, $\tilde{\sigma}$ is a transport plan between μ and ν . Finally,

$$\begin{aligned}
\text{cost}(\tilde{\sigma}) &= \text{cost}\left(\sigma + \frac{1}{1-\text{mass}(\sigma)} (\mu - \sigma_1) \times (\nu - \sigma_2)\right) \\
&= \text{cost}(\sigma) + \frac{1}{1-\text{mass}(\sigma)} \text{cost}((\mu - \sigma_1) \times (\nu - \sigma_2))
\end{aligned}$$

with

$$\begin{aligned}
\text{cost}((\mu - \sigma_1) \times (\nu - \sigma_2)) &= \int_{X \times X} d(x, y) d((\mu - \sigma_1) \times (\nu - \sigma_2)) \\
&\leq \int_{X \times X} \text{diam}(X) d((\mu - \sigma_1) \times (\nu - \sigma_2)) \\
&= \text{diam}(X) \int_{X \times X} d((\mu - \sigma_1) \times (\nu - \sigma_2)) \\
&= \text{diam}(X) (\mu - \sigma_1)(X) \cdot (\nu - \sigma_2)(X) \\
&= \text{diam}(X) (\mu(X) - \sigma_1(X)) \cdot (\nu(X) - \sigma_2(X)) \\
&= \text{diam}(X) (1 - \text{mass}(\sigma)) \cdot (1 - \text{mass}(\sigma)) \\
&= \text{diam}(X) (1 - \text{mass}(\sigma))^2.
\end{aligned}$$

Hence,

$$\text{cost}(\tilde{\sigma}) \leq \text{cost}(\sigma) + \frac{1}{1-\text{mass}(\sigma)} \text{diam}(X) (1 - \text{mass}(\sigma))^2 = \text{cost}(\sigma) + (1 - \text{mass}(\sigma)) \text{diam}(X). \quad \square$$

APPENDIX B. GENERALIZATION OF LEMMA 4.5

Here we relax the assumptions in Lemma 4.5 and give a proof in terms of matchings.

Lemma B.1. *Let X, Y be metric spaces, and let K, L be simplicial complexes with vertex sets $V(K) = X, V(L) = Y$. Let $f: X \rightarrow Y$ be a map of metric spaces such that the induced map*

$\tilde{f}: K^m \rightarrow L^m$ on metric thickenings exists. If f is continuous and if the image of f has finite diameter, then \tilde{f} is continuous.

Proof. Since the image of f has bounded diameter, let C be such that $d_Y(f(x), f(x')) \leq C$ for all $x, x' \in X$. Fix a point $\sum \lambda_i \delta_{x_i} \in K^m$ and fix $\varepsilon > 0$. Using the continuity of f at the finitely many points x_1, \dots, x_n , choose $\nu > 0$ so that if $x' \in X$ satisfies $d_X(x_i, x') \leq \nu$ for any i , then $d_Y(f(x_i), f(x')) \leq \frac{\varepsilon}{2}$. Reducing ν if necessary, we can also assume $\nu \leq \frac{\varepsilon}{2C}$. We will show that $W_1(\sum \lambda_i \delta_{x_i}, \sum \lambda'_j \delta_{x'_j}) < \nu^2$ implies $W_1(\tilde{f}(\sum \lambda_i \delta_{x_i}), \tilde{f}(\sum \lambda'_j \delta_{x'_j})) \leq \varepsilon$, which proves the continuity of $\tilde{f}: K^m \rightarrow L^m$ at $\sum \lambda_i \delta_{x_i}$.

Let $\pi_{i,j}$ be a matching from $\sum \lambda_i \delta_{x_i}$ to $\sum \lambda'_j \delta_{x'_j}$ with $\sum_{i,j} \pi_{i,j} d_X(x_i, x'_j) \leq \nu^2$. Let $A = \{(i, j) \mid d_X(x_i, x'_j) \geq \nu\}$ and $B = \{(i, j) \mid d_X(x_i, x'_j) < \nu\}$. We have

$$\nu \sum_A \pi_{i,j} \leq \sum_A \pi_{i,j} d(x_i, x'_j) \leq \sum_{i,j} \pi_{i,j} d(x_i, x'_j) \leq \nu^2,$$

so $\sum_A \pi_{i,j} \leq \nu$. Hence

$$\begin{aligned} W_1(\tilde{f}(\sum \lambda_i \delta_{x_i}), \tilde{f}(\sum \lambda'_j \delta_{x'_j})) &= W_1\left(\sum_i \lambda_i \delta_{f(x_i)}, \sum_j \lambda'_j \delta_{f(x'_j)}\right) = W_1\left(\sum_{i,j} \pi_{i,j} \delta_{f(x_i)}, \sum_{i,j} \pi_{i,j} \delta_{f(x'_j)}\right) \\ &\leq \sum_{i,j} \pi_{i,j} d_Y(f(x_i), f(x'_j)) \\ &= \sum_A \pi_{i,j} d_Y(f(x_i), f(x'_j)) + \sum_B \pi_{i,j} d_Y(f(x_i), f(x'_j)) \\ &\leq C \sum_A \pi_{i,j} + \frac{\varepsilon}{2} \sum_B \pi_{i,j} \leq C\nu + \frac{\varepsilon}{2} \leq \varepsilon. \end{aligned} \quad \square$$

Email address: henry.adams@ufl.edu

Email address: alex.elchesen@colostate.edu

Email address: sucharitamallick@ufl.edu

Email address: michael.moy@colostate.edu