

INVERSE PROBLEMS RELATED TO ELECTRICAL NETWORKS AND THE GEOMETRY OF NON-NEGATIVE GRASSMANNIANS

A. A. KAZAKOV

ABSTRACT. In this paper we provide a new solution of the classical black box problem (the discrete Calderon problem) in the theory of circular electrical networks. Our approach is based on the explicit embedding of electrical networks into non-negative Grassmannians and generalized chamber ansatz for it. Additionally, we reveal the relationship of this problem with combinatorial properties of spanning groves and the theory of the totally non-negative matrices.

CONTENTS

1. Introduction and organization	1
2. Electrical network theory	2
3. The black box problem for electrical networks	4
4. From electrical networks to non-negative Grassmannians	5
4.1. The Postnikov theory	5
4.2. The Lam embedding and its parametrization	9
4.3. The solution of the black problem via the generalized chamber ansatz	11
4.4. Conductivity recovering via groves	18
5. Conductivities reconstruction via effective resistances	20
6. The black box problem as the Berenstein-Fomin-Zelevinsky problem	21
References	24

MSC2020: 05C10, 05C50, 05E10, 15M15, 34B45, 35R30, 82B20, 90C05, 90C59, 94C05, 94C15

Key words: electrical networks, discrete Calderon problem, discrete electrical impedance tomography, non-negative Grassmannians, twist for positroid variety, Temperley trick, totally non-negative matrices, effective resistances.

1. INTRODUCTION AND ORGANIZATION

An electrical network $\mathcal{E}(G, w)$ is a graph G equipped with positive edge weights w denoting conductivities, which nodes are divided into two sets: a set of inner nodes and a set of boundary nodes. Applying voltages $\mathbf{U} : V_B \rightarrow \mathbb{R}$ to the boundary nodes and using Ohm's and Kirchhoff's law, we determine an unique harmonic extension on all boundaries voltages $U : V \rightarrow \mathbb{R}$. Studying the properties of these harmonic extensions gives rise to electrical response matrices and effective resistances matrices. The relationship between their entries and spanning groves has enabled the construction, using the generalization Temperley trick, of the embedding of the set of electrical networks to the totally non-negative part of $Gr_{\geq 0}(n-1, 2n)$, see Sections 4.2 and 4.4. This embedding, which can be explicitly defined via response matrices (or effective resistances matrices), allows us to apply the Postnikov theory of non-negative Grassmannians to study electrical network theory, see Section 4.1. Based on this idea we propose, see Section 4.3, a

new algorithmic solution to the black box problem, that is the main result of our paper (note that a similar approach has been independently studied in [23]):

Proposition 1.1. *Consider a minimal electrical network $\mathcal{E}(G, w)$ and its associated point $\mathcal{L}(\mathcal{E})$ of non-negative Grassmannian $Gr_{\geq 0}(n-1, 2n)$, then the conductivity function w can be recovered by the Plucker coordinates of $\mathcal{L}(\mathcal{E})$.*

Unlike other existing methods, our solution is applicable for any network and has non-recursive nature, which we anticipate might lead to more numerical stable approaches to Calderon problem (see Sections 3) and some problems in phylogenetic network theory (see references in Section 4.4).

Finally, in Section 6 we reveal the principal relation of the black box problem to the classical theory of the totally non-negative matrices.

Acknowledgments. This work was supported by the Russian Science Foundation project No. 20-71-10110 (<https://rscf.ru/en/project/23-71-50012>) which finances the work of the author at P. G. Demidov Yaroslavl State University. The author is grateful to Vassily Gorbounov, Dmitry Talalaev, Sotiris Konstantinou-Rizos, and especially to Lazar Guterman for their invaluable discussions and assistance with the figures.

2. ELECTRICAL NETWORK THEORY

We start with a brief introduction into the theory of electrical networks following [8], [9] and [14].

Definition 2.1. An **electrical network** $\mathcal{E}(G, w)$ is essentially planar graph $G(V, E)$, embedded into a disk and equipped with a conductivity function $w : E(G) \rightarrow \mathbb{R}_{\geq 0}$, which satisfies the following conditions:

- All nodes are divided into the set of inner nodes V_I and the set of boundary nodes V_B and each boundary node lies on the boundary circle;
- Boundary nodes are enumerated clockwise from 1 to $|V_B| := n$. Inner nodes are enumerated arbitrarily from $n + 1$ to $|V|$;
- An edge weight $w(v_i v_j) = w_{ij}$ denotes the conductivity of this edge.

Consider an electrical network $\mathcal{E}(G, w)$ and apply voltages $\mathbf{U} : V_B \rightarrow \mathbb{R}$ to its boundary nodes V_B . Then these boundary voltages induce to the unique harmonic extension on all vertices $U : V \rightarrow \mathbb{R}$, which might be found out by the Ohm's and Kirchhoff's laws:

$$\sum_{j \in V} w_{ij} (U(i) - U(j)) = 0, \quad \forall i \in V_I.$$

One of the main objects associated with each harmonic extension of boundary voltages \mathbf{U} are boundary currents $\mathbf{I} = \{I_1, \dots, I_n\}$ running through boundary nodes:

$$I_k := \sum_{j \in V} w_{kj} (U(k) - U(j)), \quad k \in \{1, \dots, n\}.$$

The first cornerstone result in the theory of electrical networks is that boundary voltages and currents are related to each other linearly.

Theorem 2.2. [9] *Consider an electrical network $\mathcal{E}(G, w)$. Then, there is a matrix $M_R(\mathcal{E}) = (x_{ij}) \in Mat_{n \times n}(\mathbb{R})$ such that the following holds:*

$$M_R(\mathcal{E}) \mathbf{U} = \mathbf{I}.$$

*This matrix is called the **response matrix** of a network $\mathcal{E}(G, w)$ and it satisfies the following conditions:*

- Matrix $M_R(\mathcal{E})$ is symmetric;
- All non-diagonal entries x_{ij} of $M_R(\mathcal{E})$ are non-positive;
- For each row (column) sum of all its entries is equal to 0.
- Matrix $M_R(\mathcal{E})$ is circular totally-nonnegative i.e. for each $k \in \{1, \dots, n\}$ all $k \times k$ circular minors of $M_R(\mathcal{E})$ (see [9] and [14] for more details) are signed non-negative: $(-1)^k \det M_R(\mathcal{E})(P; Q) \geq 0$, for each circular pair $(P; Q)$.

The following five local network transformations given below are called the **electrical transformations**.

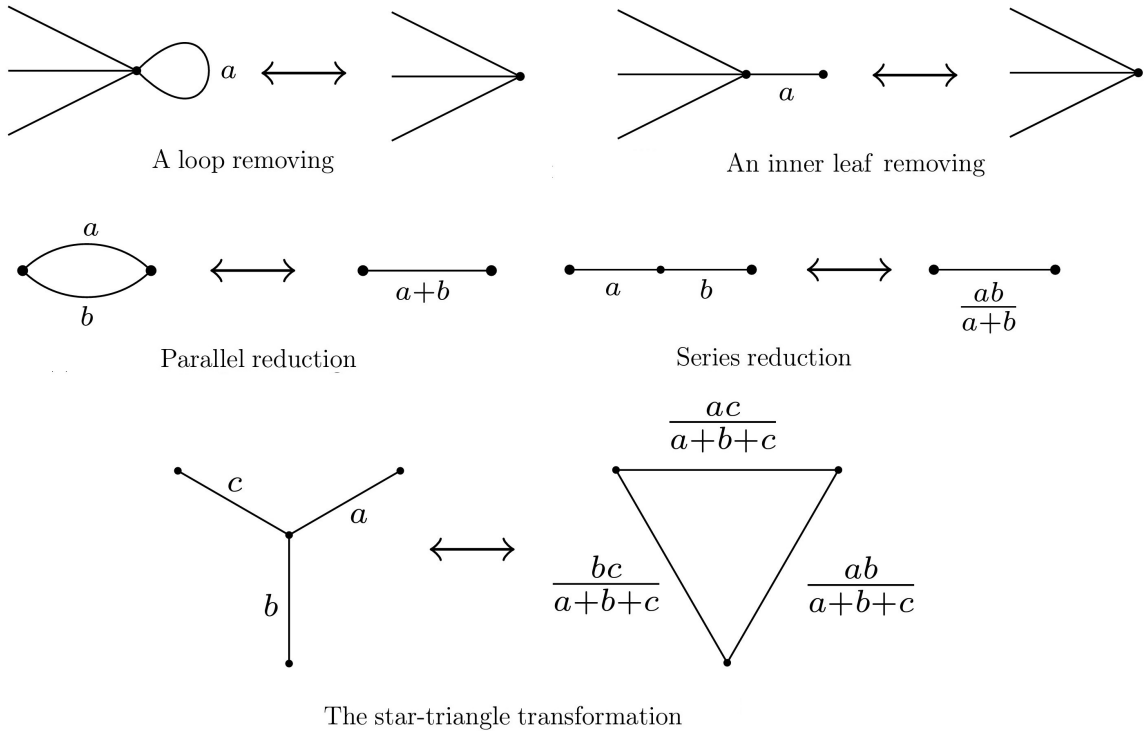

FIGURE 1. Electrical transformations

Two electrical networks are defined to be equivalent if they can be obtained from each other by a sequence of the electrical transformations. The importance of these transformations is revealed by the following result.

Theorem 2.3. [8] *The electrical transformations preserve the response matrix of an electrical network. Any two circular electrical networks which share the same response matrix are equivalent.*

According to Theorem 2.3 we will consider electrical networks up to electrical transformations. We will denote by E_n the set of all electrical networks with n boundary nodes up to electrical transformations. In fact, each electrical network can be transformed into a minimal network.

Definition 2.4. A **median graph** of an electrical network $\mathcal{E}(G, w)$ is a graph G_M whose internal vertices are the midpoints of the edges of G and two internal vertices are connected by an edge if the edges of the original graph G are adjacent. The boundary vertices of G_M are defined as the intersection of the natural extensions of the edges of G_M with the boundary circle. Since the interior vertices of the median graph have

degree four, we can define the **strands** of the median graph as the paths which always go straight through any degree four vertex.

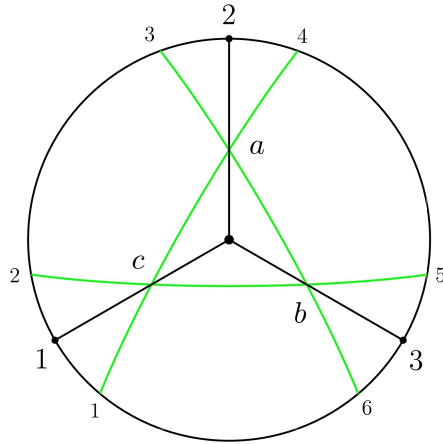

FIGURE 2. Star-shape network and its median graph

Definition 2.5. An electrical network is called **minimal** if the strands of its median graph do not have self-intersections; each strand does not form a closed loop; any two strands intersect at most once i.e. the median graph has no lenses, see Fig.3.

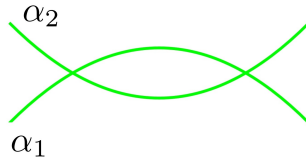

FIGURE 3. A lens obtained by the intersection of strands α_1 and α_2

Theorem 2.6. [9],[14]

- Each electrical network $\mathcal{E}(G, w) \in E_n$ is equivalent to a minimal network;
- Any two minimal electrical networks which share the same response matrix can be transformed to each other only by the star-triangle transformation.

3. THE BLACK BOX PROBLEM FOR ELECTRICAL NETWORKS

One of the most important and notorious difficult problem in electrical network theory, which has significantly influenced on the entire development of this field [9], is known as the **black box problem**.

Problem 3.1. Consider an electrical network $\mathcal{E}(G, w)$ on a given graph G . The conductivity function w is required to be recovered by a known response matrix $M_R(\mathcal{E})$;

Theorem 3.2. [8],[9] *The conductivity function w of a minimal electrical network $\mathcal{E}(G, w) \in E_n$ can be uniquely recovered by its response matrix $M_R(\mathcal{E})$.*

Note that all proofs of Theorem 3.2 are constructive and essentially present the practical algorithms for solving Problem 3.1. Let us underline a few of the main ones:

- The recursive spike-bridge-pendant decomposition [9];

- Solutions to Problem 3.1 for special (for instance, standard) electrical networks [9], [13];
- Reducing Problem 3.1 to the black box problem in the Postnikov theory. This approach we be described in Section 4 (also see [23]).

Problem 3.1 plays a central role in the theory of electrical networks due to its practical use in developing fast and stable numerical solutions of the well-known **Calderon problem** [24], [25]. Problem 3.1 can be considered as the discrete version [3] of a special case of the Calderon problem, which is called inverse problem of electrical impedance tomography in a circle.

Consider a conducting medium in a closed disk D i.e. a positive bounded function of conductivity $\sigma(x) : D \rightarrow \mathbb{R}_{>0}$ and an electric voltage $u(x) : D \rightarrow \mathbb{R}$, which are related to each other by the following second-order elliptic partial differential equation:

$$\operatorname{div}(\sigma(x)\nabla u(x)) = 0, \quad \forall x \in \operatorname{int} D,$$

with Dirichlet boundary data which is a known voltage $V : \partial D \rightarrow \mathbb{R}$ applied to the boundary of D :

$$u(x)|_{\partial D} = V(x), \quad \forall x \in \partial D.$$

The voltage $V(x)$ induces a Neumann boundary data, namely currents $I_V(x)$ running through ∂D : $\partial D \rightarrow \mathbb{R}$ induced by $V(x)$:

$$I_V(x) = (n, \sigma(x)\nabla u(x)|_{\partial D}),$$

where n is the unit vector of the outer normal to ∂D ; and (\cdot, \cdot) is the standard scalar product.

Suppose that for each boundary voltage $V(x)$ the corresponding induced boundary currents $I_V(x)$ are known. Formally, it means that the operator Λ^{DtN} from Dirichlet data to Neumann data is known:

$$\Lambda^{DtN} V(x) = I_V(x).$$

Problem 3.3. It is required to recover a conductivity function $\sigma(x)$ using a known operator Λ^{DtN} .

Omitting some important details, we briefly describe the idea of the numerical approach to Problem 3.3 following [3].

Algorithm 3.4. [3]

- Using the operator Λ^{DtN} , construct a matrix M , which is a response of the general position (well-connected, see [14]) minimal network $\mathcal{E}(G, w)$ on a given graph;
- Solve Problem 3.1 for \mathcal{E} ;
- Using the edge conductivities of \mathcal{E} numerically found out a conductivity $\sigma(x)$.

4. FROM ELECTRICAL NETWORKS TO NON-NEGATIVE GRASSMANIANS

4.1. The Postnikov theory. The main goal of this section to demonstrate that Problem 3.1 can be considered as a particular case of the black box problem in the Postnikov theory of non-negative Grassmannians, which we briefly describe following [16] and [19].

Definition 4.1. The totally non-negative Grassmannian $\operatorname{Gr}_{>0}(k, m)$ is the subset of the points of the Grassmannian $\operatorname{Gr}(k, m)$ whose Pluecker coordinates Δ_I have the same sign.

The key result of the Postnikov theory is that each $X \in \text{Gr}_{\geq 0}(k, m)$ can be parametrized by the Lam models.

Definition 4.2. A planar graph Γ together with a weight function $\omega : E(\Gamma) \rightarrow \mathbb{R}_{\geq 0}$ is called a **Lam model** $N(\Gamma, \omega)$, if the following holds:

- Γ is embedded into a disk D , and its nodes are divided on two sets, namely a set of inner nodes V_I and a set of boundary nodes V_B ;
- The boundary nodes V_B lay on a boundary circle ∂D and are numbered clockwise from 1 to $n := |V_B|$;
- The degrees of the boundary nodes are all equal to one;
- All the vertices of Γ are colored by either black or white color and each edge is incident to the vertices of different colors.

Note that when illustrating Lam models, we will omit the colors of boundary nodes and suppress the weights of edges if they are equal to 1.

Definition 4.3. A **dimer** Π is a collection of edges of Γ such that

- Each interior vertex is incident to one of the edges in Π ;
- Boundary vertices may or may not be incident to the edges in Π .

The weight $\text{wt}(\Pi)$ of a dimer Π is a product of all weights of its edges.

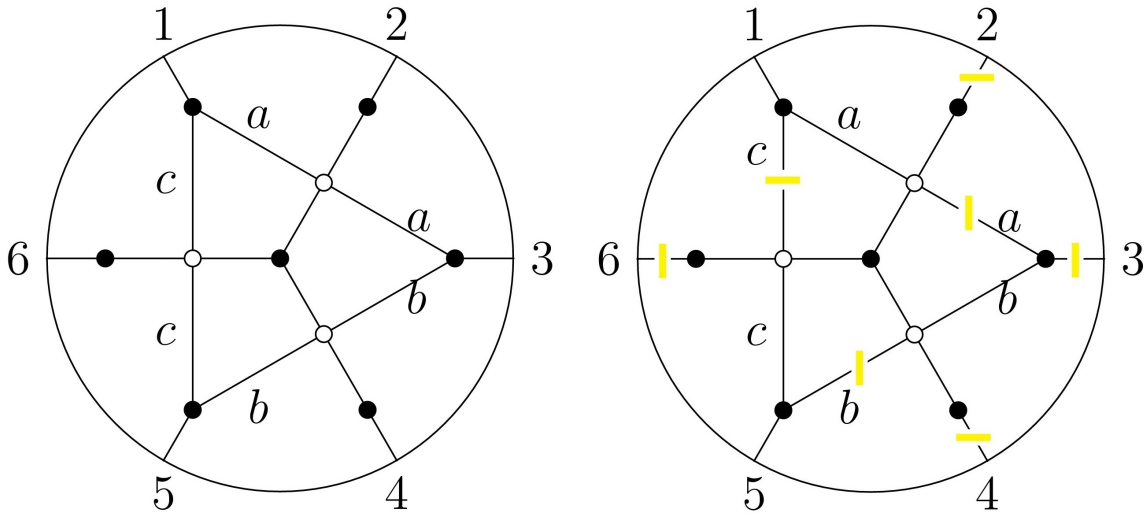

FIGURE 4. A Lam model with $k(\Gamma) = 2$ and its dimer $\Pi \in \Pi(15)$ with the weight $\text{wt}(\Pi)$ equals to ab

Consider a Lam model $N(\Gamma, \omega)$ and its arbitrary dimer Π , it is not difficult to verify that the sum of a number of black boundary nodes are *covered* by Π with a number of white boundary nodes are *not covered* by Π does not depend on the dimer Π and can be calculated as follows:

$$k(\Gamma) = \frac{1}{2} \left(n + \sum_{v \in \text{black}} (\deg(v) - 2) + \sum_{v \in \text{white}} (2 - \deg(v)) \right),$$

where summations are over black or white inner nodes of Γ . This observation leads to the following definition.

Definition 4.4. For each $I \subset V_I$ such that $|I| = k(\Gamma)$ the **boundary measurement** is given by the formula:

$$\Delta_I^d = \sum_{\Pi \in \Pi(I)} \text{wt}(\Pi),$$

where the summation goes over all dimers $\Pi \in \Pi(I)$ such that the black boundary nodes belonging to I are *covered* by Π ; and white nodes belonging to I are *not covered* by Π .

Theorem 4.5. [16] For a Lam model $N(\Gamma, \omega)$ the collection of boundary measurements Δ_I^d considered as a set of Plucker coordinates defines a point in $\text{Gr}_{\geq 0}(k(\Gamma), m)$. In particular the boundary measurements Δ_I^d satisfy the Plucker relations.

Moreover, for each point $X \in \text{Gr}_{\geq 0}(k, m)$ there is a Lam model $N(\Gamma, \omega)$ associated with it such that $\Delta_I(X) = \Delta_I^d$.

The second statement of Theorem 4.5 naturally leads to the formulation of the black box problem in the Postnikov theory.

Problem 4.6. Consider a Lam model $N(\Gamma, \omega)$ on a given graph Γ associated with a given point $X \in \text{Gr}_{\geq 0}(k, m)$. It is required to recover a weight function ω of $N(\Gamma, \omega)$ using Plucker coordinates of X .

The possibility of solving Problem 4.6 is revealed by the following result.

Definition 4.7. Consider a Lam model $N(\Gamma, \omega)$. Then, its **oriented median graph** Γ_M is defined as follows:

- Boundary nodes of Γ_M coincide with boundary nodes of $N(\Gamma, \omega)$;
- Inner nodes of Γ_M are the midpoints of the edges connected inner nodes of Γ .

Two nodes of Γ_M are connected by an edge if the edges of the original graph Γ are adjacent. Edges of Γ_M oriented as follows:

- Clockwise around each inner white node of Γ ;
- Counterclockwise around each inner black node of Γ .

Since all inner nodes of Γ_M have degree four, we can correctly define the **strands** of Γ_M as the oriented paths which always go straight through any degree four node.

Definition 4.8. A Lam model $N(\Gamma, \omega)$ is called **minimal** if the following holds:

- Each strand does not intersect itself;
- There are not loops apart from loops attached to isolated boundary nodes;
- Strands do not form oriented lenses, see Fig.5.

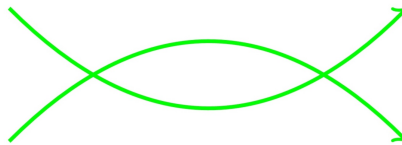

FIGURE 5. A forbidden oriented lens

Theorem 4.9. [16],[19] Consider a minimal Lam model $N(\Gamma, \omega)$ on a given graph Γ associated with a given point $X \in \text{Gr}_{\geq 0}(k, m)$. Then, a weight function ω is uniquely recovered (see Fig.6) by the Plucker coordinates of X , up to the gauge transformation.

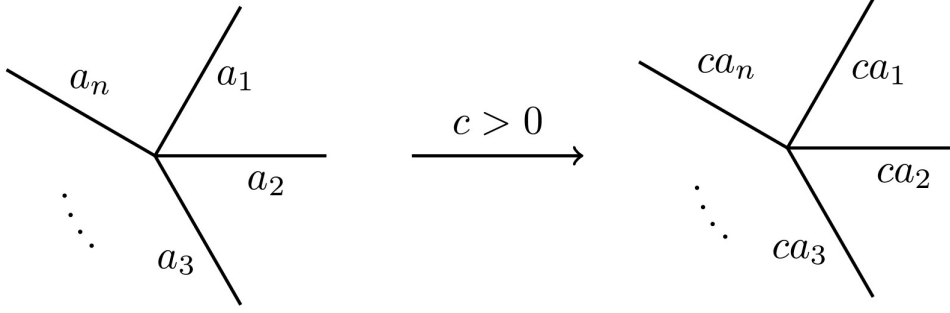

FIGURE 6. A gauge transformation in an inner node

Mirroring electrical network theory, the proofs of Theorem 4.9 provide algorithms to solve Problem 4.6. We will mention a few of them:

- The recursive bridge-lollipop decomposition [16];
- Solutions to Problem 4.6 for the special Le-diagram models [19], [22];
- Solution to Problem 4.6 by the generalized chamber ansatz [18].

We shall describe in details the last approach, since it is very important for our future goal.

Theorem 4.10. [18],[20] *Consider a minimal Lam model $N(\Gamma, \omega)$. Let us label each its face F by $I(F) \subset [n]$, $|I| = k(\Gamma)$ according to the following rule: if a face F lies on the left-hand side of the oriented strand from a source numbered i , we have that $i \in I(F)$. This labeling rule is defined correctly.*

Definition 4.11. [18] Consider a matrix $A \in \text{Mat}_{k \times m}$ and denote by A_i , $i \in \{1, \dots, 2n\}$ its columns. We define the **twist** $\tau(A) \in \text{Mat}_{k \times m}$ as follows:

$$\begin{cases} (\tau(A)_i, A_i) = 1, & \text{if } i = j \\ (\tau(A)_i, A_j) = 0, & \text{if } A_j \notin \text{span}(A_i, A_{i+1}, \dots, A_{j-1}), \end{cases}$$

here $\tau(A)_i$, $i \in \{1, \dots, m\}$ are the columns of $\tau(A)$; (\cdot, \cdot) is the standard scalar product; and the index operation $+$ is taken modulo m .

Theorem 4.12. [18] *Consider a minimal Lam model $N(\Gamma, \omega)$ on a given graph Γ associated with a point $X \in \text{Gr}_{\geq 0}(k, m)$ defined by a matrix A . Then a weight function ω can be found as follows:*

- The first step is to label each face F of Γ by $I(F)$ according to the rule from Theorem 4.10;
- The second step is to find the twist $\tau(A)$ of A ;
- Finally we calculate the weight function ω according to the rule:
 - If an edge e connects two inner nodes then

$$(1) \quad \omega(e) = \frac{1}{\Delta_{I(F_1)}(\tau(A)) \Delta_{I(F_2)}(\tau(A))},$$

here the edge e is shared by faces F_1 and F_2 ;

- If an edge e connects an inner node with a boundary node then

$$(2) \quad \omega(e) = \frac{1}{\Delta_{I(F)}(\tau(A))},$$

here F is

- * The closest counterclockwise which shares the edge e , if e connects a white boundary node;
- * The closest clockwise which shares the edge e , if e connects a black boundary node.

Remark 4.13. For our future goals we provide the general idea of the proof of Theorem 4.12 following by [18]. In fact, each face F of a minimal Lam model $N(\Gamma, \omega)$ uniquely defines a **minimal** (under the partial order on a set of all dimers with a fixed boundary) dimer Π_F , whose boundary can be calculated according to the rule from Theorem 4.10 i.e. $\Pi_F \in \Pi(I(F))$. Using weights $\text{wt}(\Pi_F)$ of these dimers we can up to the gauge transformations recover the weight function ω according to the following rule, where F_1, F_2, F are defined as in Theorem 4.12:

- If an edge e connects two inner nodes then

$$\omega(e) = \text{wt}(\Pi_{F_1})\text{wt}(\Pi_{F_2}),$$

- If an edge e connects an inner node to a boundary node, then

$$\omega(e) = \text{wt}(\Pi_F).$$

Finally, it remains to proof that the following identity holds:

$$\Delta_{I(F)}(\tau(A))\text{wt}(\Pi_F) = 1.$$

4.2. The Lam embedding and its parametrization. Now, we present the cornerstone result that will allow us to apply the Postnikov theory for the solution Problem 3.1.

Theorem 4.14. [6] *Consider an electrical network $\mathcal{E}(G, w) \in E_n$ with a response matrix $M_R(\mathcal{E}) = (x_{ij})$. Then there is an injective map $\mathcal{L} : E_n \rightarrow \text{Gr}_{\geq 0}(n-1, 2n)$ such that $\mathcal{L}(\mathcal{E})$ is a row space of the $(n \times 2n)$ matrix*

$$\Omega(\mathcal{E}) = \begin{pmatrix} x_{11} & 1 & -x_{12} & 0 & x_{13} & 0 & \cdots & (-1)^n \\ -x_{21} & 1 & x_{22} & 1 & -x_{23} & 0 & \cdots & 0 \\ x_{31} & 0 & -x_{32} & 1 & x_{33} & 1 & \cdots & 0 \\ \vdots & \vdots & \vdots & \vdots & \vdots & \vdots & \ddots & \vdots \end{pmatrix}$$

In particular we have:

- The dimension of the row space of $\Omega(\mathcal{E})$ is equal to $n-1$;
- Each $n-1 \times n-1$ minors of $\Omega(\mathcal{E})$ is non-negative;
- Plucker coordinates of the point of $\mathcal{L}(\mathcal{E})$ correspond to $n-1 \times n-1$ minors of the matrix $\Omega'(\mathcal{E})$ obtained from $\Omega(\mathcal{E})$ by deleting the last row.

Remark 4.15. The non-negativity of the Plucker coordinates of points $\mathcal{L}(\mathcal{E})$ is essentially equivalent to the last response matrix property from Theorem 2.2 (see [5] for more details).

Due to Theorem 4.5 a point $\mathcal{L}(\mathcal{E})$ associates with a Lam model $N(\mathcal{E})$, which can be canonically constructed with a network \mathcal{E} by the **generalized Temperley trick**. Essentially $N(\mathcal{E})$ is obtained by combining a graph G and its dual graph G^* ; all nodes of the graphs G and G^* are black, and additional node, which lay on intersections of edges G and G^* , are white; each edge coming from edge G has a weight equal to the conductivity of this edge, and all additional edges have weight 1 :

Definition 4.16. [15] Consider an electrical network $\mathcal{E}(G, w) \in E_n$ and let us construct its associated Lam model $N(\mathcal{E})$, whose nodes are defined as follows:

- If G has boundary nodes $\{1, 2, \dots, n\}$, then $N(\mathcal{E})$ will have white boundary nodes $\{1, 2, \dots, 2n\}$, where boundary node i is identified with $2i - 1$ and node $2i$ can be identified with the additional node \bar{i} lied between i and $i + 1$;
- Each boundary node has degree equal to 1;
- We have a black inner node b_v for each inner node v of G ;
- A black inner node b_F for each interior face F of G ;
- A white inner node w_e placed at the midpoint of each interior edge e of G ;
- For each boundary node \bar{i} , we have a black inner node b_i .

The edges of $N(\mathcal{E})$ are defined as follows:

- If v is a node of an edge e in G , then b_v and w_e are joined, and the weight $\omega(e)$ of this edge is equal to the weight $w(e)$ of e in G ;
- If e borders F , then w_e is joined to b_F by an edge with weight 1;
- The node b_i is joined by an edge with weight 1 to the boundary node $2i - 1$ in $N(e)$, and b_i is also joined by an edge with weight 1 to w_e for any edge e incident to \bar{i} in G ;
- Even boundary nodes $2i$ in $N(\mathcal{E})$ are joined by an edge with weight 1 to the face vertex w_F of the face F that they lie in.

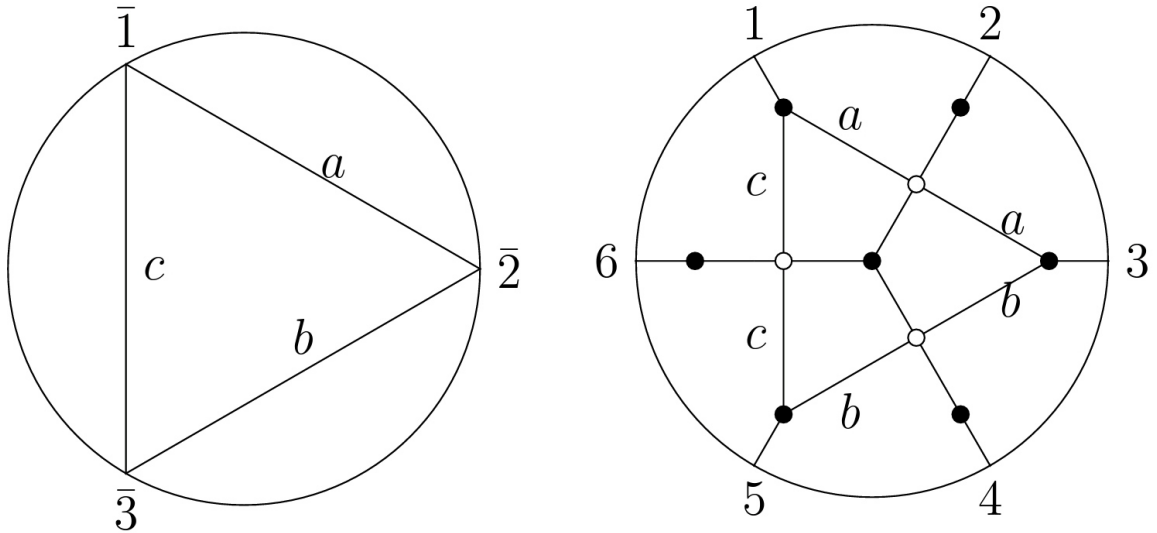

FIGURE 7. The triangle-shape network and its Lam model $N(\mathcal{E})$

Theorem 4.17.

- A Lam model $N(\mathcal{E})$ and $\Omega(\mathcal{E})$ define the same point of $\text{Gr}_{\geq 0}(n - 1, 2n)$, it has been proved in [6];
- Let us suppose that a network \mathcal{E} is a minimal and connected, then a Lam model $N(\mathcal{E})$ is also minimal.

Proof. To prove the second statement, it suffices to verify that $N(e)$ satisfies conditions in Definition 4.8. Indeed, the strands of a median graph G_M of a Lam model $N(e)$ are obtained by the parallel transitions (see Fig. 8) of strands of a median graph Γ_M of a network e . Since e is minimal, any two strands of Γ_M intersect at most once and each strand does not intersect itself. Therefore using the argument above we conclude that:

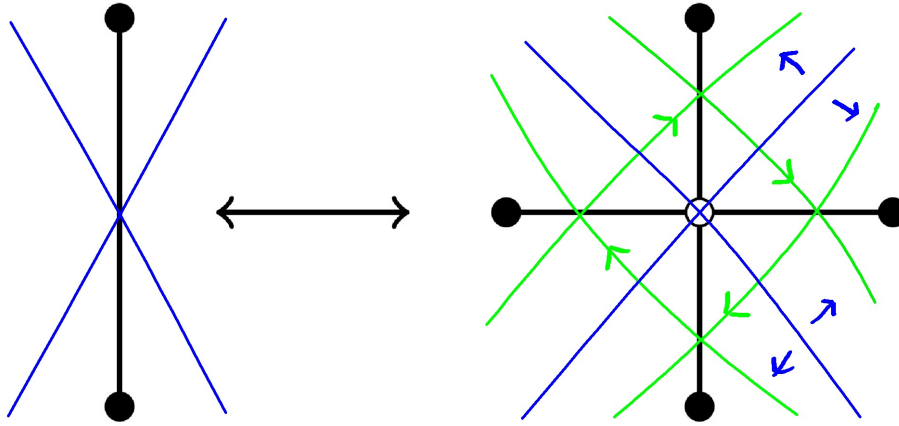

FIGURE 8. Strands of G_M and Γ_M around a midpoint of an electrical network edge

- Any two strands of G_M can intersect at most once in a midpoint of an inner edge of $N(e)$;
- No strand of G_M intersect itself.

Thus, any two strands might intersect:

- Exactly once in a midpoint of an inner edge;
- Exactly once in a midpoint of an inner edge and exactly once in a boundary node. Since all boundary nodes are white and a midpoint of an inner edge is connected with a white inner node, it is easy to check that this case does not lead to the forbidden lens (see Fig. 5);
- Exactly once in a midpoint of an inner edge and two times in a boundary nodes. According to the reasoning above, these intersections are not possible, since they contradict to the orientation rule of G_M ;
- Two times in a boundary nodes. This case also does not lead to the forbidden lens.

Therefore any two strands do not form a forbidden lens, it ends the proof. \square

4.3. The solution of the black problem via the generalized chamber ansatz.

The construction of the generalized Temperley trick, Theorem 4.9 and Theorem 4.17 demonstrate that Problem 3.1 can be considered as the particular case of Problem 4.6.

Proposition 4.18. *Consider a minimal electrical network $\mathcal{E}(G, w)$ then the recovery of a conductivity function w by a response matrix $M_R(\mathcal{E})$ is equivalent to the recovery of a weight function ω of a Lam model $N(\mathcal{E})$ by a matrix $\Omega(\mathcal{E})$.*

As the result of Theorem 4.9 and Theorem 4.12, for any minimal network, we can recover a weight function ω' of a Lam model $N(\mathcal{E})$. This function is up to gauge transformations equal to the weight function ω from Definition 4.16. However, determining the specific series of gauge transformations required to convert ω' to ω is generally difficult. Fortunately, there exists a set of coordinates on $N(\mathcal{E})$ that are invariant under gauge transformations.

Lemma 4.19. [19] We define the weight of each face F of $N(\mathcal{E})$ as follows:

$$O(F) = \frac{\prod_{e \in F, e=wb} \omega(e)}{\prod_{e \in F, e=bw} \omega(e)},$$

where F is considered to be clockwise edge oriented; the numerator is the product taken over all from white to black edges of F and the denominator is the product taken over all from black to white edges of F .

The face weight $O(F)$ does not depend on the gauge transformations.

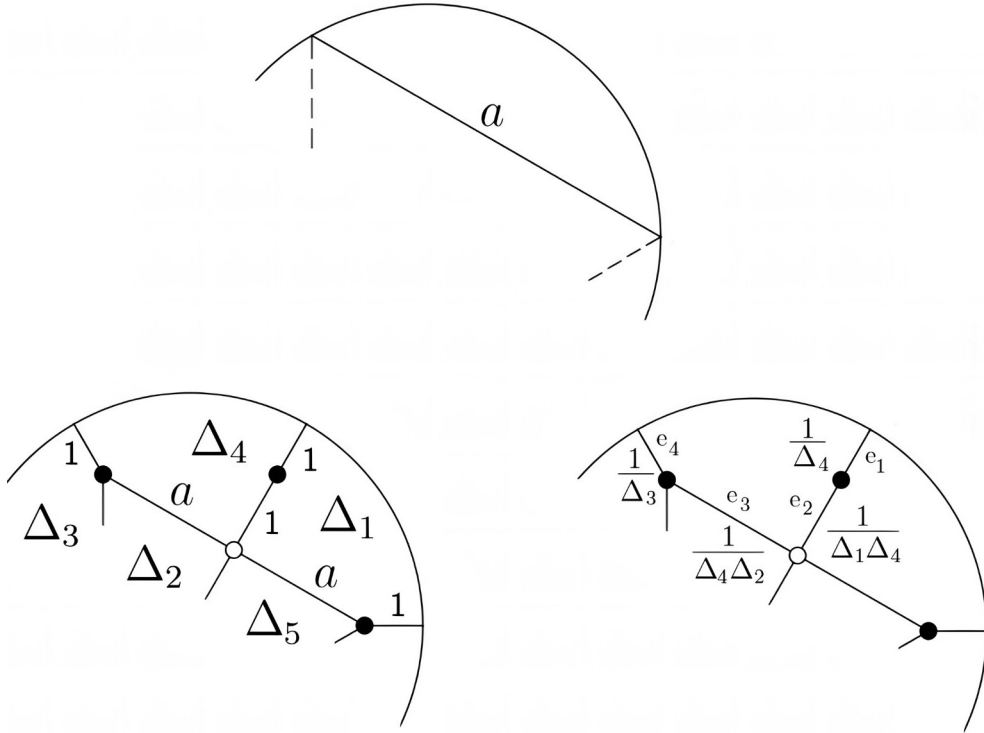

FIGURE 9. A bridge and a Lam model $N(\mathcal{E})$ around it

Lemma 4.20. Consider a minimal electrical network $\mathcal{E}(G, w)$ and its edge e . Then, the following holds:

- If an edge e is a **bridge** (i.e. an edge which connects a boundary node numbered by i with a boundary node numbered by $i + 1$) its conductivity can be recovered by the formula

$$(3) \quad w(e) = \frac{\Delta_1 \Delta_3}{\Delta_2 \Delta_4}$$

or, alternatively, by the formula

$$(4) \quad w(e) = \frac{\Delta_1}{\Delta_5};$$

- If an edge e is a **spike** (i.e. an edge which connects a boundary node with an unique inner node) can be recovered by the formula

$$(5) \quad w(e) = \frac{\Delta_2 \Delta_4}{\Delta_1 \Delta_3}$$

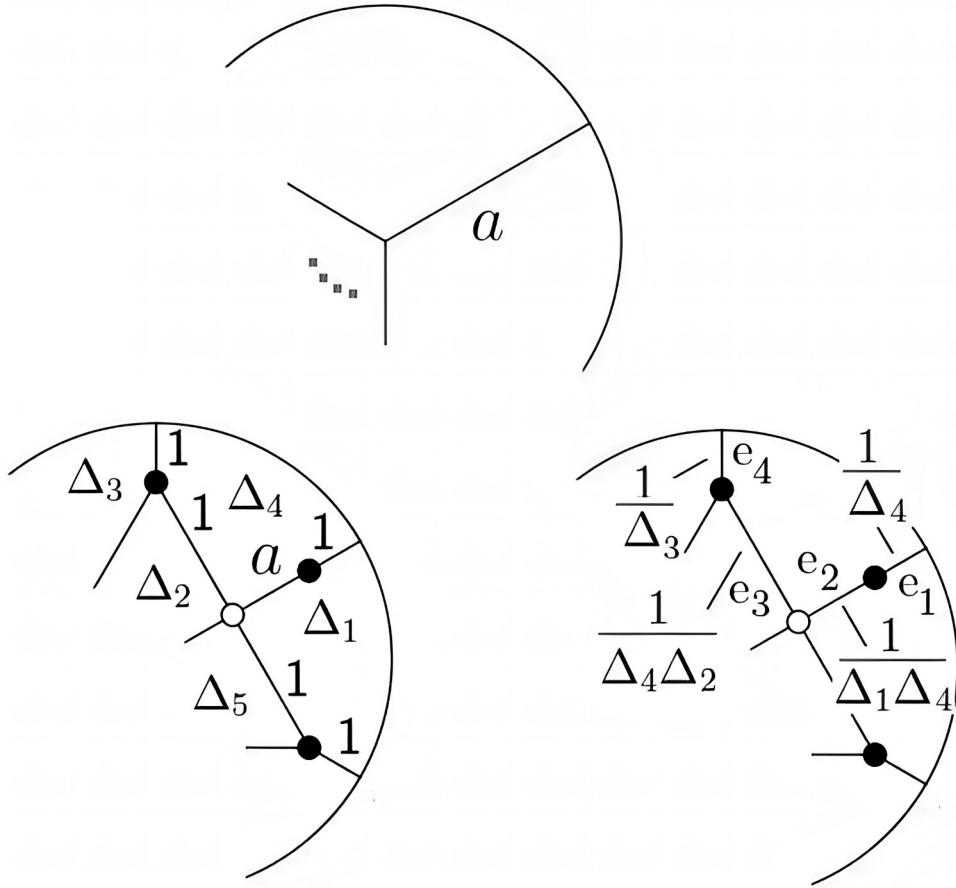

FIGURE 10. A spike and a Lam model $N(\mathcal{E})$ around it

or, alternatively, by the formula

$$(6) \quad w(e) = \frac{\Delta_5}{\Delta_1};$$

- Let us consider a face F and its two adjacent edges e_1 and e_2 (see Fig.11), then the ratio of their conductivities is equal to

$$(7) \quad \frac{w(e_1)}{w(e_2)} = \frac{\Delta_2 \Delta_4}{\Delta_1 \Delta_3},$$

where F_i are the faces labeled by Δ_i as it is shown in Fig.9, Fig.10 and Fig.11; and by Δ_i we denote

$$\Delta_i := \Delta_{I(F_i)}(\tau(\Omega'(\mathcal{E}))).$$

Proof. Let us prove Formula (3). Indeed, consider a face F_1 then

$$O(F_1) = \frac{\omega(e_1)\omega(e_3)}{\omega(e_2)\omega(e_4)} = a.$$

On the other hand, using Theorem 4.12 we have that

$$O(F_1) = \frac{\omega'(e_1)\omega'(e_3)}{\omega'(e_2)\omega'(e_4)} = \frac{\Delta_1 \Delta_3}{\Delta_2 \Delta_4},$$

where up to gauge transformations $\omega' = \omega$ and

$$\omega'(e_1) = \frac{1}{\Delta_4}, \quad \omega'(e_2) = \frac{1}{\Delta_1 \Delta_4}, \quad \omega'(e_3) = \frac{1}{\Delta_4 \Delta_2}, \quad \omega'(e_4) = \frac{1}{\Delta_3}.$$

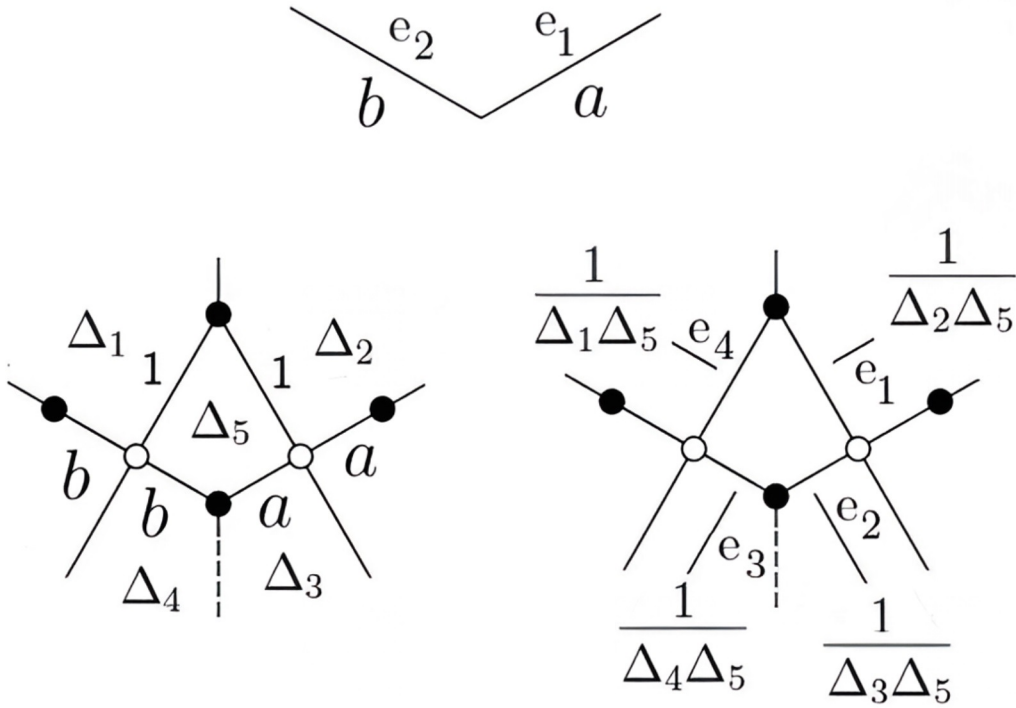

FIGURE 11. Two adjacent edges and a Lam model $N(\mathcal{E})$ around them

Since the value of $O(F_1)$ does not depend on gauge transformations we obtain Formula (3). Remaining formulas can be derived by the same way, that ends the proof. \square

Using Lemma 4.20 we can obtain the following algorithm which might be used to solve Problem 3.1.

Algorithm 4.21.

- By the given response matrix $M_R(\mathcal{E})$ of a minimal network \mathcal{E} construct the matrix $\Omega'(\mathcal{E})$;
- Calculate $\tau(\Omega'(\mathcal{E}))$;
- Label each face F of $N(\mathcal{E})$ by $n - 1 \times n - 1$ minors $\Delta_{F(I)}$ of a $\tau(\Omega'(\mathcal{E}))$;
- Using Formulas (3)–(4), (5)–(6) and (7) recover a conductivity function w .

Proof. The correctness of the proposed algorithm is derived from the following statements:

- Each minimal electrical network has at least one bridge or spike (see [9]), therefore we can extend bridges and spikes conductivities to conductivities of remain edges by Formula (7);
- The uniqueness of this extension defined by Formula (7) follows from Theorem 4.9 and the second part of Theorem 4.17.

\square

Remark 4.22. As it can be seen from Formulas (3)–(7) there are many ways to recover the same conductivity function w . Moreover, each minimal electrical network contains at least three bridges and spikes in total (see [9]). Therefore, recovery processes of the conductivity function w leads to many non-trivial identities, which of course follow from the special form of the weight function ω of $N(\mathcal{E})$. However, these identities might

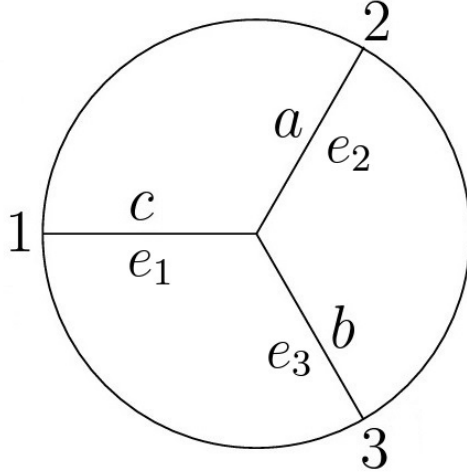

FIGURE 12. The star-shape network \mathcal{E}

be the sign of the existence of some integrable structures (see [2]) related to electrical networks.

Let us consider a couple of examples.

Example 4.23. Consider a network \mathcal{E} as it is shown in Fig.12, its response matrix has the form:

$$M_R(\mathcal{E}) = \begin{pmatrix} \frac{ca+cb}{a+b+c} & -\frac{ca}{a+b+c} & -\frac{cb}{a+b+c} \\ -\frac{ca}{a+b+c} & \frac{ca+ab}{a+b+c} & -\frac{ab}{a+b+c} \\ -\frac{cb}{a+b+c} & -\frac{ab}{a+b+c} & -\frac{cb+ab}{a+b+c} \end{pmatrix}.$$

Then $\Omega_3(\mathcal{E})$ and $\Omega'_3(\mathcal{E})$ are equal to

$$\Omega_3(\mathcal{E}) = \begin{pmatrix} \frac{ca+cb}{a+b+c} & 1 & \frac{ca}{a+b+c} & 0 & \frac{-cb}{a+b+c} & -1 \\ \frac{ca}{a+b+c} & 1 & \frac{ca+ab}{a+b+c} & 1 & \frac{ab}{a+b+c} & 0 \\ \frac{a+b+c}{a+b+c} & 0 & \frac{a+b+c}{a+b+c} & 1 & \frac{a+b+c}{a+b+c} & 1 \\ \frac{-cb}{a+b+c} & 0 & \frac{ab}{a+b+c} & 1 & \frac{cb+ab}{a+b+c} & 1 \end{pmatrix}, \quad \Omega'_3(\mathcal{E}) = \begin{pmatrix} \frac{ca+cb}{a+b+c} & 1 & \frac{ca}{a+b+c} & 0 & \frac{-cb}{a+b+c} & -1 \\ \frac{ca}{a+b+c} & 1 & \frac{ca+ab}{a+b+c} & 1 & \frac{ab}{a+b+c} & 0 \\ \frac{a+b+c}{a+b+c} & 1 & \frac{a+b+c}{a+b+c} & 1 & \frac{a+b+c}{a+b+c} & 1 \\ \frac{-cb}{a+b+c} & 0 & \frac{ab}{a+b+c} & 1 & \frac{cb+ab}{a+b+c} & 1 \end{pmatrix}.$$

By direct computation we can verify that all 2 minors of $\Omega'_3(\mathcal{E})$ do not vanish, therefore

$$\tau(\Omega'_3(\mathcal{E})) = \begin{pmatrix} \frac{a+b+c}{bc} & \frac{c+b}{b} & \frac{a+b+c}{ac} & \frac{a}{c} & 0 & -1 \\ -\frac{a+b+c}{bc} & -\frac{c}{b} & 0 & 1 & \frac{a+b+c}{ab} & \frac{a+b}{a} \end{pmatrix}.$$

For instance, $\tau(A)_6$ is defined by the following equations: $(\tau(A)_6, A_6) = 1$ and $(\tau(A)_6, A_{6+1 \bmod 6}) = (\tau(A)_6, A_1) = 0$ (since $A_6 \notin \text{span}(A_1)$).

Let us label each face of $N(\mathcal{E})$ according to the rule defined in Theorem 4.10, as it is shown in Fig.13. Since the edge e_1 is a spike, we obtain the following identities:

$$(8) \quad w(e_1) = \frac{\Delta_{26}}{\Delta_{16}} = \frac{\frac{a+b+c}{a}}{\frac{a+b+c}{ca}} = c$$

or alternatively

$$(9) \quad w(e_1) = \frac{\Delta_{56}\Delta_{46}}{\Delta_{16}\Delta_{45}} = \frac{\frac{a+b+c}{ab} \frac{a+b+c}{c}}{\frac{a+b+c}{ca} \frac{a+b+c}{cb}} = c.$$

Example 4.24. Let us consider a series of the general position (well-connected, see [14]) minimal electrical networks $\mathcal{E}(G_{4m+1}, \omega)$ defined as follows:

- The boundary nodes lie on a boundary circle of radius $m + 1$, centered at $(0, 0)$;

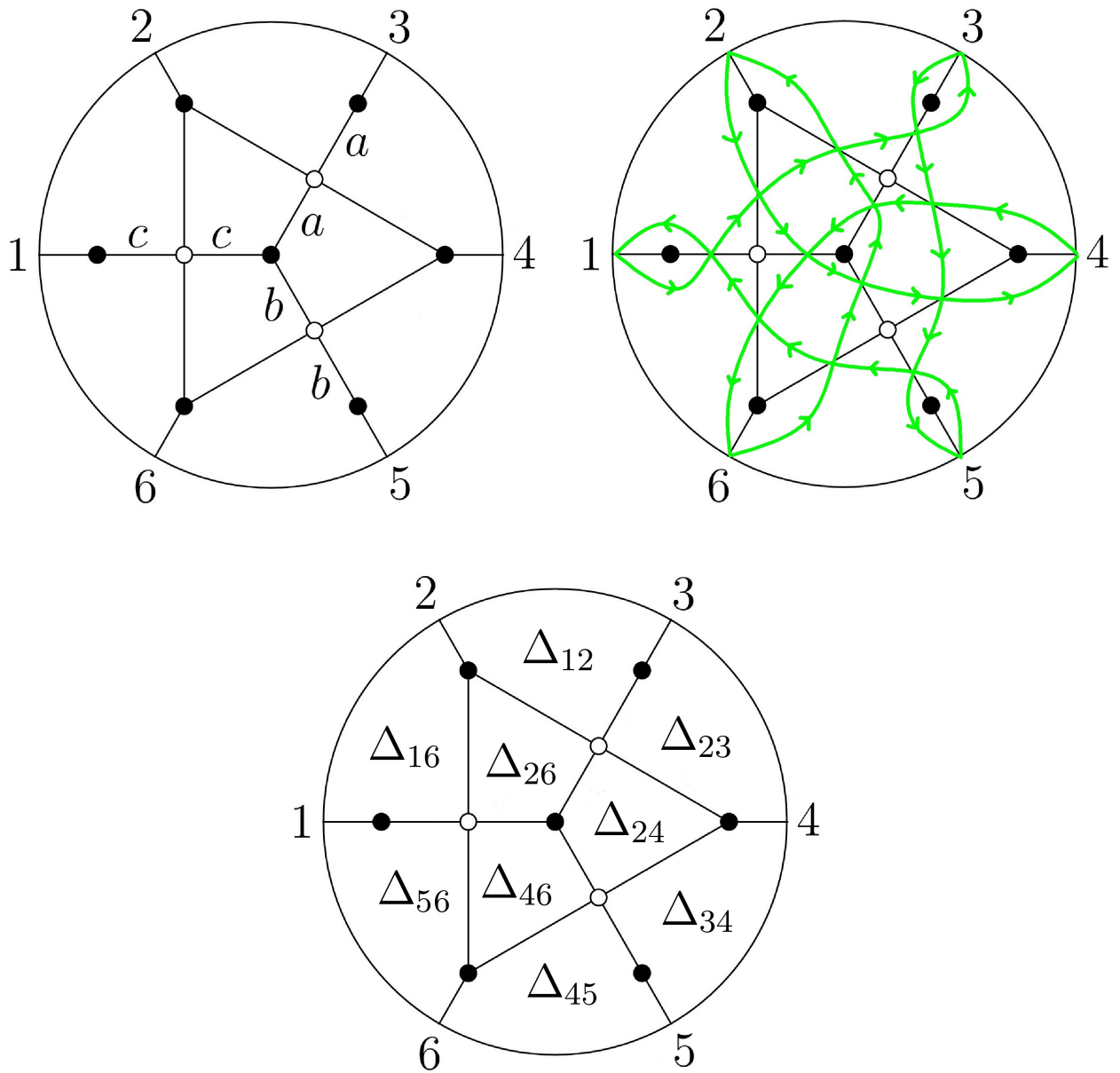

FIGURE 13. The Lam model $N(\mathcal{E})$ and the face labeling

- The nodes of G_{4m+1} are the points (i, j) for integers i and j with $0 < i \leq m + 1$ and $1 \leq j \leq 4m + 1$. The radial edges are the radial line segments joining (i, j) to $(i + 1, j)$ for each $0 < i \leq m$ and each $1 \leq j \leq 4m + 1$. The circular edges are the circular arcs joining (i, j) to $(i, j + 1)$ for each $1 \leq i \leq m$ and each $1 \leq j \leq 4m + 1$. The graph G_{4m+1} has $2m(4m + 1)$ edges and $(m - 1)(4m + 1)$ nodes;
- The boundary nodes of G_{4m+1} are the points $v_j = (m + 1, j)$, for $j = 1, \dots, 4m + 1$, with the convention that $v_0 = v_{4m+1}$.

The significance of these electrical networks is due to their role as dual networks to those used in numerical solutions of the Calderon problem, see [3] and also Theorem 3.7 [12].

Based on the specific shape of $\mathcal{E}(G_{4m+1}, \omega)$ we can propose the following way to solve Problem 3.1 to them:

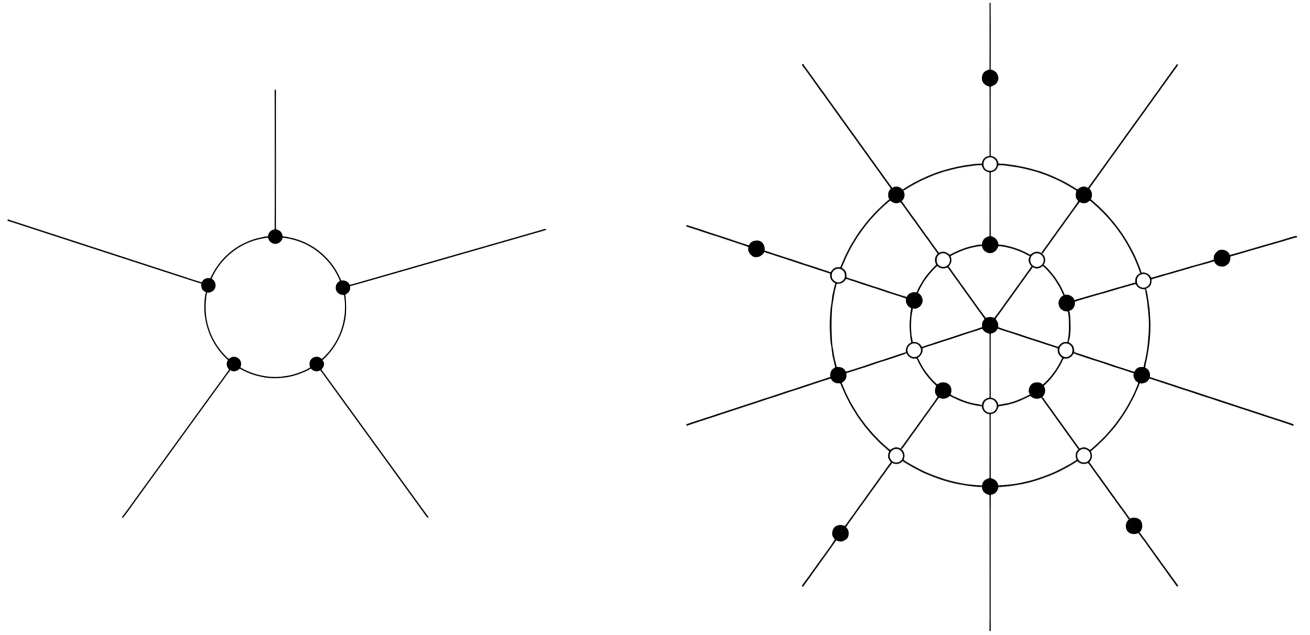

FIGURE 14. G_5 and associates to it Lam model, boundary circles are not drawn

- To label each face of $N(\mathcal{E})$ according to the rule described in [5];
- To recover spikes conductivities;
- Using a spike conductivity and Formula (7) to extend conductivities of the remain edges in each **part**, see Fig. 15 and 16:

$$a_1 = \frac{\Delta_1 \Delta_2}{\Delta'_1 \tilde{\Delta}_1}, \quad a_i = \frac{\Delta_{2i-1} \Delta_{2i+1}}{\Delta'_{2i} \tilde{\Delta}_{2i}}, \quad b_i = \frac{\Delta'_{2i+1} \tilde{\Delta}_{2i+1}}{\Delta_{2i} \Delta_{2i+2}}.$$

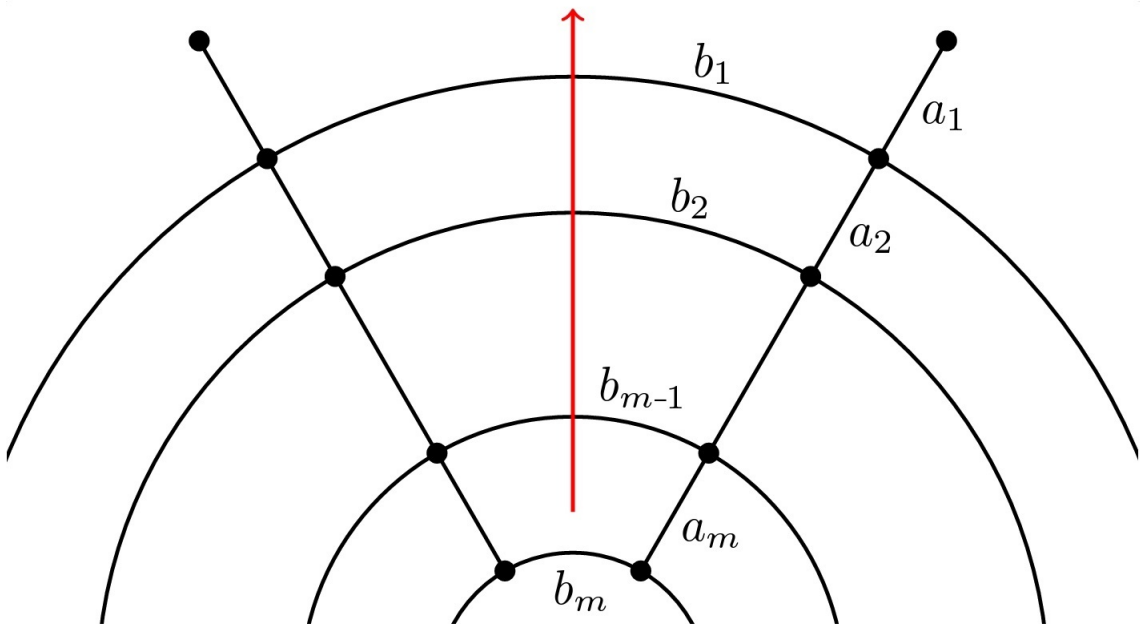

FIGURE 15. A part

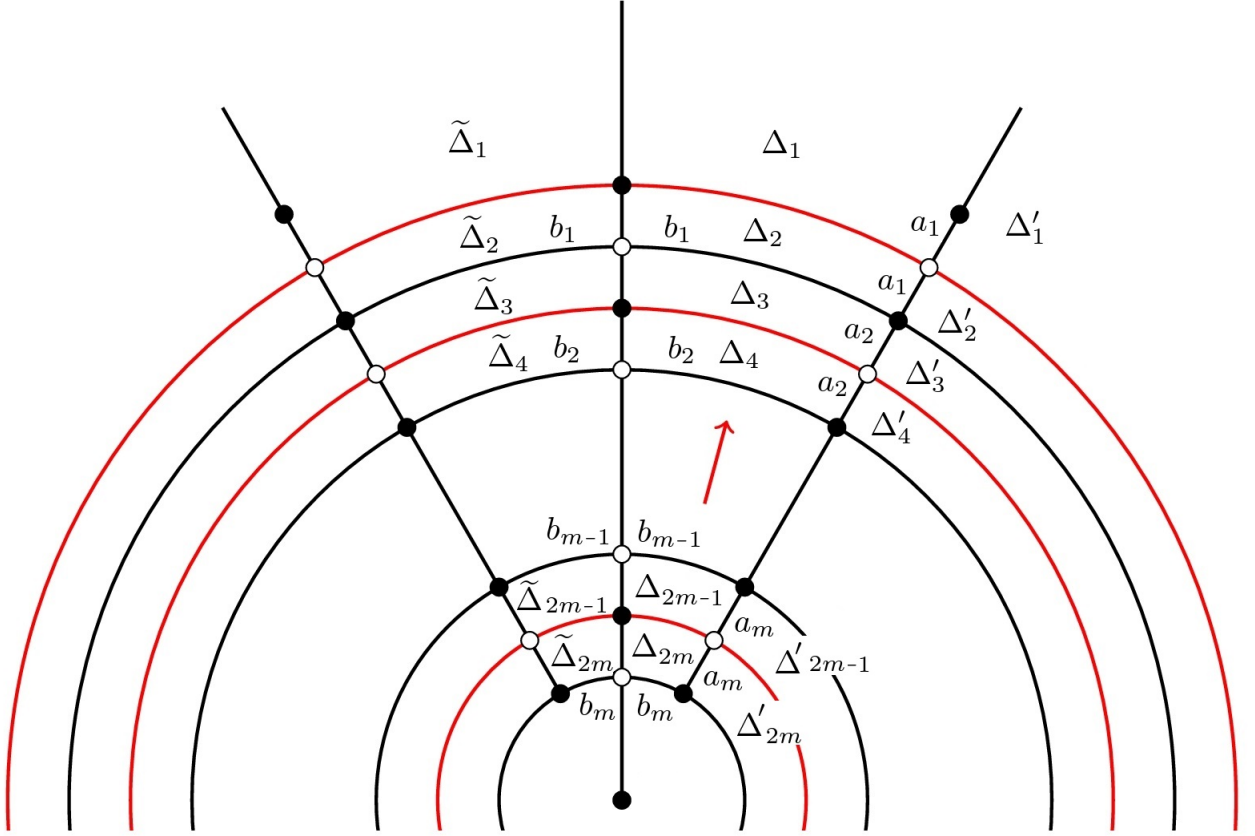

FIGURE 16. A Lam model across the part

4.4. Conductivity recovering via groves. Now we reveal some combinatorial aspects of Algorithm 4.21. Particularly, we demonstrate that conductivities can be recovered by weights of the special groves.

Definition 4.25. A **grove** \mathcal{G} on a graph G of an electrical network $\mathcal{E}(G, w)$ is a spanning forest, that is an acyclic subgraph that covers all nodes, such that each connected component contains at least one boundary nodes. A weight $wt(\mathcal{G})$ of the grove \mathcal{G} is equal to $wt(\mathcal{G}) = \prod_{e \in \mathcal{G}} w(e)$.

Theorem 4.26. [15] Consider an electrical network $\mathcal{E}(G, w)$ and its associated Lam model $N(\mathcal{E})$. Then, for each $I \subset \{1, \dots, n\}$, $|I| = n - 1$, there is a natural weight preserving **bijection** \mathcal{F}_I between the subset of dimers $\Pi \in \Pi(I)$ on $N(\mathcal{E})$ (i.e. a subset of dimers, which do not cover boundary nodes belonging to I , see Definition 4.4) and the corresponding to it subset of groves on $\mathcal{E}(G, w)$ such that $wt(\Pi) = wt(\mathcal{F}_I(\Pi))$.

Due to Theorem 4.26, the Plucker coordinates of $\mathcal{L}(\mathcal{E})$ can be rewritten in terms of grove weights.

Theorem 4.27. [6] Consider an electrical network $\mathcal{E}(G, w) \in E_n$. Then, the following identity holds:

$$\Delta_I(\Omega(\mathcal{E})) = \frac{\sum_{\Pi \in \Pi(I)} wt(\Pi)}{L_{unc}} = \frac{\sum_{\Pi \in \Pi(I)} wt(\mathcal{F}_I(\Pi))}{L_{unc}} = \frac{\sum_{\mathcal{G} \in \mathcal{G}|I} wt(\mathcal{G})}{L_{unc}},$$

where L_{unc} is the partition function of the weights of all groves with exactly n connected components; and the last sum goes over all groves, which are concondart with I , see [15] for more details.

Theorem 4.26 and Remark 4.13 also provide additional interpretation of the formulas presented in Lemma 4.20.

Proposition 4.28. Consider a minimal electrical network $\mathcal{E}(G, w)$ then the following Plucker coordinate equality holds:

$$\Delta_{I(F)}\left(\tau(\Omega'(\mathcal{E}))\right) = \frac{1}{wt(\mathcal{G}_F)},$$

where $\mathcal{G}_F := \mathcal{F}_I(\Pi_F)$ is the **minimal** grove corresponded to the minimal dimer Π_F , see Remark 4.13.

Remark 4.29. Moreover, if a face F of $N(\mathcal{E})$ is a boundary face (i.e. a face which is bounded by the boundary circle of $N(\mathcal{E})$) then Π_F is an unique dimer such that $\Pi \in I_F(\Pi)$, see [18]. Therefore we obtain the following Plucker coordinate equality for the boundary face:

$$(10) \quad \Delta_{I(F)}(\Omega'(\mathcal{E})) = wt(\mathcal{G}_F).$$

Proposition 4.30. Combining Proposition 4.28 with Lemma 4.20, we conclude that the conductivity function of each minimal electrical network can be recovered by weights of the minimal groves.

Let us provide an example:

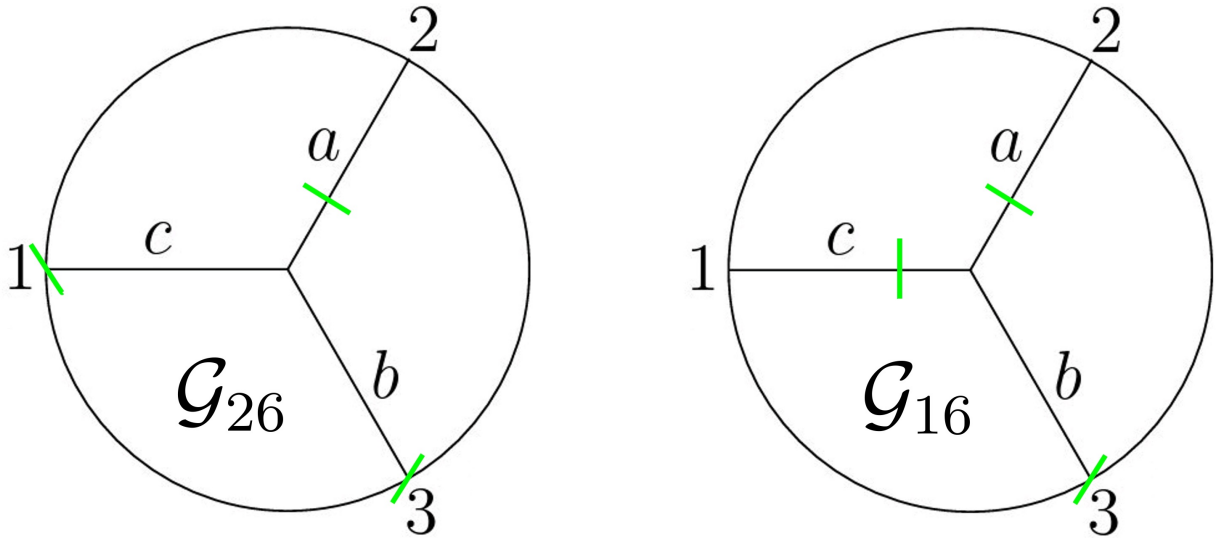

FIGURE 17. Minimal groves corresponded to faces labeled by 26 and 16

Example 4.31. Consider a network \mathcal{E} as it is shown in Fig.(12) then Formula 8 can be rewritten as follows:

$$w(e_1) = \frac{\frac{1}{wt(\mathcal{G}_{26})}}{\frac{1}{wt(\mathcal{G}_{16})}} = \frac{\frac{1}{a}}{\frac{1}{ac}} = c.$$

Proposition 4.30 gives rise to a couple of natural questions.

Problem 4.32. In [18] minimal dimers Π_F of a minimal Lam model $N(\Gamma, \omega)$ were defined using strands of an oriented median graph Γ_M of $N(\Gamma, \omega)$. Is the similar approach for constructing minimal groves \mathcal{G}_F of a minimal electrical network $\mathcal{E}(G, w)$ with strands of median graph G_M of $\mathcal{E}(G, w)$?

5. CONDUCTIVITIES RECONSTRUCTION VIA EFFECTIVE RESISTANCES

In this section, we will demonstrate a solution to another version of Problem 3.1, which, in addition to the motivation described in Section 3, has found its application in phylogenetic networks theory, see [10], [11], [12].

Definition 5.1. Let $\mathcal{E}(G, w) \in E_n$ be a connected electrical network, and let the boundary voltages $U = (U_1, \dots, U_n)$ be such that

$$M_R(\mathcal{E})U = -e_i + e_j,$$

where e_k , $k \in \{1, \dots, n\}$ is the standard basis of \mathbb{R}^n .

Let us define the **effective resistance** R_{ij} between nodes i and j as follows $|U_i - U_j| := R_{ij}$. Effective resistances are well-defined and $R_{ij} = R_{ji}$.

We will organize the effective resistances R_{ij} in an **effective resistances matrix** $R_{\mathcal{E}}$ setting $R_{ii} = 0$ for all i .

Problem 5.2. Consider an electrical network $\mathcal{E}(G, w)$ on a given graph G . The conductivity function w is required to be recovered by a known effective resistances matrix $R_{\mathcal{E}}$.

Theorem 5.3. *The conductivity function w of a minimal electrical network $\mathcal{E}(G, w) \in E_n$ can be uniquely recovered by a known effective resistances matrix $R_{\mathcal{E}}$.*

We provide the constructive proof of Theorem 5.3, which we will be absolutely similar to the proof of Theorem 3.2 due to the following result:

Theorem 5.4. [4] *Let \mathcal{E} be a connected network, using its effective resistances matrix $R_{\mathcal{E}}$, we define a point in $Gr(n-1, 2n)$ associated to it as the row space of the matrix:*

$$\Omega_R(\mathcal{E}) = \begin{pmatrix} 1 & m_{11} & 1 & -m_{12} & 0 & m_{13} & 0 & \dots \\ 0 & -m_{21} & 1 & m_{22} & 1 & -m_{23} & 0 & \dots \\ 0 & m_{31} & 0 & -m_{32} & 1 & m_{33} & 1 & \dots \\ \vdots & \vdots & \vdots & \vdots & \vdots & \vdots & \vdots & \ddots \end{pmatrix},$$

where

$$m_{ij} = -\frac{1}{2}(R_{i,j} + R_{i+1,j+1} - R_{i,j+1} - R_{i+1,j}).$$

Then, $\Omega_R(\mathcal{E})$ defines the same point of $Gr_{\geq 0}(n-1, 2n)$ as the point $\mathcal{L}(\mathcal{E})$.

Example 5.5. Consider a network as it is shown in Fig. 18, then its effective resistances matrix has the form

$$R(\mathcal{E}) = \begin{pmatrix} 0 & 3 & 3 & 2 \\ 3 & 0 & 2 & 3 \\ 3 & 2 & 0 & 3 \\ 2 & 3 & 3 & 0 \end{pmatrix},$$

and the matrix $\Omega'_R(\mathcal{E})$ obtained from $\Omega_R(\mathcal{E})$ by deleting its last row has the form

$$\Omega'_R(\mathcal{E}) = \begin{pmatrix} 1 & 3 & 1 & 1 & 0 & -1 & 0 & 1 \\ 0 & 1 & 1 & 2 & 1 & 1 & 0 & 0 \\ 0 & -1 & 0 & 1 & 1 & 3 & 1 & 1 \end{pmatrix}.$$

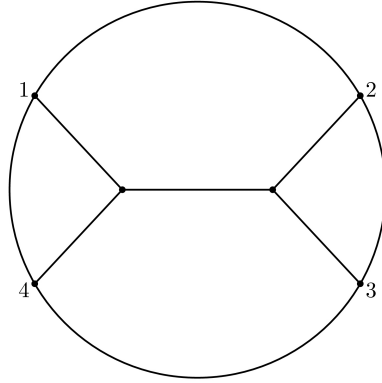

FIGURE 18. All conductivities are equal to 1

Thus we obtain the following algorithm to solve Problem 5.3:

Algorithm 5.6.

- By a given effective resistances matrix $R(\mathcal{E})$ construct a matrix $\Omega'_R(\mathcal{E})$;
- Calculate $\tau(\Omega'_R(\mathcal{E}))$;
- Do the last two steps of Algorithm 4.21.

6. THE BLACK BOX PROBLEM AS THE BERENSTEIN-FOMIN-ZELEVINSKY PROBLEM

In this section we discuss the connection between Problem 3.1 and the theory of totally non-negative matrices.

Definition 6.1. An invertible matrix $A \in \text{Mat}_{n \times n}(\mathbb{R})$ is called **totally non-negative** if all its minors are non-negative.

Theorem 6.2. [26] *Each totally non-negative matrix can be decomposed into a product of elementary generators, i.e. Jacobi matrices $x_i(t) = E + tE_{i,i+1}$, $y_i(t) = E + tE_{i,i-1}$ and a diagonal matrix $d = \text{diag}(d_1, \dots, d_n)$ with all non-negative parameters t, d_i .*

Example 6.3.

$$x_1(t) = \begin{pmatrix} 1 & t & 0 \\ 0 & 1 & 0 \\ 0 & 0 & 1 \end{pmatrix}, \quad y_3(t) = \begin{pmatrix} 1 & 0 & 0 \\ 0 & 1 & 0 \\ 0 & t & 1 \end{pmatrix}.$$

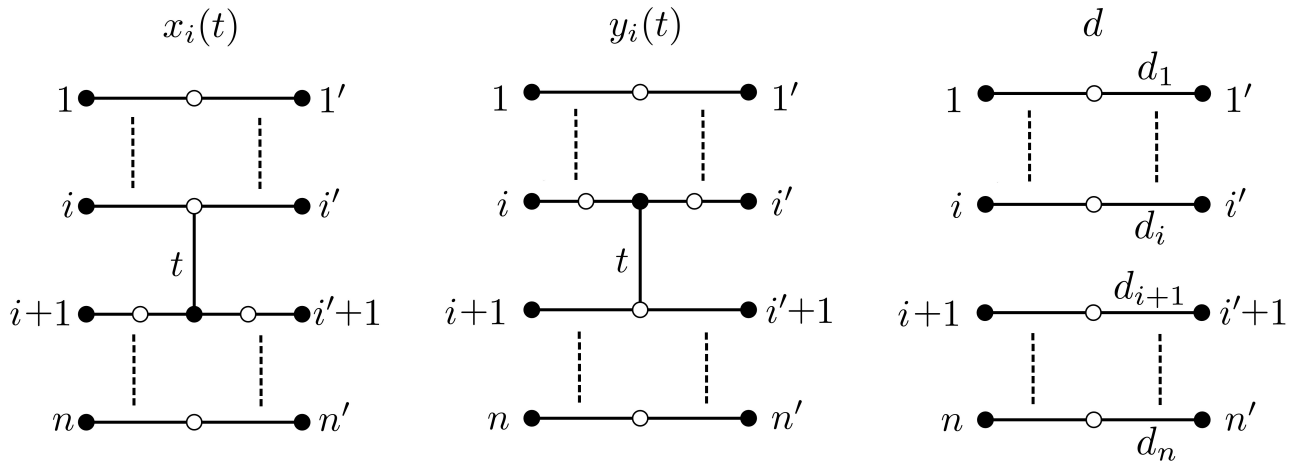

FIGURE 19. The elementary generators

Theorem 6.2 gives rise to the following natural problem, which we after works [17], [1] call **Berenstein-Fomin-Zelevinsky problem**:

Problem 6.4. Consider a totally non-negative matrix A and its given decomposition in a product of elementary generators. It is required to recover the parameters of elementary generators.

Lemma 6.5. [6] *Define the subspace*

$$V = \{v \in \mathbb{R}^{2n} \mid \sum_{i=1}^n (-1)^i v_{2i} = 0 \quad \sum_{i=1}^n (-1)^i v_{2i-1} = 0\}.$$

Then the rows of the a matrix $\Omega(\mathcal{E})$ (a matrix $\Omega_R(\mathcal{E})$) belong to the subspace V . Thus a matrix $\Omega(\mathcal{E})$ (a matrix $\Omega_R(\mathcal{E})$) defines a point of $Gr(n-1, V)$.

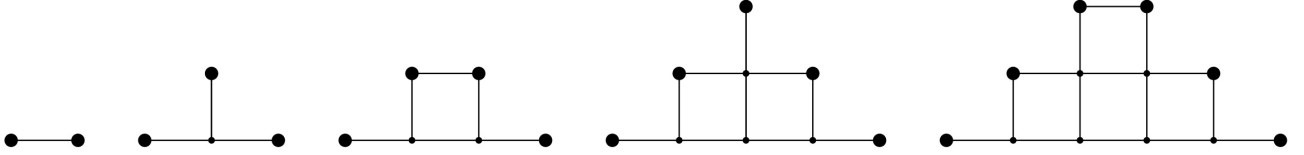

FIGURE 20. Standard networks, boundary nodes are bold

Theorem 6.6. [7],[21] *For odd n there is a special basis of V such that expanding $\Omega(\mathcal{E})$ we obtain a matrix $\bar{\Omega}(\mathcal{E})$, which defines a point of Lagrangian Grassmannian $LG_{\geq 0}(n-1, V)$ with respect of a some skew-symmetric non-degenerate form.*

*For the (well-connected, see [14]) minimal **standard** networks with odd boundary nodes $\bar{\Omega}(\mathcal{E})$ and the matrix of the following form define the same point in $LG_{\geq 0}(n-1, V)$:*

$$(\bar{\text{Id}}, A(\mathcal{E})) = \begin{pmatrix} 0 & \dots & 0 & 0 & 1 & a_{11} & a_{12} & a_{13} & \dots \\ 0 & \dots & 0 & -1 & 0 & a_{21} & a_{22} & a_{23} & \dots \\ 0 & \dots & 1 & 0 & 0 & a_{31} & a_{32} & a_{33} & \dots \\ \vdots & \vdots & \vdots & \ddots & \vdots & \vdots & \vdots & \ddots & \vdots \end{pmatrix}.$$

A matrix $A(\mathcal{E}) = (a_{ij})$ is a totally non-negative symplectic matrix with respect to the skew-symmetric non-degenerate form:

$$\Lambda_n = \begin{pmatrix} 0 & 1 & 0 & 0 & \dots \\ -1 & 0 & -1 & 0 & \dots \\ 0 & 1 & 0 & 1 & \dots \\ \vdots & \vdots & \vdots & \ddots & \vdots \end{pmatrix}, \quad A(\mathcal{E})\Lambda_n A(\mathcal{E})^t = \Lambda_n.$$

A matrix $A(e)$ can be decomposed into a product of the elementary symplectic generators $u_{i,i+1}(t) = E + t(E_{i+1,i} + E_{i-1,i})$ and $E_{n+1,n} = E_{0,1} = 0$:

$$(11) \quad A(\mathcal{E}) = \prod_{1 \leq i < j \leq n} u_{j-i,j-i+1}(t_{ij}),$$

where the product is taken over all pairs (i, j) ordered in reverse lexicographical order; and $t_{ij} = w_{ij}^{(-1)^{i+j-1}}$ here w_{ij} is a conductivity of an edge lied in intersection strands numbered i and j , see Fig. 21.

Remark 6.7. The decomposition 11 is compatible with bridge-spike decomposition, see [6] Section 8.1. We suppose that based on this observation it is possible to extend Theorem 6.6 to any network.

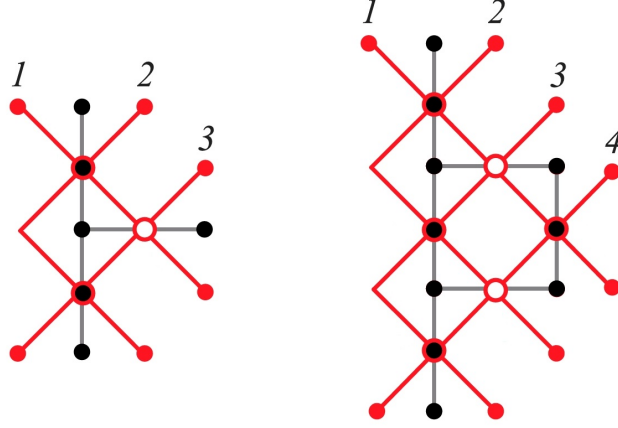

FIGURE 21. The edge numeration

Thus, it is clear that Problem 3.1 can be considered as the special instance of Problem 6.4, which is, in turn, closely related to Problem 4.6. This relationship is established by the following trick:

Theorem 6.8. [19] *Let $A \in \text{Mat}_{n \times n}(\mathbb{R})$ be a totally non-negative matrix with a known decomposition into a product of the elementary generators. Consider a point $X(A) \in \text{Gr}_{\geq 0}(n, 2n)$ which has the following form:*

$$X(A) = (\overline{\text{Id}}, A) = \begin{pmatrix} 0 & \dots & 0 & 0 & 1 & a_{11} & a_{12} & a_{13} & \dots \\ 0 & \dots & 0 & -1 & 0 & a_{21} & a_{22} & a_{23} & \dots \\ 0 & \dots & 1 & 0 & 0 & a_{31} & a_{32} & a_{33} & \dots \\ \vdots & \vdots & \vdots & \ddots & \vdots & \vdots & \vdots & \ddots & \vdots \end{pmatrix},$$

The $X(A)$ is defined by a Lam model, which can be built by compatible with the decomposition concatenation of elementary Lam models. Each elementary Lam model corresponds to an elementary generator, as it is shown in Fig. 19 (here we use the non-standard notation for the boundary nodes numbering, which relates to an ordinary with the substitution $n \rightarrow 1, \dots, 1 \rightarrow n, 1' \rightarrow n + 1, \dots, n' \rightarrow 2n$).

Example 6.9. Consider the standard electrical network with 3 boundary nodes. Using Theorem 6.6 we obtain that

$$A(\mathcal{E}) = u_{12}(t_{23})u_{23}(t_{13})u_{12}(t_{12})$$

and the point $X(A(\mathcal{E}))$ is defined by the Lam model, as it is shown in Fig. 22.

Note that Lam models associated with points $X(A(\mathcal{E}))$ are generally not minimal. Even the Lam model depicted in Fig. 22 is not minimal. Consequently, the recovery technique outlined in Section 4.1 can not be directly used to solve Berenstein-Fomin-Zelevinsky problem for totally non-negative symplectic matrices $A(\mathcal{E})$. However, we believe that the connection between the black box problem and described Berenstein-Fomin-Zelevinsky problem will shed the light on the last one. In particular, we expect that the following to occur:

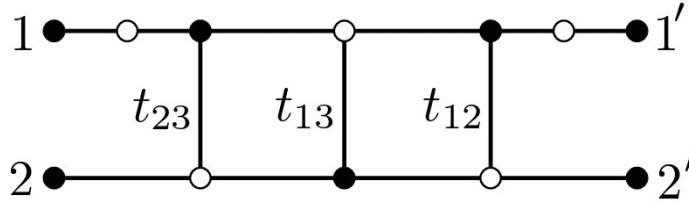

FIGURE 22. The Lam model associated with the standard electrical network with 3 boundary nodes

Hypothesis 6.10. *Any totally totally positive (i.e. a totally non-negative with all positive minors) symplectic matrix M admits the following decomposition:*

$$M = \prod_{1 \leq i < j \leq n} u_{j-i, j-i+1}(t_{ij}),$$

with all non-negative parameters $t_{ij} > 0$.

REFERENCES

- [1] A. Berenstein, S. Fomin, A. Zelevinsky, Parametrizations of canonical bases and totally positive matrices. *advances in mathematics*, Vol. 122, No. 1, pp. 49-149 (1996).
- [2] A. I. Bobenko, Y. B. Suris, *Discrete differential geometry: integrable structure*. American Mathematical Soc., Vol. 98 (2008).
- [3] L. Borcea, V. Druskin, F.G. Vasquez, Electrical impedance tomography with resistor networks. *Inverse Problems*, Vol. 24, No. 3, 035013 (2008).
- [4] B. Bychkov, V. Gorbounov, L. Guterman, A. Kazakov, Symplectic geometry of electrical networks. *arXiv preprint [arXiv:2501.01383](https://arxiv.org/abs/2501.01383)* (2024).
- [5] B. Bychkov, L. Guterman, A. Kazakov, Electrical networks via circular minors — work in progress.
- [6] B. Bychkov, V. Gorbounov, A. Kazakov, D. Talalaev, Electrical Networks, Lagrangian Grassmannians, and Symplectic Groups. *Moscow Mathematical Journal*, Vol.23, No.2, pp.133-167 (2023).
- [7] V. Gorbounov, D. Talalaev, Electrical varieties as vertex integrable statistical models. *Journal of Physics A: Mathematical and Theoretical*, Vol. 53, No. 45, 454001 (2020).
- [8] E. B. Curtis, D. Ingerman, J. A. Morrow, Circular planar graphs and resistor networks. *Linear algebra and its applications*, Vol.283, No. 1-3, pp.115-150 (1998).
- [9] B. Curtis, J. A. Morrow, *Inverse problems for electrical networks*. World Scientific. Vol.13 (2000).
- [10] S. Forcey, D. Scalzo, Phylogenetic networks as circuits with resistance distance. *Frontiers in Genetics*, Vol. 11, 586664 (2020).
- [11] S. Forcey, Circular planar electrical networks, split systems, and phylogenetic networks. *SIAM Journal on Applied Algebra and Geometry*, Vol. 7, No. 1, pp. 49-76 (2023).
- [12] V. Gorbounov, A. Kazakov, Electrical networks and data analysis in phylogenetics. *arXiv preprint [arXiv:2501.01383](https://arxiv.org/abs/2501.01383)*. (2025).
- [13] R. W. Kenyon, D. B. Wilson, The space of circular planar electrical networks. *SIAM Journal on Discrete Mathematics*, Vol 31, No. 1, pp. 1-28 (2017).
- [14] R. W. Kenyon, The Laplacian on planar graphs and graphs on surfaces. *arXiv preprint [arXiv:1203.1256](https://arxiv.org/abs/1203.1256)* (2012).
- [15] T. Lam, Electroid varieties and a compactification of the space of electrical networks. *Advances in mathematics*. Vol. 338, pp. 549-600 (2018).
- [16] T. Lam, Totally nonnegative Grassmannian and Grassmann polytopes, *Current developments in mathematics*, Vol. 2014 (2015).
- [17] G. Lusztig, Introduction to total positivity. *Positivity in Lie theory: open problems*, Vol. 26, pp. 133-145 (1998).
- [18] G. Muller, D. E. Speyer, The twist for positroid varieties. *Proceedings of the London Mathematical Society*, Vol. 115, No. 5, pp. 1014-1071 (2017).

- [19] A. Postnikov, Total positivity, Grassmannians, and networks. [arXiv:math/0609764](https://arxiv.org/abs/math/0609764).
- [20] J. S. Scott, Grassmannians and cluster algebras. *Proceedings of the London Mathematical Society*, Vol. 92, No. 2, pp. 345-380 (2006).
- [21] D. V. Talalaev, Vertex electrical model: Lagrangian and nonnegativity properties. *Theoretical and Mathematical Physics*, Vol. 210, No. 2, pp. 216-223 (2022).
- [22] K. Talaska, A formula for Plucker coordinates associated with a planar network. *Int. Math. Res. Not. IMRN*, Art. ID rnn 081, 19 pp (2008).
- [23] T. George, Inverse problem for electrical networks via twist. *arXiv preprint [arXiv:2305.10074](https://arxiv.org/abs/2305.10074)*. (2023).
- [24] G. Uhlmann, Commentary on Calderón's paper (29), on an inverse boundary value problem. *Selected papers of Alberto P. Calderón*, pp. 623-636 (2008).
- [25] G. Uhlmann, Electrical impedance tomography and Calderón's problem. *Inverse problems*, Vol. 25, No. 12, 123011 (2009).
- [26] A. M. Whitney, A reduction theorem for totally positive matrices. *Journal d'Analyse Mathématique*, Vol. 2, No. 1, pp. 88-92 (1952).

A. K.: LOMONOSOV MOSCOW STATE UNIVERSITY, FACULTY OF MECHANICS AND MATHEMATICS, RUSSIA, 119991, MOSCOW, GSP-1, 1 LENINSKIYE GORY, MAIN BUILDING; CENTRE OF INTEGRABLE SYSTEMS, P. G. DEMIDOV YAROSLAVL STATE UNIVERSITY, SOVETSKAYA 14, 150003, YAROSLAVL, RUSSIA; CENTER OF PURE MATHEMATICS, MOSCOW INSTITUTE OF PHYSICS AND TECHNOLOGY, 9 INSTITUTSKIY PER., DOLGOPRUDNY, MOSCOW REGION, 141701, RUSSIAN FEDERATION; KAZAN FEDERAL UNIVERSITY, N.I. LOBACHEVSKY INSTITUTE OF MATHEMATICS AND MECHANICS, KAZAN, 420008, RUSSIA; FACULTY OF MATHEMATICS, INTERNATIONAL LABORATORY OF CLUSTER GEOMETRY, NATIONAL RESEARCH UNIVERSITY HIGHER SCHOOL OF ECONOMICS, USACHEVA 6, 119048, MOSCOW, RUSSIA.

Email address: anton.kazakov.4@mail.ru