

An Overall Real-Time Mechanism for Classification and Quality Evaluation of Rice

Wanke Xia ^{1,+}, Ruxin Peng ^{1,+}, Haoqi Chu ², Xinlei Zhu ¹, Zhiyu Yang ¹, Yaojun Wang ^{1,*}

1 College of Information and Electrical Engineering, China Agricultural University, 17 Qinghua East Road, Haidian, Beijing 100083, China;

2 College of Land Science and Technology, China Agricultural University, 17 Qinghua East Road, Haidian, Beijing 100083, China;

+ These authors contributed equally to this work;

* Correspondence: wangyaojun@cau.edu.cn;

Abstract: Rice is one of the most widely cultivated crops globally and has been developed into numerous varieties. The quality of rice during cultivation is primarily determined by its cultivar and characteristics. Traditionally, rice classification and quality assessment rely on manual visual inspection, a process that is both time-consuming and prone to errors. However, with advancements in machine vision technology, automating rice classification and quality evaluation based on its cultivar and characteristics has become increasingly feasible, enhancing both accuracy and efficiency. This study proposes a real-time evaluation mechanism for comprehensive rice grain assessment, integrating a one-stage object detection approach, a deep convolutional neural network, and traditional machine learning techniques. The proposed framework enables rice variety identification, grain completeness grading, and grain chalkiness evaluation. The rice grain dataset used in this study comprises approximately 20,000 images from six widely cultivated rice varieties in China. Experimental results demonstrate that the proposed mechanism achieves a mean average precision (mAP) of 99.14% in the object detection task and an accuracy of 97.89% in the classification task. Furthermore, the framework attains an average accuracy of 97.56% in grain completeness grading within the same rice variety, contributing to an effective quality evaluation system.

Keywords: Rice; Object detection; Rice quality evaluation; Machine learning

1. Introduction

Rice is one of the most important crops worldwide and serves as a staple food for more than half of the global population. Its quality has a significant impact on dietary health. Additionally, the cultivar and characteristics of rice are key factors influencing its market value and selling price. Therefore, the ability to assess rice quality rapidly and accurately is of critical importance. Rice quality is determined by a wide range of indicators. For instance, type quality is a fundamental factor in assessing the nutritional value of rice, while processing quality further influences its market competitiveness based on type quality. Currently, manual sensory evaluation remains the most widely used method for rice quality assessment. However, this approach is susceptible to variations in lighting conditions, human eyesight, emotions, and other subjective factors, leading to slow identification speeds and an inability to meet the demands of rapid and objective evaluation.

As a widely applied technique in machine vision, deep learning enables automatic classification by leveraging large-scale labeled image datasets to train models for object detection and classification, thereby enhancing both efficiency and accuracy [1–4]. Moreover, deep learning plays a crucial role in quality assessment during rice production, representing a significant future direction for rice classification and identification [5]. However, studies utilizing machine learning algorithms for rice identification remain limited. Furthermore, the direct application of existing deep learning algorithms to

rice classification still presents room for improvement, indicating that challenges persist in algorithmic modeling that require further investigation and optimization.

To address the challenges identified in previous studies, this research proposes a real-time application model for rice classification and quality evaluation, aiming to achieve a comprehensive assessment of rice quality. Compared to existing deep learning models and training methods, the primary contributions of this study are as follows:

- **Enhanced Object Detection:** This study employs an improved one-stage object detection method to identify and analyze the distribution of rice types in mixed-species samples;
- **Improved Classification Accuracy:** An enhanced deep convolutional neural network is utilized to assess the completeness of six rice varieties, achieving a 2.0% increase in accuracy compared to traditional classification models;
- **Chalkiness Area Estimation:** The K-means clustering algorithm is applied to quantify the chalky area in rice grains, providing a precise measurement for quality evaluation.

2. Related Work

Traditionally, rice classification has been performed using human visual inspection, whereas the adoption of machine learning has significantly enhanced efficiency. Key quality indicators of rice include the broken rice rate, impurity rate, chalkiness, and color. Conventional quality evaluation methods rely on manual measurements using tools such as vernier calipers, which are subjective, time-consuming, inefficient, prone to errors, and labor-intensive [6]. Consequently, these methods are not well-suited for long-term quality testing.

With the rapid advancement of computer vision technology, machine learning has been increasingly applied to agriculture, leading to breakthroughs in crop detection [1,2,7]. Machine learning excels in efficiently analyzing and processing data, making it highly valuable for rice quality assessment. Several studies have demonstrated its effectiveness in this field. For example, Moses et al. [8] achieved single-class accuracies of 98.33%, 96.51%, 95.45%, 100%, 100%, 99.26%, and 98.72% for healthy, fully chalky, chalky discolored, semi-chalky, broken, discolored, and normal damage classes, respectively, attaining an overall classification accuracy of 98.37% using the EfficientNet-B0 architecture. Din et al. [9] developed the RiceNet model based on deep convolutional neural networks, using a dataset of over 4,700 images to classify five rice varieties, achieving an accuracy of 94%.

Lin et al. [10] proposed a machine vision system based on deep convolutional neural networks (DCNN) for rice classification, obtaining an accuracy of 95.5%. Zareiforush et al. [11] applied heuristic classification methods combined with computer vision to classify four rice types, achieving the highest classification accuracy of 98.72% using an artificial neural network topology. Kurtulmuş et al. [12] introduced a cost-effective method based on computer vision and machine learning, reporting an overall accuracy of 99.24% with the best predictive model. Li et al. [13] achieved 96.67% accuracy in distinguishing normal grains from the four most common types of damaged rice grains using computer vision and machine learning techniques.

Shi et al. [14] employed near-infrared spectroscopy and partial least squares regression (PLSR) for rice quality assessment. Similarly, Díaz et al. [15] utilized machine learning algorithms, including logistic regression and support vector machines, to analyze near-infrared spectra, developing a linear model for non-destructive rice taste classification with an accuracy of 94%. Yuan et al. [16] leveraged the YOLOv5s model to construct the WeedyRice5 object detection framework, integrating the CBAM attention mechanism and achieving a mean Average Precision (mAP) of 98.2% at an Intersection over Union (IoU) threshold of 0.5.

Makmuang et al. [17] applied an artificial neural network (ANN)-based classification method and utilized Self-Organizing Maps (SOM) to assess seed quality using hyperspectral imaging (HSI) data, obtaining a classification accuracy of 98%. Kang et al. [18] proposed a Multi-Scale Integrated Attention

(MSIA) block, integrating MSIA with classical convolutional neural networks (CNNs) to detect rice quality under varying storage conditions and humidity levels, achieving an accuracy of 99.69%.

In the field of rice quality evaluation, research utilizing computer vision in accordance with national or international standards remains limited. For instance, Zareiforush et al. [11] provided only a qualitative grading of rice quality without employing quantitative criteria for comprehensive quality assessment and classification. Similarly, Moses et al. [8] categorized full and semi-chalky rice but did not measure chalkiness based on national standards. In contrast, the mechanism proposed in this study is designed to address both rice type classification and quality evaluation through specifically developed algorithms and solutions. These include object detection-based anchoring for rice type identification, standardized completeness assessment, and precise area calculation for rice chalkiness, ensuring a more systematic and accurate evaluation approach.

3. Materials

3.1. Image Acquisition

In this study, we primarily collected an image dataset comprising six widely cultivated rice varieties in China, with their basic characteristics detailed in Table 1. Phenotypic images of individual rice grains were captured using an industrial camera, and each grain was manually annotated based on its completeness and chalkiness. The hardware setup for data acquisition included a Sony CMOS sensor (providing real-time imaging at 1920×1080P resolution), an AOSVI T2-HD228S body microscope, a Philips monitor, and other peripheral devices. The rice image acquisition process was conducted as follows: First, rice grains were evenly spread on a carrier table with a monochrome background. Next, optical parameters were adjusted to obtain clear, high-magnification images, after which the industrial camera was used to capture phenotypic images. Finally, the acquired images underwent manual screening and labeling to ensure data quality.

Following this procedure, we collected approximately 20,000 images of Chinese rice grains against a solid-color background. These images were manually filtered and labeled to construct a dataset for rice object detection and completeness assessment. To enhance the robustness of the model, each rice variety dataset included both intact and broken grains in a ratio of approximately 10:1. Additionally, to investigate the effect of varying optical conditions on rice chalkiness detection, we selected 10 grains from each rice variety and captured their images under five different lighting environments, yielding a total of 300 images dedicated to the rice chalkiness experiment.

Table 1. The basic information of each rice type.

| Rice Type | Abbreviation | Rice Variety | Length Range/mm | Width Range/mm | Phenotypes |
|-----------------------------|--------------|----------------|-----------------|----------------|---|
| Guangdong Simiao Rice | GD | Indica Rice | 6.74 | 1.74 | low or semi-opacity, slim figure |
| Northeastern Glutinous Rice | NM | Glutinous Rice | 4.45 | 2.86 | wax white color, high opacity, plump figure |
| Wuchang Rice | WC | Indica Rice | 6.63 | 2.44 | high opacity, plump figure |
| Panjin Crab Field Rice | PJX | Japonica Rice | 4.82 | 2.83 | high opacity, plump figure |
| Wannian Gong Rice | WN | Indica Rice | 6.81 | 2.20 | low or semi-opacity, slim figure |
| Yanbian Rice | YB | Japonica Rice | 4.59 | 2.62 | low or semi-opacity, plump figure |

3.2. Image Processing

3.2.1. Image Processing for One-Stage Mechanism

Some of the original rice images exhibited darker coloration, which obscured essential features such as translucency, chalkiness, contours, and other visual characteristics necessary for accurate observation. To enhance the visibility of these attributes, this study initially applied grayscale processing to the darker

rice images. The maximum and minimum pixel values were computed, and each pixel value was remapped to a range of 0 to 255 using a lookup table, effectively replacing the original pixel values. This processing step enhanced the overall clarity, improving contour definition and sharpness, as illustrated in Fig. 1. Subsequently, image brightness was adjusted to further emphasize fine details and enhance contrast. Taking Guangdong Simiao rice as an example, the final brightness-adjusted image is shown in Fig. 2(a), demonstrating a notable improvement in brightness and visibility compared to Fig. 1(a). This enhancement facilitates more precise human and computational analysis.

To simulate real-world conditions where multiple rice varieties may be intermixed, we employed a randomized mixing approach to construct a test dataset for rice identification. This dataset enables the evaluation of model accuracy in classifying rice varieties under practical scenarios.

In summary, the grayscale and brightness-adjusted rice images effectively highlight key visual features such as grain outline, internal texture, chalkiness, and translucency. These enhancements ensure that the images meet the requirements for classification and recognition tasks, making them suitable as input data for relevant deep learning models.

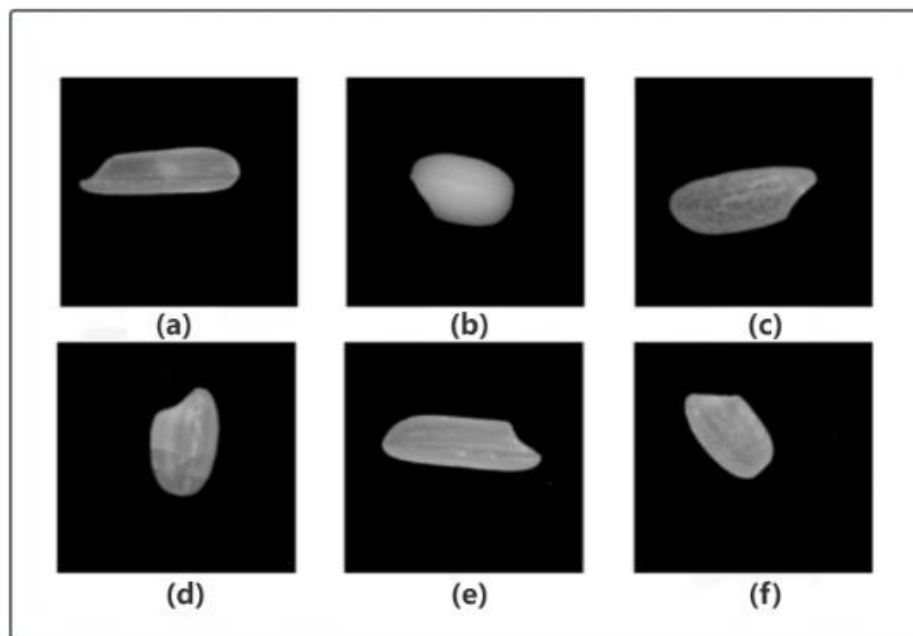

Figure 1. Six types of Chinese rice are sampled from a dataset after grayscale processing: (a) Guangdong Simiao Rice; (b) Northeastern Glutinous Rice; (c) Wuchang Rice; (d) Panjin Crab Field Rice; (e) Wannian Gong Rice; (f) Yanbian Rice.

3.2.2. Image Processing for Completeness Mechanism

For processing the broken rice image dataset, the same initial procedures outlined in Section 3.2.1 were applied using a one-stage method. In grading the completeness of rice grains, shape and contour features play a crucial role. Compared to grayscale images, binarized images more clearly delineate the shape and contours of rice grains, thereby improving the accuracy of subsequent classification algorithms. For instance, the preliminary binarized image of Guangdong Simiao rice, shown in Fig. 2(b), exhibits significantly more distinguishable geometric features than the original grayscale image in Fig. 1(a).

However, several small, unwanted white regions were present in the images. To simplify the dataset and retain only the significant and relevant areas, all white regions with a pixel area smaller than 40,000 were filled with black. Additionally, to enhance dataset quality, a median filtering algorithm was applied to remove edge noise, as illustrated in Fig. 2(c).

In summary, the rice images processed using the methods described in Section 3.2.1, followed by binarization and noise reduction techniques, exhibit enhanced shape and contour clarity. These improvements contribute to more effective subsequent quality evaluation of rice grains.

3.2.3. Image Processing for Chalk Mechanism

In studies that evaluate rice chalk using machine vision, accurate chalk discrimination requires determining a specific light intensity [19]. To investigate the impact of different light intensities on the recognition algorithm, this study established five distinct brightness levels. Using Guangdong Simiao rice as an example, Fig. 2(d) and Fig. 2(e) illustrate the results obtained at brightness levels 2 and 5, respectively.

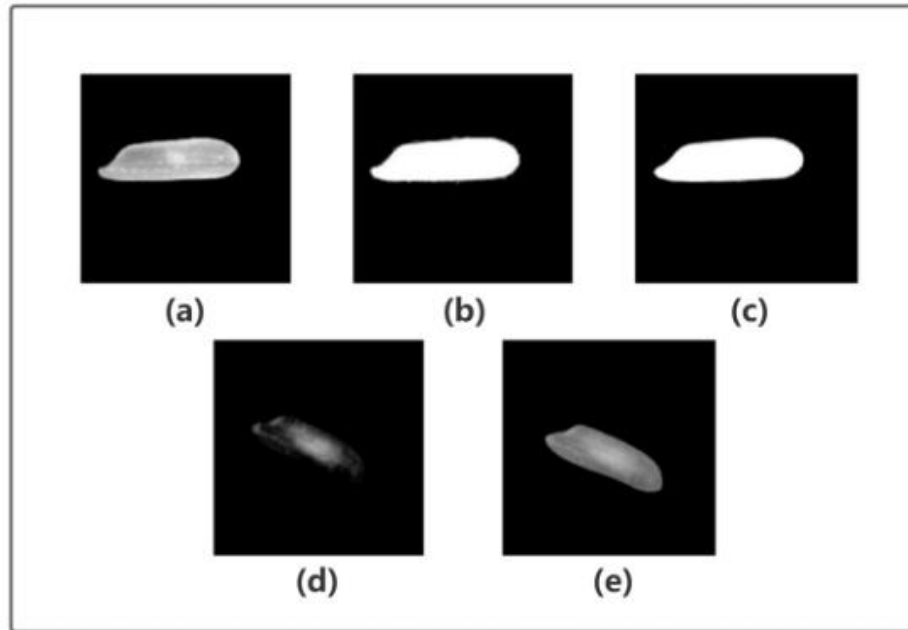

Figure 2. Example images in image processing: (a) an example image of Guangdong Simiao Rice after brightness enhancement; (b) an example image of Guangdong Simiao Rice after preliminary binarization processing; (c) an example image of Guangdong Simiao Rice after removing small domains and implementing median filtering; (d) an example image of Guangdong Simiao Rice after grayscale processing at the brightness of level 2 (which is a low brightness); (e) an example image of Guangdong Simiao Rice after grayscale processing at the brightness of level 5 (a high brightness).

4. Methods

This section elaborates on the functional components of the real-time mechanism designed for rice classification and quality evaluation. The proposed model first employs an improved one-stage object detection approach to accurately identify and distinguish multiple rice species in mixed samples. To assess the completeness of rice grains, a deep convolutional neural network (DCNN) is utilized, effectively differentiating intact grains from broken ones with enhanced precision. Additionally, the K-means clustering algorithm is applied to quantify the chalky area of rice grains, ensuring a more objective and reliable evaluation. The classification and grading criteria are established in accordance with China's National Quality Standard for Rice, providing a standardized framework for assessing rice completeness and chalk area, thereby enhancing the robustness and applicability of the proposed method.

4.1. The One-Stage Model for Object Detection Mechanism

A one-stage model performs object detection and classification in a single forward pass without generating candidate regions beforehand. In this context, the YOLO (You Only Look Once) series has emerged as a leading framework [20], significantly advancing real-time object detection with remarkable accuracy. Building upon this foundation, our research focuses on enhancing detection performance through targeted model improvements based on the YOLOv5 network framework.

The YOLOv5 network comprises three primary components: the backbone, the neck, and the head. The backbone is responsible for extracting feature representations from the input image, the neck further processes and fuses these features, and the head predicts bounding boxes, class probabilities, and objectness scores to assess object properties.

To enhance the accuracy and mean Average Precision (mAP) of the model, we integrated the SimAM module, an attention mechanism, into the backbone network (Fig. 3). Unlike conventional attention mechanisms that typically introduce additional parameters or complex computations to emphasize or suppress features, SimAM adopts a self-induced approach that optimizes an energy function to assess the importance of individual neurons. This method enables the derivation of an analytical solution for feature weighting without increasing the network's parameter count [21]. By replacing a C3 layer in the backbone with SimAM, we observed a significant improvement in both accuracy and mAP, demonstrating the effectiveness of this enhancement.

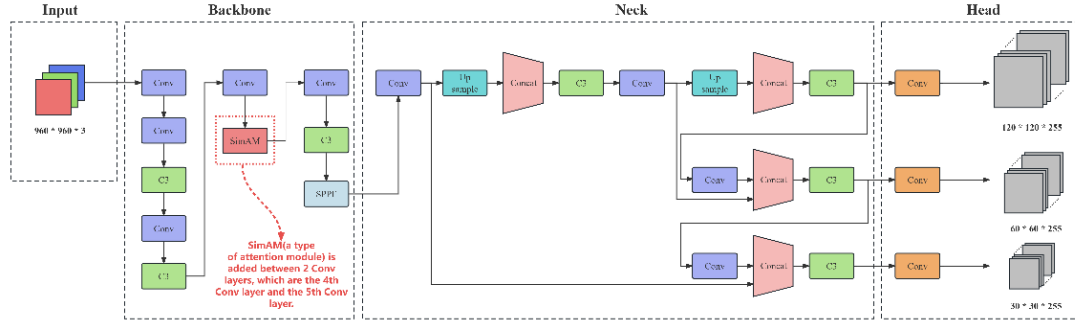

Figure 3. The general network of our improved YOLOv5.

4.2. The CNN Model for Completeness Mechanism

Deep Convolutional Neural Networks (CNNs) have become the dominant approach for visual classification tasks. Among them, ConvNeXt, introduced in 2022, has demonstrated exceptional performance across various classification scenarios [22]. Building upon this foundation, our research enhances the ConvNeXt network with algorithmic improvements specifically tailored for rice breakage recognition.

The core building block of the ConvNeXt network is the ConvNeXt module, which consists of multiple group convolution operations and transformation layers. By stacking multiple ConvNeXt modules, a deep neural network can be constructed to meet the complexity of the task. In this architecture, the output of the ConvNeXt module is connected to a global average pooling layer and fully connected layers, with classification ultimately performed using the softmax function.

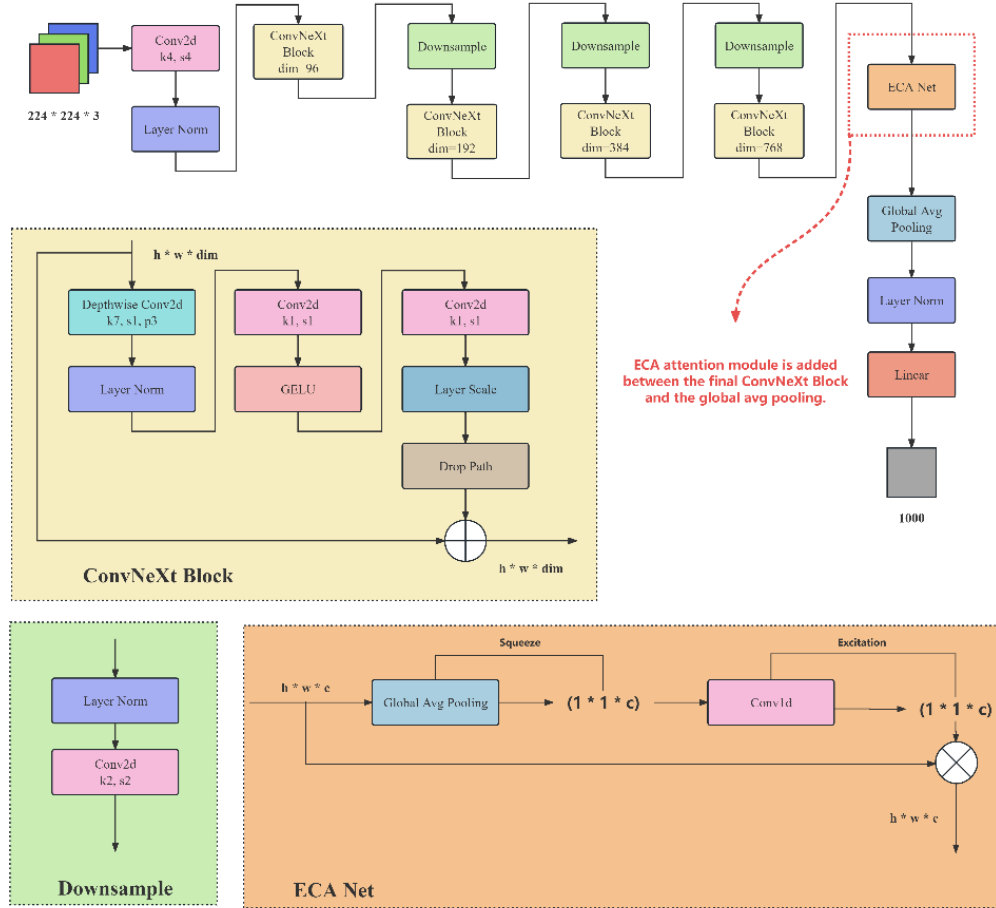

Figure 4. The general network of our improved ConvNeXt-Tiny.

To improve feature extraction and refine channel-wise attention, we modified the ConvNeXt-Tiny network by incorporating the Efficient Channel Attention (ECA) module between the final ConvNeXt Block and the global average pooling layer (Fig. 4). The ECA attention mechanism enhances the ability to capture inter-channel dependencies without significantly increasing computational complexity, thereby optimizing feature weighting across channels [23]. Additionally, to reduce training costs and develop a high-accuracy yet practical model, we initialized the network using pre-trained ConvNeXt-Tiny weights from ImageNet-1K.

The ECA module operates by computing attention weights independently for each feature map channel, without considering spatial relationships between pixels or regions. This approach allows it to efficiently capture critical channel-wise information while avoiding computationally expensive pairwise interactions, making it well-suited for enhancing rice breakage recognition.

4.3. The K-means Clustering Algorithm for Chalk Mechanism

The recognition of rice chalk involves segmenting chalky and non-chalky pixel areas within rice grains. The K-means algorithm, an iterative clustering technique, partitions data samples into K clusters by continuously updating cluster centroids. Samples within the same cluster exhibit high intra-cluster similarity, while those in different clusters demonstrate greater dissimilarity, thus facilitating effective data clustering.

In the chalk recognition process, the K-means algorithm is employed to assign image pixels to K cluster centers, enabling image segmentation. Within the segmented image, each pixel is classified according to its corresponding cluster center. By defining a category threshold, chalky areas are visualized in black, while non-chalky regions appear white, thereby achieving effective segmentation of chalk regions.

According to established rice chalk calculation methodologies, a minimum of 100 rice grains must be sampled to accurately assess the chalk content of a given batch. When handling large datasets, the K-means algorithm demonstrates lower time complexity compared to other segmentation techniques, often completing clustering tasks efficiently. Unlike density-based clustering methods such as the DBSCAN algorithm, K-means imposes fewer constraints on data distribution. Additionally, K-means allows for flexible adjustment of the number of clusters (K) to suit various segmentation requirements, whereas DBSCAN necessitates tuning parameters such as density thresholds and minimum sample counts, which must be optimized for different datasets to achieve optimal clustering performance.

4.4. The Quality Evaluation Standards of Rice

Table 2. Different varieties' general rice quality standards based on GB/T 1354-2018 Rice.

| Rice Variety | Evaluated Level | Broken Rice Rate | Small Broken Rice Rate | Chalk Rate | Admixture Rate |
|--|-----------------|------------------|------------------------|------------|----------------|
| Indica Rice | 1 | ≤15.0% | ≤1.0% | ≤2.0% | ≤5.0% |
| | 2 | ≤20.0% | ≤1.5% | ≤5.0% | |
| | 3 | ≤30.0% | ≤2.0% | ≤8.0% | |
| Japonica Rice | 1 | ≤10.0% | ≤1.0% | ≤2.0% | ≤5.0% |
| | 2 | ≤15.0% | ≤1.5% | ≤4.0% | |
| | 3 | ≤20.0% | ≤2.0% | ≤6.0% | |
| Glutinous rice from Japonica rice branch | 1 | ≤10.0% | ≤1.5% | / | ≤5.0% |
| | 2 | ≤15.0% | ≤2.0% | | |
| Glutinous rice from Indica rice branch | 1 | ≤15.0% | ≤2.0% | / | ≤5.0% |
| | 2 | ≤25.0% | ≤2.5% | | |

In the rice quality evaluation task, we primarily adhere to the Chinese national standard GB/T 1354-2018 Rice as the assessment benchmark [24]. Our study conducts an in-depth analysis of key quality indicators, including chalkiness, broken rice rate, and admixture rate. Rice is generally classified into indica rice, japonica rice, and glutinous rice, each with distinct quality evaluation criteria. The corresponding quality indicators for these rice varieties are detailed in Table 2.

4.4.1. The Standard of Rice Completeness

According to the classification criteria outlined in the Chinese National Standard GB/T 1354-2018 Rice, whole grains are defined as rice grains that remain intact in all parts except the embryo. Broken rice, on the other hand, refers to rice grains that are incomplete and have a length less than three-quarters of the average length of whole grains from the same batch, as retained on a 1.0 mm round-hole sieve. Within the category of broken rice, sizeable broken rice includes incomplete grains with a length less than three-quarters of the average length of whole grains from the same batch but retained on a 2.0 mm round-hole sieve. Tiny broken rice refers to fragments that pass through a 2.0 mm round-hole sieve but are retained on a 1.0 mm round-hole sieve.

To facilitate a more detailed analysis and assessment of broken rice in rice samples, we classified the rice into three categories based on the degree of completeness as defined by the standard: whole grains (with a length not less than three-quarters of the average length of whole grains from the same batch), sizeable broken rice, and tiny broken rice. Subsequently, the rice samples were labeled according to the identification criteria specified in the standard document.

For experimental validation, we used a sample of no less than 10 g of rice and conducted broken rice classification tests. The ratio of sizeable broken rice to tiny broken rice was calculated following the method prescribed in the standard, as described by Equation (1).

$$X_1 = \frac{m_1}{m} \times 100\% \quad (1)$$

In the Equation (1), X_1 represents the broken rice rate. m_1 is the mass of broken rice in grams (g). m is the mass of the sample in grams (g).

Referring to the calculation method for rice's broken rice rate in the standard document, we calculate it using Equation (2).

$$X_2 = \frac{m_2}{m} \times 100\% \quad (2)$$

In the Equation (2), X_2 represents the broken rice rate. m_2 is the mass of broken rice, where broken rice includes the mass of sizeable and small broken rice, measured in grams (g). m is the mass of the sample in grams (g).

4.4.2. The Standard of Rice Chalk

According to the detection method for rice chalk specified in the Chinese National Standard GB/T 1354-2018 Rice, the procedure begins by selecting 100 intact rice grains (n_0) from the suspended rice sample. From this selection, the chalky rice grains (n_1) are identified and separated. Subsequently, ten chalky rice grains are randomly selected from this group for further analysis. These selected grains are placed flat and observed from the front to visually assess the chalky projection area as a percentage of the total projection area of the intact rice grains. The average of these percentages is then calculated to quantify the degree of chalkiness. The chalk content is calculated using Equation (3), and the result is expressed as a percentage (%).

$$D = W_D \times \frac{n_1}{n_0} \quad (3)$$

In the Equation (3), D represents chalkiness, expressed in percentage (%). W_D represents the chalky size, also in percentage (%). n_1 is the number of chalky rice grains in the sample, and n_0 is the total number of rice grains in the sample.

5. Experiments and Results

This section focuses on real-time rice detection experiments and quality evaluation studies. The first subsection details the methodology and outcomes of conducting one-stage object detection experiments on a dataset of rice images containing a mixture of multiple rice varieties. These images are derived from six widely cultivated rice varieties in China. The second subsection presents the experimental process and results of employing deep convolutional neural network (CNN) models to classify rice grains based on their degree of completeness. The dataset used for this task includes rice grains categorized into three classes: severely damaged, slightly damaged, and undamaged. The third subsection describes the implementation of a rice chalk evaluation experiment using the K-means clustering algorithm. All experiments were conducted on a high-performance computing system equipped with an AMD EPYC 7543 32-core processor, an Nvidia RTX 3090 graphics card, and the Linux Ubuntu 20.04 LTS operating system.

5.1. Object Detection Experiment

This study utilized the construction method described in Section 4.1 to develop a one-stage model for rice object detection. Following this, the model was employed to classify and detect various rice types. The confusion matrix of the improved model on the validation set is presented in Fig. 5. The results indicate that the model achieved a precision rate of 1.0 for the GD, NM, and YB categories. In contrast, performance for WC, WN, and PJX categories was slightly lower but remained consistently above 0.95, demonstrating favorable overall outcomes.

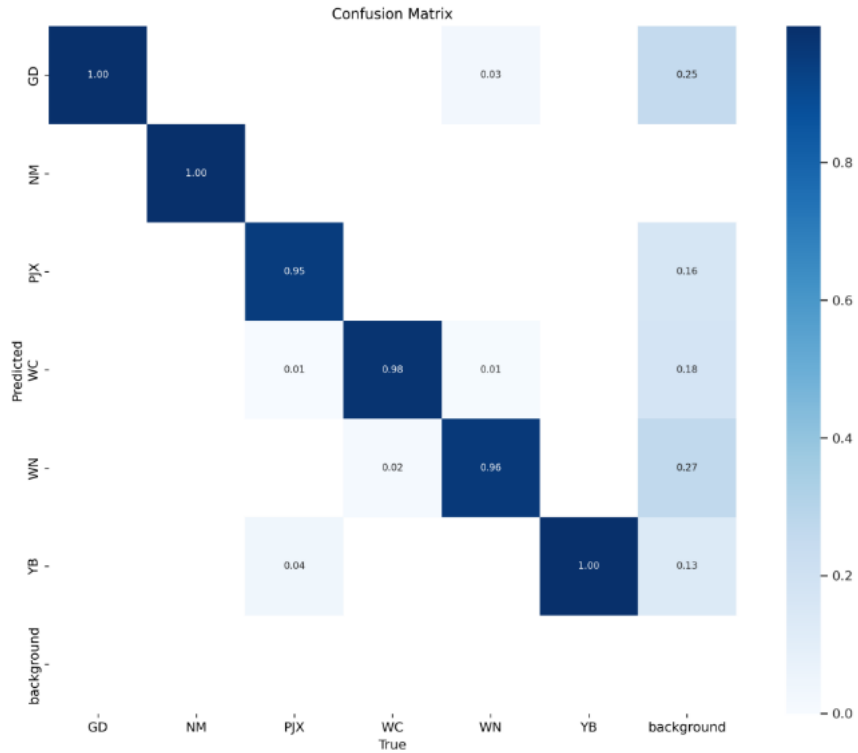

Figure 5. The confusion matrix of our improved model on the validation set.

The model's performance on the test set is illustrated in Fig. 6. A cluster of NM instances is intricately interwoven with a sparse presence of GD. The one-stage model was applied for object detection, producing the visual representation shown. The results clearly demonstrate that the anchor boxes accurately and distinctly identify both NM and the interspersed GD, achieving commendable recognition performance.

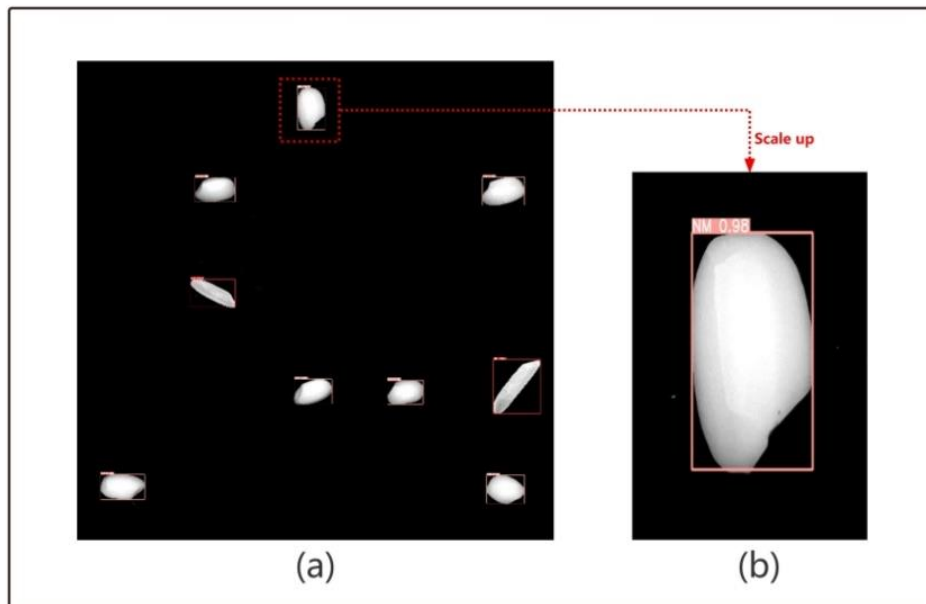

Figure 6. The visual representation of object detection results on the test set is presented, wherein pink boxes denote NM instances, and red boxes signify GD instances. The upper-left corner of each box indicates the associated category and confidence level.

As shown in Table 3, a comparative analysis was conducted between two models—the improved

version and its predecessor—to identify the optimal model for real-world applications involving multiple rice grains. The results highlight the significant advantages of the improved model over its predecessor. Notably, the enhanced model achieves superior validation accuracy (97.94% vs. 97.54%) and validation mean average precision (98.76% vs. 99.14%). Moreover, on the test set, the improved model demonstrates an elevated accuracy of 97.89%, significantly outperforming the original model's accuracy of 95.05%. These results collectively affirm the improved model's superior precision and object detection capabilities in practical scenarios, establishing it as a more reliable and effective solution compared to its predecessor.

Table 3. The accuracy and mAP results of the Improved Model in our research, compared with the Original Model without SimAM.

| Model | Val Accuracy | Val mAP | Test Accuracy |
|----------------|--------------|---------|---------------|
| Original Model | 97.54% | 99.14% | 95.05% |
| Improved Model | 97.94% | 98.76% | 97.89% |

5.2. Completeness Experiment

Following the object detection task described in Section 5.1, the mechanism was further employed to classify and detect rice grains into three categories: whole grains, large broken grains, and small broken grains, providing a comprehensive analysis of rice grain quality. To achieve optimal results with a relatively small number of parameters, two pre-trained ConvNeXt models—ConvNeXt-Tiny and ConvNeXt-Small—were evaluated. Based on the average accuracy across the training and validation datasets, ConvNeXt-Tiny demonstrated superior performance compared to ConvNeXt-Small, leading to its selection as the backbone model for the completeness experiment.

As shown in Table 4, the improved ConvNeXt-Tiny model achieved outstanding classification performance in identifying the three rice completeness grades, with an average accuracy improvement of nearly 2%. Notably, significant increases in validation accuracy were observed for Guangdong Simiao rice and Wuchang rice. The validation accuracy for Guangdong Simiao rice improved from 88.65% to 98.80%, while Wuchang rice increased from 95.44% to 96.10%.

Table 4. The validation accuracy of our improved and original ConvNeXt-Tiny models.

| Model | Average | GD | NM | PJX | WC | WN | YB |
|-------------------------------|---------|--------|--------|--------|--------|--------|--------|
| Our model (improved with ECA) | 97.61% | 98.80% | 96.35% | 98.80% | 96.10% | 95.92% | 99.68% |
| ConvNeXt-Tiny | 95.58% | 88.65% | 96.35% | 98.28% | 95.44% | 95.37% | 99.41% |

5.3. Chalk Experiment

Chalk refers to the white, opaque portion in the rice endosperm, resulting from reduced translucency caused by gaps between endosperm starch granules. It serves as a key indicator of rice quality and appearance, commonly used in rice production and quality control processes. According to the Chinese National Standard GB/T 1354-2018 Rice, rice grains with a chalk content of greater than or equal to 2.0% are classified as first-grade premium rice. This implies that lower chalkiness correlates with higher rice quality. To improve the efficiency of rice production and quality control while minimizing subjectivity and human errors, this study applies artificial intelligence algorithms to analyze features such as brightness, color distribution, and translucency in rice sample images, enabling automated chalk assessment. Rice images were collected under five different luminance intensities using the same light source, then converted to grayscale for processing. The K-means algorithm was employed to cluster the images, and by setting a category threshold, chalky regions were segmented, appearing black while non-chalky areas appeared white. To accurately determine the chalky area, a geometric polygon fitting method was used to estimate the segmented regions' area. The formula for calculating chalky areas is detailed in Section 4.4.2.

As shown in Fig. 7, the size of the chalky regions increases with higher luminance intensities. Manual comparisons revealed that the chalky area's ratio to the total rice area in images captured under

luminance level one closely aligns with human visual assessments. Thus, luminance level one was selected as the standard luminance for this experiment. Compared to the manual visual assessment method prescribed in GB/T 1354-2018 Rice, this automated approach is not only more precise but also significantly faster.

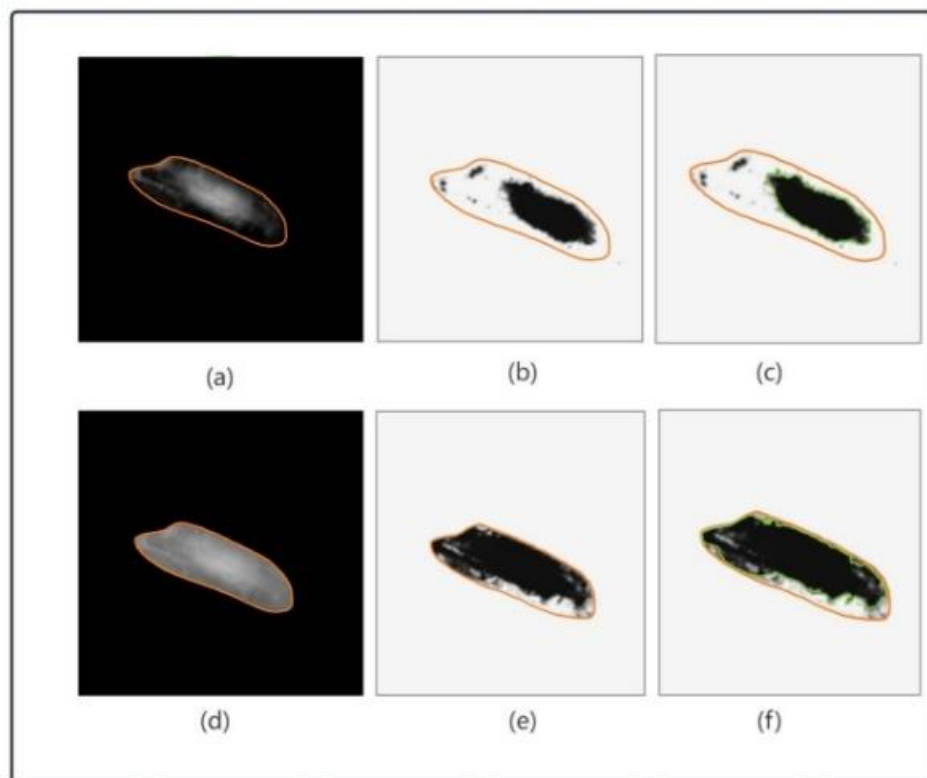

Figure 7. The processed images in the chalk mechanism of Guangdong Simiao Rice using the K-means algorithm: (a) an original image at the brightness of level 2; (b) an image at the brightness of level 2 processed by the K-means algorithm; (c) shows the theoretical area in chalk calculation surrounded by a yellow border; (d) an original image at the brightness of level 5; (e) an image at the brightness of level 5 processed by the K-means algorithm; (f) shows the theoretical area in chalk calculation surrounded by a yellow border.

6. Discussion

6.1. Comparisons of Other Methods in the Object Detection Mechanism

In practical experiments on rice recognition, we conducted a comparative analysis between the one-stage model employed in this study and various two-stage models to highlight the superiority of the proposed one-stage model in object detection and classification. The test set accuracy for each method is presented in Table 5.

The results in Table 5 indicate that two-stage models, when applied to both single-grain rice datasets and mixed-grain scenarios, fail to achieve high accuracy on the test set. Additionally, the one-stage model consistently outperforms the two-stage models in terms of recognition speed, making it better suited to the practical requirements of real-world applications.

Table 5. The accuracy results of one-stage object detection in our research, compared with those of other two-stage methods.

| Model | Test Accuracy |
|--|---------------|
| Our improved model (Yolov5 with SimAM) | 97.89% |
| Faster-Rcnn (two-stage) | 87.33% |
| Tridentnet (two-stage) | 93.69% |

During practical rice classification experiments, we conducted a comparative analysis between our proposed one-stage model and several classical classification models, including AlexNet, GoogLeNet, MobileNet v2, ResNet, and ConvNeXt. The objective was to demonstrate the superiority of our primary model in both object detection and classification tasks. The training and testing accuracies of the various methods are summarized in Table 6.

As shown in Table 6, traditional convolutional models offer the dual advantages of a compact network structure and high accuracy. These findings provide valuable insights for future research, particularly the potential to enhance the YOLO series by integrating traditional convolutional modules into their classification components. Such modifications could effectively reduce network size, thereby enabling deployment on resource-constrained hardware platforms such as the Raspberry Pi. This optimization holds significant promise for achieving large-scale and efficient rice object detection applications.

Table 6. The accuracy results of one-stage object detection in our research, compared with those of other classical classification methods.

| Methods | Train Accuracy | Test Accuracy |
|--|----------------|---------------|
| Our improved model (Yolov5 with SimAM) | 97.94% | 97.89% |
| Googlenet | 99.73% | 99.07% |
| Alexnet | 97.97% | 99.13% |
| Mobilenet v2 | 98.72% | 99.07% |
| Resnet101 | 98.46% | 96.89% |
| ConvNeXt Tiny | 99.96% | 98.85% |

6.2. Comparisons of Other Methods in the Completeness Mechanism

We initially collected data for three categories of rice: whole rice, sizeable broken rice, and tiny broken rice. The dataset included measurements of their short axis, long axis, and area. The data quantity for each category was varied, resulting in an approximate ratio of 2:1:1. Based on the definitions of broken rice outlined in GB/T 1354-2018 Rice, we utilized machine learning algorithms, including decision trees, random forests, and support vector machines (SVM), to classify and grade broken rice.

However, as shown in Table 7, a comparison between ConvNeXt and these traditional machine learning algorithms reveals that ConvNeXt significantly outperforms them in terms of accuracy.

Table 7. Comparisons of the accuracy of various classification methods, including decision tree, random forest, supported vector machine (SVM), Googlenet, Alexnet, Mobilenet, Resnet 101, and our improved ConvNeXt model.

| Model | Average Accuracy | GD | NM | PJX | WC | WN | YB |
|-----------------------------|------------------|--------|--------|--------|--------|--------|--------|
| Decision Tree | 93.72% | 85.47% | 92.42% | 97.56% | 95.13% | 95.13% | 96.59% |
| Random Forest | 94.27% | 87.60% | 93.68% | 97.88% | 95.03% | 94.84% | 96.60% |
| SVM | 91.82% | 87.75% | 87.50% | 97.72% | 91.30% | 91.30% | 95.35% |
| Googlenet | 89.24% | 82.60% | 95.65% | 95.00% | 95.23% | 86.95% | 80.00% |
| Alexnet | 94.90% | 89.36% | 95.74% | 97.62% | 97.73% | 91.30% | 97.62% |
| Mobilenet-v2 | 90.45% | 78.72% | 91.49% | 92.86% | 95.45% | 91.30% | 92.86% |
| Resnet101 | 85.19% | 80.85% | 74.47% | 90.00% | 84.09% | 91.30% | 90.48% |
| Our improved ConvNeXt model | 97.61% | 98.80% | 96.35% | 98.80% | 96.10% | 95.92% | 99.68% |

7. Conclusions

The mechanism proposed in this study demonstrates the capability to accurately identify rice varieties and perform quality analyses, particularly regarding rice completeness and chalkiness. The overall rice processing framework consists of three primary steps. In the first step, a one-stage object detection method is implemented to enable real-time visualization of rice positions and classification information, achieving an accuracy of 97.89% and a mean average precision (mAP) of 99.14%. The second step employs a convolutional neural network (CNN) to evaluate the grade of broken rice within the same category, yielding an average accuracy exceeding 97%. In the third step, clustering algorithms are applied to accurately extract the chalky regions of whole rice and calculate precise chalkiness measurements.

This mechanism integrates multiple advanced techniques, including object detection, deep learning using CNNs, and clustering, to deliver an efficient and accurate comprehensive analysis of rice quality. Despite its strengths, the study has areas for improvement. For instance, testing the mechanism with a broader range of rice varieties is a priority for future research. Additionally, further evaluation of the model's lightweight design and effectiveness on actual hardware is essential to develop a practical quality detection device for real-world applications [25].

References

1. Wang, R.-F.; Su, W.-H. The Application of Deep Learning in the Whole Potato Production Chain: A Comprehensive Review. *Agriculture* **2024**, *14*, 1225, doi:10.3390/agriculture14081225.
2. Chang-Tao, Z.; Rui-Feng, W.; Yu-Hao, T.; Xiao-Xu, P.; Wen-Hao, S. Automatic Lettuce Weed Detection and Classification Based on Optimized Convolutional Neural Networks for Robotic Weed Control. *Agronomy* **2024**, 2838.
3. Cui, K.; Tang, W.; Zhu, R.; Wang, M.; Larsen, G.D.; Pauca, V.P.; Alqahtani, S.; Yang, F.; Segurado, D.; Fine, P.; et al. Real-Time Localization and Bimodal Point Pattern Analysis of Palms Using UAV Imagery. *ArXiv Prepr. ArXiv241011124* **2024**.
4. Cui, K.; Li, R.; Polk, S.L.; Lin, Y.; Zhang, H.; Murphy, J.M.; Plemmons, R.J.; Chan, R.H. Superpixel-Based and Spatially-Regularized Diffusion Learning for Unsupervised Hyperspectral Image Clustering. *IEEE Trans. Geosci. Remote Sens.* **2024**.
5. Wang, Z.; Wang, R.; Wang, M.; Lai, T.; Zhang, M. Self-Supervised Transformer-Based Pre-Training Method with General Plant Infection Dataset. In Proceedings of the Pattern Recognition and Computer Vision; Lin, Z., Cheng, M.-M., He, R., Ubul, K., Silamu, W., Zha, H., Zhou, J., Liu, C.-L., Eds.; Springer Nature Singapore: Singapore, 2025; pp. 189–202.
6. Chen, C.; Lu, J.; Zhou, M.; Yi, J.; Liao, M.; Gao, Z. A YOLOv3-Based Computer Vision System for Identification of Tea Buds and the Picking Point. *Comput. Electron. Agric.* **2022**, *198*, 107116.
7. Robert Singh, K.; Chaudhury, S. A Cascade Network for the Classification of Rice Grain Based on Single Rice Kernel. *Complex Intell. Syst.* **2020**, *6*, 321–334.
8. Moses, K.; Miglani, A.; Kankar, P.K.; others Deep CNN-Based Damage Classification of Milled Rice Grains Using a High-Magnification Image Dataset. *Comput. Electron. Agric.* **2022**, *195*, 106811.
9. Din, N.M.U.; Assad, A.; Dar, R.A.; Rasool, M.; Sabha, S.U.; Majeed, T.; Islam, Z.U.; Gulzar, W.; Yaseen, A. RiceNet: A Deep Convolutional Neural Network Approach for Classification of Rice Varieties. *Expert Syst. Appl.* **2024**, *235*, 121214.
10. Lin, P.; Li, X.; Chen, Y.; He, Y. A Deep Convolutional Neural Network Architecture for Boosting Image Discrimination Accuracy of Rice Species. *Food Bioprocess Technol.* **2018**, *11*, 765–773.
11. Zareiforoush, H.; Minaei, S.; Alizadeh, M.R.; Banakar, A. Qualitative Classification of Milled Rice Grains Using Computer Vision and Metaheuristic Techniques. *J. Food Sci. Technol.* **2016**, *53*, 118–131.
12. Kurtulmuş, F.; Ünal, H. Discriminating Rapeseed Varieties Using Computer Vision and Machine Learning. *Expert Syst. Appl.* **2015**, *42*, 1880–1891.
13. Li, X.; Dai, B.; Sun, H.; Li, W. Corn Classification System Based on Computer Vision. *Symmetry* **2019**, *11*, 591.
14. Shi, S.; Zhang, W.; Ma, Y.; Cao, C.; Zhang, G.; Jiang, Y. Near-Infrared Spectroscopy Combined with Effective Variable Selection Algorithm for Rapid Detection of Rice Taste Quality. *Biosyst. Eng.* **2024**, *237*, 214–219.
15. Díaz, E.O.; Iino, H.; Koyama, K.; Kawamura, S.; Koseki, S.; Lyu, S. Non-Destructive Quality Classification of Rice Taste Properties Based on near-Infrared Spectroscopy and Machine Learning Algorithms. *Food Chem.* **2023**, *429*, 136907.

16. Yuan, C.; Liu, T.; Gao, F.; Zhang, R.; Seng, X. YOLOv5s-CBAM-DMLHead: A Lightweight Identification Algorithm for Weedy Rice (*Oryza Sativa f. Spontanea*) Based on Improved YOLOv5. *Crop Prot.* **2023**, *172*, 106342.
17. Makmuang, S.; Terdwongworakul, A.; Vilaivan, T.; Maher, S.; Ekgasit, S.; Wongravee, K. Mapping Hyperspectral NIR Images Using Supervised Self-Organizing Maps: Discrimination of Weedy Rice Seeds. *Microchem. J.* **2023**, *190*, 108599.
18. Kang, S.; Zhang, Q.; Wei, H.; Shi, Y. An Efficient Multiscale Integrated Attention Method Combined with Hyperspectral System to Identify the Quality of Rice with Different Storage Periods and Humidity. *Comput. Electron. Agric.* **2023**, *213*, 108259.
19. Hu, Y.; Zhang, Z. GridFree: A Python Package of Imageanalysis for Interactive Grain Counting and Measuring. *Plant Physiol.* **2021**, *186*, 2239–2252.
20. Jocher, G.; Stoken, A.; Borovec, J.; Changyu, L.; Hogan, A.; Diaconu, L.; Ingham, F.; Poznanski, J.; Fang, J.; Yu, L.; et al. Ultralytics/Yolov5: V3. 1-Bug Fixes and Performance Improvements. *Zenodo* **2020**.
21. Yang, L.; Zhang, R.-Y.; Li, L.; Xie, X. Simam: A Simple, Parameter-Free Attention Module for Convolutional Neural Networks. In Proceedings of the International conference on machine learning; PMLR, 2021; pp. 11863–11874.
22. Liu, Z.; Mao, H.; Wu, C.-Y.; Feichtenhofer, C.; Darrell, T.; Xie, S. A Convnet for the 2020s. In Proceedings of the Proceedings of the IEEE/CVF conference on computer vision and pattern recognition; 2022; pp. 11976–11986.
23. Wang, Q.; Wu, B.; Zhu, P.; Li, P.; Zuo, W.; Hu, Q. ECA-Net: Efficient Channel Attention for Deep Convolutional Neural Networks. In Proceedings of the Proceedings of the IEEE/CVF conference on computer vision and pattern recognition; 2020; pp. 11534–11542.
24. Regulation, S.A.f.M., 2018. GB/T 1354-2018 Rice.
25. Hu, M.; Li, Z.; Yu, J.; Wan, X.; Tan, H.; Lin, Z. Efficient-Lightweight Yolo: Improving Small Object Detection in Yolo for Aerial Images. *Sensors* **2023**, *23*, 6423.