

# ROSMonitoring 2.0: Extending ROS Runtime Verification to Services and Ordered Topics

Maryam Ghaffari Saadat

University of Manchester  
Manchester, United Kingdom  
maryam.ghaffarisaadat@manchester.ac.uk

Angelo Ferrando

University of Modena and Reggio Emilia  
Modena, Italy  
angelo.ferrando@unimore.it

Louise A. Dennis

University of Manchester  
Manchester, United Kingdom  
louise.dennis@manchester.ac.uk

Michael Fisher

University of Manchester  
Manchester, United Kingdom  
michael.fisher@manchester.ac.uk

Formal verification of robotic applications presents challenges due to their hybrid nature and distributed architecture. This paper introduces ROSMonitoring 2.0, an extension of ROSMonitoring designed to facilitate the monitoring of both topics and services while considering the order in which messages are published and received. The framework has been enhanced to support these novel features for ROS1 – and partially ROS2 environments – offering improved real-time support, security, scalability, and interoperability. We discuss the modifications made to accommodate these advancements and present results obtained from a case study involving the runtime monitoring of specific components of a fire-fighting Uncrewed Aerial Vehicle (UAV).

## 1 Introduction

The formal verification of robotic applications is a challenging task. Due to their heterogeneous and component-based nature, establishing the correctness of robotic systems can be particularly difficult. Various approaches exist to tackle this problem, ranging from testing methods [8, 21, 9] to static [16, 14] or dynamic [19, 15] formal verification. In this work, we focus on the latter approach to verification, specifically the extension of ROSMonitoring [15], a Runtime Verification (RV) framework developed for monitoring robotic systems deployed in the Robot Operating System (ROS) [2]. ROS is widely used, providing a *de facto* standard for robotic components. ROS encourages component-based development of robotic systems where individual components run in parallel, may be distributed across several processors, and communicate via messages. We tackle ROSMonitoring because it is a novel, formalism-agnostic, and widely used framework for the runtime monitoring of ROS applications. ROSMonitoring allows the specification of formal properties externally to ROS, without imposing any constraints on the formalism to be used. The properties that can typically be monitored in ROSMonitoring concern messages exchanged between different ROS components, called nodes. Such message communication is achieved through a publish-subscribe mechanism, where some nodes (referred to as *publishers*) publish messages on a topic and other nodes (referred to as *subscribers*) subscribe to these topics to listen for the published messages. Through ROSMonitoring, it is possible to specify the communication flow on such topics. For instance, one can determine which messages are allowed in the current state of the system, the correct order amongst them, and other relevant criteria.

Unfortunately, not all aspects of verifying ROS applications are based solely on message communication. In fact, when developing ROS systems, other communication mechanisms can also be utilised,

such as *services*. Unlike the publish-subscribe mechanism used with topics, services provide a way for nodes in ROS to directly offer functionalities to each other. While topics are typically used to transmit data from sensors, services serve as an interface that enables nodes to offer specific functionalities to others within the ROS system. Unlike topics, services are commonly synchronous, meaning that when a node calls a service, it waits for a response from the receiving node. This is in contrast to topics, where subscription is non-blocking, and the subscriber node is simply notified whenever a new message is published on the topic, without any waiting involved. Services are not supported in ROSMonitoring, restricting the framework's functionality to solely monitoring messages.

Another current limitation of ROSMonitoring pertains to the handling of message order. The framework orders messages based on the chronological order in which they are received by subscriber nodes. However, this approach only considers the viewpoint of subscribers, which may not always be suitable. In some scenarios, it may be necessary to consider the order of messages based on when they were sent. For instance, if one message was sent before another, the former should be analysed before the latter by the monitor, appearing earlier in the resulting trace of events. Unfortunately, ROSMonitoring does not currently provide a representation of the order in which messages are published and received. Generally, messages on a single topic are received by subscribers in the order they were published. However, if a property needs to monitor several topics, then it is unusual for the messages from more than one topic to be received in the order they were published. Reordering messages according to publication time is necessary if checking conditional actions that respond to specific event patterns.

In this paper, we introduce ROSMonitoring 2.0, an extension of ROSMonitoring designed to facilitate the monitoring of both topics and services while also considering the order in which messages are published and received. The framework has been enhanced to support these novel features for ROS. Some of these features, *i.e.*, service monitoring, have also been ported to ROS2<sup>1</sup> environment as well. We discuss the modifications made to accommodate these advancements and present results obtained from a case study involving the runtime monitoring of specific components of a fire-fighting Uncrewed Aerial Vehicle (UAV).

## 2 Preliminaries

In this section, we briefly introduce Runtime Verification and the ROSMonitoring framework. We emphasise the primary distinction between RV and static verification techniques. Additionally, we provide an overview of the ROSMonitoring framework and briefly outline its main features.

### 2.1 Runtime Verification

Runtime Verification (RV) is a lightweight formal verification technique that checks the behaviour of a system while it is running [23]. Unlike model checking, RV does not suffer from the state space explosion problem typical in static verification methods and is therefore much more scalable [11]. RV is particularly suitable for robotic applications due to resource limitations and system complexity that make full verification at design-time challenging. While static verification techniques focus on abstracting system components, RV checks system behaviour directly. RV addresses the word inclusion problem [5], determining if a given event trace belongs to the set of traces denoted by a formal property (referred to as the property's language). This verification process is polynomial in time relative to the trace length. In

---

<sup>1</sup>ROS2 is the upgraded version of ROS1, providing improved real-time support, security, scalability, and enhanced interoperability with multiple communication middleware options.

contrast, model checking exhaustively verifies if a system satisfies or violates a property by analysing all possible system executions, tackling the language inclusion problem, and is typically PSPACE-complete for non-deterministic finite automata [31]. RV commonly employs runtime monitors, automatically synthesised from formal properties, often expressed using Linear-time Temporal Logic (LTL) [28]. These monitors gather information from system execution traces and conclude whether the system satisfies or violates the property. A monitor returns  $\top$  if the trace satisfies the property,  $\perp$  if it violates it, and  $?$  if there is insufficient information. Depending on the property’s formalism,  $?$  may further split into  $?_{\top}$  or  $?_{\perp}$  indicating partial satisfaction or partial violation, respectively.

## 2.2 ROSMonitoring

ROSMonitoring [15] is a framework for performing RV on ROS applications. ROSMonitoring allows the user to add monitors to ROS applications, which intercept the messages exchanged between components, called “ROS nodes”<sup>2</sup>, and check whether the relevant messages conform to a given formal property. In the following we describe these three different aspects in more detail.

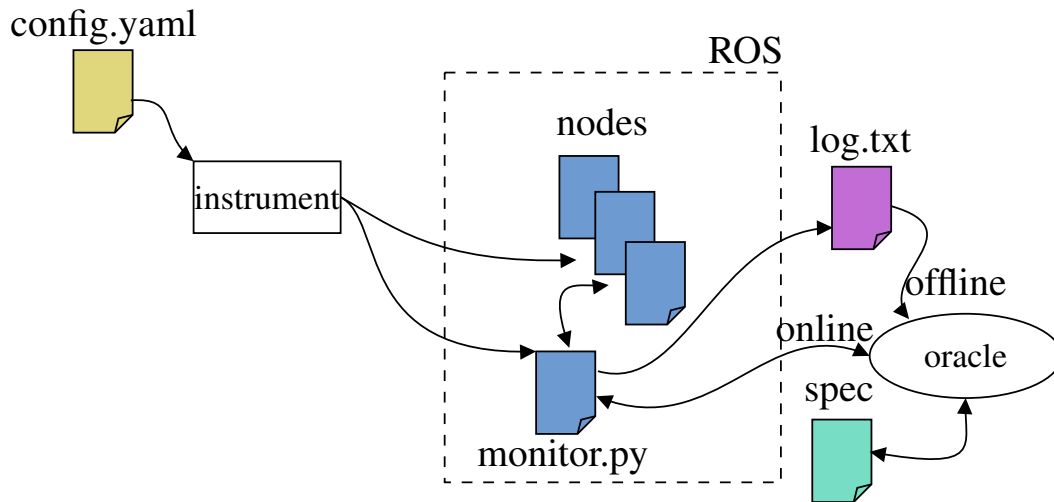

Figure 1: High-level overview of ROSMonitoring [15].

### 2.2.1 Instrumentation

ROSMonitoring starts with a YAML configuration file to guide the instrumentation process required to generate the monitors. Within this file, the user can specify the communication channels, called “ROS topics”, to be intercepted by each monitor. In particular, the user indicates the name of the topic, the ROS message type expected in that topic, and the type of action that the monitor should perform. After preferences have been configured in *config.yaml*, the last step is to run the generator script to automatically generate the monitors and instrument the required ROS launch files.

<sup>2</sup>ROS is node-based, each robot can be composed of multiple nodes.

### 2.2.2 Oracle

ROSMonitoring decouples the message interception (monitor) and the formal verification aspects (oracle) and so is highly customizable. Different formalisms can be used to represent the properties to be verified, including Past MTL, Past STL, and Past LTL (MTL [22], STL [24], and LTL [28] with past-time operators, respectively). Using the formalism of choice, an external entity can be created to handle the trace of events reported by the monitors in ROS (generated through instrumentation). ROSMonitoring requires very few constraints for adding a new oracle. It uses JSON<sup>3</sup> (JavaScript Object Notation) as a data-interchange format for serialising the messages that are observed by the ROS monitor. JSON is commonly used for transmitting data between a server and a web application. In JSON, data is represented as key-value pairs enclosed in curly braces, making it a popular choice for APIs and data storage. An oracle will parse the JSON messages, check whether they satisfy or violate the formal property, and report back to the ROS monitor.

### 2.2.3 ROS monitor

The instrumentation process generates monitors to intercept the messages of interest. Each monitor is automatically generated as a ROS node in Python, which is a native language supported in ROS. ROSMonitoring provides two types of monitors: 1) offline monitors which simply log the intercepted events in a specified file to be parsed by the Oracle later to determine whether they satisfy a given set of properties, and 2) online monitors which query the Oracle in real time about whether the intercepted messages satisfy the given properties. While offline monitors only log the observed messages, online monitors could either log messages along with the Oracle verdict updated after each message or filter messages that the Oracle deems have violated the given properties. To clarify the difference, in the case of logging without filtering, if the online monitor finds a violation of the property under analysis, it publishes a warning message containing as much information as possible about the violated property. This warning message can be used by the system to handle the violation and to react appropriately. However, the monitor does not stop the message from propagating further in the system. In contrast, if filtering is enabled, since monitors can be placed between the communication of different nodes, ROSMonitoring monitors enforces the property under analysis by not propagating messages that represent a property violation. This is achieved by directing communication on the monitored topics to pass through the monitors.

## 3 Motivating example

In this section, we explain the rationale behind extending the ROSMonitoring framework. We use, as an example, a Battery Supervisor system<sup>4</sup> designed for a UAV (Uncrewed Aerial Vehicle) with three essential components depicted in Figure 2: the Battery, the Battery Supervisor, and the LED Panel. The Battery periodically reports the remaining battery percentage. The Battery Supervisor is responsible for checking the battery level and reporting its status. It subscribes to the battery percentage updates and analyses them. If the battery percentage is above 40%, it signals a ‘healthy’ status. If it is between 30% and 40%, it flags a ‘warning’ status. And if it falls below 30%, it indicates a ‘critical’ status. The LED Panel reflects the battery status through coloured LED lights. The Battery Supervisor is connected to the LED Panel and whenever it detects a change in the battery status, it sends a signal to the LED Panel to

---

<sup>3</sup><https://www.json.org/>

<sup>4</sup>Full code for this example is available in the Git Repository for ROSMonitoring 2.0 Case Study.

adjust the lights accordingly. For instance, if the battery is in a critical state, the red light might flash to indicate urgency<sup>5</sup>.

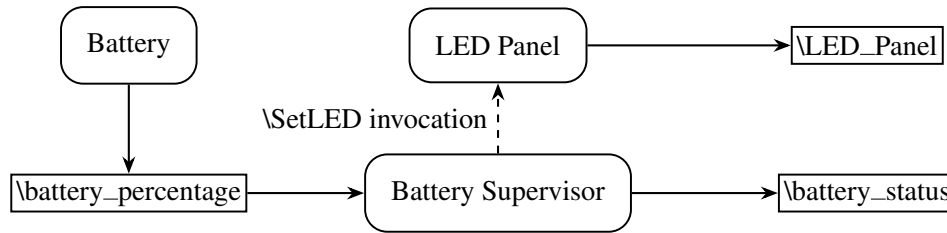

Figure 2: Motivating example with three components: Battery, Battery Supervisor, and LED Panel. Battery publishes on topic `/battery_percentage`; Battery Supervisor subscribes to `/battery_percentage`, publishes on topic `/battery_status`, and invokes service `/SetLED`; LED Panel publishes on topic `/LED_Panel` and responds to `/SetLED` service requests.

In this example, we are interested in ensuring that the messages exchanged between different components correspond correctly. For instance, that every status update provided by the Battery Supervisor accurately reflects the current battery percentage received from the Battery. However, while messages published on a single topic generally arrive at the subscribers according to their publication order, messages on different topics can arrive out of order. As a result, a battery status message could be observed before its corresponding battery percentage. Therefore, we need additional mechanisms to account for this before sending the messages to the Oracle for verification. This motivates our extension to reorder the messages according to their publication time.

Beyond message correspondence, we are also interested in verifying the interaction between the Battery Supervisor and the LED Panel service. We would like to confirm that every time the LED lights are adjusted based on the battery status, it is triggered by a legitimate status update. Conversely, we would like to check that every change in battery status is promptly followed by a request to adjust the LED lights, maintaining synchronisation between the visual feedback and the actual battery condition. However, services are not supported by the ROSMonitoring framework. This motivates our extension to support services. Since some of the properties we are interested in monitoring include both topics and services, we have also developed support for reordering service requests and responses according to publication time as well.

## 4 ROSMonitoring 2.0

ROSMonitoring 2.0 is fully available<sup>6</sup> for ROS1, while only partially available<sup>7</sup> for ROS2 (service monitoring has been added but not message reordering). In this section, we present two novel aspects of ROSMonitoring 2.0. Firstly, in Section 4.1, we detail the mechanism enabling monitoring of ROS services. Secondly, in Section 4.2, we introduce an algorithm for reordering messages based on their publication time, demonstrating its correctness under the assumption that messages on each topic arrive sequentially. Notably, such reordering mechanism is extended to support services in addition to topics.

<sup>5</sup>This case study was inspired by the example for RS services in the Robotics Back-End Tutorial as well as a solution to Challenge 3 of the MBZIRC Challenge competition 2020 [1].

<sup>6</sup><https://github.com/autonomy-and-verification-uol/ROSMonitoring/tree/master>

<sup>7</sup><https://github.com/autonomy-and-verification-uol/ROSMonitoring/tree/ros2>

## 4.1 Service extension

While ROS topics excel in broadcasting data streams or events asynchronously to multiple nodes, ROS services are designed for synchronous, point-to-point communication to request specific actions or services from other nodes in the system. Consequently, when monitoring services, our monitor node must directly intervene in the communication between the server and client. The monitor node then assumes the role of a server for the client, and conversely acts as a client for the server. The sequence diagram in Figure 3 illustrates the service verification process in ROSMonitoring 2.0 where message filtering is enabled (which subsumes the non-filtering scenario). The scenario begins with the Client sending a service request  $callService(req, res)$  to the Monitor. Subsequently, the Monitor forwards the request to the Oracle for verification via a callback mechanism specific to the service. If the Oracle identifies the request as inconsistent with the defined property, it responds with a negative verdict (*i.e.* either  $?_{\perp}$  or  $\perp$ ). In response, the Monitor publishes an error message and notifies the client of the discrepancy, bypassing the service invocation. Conversely, if the Oracle confirms the consistency of the request with the property, it returns a positive verdict (*i.e.*, either  $?_{\top}$  or  $\top$ ). The Monitor proceeds to invoke the service and awaits a response from the server. Upon receiving the response, the Monitor relays it back to the Oracle for evaluation. Should the Oracle determine the response to be erroneous (*i.e.*, the returned verdict is either  $?_{\perp}$  or  $\perp$ ), the Monitor again publishes an error message and notifies the client accordingly. Otherwise, it delivers the response to the client as expected.

In contrast to the standard ROSMonitoring behaviour, handling services necessitates additional verification steps. The Monitor must check both the service request and its corresponding response with the Oracle. Verifying the request is crucial to prevent invoking the service in case of a violation. Moreover, the Monitor must act as an intermediary between the client and server. This mechanism mirrors ROSMonitoring’s behaviour when topic filtering is enabled, albeit with an extension in the case of services to invoke the actual service upon successful request verification.

## 4.2 Ordered topics extension

To recover the publication order of messages in real time, ROSMonitoring 2.0 adds timestamps to each message. These timestamps are then utilised in Algorithm 1 to propagate messages to the Oracle in their original publication order. Moreover, this approach is based on the following assumption.

**Assumption 1.** *Messages on each single topic arrive at subscribers in the order of publication.*

In order to use the reordering feature in the ROS monitor, in the callback function for every topic, instead of propagating the message ( $msg$ ) directly to the Oracle, Algorithm 1 calls  $addToBuffer(msg, t)$ . Such a procedure accumulates messages from each topic into their respective buffers. Message release is withheld until all buffers contain at least one message, at which point the message with the earliest publication timestamp is released and sent to the Oracle. To prevent more than one thread to change the buffers simultaneously, we use locks to block write-access for a single thread.

**Lemma 1.** *In Algorithm 1, messages in each buffer maintain the order of publication timestamps.*

*Proof.* Suppose there is a topic  $t$  such that its corresponding list in dictionary  $buffers$  is out of order. Without loss of generality, assume there are two messages  $m_1$  and  $m_2$  on topic  $t$  with  $m_1$  published before  $m_2$  but stored in  $buffers[t]$  in reverse order, *i.e.*  $[.., m_2, m_1, ..]$ . Due to Assumption 1, since both

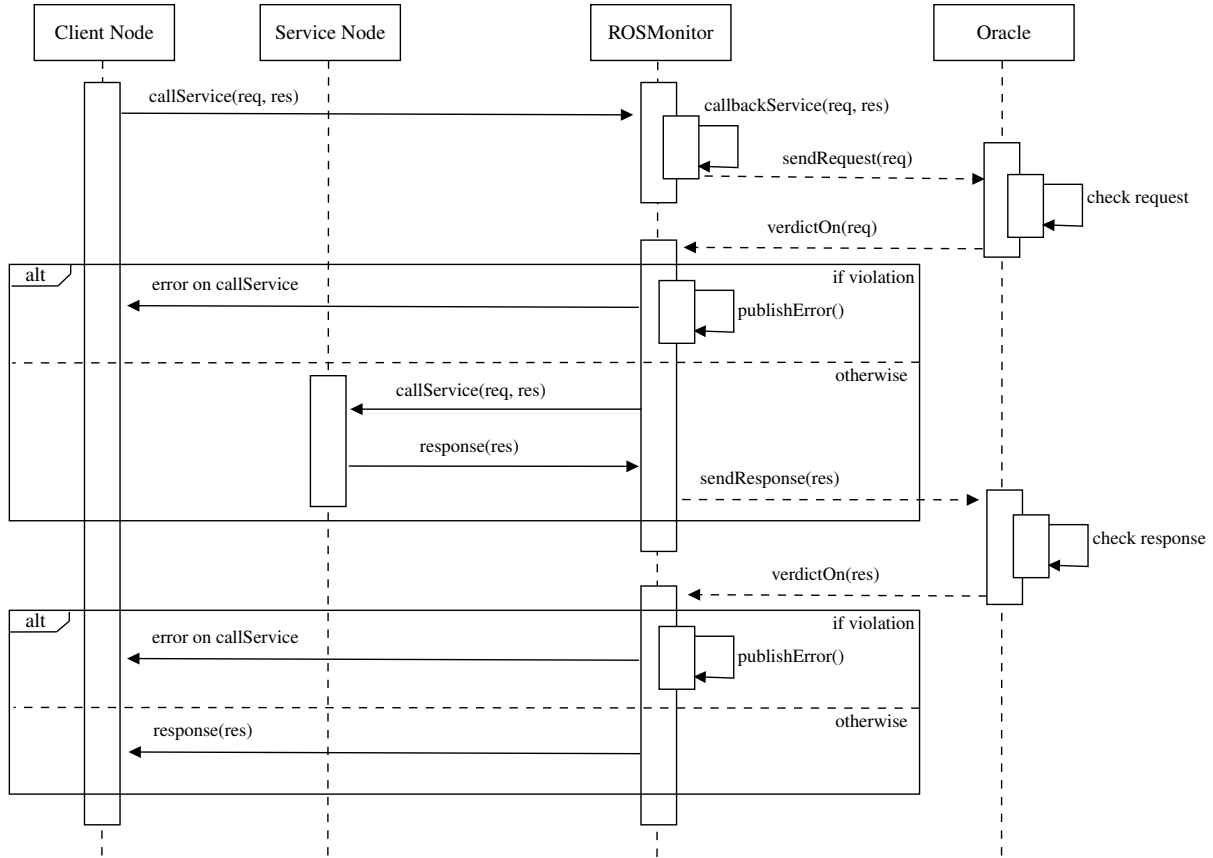

Figure 3: Service verification in ROSMonitoring 2.0 when filtering is enabled.

$m_1$  and  $m_2$  are on the same topic, they are received by the ROS monitor in the correct order. Therefore,  $addToBuffer(m_1, t)$  is called before  $addToBuffer(m_2, t)$ . Consequently,  $m_1$  is appended to the list  $buffers[t]$  before  $m_2$ . This contradicts our assumption that  $m_2$  is stored before  $m_1$  in  $buffers[t]$ . Thus, it follows, by contradiction, that Lemma 1 holds.  $\square$

**Theorem 1.** *Algorithm 1 propagates messages to the Oracle in the order of their publication.*

*Proof.* In order to prove that Algorithm 1 is correct, we assume the opposite, namely that two messages,  $m_1$  and  $m_2$ , were propagated to the Oracle in reverse order of their publication timestamps. Without loss of generality suppose  $m_1$  was published earlier than  $m_2$  but was propagated to the Oracle after  $m_2$ .

If the messages are on the same topic then, due to Assumption 1, we reach a contradiction which means our assumption is incorrect and the proof is complete. Otherwise, the messages are on distinct topics. Hence, by construction, they are stored in separate lists in  $buffers$ . Furthermore, the algorithm only sends messages to the Oracle if the buffers for all topics are non-empty. Therefore, both  $m_1$  and  $m_2$  must be present in their corresponding buffers at the time  $m_2$  is propagated to the Oracle. But the algorithm, by construction, always chooses the message with the smallest timestamp to propagate to the Oracle next. This contradicts our assumption that  $m_2$  is propagated before  $m_1$  despite having a larger timestamp. Consequently, we can conclude, by contradiction, that Algorithm 1 is correct.  $\square$

A successful application of the ordering mechanism necessitates careful consideration to mitigate the

---

**Algorithm 1:** Algorithm for propagating messages to the Oracle in the order they were published

---

**Input :**

*msg*: a ROS message received by the monitor on a topic *t*  
*ws*: a global websocket  
*buffer*: a global dictionary mapping each topic to a list of timestamps of unprocessed messages published on that topic  
*messages*: a global dictionary mapping publication timestamp to corresponding message

**Output:** Verdict published by Oracle based on messages in the order of publication time

```

1 Function sendEarliestMessageToOracle():
2   using buffer and messages
3     min_time_stamp = minimum timestamp in messages dictionary
4     message = messages[min_time_stamp]
5     send message to Oracle
6     verdict = Oracle's response
7     remove min_time_stamp from buffer
8     remove message from messages
9     Publish verdict

8 Function addToBuffer(msg, t):
9   using ws, buffer, and messages
10  time_stamp_of_msg = getTime(msg)
11  add time_stamp_of_msg to buffer[t]
12  messages[time_stamp_of_msg] = msg
13  lock websocket ws
14  while no topic has an empty buffer do
15    | sendEarliestMessageToOracle ()
16  end
17  unlock websocket ws

```

---

risk of deadlocks. Specifically, when a topic *t* undergoes filtering by the monitor, and another topic or service *x* relies on it, both *t* and *x* should not be concurrently included in the ordering process. Otherwise, the buffering of a message *m*<sub>1</sub> on topic *t* can lead to a deadlock scenario, as it cannot be released until an *x* message is buffered. Conversely, an *x* message cannot be generated until a *t* message is published, which, in turn, cannot occur until *m*<sub>1</sub> is released from the buffer. Furthermore, it is essential to carefully evaluate dependencies between topics and services when determining which should be ordered based on their publication times.



## 5 Experimental evaluation

In our case study, we illustrate the practical implementation of ROSMonitoring 2.0 through a scenario involving a Battery Supervisor system for a UAV. We developed an online ROS monitor which runs alongside the system and checks its behaviour against a set of properties in real time. The experiments were conducted using ROS1 Noetic distribution. As shown in Figure 2, our case study comprises three interconnected nodes: the Battery, responsible for publishing the remaining battery percentage; the Battery Supervisor, which subscribes to the battery percentage topic and publishes status updates based on predefined thresholds; and the LED Panel, which reflects the battery status through LED lights.

The Battery node periodically broadcasts the battery percentage on the */battery\_percentage* topic. Meanwhile, the Battery Supervisor node, operating at a slower rate than the Battery, subscribes to this topic and publishes status updates on the */battery\_status* topic. These status updates indicate the battery status as follows: status 1 for a percentage higher than 40%, status 2 for a percentage between 30% and 40%, and status 3 for a percentage between 0% and 30%. Since the Battery Supervisor has a slower publication rate, it may not report the status for every percentage published by the Battery. This is intentional to ensure that while the battery status is reported regularly, energy usage and communications are optimised.

As shown in Figure 4, to facilitate monitoring system behaviour, supplementary topics and a service are added to the original example in Figure 2. For instance, to ensure synchronisation between the Battery and the Battery Supervisor, an additional topic */input\_accepted* is introduced. This topic tracks which battery percentage messages have been processed by the Battery Supervisor. Furthermore, the Battery Supervisor publishes a message on topic */status\_change* if the battery status changes. The Battery Supervisor node subscribes to the */status\_change* topic itself to separate the processing of */battery\_percentage* messages from the invocation of service call to */SetLED*. As explained further below, this is a workaround to prevent deadlocks when using the ordering mechanism. Upon detecting a change in status by comparing the current status with the previous one, the Battery Supervisor publishes a */status\_change* message. Once the Battery Supervisor receives a */status\_change* message, it calls the */SetLED\_mon* service to update the LED lights on the LED Panel accordingly. After receiving a */SetLED\_mon* service request, the ROS monitor checks that the request is valid and it calls the */SetLED* service. Upon receiving a service call, the LED Panel publishes a message on the */status\_accepted* topic to record which status update was acknowledged, followed by a message on the */LED\_panel* topic reporting the current state of the LED lights (green, yellow, and red). The LED Panel also sends a response to the ROS monitor which is relayed back to the Battery Supervisor.

Subscribing to the */status\_change* topic may appear peculiar for the Battery Supervisor, which publishes it. While it might seem more straightforward to invoke the */SetLED* service where the status calculation occurs based on received */battery\_percentage* messages, such an approach risks deadlock. The reason is that the buffer is unable to release a service request message until accepting the next percentage message. But no further percentage messages can be accepted until a service response is received and that can only happen if the service request is released. To resolve this, we separated the publication of topics from the function which initiates service requests so that the service does not block the receipt of messages needed for producing a response.

The properties we selected to verify are as follows with formal definitions in Table 1:

1. **Topic only:** Correspondence of */battery\_status* with */battery\_percentage* and */input\_accepted* :
  - (a) Every */battery\_status* message corresponds to a */input\_accepted* message and correctly reports the status based on its corresponding

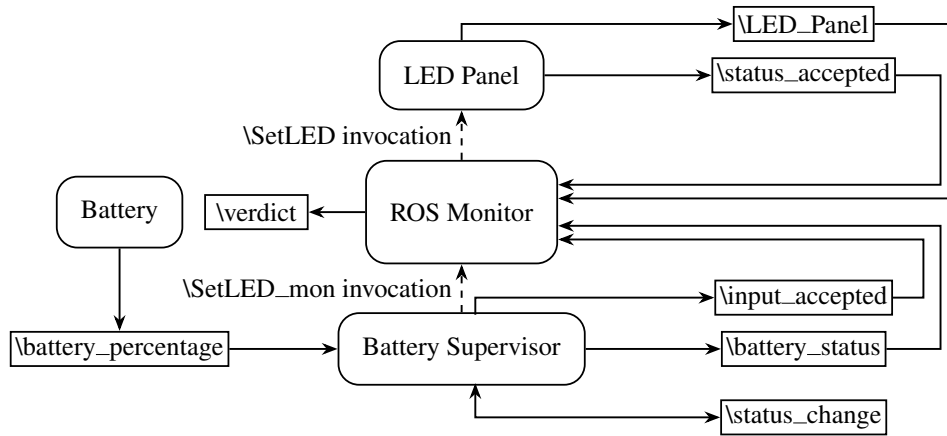

Figure 4: Case study with ROS Monitor and additional topics `/input_accepted`, `/status_accepted`, `/status_change`, `/verdict` and service `/SetLED_mon`.

`/battery_percentage` message.

- (b) Every `/input_accepted` message is followed by a `/battery_status` message within 100 time steps.
2. **Topic and Service:** Correspondence of `/SetLED` service request with `/battery_status` :
    - (a) Every `/SetLED` service request corresponds to a `/battery_status` message and a change in battery status.
    - (b) Every change of status reported via `/battery_status` messages is followed by a `/SetLED` service request within 100 time steps.
  3. **Service only:** Correspondence of `/SetLED` service request and response:
    - (a) Every `/SetLED` service response corresponds to a `/SetLED` service request.
    - (b) Every `/SetLED` service request is followed by a `/SetLED` service request within 100 time steps.

Formalisation of these properties requires definition of predicates, summarised in Table 2, based on the JSON messages sent to the Oracle. For topics, generic predicates `topic` and `id` are defined. Additionally, for the `/battery_percentage` topic, predicate `percentage` is defined, taking values 1 for percentages between 40% and 100%, 2 for percentages between 30% and 40%, 3 for percentages between 0% and 30%, and `INVALID` for other values. Consistently, the `percentage` and `status` predicates share values to enable referencing, as seen in Property 1a. For the `/battery_status` topic, predicate `status` holds the String version of message status, with `INVALID` assigned if the status is not 1, 2, or 3. Additionally, predicate `status_change` is defined to be `True` if the corresponding field in the message is `true`. Note that the monitor is not subscribed to the `/status_change` topic which is used to trigger an LED Panel response. The reason for this redundancy is deadlock prevention. If the `/status_change` topic was ordered, then its release would be contingent on a service request joining the buffers which cannot happen unless the `/status_change` message is released. Our solution to this potential deadlock was to keep the `/status_change` topic unordered and add a field `status_change` to the `battery_status` topic for the Oracle to determine if the LED panel is responding correctly. Such redundancies could be considered as a general technique to prevent deadlocks. For the `/SetLED` service, predicates `request` and `response`

Property ID	Property formal specification
1a	forall[i]. (forall[s]. {topic: “/battery_status”, id: *i, status: *s} → once({topic: “/input_accepted”, id: *i}) and once({topic: “/battery_percentage”, id: *i, percentage: *s}))
1b	forall[i]. not ({topic: “/battery_status”, id: *i}) → once[1:]{topic: “/battery_status”, id: *i} or not (once[100:]{topic: “/input_accepted”, id: *i}))
2a	forall[i]. (forall[s]. {service: “/SetLED”, req_id: *i, req_status: *s} → once({topic: “/battery_status”, id: *i, status: *s, status_change: True}))
2b	forall[i]. not ({service: “/SetLED”, req_id: *i, req_status: *s}) → once[1:]{service: “/SetLED”, req_id: *i, req_status: *s} or not (once[100:]{topic: “/battery_status”, id: *i, status: *s, status_change: True}))
3a	forall[i]. {service: “/SetLED”, response: True, res_id: *i} → once({service: “/SetLED”, request: True, req_id: *i})
3b	forall[i]. not ({service: “/SetLED”, response: True, res_id: *i}) → once[1:]{service: “/SetLED”, response: True, res_id: *i} or not (once[100:]{service: “/SetLED”, request: True, req_id: *i}))

Table 1: Properties in Past Metric Temporal Logic (Past MTL) according to the Reelay Expression Format (<https://doganulus.github.io/reelay/rye/>).

Message Type	Predicate	Description
/battery_percentage	topic	Topic of the message, i.e. /battery_percentage
	id	Unique sequentially assigned ID for the message
	percentage	‘1’ if percentage > 40 and percentage ≤ 100 ‘2’ if percentage > 30 and percentage ≤ 40 ‘3’ if percentage ≤ 30 and percentage ≥ 0 ‘INVALID’ if percentage < 0 or percentage > 100
/battery_status	topic	Topic of the message, i.e. /battery_status
	id	The ID of the corresponding percentage message
	status	‘0’ if status is 0 ‘1’ if status is 1 ‘2’ if status is 2 ‘3’ if status is 3 ‘INVALID’ if status is not 0, 1, 2, or 3
	status_change	‘True’ if and only if the corresponding field is ‘true’
/SetLED	request	‘True’ if and only if the message is a service request for /SetLED
	req_id	ID of the corresponding /battery_status message
	req_status	Status of the corresponding /battery_status message
	response	‘True’ if and only if the message is a service response for /SetLED

Table 2: Predicates construction based upon JSON messages sent to Oracle.

indicate message type. For /SetLED service request messages, predicates *req\_id* and *req\_status* store additional information used in Properties 2a and 2b to verify legitimate requests triggered by corresponding /battery\_status messages.

A significant concern associated with the implementation of runtime verification is its potential adverse effect on overall system performance. To gauge the extent of overhead induced by monitoring services, we modified the client node to measure the time elapsed between dispatching a /SetLED service request and receiving the corresponding response. All experiments shown in Figures 5, 6, and 7 were conducted over 10 runs, with the results averaged. Each run was terminated once the battery percentage reached zero. Frequencies for the Battery, Battery Supervisor, and LED Panel were set to 25, 10, and 35 Hertz respectively. The mean and standard deviation are reported for each experiment. As illustrated in Figure 6, the overhead incurred by monitoring /SetLED without ordering appears negligible, but the introduction of ordering substantially delays the process, particularly noticeable during the last status change. To approximate the overhead attributed to the ordering mechanism, we adapted the

monitor code to record the time difference between message buffering and transmission to the Oracle (reported in Figure 7). The results depicted in Figure 5 exhibit a similar trend, wherein the release time deviates from the buffering time until the second service request, after which the waiting time stabilises at a minimised level. This is because after the initial service request and response at the beginning of the execution, messages keep accumulating in the buffers since the */SetLED* service buffer remains empty until the second service request is triggered by battery percentage reaching 40%. This threshold is reached when the message with ID 60 is sent. With a service request in the corresponding buffer, the algorithm proceeds to release messages from buffers in the order of publication. Since the next service request is triggered when the battery percentage reaches 30%, i.e. message ID 70, the service buffer will not be empty for long. This explains the minimal waiting time between buffering and transmission after the 60th message. Once the battery percentage reaches 0, the execution is interrupted. This allows the remaining messages in the buffers to be released in the order of publication without requiring all buffers to be nonempty. Moreover, as shown in Figure 7, the waiting time for */SetLED* service requests escalates over time, whereas response messages appear to be promptly released from the buffer. This is because at the time that a service request is buffered, a number of messages have accumulated in the other buffers which need to be released before the service request. In contrast, since the service response is buffered shortly after the corresponding service request is released, there are only a few messages buffered in between which need to be released before the service response.

With regards to verification accuracy, monitoring with ordering consistently yielded accurate verdicts without any incorrect assessments. Conversely, in cases where monitoring excluded ordering, */battery\_status* messages often reached the monitor prior to their corresponding */battery\_percentage* or */input\_accepted* signals. Similarly, service request and response messages consistently preceded the corresponding */status\_change* signals. These out-of-order message arrivals led to frequent false negative verdicts in each run. Hence, in weighing the trade-off between performance and accuracy, it becomes evident that monitoring with ordering is most suitable for safety-critical systems where time sensitivity is not paramount. On the other hand, monitoring without ordering may offer enhanced performance at the expense of accuracy, making it more suitable for scenarios where real-time constraints are less stringent.

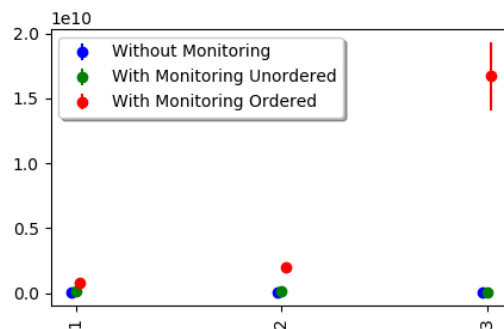

Figure 6: Mean and standard deviation of time (nanoseconds) taken for */SetLED* service request to receive a response (reported on three service calls). Data shown for 10 runs without monitoring, with monitoring excluding ordering, and with monitoring including ordering.

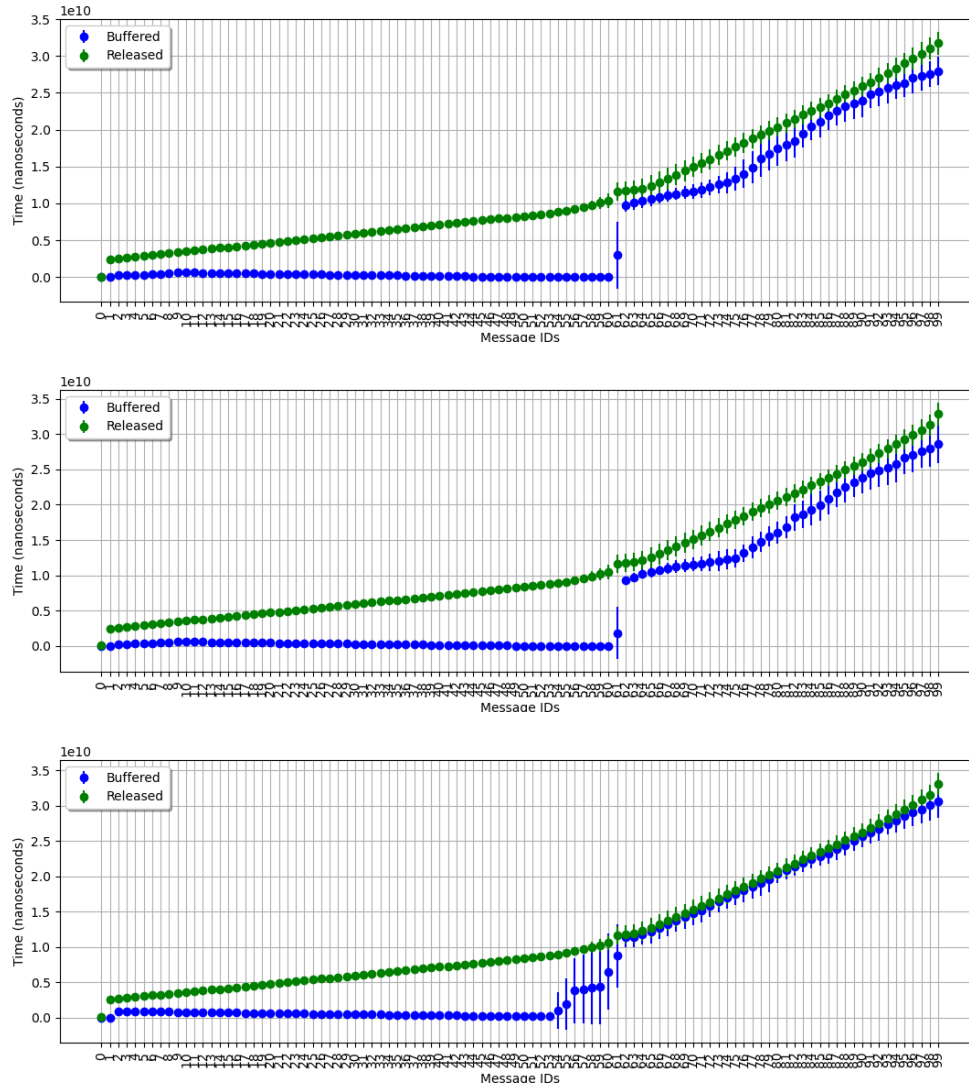

Figure 5: Mean and standard deviation of time (nanoseconds) taken for monitor with ordering to buffer and release messages on `/battery_percentage` (top), `/input_accepted` (middle), and `/battery_status` (bottom) topics since publication. Data shown for 10 runs.

## 6 Related Work

In this section, we discuss the most recent approaches to RV of ROS and position them in relation to ROSMonitoring 2.0.

ROSRV [19] shares similarities with our framework in achieving automatic RV of applications in ROS. Both tools utilise monitors not only to passively observe but also to intercept and handle incorrect behaviours in message exchanges among nodes. The main difference lies in how they integrate the monitor into the system. ROSRV replaces the ROS Master node with RVMaster, directing all node communication through it and establishing peer-to-peer communication with the monitor as the intermediary. In contrast, ROSMonitoring adds the monitor through node instrumentation without altering

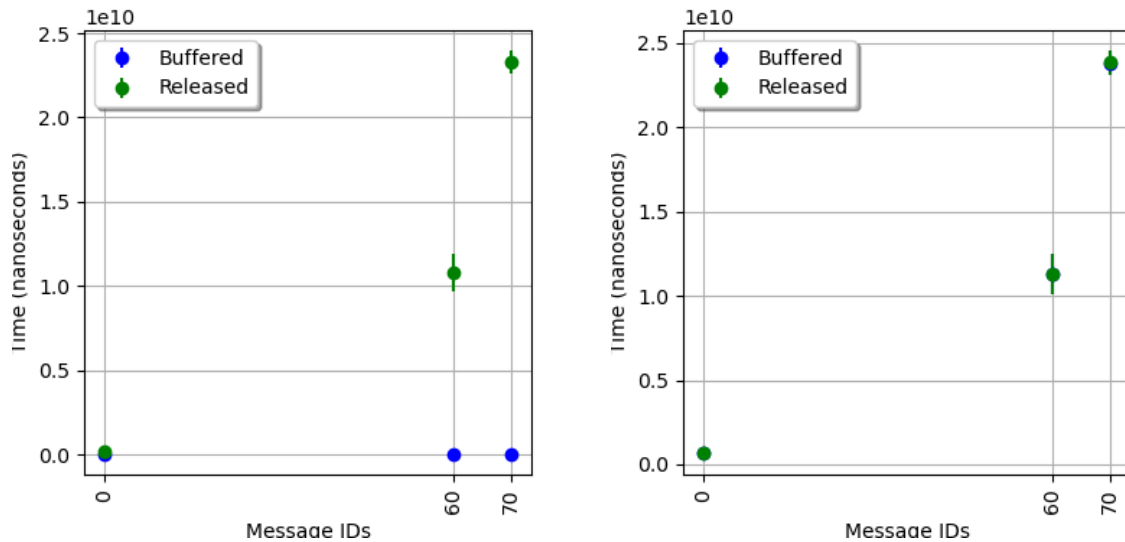

Figure 7: Mean and standard deviation of time (nanoseconds) taken for monitor with ordering to buffer and release */SetLED* request (left) and response (right) messages since generation. Time for buffering and releasing overlap for response messages in the right plot. Data shown for 10 runs.

the ROS Master node. Additionally, the new and extended version ROSMonitoring 2.0 presented in this paper further differentiates the two frameworks, as ROSRV does not support the verification of services or the customisation of the order of topics. HAROS [30] is a framework dedicated to ensuring the quality of ROS systems. Although HAROS primarily focuses on static analysis, it possesses the capability to generate runtime monitors and conduct property-based testing. Differently from ROSMonitoring 2.0, HAROS does not support ROS2 (not even partially). Furthermore, one notable distinction between ROSMonitoring 2.0 and HAROS is that our specifications do not incorporate ROS-specific details, and the process for generating monitors does not rely on understanding the topology of the ROS graph. DeROS [4] is a domain-specific language and monitoring system tailored for ROS. Although DeRoS's language incorporates explicit topic notions, it lacks native support for reordering or service handling. Moreover, it is exclusively compatible with ROS. An extension of Ogma supports the runtime monitoring of ROS2 applications [27]. It outlines a formal approach to generate runtime monitors for autonomous robots from structured natural language requirements, expressed in FRET [17]. This extension integrates FRET and Copilot [26] via Ogma to translate requirements into temporal logic formulas and generate monitor specifications. Unlike ROSMonitoring 2.0, which focuses on monitoring and potentially filtering topics and services, this extension is limited to detecting and reporting violations only. Nonetheless, [17] provides a lightweight verification solution for complex ROS2 applications, ensuring safe operation. MARVer [13] is an integrated runtime verification system designed to ensure the safety and security of industrial robotic systems. It offers a lightweight yet effective approach to monitoring the behaviour of robotic systems in real-time, enabling the detection of security attacks and potential safety hazards. By being based on ROSMonitoring, MARVer can leverage the new features introduced in this work.

The work in [7] introduces TeSSLa-ROS-Bridge, a RV system designed for robotic systems built in ROS. Unlike other RV approaches, TeSSLa-ROS-Bridge utilises Stream-based Runtime Verification

(SRV), which specifies stream transformations to detect errors and control system behaviour (currently supported in ROSMonitoring as well). The system allows TeSSLa monitors to run alongside ROS-based robotic systems, enabling real-time monitoring. Compared to ROSMonitoring, which focuses on monitoring and filtering topics and services, TeSSLa-ROS-Bridge offers a different approach by leveraging stream-based runtime verification to monitor and control robotic systems. RTAMT is an online monitoring library for Signal Temporal Logic (STL), supporting both discrete and dense-time interpretations. In [25], RTAMT4ROS is introduced, integrating RTAMT with ROS. This integration enables specification-based RV methods in robotic applications, enhancing safety assurance in complex autonomous systems. However, similar to other RV frameworks, RTAMT4ROS solely supports topics monitoring and relies exclusively on ROS. Alternative runtime monitoring systems such as Lola [12], Java-MOP [10], detectEr [3], Hydra [29], DejaVu [18], LamaConv [20], and TraceContract [6] could potentially be applied to robotics applications. However, these systems are not explicitly designed for ROS, and integrating them into ROS would require additional development effort and potentially incur runtime costs.

## 7 Conclusions and Future Work

This paper introduces ROSMonitoring 2.0, an extension of the ROSMonitoring framework designed to enable the Runtime Verification of robotic applications developed in ROS. ROSMonitoring 2.0 expands upon its predecessor by facilitating the verification of services, in addition to topics, and by accommodating ordered topics, rather than solely unordered ones. Notably, the new features of ROSMonitoring 2.0 do not necessitate changes to the compositional and formalism-agnostic aspects of ROSMonitoring; only the synthesis of ROS monitors is adjusted. This approach not only leverages all existing features in ROSMonitoring but also ensures full backward compatibility with existing ROS applications based on ROSMonitoring. Furthermore, the proposed ordering algorithm and service interception process hold applicability beyond the scope of ROSMonitoring 2.0, potentially benefiting other systems as well.

It is also worth noting that the introduction of ordering messages according to the order they are published does not mutually exclude the standard ROSMonitoring topic checking, based on the order the messages are received. In this sense, in ROSMonitoring 2.0 it is also possible to combine both ordering features to monitor both the publish and receive order of messages. This becomes relevant in scenarios where it is necessary to identify which exact node is the faulty one, rather than being only interested in checking the presence of a property violation (which could be relevant in other scenarios instead).

As a future direction, we aim to formally verify that our case study is deadlock-free and establish design principles for ensuring deadlock-freeness. Additionally, threading will be explored as an alternative solution to address potential deadlock issues. We also plan to extend our research to additional case studies in the robotics domain, focusing on complex systems involving multiple services with strong interdependencies across services, topics, and interfaces.

Moreover, we intend to expand the framework to support ROS actions. ROS actions allow robots to execute complex, asynchronous tasks by setting goals, providing feedback, and retrieving results, thus facilitating modular and scalable behaviours for navigation, manipulation, and planning. Although actions are asynchronous and non-blocking, which reduces the monitoring burden compared to services, they introduce challenges in tracking progress against runtime goals.

In parallel, we plan to enhance our message ordering algorithm by introducing timeouts, preventing messages from waiting indefinitely, particularly in unreliable communication scenarios. However, careful consideration is required, as timeouts may disrupt the message order when delays occur, rather than

message loss. This could be especially important for scenarios with strict timing requirements, where a balance must be struck between message order and timely delivery.

Furthermore, a comprehensive performance evaluation of ROSMonitoring 2.0 will be a critical focus. We aim to assess key metrics such as execution time, resource usage, and system overhead, benchmarking our approach against existing alternatives. Such an evaluation will provide deeper insights into the framework's efficiency and scalability and guide further optimisations.

Lastly, our goal is to port all the features presented in this paper to ROS2, which currently only supports service monitoring and lacks message reordering functionality. This migration will proceed once additional evaluations and testing have been completed on the ROS1 version of ROSMonitoring 2.0.

## References

- [1] *MBZIRC 2020: The Mohamed Bin Zayed International Robotics Challenge*. <https://rsl.ethz.ch/research/challenges-competitions/mbzirc2020.html>. Accessed on April 8th, 2024.
- [2] *ROS: Robot Operating System*. <https://www.ros.org/>. Accessed on April 8th, 2024.
- [3] Luca Aceto, Antonis Achilleos, Duncan Paul Attard, Léo Exibard, Adrian Francalanza & Anna Ingólfssdóttir (2024): *A Monitoring Tool for Linear-Time  $\mu$ HML*. *Sci. Comput. Program.* 232, p. 103031. Available at <https://doi.org/10.1016/j.scico.2023.103031>.
- [4] Sorin Adam, Morten Larsen, Kjeld Jensen & Ulrik Pagh Schultz (2014): *Towards Rule-Based Dynamic Safety Monitoring for Mobile Robots*. In Davide Brugali, Jan F. Broenink, Torsten Kroeger & Bruce A. MacDonald, editors: *Proc. 4th International Conference on Simulation, Modeling, and Programming for Autonomous Robots (SIMPAR), Lecture Notes in Computer Science 8810*, Springer, pp. 207–218. Available at [https://doi.org/10.1007/978-3-319-11900-7\\_18](https://doi.org/10.1007/978-3-319-11900-7_18).
- [5] Davide Ancona, Luca Franceschini, Angelo Ferrando & Viviana Mascardi (2021): *RML: Theory and practice of a domain specific language for runtime verification*. *Sci. Comput. Program.* 205, p. 102610, doi:10.1016/J.SCICO.2021.102610.
- [6] Howard Barringer & Klaus Havelund (2011): *TraceContract: A Scala DSL for Trace Analysis*. In Michael J. Butler & Wolfram Schulte, editors: *Proc. 17th International Symposium on Formal Methods (FM), Lecture Notes in Computer Science 6664*, Springer, pp. 57–72. Available at [https://doi.org/10.1007/978-3-642-21437-0\\_7](https://doi.org/10.1007/978-3-642-21437-0_7).
- [7] Marian Johannes Begemann, Hannes Kallwies, Martin Leucker & Malte Schmitz (2023): *TeSSLa-ROS-Bridge - Runtime Verification of Robotic Systems*. In Erika Ábrahám, Clemens Dubslaff & Silvia Lizeth Tapia Tarifa, editors: *Proc. 20th International Colloquium on Theoretical Aspects of Computing (ICTAC), Lecture Notes in Computer Science 14446*, Springer, pp. 388–398. Available at [https://doi.org/10.1007/978-3-031-47963-2\\_23](https://doi.org/10.1007/978-3-031-47963-2_23).
- [8] Guido Breitenhuber (2020): *Towards Application Level Testing of ROS Networks*. In: *Proc. Fourth IEEE International Conference on Robotic Computing (IRC)*, IEEE, pp. 436–442. Available at <https://doi.org/10.1109/IRC.2020.00081>.
- [9] Maria A. S. Brito, Simone R. S. Souza & Paulo S. L. Souza (2022): *Integration testing for robotic systems*. *Softw. Qual. J.* 30(1), pp. 3–35. Available at <https://doi.org/10.1007/s11219-020-09535-w>.
- [10] Feng Chen & Grigore Rosu (2005): *Java-MOP: A Monitoring Oriented Programming Environment for Java*. In Nicolas Halbwachs & Lenore D. Zuck, editors: *Proc. 11th International Conference on Tools and Algorithms for the Construction and Analysis of Systems (TACAS), held as Part of the Joint European Conferences on Theory and Practice of Software (ETAPS), Lecture Notes in Computer Science 3440*, Springer, pp. 546–550. Available at [https://doi.org/10.1007/978-3-540-31980-1\\_36](https://doi.org/10.1007/978-3-540-31980-1_36).



- [11] Edmund M. Clarke, Orna Grumberg & Doron A. Peled (2001): *Model checking*. MIT Press, doi:10.1016/B978-044450813-3/50026-6. Available at <http://books.google.de/books?id=Nmc4wEaLXFEC>.
- [12] Ben D'Angelo, Sriram Sankaranarayanan, César Sánchez, Will Robinson, Bernd Finkbeiner, Henny B. Sipma, Sandeep Mehrotra & Zohar Manna (2005): *LOLA: Runtime Monitoring of Synchronous Systems*. In: *Proc. 12th International Symposium on Temporal Representation and Reasoning (TIME)*, IEEE Computer Society, pp. 166–174. Available at <https://doi.org/10.1109/TIME.2005.26>.
- [13] Elif Degirmenci, Yunus Sabri Kirca, Özlem Örnek, Mert Bulut, Serhat Kahraman, Metin Ozkan & Ahmet Yazici (2023): *Developing an Integrated Runtime Verification for Safety and Security of Industrial Robot Inspection System*. In Fumiya Iida, Perla Maiolino, Arsen Abdulali & Mingfeng Wang, editors: *Proc. 24th Annual Conference on Towards Autonomous Robotic Systems (TAROS), Lecture Notes in Computer Science 14136*, Springer, pp. 126–137. Available at [https://doi.org/10.1007/978-3-031-43360-3\\_11](https://doi.org/10.1007/978-3-031-43360-3_11).
- [14] Ankush Desai, Tommaso Dreossi & Sanjit A. Seshia (2017): *Combining Model Checking and Runtime Verification for Safe Robotics*. In Shuvendu K. Lahiri & Giles Reger, editors: *Proc. 17th International Conference on Runtime Verification (RV), Lecture Notes in Computer Science 10548*, Springer, pp. 172–189. Available at [https://doi.org/10.1007/978-3-319-67531-2\\_11](https://doi.org/10.1007/978-3-319-67531-2_11).
- [15] Angelo Ferrando, Rafael C. Cardoso, Michael Fisher, Davide Ancona, Luca Franceschini & Viviana Mascardi (2020): *ROSMonitoring: A Runtime Verification Framework for ROS*. In Abdelkhalick Mohammad, Xin Dong & Matteo Russo, editors: *Proc. 21st Annual Conference on Towards Autonomous Robotic Systems (TAROS), Lecture Notes in Computer Science 12228*, Springer, pp. 387–399. Available at [https://doi.org/10.1007/978-3-030-63486-5\\_40](https://doi.org/10.1007/978-3-030-63486-5_40).
- [16] Mohammed Foughali, Bernard Berthomieu, Silvano Dal-Zilio, Félix Ingrand & Anthony Mallet (2016): *Model Checking Real-Time Properties on the Functional Layer of Autonomous Robots*. In Kazuhiro Ogata, Mark Lawford & Shaoying Liu, editors: *Formal Methods and Software Engineering - 18th International Conference on Formal Engineering Methods, ICFEM 2016, Tokyo, Japan, November 14-18, 2016, Proceedings, Lecture Notes in Computer Science 10009*, pp. 383–399. Available at [https://doi.org/10.1007/978-3-319-47846-3\\_24](https://doi.org/10.1007/978-3-319-47846-3_24).
- [17] Dimitra Giannakopoulou, Thomas Pressburger, Anastasia Mavridou, Julian Rhein, Johann Schumann & Nija Shi (2020): *Formal Requirements Elicitation with FRET*. In Mehrdad Sabetzadeh, Andreas Vogelsang, Salam Abualhaija, Markus Borg, Fabiano Dalpiaz, Maya Daneva, Nelly Condori-Fernández, Xavier Franch, Davide Fucci, Vincenzo Gervasi, Eduard C. Groen, Renata S. S. Guizzardi, Andrea Herrmann, Jennifer Horkoff, Luisa Mich, Anna Perini & Angelo Susi, editors: *Joint Proceedings of REFSQ-2020 Workshops, Doctoral Symposium, Live Studies Track, and Poster Track co-located with the 26th International Conference on Requirements Engineering: Foundation for Software Quality (REFSQ 2020), CEUR Workshop Proceedings 2584*, CEUR-WS.org. Available at <https://ceur-ws.org/Vol-2584/PT-paper4.pdf>.
- [18] Klaus Havelund, Doron Peled & Dogan Ulus (2018): *DejaVu: A Monitoring Tool for First-Order Temporal Logic*. In: *Proc. 3rd Workshop on Monitoring and Testing of Cyber-Physical Systems, MT@CPSWeek 2018*, IEEE, pp. 12–13. Available at <https://doi.org/10.1109/MT-CPS.2018.00013>.
- [19] Jeff Huang, Cansu Erdogan, Yi Zhang, Brandon M. Moore, Qingzhou Luo, Aravind Sundaresan & Grigore Rosu (2014): *ROSRV: Runtime Verification for Robots*. In Borzoo Bonakdarpour & Scott A. Smolka, editors: *Proc. 5th International Conference on Runtime Verification (RV), Lecture Notes in Computer Science 8734*, Springer, pp. 247–254, doi:10.1007/978-3-319-11164-3\_20.
- [20] Institute for Software Engineering and Programming Languages: *LamaConv - Logics and Automata Converter Library*. [www.isp.uni-luebeck.de/lamaconv](http://www.isp.uni-luebeck.de/lamaconv).
- [21] Gert Kanter & Jüri Vain (2020): *Model-based testing of autonomous robots using TestIt*. *J. Reliab. Intell. Environ.* 6(1), pp. 15–30. Available at <https://doi.org/10.1007/s40860-019-00095-w>.
- [22] Ron Koymans (1990): *Specifying Real-Time Properties with Metric Temporal Logic*. *Real Time Syst.* 2(4), pp. 255–299, doi:10.1007/BF01995674.

- [23] Martin Leucker & Christian Schallhart (2009): *A Brief Account of Runtime Verification*. *J. Log. Algebraic Methods Program.* 78(5), pp. 293–303. Available at <https://doi.org/10.1016/j.jlap.2008.08.004>.
- [24] Oded Maler & Dejan Nickovic (2004): *Monitoring Temporal Properties of Continuous Signals*. In Yassine Lakhnech & Sergio Yovine, editors: *Formal Techniques, Modelling and Analysis of Timed and Fault-Tolerant Systems, Joint International Conferences on Formal Modelling and Analysis of Timed Systems, FORMATS 2004 and Formal Techniques in Real-Time and Fault-Tolerant Systems, FTRTFT 2004, Grenoble, France, September 22-24, 2004, Proceedings, Lecture Notes in Computer Science 3253*, Springer, pp. 152–166, doi:10.1007/978-3-540-30206-3\_12.
- [25] Dejan Nickovic & Tomoya Yamaguchi (2020): *RTAMT: Online Robustness Monitors from STL*. In Dang Van Hung & Oleg Sokolsky, editors: *Proc. 18th International Symposium on Automated Technology for Verification and Analysis (ATVA), Lecture Notes in Computer Science 12302*, Springer, pp. 564–571. Available at [https://doi.org/10.1007/978-3-030-59152-6\\_34](https://doi.org/10.1007/978-3-030-59152-6_34).
- [26] Ivan Perez & Alwyn Goodloe (2020): *Copilot 3*. Technical Report, doi:10.13140/RG.2.2.35163.80163.
- [27] Ivan Perez, Anastasia Mavridou, Thomas Pressburger, Alexander Will & Patrick J. Martin (2022): *Monitoring ROS2: from Requirements to Autonomous Robots*. In Matt Luckcuck & Marie Farrell, editors: *Proceedings Fourth International Workshop on Formal Methods for Autonomous Systems (FMAS) and Fourth International Workshop on Automated and verifiable Software sYstem DEvelopment (ASYDE), FMAS/ASYDE@SEFM 2022, EPTCS 371*, pp. 208–216, doi:10.4204/EPTCS.371.15.
- [28] Amir Pnueli (1977): *The Temporal Logic of Programs*. In: *Proc. 18th Annual Symposium on Foundations of Computer Science*, IEEE Computer Society, pp. 46–57. Available at <https://doi.org/10.1109/SFCS.1977.32>.
- [29] Martin Raszyk, David A. Basin & Dmitriy Traytel (2020): *Multi-head Monitoring of Metric Dynamic Logic*. In Dang Van Hung & Oleg Sokolsky, editors: *Proc. 18th International Symposium on Automated Technology for Verification and Analysis (ATVA), Lecture Notes in Computer Science 12302*, Springer, pp. 233–250. Available at [https://doi.org/10.1007/978-3-030-59152-6\\_13](https://doi.org/10.1007/978-3-030-59152-6_13).
- [30] André Santos, Alcino Cunha, Nuno Macedo & Cláudio Lourenço (2016): *A framework for quality assessment of ROS repositories*. In: *Proc. IEEE/RSJ International Conference on Intelligent Robots and Systems (IROS)*, IEEE, pp. 4491–4496. Available at <https://doi.org/10.1109/IROS.2016.7759661>.
- [31] A. Prasad Sistla & Edmund M. Clarke (1985): *The Complexity of Propositional Linear Temporal Logics*. *J. ACM* 32(3), pp. 733–749. Available at <https://doi.org/10.1145/3828.3837>.