

Asymmetric Bidirectional Quantum Teleportation: Arbitrary bi-modal Information State

Ankita Pathak^{*1}, Madan Singh Chauhan and Ravi S. Singh²
Photonic Quantum-Information and Quantum Optics Group, Department of Physics,
Deen Dayal Upadhyaya Gorakhpur University, Gorakhpur (U.P.), 273009, India.

e-mail: 1pathak18.phy@gmail.com; 2yesora27@gmail.com

Abstract

Optical coherent states are experimentally realizable continuous variable quantum states of which preparation by lasers, as well as its manipulation and monitoring by linear optical gadgets are well established. We propose a strategy to send an arbitrary superposition of four-component bi-modal entangled coherent states from a sender to a receiver who, simultaneously, tries to transmit an unknown Schrodinger Cat coherent-state to sender via employing a cluster consisting of ‘three’ superposition of two-component bi-modal entangled coherent states as the quantum channel and utilizing linear optical gadgets. Heralded detections of photons in laboratories of sender and receiver followed by classical communications of even/odd number of photons and local unitary operations, impeccably, accomplishes simultaneous faithful asymmetric bidirectional quantum teleportation with one-eighth of probability of success. It is seen that not all detection events implement the protocol and, therefore, one has to locally apply displacement operator, a necessary evil. We analyze near-faithful partial asymmetric bidirectional quantum teleportation and associated probability of success therein. We demonstrated that, for an intense coherent optical field, fidelities approach unity.

Keywords: Bidirectional Quantum Teleportation, Schrodinger Cat states, Entangled Coherent States, Linear Optics.

1. Introduction

Quantum Teleportation (QT) is a fundamental protocol in quantum communication discovered by Bennet et al. [1] in discrete-variable regime. Continuous-variable version of QT has been demonstrated by Vaidman [2] via utilizing the conception of nonlocal measurements [3,4], which, later on, developed by Braunstein and Kimble [5] through Wigner distribution function route. Quantum communication has witnessed myriad variants such as quantum cryptography [6,7], super dense coding [8], quantum secure direct communication [9], quantum secret sharing [10], remote state preparation [11,13], port-based QT [14,15], counterfactual quantum communication [16], Catalytic QT [17-19]. QT is experimentally realized in various formidable physical systems such as photonic states [20-25], optical quantum modes [26-28], nuclear magnetic resonance [29], atomic ensembles [30-32], trapped atoms [33-35] or solid-state systems [36-38]. Moreover, QT is being unified with novel prevalent concepts to bring forth novel schemes such as quantum telecomputing [39-41], quantum telecloning [42-44], quantum telefilters and telemirrors [45], quantum

broadcasting [46,47], quantum tele-amplification [48], quantum digital signature [49], to name a few.

Cochrane et. al. [50] have utilized, for the first time, even and odd coherent states [51] to encode logical qubits. Ralph et.al. [52] have advocated that coherent states, itself, may be mapped as logical-qubits by $|0\rangle_L \rightarrow |\alpha\rangle$ and $|1\rangle_L \rightarrow |-\alpha\rangle$, α is, here, taken real, where $|\alpha\rangle$ and $|-\alpha\rangle$ are π -phase apart optical coherent states. Obviously, although $|\alpha\rangle$ and $|-\alpha\rangle$ are linearly independent non-orthogonal vectors embedded individually in unbounded Hilbert space but their superposition, namely, Schrodinger Cat states, are in two-dimensional Hilbert space.

van Enk and Hirota [53] have designed a scheme by using only linear optical elements such as beam splitters, phase shifters and photon number resolving detectors, in which Schrodinger Cat coherent-states is teleported to non-locally stationed Bob via bi-modal maximally Bell-coherent states [54] as quantum channel. Ba An [55] have worked out a scheme for teleporting an arbitrary superposed coherent state within a network. Wang [56] have generalized the van Enk and Hirota's protocol by in which an unknown Bell coherent-state is transmitted by GHZ-coherent states. Furthermore, teleportation of an arbitrary bi-modal four component entangled coherent states have been proposed by Liao and Kuang [54] and Phien and Ba An [57], Prakash et.al. [58].

Karlsson and Bourennane [59] generalized standard QT protocol [1] by inducting a third party, Charlie playing the role of controller in the scheme, and, therefore, notion of controlled quantum teleportation appears. Unidirectional controlled QT witnessed many variants by inducting 'multi-parties', multi qubits as information encoding and demanding security-issues by developing novel communication schemes in discrete variable regime [60-63]. Notably, controlled QT employing GHZ-coherent-states as quantum channel is brought out by Pandey et.al. [64] for transmitting unknown superposed coherent states from sender Alice to receiver Bob controlled by Charlie. Bidirectional QT protocol has appeared in work of Huelga et.al. [65], who have, while investigating implementation of arbitrary unitary operation upon distantly located quantum system, proven that the required resources for the same are those of implementing bidirectional QT. Furthermore, bidirectional controlled quantum teleportation is proposed in DV-regime by Zha et.al. [66], of which generalization is proposed by Shukla et.al. [67]. Bidirectional QT has received a renewed interests through investigating optimal input states and quantifying performance [68,69]. Bidirectional controlled quantum teleportation is a three-party scheme employing shared multi-particle

maximally or mixed entangled states as quantum channel in which communication of quantum-information encoded either in single qubit or in entangled qubits possessed by sender (receiver) are exchanged with the assistance of third party acting as ‘controller’. A sudden increase of interests is witnessed by many proposals on bidirectional QT [70-72] and its ramification in discrete variable regime on the basis of ‘to be teleported single (multi) qubit information-state’ at sender (receiver) end and, also various kinds of multi-qubit entangled state utilized as quantum channel [73,74]. Communication in quantum network, indispensably, necessitates exchange of quantum states possessed by parties such as asymmetric bidirectional quantum teleportation [75-77], cyclic quantum teleportation [78,79], cyclic ‘controlled’ quantum teleportation [80-82], multidirectional quantum teleportation in discrete variable regime [83,84].

Recently, applying ideal linear optical devices, a symmetric bidirectional cyclic quantum teleportation in which information-states at sender (receiver) station are encoded arbitrary superposed optical coherent states and penta-modal cluster-type entangled coherent states is employed as quantum channel [85]. Aliloute et.al. [86] designed a critically incorrect symmetric bidirectional QT scheme using tri-modal GHZ-entangled coherent states, but they made erroneous task by mixing Alice and Bob quantum information with a beam splitter destroying the encoding. Quite recently, we introduced a theoretical protocol for asymmetric bidirectional quantum teleportation. In this scheme, a sender transmits bi-modal entangled coherent states to a receiver, who simultaneously sends Schrödinger Cat coherent-states back to the sender [87]. Following the same idea, we have generalized our scheme to teleport an arbitrary four-component bi-modal entangled coherent states, continuous variable superposition information state, from Alice (sender) to Bob(receiver) who, simultaneously, endeavors to transmit Schrodinger Cat coherent-state to sender via employing a cluster Bell coherent-states as the quantum channel and utilizing linear optical gadgets. Heralding technique followed by classical communications of photon-counts and local unitary operations realized the simultaneous faithful and near-faithful asymmetric bidirectional quantum teleportation. One may notice that, for an intense coherent optical field, fidelity of near-faithful asymmetric bidirectional quantum teleportation approaches unit value.

The paper is organized in following Sections. Section (2) describes our scheme of bidirectional quantum teleportation with a continuous variable superposition state in detail. The analysis for probability of success and fidelity of near-faithful/ faithful is provided in

Section (3). Finally, conclusions are sketched based upon communication-complexity of proposed scheme and future prospects.

2. Bidirectional Quantum Teleportation Protocol

Alice has to teleport an arbitrary superposition of four-component bi-modal entangled coherent state,

$$|\psi\rangle_{AA'} = N_{AA'} (A_0|\alpha, \alpha\rangle + A_1|\alpha, -\alpha\rangle + A_2|-\alpha, \alpha\rangle + A_3|-\alpha, -\alpha\rangle) \quad (1)$$

where normalization constant,

$$N_{AA'} = \left[\sum_{i=0}^3 |A_i|^2 + 2e^{-2|\alpha|^2} \text{Re}(A_0^*A_2 + A_1^*A_3 + A_0^*A_1 + A_2^*A_3) + 2e^{-4|\alpha|^2} \text{Re}(A_0^*A_3 + A_1^*A_2) \right]^{-1/2}, \alpha \text{ is taken to be}$$

real for the sake of simplicity and without loss of generality, $\text{Re} \equiv \text{Real}$ and, also, Bob attempts to send a mono-modal superposition of coherent states encoded in Schrodinger Cat coherent-state, experimentally prepared [88, 89],

$$|\psi\rangle_B = N_B (B_0|\alpha\rangle + B_1|-\alpha\rangle) \quad (2)$$

where, N_B is a normalization constant $N_B = \left[\sum_{i=0}^1 |B_i|^2 + 2e^{-2|\alpha|^2} \text{Re}(B_1^*B_0) \right]^{-1/2}$, Since Alice's 'to be transmitted' state is an arbitrary bi-modal coherent state and that from Bob to Alice is mono-modal Schrodinger coherent Cat-states, the teleportation may, evidently, be termed as Asymmetric Bidirectional Quantum Teleportation (ABQT). To realize ABQT protocol, we employed hexa-modal entangled coherent states as a quantum channel,

$$|\psi\rangle_{1,2,3,4,5,6} = N_C |\Omega\rangle_{1,4} \otimes |\Omega\rangle_{2,5} \otimes |\Omega\rangle_{3,6}, \quad (3)$$

with normalization constant, $N_C = [8(1 + e^{-12|\alpha|^2} + 3e^{-8|\alpha|^2} + e^{-6|\alpha|^2} + 2e^{-4|\alpha|^2})]^{-1/2}$. To prepare quantum channel, Eq.(3), it suffices to prepare Bell coherent-states, say,

$$|\Omega\rangle_{i,j} = \hat{B} \left(\tilde{N} \left(|\alpha\sqrt{2}\rangle + |-\alpha\sqrt{2}\rangle \right)_x \otimes |0\rangle_y \right) = \tilde{N} \left(|\alpha, \alpha\rangle + |-\alpha, -\alpha\rangle \right)_{i,j} \xrightarrow{\hat{P}_j(\alpha) = e^{-i\hat{m}_j^{\dagger} \hat{p}_j}} = \tilde{N} \left(|\alpha, -\alpha\rangle + |-\alpha, \alpha\rangle \right)_{i,j},$$

where \hat{B} corresponds to "symmetric beam splitter with phase shifter" (BPS) operation, such that

$$\hat{B} \left(|\beta\rangle_x \otimes |\gamma\rangle_y \right) = \left| \frac{\beta + \gamma}{\sqrt{2}} \right\rangle_i, \left| \frac{\beta - \gamma}{\sqrt{2}} \right\rangle_j \quad (4)$$

The protocol is strategized by distributing modes of quantum channel; Eq. (3) such that Alice preserves modes 1,2 and 6 while Bob possesses modes 3, 4 and 5, respectively. The global state can, be expressed as, $|\varphi\rangle_{AA'B,1,2,3,4,5,6} = N_T (|\psi\rangle_{AA'} \otimes |\psi\rangle_B \otimes |\psi\rangle_{123456})$

$$|\varphi\rangle_{A,A',B,1,2,3,4,5,6} = N_T (A_0 B_0 |\alpha, \alpha, \alpha\rangle + A_0 B_1 |\alpha, \alpha, -\alpha\rangle + A_1 B_0 |\alpha, -\alpha, \alpha\rangle + A_1 B_1 |\alpha, -\alpha, -\alpha\rangle + A_2 B_0 |-\alpha, \alpha, \alpha\rangle + A_2 B_1 |-\alpha, \alpha, -\alpha\rangle + A_3 B_0 |-\alpha, -\alpha, \alpha\rangle + A_3 B_1 |-\alpha, -\alpha, -\alpha\rangle)_{A,A',B} \otimes |\psi\rangle_{123456}, \quad (5)$$

where, normalization constant, $N_T = N_C \times N$ and $N = N_{AA'} \times N_B$

Simultaneous ABQT protocol may be outlined in following steps:

Step1: Alice mixes quantum-information modes, (A) and (A') with quantum channel's modes 1&2 respectively, on a 'symmetric beam splitter with phase shifter' BPS-1 and BPS-2 of which output modes may be indexed as 7,8 and 9,10. Similarly, Bob mixes quantum-information mode, (B) on third BPS-3 of which output modes are 11 and 12 (see Figure.1).

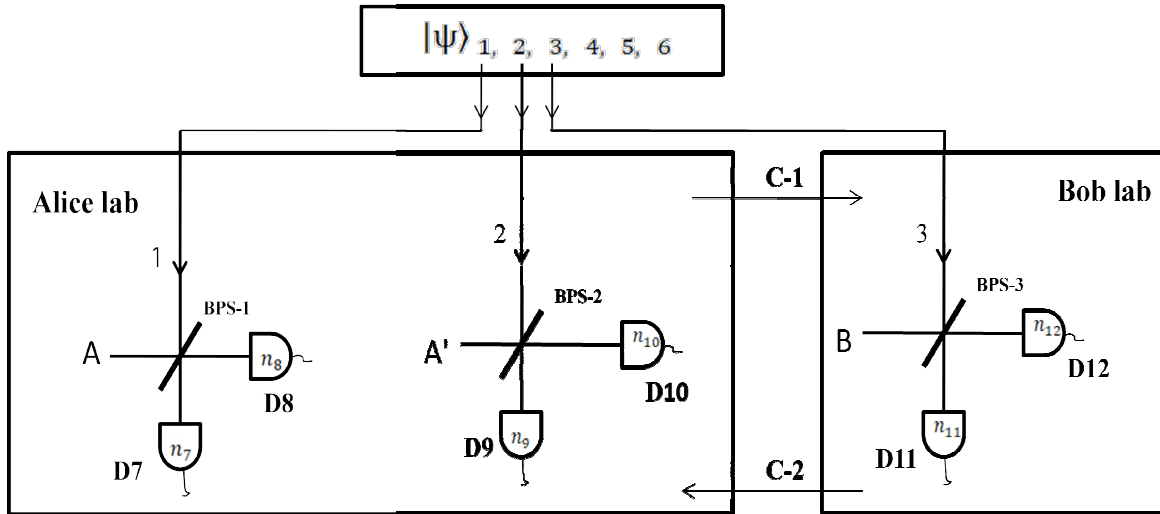

Figure1. Schematic diagram of the proposed scheme for ABQT. Alice mixes mode A,1 and A',2 using (BPS-1) and (BPS-2) followed by photon counting measurements at output modes n_{7-10} by photon-number resolving detectors D_{7-10} , respectively. Simultaneously, Bob mixes mode B,3 on BPS-3 with output modes (11,12) using detector D_{11-12} and communicate the outcomes (even and/or odd number of photons) to Alice and Bob using classical channels C_i (where $i=1,2$).

Applying Eq. (4) along with modes-mixing procedure spelled out in Step-1, Fig.1, we obtain global state, Eq. (A.1), in Appendix A Eq. (A.1), clearly, shows that there are null (vacuum) photons at various output modes of which presence play a significant role in photon counting measurements, see Step-3, Eqs. (7a-7h) below.

Step2- Alice performs photon-count measurements by the photon-number resolving detectors $n_{7,8}$ for output modes (7,8) from BPS-1 and $n_{9,10}$ for output modes (9,10) from BPS-2. Similarly, Bob does the same measurements via detectors $n_{11,12}$ for output modes (11,12) from BPS-3. That is to say, Eq. (A.1) in Appendix (A), collapses to a heralded state vector

$$|\chi(n_7, n_8, n_9, n_{10}, n_{11}, n_{12})\rangle_{4,5,6} = \langle n_7, n_8, n_9, n_{10}, n_{11}, n_{12} | \psi \rangle_{7,8,9,10,11,12,4,5,6} \quad (6)$$

Now, Alice sends the results of photon-number measurements n_{7-10} to Bob through classical channel and, at the same time, Bob communicates, classically, his photon-numbers n_{11-12} to Alice.

Step 3- Depending upon the null photon counts at various detectors, overall, eight cases may be identified for accomplishing simultaneous faithful (unit fidelity) ABQT. These cases are:

Case-(I): Now, Alice and Bob may find photons $n_7 = 0, n_8 \neq 0$ from detectors $D_{7,8}$; photons $n_9 = 0, n_{10} \neq 0$ from detectors $D_{9,10}$ and photons $n_{11} = 0, n_{12} \neq 0$ from detectors $D_{11,12}$, i.e., $|\chi^1(n_7=0, n_8, n_9=0, n_{10}, n_{11}=0, n_{12})\rangle_{4,5,6} = \langle 0, n_8, 0, n_{10}, 0, n_{12} | \psi \rangle_{7,8,9,10,11,12,4,5,6}$,

$$\begin{aligned} |\chi^1(0, n_8, 0, n_{10}, 0, n_{12})\rangle_{4,5,6} = & N(A_0 B_0 |\alpha, \alpha, \alpha\rangle + (-1)^{n_{12}} A_0 B_0 |\alpha, \alpha, -\alpha\rangle + (-1)^{n_{10}} A_1 B_0 |\alpha, -\alpha, \alpha\rangle + (-1)^{n_{10}+n_{12}} A_1 B_1 |\alpha, -\alpha, -\alpha\rangle \\ & + (-1)^{n_8} A_2 B_0 |-\alpha, \alpha, \alpha\rangle + (-1)^{n_8+n_{12}} A_2 B_1 |-\alpha, \alpha, -\alpha\rangle + (-1)^{n_8+n_{10}} A_3 B_0 |-\alpha, -\alpha, \alpha\rangle + (-1)^{n_8+n_{10}+n_{12}} A_3 B_1 |-\alpha, -\alpha, -\alpha\rangle)_{4,5,6} \quad (7a) \end{aligned}$$

Evidently, if photon-counts, n_8 , n_{10} , and n_{12} are even-numbered, the proposed ABQT scheme is simultaneously faithful for, the heralded state vector yields, $N_{AA} (A_0 |\alpha, \alpha\rangle + A_1 |\alpha, -\alpha\rangle + A_2 |-\alpha, \alpha\rangle + A_3 |-\alpha, -\alpha\rangle)_{4,5} \otimes N_B (B_0 |\alpha\rangle + B_1 |-\alpha\rangle)_6$, which is tensor product of ‘teleported’ arbitrary bi-modal entangled coherent states and Schrodinger Cat coherent-states at Bob and Alice, respectively, tabulated in fifth row of Table-1, Appendix B.

Case-(II): Next, Alice and Bob may find photons $n_7 \neq 0, n_8 = 0$ from detectors $D_{7,8}$; photons $n_9 \neq 0, n_{10} = 0$ from detectors $D_{9,10}$ and photons $n_{11} \neq 0, n_{12} = 0$ from detectors $D_{11,12}$, i.e.,

$$\begin{aligned} |\chi^2(n_7, n_8=0, n_9, n_{10}=0, n_{11}, n_{12}=0)\rangle_{4,5,6} = & \langle n_7, 0, n_9, 0, n_{11}, 0 | \psi \rangle_{7,8,9,10,11,12,4,5,6}, \\ |\chi^2(n_7, 0, n_9, 0, n_{11}, 0)\rangle_{4,5,6} = & N(A_0 B_0 |-\alpha, -\alpha, -\alpha\rangle + (-1)^{n_{11}} A_0 B_1 |-\alpha, -\alpha, \alpha\rangle + (-1)^{n_9} A_1 B_0 |-\alpha, \alpha, -\alpha\rangle + (-1)^{n_9+n_{11}} A_1 B_1 |-\alpha, \alpha, \alpha\rangle \\ & + (-1)^{n_7} A_2 B_0 |\alpha, -\alpha, -\alpha\rangle + (-1)^{n_7+n_{11}} A_2 B_1 |\alpha, -\alpha, \alpha\rangle + (-1)^{n_7+n_9} A_3 B_0 |\alpha, \alpha, -\alpha\rangle + (-1)^{n_7+n_9+n_{11}} A_3 B_1 |\alpha, \alpha, \alpha\rangle)_{4,5,6} \quad (7b) \end{aligned}$$

Eq. (7b) suggests that if n_7, n_9 and n_{11} are even, $|\chi^1\rangle_{4,5,6} = P_{4,5,6}(\pi)|\chi^2\rangle_{4,5,6}$, where, P is ψ -phase shifting unitary operator, $P(\psi) = \exp(-ia^\dagger a \psi)$ such that, $P(\psi)|\alpha\rangle \rightarrow |e^{i\psi}\alpha\rangle$, taking $\psi = \pi$, $|\alpha\rangle = |-\alpha\rangle$. This implies that simultaneous ABQT is faithfully achieved.

Case-(III): Next, Alice and Bob may find photons $n_7 \neq 0, n_8 = 0$ from detectors $D_{7,8}$; photons $n_9 \neq 0, n_{10} = 0$ from detectors $D_{9,10}$ and photons $n_{11} = 0, n_{12} \neq 0$ from detectors $D_{11,12}$, i.e.,

$$\begin{aligned} |\chi^3\rangle_{4,5,6} &= \langle n_7, 0, n_9, 0, 0, n_{12} | \psi \rangle_{7,8,9,10,11,12,4,5,6} \\ |\chi^3(n_7, 0, n_9, 0, 0, n_{12})\rangle_{4,5,6} &= N(A_0 B_0 |-\alpha, -\alpha, \alpha\rangle + (-1)^{n_{12}} A_0 B_1 |-\alpha, -\alpha, -\alpha\rangle + (-1)^{n_9} A_1 B_0 |-\alpha, \alpha, \alpha\rangle + (-1)^{n_9 + n_{12}} A_1 B_1 |-\alpha, \alpha, -\alpha\rangle \\ &+ (-1)^{n_7} A_2 B_0 |\alpha, -\alpha, \alpha\rangle + (-1)^{n_7 + n_{12}} A_2 B_1 |\alpha, -\alpha, -\alpha\rangle + (-1)^{n_7 + n_9} A_3 B_0 |\alpha, \alpha, \alpha\rangle + (-1)^{n_7 + n_9 + n_{12}} A_3 B_1 |\alpha, \alpha, -\alpha\rangle)_{4,5,6} \end{aligned} \quad (7c)$$

if n_7, n_9 and n_{12} are even, $|\chi^1\rangle_{4,5,6} = P_{4,5,6}(\pi)|\chi^3\rangle_{4,5,6}$ i.e., simultaneous faithful ABQT.

Case-(IV): Next, Alice and Bob may find photons $n_7 \neq 0, n_8 = 0$ from detectors $D_{7,8}$; photons $n_9 = 0, n_{10} \neq 0$ from detectors $D_{9,10}$ and photons $n_{11} \neq 0, n_{12} = 0$ from detectors $D_{11,12}$, i.e.,

$$\begin{aligned} |\chi^4\rangle_{4,5,6} &= \langle n_7, 0, 0, n_{10}, n_{11}, 0 | \psi \rangle_{7,8,9,10,11,12,4,5,6} \\ |\chi^4(n_7, 0, 0, n_{10}, n_{11}, 0)\rangle_{4,5,6} &= N(A_0 B_0 |-\alpha, \alpha, -\alpha\rangle + (-1)^{n_{11}} A_0 B_1 |-\alpha, \alpha, \alpha\rangle + (-1)^{n_{10}} A_1 B_0 |-\alpha, -\alpha, -\alpha\rangle + (-1)^{n_{10} + n_{11}} A_1 B_1 |-\alpha, -\alpha, \alpha\rangle \\ &+ (-1)^{n_7} A_2 B_0 |\alpha, \alpha, -\alpha\rangle + (-1)^{n_7 + n_{11}} A_2 B_1 |\alpha, \alpha, \alpha\rangle + (-1)^{n_7 + n_{10}} A_3 B_0 |\alpha, -\alpha, -\alpha\rangle + (-1)^{n_7 + n_{10} + n_{11}} A_3 B_1 |\alpha, -\alpha, \alpha\rangle)_{4,5,6} \end{aligned} \quad (7d)$$

if n_7, n_{10} and n_{11} are even, $|\chi^1\rangle_{4,5,6} = P_{4,6}(\pi)|\chi^4\rangle_{4,5,6}$ i.e., simultaneous faithful ABQT.

Case-(V): Next, Alice and Bob may find photons $n_7 \neq 0, n_8 = 0$ from detectors $D_{7,8}$; photons $n_9 = 0, n_{10} \neq 0$ from detectors $D_{9,10}$ and photons $n_{11} = 0, n_{12} \neq 0$ from detectors $D_{11,12}$, i.e.,

$$\begin{aligned} |\chi^5\rangle_{4,5,6} &= \langle n_7, 0, 0, n_{10}, 0, n_{12} | \psi \rangle_{7,8,9,10,11,12,4,5,6} \\ |\chi^5(n_7, 0, 0, n_{10}, 0, n_{12})\rangle_{4,5,6} &= N(A_0 B_0 |-\alpha, \alpha, \alpha\rangle + (-1)^{n_{12}} A_0 B_1 |-\alpha, \alpha, -\alpha\rangle + (-1)^{n_{10}} A_1 B_0 |-\alpha, -\alpha, \alpha\rangle + (-1)^{n_{10} + n_{12}} A_1 B_1 |-\alpha, -\alpha, -\alpha\rangle \\ &+ (-1)^{n_7} A_2 B_0 |\alpha, \alpha, \alpha\rangle + (-1)^{n_7 + n_{12}} A_2 B_1 |\alpha, \alpha, -\alpha\rangle + (-1)^{n_7 + n_{10}} A_3 B_0 |\alpha, -\alpha, \alpha\rangle + (-1)^{n_7 + n_{10} + n_{12}} A_3 B_1 |\alpha, -\alpha, -\alpha\rangle)_{4,5,6} \end{aligned} \quad (7e)$$

if n_7, n_{10} and n_{12} are even, $|\chi^1\rangle_{4,5,6} = P_4(\pi)|\chi^5\rangle_{4,5,6}$ i.e., simultaneous faithful ABQT.

Case-(VI): Next, Alice and Bob may find photons $n_7 = 0, n_8 \neq 0$ from detectors $D_{7,8}$; photons $n_9 \neq 0, n_{10} = 0$ from detectors $D_{9,10}$ and photons $n_{11} \neq 0, n_{12} = 0$ from detectors $D_{11,12}$, i.e.,

$$|\chi^6\rangle_{4,5,6} = \langle 0, n_8, n_9, 0, n_{11}, 0 | \psi \rangle_{7,8,9,10,11,12,4,5,6}$$

$$\begin{aligned}
|\chi^6(0, n_8, n_9, 0, n_{11}, 0)\rangle_{4,5,6} &= N(A_0 B_0 |\alpha, -\alpha, -\alpha\rangle + (-1)^{n_{11}} A_0 B_1 |\alpha, -\alpha, \alpha\rangle + (-1)^{n_9} A_1 B_0 |\alpha, \alpha, -\alpha\rangle + (-1)^{n_9+n_{11}} A_1 B_1 |\alpha, \alpha, \alpha\rangle \\
&+ (-1)^{n_8} A_2 B_0 |-\alpha, -\alpha, -\alpha\rangle + (-1)^{n_8+n_{11}} A_2 B_1 |-\alpha, -\alpha, \alpha\rangle + (-1)^{n_8+n_9} A_3 B_0 |-\alpha, \alpha, -\alpha\rangle + (-1)^{n_8+n_9+n_{11}} A_3 B_1 |-\alpha, \alpha, \alpha\rangle)_{4,5,6} \quad (7f)
\end{aligned}$$

if n_7, n_9 and n_{11} are even, $|\chi^1\rangle_{4,5,6} = P_{5,6}(\pi) |\chi^6\rangle_{4,5,6}$ i.e., simultaneous faithful ABQT.

Case-(VII): Next, Alice and Bob may find photons $n_7 = 0, n_8 \neq 0$ from detectors $D_{7,8}$; photons $n_9 \neq 0, n_{10} = 0$ from detectors $D_{9,10}$ and photons $n_{11} = 0, n_{12} \neq 0$ from detectors $D_{11,12}$, i.e.,

$$\begin{aligned}
|\chi^7\rangle_{4,5,6} &= \langle 0, n_8, n_9, 0, 0, n_{12} | \psi \rangle_{7,8,9,10,11,12,4,5,6} \\
|\chi^7(0, n_8, n_9, 0, 0, n_{12})\rangle_{4,5,6} &= N(A_0 B_0 |\alpha, -\alpha, \alpha\rangle + (-1)^{n_{12}} A_0 B_1 |\alpha, -\alpha, -\alpha\rangle + (-1)^{n_9} A_1 B_0 |\alpha, \alpha, \alpha\rangle + (-1)^{n_9+n_{12}} A_1 B_1 |\alpha, \alpha, -\alpha\rangle \\
&+ (-1)^{n_8} A_2 B_0 |-\alpha, -\alpha, \alpha\rangle + (-1)^{n_8+n_{12}} A_2 B_1 |-\alpha, -\alpha, -\alpha\rangle + (-1)^{n_8+n_9} A_3 B_0 |-\alpha, \alpha, \alpha\rangle + (-1)^{n_8+n_9+n_{12}} A_3 B_1 |-\alpha, \alpha, -\alpha\rangle)_{4,5,6} \quad (7g)
\end{aligned}$$

can be observed that n_8, n_9 and n_{12} are even, $|\chi^1\rangle_{4,5,6} = P_5(\pi) |\chi^7\rangle_{4,5,6}$ i.e., simultaneous faithful ABQT.

Case-(VIII): Next, Alice and Bob may find photons $n_7 = 0, n_8 \neq 0$ from detectors $D_{7,8}$; $n_9 = 0, n_{10} \neq 0$ from detectors $D_{9,10}$ and photons $n_{11} \neq 0, n_{12} = 0$ from detectors $D_{11,12}$ i.e.,

$$\begin{aligned}
|\chi^8\rangle_{4,5,6} &= \langle 0, n_8, 0, n_{10}, n_{11}, 0 | \psi \rangle_{7,8,9,10,11,12,4,5,6} \\
|\chi^8(0, n_8, 0, n_{10}, n_{11}, 0)\rangle_{4,5,6} &= N(A_0 B_0 |\alpha, \alpha, -\alpha\rangle + (-1)^{n_{11}} A_0 B_1 |\alpha, \alpha, \alpha\rangle + (-1)^{n_{10}} A_1 B_0 |\alpha, -\alpha, -\alpha\rangle + (-1)^{n_{10}+n_{11}} A_1 B_1 |\alpha, -\alpha, \alpha\rangle \\
&+ (-1)^{n_8} A_2 B_0 |-\alpha, \alpha, -\alpha\rangle + (-1)^{n_8+n_{11}} A_2 B_1 |-\alpha, \alpha, \alpha\rangle + (-1)^{n_8+n_{10}} A_3 B_0 |-\alpha, -\alpha, -\alpha\rangle + (-1)^{n_8+n_{10}+n_{11}} A_3 B_1 |-\alpha, -\alpha, \alpha\rangle)_{4,5,6} \quad (7h)
\end{aligned}$$

Similarly, if n_8, n_{10} and n_{11} are even, $|\chi^1\rangle_{4,5,6} = P_6(\pi) |\chi^8\rangle_{4,5,6}$ i.e., simultaneous faithful ABQT.

In general, probability of successful accomplishment of simultaneous faithful ABQT is nothing but finding number of photons n_{7-12} in various modes (7-12),

$$P = (n_7, n_8, n_9, n_{10}, n_{11}, n_{12}) = \sum_{n_7, n_8, \dots, n_{12}} \left| \langle n_7, n_8, n_9, n_{10}, n_{11}, n_{12} | \psi \rangle_{7,8,9,10,11,12,4,5,6} \right|^2, \quad (8)$$

where, $|\psi\rangle_{7,8,9,10,11,12,4,5,6}$ is given in Eq. (A1) in Appendix A. Evaluation of Eq. (8) for Case-I Eq. (7a) is $P_{\chi^1} = (n_8, n_{10}, n_{12}, 0, 0, 0) = 1/8$ for even n_8, n_{10}, n_{12} . The total ‘probability of success’ of simultaneous faithful ABQT (denoted by $A \leftrightarrow B$) scheme would, therefore, be

$$P_T^{A \leftrightarrow B} = \sum_{i=1}^8 P_{\chi^i} = 1 \text{ for intense optical coherent states } (\alpha^2 \rightarrow \infty). \text{ Evidently, total probability (}$$

$P_T^{A \leftrightarrow B}$) is independent of α , the modal amplitude of optical coherent field as well as the

unknown probability amplitudes $A_{0,3}$ of Alice's information-state and those of $B_{0,1}$ of Bob's information-state.

Step 4-Notably, Eqs. (7a-7h) do not demonstrate all exhaustive possibilities of detection of number of photons n_{7-12} from detectors D_{7-12} but there may exist several detection-events which are tabulated along with their consequent heralded states and local unitary operations in Alice's and Bob's lab in Tables (1-8), in Appendix B.

3. Probability of Success and Fidelity for Near-faithful Partial ABQT

A curious inspection of Tables (1-8) in Appendix B displays that not all detection-events accomplishes faithful ABQT but there exists cases wherein at least one uni-directional QT (either $A \rightarrow B$ or $B \rightarrow A$ or $A \rightleftharpoons B$). is near-faithful with finite probability of success, which may be termed as near-faithful partial ABQT, described below.

Firstly, Table-1, Eq. (7a), First row (Odd, Odd, Odd).

$$|\chi^1\rangle_{45} \otimes |\chi^1\rangle_6 = N_{AA'}(A_0|\alpha, \alpha\rangle - A_1|\alpha, -\alpha\rangle - A_2|-\alpha, \alpha\rangle + A_3|-\alpha, -\alpha\rangle)_{4,5} \otimes N_B(B_0|\alpha\rangle - B_1|-\alpha\rangle)_6 \quad (9)$$

Eq. (10), is not exactly same as information-states of Alice and Bob, but by application of displacement operator, $D_k(\delta) = \exp(\delta b_k^\dagger - \delta^* b_k)$ in Eq. (9) in Bob's lab, we obtain, taken, for simplicity, parameterization of probability amplitudes: $A_0 = \cos \theta$, $A_1 = \sin \theta$, $A_2 = \cos \phi$, $A_3 = \sin \phi$, $B_0 = \cos \theta_1$, $B_1 = \sin \theta_1$,

$$D_4\left(\frac{i\pi}{2\alpha}\right)D_5\left(\frac{i\pi}{2\alpha}\right)|\chi^1\rangle_{45} = |\xi\rangle_{4,5} = N_{AA'} e^{i\pi} \left(A_0 \left| \frac{i\pi}{2\alpha} + \alpha \right\rangle + A_1 \left| \frac{i\pi}{2\alpha} + \alpha \right\rangle + A_2 \left| \frac{i\pi}{2\alpha} - \alpha \right\rangle + A_3 \left| \frac{i\pi}{2\alpha} - \alpha \right\rangle \right)_{4,5} \quad (10)$$

And by following same technique in Alice lab, one obtains,

$$D_6\left(\frac{i\pi}{2\alpha}\right)|\chi^1\rangle_6 = |\zeta\rangle_6 = N_{BB'} e^{i\pi/2} \left(B_0 \left| \frac{i\pi}{2\alpha} + \alpha \right\rangle + B_1 \left| \frac{i\pi}{2\alpha} - \alpha \right\rangle \right)_6 \quad (11)$$

Hence, the fidelities and probabilities for success of near-faithful ABQT in this detection-events, Table-1, Eq. (7a), First row (Odd, Odd, Odd), in Bob's lab $F_1^{(I)A \rightarrow B} = \left| {}_{AA'} \langle \psi | \xi \rangle_{4,5} \right|^2$ and in Alice's lab $F_1^{(I)B \rightarrow A} = \left| {}_B \langle \psi | \zeta \rangle_6 \right|^2$ are given by, after insertion of Eqs. (10-11),

$$F_1^{(I)A \rightarrow B} = (N_{1AA'} N_{AA'})^2 e^{\frac{-\pi^2}{4\alpha^2}} \left(\sum_{i=0}^3 A_i^2 + 2e^{-4\alpha^2} (A_1 A_2 - A_0 A_3) \right)^2, P_1^{(I)A \rightarrow B} = \left(\frac{N_{AA'}}{8N_{1AA'}} \right)^2 \left(\frac{1 - e^{-2\alpha^2}}{1 + e^{-2\alpha^2}} \right)^2 \quad (12)$$

$$F_1^{(I)B \rightarrow A} = (N_{1B} N_B)^2 e^{\frac{-\pi^2}{8\alpha^2}} \left(\sum_{i=0}^1 B_i^2 + 2e^{-2\alpha^2} (B_0 B_1) \right)^2, P_1^{(I)B \rightarrow A} = \left(\frac{N_B}{8N_{1B}} \right)^2 \quad (13)$$

where, $(N_{1AA'})^{-2} = \sum_{i=0}^3 A_i^2 - 2e^{-2\alpha^2} (A_0 A_1 + A_0 A_2 + A_1 A_3 + A_2 A_3) + 2e^{-4\alpha^2} (A_0 A_3 + A_1 A_2)$, and

$$(N_{1B})^{-2} = \sum_{j=0}^1 B_j^2 - 2e^{-2\alpha^2} (B_0 B_1).$$

One may note that a characteristic property of displacement operator, $D_i(\beta)|\delta\rangle_i = \exp\left[\frac{1}{2}(\beta\delta^* - \beta^*\delta)\right]|\beta + \delta\rangle_i$, has been applied along with the expression for scalar product of optical coherent states, $\langle\beta|\delta\rangle = \exp[-(|\beta|^2 + |\delta|^2 - 2\beta^*\delta)/2]$. Clearly, one may note from Eqs (12-13) that in both cases ($A \rightarrow B$ and $B \rightarrow A$) the teleportation is nearly faithful and thereby, ‘Near-Faithfull Partial ABQT’, plotted in Figure 2 to assess dependencies of fidelities on probability-amplitudes θ, ϕ as well α as on the modal-amplitudes of optical coherent states. It is instructive to infer that Fidelities in Alice’s and Bob’s lab approaches, asymptotically, near unit-values for intense coherent optical field. Numerically, it may be seen that fidelities tends to unity for $\alpha \geq 5$.

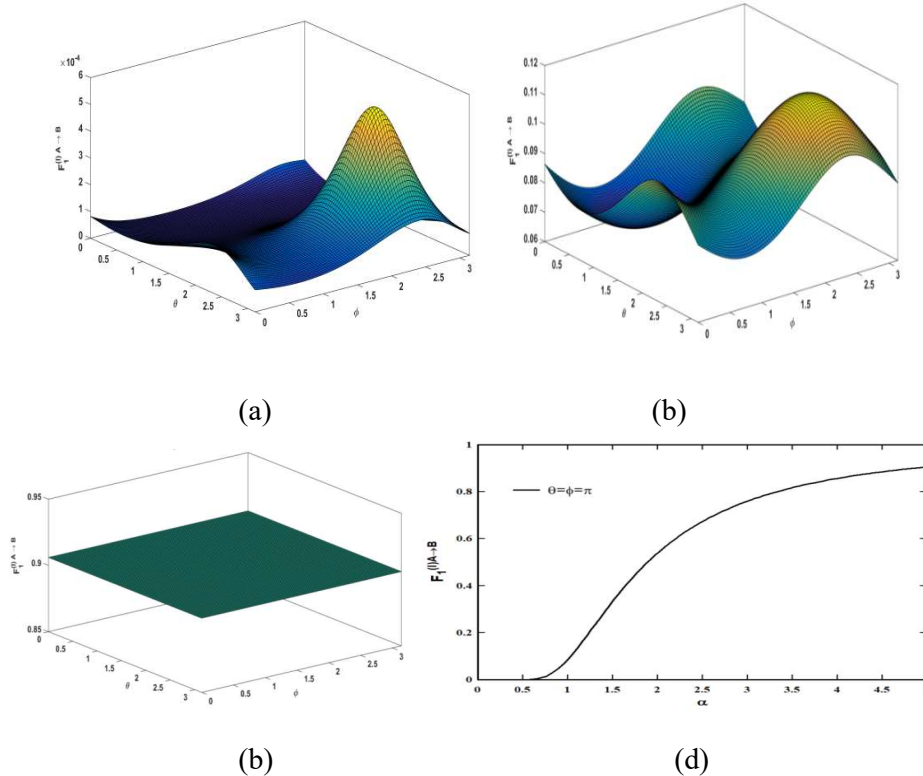

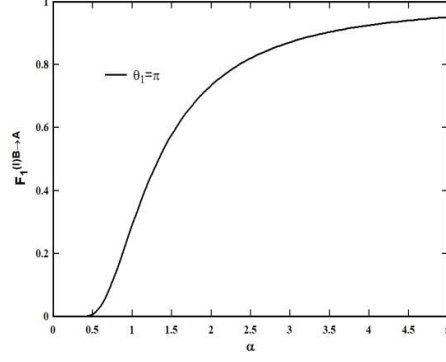

(c)

Figure 2. (a), (b) and (c) are $F_1^{(I)A \rightarrow B}$ Vs Θ, Φ for $\alpha = 0.5, 1$ and 5 , respectively, (d) and (e) is the dependence of $F_1^{(I)A \rightarrow B}$ and $F_1^{(I)B \rightarrow A}$ on α for $\Theta_1 = \pi$.

Following similar lineage one may evaluate fidelities and probabilities for other detection-events in Table-1, for, Eq. (7a), Second row (Odd, Odd, Even),

$$F_2^{(I)A \rightarrow B} = (N_{2AA'} N_{AA'})^2 e^{\frac{-\pi^2}{4\alpha^2}} \left(\sum_{i=0}^3 A_i^2 + 2e^{-2\alpha^2} (A_1 A_2 - A_0 A_3) \right)^2, P_2^{(I)A \rightarrow B} = \left(\frac{N_{AA'}}{8N_{2AA'}} \right)^2 \left(\frac{1 - e^{-2\alpha^2}}{1 + e^{-2\alpha^2}} \right)^2 \quad (14)$$

$$F_2^{(I)B \rightarrow A} = 1, P_2^{(I)B \rightarrow A} = 1/64 \quad (15)$$

$$\text{where } (N_{2AA'})^{-2} = \sum_{i=0}^3 A_i^2 - 2e^{-2\alpha^2} (A_0 A_1 + A_0 A_2 + A_1 A_3 + A_2 A_3) + 2e^{-4\alpha^2} (A_0 A_3 + A_1 A_2), \quad \text{and } (N_{2B})^{-2} = \sum_{j=0}^1 B_j^2 + 2e^{-2\alpha^2} (B_0 B_1).$$

Obviously, Eq. (14) the teleportation in one direction ($A \rightarrow B$) is near faithful QT and in backward direction ($B \rightarrow A$) is faithful QT i.e, it is near-faithful partial ABQT.

Next, for Table-1, Eq. (7a), Third row (Odd, Even, Odd)

$$F_3^{(I)A \rightarrow B} = (N_{3AA'} N_{AA'})^2 e^{\frac{-\pi^2}{8\alpha^2}} \left(\sum_{i=0}^3 A_i^2 + 2e^{-2\alpha^2} (A_0 A_1 + A_2 A_3) \right)^2, P_3^{(I)A \rightarrow B} = \left(\frac{N_{AA'}}{8N_{3AA'}} \right)^2 \left(\frac{1 + e^{-4\alpha^2}}{1 - e^{-4\alpha^2}} \right)^2 \quad (16)$$

$$F_3^{(I)B \rightarrow A} = (N_{3B} N_B)^2 e^{\frac{-\pi^2}{8\alpha^2}} \left(\sum_{j=0}^1 B_j^2 + 2e^{-2\alpha^2} (B_0 B_1) \right)^2, P_3^{(I)B \rightarrow A} = \left(\frac{N_B}{8N_{3B}} \right)^2 \quad (17)$$

$$\text{where, } (N_{3AA'})^{-2} = \sum_{i=0}^3 A_i^2 + 2e^{-2\alpha^2} (A_0 A_1 + A_2 A_3 - A_0 A_2 - A_1 A_3) - 2e^{-4\alpha^2} (A_0 A_3 + A_1 A_2) \quad \text{and}$$

$$(N_{3B})^{-2} = \sum_{j=0}^1 B_j^2 - 2e^{-2\alpha^2} (B_0 B_1).$$

Evidently, Eqs. (16-17) demonstrates that in both directions ($A \rightarrow B$) and ($B \rightarrow A$) the QT is nearly faithful and, thus, it is near-faithful partial ABQT. Plot of Eq.(16) are in Figure 3 to assess dependence of fidelities on probability-amplitudes parameters Θ , Φ as well as α on amplitudes of optical coherent states.

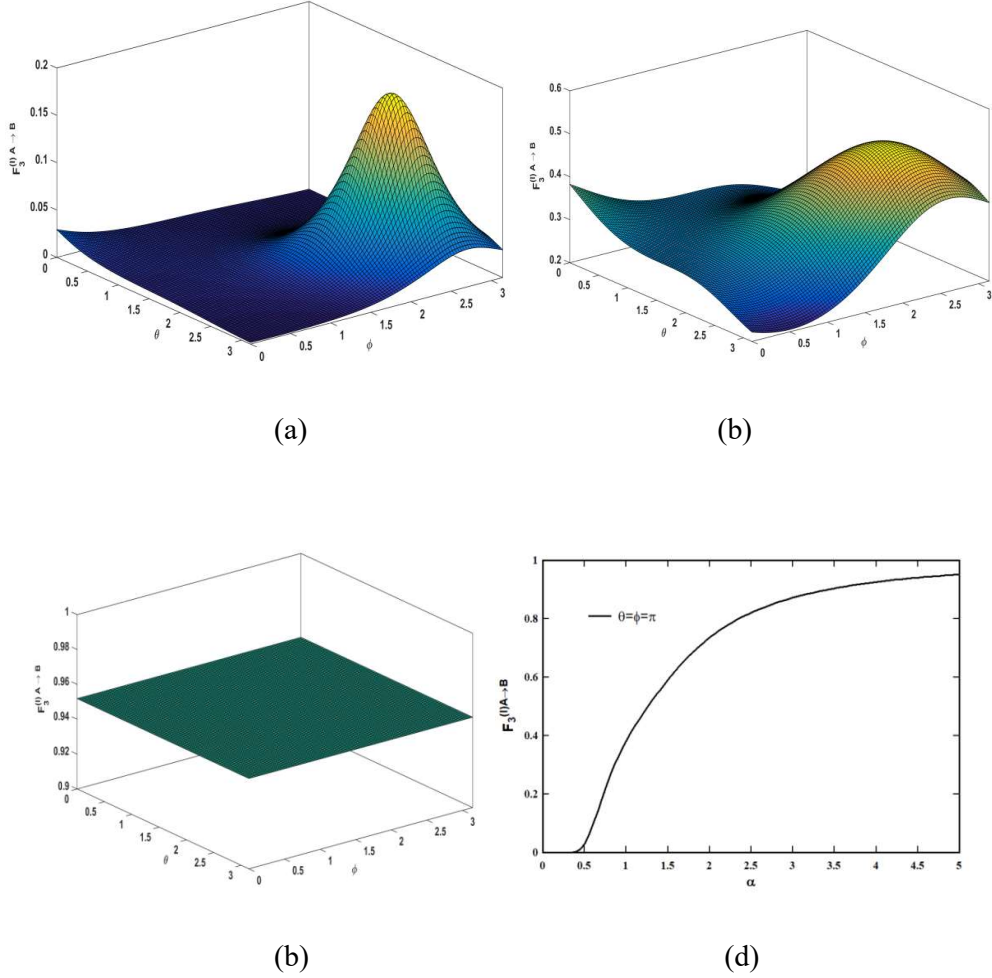

Figure 3. (a), (b) and (c) are $F_3^{(I)A \rightarrow B}$ vs Θ, Φ for $\alpha = 0.5, 1$ and 5 , respectively, (d) is the dependence of $F_3^{(I)A \rightarrow B}$ on α for $\Theta = \Phi = \pi$.

Next, for Table-1, Eq. (7a), Fourth row (Even, Odd, Odd),

$$F_4^{(I)A \rightarrow B} = (N_{4AA'} N_{AA'})^2 e^{\frac{-\pi^2}{8\alpha^2}} \left(\sum_{i=0}^3 A_i^2 + 2e^{-2\alpha^2} (A_0 A_2 + A_1 A_3) \right)^2, \quad P_4^{(I)A \rightarrow B} = \left(\frac{N_{AA'}}{8N_{4AA'}} \right)^2 \left(\frac{1 + e^{-4\alpha^2}}{1 - e^{-4\alpha^2}} \right) \quad (18)$$

$$F_4^{(I)B \rightarrow A} = (N_{4B} N_B)^2 e^{\frac{-\pi^2}{8\alpha^2}} \left(\sum_{j=0}^1 B_j^2 + 2e^{-2\alpha^2} (B_0 B_1) \right)^2, P_4^{(I)B \rightarrow A} = \left(\frac{N_B}{8 N_{4B}} \right)^2 \quad (19)$$

where, $(N_{4AA'})^{-2} = \sum_{i=0}^3 A_i^2 - 2e^{-2\alpha^2} (A_0 A_1 + A_0 A_2 + A_1 A_3 - A_2 A_3) + 2e^{-4\alpha^2} (A_0 A_3 + A_1 A_2)$ and

$$(N_{4B})^{-2} = \sum_{j=0}^1 B_j^2 - 2e^{-2\alpha^2} (B_0 B_1).$$

Evidently, Eqs. (18-19) demonstrates that in both directions ($A \rightarrow B$) and ($B \rightarrow A$) the QT is nearly faithful and, thus, it is near-faithful partial ABQT. Plot of Eqs. (18) are in Figure 4 to assess dependence of fidelities on probability-amplitudes parameters Θ , Φ , as well as α on amplitudes of optical coherent states.

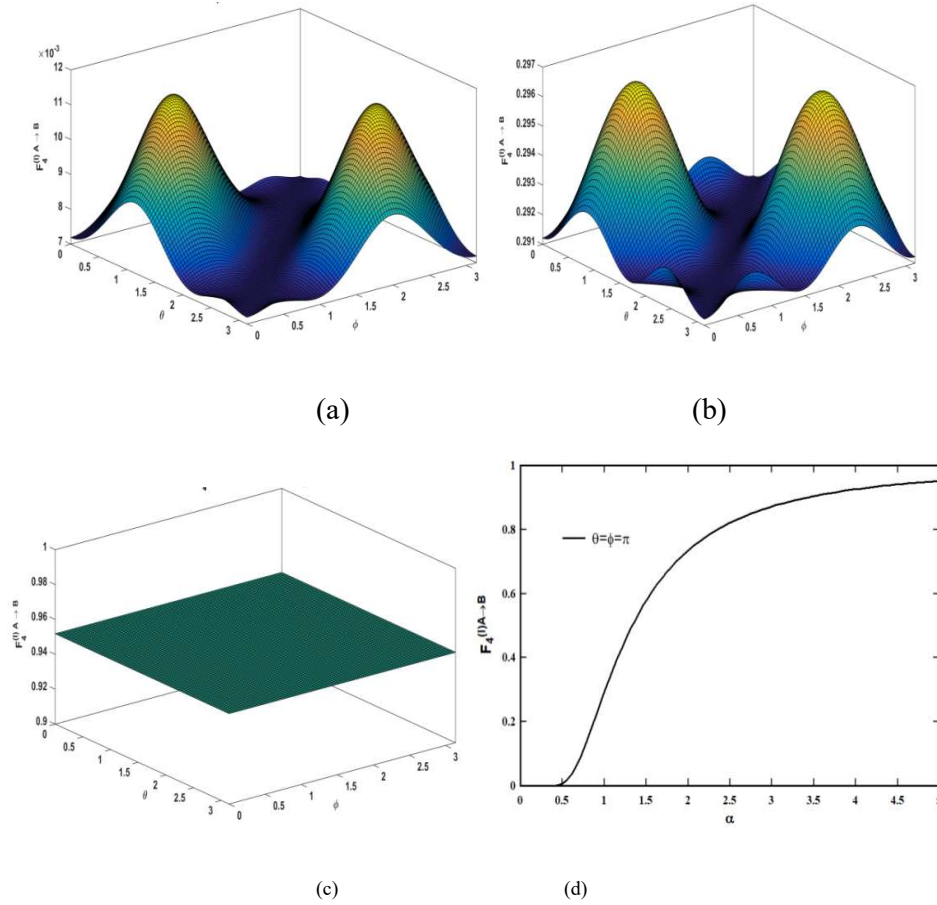

Figure 4. (a), (b) and (c) are $F_4^{(I)A \rightarrow B}$ vs Θ, Φ for $\alpha = 0.5, 1$ and 5 , respectively, (d) is the dependence of $F_4^{(I)A \rightarrow B}$ on α for $\Theta = \Phi = \pi$.

Next, for Table-1, Eq. (7a), Fifth row (Even, Even, Even)

$$F_5^{(I)A \rightarrow B} = 1, P_5^{(I)A \rightarrow B} = 1/64 \quad (20)$$

$$F_5^{(I)B \rightarrow A} = 1, P_5^{(I)B \rightarrow A} = 1/64 \quad (21)$$

where, $(N_{5AA})^{-2} = \sum_{i=0}^3 A_i^2 + 2e^{-2\alpha^2} (A_0A_2 + A_1A_3 + A_0A_1 + A_2A_3) + 2e^{-4\alpha^2} (A_0A_3 + A_1A_2)$ and

$$(N_{5B})^{-2} = \sum_{j=0}^1 B_j^2 + 2e^{-2\alpha^2} (B_0B_1).$$

Clearly, in both directions ($A \rightarrow B$) and ($B \rightarrow A$) the faithful teleportation is achieved i.e, faithful partial ABQT described separately in forward and backward directions.

Next, Table-1, Eq. (7a), Six row (Even, Even, Odd),

$$F_6^{(I)A \rightarrow B} = 1, P_6^{(I)A \rightarrow B} = 1/64 \quad (22)$$

$$F_6^{(I)B \rightarrow A} = (N_{6B} N_B)^2 e^{\frac{-\pi^2}{8\alpha^2}} \left(\sum_{j=0}^1 B_j^2 + 2e^{-2\alpha^2} (B_0B_1) \right)^2, P_6^{(I)B \rightarrow A} = \left(\frac{N_B}{8N_{6B}} \right)^2 \quad (23)$$

where, $(N_{6AA})^{-2} = \sum_{i=0}^3 A_i^2 + 2e^{-2\alpha^2} (A_0A_2 + A_1A_3 + A_0A_1 + A_2A_3) + 2e^{-4\alpha^2} (A_0A_3 + A_1A_2)$ and $(N_{6B})^{-2} = \sum_{j=0}^1 B_j^2 - 2e^{-2\alpha^2} (B_0B_1)$,

Evidently, Eq. (23) demonstrates that in one directions ($B \rightarrow A$) the QT is nearly faithful and, thus, it is near-faithful partial ABQT.

Table-1, Eq. (7a), Seventh row (Even, Odd, Even),

$$F_7^{(1)B \rightarrow A} = 1 \quad \text{and} \quad P_7^{(1)B \rightarrow A} = 1/64 \quad (24)$$

$$F_7^{(I)A \rightarrow B} = (N_{7AA} N_{AA'})^2 e^{\frac{-\pi^2}{8\alpha^2}} \left(\sum_{i=0}^3 A_i^2 + 2e^{-2\alpha^2} (A_0A_2 + A_1A_3) \right)^2, P_7^{(I)A \rightarrow B} = \left(\frac{N_{AA'}}{8N_{7AA'}} \right)^2 \left(\frac{1+e^{-4\alpha^2}}{1-e^{-4\alpha^2}} \right) \quad (25)$$

where $(N_{7AA})^{-2} = \sum_{i=0}^3 A_i^2 - 2e^{-2\alpha^2} (A_0A_1 + A_0A_2 + A_1A_3 - A_2A_3) + 2e^{-4\alpha^2} (A_0A_3 + A_1A_2)$ and $(N_{7B})^{-2} = \sum_{j=0}^1 B_j^2 - 2e^{-2\alpha^2} (B_0B_1)$.

Clearly, Eq. (25) demonstrates that in one directions ($A \rightarrow B$) the QT is nearly faithful and, thus, it is near-faithful partial ABQT.

Next Table-1, Eq. (7a), Eighth row (Odd, Even, Even),

$$F_8^{(1)B \rightarrow A} = 1 \quad \text{and} \quad P_8^{(1)B \rightarrow A} = 1/64 \quad (26)$$

$$F_8^{(I)A \rightarrow B} = (N_{8AA'} N_{AA'})^2 e^{\frac{-\pi^2}{8\alpha^2}} \left(\sum_{i=0}^3 A_i^2 + 2e^{-2\alpha^2} (A_0A_1 + A_2A_3) \right)^2, P_8^{(I)A \rightarrow B} = \left(\frac{N_{AA'}}{8N_{8AA'}} \right)^2 \quad (27)$$

where, $(N_{8AA})^{-2} = \sum_{i=0}^3 A_i^2 + 2e^{-2\alpha^2} (A_0A_1 + A_2A_3 - A_0A_2 - A_1A_3) - 2e^{-4\alpha^2} (A_0A_3 + A_1A_2)$ and

$$(N_{8B})^{-2} = \sum_{j=0}^1 B_j^2 - 2e^{-2\alpha^2} (B_0B_1).$$

Clearly, Eq. (27) demonstrates that in one directions ($A \rightarrow B$) the QT is nearly faithful and, thus, it is near-faithful partial ABQT.

One may calculate fidelities for entire Cases (I-VIII) described by Eqs. (7a-7h). It is seen that not all fidelities are different for,

$$\begin{aligned} F_1^{(I)A \rightarrow B} &= F_1^{(II)A \rightarrow B} = F_1^{(III)A \rightarrow B} = F_1^{(IV)A \rightarrow B} = F_1^{(V)A \rightarrow B} = F_1^{(VI)A \rightarrow B} = F_1^{(VII)A \rightarrow B} = F_1^{(VIII)A \rightarrow B} = F_2^{(I)A \rightarrow B} = F_2^{(II)A \rightarrow B} \\ &= F_2^{(III)A \rightarrow B} = F_2^{(IV)A \rightarrow B} = F_2^{(V)A \rightarrow B} = F_2^{(VI)A \rightarrow B} = F_2^{(VII)A \rightarrow B} = F_2^{(VIII)A \rightarrow B}, \end{aligned}$$

$$\begin{aligned} F_3^{(I)A \rightarrow B} &= F_3^{(II)A \rightarrow B} = F_3^{(III)A \rightarrow B} = F_3^{(IV)A \rightarrow B} = F_3^{(V)A \rightarrow B} = F_3^{(VI)A \rightarrow B} = F_3^{(VII)A \rightarrow B} = F_3^{(VIII)A \rightarrow B} = F_8^{(I)A \rightarrow B} = F_8^{(II)A \rightarrow B} \\ &= F_8^{(III)A \rightarrow B} = F_8^{(IV)A \rightarrow B} = F_8^{(V)A \rightarrow B} = F_8^{(VI)A \rightarrow B} = F_8^{(VII)A \rightarrow B} = F_8^{(VIII)A \rightarrow B}, \end{aligned}$$

$$\begin{aligned} F_4^{(I)A \rightarrow B} &= F_4^{(II)A \rightarrow B} = F_4^{(III)A \rightarrow B} = F_4^{(IV)A \rightarrow B} = F_4^{(V)A \rightarrow B} = F_4^{(VI)A \rightarrow B} = F_4^{(VII)A \rightarrow B} = F_4^{(VIII)A \rightarrow B} = F_7^{(I)A \rightarrow B} = F_7^{(II)A \rightarrow B} \\ &= F_7^{(III)A \rightarrow B} = F_7^{(IV)A \rightarrow B} = F_7^{(V)A \rightarrow B} = F_7^{(VI)A \rightarrow B} = F_7^{(VII)A \rightarrow B} = F_7^{(VIII)A \rightarrow B}, \end{aligned}$$

$$\begin{aligned} F_5^{(I)A \rightarrow B} &= F_5^{(II)A \rightarrow B} = F_5^{(III)A \rightarrow B} = F_5^{(IV)A \rightarrow B} = F_5^{(V)A \rightarrow B} = F_5^{(VI)A \rightarrow B} = F_5^{(VII)A \rightarrow B} = F_5^{(VIII)A \rightarrow B} = F_6^{(I)A \rightarrow B} = F_6^{(II)A \rightarrow B} \\ &= F_6^{(III)A \rightarrow B} = F_6^{(IV)A \rightarrow B} = F_6^{(V)A \rightarrow B} = F_6^{(VI)A \rightarrow B} = F_6^{(VII)A \rightarrow B} = F_6^{(VIII)A \rightarrow B} \end{aligned}$$

Similarly, one may notice that Fidelities from Bob to Alice bears following equalities,

$$\begin{aligned} F_1^{(I)B \rightarrow A} &= F_1^{(II)B \rightarrow A} = F_1^{(III)B \rightarrow A} = F_1^{(IV)B \rightarrow A} = F_1^{(V)B \rightarrow A} = F_1^{(VI)B \rightarrow A} = F_1^{(VII)B \rightarrow A} = F_1^{(VIII)B \rightarrow A} = F_3^{(I)B \rightarrow A} = \\ &F_3^{(II)B \rightarrow A} = F_3^{(III)B \rightarrow A} = F_3^{(IV)B \rightarrow A} = F_3^{(V)B \rightarrow A} = F_3^{(VI)B \rightarrow A} = F_3^{(VII)B \rightarrow A} = F_3^{(VIII)B \rightarrow A} = F_4^{(I)B \rightarrow A} = F_4^{(II)B \rightarrow A} = \\ &F_4^{(III)B \rightarrow A} = F_4^{(IV)B \rightarrow A} = F_4^{(V)B \rightarrow A} = F_4^{(VI)B \rightarrow A} = F_4^{(VII)B \rightarrow A} + F_4^{(VIII)B \rightarrow A} = F_6^{(I)B \rightarrow A} = F_6^{(II)B \rightarrow A} = F_6^{(III)B \rightarrow A} = \\ &F_6^{(IV)B \rightarrow A} = F_6^{(V)B \rightarrow A} = F_6^{(VI)B \rightarrow A} = F_6^{(VII)B \rightarrow A} = F_6^{(VIII)B \rightarrow A}, \end{aligned}$$

$$\begin{aligned} F_2^{(I)B \rightarrow A} &= F_2^{(II)B \rightarrow A} = F_2^{(III)B \rightarrow A} = F_2^{(IV)B \rightarrow A} = F_2^{(V)B \rightarrow A} = F_2^{(VI)B \rightarrow A} = F_2^{(VII)B \rightarrow A} = F_2^{(VIII)B \rightarrow A} = F_5^{(I)B \rightarrow A} = \\ &F_5^{(II)B \rightarrow A} = F_5^{(III)B \rightarrow A} = F_5^{(IV)B \rightarrow A} = F_5^{(V)B \rightarrow A} = F_5^{(VI)B \rightarrow A} = F_5^{(VII)B \rightarrow A} = F_5^{(VIII)B \rightarrow A} = F_7^{(I)B \rightarrow A} = F_7^{(II)B \rightarrow A} = \\ &F_7^{(III)B \rightarrow A} = F_7^{(IV)B \rightarrow A} = F_7^{(V)B \rightarrow A} = F_7^{(VI)B \rightarrow A} = F_7^{(VII)B \rightarrow A} = F_7^{(VIII)B \rightarrow A} = F_8^{(I)B \rightarrow A} = F_8^{(II)B \rightarrow A} = F_8^{(III)B \rightarrow A} = \\ &F_8^{(IV)B \rightarrow A} = F_8^{(V)B \rightarrow A} = F_8^{(VI)B \rightarrow A} = F_8^{(VII)B \rightarrow A} = F_8^{(VIII)B \rightarrow A} \end{aligned}$$

Finally the ‘Average Fidelity’ of entire scheme from ($A \rightarrow B$) and ($B \rightarrow A$) can be defined as,

$$F_{av}^{A \rightarrow B} = \sum_{i=1}^8 (F_i^{(I)A \rightarrow B} P_i^{(I)A \rightarrow B} + F_i^{(II)A \rightarrow B} P_i^{(II)A \rightarrow B} + \dots + F_i^{(VIII)A \rightarrow B} P_i^{(VIII)A \rightarrow B}) \quad (28)$$

$$F_{av}^{B \rightarrow A} = \sum_{j=1}^8 (F_j^{(I)B \rightarrow A} P_j^{(I)B \rightarrow A} + F_j^{(II)B \rightarrow A} P_j^{(II)B \rightarrow A} + \dots + F_j^{(VIII)B \rightarrow A} P_j^{(VIII)B \rightarrow A}) \quad (29)$$

Plots of Eqs. (28-29), Figure 5 clearly, displays that Average fidelity is independent of probability-amplitudes parameters Θ , Φ as well as α on amplitudes of optical coherent states.

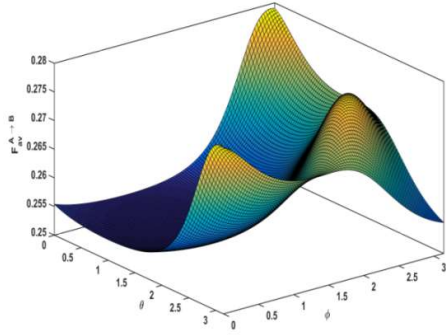

(a)

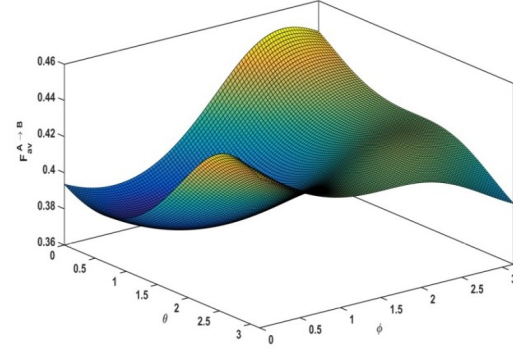

(b)

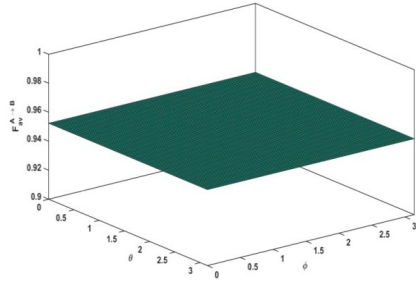

(c)

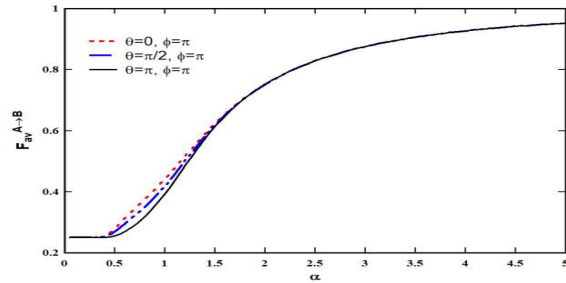

(d)

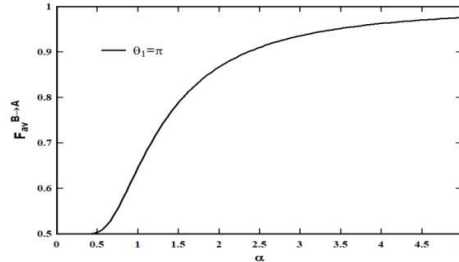

(e)

Figure 5. (a), (b) and (c) are $F_{av}^{A \rightarrow B}$ vs Θ , Φ for $\alpha = 0.5, 1$ and 5 respectively, (d) is the dependence of $F_{av}^{A \rightarrow B}$ Vs $[\Theta, \Phi] = [0, \pi]$, $[\Theta, \Phi] = [\pi/2, \pi]$, $[\Theta, \Phi] = [\pi, \pi]$, and (e) $F_{av}^{B \rightarrow A}$ dependent on α for $\Theta_1 = \pi$.

Communication complexity and future prospects.

We have presented a protocol for a simultaneous faithful ABQT and near-faithful partial ABQT schemes. The communication complexity of the protocol may, easily, be recognized as three classical bits: two classical bit from Alice to Bob and one classical bit from Bob to Alice, if one encodes (ODD, EVEN) as (0,1), respectively, and the three e-bits because three Bell Coherent-states are needed to prepare quantum resource employed as the quantum channel. The scheme worked out, here, may be generalized by invoking hybrid QT in which QT is for forward direction and remote-state preparation in reverse direction or increasing number of parties involved in QT, which necessitates new publications.

Acknowledgement

We acknowledge Prof. Lev Vaidman, School of Physics and Astronomy, Tel Aviv University, Israel and Prof. Mark M. Wilde, School of Electrical and Computer Engineering Cornell University, New York for drawing our attention toward their investigations on continuous variable quantum teleportation and bidirectional quantum teleportation.

References:

- [1] Bennett, C. H. et al. Teleporting an unknown quantum state via dual classical and Einstein-Podolsky-Rosen channels. *Phys. Rev. Lett.* **70**, 1895–1899 (1993).
- [2] Vaidman, L. Teleportation of Quantum states. *Phys. Rev. A* **49**, 1473 (1994).
- [3] Aharonov, C. Y. & Albert D. Z. States and observables in relativistic quantum field theories, *Phys. Rev. D* **21**, 3316-3324 (1980).
- [4] Aharonov, C. Y. & Albert, D. Z. Can we make sense out of the measurement process in relativistic quantum mechanics, *Phys. Rev. D* **24**,359-370 (1981).
- [5] Braunstein, S. L.& Kimble, H. J. Teleportation of Continuous Quantum Variables. *Phys. Rev. Lett.* **80**, 869 (1998).
- [6] Bennett, C. H. & Brassard, G. Quantum cryptography: public key distribution and coin tossing, *Int. conf. Computers, Systems & Signal Processing*. Bangalore, India, December 10-12, 175-179 (1984).
- [7] Ekert, K. Quantum Cryptography Based on Bell's Theorem. *Phys. Lett. A* **67**, 661-663 (1991).
- [8] Bennett, C. H. & Wiesner, S. J. Communication via one- and two-particle operators on Einstein-Podolsky-Rosen states. *Phys. Rev. Lett.* **69**, 2881–2884(1992).
- [9] Long, G. L. & Liu, X. S. Theoretically efficient high-capacity quantum-key-distribution scheme. *Phys. Rev. A* **65**, 032302 (2002).

- [10] Hillery, M., Bužek, V. & Berthiaume, A. Quantum secret sharing. *Phys. Rev. A* **59**, 1829 (1999).
- [11] Lo, H.-K. Classical-communication cost in distributed quantum-information processing: A generalization of quantum-communication complexity. *Physical Rev. A* **62**, 1(2000).
- [12] Pati, K. Minimum classical bit for remote preparation and measurement of a qubit. *Phys. Rev. A* **63**, 1 (2000).
- [13] Ishizaka, S. & Hiroshima, T. Asymptotic Teleportation Scheme as a Universal Programmable Quantum Processor. *Phys. Rev. Lett.* **101**, 24 (2008).
- [14] Ishizaka, S. & Hiroshima, T. Quantum teleportation scheme by selecting one of multiple output ports. *Phys. Rev. A* **79**, 4(2009).
- [15] Salih, H., Li, Z.-H., Al-Amri, & Zubairy, M. M. S. Protocol for Direct Counterfactual Quantum Communication. *Phys. Rev. Lett.* **110**, 17(2013).
- [16] Xu, X. Enhancing quantum entanglement and quantum teleportation for two-mode squeezed vacuum state by local quantum-optical catalysis. *Phys. Rev. A* **92**, 1 (2015).
- [17] Bartosik, P. L. & Skrzypczyk, P. Catalytic quantum teleportation and beyond. *Phys. Rev. Lett.* **127**, 080502 (2021)
- [18] Wen, Z., Yi, Y., Xu, X. Continuous-variable quantum teleportation with entanglement enabled via photon catalysis. *Quantum Inf. Process.* **21**, 325 (2022).
- [19] Bouwmeester, D., Pan, et al. Experimental quantum teleportation. *Nature* **390**, 575–579 (1997).
- [20] Ursin, R., Aspelmeyer, et al. Quantum teleportation across the Danube. *Nature* **430**, 849 (2004).
- [21] Boschi, D., Branca, et al. Experimental Realization of Teleporting an Unknown Pure Quantum State via Dual Classical and Einstein-Podolski-Rosen Channels. *Phys. Rev. Lett.* **80**, 1121–1125 (1998).
- [22] Jin, X.-M., Ren, J.-G. et al. Experimental Free-Space Quantum Teleportation. *Nature Photonics* **4**, 376 (2010).
- [23] Kim, Y.-H., Kulik, S. P. & Shih, Y. Quantum Teleportation of a Polarization State with a Complete Bell State Measurement. *Phys. Rev. Lett.* **86**, 1370 (2001).
- [24] Riedmatten, H. de, Marcikic, I., Tittel, W., Zbinden, H., Collins, D. & Gisin, N. Long Distance Quantum Teleportation in a Quantum Relay Configuration. *Phys. Rev. Lett.* **92**, 047904 (2004).
- [25] Furusawa, A. Unconditional quantum teleportation. *Science* **282**, 706 (1998).
- [26] Bowen, W. P., Treps, N. et al. Experimental investigation of continuous-variable quantum teleportation. *Phys. Rev. A* **67**, 032302 (2003).
- [27] Yukawa, M., Benichi, H. & Furusawa, A. High-fidelity continuous-variable quantum teleportation toward multistep quantum operations. *Phys. Rev. A* **77**, 022314 (2008).
- [28] Nielsen, M. A., Knill, E. & Laflamme, R. Complete quantum teleportation using nuclear magnetic resonance. *Nature* **396**, 52–55 (1998).
- [29] Sherson, J. F., et al. Quantum teleportation between light and matter. *Nature* **443**, 557–560 (2006).
- [30] Bao, X.-H. et al. Quantum Communication Networks for Energy Applications: Review and Perspective. *Proceedings of the National Academy of Sciences* **109**, 20347 (2012),
- [31] Chen, Y.-A. et al. Memory-built-in quantum teleportation with photonic and atomic qubits, *Nature Physics* **4**, 103–107 (2008).
- [32] Barrett, M. D. et al. Deterministic quantum teleportation of atomic qubits. *Nature* **429**, 737 (2004).

- [33] Olmschenk, S. et al. Quantum teleportation between distant matter qubits. *Science***323**, 486–489 (2009).
- [34] Nölleke, C., Neuzner, A., Reiserer, A., Hahn, C., Rempe, G. & Ritter, S. Efficient Teleportation Between Remote Single-Atom Quantum Memories. *Phys. Rev. Lett.***110**, 140403 (2013).
- [35] Gao, W., et al. Quantum teleportation from a propagating photon to a solid-state spin qubit. *Nature Communication***4**, 3744 (2013).
- [36] Steffen, Y., Salathe, L. Realization of Deterministic Quantum Teleportation with Solid State Qubits. *Nature* **500**, 319–322 (2013).
- [37] Pfaff, W. et al. Unconditional quantum teleportation between distant solid-state quantum bits. *Science*. **345**, 532–535 (2014).
- [38] Grover, L. K. A fast quantum mechanical algorithm for database search. Proceedings, 28th ACM Symposium on Theory of Computing (STOC), 212-218 (1996).
- [39] Gottesman, D. & Chuang, I. L. Demonstrating the viability of universal quantum computation using teleportation and single-qubit operations. *Nature***402**, 390–393(1999).
- [40] Zaman, F., Paing, S., Farooq, N. A., Shin H. & Win, M. Z. "Concealed Quantum Telecomputation for Anonymous 6G URLLC Networks," in IEEE Journal on Selected Areas in Communications, **41**, 2278-2296 (2023).
- [41] Murao, M., Jonathan, D., Plenio, M. B., & Vedral, V. Quantum telecloning and multiparticle entanglement. *Phys. Rev. A***59**, 156–161 (1999).
- [42] Das, S., Halder, P., Banerjee, R. & Sen, A. Sequential reattempt of telecloning. *Phys. Rev. A***107**, 042414 (2023).
- [43] Pelofske, E., Bäertschi, A., Garcia, B., Kiefer, B. & Eidenbenz, S. "Quantum Telecloning on NISQ Computers, IEEE International Conference on Quantum Computing and Engineering (QCE), Broomfield, CO, USA, 605-616, (2022).
- [44] Foo, J., Onoe, S., Zych, M. & Ralph, T.C. Telefilters, telemirrors, and causality, *Phys. Rev. A* **105**, 033711 (2022).
- [45] Hillery, M., Bergou, J. A., Wei, T-C. Santra, S. & Malinovsky, V. Broadcast of a restricted set of qubit and qutrit states. *Phys. Rev. A* **105**, 042611 (2022).
- [46] Sukeno, H., et al. Broadcasting single-qubit and multiqubit entangled states: Authentication, cryptography, and distributed quantum computation, *Phys. Rev. A* **107**, 062605 (2023).
- [47] Guanzon, J. J., Winnel, M.S., Lund, A. P. & Ralph, T.C. Ideal Quantum Teleamplification up to a Selected Energy Cutoff Using Linear Optics. *Phys. Rev. Lett.***128**, 160501 (2022).
- [48] Zhao, O.P et al. Teleportation-based continuous-variable quantum digital signature. *Results in Physics*, **53**, 107018 (2023).
- [49] Cochrane, P. T., Milburn, G. J. & Munro, W. J. Macroscopically distinct quantum-superposition states as a bosonic code for amplitude damping. *Phys. Rev. A***59**, 2631 (1999).
- [50] Dodonov, V.V., Malkin, A. I., Man'ko, I. V.: Even and odd coherent states and excitations of a singular oscillator. *Physica***72**, 597–615 (1974).
- [51] Ralph, T. C., Munro, W. J. & Milburn, G. J. Quantum Computation with Coherent States, Linear Interactions and Superposed Resources, (21 October, 2001); Ralph, T. C., Munro, W. J. & Milburn, G. J., "Quantum computation based on linear optics," Proc. SPIE 4917, Quantum Optics in Computing and

- Communications, (13 September 2002); Ralph, T. C., Gilchrist, A., Milburn, G. J., Munro, W. J., Munro, Glancy, S. Quantum computation with optical coherent states. *Phys. Rev. A* **68**, 42319 (2003).
- [52] Van Enk S. J. & Hirota, O. Entangled coherent states: Teleportation and decoherence. *Phys. Rev. A* **64**, 1 (2001).
- [53] Sanders, B.C. Entangled coherent state. *Phys. Rev. A* **45**, 9 (1992).
- [54] An, N. Ba. Teleportation of coherent-state superpositions within a network. *Phys. Rev. A* **68**, 1 (2003).
- [55] Wang, X. Quantum teleportation of entangled coherent states. *Phys. Rev. A* **64**, 4 (2001).
- [56] Liao J-Q & Kuang, Le-M. Near-complete teleportation of two-mode four-component entangled coherent states. *J. Phys. B: At. Mol. Opt. Phys.* **40**, 1183 (2007).
- [57] Ngoc H. & An, N. Ba. Quantum teleportation of an arbitrary two-mode coherent state using only linear optics elements, *Phys. Lett. A* **372**, 2825 (2008).
- [58] Prakash, H., Chandra, N., Prakash, R. & Shivani. Improving the teleportation of entangled coherent states. *Phys. Rev. A* **75**, 3 (2007).
- [59] Karlsson A. & Bourennane, M. Quantum teleportation using three-particle entanglement. *Phys. Rev. A* **58**, 4394 (1998).
- [60] Yang, C. P., Chu, S. I. & Han, S. Efficient many-party controlled teleportation of multiqubit quantum information via entanglement. *Phys. Rev. A* **70**, 1 (2004).
- [61] Dong, L., Xiu, X. M., Gao, Y. J., Ren, Y. P. & Liu, H. W. Controlled three-party communication using GHZ-like state and imperfect Bell-state measurement. *Opt. Commun.* **284**, 905 (2011).
- [62] Hassanpour S. & Houshmand, M. Efficient controlled quantum secure direct communication based on GHZ-like states. *Quantum Inf. Process.* **14**, 739 (2015).
- [63] Gangopadhyay, S., Wang, T., A. Mashatan, & Ghose, S. Controlled quantum teleportation in the presence of an adversary. *Phys. Rev. A* **106**, 1 (2022).
- [64] Pandey, R. K., Prakash, R. & Prakash, H. Controlled Quantum Teleportation of Superposed Coherent State Using GHZ Entangled Coherent State, *Int. J. Theor. Phys.* **58**, 3342 (2019).
- [65] Huelga, S. F., Vaccaro, J. A., Chefles, A. & Plenio, M. B. Quantum remote control: Teleportation of unitary operations, *Phys. Rev. A* **63**, 1 (2001).
- [66] Zha, X.-W., Z.-C. Zou, Qi, J.-X. & Song, H.-Y. Bidirectional Quantum Controlled Teleportation via Five-Qubit Cluster State, *Int. J. Theor. Phys.* **52**, 1740 (2013).
- [67] Shukla, C. Banerjee, A. & Pathak, A. Bidirectional Controlled Teleportation by Using 5-Qubit States: A Generalized View, *Int. J. Theor. Phys.* **52**, 3790 (2013).
- [68] Siddiqui, A. U, Wilde, M. M. Quantifying the performance of bidirectional quantum teleportation,” *Canadian Journal of Physics*. Just-IN <https://doi.org/10.1139/cjp-2023-0233>.
- [69] Mishra, H. K., Oskouei, S. K. & Wilde, M. M. Optimal input states for quantifying the performance of continuous-variable unidirectional and bidirectional teleportation, *Phys. Rev. A* **107** 062603 (2023).
- [70] Hassanpour S. & Houshmand, M. Bidirectional quantum teleportation via entanglement swapping. in 23rd Iran. *Conf. Electr Eng.* **10**, 501 (2015).
- [71] Verma, V. Bidirectional quantum teleportation and cyclic quantum teleportation of multi-qubit entangled states via G-state. *Int. J. Mod. Phys. B* **34**, 2050261 (2020).

- [72] Verma, V. Bidirectional Quantum Teleportation by Using Two GHZ-States as the Quantum Channel. *IEEE Commun. Lett.* **25**, 936 (2021).
- [73] Mafi, Y., Kazemikhah, P., Ahmadkhaniha, A. Aghababa, H. & Kolahdouz, M. Bidirectional quantum teleportation of an arbitrary number of qubits over a noisy quantum system using 2^n Bell states as quantum channel, *Opt. Quant. Electron.* **54**, 1 (2022).
- [74] Verma, V., Singh, N. & Singh, R. S. Improvement on Quantum Teleportation of Three and Four Qubit States Using Multi-Qubit Cluster States. *Int. J. Theor. Phys.* **60**, 3973 (2021).
- [75] Choudhury B. S. & Samanta, S. A controlled protocol for asymmetric cyclic $A \Rightarrow B \Rightarrow C \Rightarrow A$ quantum state transfer between three parties. *Physics Scripta* **95**, (2020).
- [76] Sang, M. H. Bidirectional Quantum Teleportation by Using Five-qubit Cluster State. *Int. J. Theor. Phys.* **55**, 1333 (2016).
- [77] Yang, et al. Research on Key Technologies of Controlled Bidirectional Quantum Teleportation, *Int. J. Theor. Phys.* **62**, 1 (2023).
- [78] Chen, Y.-X., Du, J., Liu, S.-Y. & Wang, X.-H. Cyclic quantum teleportation. *Quantum Inf. Process.* **16**, 201 (2017).
- [79] Verma, V., Cyclic quantum teleportation via GHZ-like state. *Mod. Phys. Lett. A* **35**, 44 (2020).
- [80] Liu, R.-J., Bai, M.-Q, Wu, F. & Zhang, Y.-C. Cyclic-controlled quantum operation teleportation in noisy environment. *Int. J. Quantum Inf.*, **17**, 1950052 (2019).
- [81] Gu, J., Hwang, T. & Tsai, C. W. On the Controlled Cyclic Quantum Teleportation of an Arbitrary Two-Qubit Entangled State by Using a Ten-Qubit Entangled State. *Int. J. Theor. Phys.* **59** 200 (2020).
- [82] Shi, J., Zhang, X. & Zhu, Y. Cyclic Controlled Quantum Teleportation Using Three-Dimensional Hyper-Entangled State. *Int. J. Theor. Phys.* **58**, 3036 (2019)
- [83] Verma, V., & Singh, R. S. Simultaneous Quantum Teleportation within a Quantum Network. *Int. J. Theor. Phys.* **61**, 191 (2022).
- [84] Singh, N., Singh, N., Pathak, A. Verma, V. & Singh, R. S. Multi-directional controlled quantum teleportation by using nine-qubit entangled state as a single quantum channel. *Opt. Quantum Electron* **55**, 932 (2023).
- [85] Pandey, R. K., Yadav, P., Prakash, S. R. & Prakash, H. Controlled Bidirectional Quantum Teleportation of Superposed Coherent State Using Five-mode Cluster-type Entangled Coherent State as a Resource. *Int. J. Theor. Phys.* **61**, 104 (2022).
- [86] Aliloute, S. Allati, A. El & Aouadi, I. El. Bidirectional teleportation using coherent states. *Quantum Inf. Process.* **20**, 1(2021).
- [87] Pathak A., Singh N, Singh N, Singh R S., Linear Optical Protocol for Asymmetric Bidirectional Quantum Teleportation. *Int. J. Theor. Phys.* **63**, 15 (2024)
- [88] Wang Z., Bao Z., Wu Y., Li Y., Cai W., Wang W., Ma Y., Cai T., Han X., and Duan L., A flying Schrödinger's cat in multipartite entangled states. *Science Advances* **8**, 10 (2022)
- [89] Schmidt F., Miller D., and van Loock P., Error-corrected quantum repeaters with Gottesman-Kitaev-Preskill qudits. *Phys. Rev.* **A109**, 042427 (2024)

Appendix B

Table1. All exhaustive possibilities for detection-events in Eq.(7a) along with requisite unitary operations for faithful ABQT and Partial ABQT Protocol.

Photons detected in Alice lab.		Photons detected in Bob lab	Heralded state-vectors along with their conditions $n_7, n_9, n_{11} = 0$ and $n_8, n_{10}, n_{12} \neq 0$ (see Eq. (7a))	Unitary operation in labs		Faithful(F)/ Near Faithful (NF)
n_7/ n_8	n_9/ n_{10}	n_{11}/ n_{12}		Alice	Bob	
Odd	Odd	Odd	$N_{AA}(A_0 \alpha, \alpha\rangle - A_1 \alpha, -\alpha\rangle - A_2 -\alpha, \alpha\rangle + A_3 -\alpha, -\alpha\rangle)_{4,5} \otimes N_B(B_0 \alpha\rangle - B_1 -\alpha\rangle)_6$	D_6	$D_5 \otimes D_4$	NF Eq.(12,13)
Odd	Odd	Even	$N_{AA}(A_0 \alpha, \alpha\rangle - A_1 \alpha, -\alpha\rangle - A_2 -\alpha, \alpha\rangle + A_3 -\alpha, -\alpha\rangle)_{4,5} \otimes N_B(B_0 \alpha\rangle + B_1 -\alpha\rangle)_6$	I_6	$D_5 \otimes D_4$	F/NF Eq.(14,15)
Odd	Even	Odd	$N_{AA}(A_0 \alpha, \alpha\rangle + A_1 \alpha, -\alpha\rangle - A_2 -\alpha, \alpha\rangle - A_3 -\alpha, -\alpha\rangle)_{4,5} \otimes N_B(B_0 \alpha\rangle - B_1 -\alpha\rangle)_6$	D_6	D_4	NF Eq.(16,17)
Even	Odd	Odd	$N_{AA}(A_0 \alpha, \alpha\rangle - A_1 \alpha, -\alpha\rangle + A_2 -\alpha, \alpha\rangle - A_3 -\alpha, -\alpha\rangle)_{4,5} \otimes N_B(B_0 \alpha\rangle - B_1 -\alpha\rangle)_6$	D_6	D_5	NF Eq.(18,19)
Even	Even	Even	$N_{AA}(A_0 \alpha, \alpha\rangle + A_1 \alpha, -\alpha\rangle + A_2 -\alpha, \alpha\rangle + A_3 -\alpha, -\alpha\rangle)_{4,5} \otimes N_B(B_0 \alpha\rangle + B_1 -\alpha\rangle)_6$	I_6	$I_5 \otimes I_4$	F Eq.(20,21)
Even	Even	Odd	$N_{AA}(A_0 \alpha, \alpha\rangle + A_1 \alpha, -\alpha\rangle + A_2 -\alpha, \alpha\rangle + A_3 -\alpha, -\alpha\rangle)_{4,5} \otimes N_B(B_0 \alpha\rangle - B_1 -\alpha\rangle)_6$	D_6	$I_5 \otimes I_4$	NF/F Eq.(22,23)
Even	Odd	Even	$N_{AA}(A_0 \alpha, \alpha\rangle - A_1 \alpha, -\alpha\rangle + A_2 -\alpha, \alpha\rangle - A_3 -\alpha, -\alpha\rangle)_{4,5} \otimes N_B(B_0 \alpha\rangle + B_1 -\alpha\rangle)_6$	I_6	D_5	F/NF Eq.(24,25)
Odd	Even	Even	$N_{AA}(A_0 \alpha, \alpha\rangle + A_1 \alpha, -\alpha\rangle - A_2 -\alpha, \alpha\rangle - A_3 -\alpha, -\alpha\rangle)_{4,5} \otimes N_B(B_0 \alpha\rangle + B_1 -\alpha\rangle)_6$	I_6	D_4	F/NF Eq.(26,27)

Table 2. All exhaustive possibilities for detection-events in Eq.(7b) along with requisite unitary operator for faithful/near-faithful ABQT Protocol.

Photons detected in Alice lab.		Photons detected in Bob lab.	Heralded state-vectors along with their conditions $n_7, n_9, n_{11} \neq 0$ and $n_8, n_{10}, n_{12} = 0$ (see Eq.(7b))	Unitary operation in labs		Faithful(F)/Near Faithful (NF)
n_7/ n_8	n_9/ n_{10}	n_{11}/ n_{12}		Alice	Bob	
Odd	Odd	Odd	$N_{AA}(A_0 -\alpha, \alpha\rangle - A_1 -\alpha, \alpha\rangle - A_2 \alpha, \alpha\rangle + A_3 \alpha, \alpha\rangle)_{4,5} \otimes N_B(B_0 -\alpha\rangle - B_1 \alpha\rangle)_6$	$D_6 P_6$	$D_5 \otimes D_4 (P_5 \otimes P_4)$	NF Eq.(12,13)
Odd	Odd	Even	$N_{AA}(A_0 -\alpha, \alpha\rangle - A_1 -\alpha, \alpha\rangle - A_2 \alpha, \alpha\rangle + A_3 \alpha, \alpha\rangle)_{4,5} \otimes (B_0 -\alpha\rangle + B_1 \alpha\rangle)_6$	P_6	$D_5 \otimes D_4 (P_5 \otimes P_4)$	F/NF Eq.(14,15)
Odd	Even	Odd	$N_{AA}(A_0 -\alpha, \alpha\rangle + A_1 -\alpha, \alpha\rangle - A_2 \alpha, \alpha\rangle - A_3 \alpha, \alpha\rangle)_{4,5} \otimes N_B(B_0 -\alpha\rangle - B_1 \alpha\rangle)_6$	$D_6 P_6$	$D_4 (P_5 \otimes P_4)$	NF Eq.(16,17)
Even	Odd	Odd	$N_{AA}(A_0 -\alpha, \alpha\rangle - A_1 -\alpha, \alpha\rangle + A_2 \alpha, \alpha\rangle - A_3 \alpha, \alpha\rangle)_{4,5} \otimes N_B(B_0 -\alpha\rangle - B_1 \alpha\rangle)_6$	$D_6 P_6$	$D_5 (P_5 \otimes P_4)$	NF Eq.(18,19)
Even	Even	Even	$N_{AA}(A_0 -\alpha, \alpha\rangle + A_1 -\alpha, \alpha\rangle + A_2 \alpha, \alpha\rangle + A_3 \alpha, \alpha\rangle)_{4,5} \otimes N_B(B_0 -\alpha\rangle + B_1 \alpha\rangle)_6$	P_6	$P_5 \otimes P_4$	F Eq.(20,21)
Even	Even	Odd	$N_{AA}(A_0 -\alpha, \alpha\rangle + A_1 -\alpha, \alpha\rangle + A_2 \alpha, \alpha\rangle + A_3 \alpha, \alpha\rangle)_{4,5} \otimes N_B(B_0 -\alpha\rangle - B_1 \alpha\rangle)_6$	$D_6 P_6$	$P_5 \otimes P_4$	NF/F Eq.(22,23)
Even	Odd	Even	$N_{AA}(A_0 -\alpha, \alpha\rangle - A_1 -\alpha, \alpha\rangle + A_2 \alpha, \alpha\rangle - A_3 \alpha, \alpha\rangle)_{4,5} \otimes N_B(B_0 -\alpha\rangle + B_1 \alpha\rangle)_6$	P_6	$D_5 (P_5 \otimes P_4)$	F/NF Eq.(24,25)
Odd	Even	Even	$N_{AA}(A_0 -\alpha, \alpha\rangle + A_1 -\alpha, \alpha\rangle - A_2 \alpha, \alpha\rangle - A_3 \alpha, \alpha\rangle)_{4,5} \otimes N_B(B_0 -\alpha\rangle + B_1 \alpha\rangle)_6$	P_6	$D_4 (P_5 \otimes P_4)$	F/NF Eq.(26,27)

Table 3. All exhaustive possibilities for detection-events in Eq.(7c) along with requisite unitary operator for faithful/near-faithful ABQT Protocol.

Photons detected in Alice lab.		Photons detected in Bob lab.	Heralded state-vectors along with their conditions $n_7, n_9, n_{12} \neq 0$ and $n_8, n_{10}, n_{11} = 0$ (see Eq. (7c))	Unitary operation		Faithful(F) /Near Faithful (NF)
n_7/ n_8	n_9/ n_{10}	n_{11}/ n_{12}		Alice	Bob	
Odd	Odd	Odd	$N_{AA}(A_0 -\alpha\rangle\langle-\alpha - A_1 -\alpha\rangle\langle-\alpha - A_2 \alpha\rangle\langle\alpha + A_3 \alpha\rangle\langle\alpha)_{45} \otimes N_B(B_0 \alpha\rangle\langle-\alpha - \alpha)_6$	D_6	$(D_5 \otimes D_4)(P_5 \otimes P_4)$	NF Eq.(12,13)
Odd	Odd	Even	$N_{AA}(A_0 -\alpha\rangle\langle-\alpha - A_1 -\alpha\rangle\langle-\alpha - A_2 \alpha\rangle\langle\alpha + A_3 \alpha\rangle\langle\alpha)_{45} \otimes N_B(B_0 \alpha\rangle\langle\alpha + B_1 -\alpha\rangle\langle-\alpha)_6$	I_6	$(D_5 \otimes D_4)(P_5 \otimes P_4)$	F/NF Eq.(14,15)
Odd	Even	Odd	$N_{AA}(A_0 -\alpha\rangle\langle-\alpha + A_1 -\alpha\rangle\langle-\alpha - A_2 \alpha\rangle\langle\alpha - A_3 \alpha\rangle\langle\alpha)_{45} \otimes N_B(B_0 \alpha\rangle\langle-\alpha - \alpha)_6$	D_6	$D_4(P_5 \otimes P_4)$	NF Eq.(16,17)
Even	Odd	Odd	$N_{AA}(A_0 -\alpha\rangle\langle-\alpha - A_1 -\alpha\rangle\langle\alpha + A_2 \alpha\rangle\langle-\alpha - A_3 \alpha\rangle\langle\alpha)_{45} \otimes N_B(B_0 \alpha\rangle\langle-\alpha - \alpha)_6$	D_6	$D_5(P_5 \otimes P_4)$	NF Eq.(18,19)
Even	Even	Even	$N_{AA}(A_0 -\alpha\rangle\langle-\alpha + A_1 -\alpha\rangle\langle\alpha + A_2 \alpha\rangle\langle\alpha + A_3 \alpha\rangle\langle\alpha)_{45} \otimes N_B(B_0 \alpha\rangle\langle\alpha + B_1 -\alpha\rangle\langle-\alpha)_6$	I_6	$P_5 \otimes P_4$	F Eq.(20,21)
Even	Even	Odd	$N_{AA}(A_0 -\alpha\rangle\langle-\alpha + A_1 -\alpha\rangle\langle\alpha + A_2 \alpha\rangle\langle\alpha + A_3 \alpha\rangle\langle\alpha)_{45} \otimes N_B(B_0 \alpha\rangle\langle-\alpha - \alpha)_6$	D_6	$P_5 \otimes P_4$	NF/F Eq.(22,23)
Even	Odd	Even	$N_{AA}(A_0 -\alpha\rangle\langle-\alpha - A_1 -\alpha\rangle\langle\alpha + A_2 \alpha\rangle\langle-\alpha - A_3 \alpha\rangle\langle\alpha)_{45} \otimes N_B(B_0 \alpha\rangle\langle\alpha + B_1 -\alpha\rangle\langle-\alpha)_6$	I_6	$D_5(P_5 \otimes P_4)$	F/NF Eq.(24,25)
Odd	Even	Even	$N_{AA}(A_0 -\alpha\rangle\langle-\alpha + A_1 -\alpha\rangle\langle-\alpha - A_2 \alpha\rangle\langle-\alpha - A_3 \alpha\rangle\langle\alpha)_{45} \otimes N_B(B_0 \alpha\rangle\langle\alpha + B_1 -\alpha\rangle\langle-\alpha)_6$	I_6	$D_4(P_5 \otimes P_4)$	F/NF Eq.(26,27)

Table 4. All exhaustive possibilities for detection-events in Eq.(7d) along with requisite unitary operator for faithful/near-faithful ABQT Protocol.

Photons detected in Alice lab.		Photons detected in Bob lab.	Heralded state-vectors along with their conditions $n_7, n_{10}, n_{11} \neq 0$ and $n_8, n_9, n_{12} = 0$ (see Eq.(7d))	Unitary operation		Faithful(F) /Near Faithful (NF)
n_7/ n_8	n_9/ n_{10}	n_{11}/ n_{12}		Alice	Bob	
Odd	Odd	Odd	$N_{A,A}(A_0 -\alpha,\alpha\rangle - A_1 -\alpha,-\alpha\rangle - A_2 \alpha,\alpha\rangle + A_3 \alpha,-\alpha\rangle)_{4,5} \otimes N_B(B_0 -\alpha\rangle - B_1 \alpha\rangle)_6$	$D_6 \otimes P_6$	$(D_5 \otimes D_4)P_4$	NF Eq.(12,13)
Odd	Odd	Even	$N_{A,A}(A_0 -\alpha,\alpha\rangle - A_1 -\alpha,-\alpha\rangle - A_2 \alpha,\alpha\rangle + A_3 \alpha,-\alpha\rangle)_{4,5} \otimes N_B(B_0 -\alpha\rangle + B_1 \alpha\rangle)_6$	P_6	$(D_5 \otimes D_4)P_4$	F/NF Eq.(14,15)
Odd	Even	Odd	$N_{A,A}(A_0 -\alpha,\alpha\rangle + A_1 -\alpha,-\alpha\rangle - A_2 \alpha,\alpha\rangle - A_3 \alpha,-\alpha\rangle)_{4,5} \otimes N_B(B_0 -\alpha\rangle - B_1 \alpha\rangle)_6$	$D_6 \otimes P_6$	$D_4 \otimes P_4$	NF Eq.(16,17)
Even	Odd	Odd	$N_{A,A}(A_0 -\alpha,\alpha\rangle - A_1 -\alpha,-\alpha\rangle + A_2 \alpha,\alpha\rangle - A_3 \alpha,-\alpha\rangle)_{4,5} \otimes N_B(B_0 -\alpha\rangle - B_1 \alpha\rangle)_6$	$D_6 \otimes P_6$	$D_5 \otimes P_4$	NF Eq.(18,19)
Even	Even	Even	$N_{A,A}(A_0 -\alpha,\alpha\rangle + A_1 -\alpha,-\alpha\rangle + A_2 \alpha,\alpha\rangle + A_3 \alpha,-\alpha\rangle)_{4,5} \otimes N_B(B_0 -\alpha\rangle + B_1 \alpha\rangle)_6$	P_6	P_4	F Eq.(20,21)
Even	Even	Odd	$N_{A,A}(A_0 -\alpha,\alpha\rangle + A_1 -\alpha,-\alpha\rangle + A_2 \alpha,\alpha\rangle + A_3 \alpha,-\alpha\rangle)_{4,5} \otimes N_B(B_0 -\alpha\rangle - B_1 \alpha\rangle)_6$	$D_6 \otimes P_6$	P_4	NF/F Eq.(22,23)
Even	Odd	Even	$N_{A,A}(A_0 -\alpha,\alpha\rangle - A_1 -\alpha,-\alpha\rangle + A_2 \alpha,\alpha\rangle - A_3 \alpha,-\alpha\rangle)_{4,5} \otimes N_B(B_0 -\alpha\rangle + B_1 \alpha\rangle)_6$	P_6	$D_5 \otimes P_4$	F/NF Eq.(24,25)
Odd	Even	Even	$N_{A,A}(A_0 -\alpha,\alpha\rangle + A_1 -\alpha,-\alpha\rangle - A_2 \alpha,\alpha\rangle - A_3 \alpha,-\alpha\rangle)_{4,5} \otimes N_B(B_0 -\alpha\rangle + B_1 \alpha\rangle)_6$	P_6	$D_4 \otimes P_4$	F/NF Eq.(26,27)

Table 5. All exhaustive possibilities for detection-events in Eq.(7e) along with requisite unitary operator for faithful/near-faithful ABQT Protocol.

Photons detected in Alice lab.		Photons detected in Bob lab.	Heralded state-vectors along with their conditions $n_7, n_{10}, n_{12} \neq 0$ and $n_8, n_9, n_{11} = 0$ (see Eq. (7e))	Unitary operation		Faithful(F)/Near Faithful (NF)
n_7/ n_8	n_9/ n_{10}	n_{11}/ n_{12}		Alice	Bob	
Odd	Odd	Odd	$N_{A_4}(A_0 -\alpha, \alpha\rangle - A_1 -\alpha, -\alpha\rangle - A_2 \alpha, \alpha\rangle + A_3 \alpha, -\alpha\rangle)_{4,5} \otimes N_B(B_0 \alpha\rangle - B_1 -\alpha\rangle)_6$	D_6	$(D_5 \otimes D_4)P_4$	NF Eq.(12,13)
Odd	Odd	Even	$N_{A_4}(A_0 -\alpha, \alpha\rangle + A_1 -\alpha, -\alpha\rangle - A_2 \alpha, \alpha\rangle + A_3 \alpha, -\alpha\rangle)_{4,5} \otimes N_B(B_0 \alpha\rangle + B_1 -\alpha\rangle)_6$	I_6	$(D_5 \otimes D_4)P_4$	F/NF Eq.(14,15)
Odd	Even	Odd	$N_{A_4}(A_0 -\alpha, \alpha\rangle + A_1 -\alpha, -\alpha\rangle - A_2 \alpha, \alpha\rangle - A_3 \alpha, -\alpha\rangle)_{4,5} \otimes N_B(B_0 \alpha\rangle - B_1 -\alpha\rangle)_6$	D_6	$D_4 \otimes P_4$	NF Eq.(16,17)
Even	Odd	Odd	$N_{A_4}(A_0 -\alpha, \alpha\rangle - A_1 -\alpha, -\alpha\rangle + A_2 \alpha, \alpha\rangle - A_3 \alpha, -\alpha\rangle)_{4,5} \otimes N_B(B_0 \alpha\rangle - B_1 -\alpha\rangle)_6$	D_6	$D_5 \otimes P_4$	NF Eq.(18,19)
Even	Even	Even	$N_{A_4}(A_0 -\alpha, \alpha\rangle + A_1 -\alpha, -\alpha\rangle + A_2 \alpha, \alpha\rangle + A_3 \alpha, -\alpha\rangle)_{4,5} \otimes N_B(B_0 \alpha\rangle + B_1 -\alpha\rangle)_6$	I_6	P_4	F Eq.(20,21)
Even	Even	Odd	$N_{A_4}(A_0 -\alpha, \alpha\rangle + A_1 -\alpha, -\alpha\rangle + A_2 \alpha, \alpha\rangle + A_3 \alpha, -\alpha\rangle)_{4,5} \otimes N_B(B_0 \alpha\rangle - B_1 -\alpha\rangle)_6$	D_6	P_4	NF/F Eq.(22,23)
Even	Odd	Even	$N_{A_4}(A_0 -\alpha, \alpha\rangle - A_1 -\alpha, -\alpha\rangle + A_2 \alpha, \alpha\rangle - A_3 \alpha, -\alpha\rangle)_{4,5} \otimes N_B(B_0 \alpha\rangle + B_1 -\alpha\rangle)_6$	I_6	$D_5 \otimes P_4$	F/NF Eq.(24,25)
Odd	Even	Even	$N_{A_4}(A_0 -\alpha, \alpha\rangle + A_1 -\alpha, -\alpha\rangle - A_2 \alpha, \alpha\rangle - A_3 \alpha, -\alpha\rangle)_{4,5} \otimes N_B(B_0 \alpha\rangle + B_1 -\alpha\rangle)_6$	I_6	$D_4 \otimes P_4$	F/NF Eq.(26,27)

Table 6. All exhaustive possibilities for detection-events in Eq.(7f) along with requisite unitary operator for faithful/near-faithful ABQT Protocol.

Photons detected in Alice lab.		Photons detected in Bob lab.	Heralded state-vectors along with their conditions $n_7, n_{10}, n_{11} \neq 0$ and $n_8, n_9, n_{12} = 0$ (see Eq. (7f))	Unitary operation		Faithful(F)/Near Faithful (NF)
n_7/n_8	n_9/n_{10}	n_{11}/n_{12}		Alice	Bob	
Odd	Odd	Odd	$N_{A_4}(A_0 \alpha-\alpha\rangle - A_1 \alpha,\alpha\rangle - A_2 -\alpha-\alpha\rangle + A_3 -\alpha,\alpha\rangle)_{4,5} \otimes N_B(B_0 -\alpha\rangle - B_1 \alpha\rangle)_6$	$D_6 \otimes P_6$	$(D_5 \otimes D_4)P_5$	NF Eq.(12,13)
Odd	Odd	Even	$N_{A_4}(A_0 \alpha-\alpha\rangle - A_1 \alpha,\alpha\rangle - A_2 -\alpha-\alpha\rangle + A_3 -\alpha,\alpha\rangle)_{4,5} \otimes N_B(B_0 -\alpha\rangle + B_1 \alpha\rangle)_6$	P_6	$(D_5 \otimes D_4)P_5$	F/NF Eq.(14,15)
Odd	Even	Odd	$N_{A_4}(A_0 \alpha-\alpha\rangle + A_1 \alpha,\alpha\rangle - A_2 -\alpha-\alpha\rangle - A_3 -\alpha,\alpha\rangle)_{4,5} \otimes N_B(B_0 -\alpha\rangle - B_1 \alpha\rangle)_6$	$D_6 \otimes P_6$	$D_4 \otimes P_5$	NF Eq.(16,17)
Even	Odd	Odd	$N_{A_4}(A_0 \alpha-\alpha\rangle - A_1 \alpha,\alpha\rangle + A_2 -\alpha-\alpha\rangle - A_3 -\alpha,\alpha\rangle)_{4,5} \otimes N_B(B_0 -\alpha\rangle - B_1 \alpha\rangle)_6$	$D_6 \otimes P_6$	$D_5 \otimes P_5$	NF Eq(18,19)
Even	Even	Even	$N_{A_4}(A_0 \alpha-\alpha\rangle + A_1 \alpha,\alpha\rangle + A_2 -\alpha-\alpha\rangle + A_3 -\alpha,\alpha\rangle)_{4,5} \otimes N_B(B_0 -\alpha\rangle + B_1 \alpha\rangle)_6$	P_6	P_5	F Eq.(20,21)
Even	Even	Odd	$N_{A_4}(A_0 \alpha-\alpha\rangle + A_1 \alpha,\alpha\rangle + A_2 -\alpha-\alpha\rangle + A_3 -\alpha,\alpha\rangle)_{4,5} \otimes N_B(B_0 -\alpha\rangle - B_1 \alpha\rangle)_6$	$D_6 \otimes P_6$	P_5	NF/F Eq.(22,23)
Even	Odd	Even	$N_{A_4}(A_0 \alpha-\alpha\rangle - A_1 \alpha,\alpha\rangle + A_2 -\alpha-\alpha\rangle - A_3 -\alpha,\alpha\rangle)_{4,5} \otimes N_B(B_0 -\alpha\rangle + B_1 \alpha\rangle)_6$	P_6	$D_5 \otimes P_5$	F/NF Eq.(24,25)
Odd	Even	Even	$N_{A_4}(A_0 \alpha-\alpha\rangle + A_1 \alpha,\alpha\rangle - A_2 -\alpha-\alpha\rangle - A_3 -\alpha,\alpha\rangle)_{4,5} \otimes N_B(B_0 -\alpha\rangle + B_1 \alpha\rangle)_6$	P_6	$D_4 \otimes P_5$	F/NF Eq.(26,27)

Table 7. All exhaustive possibilities for detection-events in Eq.(7g) along with requisite unitary operator for faithful/near-faithful ABQT Protocol.

Photons detected in Alice lab.		Photons detected in Bob lab.	Heralded state-vectors along with their conditions $n_7, n_{10}, n_{12} \neq 0$ and n_8, n_9, n_{11} (see Eq. (7g))	Unitary operation		Faithful(F)/Near Faithful (NF)
n_7/n_8	n_9/n_{10}	n_{11}/n_{12}		Alice	Bob	
Odd	Odd	Odd	$N_{A_1}(A_0 \alpha, \alpha\rangle - A_1 \alpha, \alpha\rangle - A_2 -\alpha, \alpha\rangle + A_3 -\alpha, \alpha\rangle)_{4,5} \otimes N_B(B_0 \alpha\rangle - B_1 -\alpha\rangle)_6$	D_6	$(D_5 \otimes D_4)P_5$	NF Eq.(12,13)
Odd	Odd	Even	$N_{A_1}(A_0 \alpha, \alpha\rangle + A_1 \alpha, \alpha\rangle - A_2 -\alpha, \alpha\rangle + A_3 -\alpha, \alpha\rangle)_{4,5} \otimes N_B(B_0 \alpha\rangle + B_1 -\alpha\rangle)_6$	I_6	$(D_5 \otimes D_4)P_5$	F/NF Eq.(14,15)
Odd	Even	Odd	$N_{A_1}(A_0 \alpha, \alpha\rangle + A_1 \alpha, \alpha\rangle - A_2 -\alpha, \alpha\rangle - A_3 -\alpha, \alpha\rangle)_{4,5} \otimes N_B(B_0 \alpha\rangle - B_1 -\alpha\rangle)_6$	D_6	$D_4 \otimes P_4$	NF Eq.(16,17)
Even	Odd	Odd	$N_{A_1}(A_0 \alpha, \alpha\rangle - A_1 \alpha, \alpha\rangle + A_2 -\alpha, \alpha\rangle - A_3 -\alpha, \alpha\rangle)_{4,5} \otimes N_B(B_0 \alpha\rangle - B_1 -\alpha\rangle)_6$	D_6	$D_5 \otimes P_5$	NF Eq.(18,19)
Even	Even	Even	$N_{A_1}(A_0 -\alpha, \alpha\rangle + A_1 -\alpha, \alpha\rangle + A_2 \alpha, \alpha\rangle + A_3 \alpha, \alpha\rangle)_{4,5} \otimes N_B(B_0 \alpha\rangle + B_1 -\alpha\rangle)_6$	I_6	$P_5 \otimes P_4$	F Eq.(20,21)
Even	Even	Odd	$N_{A_1}(A_0 -\alpha, \alpha\rangle + A_1 -\alpha, \alpha\rangle + A_2 \alpha, \alpha\rangle + A_3 \alpha, \alpha\rangle)_{4,5} \otimes N_B(B_0 \alpha\rangle - B_1 -\alpha\rangle)_6$	D_6	P_4	NF/F Eq.(22,23)
Even	Odd	Even	$N_{A_1}(A_0 -\alpha, \alpha\rangle - A_1 -\alpha, \alpha\rangle + A_2 \alpha, \alpha\rangle - A_3 \alpha, \alpha\rangle)_{4,5} \otimes N_B(B_0 \alpha\rangle + B_1 -\alpha\rangle)_6$	I_6	$D_5 \otimes P_4$	F/NF Eq.(24,25)
Odd	Even	Even	$N_{A_1}(A_0 -\alpha, \alpha\rangle + A_1 -\alpha, \alpha\rangle - A_2 \alpha, \alpha\rangle - A_3 \alpha, \alpha\rangle)_{4,5} \otimes N_B(B_0 \alpha\rangle + B_1 -\alpha\rangle)_6$	I_6	$D_4 \otimes P_4$	F/NF Eq.(26,27)

Table 8. All exhaustive possibilities for detection-events in Eq.(7h) along with requisite unitary operator for faithful/near-faithful ABQT Protocol.

Photons detected in Alice lab.		Photons detected in Bob lab.	Heralded state-vectors along with their conditions $n_7, n_{10}, n_{11} \neq 0$ and $n_8, n_9, n_{12} = 0$ (see Eq. (7h))	Unitary operation		Faithful(F)/ Near Faithful (NF)
n_7/ n_8	n_9/ n_{10}	n_{11}/ n_{12}		Alice	Bob	
Odd	Odd	Odd	$N_{A_4}(A_0 \alpha, \alpha\rangle - A_1 \alpha, -\alpha\rangle - A_2 -\alpha, \alpha\rangle + A_3 -\alpha, -\alpha\rangle)_{4,5} \otimes N_B(B_0 -\alpha\rangle - B_1 \alpha\rangle)_6$	$D_6 P_6$	$D_5 \otimes D_4$	NF Eq.(12,13)
Odd	Odd	Even	$N_{A_4}(A_0 \alpha, \alpha\rangle + A_1 \alpha, -\alpha\rangle - A_2 -\alpha, \alpha\rangle + A_3 -\alpha, -\alpha\rangle)_{4,5} \otimes N_B(B_0 -\alpha\rangle + B_1 \alpha\rangle)_6$	P_6	$D_5 \otimes D_4$	F/NF Eq.(14,15)
Odd	Even	Odd	$N_{A_4}(A_0 \alpha, \alpha\rangle + A_1 \alpha, -\alpha\rangle - A_2 -\alpha, \alpha\rangle - A_3 -\alpha, -\alpha\rangle)_{4,5} \otimes N_B(B_0 -\alpha\rangle - B_1 \alpha\rangle)_6$	$D_6 P_6$	D_4	NF Eq.(16,17)
Even	Odd	Odd	$N_{A_4}(A_0 \alpha, \alpha\rangle - A_1 \alpha, -\alpha\rangle + A_2 -\alpha, \alpha\rangle - A_3 -\alpha, -\alpha\rangle)_{4,5} \otimes N_B(B_0 -\alpha\rangle - B_1 \alpha\rangle)_6$	$D_6 P_6$	D_5	NF Eq(18,19)
Even	Even	Even	$N_{A_4}(A_0 \alpha, \alpha\rangle + A_1 \alpha, -\alpha\rangle + A_2 -\alpha, \alpha\rangle + A_3 -\alpha, -\alpha\rangle)_{4,5} \otimes N_B(B_0 -\alpha\rangle + B_1 \alpha\rangle)_6$	P_6	$I_5 \otimes I_4$	F Eq.(20,21)
Even	Even	Odd	$N_{A_4}(A_0 \alpha, \alpha\rangle + A_1 \alpha, -\alpha\rangle + A_2 -\alpha, \alpha\rangle + A_3 -\alpha, -\alpha\rangle)_{4,5} \otimes N_B(B_0 -\alpha\rangle - B_1 \alpha\rangle)_6$	$D_6 P_6$	$I_5 \otimes I_4$	NF/F Eq.(22,23)
Even	Odd	Even	$N_{A_4}(A_0 \alpha, \alpha\rangle - A_1 \alpha, -\alpha\rangle + A_2 -\alpha, \alpha\rangle - A_3 -\alpha, -\alpha\rangle)_{4,5} \otimes N_B(B_0 -\alpha\rangle + B_1 \alpha\rangle)_6$	P_6	D_5	F/NF Eq.(24,25)
Odd	Even	Even	$N_{A_4}(A_0 \alpha, \alpha\rangle + A_1 \alpha, -\alpha\rangle - A_2 -\alpha, \alpha\rangle - A_3 -\alpha, -\alpha\rangle)_{4,5} \otimes N_B(B_0 -\alpha\rangle + B_1 \alpha\rangle)_6$	P_6	D_4	F/NF Eq.(26,27)