

NEW-MUSIC: The Next-generation Extended-Wavelength Multiband Sub/millimeter Inductance Camera

Sunil R. Golwala^a, Andrew D. Beyer^b, Daniel Cunnane^b, Peter K. Day^b, Fabien Defrance^b, Clifford F. Frez^b, Xiaolan Huang^{c,d}, Junhan Kim^{a,f}, Jean-Marc Martin^a, Jack Sayers^a, Shibo Shu^c, and Shiling Yu^{a,e,g}

^aDivision of Physics, Mathematics, and Astronomy, California Institute of Technology, Pasadena, CA, USA, 91125

^bJet Propulsion Laboratory, California Institute of Technology, 4800 Oak Grove Ave., Pasadena, CA, USA, 91109

^cInstitute of High Energy Physics, Chinese Academy of Sciences, Beijing, China, 100049

^dShanghai Normal University, Shanghai, China, 201418

^eNational Astronomical Observatories of China, Beijing, China, 100101

^fKorea Advanced Institute for Science and Technology, Daejeon, 34141, Republic of Korea

^gUniversity of the Chinese Academy of Sciences, Beijing, China, 101408

ABSTRACT

The Next-generation Extended Wavelength-MUltiband Sub/millimeter Inductance Camera (NEW-MUSIC) on the Leighton Chajnantor Telescope (LCT) will be a first-of-its-kind, six-band, transmillimeter-wave (“trans-mm”) polarimeter covering 2.4 octaves of spectral bandwidth to open a new window on the trans-mm time-domain frontier, in particular new frontiers in energy, density, time, and magnetic field. NEW-MUSIC’s broad spectral coverage will also enable the use of the Sunyaev-Zeldovich effects to study accretion, feedback, and dust content in the hot gaseous haloes of galaxies and galaxy clusters. Six-band spectral energy distributions, with polarization information, will yield new insights into stellar and planetary nurseries. NEW-MUSIC will employ hierarchical, phased arrays of polarization-sensitive superconducting slot-dipole antennas, coupled to photolithographic bandpass filters, to nearly optimally populate LCT’s 14’ field-of-view with six spectral bands over 80–420 GHz (1:5.25 spectral dynamic range; 2.4 octaves). Light will be routed to Al or AlMn microstripline-coupled, parallel-plate capacitor, lumped-element kinetic inductance detectors (MS-PPC-LEKIDs), an entirely new KID architecture that substantially enhances design flexibility while providing background-limited performance. Innovative, wide-bandwidth, etched silicon structures will be used to antireflection-treat the back-illuminated focal plane. NEW-MUSIC will cost-effectively reuse much of the MUSIC instrument, initially deploying a quarter-scale focal plane capable of the bulk of NEW-MUSIC science followed later by a full-FoV focal plane needed for NEW-MUSIC wide-area survey science.

Keywords: kinetic inductance detector, photolithographic antenna, two-level systems, dielectric loss, dielectric noise, millimeter-wave instrumentation

1. INTRODUCTION

The time-domain sky at submillimeter and millimeter wavelengths is only just now beginning to be explored thanks to advances in observing facilities at these wavelengths. Sources include various explosions associated with stellar death, outbursts from and accretion onto the remnants, young stars growing their mass, flaring stars, and active galactic nuclei. This spectral range traces some of the most energetic phenomena, penetrates deep into some of the densest environments, accesses the earliest times and shortest-timescale variability, and probes the highest magnetic field environments. Critical to understanding these sources are multi-band spectral energy distribution (SED) data over a large spectral range. For synchrotron sources, the SED spectral slopes

Send correspondence to SRG; email: golwala@caltech.edu

and breaks help to constrain the energies of the emitting electrons and thus the shocks that accelerate them, and the SED time evolution constrains dynamics of the explosion and the outflow. For local dusty sources, the spectral slope and curvature constrain the temperature and grain emissivity, and temporal information tells us about the episodic nature of evolution.

Accretion and feedback play central roles in the evolution of galaxies and galaxy clusters, impacting the hot circumgalactic medium (CGM) and intracluster medium (ICM). Via Sunyaev-Zeldovich effect observations yielding total thermal content, pressure, and density, it is possible to probe deviations from equilibrium due to accretion and feedback processes: non-thermal pressure and bulk motions in galaxy clusters, and deviations of the CGM from self-similar scaling. The complex nature of the spectral signature of the SZ effects, combined with the presence of contaminating foreground and background sources, necessitates multi-band data through the trans-mm (0.7–3.8 mm) regime.

Six-band spectral energy distributions, with polarization information, will yield new insights into stellar and planetary nurseries.

The very broadband trans-mm SED information needed for these various applications will be provided by the Next generation Extended Wavelength MULTiband Sub/millimeter Inductance Camera (NEW-MUSIC) on the Leighton Chajnantor Telescope. NEW-MUSIC will provide 2.4 octaves of spectropolarimetric coverage in six spectral bands from 80 to 420 GHz (0.7–3.8 mm). It will be deployed on the Leighton Chajnantor Telescope (LCT), the re-siting of the 11 μm rms, 10.4 m Leighton Telescope of the Caltech Submillimeter Observatory to Cerro Toco in the Atacama Desert in Chile.

A number of key elements enable this broad spectral coverage with fundamental-noise-limited performance. Hierarchical phased arrays of slot-dipole antennas using low-loss, hydrogenated amorphous silicon (a-Si:H) dielectric make it possible to couple incoming light to detectors across the 2.4-octave bandwidth while also matching pixel size to the diffraction spot size so the detector count and sensitivity requirements are not unnecessarily demanding. The antennas are also inherently polarization-selective. We couple light into the antennas through the silicon substrate using metamaterial, silicon, antireflective structures. We sense the light from the antennas with Al or AlMn microstrip-coupled, parallel-plate capacitor, lumped-element KIDs (MS-PPC-LEKIDs), an innovative new KID design that combines the low two-level-system noise of a-Si:H with a flexible KID design that is also inherently shielded against direct absorption. These KIDs provide sensitivity limited only by photon statistics and generation-recombination noise (the sum being what we term “fundamental noise”). This revolutionary focal plane technology will be integrated into the existing MUSIC cryostat and relay optics and make use of existing KID readout systems to enable quick deployment.

2. SCIENTIFIC MOTIVATION

2.1 The Trans-mm Time-Domain Frontier

NEW-MUSIC on LCT will have transformative impact via simultaneous observations in six spectral bands from 80 to 420 GHz, covering the critical spectral range where transient and time-domain synchrotron emission shows peaks and spectral breaks and where dust thermal emission is accessible in most weather conditions at an excellent site. NEW-MUSIC/LCT will build on enormous investments in O/IR time-domain surveys and the growing transient alert capacity of mm-wave CMB surveys.

2.1.1 Explosive Stellar Death

The Nearby Universe

Death omens Core-collapse supernovae (CCSNe) explode in a circumstellar medium (CSM) sculpted by mass loss during the star’s life. There is increasing evidence that many, or perhaps most, massive stars undergo intense eruptive mass loss within days to years of core collapse, producing a dense CSM. However, emission from supernova-driven shocks in dense CSM (“Interacting SNe”) is absorbed at early times (when the explosion is still close to the source; days to weeks) *except in the trans-mm*. NEW-MUSIC/LCT’s simultaneous six-band observations with mJy sensitivity (Table 1) will track the explosion size and the structure of the surrounding medium (CSM density and magnetic pressure) via the time evolution of the synchrotron self-absorption (or

Class	Luminosity	Horizon	Rate	
	[10^{27} erg/s/Hz]	[Gpc]	[yr/Gpc^3]	[yr]
SNe	1	0.013	100,000	0.4
Interacting SNe	100	0.130	10,000	37
FBOT	1,000	0.410	100	12
LLGRB	100	0.130	1,000	3.7
LGRB $\theta_{\text{obs}} < 0.2$	100,000	4.090	0.3	34
LGRB $0.2 < \theta_{\text{obs}} < 0.4$	30,000	2.240	1	23
LGRB $0.4 < \theta_{\text{obs}} < 0.8$	1,000	0.410	5	0.5
relativistic TDEs	20,000	1.800	0.03	0.3

Table 1. **Estimated luminosities, detection horizons, and volumetric and total detection rates for various classes of exotic explosions.** The rates assume a 5σ flux limit of 5 mJy at 90 GHz (feasible in a 3-minute LCT integration: see Table 4). Simultaneous multi-band observations would yield 5σ flux limits at 150, 230, 290, 345, and 405 GHz of 10, 9, 13, 25, and 46 mJy (Table 4). The rate of SNe is given as a reference point for luminosities and rates, not because they are a viable science target. SNe, interacting SNe rates from,¹ and we assume LLGRBs occur at 1% of the SNe rate. FBOT, LGRB, and TDE rates and luminosities from.² For jetted LGRBs and TDEs, the luminosity is not intrinsic but observed.

free-free absorption) peak. A program to study nearby ($\lesssim 100$ Mpc) events would comprehensively assess pre-supernova mass-loss rates across the zoo of CCSNe. Insight into the CSM structure may also shed light on the nature of the progenitors.

Relativistic outflows into the CSM? Fast blue optical transients (FBOTs) are a recently discovered class of transients, remarkable because of their blue colors and short (≈ 10 day) durations. Many models have been put forth (see, e.g.,³ for a review); one is that they are a particularly rare (0.1%) class of interacting SNe, interesting because the newly formed compact object launches a mildly relativistic outflow into the CSM that enhances the luminosity by 100 times. Seven have been discovered to-date, informing the rate estimate. NEW-MUSIC/LCT should detect of order ten FBOTs per year (Table 1) to substantially enhance the sample with trans-mm SEDs well-sampled in time, which will reveal the dynamics of the outflow and the explosion environment and directly probe the particle acceleration process in relativistic shocks.

Low-luminosity gamma-ray bursts LLGRBs are thought to be cases of the fairly common broad-line SNe Ic that emit gamma-rays like gamma-ray bursts (discussed below) but with lower luminosity, perhaps due to smothering by a dense CSM — effectively, another case of CCSNe exploding into a dense CSM, but now adding gamma-rays. NEW-MUSIC/LCT should detect a handful a year, adding to our understanding of the LLGRB emission mechanism and CSM.

The Distant Universe

Gamma-ray bursts Long-duration gamma-ray bursts (LGRBs) are thought to arise from relativistic jets launched in the collapse of massive stars. Thousands of GRBs have been discovered, but only a handful have the trans-mm data that provide unique information about the jet. In particular, the reverse shock (RS) dominates the trans-mm at early times ($\lesssim 1$ day⁵) and provides information about the baryon content and magnetization of the ejecta, while the forward shock (FS) dominates from $\mathcal{O}(1)$ day onward and provides information about the CSM, including its magnetic field geometry via polarization.⁵ Figure 1 shows a typical spectrum at 3.9 days and Table 1 shows luminosities and rates for different viewing angles. CSM information may be critical to testing whether LGRBs are a special case of LLGRBs, one in which the CSM is tenuous and the full gamma-ray emission can escape.⁶

Jets from shredded stars Relativistic tidal disruption events (TDEs) are a rare case of TDEs in which a synchrotron-emitting jet is launched⁷ when the supermassive black hole shreds a passing star. Only 1–10% of all TDEs are relativistic, so only four have been observed, with *Swift* J1644+57 being an exemplar (Figure 1).

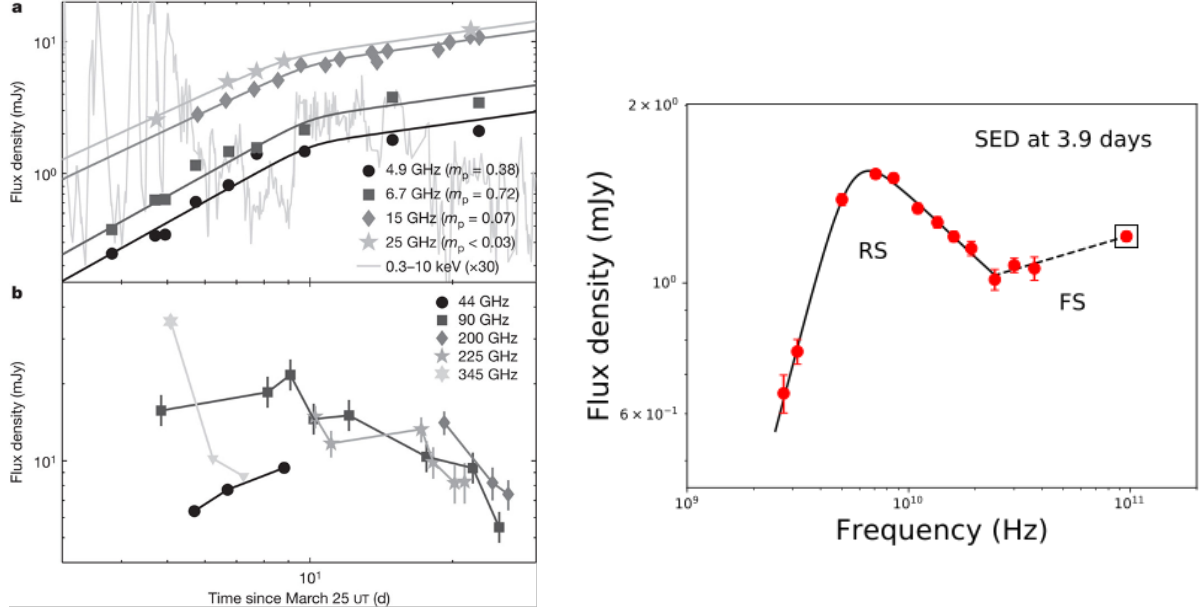

Figure 1. (Left) **The tidal disruption event (TDE) *Swift* J1644.493+57.3451.** Radio (top) and trans-mm (bottom) lightcurves.⁴ While the smooth radio light-curves are affected by self-absorption within the source, the structure in the trans-mm lightcurves probe the rapidly flickering relativistic jet. (Right) **GRB afterglow SED.**⁵ At earlier times (< 1 day), the reverse shock will peak in the trans-mm.

NEW-MUSIC/LCT could detect a relativistic TDE once every year or two (Table 1), yielding trans-mm SEDs well-sampled in time that, like for FBOTs, will reveal the environment and outflow dynamics and directly probe relativistic shock particle acceleration. Non-relativistic TDEs are 100 times less luminous,² so their 10–100× higher rate does not compensate the smaller detection volume.

Black Hole Accretion Black holes accreting from companion stars power transient jets when in outburst. Trans-mm monitoring near the spectral power-law break probes jet power variability that is more difficult to observe at lower frequencies due to synchrotron self-absorption.⁸ As these sources evolve over the weeks following the outbursts, mm flares are still observed, likely tracing discrete jet ejections. For the handful of such systems studied, this field has been plagued by sparse data relative to the minimum variability timescales of \ll hours, with recent dedicated observations revealing just how significant the activity is on short timescales and at high frequencies (see Figure 2). NEW-MUSIC/LCT minute-by-minute measurements, with ≈ 10 mJy rms at 345 GHz, would be sufficient to track the variability detected by ALMA, to do so in many more sources, and to provide substantial SED information to characterize the time evolution of the spectral break.

Novae These thermonuclear explosions on accreting white dwarfs yield shocks that accelerate particles to radiate in the radio, X-rays, and gamma-rays. Internal shocks determine the morphology of nova ejecta and eventually lead to dust and molecule formation in the interstellar medium. Nova synchrotron emission should be brighter in the trans-mm early on, but data are lacking. V1324 Sco, one of the most gamma-ray-luminous novae, showed mJy fluxes at 33 GHz with a spectral index $F_\nu \sim \nu^2$ at tens of days.⁹ NEW-MUSIC/LCT would have been able to provide a full SED with mJy noise in 3 minutes, and these SEDs and their time evolution would be much more diagnostic of the electron spectrum and the gamma-ray source than radio data.¹⁰

2.1.2 Outbursts and Pulses from Stellar Remnants

Magnetars Magnetars, incredibly magnetized neutron stars with 10^{13-15} G fields, can have pulsed trans-mm emission synchronized to their radio pulsar activity, but the trans-mm emission mechanism is not known. It is even conceivable the pulsed flux, and the SED shape and position of the break, can vary with time.¹¹ Of the thirty known magnetars, six are radio-loud, but only two have been detected in the trans-mm: XTE J1810-197

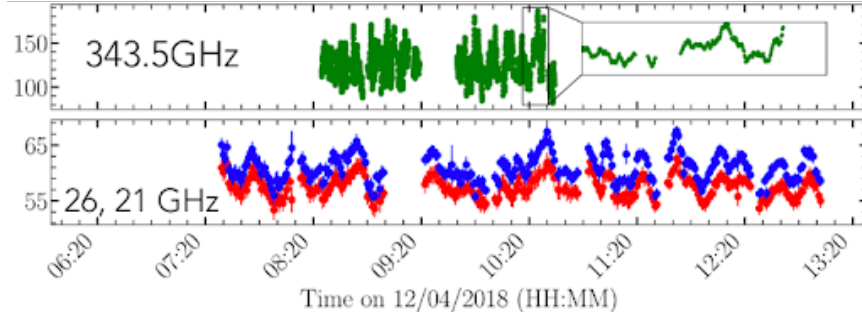

Figure 2. **ALMA and VLA lightcurves of the black hole X-ray binary MAXI J1820+070.**⁸ (Top) ALMA; (bottom) VLA. The flux density units are mJy. The high-frequency lightcurve is much richer and exhibits faster-timescale variation than those at lower frequencies.

(Figure 3), which exhibits a spectral break in the trans-mm, and the galactic center magnetar SGR J1745-2900, 2–290 GHz with a $\nu^{0.4}$ spectrum. NEW/MUSIC can both monitor the spectral shape of these known sources and search for trans-mm emission from others, even those with past non-detections given potential variability.

2.1.3 Mass Buildup in Infant Stars

Young stellar objects (YSOs) are generally underluminous compared to expected mass accretion rates. The wide range of YSO variability (e.g., Figure 3 of¹²), with some outbursts showing $100\times$ increase in luminosity lasting for decades, support the idea of episodic accretion. Trans-mm variability can be cleanly used to measure the change in T_{dust} driven by stellar luminosity variations.^{12–14} The JCMT Transient Survey^{15,16} has monitored eight nearby star-forming regions monthly since 2015/2016, observing 10–30% variations in $\gtrsim 20\%$ of sources at a rms sensitivity per half-hour monthly observation of 14 mJy/beam at 345 GHz. NEW-MUSIC/LCT will complement and expand on this work by accessing the southern sky and achieving a factor of 2 better sensitivity (see Table 1 caption). Six-band SEDs will enable a search for time-variable free-free emission.

2.1.4 Active Stars and Exoplanet Habitability

The number of millimeter flares from across the stellar landscape is growing, mainly via serendipitous searches in wide-area CMB surveys.^{17,18} The flares range over six orders of magnitude in luminosity, entirely unexpected from prior radio data. Several flares are in binary systems (including YSOs) and may be triggered by reconnection events in the interacting magnetospheres. Only one flare has spectral information above 300 GHz. The short flare timescales of several minutes to several hours, and extremely low duty cycles, motivate rapid ($\lesssim 1$ hr) follow-up with NEW-MUSIC/LCT. The flares seen to date, with flux changes of tens to hundreds of mJy at 90–220 GHz, are eminently detectable with NEW-MUSIC/LCT’s 1–10 mJy rms across this spectral band in 3 minutes (Table 1 caption), and NEW-MUSIC/LCT will add three more bands of data, especially in the poorly sampled region above 300 GHz. Multi-band lightcurves will reveal the flare energetics, critical for understanding the emission mechanism. Cyclotron emission is likely and will be circularly polarized. Such flares have deep implications for exoplanet habitability: life on Earth relies on the relatively modest solar flaring activity and protection by Earth’s magnetic field.

2.1.5 Active Galactic Nuclei: A View Deep into the Jet

Most radio galaxies have compact cores with flat spectra ($L_\nu \sim \nu^0$). The flux at a given frequency is dominated by a radius $r \propto \nu^{-1}$ for a conical jet. In low-luminosity sources such as M87, the innermost parts of the jet (at about 5–10 Schwarzschild radii) emit at ~ 200 GHz, while for higher luminosity sources, and more strongly relativistically beamed ones, the innermost parts emit at 400 GHz or above. As shocks propagate down the jets and compress the magnetic field, there are flux outbursts and swings of polarization correlated with inverse-Compton-scattered high-energy gamma-ray emission. Trans-mm monitoring of ~ 100 “interesting” sources on a few-day cadence would complement the long-running 15 GHz monitoring program on the Caltech OVRO 40 m telescope,¹⁹ more completely characterizing variability over a range of length scales deep into the jet. Especially

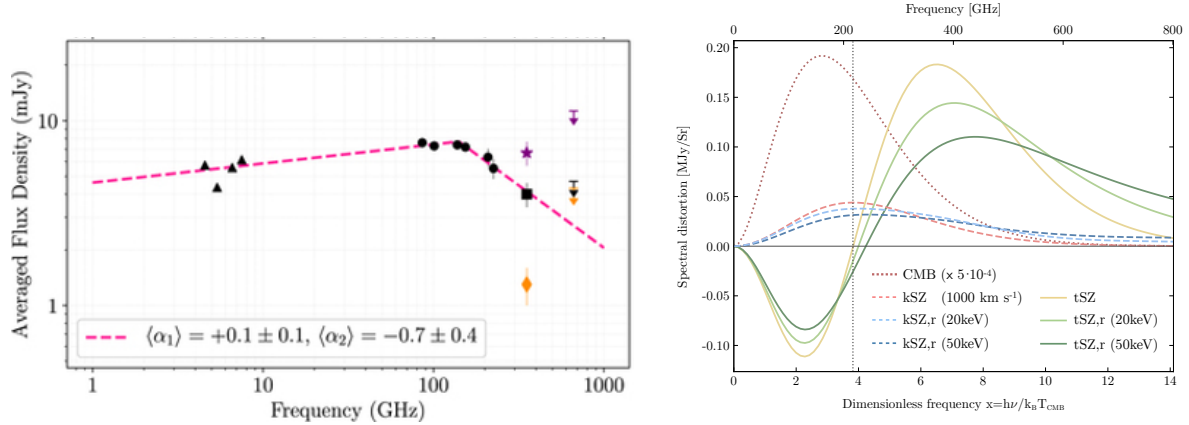

Figure 3. (Left) **Mean spectrum of the magnetar XTE J1810-197.**¹¹ Different colored points indicate measurements at different epochs; the power-law fit is done for one epoch. The “averaged flux density” is the integral of the flux density over the pulse divided by the period; the peak pulse flux is of order 20 times larger, easily detectable with NEW-MUSIC/LCT, while no quiescent flux has been detected. NEW-MUSIC/LCT would cover the spectral peak. (Right) **Sunyaev-Zeldovich effect spectra.**²⁰ Solid: thermal (tSZ); dashed: kinematic (kSZ). Relativistic corrections are included, differentiating the spectral shapes for different electron temperatures (in keV). The assumed optical depth is $\tau = 10^{-2}$ and the Comptonization parameter is $y = 10^{-4}$. The dotted curve illustrates the shape of the unscattered CMB spectrum, which has been scaled by a factor of 5×10^{-4} . The importance of multiple trans-mm spectral bands for measuring and separating the CMB, tSZ, and kSZ is clear.

exciting would be correlations with gamma-rays (CTA) and neutrinos (IceCube, Baikal, KM3NeT). Many of these sources are bright (> 30 mJy, so $\text{SNR} > 30$ in three minutes (Table 1 caption)) and used as pointing calibrators, ensuring a large database of observations.

2.2 Using Hot Gas Haloes to Study Accretion and Feedback in Galaxy and Galaxy Cluster Evolution

Astro2020²¹ highlighted the emerging study of accretion and feedback via the hot, ionized CGM’s thermal energy density (= pressure) and electron density distributions as measured by, respectively, the thermal and kinetic Sunyaev-Zeldovich (tSZ, kSZ) effects*. kSZ can also reveal coherent flows of ionized gas (non-thermal gas motions).

2.2.1 The Dynamics of Accretion from the IGM onto the ICM in Galaxy Clusters

Galaxy clusters serve as high-mass, high-SNR galaxy analogues for studying accretion from the intergalactic medium (IGM). The accretion shock heats infalling gas to near-virial temperatures, but significant support against gravity is also provided by residual coherent motions of order 500 km/s.^{23–25} Such support should coincide with a tSZ thermal pressure deficit relative to hydrostatic equilibrium,^{26–28} for which there is modest evidence^{26–31} (Figure 4). kSZ measurements of such motions have been sensitivity-limited to extreme mergers (relative velocity ~ 3000 km/s;^{32,33} Figure 4), though the recently fielded TolTEC/LMT³⁴ will have 5–10 \times better sensitivity and 5 \times finer angular resolution.

With six bands and better sensitivity than prior instruments on CSO, NEW-MUSIC/LCT will be able to spectrally separate tSZ, kSZ, and dust/synchrotron contaminants in a large program on 20 well-studied galaxy clusters. The $\gtrsim 20\times$ improvement in tSZ SNR will enable %-level constraints on non-thermal pressure, yielding a high-significance detection and distinguishing among simulations (Figure 4). The 10 \times kSZ uncertainty improvement to 100 km/s will enable mapping of bulk motion in typical clusters, complementing TolTEC/LMT in field size. Future X-ray spectroscopic imaging (XRISM, *NewAthena*, X-ray probe mission) of such motions will also be complementary, mainly probing core regions at lower z . The high-frequency bands will constrain the ICM dust content and deliver SZ constraints on the mass-weighted temperature via relativistic corrections.

*CMB distortions due to scattering with free electrons²²

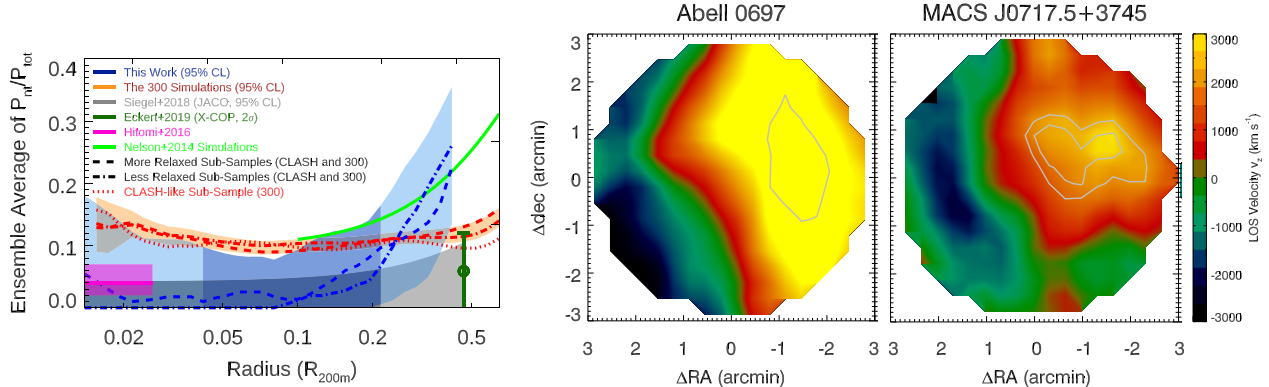

Figure 4. (Left) **Non-thermal pressure fraction as a function of radius from an analysis of 16 galaxy clusters,**³⁰ compared to prior results^{26,29} and simulations. (Right) **Illustration of the use of kSZ for non-thermal motions.**³³ The contours are 2σ and 3σ . A moving subclump in MACSJ0717.5 is clearly detected, and both mergers show prominent cluster-wide trends, but current sensitivity only permits the detection of extreme bulk motions in mergers.

2.2.2 Feedback and the Relation between Galaxies and their Circumgalactic Medium

Simulations show that, on galaxy scales, deviations from self-similar, gravity-only predictions for the radial tSZ profile of stacks of galaxies reflect feedback mechanisms including supernova winds,^{35–37} AGN-driven outflows,^{38–40} and cosmic-ray pressure.^{39,41} Both deficits and excesses have been observed and there are varying degrees of consistency with simulations that do or do not incorporate AGN feedback.^{42–49} Current work focuses only on quiescent, high-mass galaxies rather than comparing star-forming and quiescent samples, and thus conclusions rely on comparison to imperfect, incompletely calibrated simulations. Empirical comparison of different samples may be more conclusive, but deeper maps are needed. Dust contamination is also a serious problem.^{42,48}

Relative to prior work with *Planck*, SPT, and ACT, NEW-MUSIC/LCT’s angular resolution, broader spectral coverage, and narrower, deeper survey will reach to 3–10× lower mass. Its high-frequency bands will better constrain dust than the 220 GHz data used to date. These improvements will enable differential measurements between galaxy stacks with different star-formation rates and potentially a detection of a deviation of the tSZ-mass relation from self-similarity.

2.3 Dust in Stellar and Planetary Nurseries

NEW-MUSIC/LCT will provide six-band SEDs and polarimetry of dust thermal emission in star-forming regions, protostellar cores, and protoplanetary disks, with many potential applications. Magnetic field orientation measurements on scales between ALMA (sub-arcminute) and *Planck* (degree) can help quantify the role of magnetic fields in regulating star formation. The frequency dependence of dust polarization on small scales can reveal whether different dust temperatures and populations are needed,⁵⁰ impacting shielding in many environments. SEDs of protoplanetary disks can yield sizes and environments of large dust grains, testing if protoplanetary dust forms *in situ* and how grain size affects shielding and clumping, impacting the speed of protoplanetary disk evolution.

3. INSTRUMENT PARAMETERS

Table 2 summarizes the spectral bands we are targeting for NEW-MUSIC, motivated by a combination of the science goals outlined above, atmospheric transmission windows, and appropriateness of the technologies being developed.

The prime driver for this specific frequency range is science using the Sunyaev-Zeldovich effects, as this spectral range overlaps the atmospheric windows where the effect is bright and spectrally distinguishable from contaminating sources such as the primary anisotropy of the cosmic microwave background, radio galaxies, and, most importantly, dusty, star-forming galaxies. As outlined in the prior section, this frequency range is also an excellent match to unfulfilled needs for the study of time-domain sources in this spectral band. In particular, the

Quantity	B1	B2	B3	B4	B5	B6
ν [GHz]	90	150	230	275	350	400
λ [mm]	3.3	2.0	1.3	1.1	0.87	0.74
$\Delta\nu$ [GHz]	35	47	45	40	34	30
T_{atm} [K]	5	6	10	14	30	57
T_{tel} [K]	13	13	13	13	27	27
T_{exc} [K]	14	14	17	20	41	61
T_{load} [K]	32	33	40	47	98	145
ℓ_{pix} [mm]	6.66	6.66	3.33	3.33	1.66	1.66
$(f/\#)\lambda$	1.17	1.94	1.46	1.84	1.11	1.30
FWHM ["]	76	53	32	29	20	17
N_{pix}	64	64	256	256	1024	1024

Table 2. **NEW-MUSIC spectral bands, expected optical loads, pixel sizes, beam FWHMs, and pixel counts.** ν , λ = spectral band center; $\Delta\nu$ = spectral bandwidth; T_{atm} , T_{tel} , T_{exc} , T_{load} = Rayleigh-Jeans optical loading from atmosphere, telescope, instrument, and total. T_{atm} assumes ≈ 25 th percentile precipitable water vapor conditions (PWV = 0.55 mm) for Cerro Toco; see text for motivation for this choice. T_{tel} assumes 1% or 2% emissivity per aluminum optical reflecting surface (see §4.4 for optical configuration) but neglects panels gaps and feedleg scattering. T_{exc} is assumed to be such that the total loading is increased by an ad hoc factor of $\sqrt{3}$ from telescope and sky loading alone. The bandwidths and optical loadings have intentionally been optimistically chosen to place the most stringent demands on instrument sensitivity. The choice of pixel sizes and numbers of pixels is discussed in the text. The beam FWHMs on the sky derive from the pixel size and the optical configuration.

large proposed spectral range (1:5.25) will provide a large lever arm for: measuring spectral indices and looking for spectral breaks in non-thermal sources that constrain their engines, emission mechanisms, and explosion and outflow dynamics; for constraining $T/(1+z)$ for extragalactic dusty sources; and, for separating synchrotron, free-free, and thermal dust emission for local sources.

The specific choice of bands is driven by the available atmospheric windows (see Figure 10), with the additional requirement that we split the very wide 190–310 GHz window into two bands to obtain spectral information across that window. Practical considerations limit the spectral bands at high and low frequencies. Above 420 GHz, there are no atmospheric windows with useful fractional bandwidths until the 650 and 850 GHz windows, which approach the Nb gap and thus require a fundamentally different optical coupling technology. The rarity of good observing conditions at these higher frequencies also argue for different instrumentation. At low frequencies, there is again a large gap down to the next atmospheric window below 45 GHz. The combination of degraded angular resolution and the need for a much lower T_c material render other technical approaches more appropriate.

We note that we evaluate the atmospheric optical load at the approximate 25th percentile for the site, 0.55 mm PWV, because we expect that, under *better* conditions, LCT will be in use for 650 and 850 GHz observations. (Comprehensive weather statistics are actually not available for Cerro Toco. The one existing study of Cerro Toco⁵¹ suggests that the PWV there is, on average, 90% of that on the plateau. Thus, we use the percentile for 0.6 mm PWV on the plateau.^{52, 53}) We use the *best* planned observing conditions for our calculations to obtain the most stringent requirements on instrument sensitivity so that, under all conditions, the instrument is background limited.

Table 2 also summarizes the focal plane parameters: pixel size in mm and $(f/\#)\lambda$, beam FWHM, and number of pixels. The $f/\#$ of the optics is chosen so that the pixel size is between $1(f/\#)\lambda$ and $2(f/\#)\lambda$ at all frequencies. The band centers work out such that the pixel size is closer to $1(f/\#)\lambda$ at high frequency, where angular resolution is important for dusty, star-forming galaxies, while the pixel size is more conservative (closer to $2(f/\#)\lambda$) at low frequencies where sidelobes and stray light are more of a concern.

The total number of pixels in each band is chosen to approximately fill the LCT 14' field of view. (Gaps between pixels for KIDs and the readout feedline make the focal plane larger than $\ell_{pix}\sqrt{N_{pix}}$.) Initial deployment will use a quarter-scale focal plane, and the final instrument will consist of four copies of the quarter-scale focal plane.

4. TECHNICAL APPROACH

4.1 Focal Plane Architecture – Design

4.1.1 Polarized, Hierarchical Antennas using Low-Loss Hydrogenated Amorphous Silicon (a-Si:H)

4.1.1.1 Phased Arrays of Slot-Dipole Antennas Light is received at the focal plane by a superconducting phased-array antenna,^{54,55} back-illuminated through the silicon substrate, as shown in Figure 5. The fundamental element is a 1.664 mm long, 18 μm wide slot in a niobium ground plane. An incoming EM wave polarized normal to the slot excites a voltage across it, which excites waves on capacitively shunted microstripline (“microstrip”)⁵⁶ feeds crossing the slot. The feeds have a 54 Ω impedance given the microstripline geometry. The capacitors are 37 $\mu\text{m} \times 10 \mu\text{m}$ and have 40 Ω reactance at 100 GHz. The 1 μm wide microstrip comprises the ground plane (190 nm thick) and a Nb wiring layer (160 nm thick) sandwiching a 1070 nm thick hydrogenated amorphous silicon (a-Si:H) dielectric layer. The ground plane prevents direct excitation of the microstrip by incoming light, both by geometrical blocking and by imposing a zero electric field boundary condition $\ll \lambda$ away from the top conductor. A binary summing tree combines the trans-mm wave from 16 feeds along a slot and from 16 such slots with equal path lengths. The feeds and the slots are all spaced by 104 μm center-to-center. After each summing junction, the now-widened microstripline is tapered back down in width so the summing tree occupies minimal space between the slots, but then the microstripline exiting the summing tree is allowed stay at the final summing junction output width, 5 μm . This wider microstripline is both more ideal (width large compared to the 1.07 μm dielectric thickness) and more robust against fabrication defects as it travels to the filters and KIDs. A backshort 150 μm from the vacuum side improves the antenna forward efficiency averaged over its entire band, and it does this for a very wide bandwidth because of the high permittivity substrate (whose thickness is also optimized in the calculation). The inductance it adds is tuned out by the capacitive shunts at the feeds. The intrinsic bandwidth of the antenna is calculated to be very wide, 1:7.5 above 90% efficiency.

To the extent that the slot impedance is the same for all 16 feeds along a slot, the illumination of the antenna is uniform and the far-field beam will be sinc-like. Variations of the slot impedance with position may cause the illumination to be tapered along the slots. At low frequency, the impedance oscillates significantly along the slot (varying by $\pm 50\%$ at 100 GHz) but the variation is over the entire slot, while, as the frequency increases, the slot impedance is stable over the bulk of the slot and then shows similar $\pm 50\%$ variations only near the ends. The resulting coupling variation may result in a small E - H plane beam asymmetry. Fortunately, even these significant impedance mismatches should cause $\lesssim 10\%$ variations in power coupling from the slot to the feed. It remains to be determined whether any such effects are observed (see §4.3.2). If so, they may be corrected by adjusting the dimensions of the phased array.

4.1.1.2 Hierarchical Summing The main innovation in the phased-array antennas for NEW-MUSIC is to hierarchically sum the slot antennas in a frequency-selective way so that the pixel size grows with wavelength to roughly track the diffraction $\text{FWHM} = (F/\#)\lambda$. Figure 5 shows how photolithographic low-pass and band-pass filters (LPFs and BPFs) will be used to do this, starting with 16×16 , 1.664 mm antennas. The main advantage is the nearly optimal trade-off between optical efficiency and angular resolution. For λ for which a fixed antenna size is smaller than $(F/\#)\lambda$, its efficiency is $< 50\%$, enhancing the requirement on detector noise. For λ for which the fixed antenna size is larger than $2(F/\#)\lambda$, angular resolution is degraded ($\text{FWHM} > \lambda/D$), which degrades point source sensitivity and confusion limit.

In implementing hierarchical summing, we allow gaps between the fundamental elements, which could have been avoided by use of microstripline crossovers. While such crossovers have been demonstrated at trans-mm wavelengths,⁵⁷ we deemed it simpler, more robust, and easier to model to instead array the 16×16 slot antennas with gaps between them, using the space between them for filtering and microstripline routing without crossovers. The gaps are 208 μm between the level 0 (fundamental) antennas and 312 μm between the level 1 (one level of summing) antennas; the gap grows because the level 1 gap must permit space for the summing trees. Both are multiples of the feed/slot spacing of 104 μm .

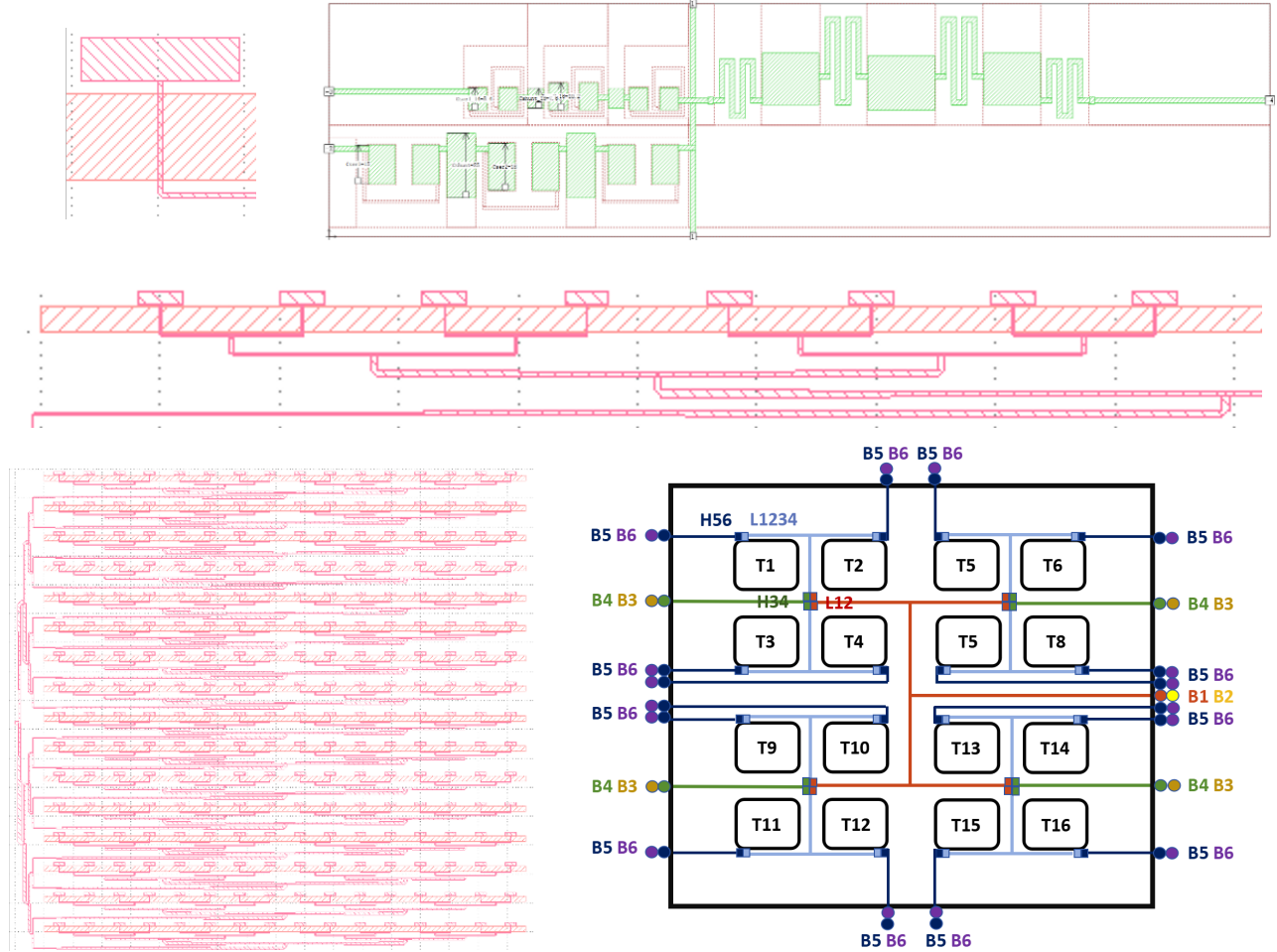

Figure 5. **Hierarchical phased-array antenna and filterbank example.** (Top left) Close-up view of one $1 \mu\text{m}$ wide feed crossing the $18 \mu\text{m}$ wide slot and shunted to the ground plane by a $37 \mu\text{m} \times 10 \mu\text{m}$ capacitor at the top. (Top right) Summing junction/BPF-LPF filterbank example. The microstriplines entering at top and bottom carry the in-phase signals after summing of two 16×16 fundamental elements. The rectangular shapes are capacitors, either shunt capacitors to the ground plane (single elements) or series capacitors (paired elements) where one plate is on the microstripline layer and one plate is in a window in the ground plane. The meanders connecting them are inductors, sitting in the same windows in the ground plane. To provide a scale, the capacitor at lower left has $15 \mu\text{m}$ vertical dimension. The filters at the left are B3 and B4 BPFs. The filter at right is a LPF that passes B1 and B2. A similar BPF/LPF combination must be placed at the output of each 16×16 fundamental element, but it only requires a single input since it does not perform summing, just filtering. After the final summing junction at the center of the entire hierarchical array, there will be a B1-B2 BPF filterbank with no LPF. (Middle) Close-up view of half of one slot with its summing tree. The slot is left-right mirror symmetric except for the output leg of the summing tree. (Bottom left) 16×16 fundamental antenna element. (Bottom right) Schematic showing how antenna elements' outputs are routed, selectively filtered, and summed for the three-scale antenna. Each square "TX" is a 16×16 fundamental element (level 0). Of the four elements of a level 1 group (e.g., T1, T2, T3, T4), the left ones match the schematic at bottom left while the right ones have been mirrored through a vertical line so the summing tree exits to the right, not the left. (There is no mirroring through a horizontal line because that would cause a 180° phase shift of the feed excitation.) The elements of each level 1 group are separated by $208 \mu\text{m}$ while the elements of the level 2 group are separated by $312 \mu\text{m}$ to accommodate the summing trees. The gaps provide sufficient space for the required summing junctions and filterbanks.

4.1.1.3 Low-Loss a-Si:H for Trans-mm Microstripline An enabling technology for hierarchical phased-array antennas is low-loss dielectric for the trans-mm-wave microstripline, which permits the detectors for even the highest-frequency bands of interest to be at the outer edge of the low-frequency antenna. We use hydrogenated

amorphous silicon (a-Si:H), for which we have demonstrated recipes with RF loss tangent δ as low as 7×10^{-6} .⁵⁸ For fabrication convenience here, we used somewhat lossier recipes, with $\delta \approx 3 \times 10^{-5}$ (see §4.2 for details). The dielectric is 1070 nm thick to provide a microstripline impedance comparable to that obtained with more typical dielectrics ($\epsilon_r \approx 12$ for a-Si:H vs. $\epsilon_r \approx 4$ for SiO_x and $\epsilon_r \approx 7$ for SiN_x , $\mu = \mu_0$ for all). For the material used here and assuming a trans-mm loss tangent equal to the RF loss tangent, the microstripline dielectric loss for the 420 GHz band would be 0.6%. It is expected the loss tangent will increase between RF and trans-mm frequencies,^{59,60} but even a factor 10 degradation would yield an acceptable 94% microstripline transmission at 420 GHz.

4.1.1.4 Polarization Coverage While the antennas are inherently polarization-selective, it is well understood that polarization sensitivity must be modulated quickly to mitigate systematic uncertainties in differencing complementary polarizations on the sky. The first level of such differencing will be provided by rotating the antennas 90° between adjacent level 2 (B1/B2) pixels, separated by approximately $1.5'$ on the sky. At scan speeds of $0.5\text{--}1^\circ/\text{s}$, there will be only a 25–50 ms time separation, fast enough to freeze atmospheric emission variations (“sky noise”).^{61,62} The sky noise will thus provide a relative calibration and will difference away well. Parallaxic angle rotation will yield full coverage in Q and U Stokes parameters. Another, potentially more effective level of differencing, pending evaluation of its consistency with the final optical design, would be provided by placing a polarizing grid between the final lens and the focal plane, feeding complementary polarizations to two focal planes situated at right angles with respect to each other. Additional modulation could be provided by a rotating or stepped broadband, multi-layer, sapphire half-wave plate,^{63–65} cryogenically situated at an internal Lyot stop, though obtaining the necessary 2.4-octave bandwidth may be challenging.⁶⁶ A more practical option may be a rotating or stepped broadband, reflective metal-mesh half-wave plate⁶⁷ placed at one flat relay mirror outside the cryostat. If circular polarization sensitivity is desired (interesting for stellar flaring cyclotron emission, §2.1.4), a variable-delay polarization modulator^{68–70} could be used at the second flat relay mirror, employing a $\lambda/8$ air gap rather than the conventional $\lambda/4$ to make it a quarter-wave rather than half-wave plate. This approach is narrow-band, but observations could be taken sequentially with multiple spacings.

4.1.2 Microstrip-Coupled, Parallel-Plate Capacitor, Lumped-Element KIDs (MS-PPC-LEKIDs) using Low-Noise a-Si:H

4.1.2.1 Parallel-Plate Capacitor, Lumped-Element KIDs (PPC-LEKIDs) The trans-mm microstripline exiting the BPFs couple to a novel KID design illustrated in Figure 6.^{71,72} The two ends of a meandered inductor connect to two plates, all 100 nm thick Al or AlMn. The structure sits on top of the ground plane and a first 800 nm thick a-Si:H layer. The top plates form two parallel-plate capacitors (PPCs) with the ground plane, connected in series. The symmetric KID design makes the shared PPC electrode a virtual ground, obviating isolating it from the ground plane. While the two plates could in principle couple to an incoming electric field normal to the slot between them, the ground plane shields the KID inductor and capacitor in the same way as it does the trans-mm microstrip. To prevent out-diffusion of the quasiparticles into the inductor, we deposit Nb (via liftoff to prevent etching damage to the KID material) on the PPC top plates to raise the pair-breaking energy to 3 meV. This energy corresponds to $\nu = 2 \Delta_{\text{Nb}}/h \approx 740$ GHz, so the Nb is also a poor direct absorber for in-band light (as well as being highly reflective even above 740 GHz). We couple the KID to a $2 \mu\text{m}$ wide microstripline feedline (impedance 32.5Ω) via a PPC coupling capacitor attached to one end of the inductor. Though it is difficult to impedance-match this type of feedline to 50Ω , it ensures the ground plane is uninterrupted except at the antenna slots. A traditional coplanar-waveguide (CPW) feedline inherently breaks the ground plane into two halves, which can at best be coupled intermittently by ground bridges across the CPW.

4.1.2.2 Microstrip Coupling The trans-mm microstripline deposits power in the inductor via a unique capacitive coupling. For B4/B5/B6, the design is similar to the one we detailed earlier for a TiN_x inductor,⁷² illustrated in Figure 6. The microstripline from the BPF encounters a 50-50 splitter. One of the outputs is delayed by a half-wavelength so that the two complementary microstriplines, now with nearly equal magnitude but opposite sign trans-mm voltages on their top electrodes, present a trans-mm voltage difference. The KID

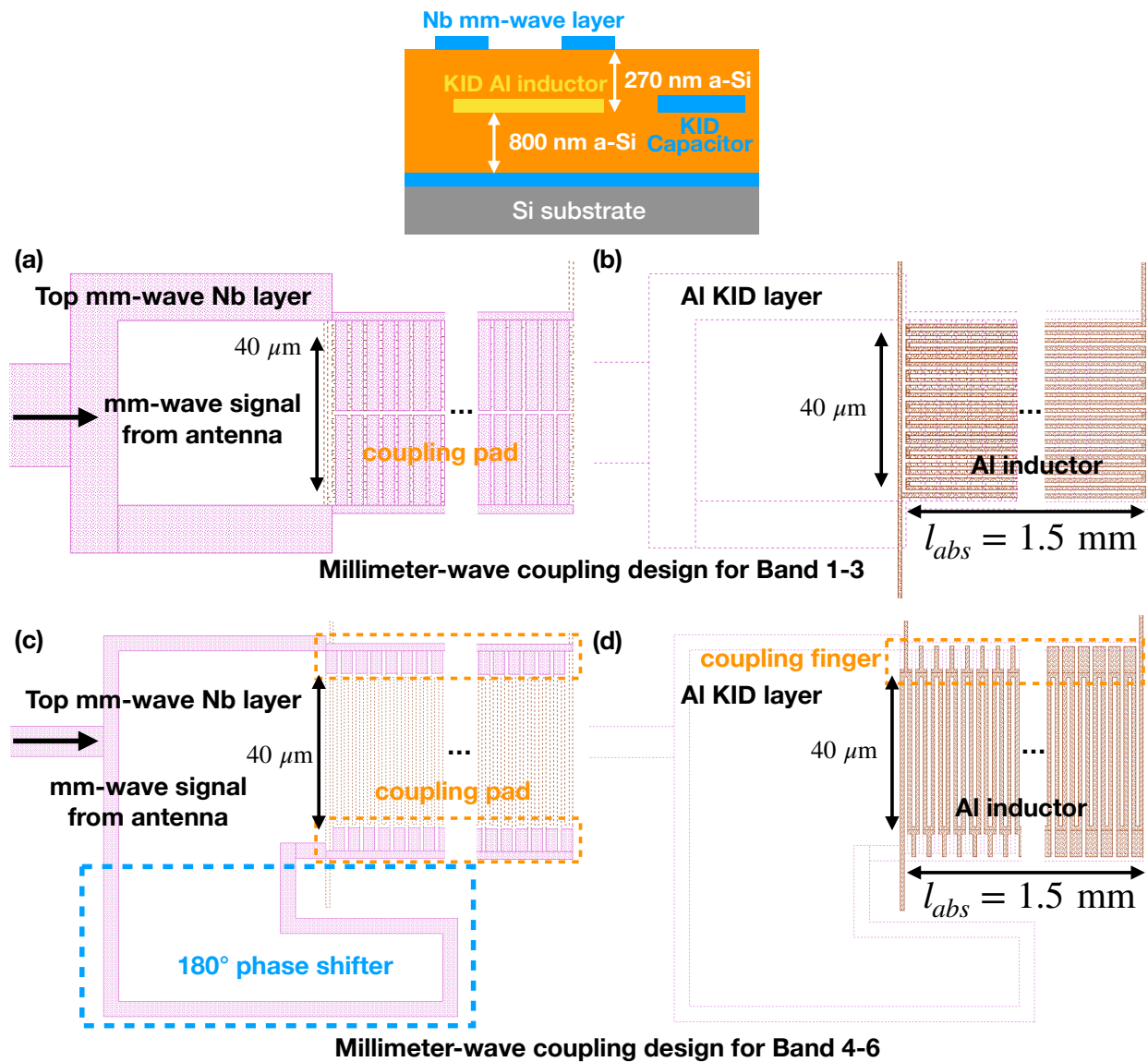

Figure 6. Coupling of trans-mm microstripline to KID inductor (Top) Layer structure. (Bottom) These structures couple trans-mm power from the microstripline entering at the left into the KID inductor. Different structures are used at lower frequencies (B1–B3) and higher frequencies (B4–B6). The Nb microstripline top layer is shown in magenta. The Al KID inductor layer is shown in brown. The underlying Nb ground plane and the intervening dielectric layers are not shown. The operation of each of the structures is described in the text. Figures reproduced from.⁷¹

inductor meanders back and forth in the space between the two microstriplines, with small pads extending from the end of each meander under pads that extend outward from the microstripline top electrode, separated by 270 nm of a-Si:H (the total thickness of 1070 nm less the 800 nm thickness between the KID inductor and the ground plane). The overlapping pads and each meander of the inductor thus form a trans-mm C - R - C network, through which the trans-mm voltage on the two microstriplines drives a trans-mm current. This current dissipates the trans-mm power in the meanders of the KID inductor. Any single C - R - C element has a lumped element impedance much larger than that of the microstripline, and the microstripline continues onward, so each meander can be considered a high parasitic impedance between the two microstriplines rather than a terminating impedance. With many such meanders, the trans-mm power is adiabatically absorbed as the wave propagates down the microstripline pair. The coupling C can be increased along the microstripline so that equal power, rather than equal fractional power, is absorbed per unit length, ensuring the trans-mm power is absorbed uniformly over the entire inductor rather than with an exponential profile. The coupling C and the meander width, thickness, and length are all free parameters, providing a great deal of design space to simultaneously obtain a high enough KID responsivity (set by the KID inductance, capacitance, and inductor volume) that generation-recombination (and thus photon noise) dominates over amplifier and TLS noise while also obtaining high optical absorptance. The details of the optimization have been previously provided for a TiN_x inductor⁷² and for an Al inductor.⁷¹ We term this design the “adiabatic lumped-element” coupler.

For the lower frequency bands B1/B2/B3, it proved difficult for the above design to provide high optical absorptance with a meander of a reasonable length and width given the low frequency combined with the low resistivity of Al (or AlMn) in comparison to the TiN_x for which the design was originally intended.⁷² (A narrower Al linewidth could have addressed this challenge, but we worried about fabrication yield given that the Al sits on somewhat rough a-Si:H rather than optically polished crystalline silicon.) We therefore developed an alternative “traveling wave” coupler design, illustrated in Figure 6. First, we taper the microstripline to a very large width (low impedance) to match the low impedance of the coupler structure. Again, there is a 50-50 splitter, but this time with no delay added. Instead, where the two microstriplines run in parallel, we extend the capacitive pads from each microstripline to become fingers, almost touching between the two microstriplines. The KID inductor is again sandwiched between the ground plane and the microstripline top electrode, with the same 800 nm/270 nm split of the a-Si:H thicknesses. In this case, however, the inductor meanders along the same direction as the microstripline, and the microstripline’s capacitive tabs extend almost completely over the inductor’s meanders. We believe this geometry effectively makes a capacitive voltage divider between the microstripline top electrode, the inductor, and the ground plane, imposing a spatially varying voltage along the KID meanders. This coupling excites a microstripline mode between the meanders and the ground plane, and the mode’s energy is dissipated in the trans-mm-lossy KID inductor material. Each long KID meander is connected to one of its neighbors at either end in order to form one continuous inductor. The reflections imposed by these shorts effectively make the excitation in the KID inductive meander microstripline a standing wave that is excited by the incoming wave on the Nb microstripline. Like the adiabatic lumped-element coupler, the traveling wave coupler is adiabatic in the sense that power is deposited gradually along the coupler’s microstripline rather than by terminating the microstripline in a matched impedance. Again, the details of the optimization have been previously provided.⁷¹

Since there is no voltage difference between the 50-50 split Nb microstriplines in the traveling-wave design, the split may be an unnecessary residual feature of its origin in the adiabatic lumped element coupler. The use of capacitive fingers is, however, important: it provides the necessary voltage divider coupling to the KID meander while maintaining a higher microstripline impedance than would be obtained by simply widening the microstripline to cover the KID inductor. The capacitance per unit length \mathcal{C} is increased by about half as much as would have been obtained by widening the microstripline, while the inductance per unit length \mathcal{L} is largely unchanged (very little current flows along the fingers). Therefore, rather than the impedance decreasing by a factor $\approx w_b/w_c$, where w_b and w_c are the microstripline width exiting the BPF and in the coupler, it decreases by a more modest factor, $\approx \sqrt{2 w_b/w_c}$. The increase in microstripline width between the BPF and the coupler can be smaller by the same factor.

4.1.2.3 Contrasts with Prior KID Designs Our design contrasts with the other standard approaches for coupling mm/submm power to KIDs: direct absorption in the inductor (unmediated by microstripline) and termination of microstripline directly in the KID inductor. In both cases, the KID inductor must match the impedance of the incoming wave, which may be in vacuum (direct illumination), a vacuum cavity (horn-coupled direct illumination), dielectric (silicon or alumina lens coupling), or microstripline (horn, lens, or antenna coupling), while simultaneously providing high enough responsivity (deriving from the volume and resonant frequency) for photon-background-limited sensitivity. Impedance depends on film thickness and line width, so yield and uniformity can be fabrication challenges. The designs used here are quite robust against film thickness and linewidth variations because the adiabatic coupling to the KID avoids dimension-sensitive impedance matching.

4.1.2.4 Low-Noise a-Si:H for PPC-LEKIDs This design is only feasible because of our development of low-loss a-Si:H, based on⁷³ but with $10\times$ lower loss tangent⁵⁸ and at least $2\times$ lower noise.⁷⁴ Our first work⁵⁸ presented two a-Si:H deposition recipes for two different machines at two sites and found that the loss tangent is stable, both across films fabricated months or years apart⁵⁸ and in a given film over time ($d\delta_{TLS}/dt \approx 0.35 \times 10^{-6}/\text{mo}$ in a typical lab environment). Our KID design optimization⁷¹ used measurements of TLS noise for recipe A from⁵⁸ taken at $T_{bath} = 100$ mK. In this work, we make our measurements at $T_{bath} \approx 250$ mK. Assuming the measured $T_{bath}^{-1.7}$ scaling of TLS noise power spectral density with temperature⁷⁵ and a naive (and experimentally unconfirmed) linear scaling with δ_{TLS} , we should observe TLS noise about $1.5\times$ lower than the design.

4.1.2.5 AlMn KIDs Al, especially in thin films, generally has T_c too high to be suitable for B1, whose lower edge is ≈ 75 GHz: even bulk $T_c \approx 1.2$ K and thus $2\Delta_{Al}/h \approx 88$ GHz would substantially decrease the B1 bandwidth (Table 2), and thin films generally have higher T_c .⁷⁶ We will therefore use AlMn, an alloy in which Mn suppresses Al T_c ⁷⁷⁻⁸⁰ and that has previously yielded $Q > 2 \times 10^5$ resonators down to $T_c = 0.69$ K.⁸¹

4.1.2.6 Control and Trimming of f_r There is reason to believe PPC-LEKID resonant frequencies will be more well controlled than for IDC-based KID designs: because the electric field is so well confined in the PPC, there should be negligible frequency scatter due to parasitic capacitances and inter-resonator couplings. Fabrication non-uniformities such as variations of inductor linewidth and thickness (both affecting geometrical as well as kinetic inductance), dielectric thickness, or PPC plate dimensions should be smooth functions of position. Regardless, it is sensible to have a trimming mechanism.^{82,83} We will etch the edge of the PPC furthest away from the inductor (etching through a-Si:H, Nb, and Al) to avoid collateral damage to the inductor by etch chemicals permeating between layers transversely to the inductor, which was a problem in the past for some of the buffered oxide etches used to clean various layers before or after the second a-Si:H deposition (§4.2).

4.2 Focal Plane Architecture – Fabrication

The devices are fabricated on double-side polished, high-resistivity, float-zone silicon wafers, 100 mm in diameter and $375 \mu\text{m}$ thick. We do fine-scale photolithography using a Canon EX3 stepper mask aligner and some coarser features (e.g., a-Si:H trench etch) using a Heidelberg MLA 150 maskless aligner. Steps:

- 1. Nb ground plane:** After a buffered oxide etch (BOE) dip of the wafer to remove native oxide, we ion mill and then deposit a 190 nm thick ground plane via RF magnetron sputtering using a 6-inch target at 900 W RF power. It is patterned with the antenna slots and the BPF windows using a fluorine etch in an ICP RIE machine.
- 2. First a-Si:H layer (microstripline, KID capacitor):** Another BOE dip is done (to remove oxides on the Nb) and then a 1070 nm a-Si:H layer is deposited by CVD. The machines and recipes available are described in detail elsewhere.⁵⁸ The lowest loss recipes require deposition in a machine at JPL with 350°C substrate temperature, which can cause flaking if the deposition chamber is not properly conditioned. For the first device studied here, we deposited at 350°C but with a machine at the Caltech Kavli Nanoscience Institute that has previously yielded $\delta \approx 1.2 \times 10^{-5}$,⁵⁸ and for the second device, we used the JPL machine

but at 150° C, which previous work had shown yielded $\delta \approx 3 \times 10^{-5}$. We then etch away 270 nm of a-Si:H in windows where the resonators, coupling capacitors, and microwave feedline will reside.

3. **KID inductor and capacitor top plates:** After a BOE dip to remove SiO_x that forms on the first a-Si:H layer, we ion mill the a-Si:H and then sputter-deposit the 100 nm Al layer using a 6-inch target and 750 W RF power. If doing AlMn, we instead use a dedicated machine that co-sputters AlMn (2500 ppm Mn doping) and pure Al, aiming for 750 ppm. We use chlorine etch in an ICP RIE machine to pattern the Al (AlMn) to obtain the KID inductor and capacitor, coupling capacitor outer (bottom) plates, and readout feedline. We then ion mill the Al (AlMn) and deposit/pattern, using liftoff, 50 nm Nb and 30 nm Al over the patterned Al (AlMn) *except over the KID inductor* (same 6-inch target sputter tool and powers). The Nb is intended to prevent outdiffusion of quasiparticles from the Al (AlMn) inductor and to increase the threshold frequency for photon absorption in the capacitor (already mitigated by its high reflectivity and its placement within 1.1 μm of the Nb ground plane). It also ensures the feedline has transmission at 4 K, which is useful for device screening. The Al top layer protects the thin Nb layer from the later “Nb wiring layer” etch (step 5 below).
4. **Second a-Si:H layer (trans-mm coupler):** A second layer of a-Si:H is then deposited, 270 nm thick, now always at 150 C to prevent damage to the underlying Al film (formation of AlSi at ≈ 166 C) and always using the JPL ICP PECVD (both for convenience and because the KNI PECVD does not make good a-Si:H at 150 C). No BOE dip is done before this deposition to avoid damage to the now-patterned KID Al (AlMn); any oxide at the interface will only be present in the trans-mm coupler, not in the KID or the trans-mm microstripline. This a-Si:H layer is etched away almost everywhere except in the window where the prior a-Si:H layer was etched. The result is an approximately constant thickness of a-Si:H over the entire wafer, but with the KID inductor and capacitor films (and KID coupling capacitor outer plates and readout feedline) residing between the 800 nm and 270 nm a-Si:H layers. The one exception is that the 2nd a-Si:H layer is etched away over the microwave feedline bondpads so they are accessible.
5. **Nb wiring layer:** We complete the KID, antenna, and bandpass filters, and also the KID coupling capacitor by ion milling the a-Si:H and depositing a last Nb layer, 160 nm thick, which is now patterned using fluorine-chlorine ICP RIE. This etch is not highly selective against Si, hence the Al protect layer for the microwave feedline in step 3.

Ideally, because it is more effective at removing SiO_x , we would do a BOE dip prior to the Nb layer, but there have been cases in which BOE at this step reduced KID yield, presumably because BOE can permeate through microfissures or pinholes in the a-Si:H to the Al (AlMn) KID layer. To achieve the best trans-mm loss, we may try to resolve this problem so we may implement a BOE dip at this step.

6. **Borders for good electrical and thermal connection:** To ensure good RF and thermal coupling to the device box, we etch a border through all the layers (fluorine- SF_6 ICP RIE) to expose the Nb ground plane. On three sides of the device, we additionally etch through part of the exposed Nb (same fluorine-chlorine ICP RIE as Nb wiring layer) and deposit 10 nm of Ti (sticking layer) and 350 nm of Au by electron-beam evaporation through a liftoff mask that leaves openings over both Si and Nb. When the device is mounted, Au wirebonds connect the Au pads to the copper box to provide good thermal connection to the silicon substrate (see discussion of substrate heating vs. direct absorption in the KIDs in §4.3.6) as well as electrical connection to Nb on three sides, and Al wirebonds connect the Nb ground plane on the fourth side to the box for RF grounding.

4.3 Focal Plane Architecture – Experimental Validation

We undertook extensive dark and optical tests of two prototype devices. Both devices incorporate a two-scale analogue of the three-scale antenna planned for NEW-MUSIC. For B3–B5, the two-scale prototype uses a fundamental 3.328 mm wide, 32×32 slot array antenna, analogous to the 16×16 slot array antenna presented in §4.1.1 and Figure 5, and it sums four such antennas for B2, so it tests the critical feature: summing of fundamental elements with gaps between. Both devices also incorporate a limited set of bands as a first step in

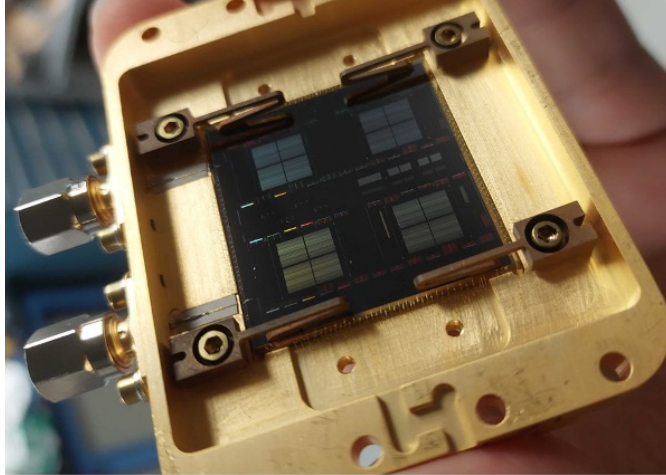

Figure 7. **Fabricated device.** The 32 mm \times 32 mm die is mounted in a gold-plated copper box. (No Ni sticking layer is used because it can be magnetic.) Below the wafer (not visible) is a window in the box and a metamaterial silicon antireflection wafer. Phosphor bronze spring clips hold the device in place. Numerous wirebonds provide thermal and RF connection to the box (see text). On the chip, there are four copies of the hierarchical antenna. Along the midline of the wafer, one can see the Nb LC resonators (the large rectangles) used to measure a-Si:H RF loss as well as four dark KIDs. Before installation in the cryostat, a Nb backshort is placed above the device, located and fixed by the four screw holes in the wells. The relative height of the wells and the shoulders for the die are precision-machined so the backshort surface is at the desired 150 μm distance from the device, with an uncertainty of 10–20 μm .

the complexity of the filter banks.[†] Each antenna feeds four KIDs in each of B3–B5 and one KID in B2. We additionally have four dark KIDs (no connection to an antenna). We thus expect to see 56 KID resonances on each die.

The second device incorporates some pixels where an output feeds not one but rather two KIDs for loss and impedance/wave-speed testing. For the former, a 50-50 splitter is followed immediately by a KID on one leg and by a long length of microstripline terminated in a KID on the other leg. The relative optical efficiency of the two KIDs measures the transmittance, and thus the loss, of the length of microstripline. For the latter, the second arm of the splitter is instead followed by a Fabry-Perot cavity consisting of a widened (and thus impedance-mismatched) length of microstripline. The resulting standing wave pattern’s frequency measures the microstripline wave-speed and its amplitude contrast measures the ratio of the widened to standard microstripline impedance. The total number of KIDs is unchanged, but 14 more are “dark” due to the microstrip routing required for the test structures. Measurements of these test structures are not yet available, so we report only on the non-test-structure KIDs.

For optical testing, the devices incorporated a 2-layer metamaterial-structured silicon antireflection wafer (1:1.6 bandwidth, 190–310 GHz)⁸⁴ and a niobium backshort (§4.1.1). They were tested in a pulse-tube-cooled 4 K dewar with a 240 mK Chase $^3\text{He}/^3\text{He}/^4\text{He}$ sorption refrigerator.⁸⁵ The dewar has a UHMWPE window (with single-layer Porex[‡] PM23DR 0.25 mm thick AR coating) with ≈ 30 cm clear aperture, permitting very wide angle beam measurements (up to 40° off axis). For blackbody radiation filtering, the dewar has five 3 mm thick Zotefoam[§] HD-30 sheets behind the vacuum window, two PTFE filters (25 and 10 mm thick, with single-layer Porex PM23DR 0.25 mm thick AR coatings) at 50 K, and, at 4 K, a nylon filter (10 mm thick, with single-layer Porex PMV30 0.25 mm thick AR coating) and a 420 GHz low-pass cutoff metal mesh filter.⁸⁶ To ensure good heat sinking of the devices, we bond the Au border on three sides of the device to the copper device box every

[†]In fact, each fundamental element has its own four-band BPF at its output, following by summing of the B2 outputs. The long-term scheme would not use BPFs for the bands to be summed but only LPFs, with a single BPF to follow after summing. This latter approach prevents BPF variation among the summed elements from causing beam asymmetries.

[‡]<https://www.porex.com/products/porous-sheets/>

[§]<https://www.zotefoams.com>

0.5–1 mm using Au wirebonds. The remaining side has Al wirebonds to the Nb ground plane and microwave feedline of similar density. Figure 7 shows the backside of a device mounted for testing.

A magnetic shield, residing at 4 K and consisting of two layers of Amuneral A4K material, enclosed the devices to limit the impact of Earth’s magnetic field. The shield incorporates an aperture at the top to permit optical access for one device. The device under optical test incorporates an additional single-layer A4K shield, also with an aperture, to improve its shielding as it sits near the aperture in the larger shield. A combination of stainless steel and NbTi semi-rigid coaxial cables carried the readout signal to the devices, with 30 dB and 10 dB in-line attenuators at 4 K and 0.35 K, respectively, to block 300 K thermal noise. Similar NbTi coax carried the signal exiting each device to a cryogenic SiGe low-noise amplifier (LNA) at 4 K (ASU 10 MHz–2 GHz or Cosmic Microwave Technologies CITLF2), with a noise temperature of approximately 5 K, followed by stainless steel coax back to 300 K. Additional LNAs at 300 K ensured the cryogenic LNA dominated the system noise. We monitored the device temperature using a Stanford Research System (SRS) SIM921 reading a Lakeshore Germanium Resistance Thermometer (GRT) located next to the devices. The temperature was controlled using a SRS SIM960 analog PID controller supplying a current to a 10 k Ω heater on the mechanical stage holding the devices.

Measurements relying on $S_{21}(f)$ scans used a Copper Mountain Technologies SC5065 Vector Network Analyzer. We used the Python module SCRAPS⁸⁷ to fit the $S_{21}(f)$ data to standard forms (e.g.,⁸⁸) to extract the resonance frequency f_r and quality factors Q_r , Q_i , and Q_c . Measurements of small signal response such as beam maps and Fourier Transform Spectroscopy used an Ettus X310 USRP with a UBX 160 daughter card. Measurements of noise relied on a standard homodyne mixing setup. The resonator drive signal and local oscillator for mixing was provided by an Anritsu MG3694A synthesizer, and the mixer was followed by Stanford Research Systems SR560 voltage preamplifiers and a National Instruments NI-9775 ADC.

4.3.1 KID Parameters and Yield

We use a vector network analyzer (VNA) to measure $S_{21}(f)$ over the frequency range containing the resonances at a range of T_{bath} values under dark conditions. We fit these resonance scans using standard techniques (e.g.,⁸⁹). Figure 8 shows frequency scans, $\delta f_r/f_r$ and Q_i vs. T_{bath} , and kinetic inductance fraction α and gap parameter Δ inferred from fits of the $\delta f_r/f_r$ vs. T_{bath} data to Mattis-Bardeen theory.⁹⁰ The different trans-mm spectral bands also have different f_r design ranges to enable disambiguation of bands without FTS data. Yield and uniformity is fairly high already. The two devices for which data are shown have yields of 55/56 and 47/56 resonators. Two additional devices show yields of >50/56 and 40/56 resonators. A detailed inspection has not yet been done, but, given the uniformity of the KIDs that do appear, we suspect catastrophic fabrication defects caused the failed resonators. Better process control will likely enable regular achievement of >95% yield.

From the Mattis-Bardeen fits, we infer $\Delta \approx 0.20$ – 0.22 meV, which would imply $2\Delta_{Al}/h \approx 100$ GHz. We find $\alpha \approx 0.25$ – 0.40 , fairly consistent with the design value $\alpha = 0.26$, which assumed 100 nm Al with a normal state sheet resistance of $0.069 \Omega/\square$.⁷¹ We speculate that the systematic differences in Δ and α between wafers are due to slight differences in Al film thickness: the penetration depth in particular, which determines α , is a strong function of thickness for $d \lesssim 100$ nm.⁸⁹ Fortunately, these variations in α only affect f_r as $1/\sqrt{1 + \alpha/(1 - \alpha)}$, so the f_r bands are very similar, 209–406 GHz and 213–417 MHz. (In the first device, two B3 resonators moved below 200 GHz, but the remainder did not move, so these shifts are likely due to a defect specific to those two resonators.) The design frequency range was 180–336 MHz, so the shift relative to design varies from 16% to 24% across the octave band. Given the good match of α to expectations, this shift seems likely to be due to unmodeled parasitic reactances.

Each device has a handful (3 and 6) of resonators that have anomalous $\delta f_r/f_r$ vs. T_{bath} curves. These all happen to be dark and also seem to have moved from their design f_r values (374–388 MHz for nominal darks, mixed with the other bands for the darks due to the test structures) by a larger factor than the optically sensitive KIDs, up to ~ 500 – 600 MHz. They all seem to have low α , too, which causes the anomalous $\delta f_r/f_r$ vs. T_{bath} . Lower α can explain part of the upward shift in f_r , but the films are the same thickness as those of the other KIDs, so the kinetic inductance L_k should not have changed. One potential explanation for all of this behavior is that the removal of the microstripline in the trans-mm coupler (unnecessary since these resonators are intended to be dark) increases the geometrical inductance L_g (decreases α) while also reducing C by a larger factor,

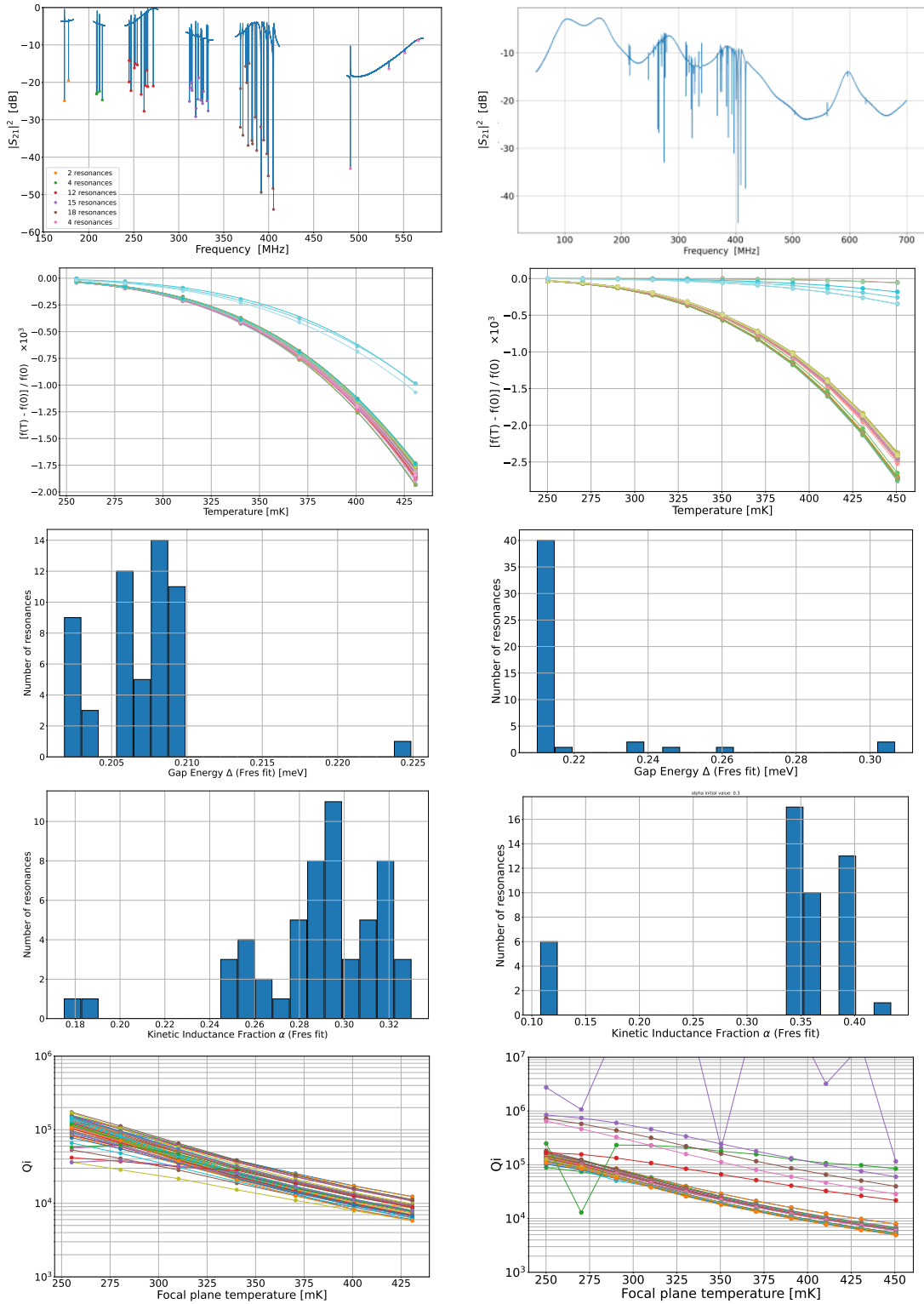

Figure 8. Measured KID parameters for two devices. See text for discussion.

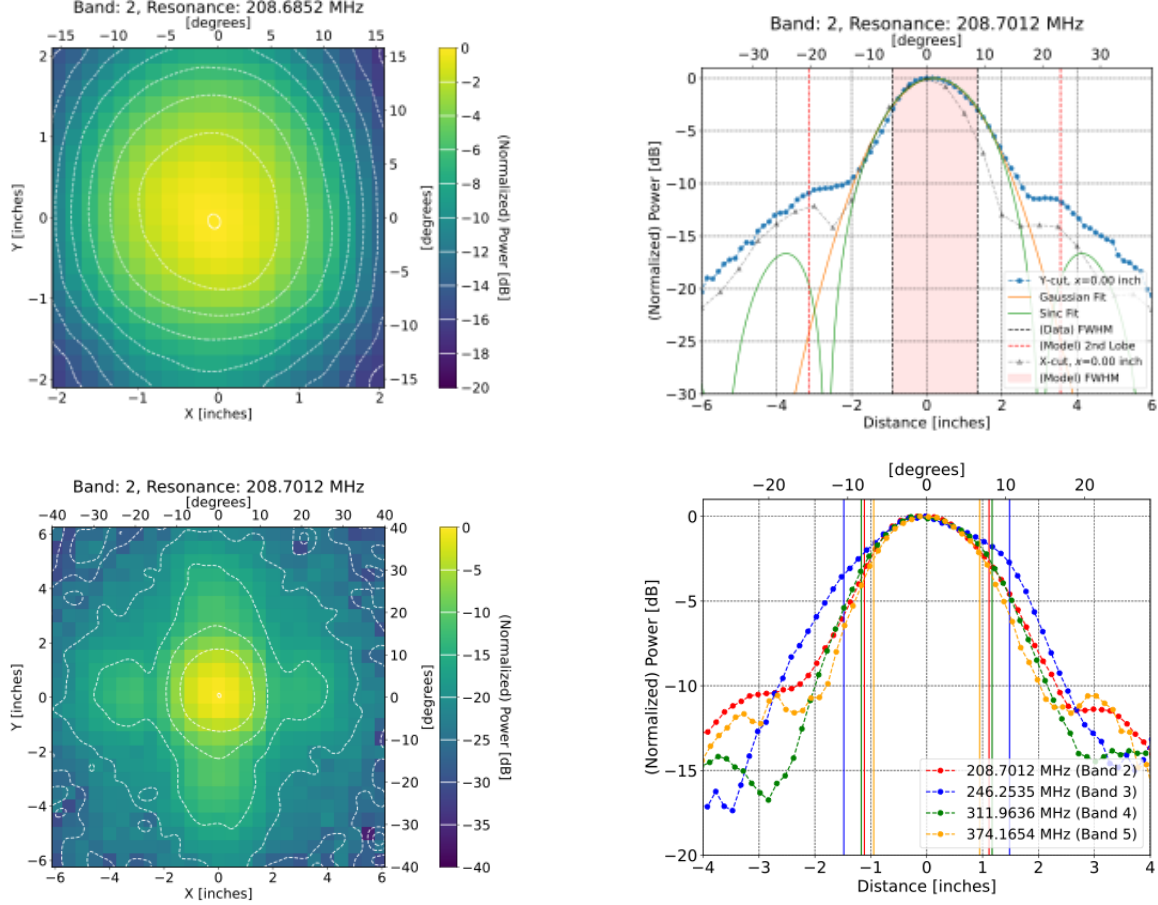

Figure 9. **Hierarchical phased-array antenna beam measurements.** (Left) B2 beam maps, main lobe (top), and wider map including sidelobes (bottom). (Top right) B2 beam cross sections and comparisons to expected FWHM and fits to gaussian and sinc functions. The slight difference in beam width in the two directions is being confirmed before corrective action is taken. (Right) Cross sections of beams for all four bands B2–B5. The FWHMs are within 10% of expectations.⁹¹ The near equality of the B2 and B4 FWHMs indicates the B2 summing works. The somewhat elevated sidelobes for B2 and B5 are being investigated.

making higher $f_r \propto 1/\sqrt{LC}$ possible in spite of the larger L_g . We will re-implement the trans-mm coupler for these dark KIDs (with no incoming microstripline) to eliminate this systematic difference.

For the majority of resonators, we find $Q_i \gtrsim 10^5$ and still rising at the lowest temperatures for which we have data, $T_{bath} \approx 250$ mK. There is good uniformity in the behavior. Thus, in spite of the unconventional device structure, with the Al inductor material on a thick a-Si:H layer and with many parasitic capacitive and inductive couplings, the loss is still dominated by quasiparticles at $T_{bath}/T_c \approx 0.15$ – 0.2 .

One challenge to be addressed is large variation of Q_c , over an order of magnitude (not shown). We suspect impedance mismatches arising from the use of the 32.5Ω microstripline feedline, causing reflections at the interfaces to the 50Ω readout wiring and standing waves on the feedline. Our initial choice of feedline width was conservative due to the catastrophic impact of feedline failure, but we have not had a single device with a failed feedline, we will try narrowing the feedline in future devices to increase the impedance.

4.3.2 Hierarchical Antenna Beams

Figure 9 shows experimental validation of beams. The measurements were done using a chopped hot blackbody source[¶] behind a 18.35 mm aperture at a distance of 189 mm. The main expected features are visible. Most importantly, the beam FWHM scales with frequency as expected, accounting for summing for B2, rendering the B2 FWHM similar to the B4 FWHM. The B3 and B4 beams show sidelobes similar in shape to the sinc expectation, though the nulls are insufficiently deep and the level is 2–5 dB too high. The B2 and B5 beams show shoulder-like features, as if the sinc function null were filled in. The B2 beam may show some asymmetry between the E and H planes, which we are confirming before taking corrective action. While we are still trying to understand some details, it is clear that hierarchical summing works well in spite of the gaps between the fundamental elements. Moreover, these sidelobes will be terminated on a cold Lyot stop in the NEW-MUSIC optical configuration (§4.4).

4.3.3 Spectral Bandpasses

Figure 10 shows bandpass measurements using a Martin-Puplett Fourier Transform Spectrometer fed by a chopped $\approx 1100^\circ$ C cavity blackbody^{||}. The measurements are overlaid on expectations from Sonnet for the BPF banks alone and expected atmospheric transmission for 1 mm and 2 mm PWV at the LCT site. There is good qualitative agreement of the measurements with expectations in terms of band centers and edges. The measured spectra show higher contrast ripples, and the B5 upper edge approaches the upper edge of its atmospheric window too closely (a design error). As noted above, the optical train includes a 190–310 GHz silicon antireflection wafer and UHWMPE, PTFE, and nylon plastic windows/filters coated with single-layer AR coatings, and an uncoated metal-mesh filter, so some reflections are to be expected. More detailed modeling is in process. Nevertheless, the basic elements of the design appear work, with refinement of the design and the measurement setup necessary to reduce non-idealities.

4.3.4 Optical Efficiency

We measure optical efficiency using beam-filling cold (liquid nitrogen) and hot (room temperature) blackbody loads^{**}. We use an air knife^{††} to prevent condensation on the large clear-aperture window during measurements. We measured f_r for the two values of T_{load} and a range of T_{bath} . We then fit the $\delta f_r/f_r$ data to a model that incorporates resonator-specific measurements of (α, Δ) from dark data (§4.3.1) and determines $P_{qp}(T_{load})$ and T_{exc} for each resonator, where P_{qp} is the optical power absorbed in the KID quasiparticle system (i.e., that can affect f_r and Q_i) and T_{exc} is the “excess load” due to emission from the dewar (especially the dewar windows) converted to a Rayleigh-Jeans load temperature outside the dewar. If P_{opt} is the power incident on the KID from the microstripline, then $P_{qp} = \eta_{pb} P_{opt}$ where η_{pb} is the efficiency with which incoming trans-mm photons break Cooper pairs (with the remainder of the energy lost to sub- 2Δ phonons). Figure 11 shows an example of these data and fits. To infer $P_{opt}(T_{load})$, we use η_{pb} as given in Table 4.

We obtain from $P_{opt}(T_{load})$ two quantities: dP_{opt}/dT_{load} and the optical efficiency, η_{opt} . To do so, we make a typical set of assumptions: 1) the antennas are single-moded and thus have throughput $A\Omega = \lambda^2$ at 100% efficiency; 2) the blackbody loads are in the Rayleigh-Jeans limit at the frequencies of interest; and, 3) the antenna is sensitive to a single polarization. These assumptions imply $P_{opt} = \eta_{opt} k_B T_{load} \Delta\nu$ where $\Delta\nu$ is the spectral bandpass width and η_{opt} is the end-to-end optical efficiency between the blackbody source and the KID, excluding η_{pb} . We may thus calculate $dP_{opt}/dT_{load} = P_{opt}/T_{load}$ trivially. As always, there is a degeneracy between $\Delta\nu$ and η_{opt} . Peak normalization of the spectral bandpasses is one choice that is frequently made. Another choice would be to take $\Delta\nu$ to be equal to the design values from Table 2 so that η_{opt} both incorporates

[¶]A commercial ceramic heater source (e.g., <https://www.amazon.com/Infrared-Ceramic-Heater-Forming-Element/dp/BOC394KWJB>), coated in Bock black.⁹²

^{||}CI-Systems SR-200N

^{**}61 cm \times 61 cm pieces of WAVASORB[®] VHP (<https://www.ecanechoicchambers.com/pdf/WAVASORB%20-%20VHP.pdf>). For the cold load, we immerse the blackbody in liquid nitrogen contained in a closed-cell ethylene vinyl acetate (EVA) foam container that we assembled from individual layers cut by Rapid Die Cut (<https://rapiddiecut.com>). The layers were provided with adhesive on one side to aid assembly.

^{††}Exair Super Air Knife, <https://www.exair.com/products/air-knives/super-air-knives.html>

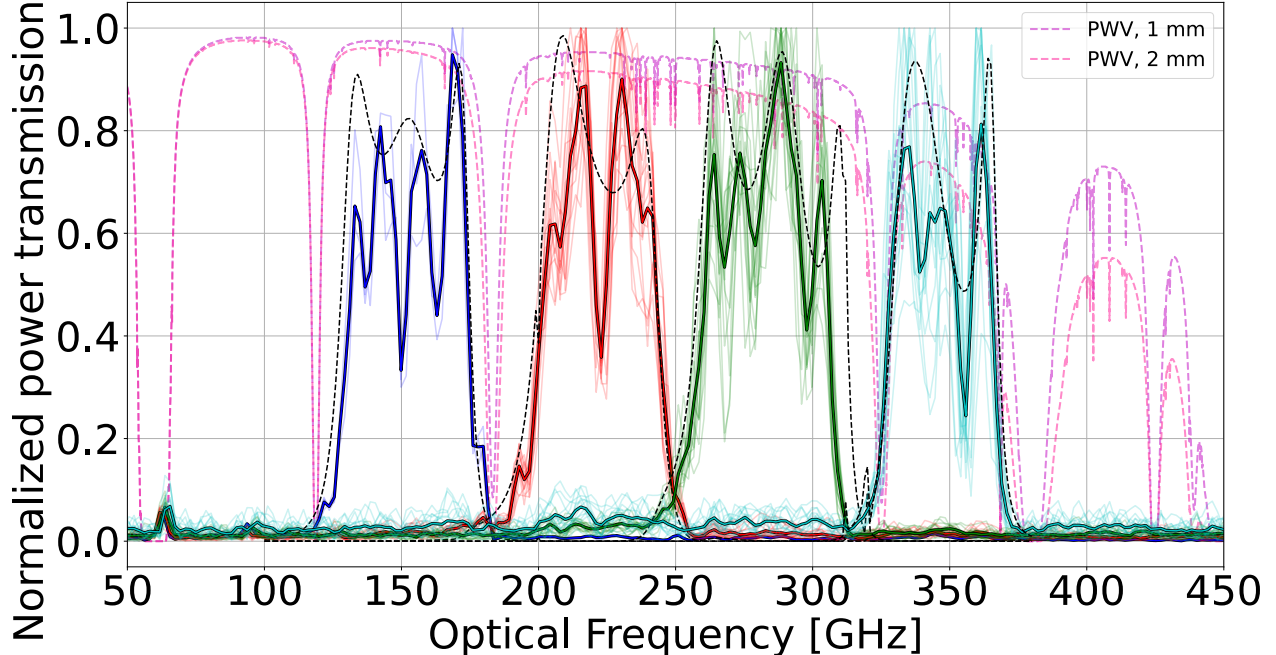

Figure 10. **Spectral bandpass measurements.** Bandpasses for B2–B5 measured using Fourier Transform Spectroscopy. Dashed black: design. Thin solid: individual KIDs. Thick solid: average by band. Dashed magenta: atmospheric transmission for LCT site with 1 and 2 mm precipitable water vapor (PWV; 50th and 75th percentile conditions), showing the as-yet unpopulated B1 and B6 windows.

non-idealities in the spectral bandpasses and absorption. Figure 11 provides plots of the unambiguous dP_{opt}/dT_{load} quantity, and Table 3 provide minimum, maximum, and mean values for each band and device for dP_{opt}/dT_{load} and for η_{opt} under the two different assumptions for $\Delta\nu$. We find the two choices for η_{opt} normalization differ fractionally at the $\lesssim 10\text{--}15\%$ level, resulting in no significant difference in interpretation of the results.

In B2, the dP_{opt}/dT_{load} values are comparable to the best typically achieved for sub-Kelvin detectors given the significant blackbody filtering required, 0.24 pW/K .⁹³ B3 has comparable performance to B2 in both dP_{opt}/dT_{load} and η_{opt} . There is a significant difference between *mean* B4 performance for the two devices. The second device again yields dP_{opt}/dT_{load} and η_{opt} performance comparable to B2 (and B3). The first device’s best detectors also match this performance, but it has a number of detectors with response lower by about 1/3 fractional. The B5 detectors show appreciably lower η_{opt} than all the other bands, also down by 40% relative to B2 and B3 but now uniformly. (Comparison of B5’s dP_{opt}/dT_{load} other bands is not useful because of its lower design bandwidth.)

While we have not modeled the optical efficiency in detail, we note at least two potential causes for variations in optical efficiency among bands (and especially in B5): loss in the plastic windows/filters (expected transmittances of 0.76, 0.71, 0.66, and 0.62 in the four bands) and reflection loss due to insufficiently wide-band AR coatings on optical elements (for the silicon AR wafer, $<0.5\%$ reflectance in B3 and B4 but $\approx 10\%$ and $\approx 5\%$ reflectance in B2 and B5, respectively⁸⁴). Together, these effects result in an expected transmittance relative to B3 of 0.96, unity, 0.93, and 0.83. Motivated by the dispersion among detectors noted above, which is not due to measurement uncertainty but rather to individual detectors suffering performance non-idealities, Table 3 compares these expected relative transmittances to B3-normalized *maximum* efficiencies. The B2–B4 relative transmissions are generally in line with expectations while the B5 relative transmission is not. A more extensive analysis is underway (§4.3.3) and may explain this discrepancy. We also plan measurements with a blackbody at the 4 K stage of the cryostat to eliminate filter transmission uncertainty.

We have developed a broader-bandwidth three-layer AR structure^{94,95} and are finalizing the development of an even broader-bandwidth four-layer AR design, and we anticipate implementing lower-loss windows and filters

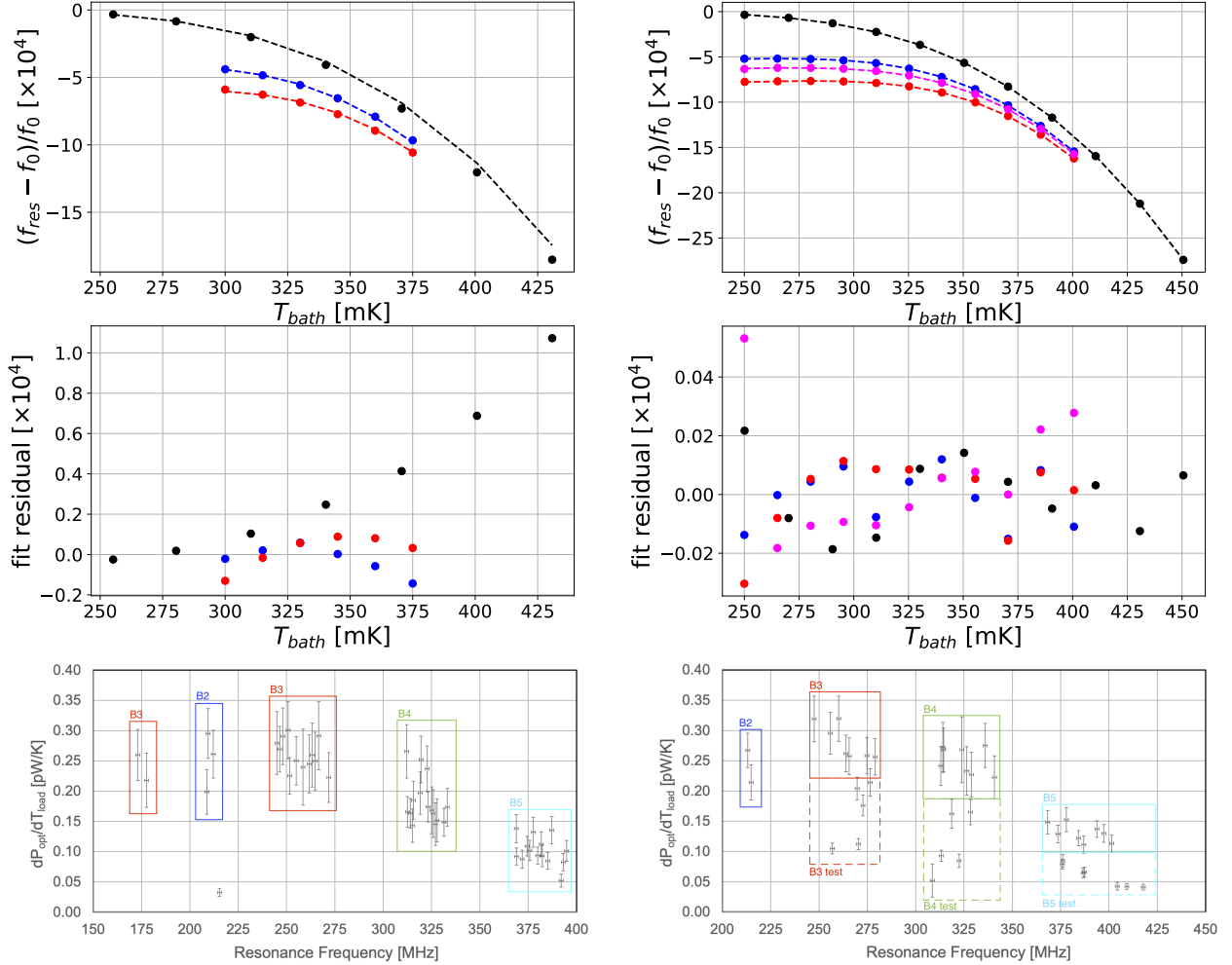

Figure 11. **Data used to measure trans-mm power absorbed in quasiparticle system for hot and cold black-body loads.** (Top) Typical $\delta f_r / f_r$ data sets used to fit for dP_{qp}/dT_{load} and T_{exc} for the two devices discussed here. Black, blue, magenta, and red data points and lines correspond to dark, cold, mirror, and hot data and fits. (The “mirror” data uses a reflective cover over the window and is not used in this analysis. There is no “mirror” data for the first device.) Data under optical load for the first device are over a restricted range of T_{bath} due to sub-Kelvin cryogenics problems during that cooldown. (Middle) Fit residuals. There is a greater systematic difference between dark data and model for the first device, but it does not appear to have significant impact on the results. Both fits allow for heating of the device wafer, $T_{substrate} \neq T_{bath}$. For the second device, the full power-law heating model provided in the text is used. For the first device, due to the limited T_{bath} range under optical load, a simple fixed temperature offset $T_{substrate} - T_{bath}$ was allowed. In both cases, however, the heating model shows results inconsistent between different resonators, suggesting it simply accommodates a systematic error in the modeling of $\delta f_r / f_r$ vs. T_{bath} . (Bottom) dP_{opt}/dT_{load} inferred from the above fits as explained in the text. The spectral bands are indicated, and “test” indicates resonators attached to test structures that should have lower response.

with better AR coatings, so we expect significant improvement in B5’s performance as well as modest gains in the other bands.

4.3.5 a-Si:H Loss Tangent

Every device includes lumped-element Nb LC resonators, identical in design to those used in our prior demonstrations of a-Si:H low-power TLS loss tangent as low as $\delta_{TLS}^0 \approx 7 \times 10^{-6}$ near 1 GHz,⁵⁸ so that we may measure independently this loss tangent *for the deposited material in the KIDs and microstripline on each device*. There are two sets of resonators, one incorporating the 800 nm a-Si:H in the KID capacitors and the other the 1070 nm

Band	Device	dP_{opt}/dT_{load}			$\eta_{opt}^{peak-norm}$			η_{opt}^{design}				expected	
		min	max	mean	min	max	mean	min	max	mean	max/B3	$\eta_{filt}\eta_{AR}$ value/	B3
2	a	0.20	0.30	0.25	0.33	0.49	0.42	0.31	0.46	0.39	0.95	0.68	0.96
2	b	0.21	0.27	0.24				0.33	0.41	0.37	0.81	0.68	0.96
3	a	0.22	0.30	0.26	0.39	0.53	0.46	0.35	0.48	0.41	1	0.71	1
3	b	0.26	0.32	0.28				0.41	0.51	0.45	1	0.71	1
4	a	0.14	0.27	0.18	0.23	0.42	0.29	0.26	0.48	0.33	1	0.66	0.93
4	b	0.22	0.28	0.25				0.40	0.50	0.45	0.98	0.66	0.93
5	a	0.08	0.14	0.10	0.16	0.27	0.21	0.18	0.29	0.22	0.60	0.59	0.83
5	b	0.11	0.15	0.13				0.24	0.33	0.28	0.65	0.59	0.83

Table 3. **Optical efficiency estimates.** We convert the minimum, maximum, and mean values of dP_{opt}/dT_{load} for each spectral band and each device to optical efficiency under the two different assumptions noted in the text: peak-normalized bandpasses and design bandpasses. The differences between the two approaches are at the 10% fractional level. We have not measured bandpasses for the second device, so we do not provide η_{opt}^{peak} values for it. The penultimate column shows the expected transmittance of the plastic windows and the silicon metamaterial antireflection wafer. For η_{opt}^{design} and the expected $\eta_{filt}\eta_{AR}$, we compute the values relative to the B3 values to assess whether the relative transmissions match expectations. (For the measurements, we use the maximum values as explained in the text.) The B2–B4 relative transmissions are generally in line with expectations while the B5 relative transmission is not.

a-Si:H in the microstripline. (See §4.1.2.2 and §4.2 for an explanation of the distinction between the two.) As in that prior work, we infer δ_{TLS}^0 by measuring $\delta f_r/f_r$ vs. T_{bath} in the 250–450 mK range, well below the temperatures at which quasiparticles cause any shift in f_r in Nb, and fitting for δ_{TLS}^0 as the normalization for the known TLS loss dependence on temperature (e.g.,^{88,89,96}). We show in Figure 12 loss tangents of 2 and 3.7×10^{-5} for the 800 nm KID a-Si:H for the two devices studied here. (The resonators for the 1070 nm microstripline a-Si:H do not seem to be present.) These results are 70% and 25% poorer than expected (§4.2), respectively, and worth tracking in future devices, but they do not significantly impact expectations for device optical efficiency or KID TLS noise.

We are in the midst of explicitly measuring the trans-mm wave loss of our a-Si:H using the dedicated test devices. We may set a conservative upper limit using the data in hand by assuming the lowest efficiency resonators in each band for the second device (Figure 11 (bottom right)) are part of a loss-test pair for that band and the highest efficiency resonators have twice the efficiency of the loss-test pair’s reference detector. The loss-test devices were designed to match the $1/e$ length for a loss tangent of $\approx 10^{-3}$ and yield 10% loss for a loss tangent of $\approx 10^{-4}$. The inferred efficiency ratio is approximately $0.6 \approx \ln 0.5$ in all of B3, B4, and B5, so the loss tangent is at most 5×10^{-4} . From this, we estimate a lower limit on the transmission for the three-scale antenna of 0.93–0.94, approximately independent of frequency. This value is certainly good enough that it is subdominant to many other optical losses (§4.3.4). It is likely the constraints on δ will be improved by our ongoing measurements using the paired KIDs. If $\delta \approx 10^{-4}$ is obtained, comparable to the best achieved with a-Si:H⁹⁷ and a-SiC:H,⁹⁸ then the transmission would be approximately 0.985.

4.3.6 Direct Absorption Limits

A key feature of the device design is the many measures taken to limit direct absorption of trans-mm light by the KIDs (§4.1.2). We are able to place limits on this absorption by including in our optical efficiency analysis the dark KIDs. Their data are treated in the same way as those of the other KIDs, yielding an effective P_{opt} and dP_{opt}/dT_{load} that can be compared to those of the optically sensitive KIDs. (η_{opt} can be calculated too by assuming $\Delta\nu = 420 - 96 = 304$ GHz, the bandwidth between the metal mesh filter cutoff and $2\Delta_{Al}/h$, but P_{opt} and dP_{opt}/dT_{load} are more important for determining what fraction of the signal observed by a given detector arrives via the antenna vs. being directly coupled.)

Because it is physically allowed, to improve the fit quality, and to ensure we interpret any apparent response of the dark KIDs to varying optical load correctly, the model allows for the substrate to heat up due to broadband

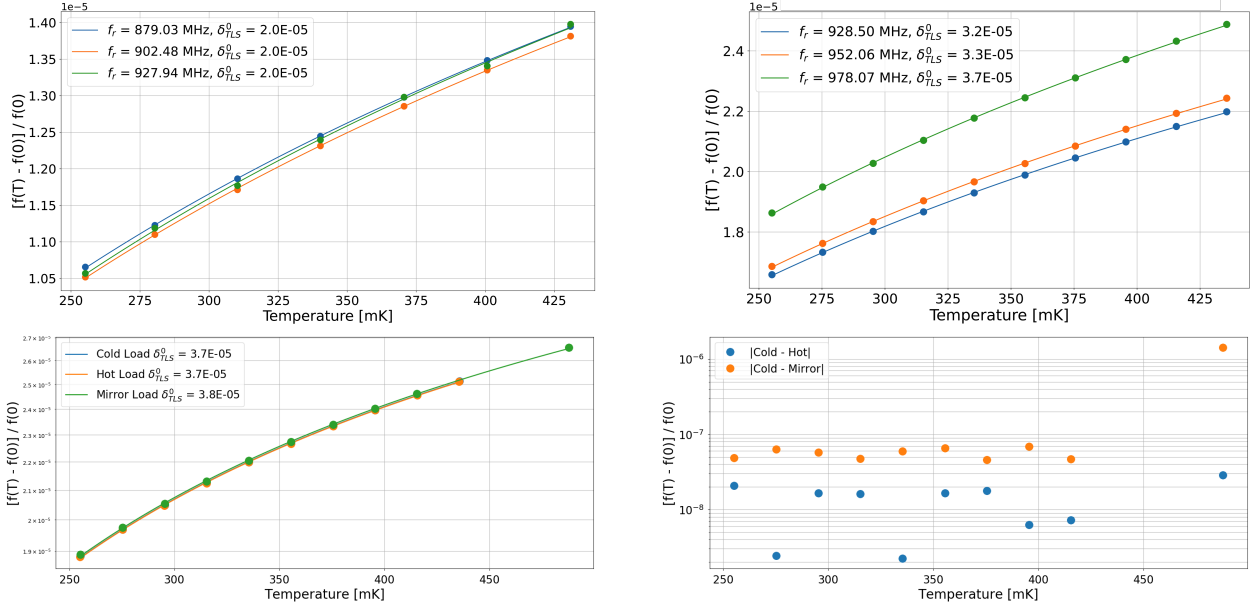

Figure 12. **RF TLS loss tangent and direct absorption limits.** (Top) Fractional frequency shift vs. T_{bath} for three observed Nb LC resonators on each of the two devices under study here. The low-power TLS RF loss tangent is given by the normalization of the fit. The loss tangents, 2 and 3.7×10^{-5} , are excellent compared to most amorphous dielectrics. The difference between the two is discussed in the text. (Bottom left) Fractional frequency shift vs. T_{bath} for the second device’s 978 MHz resonator under three optical loads. (Nb LC resonator data under optical load were not taken for the first device.) (Bottom right) Absolute difference in fractional frequency shift vs. T_{bath} between cold and hot and between cold and mirror optical loads for the same resonator. It is clear the difference is limited by systematics because the cold–mirror difference is larger in magnitude than the cold–hot difference and, in the plot at right, the ordering from bottom to top is hot, cold, mirror when it should be cold, mirror, hot if the differences were due to true changes in substrate temperature.

absorption in the silicon wafer itself. We use a standard conductance power law, $P = g(T_{substrate}^n - T_{bath}^n)$, where $T_{substrate}$ is the substrate temperature and we fit for g and n . The measurement of $\delta f_r/f_r$ under dark, cold, and hot loads as a function of T_{bath} breaks the degeneracy between optical efficiency and substrate heating. We find that the data prefer substrate heating, but the modeling is problematic. The preferred value is inconsistent among KIDs, even among the dark detectors, with values of up to $T_{substrate} - T_{bath} \approx 15$ mK at low T_{bath} for optical detectors but values of 60–70 mK for dark KIDs under the same conditions. We also find that the value depends far more on T_{bath} than on T_{load} , which is unphysical.

We can obtain a more useful constraint on $T_{substrate}$ using the a-Si:H RF loss tangent diagnostic resonators discussed in §4.3.5. The dependence of $\delta f_r/f_r$ on T_{bath} due to TLS can be used as a differential thermometer by seeing how much f_r changes between cold, mirror, and hot loads. Figure 12 shows those data. While the desired difference is clearly limited by systematics, we can infer a conservative upper limit of about 10^{-7} on $(f_r^{hot} - f_r^{cold})/f_r$, and we observed $d(\delta f_r/f_r)/dT_{bath} \approx 5 \times 10^{-8}/\text{mK}$ from the same data. We may therefore conclude the substrate changes in temperature by no more than about 2 mK between exposure to cold and hot loads. Thus, it is clear that the fitted deviation of $T_{substrate}$ from T_{bath} for the KIDs is indeed unphysical. We suspect the model’s preference for substrate heating reflects non-idealities in our Mattis-Bardeen modeling of $\delta f_r/f_r$ vs. T_{bath} for dark data.

Fortunately, the fitted $P_{opt}(T_{load})$ is not significantly affected by whether substrate heating is included or not, so we use these data to set an upper limit $P_{opt}^{dark}/P_{opt}^{opt} \lesssim 1\%$.

4.3.7 AlMn

We have recently demonstrated devices with the Al KID material replaced by AlMn and no other changes. The yield on these first arrays appears to be around 60%, a good starting point. Figure 13 shows $\delta f_r/f_r$ and Q_i vs.

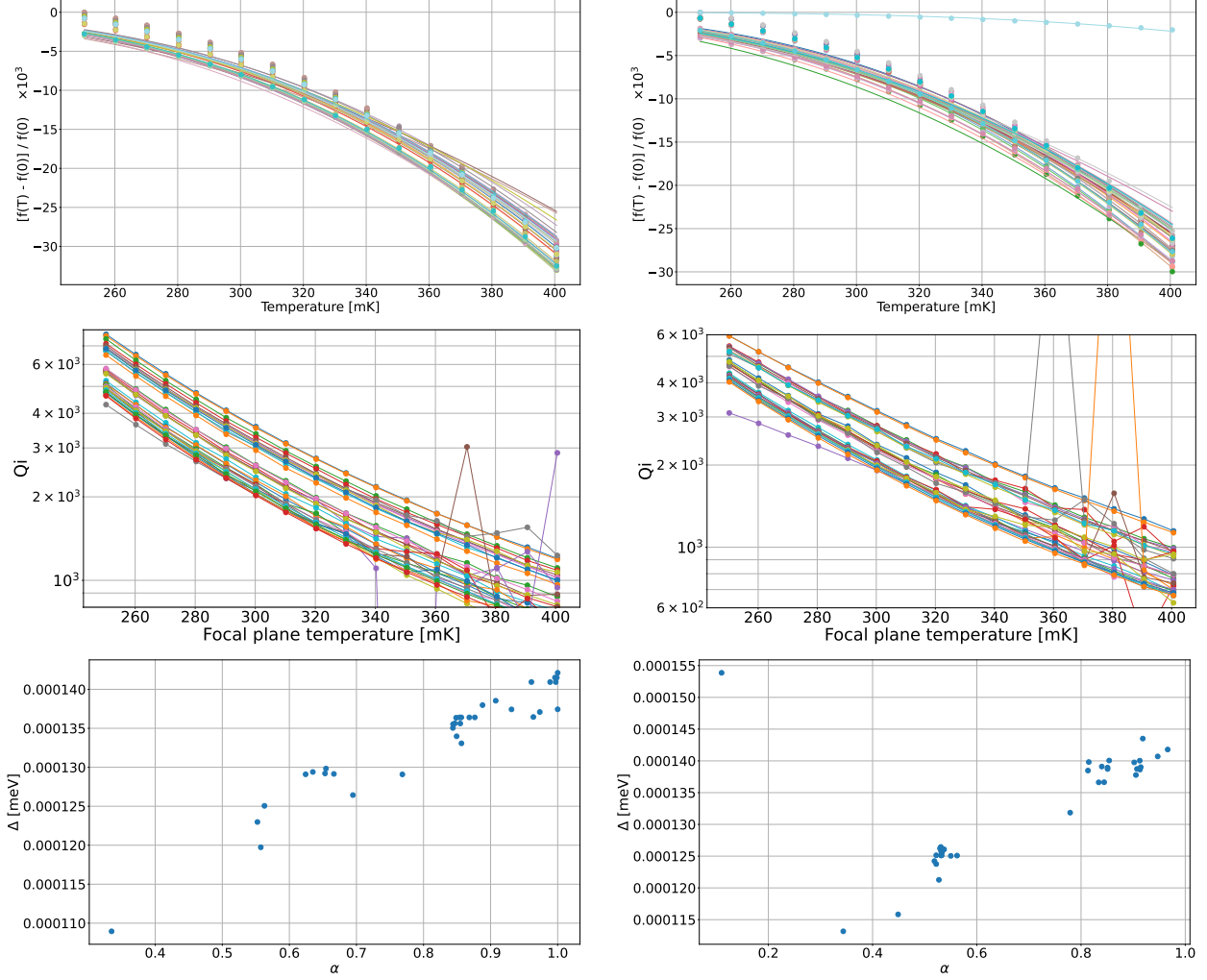

Figure 13. **AlMn KIDs** (Top and middle) $\delta f_r/f_r$ and Q_i vs. T_{bath} plots for two devices, from different wafers, replacing Al with AlMn. The data do not saturate at low T_{bath} due to the lower temperature limit of the apparatus being used. Low Q_r at high T_{bath} makes it difficult to fit the resonance loops, resulting in some unreliable Q_i values at high T_{bath} . (Bottom) Plot of α vs. Δ . A clear degeneracy is present due to the limited T_{bath} range. As discussed in the text, we can use the reduction of f_r between Al and AlMn to constrain α_{AlMn} and thus narrow the range for Δ_{AlMn} to 0.125–0.135 meV ($2\Delta_{AlMn}/h = 60$ –65 GHz).

T_{bath} over a limited range of T_{bath} . The low Q_i reflects the high value of T_{bath}/T_c and may make multiplexing and achieving fundamental-noise-limited performance challenging. That said, the large B1 pixels imply very few B1 resonators are needed for the three-scale architecture (see §3), and η_{pb} will be close to unity, so the low Q_i may be acceptable.

Because the data are not highly constraining, fits of $\delta f_r/f_r$ vs. T_{bath} to Mattis-Bardeen theory yield a significant α - Δ degeneracy, seen in Figure 13. We may narrow the range for Δ_{AlMn} by constraining α_{AlMn} using α_{Al} and the observed f_r ranges for Al and AlMn and the common resonator geometry: if f_g is the resonant frequency assuming only the geometrical inductance L_g and f_r is the resonant frequency including the kinetic inductance L_k , then

$$f_r = f_g \frac{\sqrt{L_g}}{\sqrt{L_g + L_k}} = f_g \sqrt{1 - \alpha} \quad \Rightarrow \quad \alpha_{AlMn} = 1 - (1 - \alpha_{Al}) \left(\frac{f_r^{AlMn}}{f_r^{Al}} \right)^2 \quad (1)$$

Figure 8 shows the f_r range for Al is 210–420 MHz (both devices) and the α_{Al} range is 0.25–0.40 (over both devices). The observed f_r ranges for the two AlMn devices are 136–265 MHz and 158–315 MHz. Combining these ranges yields $\alpha_{AlMn} = 0.58\text{--}0.75$, which narrows Δ_{AlMn} to 0.125–0.135 meV, or $2\Delta_{AlMn}/h = 60\text{--}65$ GHz. We will use index-test KIDs, which incorporate no BPFs, to explicitly measure $2\Delta_{AlMn}/h$.

To improve Q_i at the current T_{bath} , we could tune the AlMn T_c to obtain higher $\Delta_{AlMn} \approx 0.165$ meV ($2\Delta_{AlMn}/h \approx 80$ GHz). If Q_i remains inconveniently low, it may be possible to deposit AlMn only for the B1 resonators, suffering low Q_i for only $64/(2 \times 64 + 2 \times 256 + 2 \times 1024) = 2.3\%$ of the KIDs, by using coarse liftoff masks for Al and AlMn depositions: i.e., prepare a liftoff mask to only permit Al deposition in windows over the non-B1 resonators, deposit Al, remove the liftoff mask, prepare a second liftoff mask to only permit AlMn deposition in windows over the B1 resonators, deposit AlMn, and then proceed with the rest of the fabrication as before. There is no need for the Al and AlMn to be in galvanic contact with each other, so this two-step deposition process would be acceptable.

4.3.8 Noise and Sensitivity

4.3.8.1 Generation-Recombination-Dominated Detector Noise Figure 14 shows an example of the noise power spectral densities $S_{\delta f/f}$ and $S_{\delta(1/Q)}$ measured in a dark run at $T_{bath} = 310$ mK, a temperature at which the quasiparticle density is similar to what we expect under optical load at a telescope on the sky for the most demanding bands (B1–B3), $T_{load} \approx 30\text{--}40$ K (Table 2). We focus on the region above 100 Hz, where electronics $1/f$ noise is negligible. The noise in the frequency direction is far in excess of that in the dissipation direction but is flat from 100 Hz until it begins to roll off just above 1 kHz. The noise in the dissipation direction is approximately flat from 100 Hz to 100 kHz. (The slight dip seen below a few kHz is likely due to slight miscalibration of the frequency and dissipation directions. Correcting this miscalibration would have little effect on the frequency-direction noise given the logarithmic vertical scale.) The resonator ring-down bandwidth is indicated. We interpret the approximately white dissipation-direction noise as amplifier noise given that it maintains approximately the same level above the resonator bandwidth. We interpret the higher flat noise in the frequency direction as generation-recombination (GR) noise, rolling off with the quasiparticle lifetime ($f_{3dB} \approx 3.3$ kHz, $\tau_{qp} \approx 50$ μ s) and the resonator bandwidth ($f_{3dB} \approx 5$ kHz). The plot thus shows that, under dark conditions at $T_{bath} = 310$ mK, the device responsivity is large enough for GR noise to dominate over amplifier noise by about a factor of about 3, the square root of the ratio of the flat noise spectral densities in the frequency and dissipation directions.

The above conclusion that the noise seen in the frequency direction is GR noise is reinforced by the observation that, when plotted in $S_{N_{qp}}$ for various temperatures under dark conditions (Figure 14), the flat level is approximately independent of temperature. We would expect this behavior in the recombination-dominated limit, where $S_{N_{qp}}^{GR} = 4\tau_{qp}N_{qp} \approx 2V/R$ with V the inductor volume and R the recombination constant, while the rolloff frequency, given by $f_{3dB} = (2\pi\tau_{qp})^{-1}$, moves up with temperature as τ_{qp} decreases. With $V \approx 3500$ (μm)³ for this B3 detector and the flat noise level, we infer $R \approx 6.5\text{--}9.5$ (μm)³/sec, not too different from the canonical value for Al, $R = 10$ (μm)³/sec.

4.3.8.2 Photon-Noise-Dominated Performance Under Optical Load We have also measured the noise under optical load. We used 77 K and room-temperature (295 K) blackbody loads outside the dewar window as for the optical efficiency measurements, and we also put a reflective cover in front of the dewar window (“mirror”), which we calibrated to yield an effective outside-the-dewar optical load $T_{load} \approx 150$ K. The fits of the dark, cold, and hot load data also allow us to calibrate the excess loading from the dewar to be $T_{exc} \approx 150$ K in B3, which adds to the loads applied outside the dewar window. We show $S_{\delta f/f}$ under cold load ($T_{load} \approx 77$ K + $T_{exc} \approx 180$ K) in Figure 14. While the amplifier noise level in $S_{\delta f/f}$ increases substantially due to the decrease in $\partial V/\partial(\delta f_r/f_r) = 2Q_r^2/Q_c$ under increased optical loading, the frequency direction noise increases by about the same factor. We interpret this increase as due to the addition of photon noise, which we corroborate below via its dependence on T_{load} .

To more clearly establish that the increase in the flat noise level observed under optical load is indeed due to photon noise, it is particularly useful to plot $S_{N_{qp}}$ as a function of T_{load} because, in the recombination-dominated

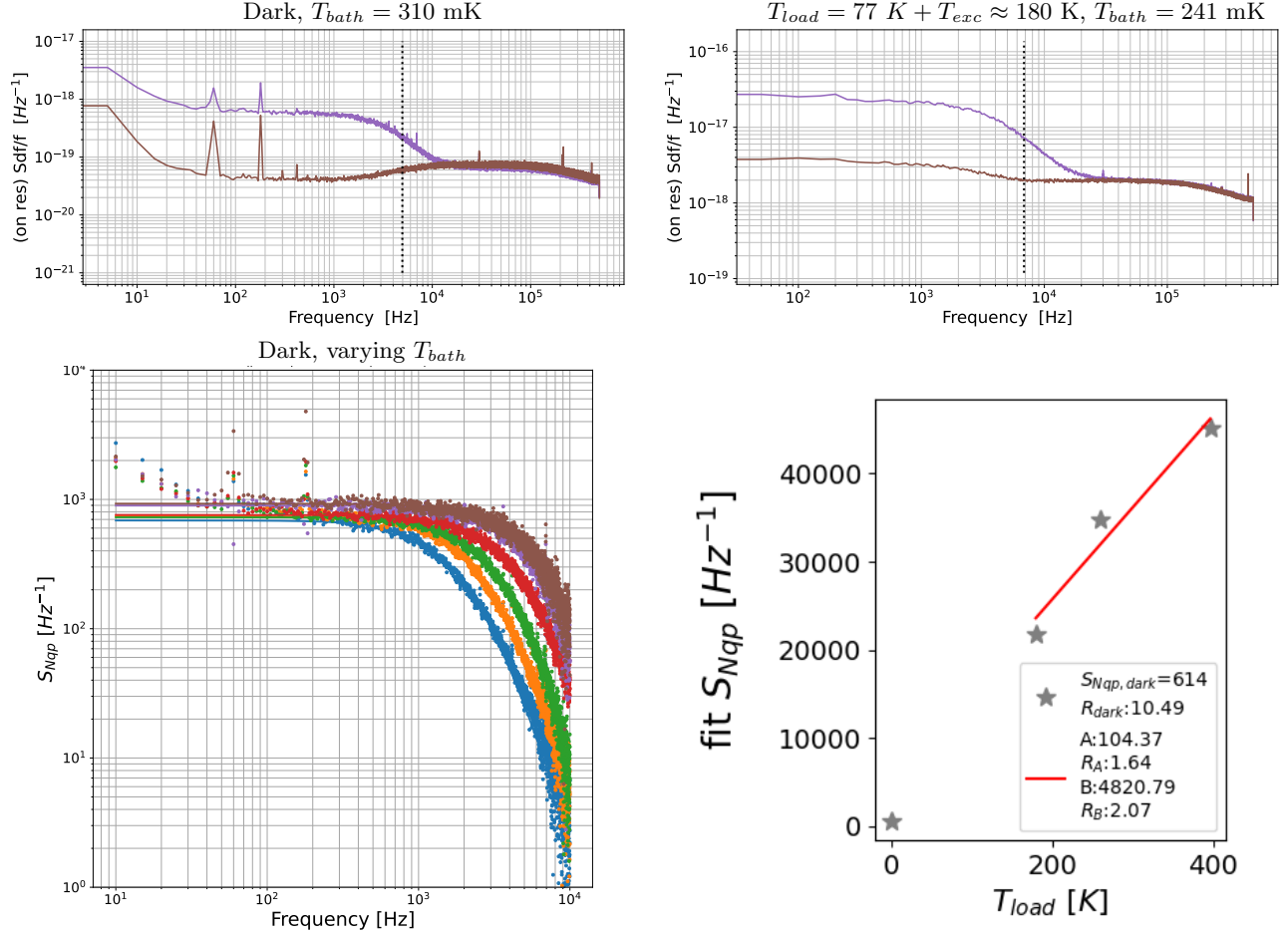

Figure 14. **Noise contributions** (Top) Fractional frequency noise power spectral density for one resonator under dark conditions at $T_{bath} = 310$ mK (left) and under a blackbody load $T_{load} = 77$ K + $T_{exc} \approx 180$ K at $T_{bath} = 241$ mK (right), both at a feedline power of -81 dBm. The noise in the frequency and dissipation directions are shown (both converted from voltage noise using the same $d(\delta f/f)/dV$, but which is different for the dark and optical data). The dashed vertical lines indicate the resonator bandwidth ($f_r/2Q_r$). The noise above 10 kHz is dominated by amplifier noise, while the noise at low frequency is likely dominated by electronics $1/f$ noise. See text for discussion. (Bottom left) Quasiparticle number noise power spectral density $S_{N_{qp}}$ (difference of on- and off resonance PSDs to subtract electronics white noise at high frequency) for the same resonator as a function of T_{bath} from 250 to 350 mK in steps of 20 mK in the sequence blue-orange-green-red-purple-brown. The flat noise level in $S_{N_{qp}}$ is approximately independent of temperature as would be expected for quasiparticle lifetime τ_{qp} limited by recombination, $S_{N_{qp}}^{GR} = 4 \tau_{qp} N_{qp} \approx 2V/R$, while the rolloff frequency moves up with temperature as $\tau_{qp}^{-1} \approx 2RN_{qp}/V$ increases. (Bottom right) $S_{N_{qp}}$ as a function of Rayleigh-Jeans optical load temperature. The optical load includes both the intended load applied outside the dewar and the excess loading from the dewar $T_{exc} = 103$ K inferred as described in the text. The behavior is consistent with Equation 2, with A and B being the slope and offset, indicating our detectors are GR or photon-noise dominated over this full range of optical loads. (The dark point at $T_{load} = 0$ is not included in the fit because it does not include the shot noise term.)

regime, it satisfies

$$S_{N_{qp}}^{tot} = S_{N_{qp}}^{GR} + S_{N_{qp}}^{shot} + S_{N_{qp}}^{Bose} = \frac{V}{R} \left[2 + \eta_{pb} \left(\frac{h\nu}{2\Delta} + \frac{\eta_{opt} k_B T_{load}}{2\Delta} \right) \right] \quad (2)$$

That is, we expect a simple linear dependence of $S_{N_{qp}}$ on T_{load} , with the intercept providing the sum of the GR and photon shot noise terms. (Beyond this simple behavior, another benefit of the $S_{N_{qp}}(T_{load})$ analysis is that it does

not depend on converting $S_{N_{qp}}$ to noise-equivalent power at the input to the KID, $\text{NEP}_{opt} = (\Delta/\eta_{pb}\tau_{qp})\sqrt{S_{N_{qp}}}$, which relies on theoretical calculations for η_{pb} and may suffer systematic uncertainties if τ_{qp} cannot be measured well, such as when it is too similar to the resonator ring-down time constant (as is seen in Figure 14.) Figure 14 shows the expected linear dependence, demonstrating that the additional noise observed under optical load is indeed photon noise.

We can determine from the $S_{N_{qp}}$ vs. T_{load} plot, by empirical extrapolation rather than calculation, the expected $S_{N_{qp}}$ under the expected optical load on sky at a telescope and the relative contributions of GR, shot, and Bose noise. For the B3 detector shown, we expect $T_{load} = 40$ K on sky, yielding an expected total noise of $S_{N_{qp}} \approx 9000/\text{Hz}$. Given $S_{N_{qp}} \approx 750/\text{Hz}$ measured under dark conditions, it would appear the photon noise is well in excess of the GR noise. However, a detailed comparison reveals the dark and optical data do not yield a consistent recombination constant. Using $\eta_{pb} = 0.49$ as discussed earlier, estimated values of $\nu = 225$ GHz (B3) and $2\Delta_{Al} = 96$ GHz, $V = 3500$ (μm)³, and $R = 8$ (μm)³/sec, we find the shot noise term should be 60% of the GR noise term, or about 450/Hz. The fit yields an offset, corresponding to the sum of the GR and shot noise terms, of $\approx 4800/\text{Hz}$, about four times larger than the expected $750 + 450 = 1200/\text{Hz}$. Similarly, using $\eta_{opt} = 0.5$ (§4.3.4), we find $\eta_{opt}k_B/2\Delta_{Al} \approx 0.11$ and thus the slope should be $23/(\text{K Hz})$ while the fit yields a slope of $104/(\text{K Hz})$, 4.5 times larger than expected. We can only reconcile the dark and optical data by positing that somehow R is reduced when trans-mm-generated quasiparticles are present, a hypothesis we will return to momentarily. Assuming $R = 1.8\text{--}2$ (μm)³/sec is more appropriate for optical data, then we infer $S_{N_{qp}}^{GR} \approx 3000\text{--}3400/\text{Hz}$, $S_{N_{qp}}^{shot} \approx 1800\text{--}2000/\text{Hz}$, and $S_{N_{qp}}^{Bose}(T_{load} = 40 \text{ K}) \approx 3500\text{--}4000/\text{Hz}$. The result is that the GR noise is about 60% of the photon noise and about 1/3 of the total noise — our detectors will be quite close to photon-noise-limited at expected optical loads.

As to how R can decrease under optical load, one hypothesis would be that: 1) the phonons arising from pair recombination of trans-mm-generated quasiparticles have a distinctly different spectrum than the Wien tail of thermal phonons that thermally generate quasiparticles; and, (2) this different spectrum may be more easily trapped by acoustic mismatch in the Al KID film than thermal phonons. It is known that the recombination constant and quasiparticle lifetime measured in a purely thermal environment for thin films already reflect some level of phonon trapping — lifetimes calculated from BCS theory⁹⁹ are much faster than those observed — so we hypothesize that our data can be explained by an enhancement of this effect. The effect may have been enhanced by the 800 nm a-Si:H layer between the KID film and the substrate. With more exhaustive data over all the frequency bands, we can test for a systematic dependence of R on ν , which would impact the trans-mm-generated phonon spectrum and which varies by a factor of 2.5 over B2–B5.

While we have already demonstrated performance limited by GR+photon noise, it is useful to convert to noise-equivalent power, NEP_{opt} ($\text{W Hz}^{-1/2}$), because it is the standard performance metric for detectors of this type. Under the expected on-sky optical loads from Table 2, the photon-noise-limited sensitivity, NEP_{opt}^γ , varies from 6.4 to 16×10^{-17} $\text{W Hz}^{-1/2}$ for B2–B6. (B1 requires AlMn, which will have different $S_{N_{qp}}$.) If we map from the expected τ_{qp} under optical load (≈ 30 μs) to the T_{bath} with matching τ_{qp} , then $T_{bath} = 310$ mK and we see that $\text{NEP}_{opt}^{GR} \leq \text{NEP}_{opt}^\gamma$. The margin is not as great as the one from the empirical extrapolation above because it fails to account for the decrease in R observed under optical load. Both $S_{N_{qp}}$ and τ_{qp} are inversely proportional to R , so $\text{NEP}_{opt}^{GR} \propto \sqrt{R}$, decreasing as R decreases. The factor of 4 reduction in R between dark and optical data implies a factor of $\sqrt{4} = 2$ in NEP_{opt}^{GR} , implying $\text{NEP}_{opt}^{GR} \leq \text{NEP}_{opt}^\gamma/2$ and ensuring photon noise is dominant.

4.3.8.3 TLS Noise Electronics $1/f$ noise currently makes it difficult to measure the noise below 100 Hz, but we may estimate the expected TLS noise level using existing measurements,⁷⁴ which yield $S_{\delta f/f}^{TLS} = 0.8, 0.4,$ and $0.25 \times 10^{-18}/\text{Hz}$ at 10, 100, and 1000 Hz, an electric field of 130 V/m, at $T_{bath} = 250$ mK, and for a capacitor area $A_C = 0.3$ (mm)² (single top plate). (We do not correct the TLS noise for its $T^{-1.7}$ temperature dependence⁷⁵ because the capacitor dielectric would be at $T_{bath} = 250$ mK even if the quasiparticle density under load is comparable to what is seen thermally at $T_{bath} = 330$ mK.) Comparing to the dark data in Figure 14 (upper left), we scale to the expected B3 KID capacitor area $A_C = 0.55$ (mm)² and the electric field $E = 1430$ V/m at the applied feedline power of -81 dBm to obtain $S_{\delta f/f}^{TLS} = 3.9, 2.0,$ and $1.2 \times 10^{-20}/\text{Hz}$ at 10, 100, and 1000 Hz, below

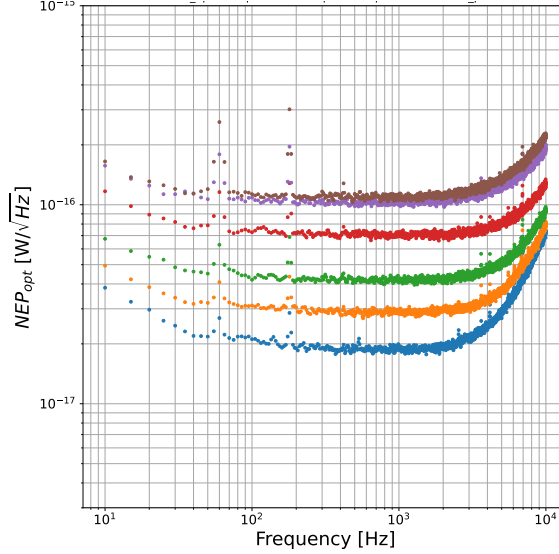

Figure 15. **Sensitivity** $NEP_{opt}^{GR} = (\Delta/\eta_{pb}\tau_{qp})\sqrt{S_{N_{qp}}}$ using $S_{N_{qp}}$ from dark data (Figure 14 (bottom left)) as a function of T_{bath} assuming $\eta_{pb} = 0.5$, same legend as Figure 14 (bottom left). See discussion in text for comparison to expected photon noise; it is not trivial given the apparent reduction of R under optical load.

the amplifier noise and well below the GR noise. Comparing to the cold load data in Figure 14 (upper right), the same feedline power now yields $E = 990$ V/m because of the reduced Q_i under load. The TLS noise scales to $S_{\delta f/f}^{TLS} = 5.6, 2.8,$ and $1.8 \times 10^{-20}/\text{Hz}$ at 10, 100, and 1000 Hz, slightly higher but now even further below the amplifier noise and photon noise because the latter have increased substantially in $S_{\delta f/f}$ units while the TLS noise has not. Extrapolating to lower frequencies more relevant for astronomical observations, assuming a conservative $S_{\delta f/f} \propto 1/f$ scaling, yields $S_{\delta f/f}^{TLS} = 3.9\text{--}5.6 \times 10^{-19}/\text{Hz}$ at 1 Hz and $3.9\text{--}5.6 \times 10^{-18}/\text{Hz}$ at 0.1 Hz. Since the amplifier and fundamental (GR+photon) noise under sky loading will likely be somewhere between the dark and cold load noise $S_{\delta f/f}$ PSDs from Figure 14, TLS noise will likely be subdominant to amplifier noise and certainly well below fundamental noise. Actual measurements of TLS noise under optical load close to expectations will likely motivate reducing the capacitor area to reduce focal plane dead area.

4.4 Supporting Subsystems

NEW-MUSIC builds on the heritage of the MUSIC instrument,^{59,100} and we will reuse much of MUSIC for NEW-MUSIC. We review the extant MUSIC sub-systems and describe the necessary modifications.

Cryostat The MUSIC cryostat¹⁰¹ consists of a 1.5 m tall, 0.6 m diameter dewar with two internal stages cooled by a Cryomech PT-415 pulse-tube cooler, providing 40 W at 50 K and 1.35 W at 4 K. A Chase Cryogenics $^4\text{He}/^3\text{He}/^3\text{He}$ closed-cycle sorption cooler provides 3 μW at 240 mK and 100 μW at 350 mK, sufficient to accommodate conductive and radiative heat loads while providing well in excess of 24 hrs hold time after a 6 hr cycle. It incorporates a two-layer A4K shield at 4 K to provide magnetic shielding against Earth’s field, which varies with time as the telescope moves. The cryostat originally included eight 2-8 GHz HEMT amplifiers, which will be replaced as needed with SiGe amplifiers that provide excellent performance below 2 GHz. The cryostat is already equipped with the necessary RF coaxes as well as DC wiring for thermometry.

Optical Train The MUSIC optical train consists of one powered mirror and two flat mirrors at 300 K followed by a cold Lyot stop and cold lens at 4 K; see Figure 16. The original cold optics reimaged the $f/12.6$ Cassegrain focus of the CSO to $f/3.45$ with a 15’ diameter (135 mm) field-of-view and a flat focal surface using a single-layer Porex-coated HDPE lens. A second version of the cold optics instead reimaged to $f/2.19$, making the field-of-view 85 mm in diameter. We will revise the 4 K lens slightly to provide a focal ratio of $f/1.72$ to match

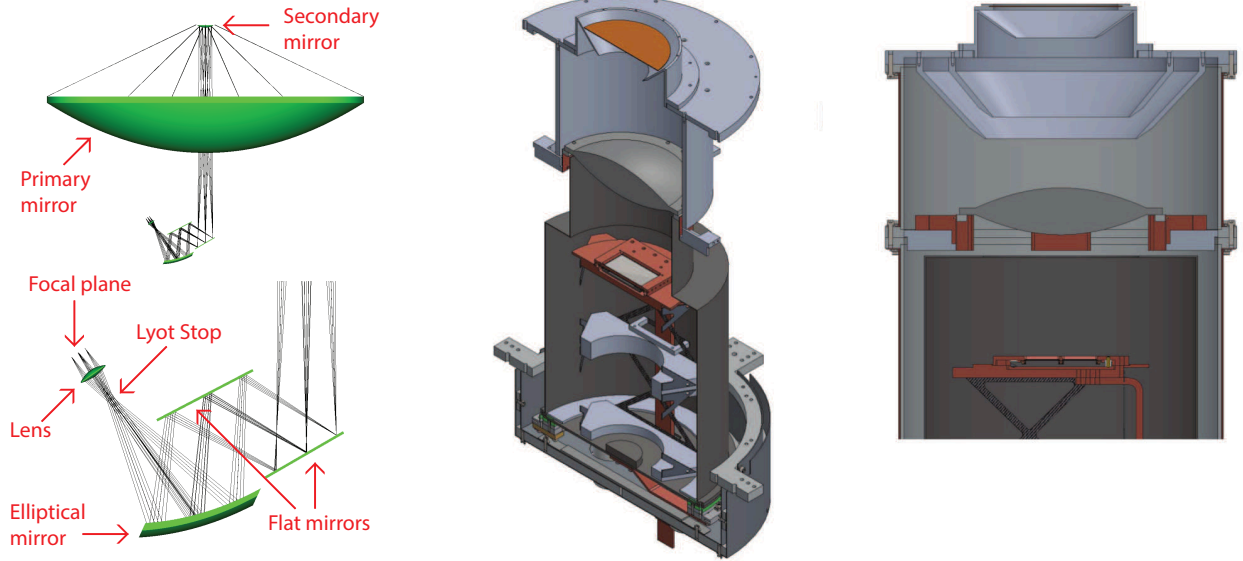

Figure 16. **MUSIC optical design.** (Top left) Full optical model including primary and secondary mirrors of Leighton Telescope. (Bottom left) Close-up on relay optics include two folding flats, one 300 K ellipsoid, a cold lens, and the focal surface. The Cassegrain focus is visible just above the first fold mirror. (Center) CAD model of internal optics at 4 K (including Lyot stop and lens) and focal plane location for $f/2.19$ configuration. Some baffles are removed. (Right) CAD model showing all 4 K baffles for $f/2.19$ configuration. The Lyot stop is at the bottom of the top conical baffle.

our antenna pixels, making the 14' field-of-view roughly 60 mm across. We will also AR-coat the lens with two layers of Porex to provide broader bandwidth. Ongoing development work on broadband AR-structured metamaterial silicon gradient-index lenses⁹⁵ may be implemented later to enhance optical efficiency. At the focal plane, NEW-MUSIC will use a proven three-layer silicon AR structure,^{94,95} or an in-development four-layer AR.

In terms of windows and filtering, the existing MUSIC design is quite similar to the one used for the work presented here, with the differences being that MUSIC used a HDPE rather than UHMWPE window, metal-mesh 14 THz and 3.75 THz low-pass blackbody filters instead of Zotefoam sheets to limit 300 K radiation incident on 50 K, and PTFE instead of Nylon at 4 K. As noted earlier, we plan to revisit this stack to increase its efficiency without degrading the optical load on 4 K or the sub-Kelvin cooler.

The $f/2.19$ optical train incorporated significant baffling near the Lyot stop, which ensures that, in a time-reversed sense, rays emitted by the focal plane have many opportunities to intersect cold, absorbing surfaces before exiting the cryostat. See Figure 16. The absorber used was “steelcast”.¹⁰² Without these baffles, rays that reflect off the Lyot stop can reflect off the focal plane and exit through the optical path. In spite of this baffling, MUSIC suffered a significant ($\sim 50\%$) loss of beam to wide angles,¹⁰³ suggesting the baffling was not completely effective in absorbing wide-angle beam. We will incorporate more sophisticated absorber materials that have been developed in recent years,^{104–107} and we plan an extensive baffling test campaign.

KID Readout and Data Acquisition Our initial deployment plan (for a quarter-scale focal plane; see §5) is to reuse the MUSIC readout but without the the up/down-converting IF system. Each MUSIC readout module¹⁰⁸ consists of three boards: a ROACH-1 board¹⁰⁹ providing a Virtex5 FPGA, a PowerPC for a simple linux operating system, and an ethernet transceiver; an ADC/DAC board with two pairs of TI DAC5618 1000 MHz 16-bit DACs and TI ADS5463 500-MHz 12-bit ADCs, which we operate at 491.52 MHz; and, an “IF” (intermediate frequency) board that provides 300 K amplification, a variable attenuator, IQ mixers, baseband amplification, and anti-alias filtering. The board set accepts signals from a Rb frequency standard locked to GPS to provide a stable frequency reference (10 MHz) for generation of the CPU and ADC/DAC clocks and for absolute time synchronization (1 Hz). Each module has firmware^{110,111} that handles 192 readout tones across 450 MHz of usable bandwidth, using a 2^{16} -sample FFT to output data at 7.5 kHz for each tone. On-board

filtering and decimation reduce the data rate to 100 Hz, matching the telescope pointing stream, for transport off the board. The entire planned MUSIC focal plane required 16 boards: 144 KIDs per board with 48 monitor tones for removal of low-frequency gain and phase noise. The boards were housed in two fan-cooled electronics crates that mount on the telescope near the cryostat. The vented air is ducted away from the telescope. DC power supplies sat in the CSO dome, away from the telescope.

The 100-400 MHz readout band motivates replacing the MUSIC IQ mixer (“IF”) board with a much simpler one that eliminates the IQ mixers and uses diplexers at the Nyquist frequency to separately populate the first and second Nyquist zones of different ADC/DAC pairs. It would still include additional gain, variable attenuation, and anti-alias filtering. The new boards will be compatible with the MUSIC FPGA command interface to obviate firmware changes.

RF system-on-chip (RFSoc) implementations for KID readout are making fast progress,^{112–115} so we anticipate switching to such a system for a full NEW-MUSIC focal plane.

Data Acquisition MUSIC used an industrial server running Linux from internal SSDs with a hard-drive RAID for data. CASPER¹⁰⁹ provided python tools for communicating with the ROACHs, which we used wholesale. We wrote our own Matlab-based data acquisition software to accept the streams of data from the 16 ROACHs, combine it with pointing and slow monitoring data, and package it into the HDF5 format. Initially, we plan to port this existing DAQ to modern computing hardware and a Python platform and use SSDs for storage as well as the operating system. When we switch to a RFSoc system, we may adapt DAQ software built for such systems and only replace the low-level DAQ-KID readout drivers.

Data Reduction An IDL-based pipeline was used for reduction of MUSIC data for extensive instrument characterization^{59,100,103,116} and science publications.^{117,118} This pipeline was an extension of the pipeline developed for Bolocam, which was the mm-wave facility camera on the CSO for over a decade and resulted in tens of publications. We will either port this code base to Python or adopt data reduction packages developed over the past decade for KID-based instruments (e.g., `citlali`¹¹⁹ for TolTEC).

4.5 Sensitivity and Mapping Speed

Given uncertainties on the recombination constant R , we take a semi-empirical approach to calculating the expected sensitivity and mapping speed of NEW-MUSIC, making heavy use of Equation 2 and the measurements in §4.3.8.2. We calculate $S_{N_{qp}}^{GR}$ from $V = 3500 (\mu\text{m})^3$ and the empirical noise-based value of $R = 1.9 (\mu\text{m})^3/\text{sec}$ from §4.3.8.2. We calculate $S_{N_{qp}}^{shot}$ using the same V and R as for $S_{N_{qp}}^{GR}$ along with $\Delta_{AlMn} = 165 \mu\text{eV}$ for B1 (§4.3.7) and $\Delta_{Al} = 200 \mu\text{eV}$ (Figure 8) for the other bands along with η_{pb} from¹²⁰ (listed in Table 4; we take $\eta_{pb} = 1$ for B1 because $h\nu \approx 2\Delta_{AlMn}$). For $S_{N_{qp}}^{Bose}$, we start with the measurement of the $S_{N_{qp}}^{Bose}(T_{load})$ slope in Equation 2 shown in Figure 14. Because of the η_{opt} factor in that term, we correct it by the ratio between the optical efficiency expected for NEW-MUSIC (which accounts for the Lyot stop) and the optical efficiency we measure here (the average of the two devices’ “max” values of η_{opt}^{design} , with the use of the maximum motivated as in §4.3.4). We then multiply by T_{load} given in Table 2. We convert these three $S_{N_{qp}}$ values to noise-equivalent power (NEPs) using another recombination-limit relation:

$$\frac{dP_{opt}}{dN_{qp}} = \sqrt{\frac{\Delta P_{opt} R}{\eta_{pb} V}} \quad (3)$$

This approach is mathematically equivalent to calculating N_{qp} from P_{opt} , R , V , and Δ using the GR equation, calculating τ_{qp} from N_{qp} , R , and V , and using $dP_{opt}/dN_{qp} = \Delta/\eta_{pb}\tau_{qp}$, but it obviates the intermediate result for τ_{qp} and makes it clear how the derivative depends on input parameters. We calculate P_{opt} for the expected T_{load} and assuming $\Delta\nu$ from Table 2 and η_{opt} for the instrument as given in Table 4. Consistent with expectations from §4.3.8.2, Table 4 shows this semi-empirical model indicates NEW-MUSIC will be quite close to photon-noise-limited.

	B1	B2	B3	B4	B5	B6
η_{opt} w/Lyot stop	0.26	0.40	0.34	0.38	0.26	0.29
η_{pb}	1	0.64	0.49	0.45	0.41	0.41
P_{opt} w/Lyot stop [pW]	4.1	8.7	8.4	9.8	12	18
Δ [μ eV]	165	200	200	200	200	200
$S_{N_{qp}}^{GR}$ [/Hz]	3700					
$S_{N_{qp}}^{shot}$ [/Hz]	2100	1800	2200	2500	2700	3200
$S_{N_{qp}}^{Bose}$ [/Hz]	3000	3100	2800	3800	8500	12600
dP_{opt}/dN_{qp} [pW]	0.48	0.97	1.09	1.23	1.45	1.74
NEP _{GR} [aW/ \sqrt Hz]	29	59	67	75	88	106
NEP _{photon} [aW/ \sqrt Hz]	35	68	77	98	153	219
NEP _{tot} [aW/ \sqrt Hz]	45	90	102	123	176	244
NEP _{tot} /NEP _{photon}	1.31	1.32	1.32	1.26	1.15	1.11
NEFD [mJy \sqrt sec]	13	16	20	22	69	115
Mapping Speed [arcmin ² /mJy/hr]	2500	810	730	500	100	26

Table 4. **NEW-MUSIC expected sensitivity and mapping speed under best-case conditions.** The sensitivity is estimated using the semi-empirical approach discussed in the text using the “best-case conditions” optical loads provided in Table 2. Amplifier and TLS noise are not listed in the noise budget because Figure 14 shows they are highly subdominant. The ratio NEP_{tot}/NEP_{photon} shows that the degradation relative to fully photon-noise-limited performance will be small. The mapping speeds provided are for the full pixel-count focal plane, while the NEPs and NEFDs are independent of the FPU size. We assume AlMn KIDs for B1 and Al KIDs for the other bands (see §4.3.7).

Table 4 also shows calculations of noise-equivalent flux density (NEFD) and mapping speed ($N_{pix}\Omega_{beam}/\text{NEFD}^2$). We calculate NEFD from NEP_{tot} using the 10.4 m diameter of the Leighton Telescope along with a degradation factor to account for primary illumination, including the effect of the Lyot stop. We then calculate mapping speed from the NEFD, N_{pix} , and $\Omega_{beam} = \text{FWHM}^2 \pi / (4 \ln 2)$ (N_{pix} and FWHM from Table 2).

5. CONCLUSION AND FUTURE PLANS

We have motivated, described, and provided significant technology validation for the Next-generation, Extended Wavelength, MUlti-band Sub/mm Inductance Camera, NEW-MUSIC, a six-band, polarization-sensitive, trans-mm camera for the 10.4 m Leighton Chajnantor Telescope. NEW-MUSIC will provide SEDs from 80 to 420 GHz for: a variety of time-domain sources to probe new frontiers in energy, density, time, and magnetic field: the Sunyaev-Zeldovich effects in galaxies and galaxy clusters to study accretion, feedback, and dust content in their hot gaseous haloes; and to provide new insights into stellar and planetary nurseries via dust thermal emission and polarization.

Hierarchical summing of our slot-dipole, phased-array antennas works as expected and that microstripline loss is acceptable. We have demonstrated reasonable spectral bandpasses and competitive optical efficiency in four of NEW-MUSIC’s six bands, including validation of NEW-MUSIC’s groundbreaking microstripline-coupled, parallel-plate-capacitor, lumped-element KIDs. The detectors’ generation-recombination noise dominates over amplifier and two-level-system noise above 100 Hz, and scaling predictions indicate this performance should continue to hold down to 0.1 Hz. The NEW-MUSIC detectors are demonstrably photon-background-limited. Direct absorption is at the $\lesssim 1\%$ level. We have fabricated and observed reasonable first-try yield for AlMn KIDs necessary for B1.

In the near term, we expect to provide the following key remaining demonstrations: beams for the three-scale antenna; similar sensitivity down to the 0.1–1 Hz audio frequencies necessary for astronomical scanning observations; AlMn KIDs with photon-background-limited sensitivity for B1; improved optical efficiency and spectral bandpasses; explicit measurements of loss and wave-speed for our a-Si:H microstripline; and, resonator yield and collision statistics. These results will enable the final design of NEW-MUSIC. Funding-permitting, NEW-MUSIC will deploy with a quarter-scale focal plane on LCT in 2027, with a focus on time-domain sources

and object-oriented science. On-sky validation will motivate construction of the full focal-plane and readout system to enable wide-area surveys.

ACKNOWLEDGMENTS

This work has been supported by the JPL Research and Technology Development Fund, the National Aeronautics and Space Administration under awards 80NSSC18K0385 and 80NSSC22K1556, the Department of Energy Office of High-Energy Physics Advanced Detector Research program under award DE-SC0018126, and the Wilf Foundation. The research was carried out in part at the Jet Propulsion Laboratory, California Institute of Technology, under a contract with the National Aeronautics and Space Administration (80NM0018D0004). The authors acknowledge the work of numerous former students and collaborators in the development of the technologies presented here and thank Liam Connor, Anna Ho, Mansi Kasliwal, Shri Kulkarni, Sterl Phinney, and Vikram Ravi for development of the time-domain astronomy science targets.

REFERENCES

- [1] Perley, D. A., Fremling, C., Sollerman, J., Miller, A. A., Dahiwal, A. S., Sharma, Y., Bellm, E. C., Biswas, R., Brink, T. G., Bruch, R. J., De, K., Dekany, R., Drake, A. J., Duev, D. A., Filippenko, A. V., Gal-Yam, A., Goobar, A., Graham, M. J., Graham, M. L., Ho, A. Y. Q., Irani, I., Kasliwal, M. M., Kim, Y.-L., Kulkarni, S. R., Mahabal, A., Masci, F. J., Modak, S., Neill, J. D., Nordin, J., Riddle, R. L., Soumagnac, M. T., Strotjohann, N. L., Schulze, S., Taggart, K., Tzanidakis, A., Walters, R. S., and Yan, L., “The Zwicky Transient Facility Bright Transient Survey. II. A Public Statistical Sample for Exploring Supernova Demographics,” *Astrophysical Journal* **904**(1), 35/1–24 (2020).
- [2] Eftekhari, T., Berger, E., Metzger, B. D., Laskar, T., Villar, V. A., Alexander, K. D., Holder, G. P., Vieira, J. D., Whitehorn, N., and Williams, P. K. G., “Extragalactic Millimeter Transients in the Era of Next-generation CMB Surveys,” *Astrophysical Journal* **935**(1), 16/1–19 (2022).
- [3] Liu, J.-F., Liu, L.-D., Yu, Y.-W., and Zhu, J.-P., “A Population Study of the Radio Emission of Fast Blue Optical Transients,” *Astrophysical Journal* **946**, 35/1–7 (2023).
- [4] Zauderer, B. A., Berger, E., Soderberg, A. M., Loeb, A., Narayan, R., Frail, D. A., Petitpas, G. R., Brunthaler, A., Chornock, R., Carpenter, J. M., Pooley, G. G., Mooley, K., Kulkarni, S. R., Margutti, R., Fox, D. B., Nakar, E., Patel, N. A., Volgenau, N. H., Culverhouse, T. L., Bietenholz, M. F., Rupen, M. P., Max-Moerbeck, W., Readhead, A. C. S., Richards, J., Shepherd, M., Storm, S., and Hull, C. L. H., “Birth of a relativistic outflow in the unusual γ -ray transient Swift J164449.3+573451,” *Nature* **476**, 425–428 (2011).
- [5] Laskar, T., van Eerten, H., Schady, P., Mundell, C. G., Alexander, K. D., Barniol Duran, R., Berger, E., Bolmer, J., Chornock, R., Coppejans, D. L., Fong, W.-f., Gomboc, A., Jordana-Mitjans, N., Kobayashi, S., Margutti, R., Menten, K. M., Sari, R., Yamazaki, R., Lipunov, V. M., Gorbovskey, E., Kornilov, V. G., Tyurina, N., Zimmukhov, D., Podesta, R., Levato, H., Buckley, D. A. H., Tlatov, A., Rebolo, R., and Serra-Ricart, M., “A Reverse Shock in GRB 181201A,” *Astrophysical Journal* **884**, 121/1–17 (2019).
- [6] Nakar, E., “A Unified Picture for Low-luminosity and Long Gamma-Ray Bursts Based on the Extended Progenitor of 11GRB 060218/SN 2006aj,” *Astrophysical Journal* **807**, 172/1–8 (2015).
- [7] Rhodes, L., Bright, J. S., Fender, R., Sfaradi, I., Green, D. A., Horesh, A., Mooley, K., Pasham, D., Smartt, S., Titterton, D. J., van der Horst, A. J., and Williams, D. R. A., “Day-time-scale variability in the radio light curve of the Tidal Disruption Event AT2022cmc: confirmation of a highly relativistic outflow,” *Monthly Notices of the Royal Astronomical Society* **521**, 389–395 (2023).
- [8] Tetarenko, A. J., Casella, P., Miller-Jones, J. C. A., Sivakoff, G. R., Paice, J. A., Vincentelli, F. M., Maccarone, T. J., Gandhi, P., Dhillon, V. S., Marsh, T. R., Russell, T. D., and Uttley, P., “Measuring fundamental jet properties with multiwavelength fast timing of the black hole X-ray binary MAXI J1820+070,” *Monthly Notices of the Royal Astronomical Society* **504**, 3862–3883 (2021).
- [9] Finzell, T., Chomiuk, L., Metzger, B. D., Walter, F. M., Linford, J. D., Mukai, K., Nelson, T., Weston, J. H. S., Zheng, Y., Sokoloski, J. L., Mioduszewski, A., Rupen, M. P., Dong, S., Starrfield, S., Cheung, C. C., Woodward, C. E., Taylor, G. B., Bohlsen, T., Buil, C., Prieto, J., Wagner, R. M., Bensby, T., Bond, I. A., Sumi, T., Bennett, D. P., Abe, F., Koshimoto, N., Suzuki, D., Tristram, P. J., Christie, G. W., Natusch,

- T., McCormick, J., Yee, J., and Gould, A., “A Detailed Observational Analysis of V1324 Sco, the Most Gamma-Ray-luminous Classical Nova to Date,” *Astrophysical Journal* **852**, 108/1–23 (2018).
- [10] Chomiuk, L., Metzger, B. D., and Shen, K. J., “New Insights into Classical Novae,” *Annual Reviews of Astronomy and Astrophysics* **59**, 391–444 (2021).
- [11] Torne, P., Bell, G. S., Bintley, D., Desvignes, G., Berry, D., Dempsey, J. T., Ho, P. T. P., Parsons, H., Eatough, R. P., Karuppusamy, R., Kramer, M., Kramer, C., Liu, K., Paubert, G., Sanchez-Portal, M., and Schuster, K. F., “Submillimeter Pulsations from the Magnetar XTE J1810-197,” *Astrophysical Journal* **925**, L17/1–10 (2022).
- [12] Fischer, W. J., Hillenbrand, L. A., Herczeg, G. J., Johnstone, D., Kospal, A., and Dunham, M. M., “Accretion Variability as a Guide to Stellar Mass Assembly,” in [*Protostars and Planets VII*], Inutsuka, S., Aikawa, Y., Muto, T., Tomida, K., and Tamura, M., eds., *Astronomical Society of the Pacific Conference Series* **534**, 355–376, Astronomical Society of the Pacific, San Francisco, CA (2023).
- [13] Johnstone, D., Hendricks, B., Herczeg, G. J., and Bruderer, S., “Continuum Variability of Deeply Embedded Protostars as a Probe of Envelope Structure,” *Astrophysical Journal* **765**, 133/1–10 (2013).
- [14] Baek, G., MacFarlane, B. A., Lee, J.-E., Stamatellos, D., Herczeg, G., Johnstone, D., Peña, C. C., Varricatt, W., Hodapp, K. W., Chen, H.-R. V., and Kang, S.-J., “Radiative Transfer Modeling of EC 53: An Episodically Accreting Class I Young Stellar Object,” *Astrophysical Journal* **895**, 27/1–13 (2020).
- [15] Johnstone, D., Herczeg, G. J., Mairs, S., Hatchell, J., Bower, G. C., Kirk, H., Lane, J., Bell, G. S., Graves, S., Aikawa, Y., Chen, H.-R. V., Chen, W.-P., Kang, M., Kang, S.-J., Lee, J.-E., Morata, O., Pon, A., Scicluna, P., Scholz, A., Takahashi, S., Yoo, H., and JCMT Transient Team, “The JCMT Transient Survey: Stochastic and Secular Variability of Protostars and Disks In the Submillimeter Region Observed over 18 Months,” *Astrophysical Journal*, 31/1–21 (2018).
- [16] Lee, Y.-H., Johnstone, D., Lee, J.-E., Herczeg, G., Mairs, S., Contreras-Peña, C., Hatchell, J., Naylor, T., Bell, G. S., Bourke, T. L., Broughton, C., Francis, L., Gupta, A., Harsono, D., Liu, S.-Y., Park, G., Plovie, S., Moriarty-Schieven, G. H., Scholz, A., Sharma, T., Teixeira, P. S., Wang, Y.-T., Aikawa, Y., Bower, G. C., Vivien Chen, H.-R., Bae, J., Baek, G., Chapman, S., Ping Chen, W., Du, F., Dutta, S., Forbrich, J., Guo, Z., Inutsuka, S.-i., Kang, M., Kirk, H., Kuan, Y.-J., Kwon, W., Lai, S.-P., Lalchand, B., Lane, J. M. M., Lee, C.-F., Liu, T., Morata, O., Pearson, S., Pon, A., Sahu, D., Shang, H., Stamatellos, D., Tang, S.-Y., Xu, Z., Yoo, H., and Rawlings, J. M. C., “The JCMT Transient Survey: Four-year Summary of Monitoring the Submillimeter Variability of Protostars,” *Astrophysical Journal* **920**, 119/1–23 (2021).
- [17] Guns, S., Foster, A., Daley, C., Rahlin, A., Whitehorn, N., Ade, P. A. R., Ahmed, Z., Anderes, E., Anderson, A. J., Archipley, M., Avva, J. S., Aylor, K., Balkenhol, L., Barry, P. S., Basu Thakur, R., Benabed, K., Bender, A. N., Benson, B. A., Bianchini, F., Bleem, L. E., Bouchet, F. R., Bryant, L., Byrum, K., Carlstrom, J. E., Carter, F. W., Cecil, T. W., Chang, C. L., Chaubal, P., Chen, G., Cho, H. M., Chou, T. L., Cliche, J. F., Crawford, T. M., Cukierman, A., de Haan, T., Denison, E. V., Dibert, K., Ding, J., Dobbs, M. A., Dutcher, D., Everett, W., Feng, C., Ferguson, K. R., Fu, J., Galli, S., Gambrel, A. E., Gardner, R. W., Goeckner-Wald, N., Gualtieri, R., Gupta, N., Guyser, R., Halverson, N. W., Harke-Hosemann, A. H., Harrington, N. L., Henning, J. W., Hilton, G. C., Hivon, E., Holder, G. P., Holzapfel, W. L., Hood, J. C., Howe, D., Huang, N., Irwin, K. D., Jeong, O. B., Jonas, M., Jones, A., Khaire, T. S., Knox, L., Kofman, A. M., Korman, M., Kubik, D. L., Kuhlmann, S., Kuo, C. L., Lee, A. T., Leitch, E. M., Lowitz, A. E., Lu, C., Marrone, D. P., Meyer, S. S., Michalik, D., Millea, M., Montgomery, J., Nadolski, A., Natoli, T., Nguyen, H., Noble, G. I., Novosad, V., Omori, Y., Padin, S., Pan, Z., Paschos, P., Pearson, J., Phadke, K. A., Posada, C. M., Prabhu, K., Quan, W., Reichardt, C. L., Riebel, D., Riedel, B., Rouble, M., Ruhl, J. E., Sayre, J. T., Schiappucci, E., Shirokoff, E., Smecher, G., Sobrin, J. A., Stark, A. A., Stephen, J., Story, K. T., Suzuki, A., Thompson, K. L., Thorne, B., Tucker, C., Umilta, C., Vale, L. R., Vieira, J. D., Wang, G., Wu, W. L. K., Yefremenko, V., Yoon, K. W., Young, M. R., and Zhang, L., “Detection of Galactic and Extragalactic Millimeter-wavelength Transient Sources with SPT-3G,” *Astrophysical Journal* **916**, 98/1–11 (2021).
- [18] Li, Y., Biermann, E., Naess, S., Aiola, S., An, R., Battaglia, N., Bhandarkar, T., Calabrese, E., Choi, S. K., Crowley, K. T., Devlin, M., Duell, C. J., Duff, S. M., Dunkley, J., Dünner, R., Gallardo, P. A., Guan, Y., Hervías-Caimapo, C., Hincks, A. D., Hubmayr, J., Huppenberger, K. M., Hughes, J. P., Kosowsky, A., Louis, T., Mallaby-Kay, M., McMahan, J., Nati, F., Niemack, M. D., Orłowski-Scherer, J., Page, L.,

- Salatino, M., Sifón, C., Staggs, S. T., Vargas, C., Vavagiakis, E. M., Wang, Y., and Wollack, E. J., “The Atacama Cosmology Telescope: Systematic Transient Search of 3 Day Maps,” *Astrophysical Journal* **956**, 36/1–14 (2023).
- [19] Max-Moerbeck, W., Richards, J. L., Pavlidou, V., Hovatta, T., King, O. G., Pearson, T. J., Readhead, A. C. S., Reeves, R., and Shepherd, M. C., “OVRO 40m blazar monitoring program: Understanding the relationship between 15 GHz radio variability properties and gamma-ray activity in blazars.” arXiv:1205.0276 (2014).
- [20] Mroczkowski, T., Nagai, D., Basu, K., Chluba, J., Sayers, J., Adam, R., Churazov, E., Crites, A., Di Mascolo, L., Eckert, D., Macias-Perez, J., Mayet, F., Perotto, L., Pointecouteau, E., Romero, C., Ruppin, F., Scannapieco, E., and ZuHone, J., “Astrophysics with the Spatially and Spectrally Resolved Sunyaev-Zeldovich Effects. A Millimetre/Submillimetre Probe of the Warm and Hot Universe,” *Space Science Reviews* **215**, 17/1–60 (2019).
- [21] [*Pathways to Discovery in Astronomy and Astrophysics for the 2020s*], National Academies Press, Washington, D.C. (2021). doi:10.17226/26141.
- [22] Sunyaev, R. A. and Zeldovich, Y. B., “Formation of Clusters of Galaxies; Protocluster Fragmentation and Intergalactic Gas Heating,” *Astronomy and Astrophysics* **20**, 189–200 (1972).
- [23] Battaglia, N., Bond, J. R., Pfrommer, C., and Sievers, J. L., “On the Cluster Physics of Sunyaev-Zel’dovich and X-Ray Surveys. I. The Influence of Feedback, Non-thermal Pressure, and Cluster Shapes on Y-M Scaling Relations,” *Astrophysical Journal* **758**, 74 (2012).
- [24] Nelson, K., Lau, E. T., and Nagai, D., “Hydrodynamic Simulation of Non-thermal Pressure Profiles of Galaxy Clusters,” *Astrophysical Journal* **792**, 25 (2014).
- [25] Biffi, V., Borgani, S., Murante, G., Rasia, E., Planelles, S., Granato, G. L., Ragone-Figueroa, C., Beck, A. M., Gaspari, M., and Dolag, K., “On the Nature of Hydrostatic Equilibrium in Galaxy Clusters,” *Astrophysical Journal* **827**, 112 (2016).
- [26] Siegel, S. R., Sayers, J., Mahdavi, A., Donahue, M., Merten, J., Zitrin, A., Meneghetti, M., Umetsu, K., Czakon, N. G., Golwala, S. R., Postman, M., Koch, P. M., Koekemoer, A. M., Lin, K.-Y., Melchior, P., Molnar, S. M., Moustakas, L., Mroczkowski, T. K., Pierpaoli, E., and Shitanishi, J., “Constraints on the Mass, Concentration, and Nonthermal Pressure Support of Six CLASH Clusters from a Joint Analysis of X-Ray, SZ, and Lensing Data,” *Astrophysical Journal* **861**, 71/1–29 (2018).
- [27] Sereno, M., Ettori, S., Meneghetti, M., Sayers, J., Umetsu, K., Merten, J., Chiu, I.-N., and Zitrin, A., “CLUMP-3D: three-dimensional lensing and multi-probe analysis of MACS J1206.2-0847, a remarkably regular cluster,” *Monthly Notices of the Royal Astronomical Society* **467**, 3801–3826 (2017).
- [28] Morandi, A., Limousin, M., Sayers, J., Golwala, S. R., Czakon, N. G., Pierpaoli, E., Jullo, E., Richard, J., and Ameglio, S., “X-ray, lensing and Sunyaev-Zel’dovich triaxial analysis of Abell 1835 out to R_{200} ,” *Monthly Notices of the Royal Astronomical Society* **425**, 2069–2082 (2012).
- [29] Eckert, D., Ghirardini, V., Ettori, S., Rasia, E., Biffi, V., Pointecouteau, E., Rossetti, M., Molendi, S., Vazza, F., Gastaldello, F., Gaspari, M., De Grandi, S., Ghizzardi, S., Bourdin, H., Tchernin, C., and Roncarelli, M., “Non-thermal pressure support in X-COP galaxy clusters,” *Astronomy and Astrophysics* **621**, A40 (2019).
- [30] Sayers, J., Sereno, M., Ettori, S., Rasia, E., Cui, W., Golwala, S., Umetsu, K., and Yepes, G., “CLUMP-3D: the lack of non-thermal motions in galaxy cluster cores,” *Monthly Notices of the Royal Astronomical Society* **505**(3), 4338–4344 (2021).
- [31] Kim, J., Sayers, J., Sereno, M., Bartalucci, I., Chappuis, L., De Grandi, S., De Luca, F., De Petris, M., Donahue, M. E., Eckert, D., Ettori, S., Gaspari, M., Gastaldello, F., Gavazzi, R., Gavidia, A., Ghizzardi, S., Iqbal, A., Kay, S. T., Lovisari, L., Maughan, B. J., Mazzotta, P., Okabe, N., Pointecouteau, E., Pratt, G. W., Rossetti, M., and Umetsu, K., “CHEX-MATE: CLUSTER Multi-Probes in Three Dimensions (CLUMP-3D). I. Gas analysis method using X-ray and Sunyaev-Zel’dovich effect data,” *Astronomy and Astrophysics* **686**, A97/1–15 (2024).
- [32] Sayers, J., Mroczkowski, T., Zemcov, M., Korngut, P. M., Bock, J., Bulbul, E., Czakon, N. G., Egami, E., Golwala, S. R., Koch, P. M., Lin, K.-Y., Mantz, A., Molnar, S. M., Moustakas, L., Pierpaoli, E., Rawle, T. D., Reese, E. D., Rex, M., Shitanishi, J. A., Siegel, S., and Umetsu, K., “A Measurement of the Kinetic Sunyaev-Zel’dovich Signal towards MACS J0717.5+3745,” *Astrophysical Journal* **778**, 52/1–20 (2013).

- [33] Sayers, J., Montaña, A., Mroczkowski, T., Wilson, G. W., Zemcov, M., Zitrin, A., Cibirka, N., Golwala, S., Hughes, D., Nagai, D., Reese, E. D., Sánchez, D., and Zuhone, J., “Imaging the Thermal and Kinematic Sunyaev-Zel’dovich Effect Signals in a Sample of 10 Massive Galaxy Clusters: Constraints on Internal Velocity Structures and Bulk Velocities,” *Astrophysical Journal* **880**, 45/1–15 (2019).
- [34] Wilson, G. W., Abi-Saad, S., Ade, P., Aretxaga, I., Austermann, J., Ban, Y., Bardin, J., Beall, J., Berthoud, M., Bryan, S., Bussan, J., Castillo, E., Chavez, M., Contente, R., DeNigris, N. S., Dober, B., Eiben, M., Ferrusca, D., Fissel, L., Gao, J., Golec, J. E., Golina, R., Gomez, A., Gordon, S., Gutermuth, R., Hilton, G., Hosseini, M., Hubmayr, J., Hughes, D., Kuczarski, S., Lee, D., Lunde, E., Ma, Z., Mani, H., Mauskopf, P., McCrackan, M., McKenney, C., McMahan, J., Novak, G., Pisano, G., Pope, A., Ralston, A., Rodriguez, I., Sánchez-Argüelles, D., Schloerb, F. P., Simon, S., Sinclair, A., Souccar, K., Torres Campos, A., Tucker, C., Ullom, J., Van Camp, E., Van Lanen, J., Velazquez, M., Vissers, M., Weeks, E., and Yun, M. S., “The TolTEC camera: an overview of the instrument and in-lab testing results,” in [*Millimeter, Submillimeter, and Far-Infrared Detectors and Instrumentation for Astronomy X*], Zmuidzinas, J. and Gao, J.-R., eds., *Society of Photo-Optical Instrumentation Engineers (SPIE) Conference Series* **11453**, 1145302/1–20, SPIE Press, Bellingham, WA (2020).
- [35] Le Brun, A. M. C., McCarthy, I. G., and Melin, J.-B., “Testing Sunyaev-Zel’dovich measurements of the hot gas content of dark matter haloes using synthetic skies,” *Monthly Notices of the Royal Astronomical Society* **451**, 3868–3881 (2015).
- [36] van de Voort, F., Quataert, E., Hopkins, P. F., Faucher-Giguère, C.-A., Feldmann, R., Kereš, D., Chan, T. K., and Hafen, Z., “The impact of stellar feedback on hot gas in galaxy haloes: the Sunyaev-Zel’dovich effect and soft X-ray emission,” *Monthly Notices of the Royal Astronomical Society* **463**, 4533–4544 (2016).
- [37] Crain, R. A., Schaye, J., Bower, R. G., Furlong, M., Schaller, M., Theuns, T., Dalla Vecchia, C., Frenk, C. S., McCarthy, I. G., Helly, J. C., Jenkins, A., Rosas-Guevara, Y. M., White, S. D. M., and Trayford, J. W., “The EAGLE simulations of galaxy formation: calibration of subgrid physics and model variations,” *Monthly Notices of the Royal Astronomical Society* **450**, 1937–1961 (2015).
- [38] Su, K.-Y., Hopkins, P. F., Bryan, G. L., Somerville, R. S., Hayward, C. C., Anglés-Alcázar, D., Faucher-Giguère, C.-A., Wellons, S., Stern, J., Terrazas, B. A., Chan, T. K., Orr, M. E., Hummels, C., Feldmann, R., and Kereš, D., “Which AGN jets quench star formation in massive galaxies?,” *Monthly Notices of the Royal Astronomical Society* **507**, 175–204 (2021).
- [39] Kim, J., Golwala, S., Bartlett, J. G., Amodeo, S., Battaglia, N., Benson, A. J., Hill, J. C., Hopkins, P. F., Hummels, C. B., Moser, E., and Orr, M. E., “Probing Hot Gas Components of the Circumgalactic Medium in Cosmological Simulations with the Thermal Sunyaev-Zel’dovich Effect,” *Astrophysical Journal* **926**(2), 179/1–15 (2022).
- [40] Grayson, S., Scannapieco, E., and Davé, R., “Distinguishing Active Galactic Nuclei Feedback Models with the Thermal Sunyaev-Zel’dovich Effect,” *Astrophysical Journal* **957**, 17/1–12 (2023).
- [41] Ji, S., Chan, T. K., Hummels, C. B., Hopkins, P. F., Stern, J., Kereš, D., Quataert, E., Faucher-Giguère, C.-A., and Murray, N., “Properties of the circumgalactic medium in cosmic ray-dominated galaxy haloes,” *Monthly Notices of the Royal Astronomical Society* **496**, 4221–4238 (2020).
- [42] Planck Collaboration, Ade, P. A. R., Aghanim, N., Arnaud, M., Ashdown, M., Aumont, J., Baccigalupi, C., Balbi, A., Banday, A. J., Barreiro, R. B., Battaner, E., Benabed, K., Benoit-Levy, A., Bernard, J.-P., Bersanelli, M., Bielewicz, P., Bikmaev, I., Bobin, J., Bock, J. J., Bonaldi, A., Bond, J. R., Borrill, J., Bouchet, F. R., Burigana, C., Butler, R. C., Cabella, P., Cardoso, J.-F., Catalano, A., Chamballu, A., Chiang, L.-Y., Chon, G., Christensen, P. R., Clements, D. L., Colombi, S., Colombo, L. P. L., Crill, B. P., Cuttaia, F., Da Silva, A., Dahle, H., Davies, R. D., Davis, R. J., de Bernardis, P., de Gasperis, G., de Zotti, G., Delabrouille, J., Democles, J., Diego, J. M., Dolag, K., Dole, H., Donzelli, S., Dore, O., Doerl, U., Douspis, M., Dupac, X., Ensslin, T. A., Finelli, F., Flores-Cacho, I., Forni, O., Frailis, M., Frommert, M., Galeotta, S., Ganga, K., Genova-Santos, R. T., Giard, M., Giardino, G., Gonzalez-Nuevo, J., Gregorio, A., Gruppuso, A., Hansen, F. K., Harrison, D., Hernandez-Monteagudo, C., Herranz, D., Hildebrandt, S. R., Hivon, E., Holmes, W. A., Hovest, W., Huffenberger, K. M., Hurier, G., Jaffe, T. R., Jaffe, A. H., Jasche, J., Jones, W. C., Juvela, M., Keihanen, E., Keskitalo, R., Khamitov, I., Kisner, T. S., Knoche, J., Kunz, M., Kurki-Suonio, H., Lagache, G., Lahteenmaki, A., Lamarre, J.-M., Lasenby, A., Lawrence, C. R., Le Jeune, M., Leonardi, R., Lilje, P. B., Linden-Vornle, M., Lopez-Caniego, M., Macias-Perez, J. F., Maino,

- D., Mak, D. S. Y., Mandolesi, N., Maris, M., Marleau, F., Martinez-Gonzalez, E., Masi, S., Matarrese, S., Mazzotta, P., Melchiorri, A., Melin, J.-B., Mendes, L., Mennella, A., Migliaccio, M., Mitra, S., Miville-Deschenes, M.-A., Moneti, A., Montier, L., Morgante, G., Mortlock, D., Moss, A., Munshi, D., Murphy, J. A., Naselsky, P., Nati, F., Natoli, P., Netterfield, C. B., Norgaard-Nielsen, H. U., Noviello, F., Novikov, D., Novikov, I., Osborne, S., Pagano, L., Paoletti, D., Perdereau, O., Perrotta, F., Piacentini, F., Piat, M., Pierpaoli, E., Pietrobon, D., Plaszczynski, S., Pointecouteau, E., Polenta, G., Popa, L., Poutanen, T., Pratt, G. W., Prunet, S., Puget, J.-L., Puisieux, S., Rachen, J. P., Rebolo, R., Reinecke, M., Remazeilles, M., Renault, C., Ricciardi, S., Roman, M., Rubino-Martin, J. A., Rusholme, B., Sandri, M., Savini, G., Scott, D., Spencer, L., Sunyaev, R., Sutton, D., Suur-Uski, A.-S., Sygnet, J.-F., Tauber, J. A., Terenzi, L., Toffolatti, L., Tomasi, M., Tristram, M., Tucci, M., Valenziano, L., Valiviita, J., Van Tent, B., Vielva, P., Villa, F., Vittorio, N., Wade, L. A., Welikala, N., Yvon, D., Zacchei, A., Zibin, J. P., and Zonca, A., “Planck intermediate results. XI. The gas content of dark matter halos: the Sunyaev-Zeldovich-stellar mass relation for locally brightest galaxies,” *Astronomy and Astrophysics* **557**, A52/1–17 (2013).
- [43] Greco, J. P., Hill, J. C., Spergel, D. N., and Battaglia, N., “The Stacked Thermal Sunyaev-Zel’dovich Signal of Locally Brightest Galaxies in Planck Full Mission Data: Evidence for Galaxy Feedback?,” *Astrophysical Journal* **808**, 151 (2015).
- [44] Gralla, M. B., Crichton, D., Marriage, T. A., Mo, W., Aguirre, P., Addison, G. E., Asboth, V., Battaglia, N., Bock, J., Bond, J. R., Devlin, M. J., Dünner, R., Hajian, A., Halpern, M., Hilton, M., Hincks, A. D., Hlozek, R. A., Huppenberger, K. M., Hughes, J. P., Ivison, R. J., Kosowsky, A., Lin, Y.-T., Marsden, D., Menanteau, F., Moodley, K., Morales, G., Niemack, M. D., Oliver, S., Page, L. A., Partridge, B., Reese, E. D., Rojas, F., Sehgal, N., Sievers, J., Sifón, C., Spergel, D. N., Staggs, S. T., Switzer, E. R., Viero, M. P., Wollack, E. J., and Zemcov, M. B., “A measurement of the millimetre emission and the Sunyaev-Zel’dovich effect associated with low-frequency radio sources,” *Monthly Notices of the Royal Astronomical Society* **445**, 460–478 (2014).
- [45] Crichton, D., Gralla, M. B., Hall, K., Marriage, T. A., Zakamska, N. L., Battaglia, N., Bond, J. R., Devlin, M. J., Hill, J. C., Hilton, M., Hincks, A. D., Huppenberger, K. M., Hughes, J. P., Kosowsky, A., Moodley, K., Niemack, M. D., Page, L. A., Partridge, B., Sievers, J. L., Sifón, C., Staggs, S. T., Viero, M. P., and Wollack, E. J., “Evidence for the thermal Sunyaev-Zel’dovich effect associated with quasar feedback,” *Monthly Notices of the Royal Astronomical Society* **458**, 1478–1492 (2016).
- [46] Verdier, L., Melin, J.-B., Bartlett, J. G., Magneville, C., Palanque-Delabrouille, N., and Yèche, C., “Quasar host environments: The view from Planck,” *Astronomy and Astrophysics* **588**, A61 (2016).
- [47] Amodeo, S., Battaglia, N., Schaan, E., Ferraro, S., Moser, E., Aiola, S., Austermann, J. E., Beall, J. A., Bean, R., Becker, D. T., Bond, R. J., Calabrese, E., Calafut, V., Choi, S. K., Denison, E. V., Devlin, M., Duff, S. M., Duivenvoorden, A. J., Dunkley, J., Dünner, R., Gallardo, P. A., Hall, K. R., Han, D., Hill, J. C., Hilton, G. C., Hilton, M., Hložek, R., Hubmayr, J., Huppenberger, K. M., Hughes, J. P., Koopman, B. J., MacInnis, A., McMahan, J., Madhavacheril, M. S., Moodley, K., Mroczkowski, T., Naess, S., Nati, F., Newburgh, L. B., Niemack, M. D., Page, L. A., Partridge, B., Schillaci, A., Sehgal, N., Sifón, C., Spergel, D. N., Staggs, S., Storer, E. R., Ullom, J. N., Vale, L. R., van Engelen, A., Van Lanen, J., Vavagiakis, E. M., Wollack, E. J., and Xu, Z., “Atacama Cosmology Telescope: Modeling the gas thermodynamics in BOSS CMASS galaxies from kinematic and thermal Sunyaev-Zel’dovich measurements,” *Physical Review D* **103**, 063514/1–23 (2021).
- [48] Meinke, J., Böckmann, K., Cohen, S., Mauskopf, P., Scannapieco, E., Sarmiento, R., Lunde, E., and Cottle, J., “The Thermal Sunyaev-Zel’dovich Effect from Massive, Quiescent $0.5 \leq z \leq 1.5$ Galaxies,” *Astrophysical Journal* **913**, 88/1–14 (2021).
- [49] Meinke, J., Cohen, S., Moore, J., Böckmann, K., Mauskopf, P., and Scannapieco, E., “Evidence of Extended Dust and Feedback around $z \approx 1$ Quiescent Galaxies via Millimeter Observations,” *Astrophysical Journal* **954**, 119/1–14 (2023).
- [50] Andersson, B. G., Lazarian, A., and Vaillancourt, J. E., “Interstellar Dust Grain Alignment,” *Annual Reviews of Astronomy and Astrophysics* **53**, 501–539 (2015).
- [51] Cortés, F., Reeves, R., and Bustos, R., “Analysis of the distribution of precipitable water vapor in the Chajnantor area,” *Radio Science* **51**, 1166–1175 (2016).

- [52] Cortés, F., Cortés, K., Reeves, R., Bustos, R., and Radford, S., “Twenty years of precipitable water vapor measurements in the Chajnantor area,” *Astronomy and Astrophysics* **640**, A126/1–9 (2020).
- [53] Radford, S. J. E. private communication.
- [54] Goldin, A., Bock, J. J., Hunt, C., Lange, A. E., Leduc, H., Vayonakis, A., and Zmuidzinas, J., “SAMBA: Superconducting antenna-coupled, multi-frequency, bolometric array,” *AIP Conf. Proc. 605: Low Temperature Detectors* **605**, 251–254 (2002).
- [55] Goldin, A., Bock, J. J., Hunt, C. L., Lange, A. E., LeDuc, H. G., Vayonakis, A., and Zmuidzinas, J., “Design of broadband filters and antennas for SAMBA,” in [*Proceedings of the SPIE, Vol. 4855: Millimeter and Submillimeter Detectors for Astronomy*], T. G. Phillips and J. Zmuidzinas, ed., 163–171, SPIE, Bellingham, Washington (2003).
- [56] <https://en.wikipedia.org/wiki/Microstrip>.
- [57] Posada, C. M., Ade, P. A. R., Ahmed, Z., Arnold, K., Austermann, J. E., Bender, A. N., Bleem, L. E., Benson, B. A., Byrum, K., Carlstrom, J. E., Chang, C. L., Cho, H. M., Ciocys, S. T., Cliche, J. F., Crawford, T. M., Cukierman, A., Czaplewski, D., Ding, J., Divan, R., de Haan, T., Dobbs, M. A., Dutcher, D., Everett, W., Gilbert, A., Halverson, N. W., Harrington, N. L., Hattori, K., Henning, J. W., Hilton, G. C., Holzzapfel, W. L., Hubmayr, J., Irwin, K. D., Jeong, O., Keisler, R., Kubik, D., Kuo, C. L., Lee, A. T., Leitch, E. M., Lendinez, S., Meyer, S. S., Miller, C. S., Montgomery, J., Myers, M., Nadolski, A., Natoli, T., Nguyen, H., Novosad, V., Padin, S., Pan, Z., Pearson, J., Ruhl, J. E., Saliwanchik, B. R., Smecher, G., Sayre, J. T., Shirokoff, E., Stan, L., Stark, A. A., Sobrin, J., Story, K., Suzuki, A., Thompson, K. L., Tucker, C., Vanderlinde, K., Vieira, J. D., Wang, G., Whitehorn, N., Yefremenko, V., Yoon, K. W., and Ziegler, K. E., “Fabrication of large dual-polarized multichroic TES bolometer arrays for CMB measurements with the SPT-3G camera,” *Superconductor Science and Technology* **28**, 094002/1–12 (2015).
- [58] Defrance, F., Beyer, A. D., Shu, S., Sayers, J., and Golwala, S. R., “Characterization of the low electric field and zero-temperature two-level-system loss in hydrogenated amorphous silicon,” *Physical Review Materials* **8**, 035602 (2024).
- [59] Golwala, S. R., Bockstiegel, C., Brugger, S., Czakon, N. G., Day, P. K., Downes, T. P., Duan, R., Gao, J., Gill, A. K., Glenn, J., Hollister, M. I., LeDuc, H. G., Maloney, P. R., Mazin, B. A., McHugh, S. G., Miller, D., Noroozian, O., Nguyen, H. T., Sayers, J., Schlaerth, J. A., Siegel, S., Vayonakis, A., Wilson, P. R., and Zmuidzinas, J., “Status of MUSIC, the MULTIwavelength Sub/millimeter Inductance Camera,” in [*Society of Photo-Optical Instrumentation Engineers (SPIE) Conference Series*], **8452**, 845205/1–21, SPIE, Bellingham, Washington (2012). astro-ph.IM/1211.0595.
- [60] Buijtenorp, B. T., Endo, A., Jellema, W., Karatsu, K., Kouwenhoven, K., Lamers, D., van der Linden, A. J., Rostem, K., Veen, M., Wollack, E. J., Baselmans, J. J. A., and Vollebregt, S., “Vibrational modes as the origin of dielectric loss at 0.27–100 THz in a-SiC:H.” astro-ph.IM/2405.13688 (2024). doi:10.48550/arXiv.2405.13688.
- [61] Sayers, J., Golwala, S. R., Ade, P. A. R., Aguirre, J. E., Bock, J. J., Edgington, S. F., Glenn, J., Goldin, A., Haig, D., Lange, A. E., Laurent, G. T., Mauskopf, P. D., Nguyen, H. T., Rossinot, P., and Schlaerth, J., “Studies of Millimeter-wave Atmospheric Noise above Mauna Kea,” *Astrophysical Journal* **708**, 1674–1691 (2010).
- [62] Hincks, A. D., Acquaviva, V., Ade, P. A. R., Aguirre, P., Amiri, M., Appel, J. W., Barrientos, L. F., Battistelli, E. S., Bond, J. R., Brown, B., Burger, B., Chervenak, J., Das, S., Devlin, M. J., Dicker, S. R., Doriese, W. B., Dunkley, J., Dünner, R., Essinger-Hileman, T., Fisher, R. P., Fowler, J. W., Hajian, A., Halpern, M., Hasselfield, M., Hernández-Monteagudo, C., Hilton, G. C., Hilton, M., Hlozek, R., Huppenberger, K. M., Hughes, D. H., Hughes, J. P., Infante, L., Irwin, K. D., Jimenez, R., Juin, J. B., Kaul, M., Klein, J., Kosowsky, A., Lau, J. M., Limon, M., Lin, Y.-T., Lupton, R. H., Marriage, T. A., Marsden, D., Martocci, K., Mauskopf, P., Menanteau, F., Moodley, K., Moseley, H., Netterfield, C. B., Niemack, M. D., Nolta, M. R., Page, L. A., Parker, L., Partridge, B., Quintana, H., Reid, B., Sehgal, N., Sievers, J., Spergel, D. N., Staggs, S. T., Stryzak, O., Swetz, D. S., Switzer, E. R., Thornton, R., Trac, H., Tucker, C., Verde, L., Warne, R., Wilson, G., Wollack, E., and Zhao, Y., “The Atacama Cosmology Telescope (ACT): Beam Profiles and First SZ Cluster Maps,” *Astrophysical Journal Supplements* **191**, 423–438 (2010).

- [63] Hanany, S., Hubmayr, J., Johnson, B. R., Matsumura, T., Oxley, P., and Thibodeau, M., “Millimeter-wave achromatic half-wave plate,” *Applied Optics* **44**, 4666–4670 (2005).
- [64] Savini, G., Pisano, G., and Ade, P. A. R., “Achromatic half-wave plate for submillimeter instruments in cosmic microwave background astronomy: modeling and simulation,” *Applied Optics* **45**, 8907–8915 (2006).
- [65] Pisano, G., Savini, G., Ade, P. A. R., Haynes, V., and Gear, W. K., “Achromatic half-wave plate for submillimeter instruments in cosmic microwave background astronomy: experimental characterization,” *Applied Optics* **45**, 6982–6989 (2006).
- [66] Takaku, R., Ghigna, T., Hanany, S., Hoshino, Y., Ishino, H., Katayama, N., Komatsu, K., Konishi, K., Kuwata-Gonokami, M., Matsumura, T., Sakurai, H., Sakurai, Y., Wen, Q., Yamasaki, N. Y., Yumoto, J., and the LiteBIRD Collaboration, “Performance of a 200 mm Diameter Achromatic HWP with Laser-Ablated Sub-Wavelength Structures,” *Journal of Low Temperature Physics* **211**, 346–356 (2023).
- [67] Pisano, G., Maffei, B., Ade, P. A. R., de Bernardis, P., de Maagt, P., Ellison, B., Henry, M., Ng, M. W., Schott, B., and Tucker, C., “Multi-octave metamaterial reflective half-wave plate for millimeter and submillimeter wave applications,” *Applied Optics* **55**, 10255–10262 (2016).
- [68] Chuss, D. T., Wollack, E. J., Moseley, S. H., and Novak, G., “Interferometric polarization control,” *Applied Optics* **45**, 5107–5117 (2006).
- [69] Krejny, M., Chuss, D., D’Aubigny, C. D., Golish, D., Houde, M., Hui, H., Kulesa, C., Loewenstein, R. F., Moseley, S. H., Novak, G., Voellmer, G., Walker, C., and Wollack, E., “The Hertz/VPM polarimeter: design and first light observations,” *Applied Optics* **47**, 4429/1–12 (2008).
- [70] Chuss, D. T., Wollack, E. J., Henry, R., Hui, H., Juarez, A. J., Krejny, M., Moseley, S. H., and Novak, G., “Properties of a variable-delay polarization modulator,” *Applied Optics* **51**, 197–208 (2012).
- [71] Shu, S., Beyer, A., Day, P. K., Defrance, F., Sayers, J., and Golwala, S., “A multi-chroic kinetic inductance detectors array using hierarchical phased array antenna,” *Journal of Low Temperature Physics* **209**, 330–336 (2022).
- [72] Ji, C., Beyer, A., Golwala, S., and Sayers, J., “Design of antenna-coupled lumped-element titanium nitride KIDs for long-wavelength multi-band continuum imaging,” in [*Society of Photo-Optical Instrumentation Engineers (SPIE) Conference Series*], **9153**, 915321/1–15, SPIE, Bellingham, Washington (2014).
- [73] Mazin, B. A., Sank, D., McHugh, S., Lucero, E. A., Merrill, A., Gao, J., Pappas, D., Moore, D., and Zmuidzinas, J., “Thin film dielectric microstrip kinetic inductance detectors,” *Applied Physics Letters* **96**, 102504/1–3 (2010).
- [74] Defrance, F., Beyer, A. D., Shu, S., Sayers, J., and Golwala, S. R., “Characterization of the two-level-system noise in hydrogenated amorphous silicon.” in prep.
- [75] Kumar, S., Gao, J., Zmuidzinas, J., Mazin, B. A., LeDuc, H. G., and Day, P. K., “Temperature dependence of the frequency and noise of superconducting coplanar waveguide resonators,” *Applied Physics Letters* **92**, 123503/1–3 (2008).
- [76] Meservey, R. and Tedrow, P. M., “Properties of Very Thin Aluminum Films,” *Journal of Applied Physics* **42**, 51–53 (1971).
- [77] Young, B. A., Saab, T., Cabrera, B., Miller, A. J., Brink, P. L., and Castle, J. P., “Effect of implanted metal impurities on superconducting tungsten films,” *Journal of Applied Physics* **91**, 6516–6519 (2002).
- [78] Young, B. A., Williams, J. R., Deiker, S. W., Ruggiero, S. T., and Cabrera, B., “Using ion implantation to adjust the transition temperature of superconducting films,” *Nuclear Instruments and Methods A* **520**, 307–310 (2004).
- [79] Deiker, S. W., Doriese, W., Hilton, G. C., Irwin, K. D., Rippard, W. H., Ullom, J. N., Vale, L. R., Ruggiero, S. T., Williams, A., and Young, B. A., “Superconducting transition edge sensor using dilute AlMn alloys,” *Applied Physics Letters* **85**, 2137–2139 (2004).
- [80] Ruggiero, S. T., Williams, A., Rippard, W. H., Clark, A., Deiker, S. W., Vale, L. R., and Ullom, J. N., “Dilute Al-Mn Alloys for Low-Temperature Device Applications,” *Journal of Low Temperature Physics* **134**, 973–984 (2004).
- [81] Jones, G., Johnson, B. R., Abitbol, M. H., Ade, P. A. R., Bryan, S., Cho, H. M., Day, P., Flanigan, D., Irwin, K. D., Li, D., Mauskopf, P., McCarrick, H., Miller, A., Song, Y. R., and Tucker, C., “High quality factor manganese-doped aluminum lumped-element kinetic inductance detectors sensitive to frequencies below 100 GHz,” *Applied Physics Letters* **110**, 222601/1–5 (2017).

- [82] Liu, X., Guo, W., Wang, Y., Dai, M., Wei, L. F., Dober, B., McKenney, C. M., Hilton, G. C., Hubmayr, J., Austermann, J. E., Ullom, J. N., Gao, J., and Vissers, M. R., “Superconducting micro-resonator arrays with ideal frequency spacing,” *Applied Physics Letters* **111**, 252601 (2017).
- [83] Shu, S., Calvo, M., Goupy, J., Leclercq, S., Catalano, A., Bideaud, A., Monfardini, A., and Driessen, E. F. C., “Increased multiplexing of superconducting microresonator arrays by post-characterization adaptation of the on-chip capacitors,” *Applied Physics Letters* **113**, 082603/1–5 (2018).
- [84] Defrance, F., Jung-Kubiak, C., Sayers, J., Connors, J., deYoung, C., Hollister, M. I., Yoshida, H., Chattopadhyay, G., Golwala, S. R., and Radford, S. J. E., “1.6:1 bandwidth two-layer antireflection structure for silicon matched to the 190–310 GHz atmospheric window,” *Applied Optics* **57**, 5196–5209 (2018).
- [85] Bhatia, R. S., Chase, S. T., Jones, W. C., Keating, B. G., Lange, A. E., Mason, P. V., Philhour, B. J., and Sirbi, G., “Closed cycle cooling of infrared detectors to 250 mK,” *Cryogenics* **42**, 113–122 (2002).
- [86] Ade, P. A. R., Pisano, G., Tucker, C., and Weaver, S., “A review of metal mesh filters,” in [*Proceedings of the SPIE*], **6275**, SPIE, Bellingham, Washington (2006).
- [87] Carter, F. W., Khaire, T. S., Novosad, V., and Chang, C. L., “scraps: An Open-Source Python-Based Analysis Package for Analyzing and Plotting Superconducting Resonator Data,” *IEEE Transactions on Applied Superconductivity* **27**, 1–5 (June 2017).
- [88] Zmuidzinas, J., “Superconducting Microresonators: Physics and Applications,” *Annual Reviews of Condensed Matter Physics* **3**, 169–214 (2012).
- [89] Gao, J., *The Physics of Superconducting Microwave Resonators*, PhD thesis, California Institute of Technology, Pasadena, California, USA (2008).
- [90] Mattis, D. C. and Bardeen, J., “Theory of the Anomalous Skin Effect in Normal and Superconducting Metals,” *Physical Review* **111**, 412–417 (1958).
- [91] Martin, J.-M., Kim, J., Defrance, F., Shu, S., Beyer, A. D., Day, P. K., Sayers, J., and Golwala, S. R., “Hierarchical Phased-Array Antennas Coupled to Al KIDs: A Scalable Architecture for Multi-band Millimeter/Submillimeter Focal Planes,” *Journal of Low Temperature Physics* (2024).
- [92] Bock, J. J., *Rocket-Borne Observation of Singly Ionized Carbon 158 Micrometer Emission from the Diffuse Interstellar Medium*, PhD thesis, University of California, Berkeley, California, USA (1994).
- [93] BICEP2 Collaboration, Keck Array Collaboration, SPIDER Collaboration, Ade, P. A. R., Aikin, R. W., Amiri, M., Barkats, D., Benton, S. J., Bischoff, C. A., Bock, J. J., Bonetti, J. A., Brevik, J. A., Buder, I., Bullock, E., Chattopadhyay, G., Davis, G., Day, P. K., Dowell, C. D., Duband, L., Filippini, J. P., Fliescher, S., Golwala, S. R., Halpern, M., Hasselfield, M., Hildebrandt, S. R., Hilton, G. C., Hristov, V., Hui, H., Irwin, K. D., Jones, W. C., Karkare, K. S., Kaufman, J. P., Keating, B. G., Kefeli, S., Kernasovskiy, S. A., Kovac, J. M., Kuo, C. L., LeDuc, H. G., Leitch, E. M., Lombart, N., Lueker, M., Mason, P., Megerian, K., Moncelsi, L., Netterfield, C. B., Nguyen, H. T., O’Brient, R., Ogburn, IV, R. W., Orlando, A., Pryke, C., Rahlin, A. S., Reintsema, C. D., Richter, S., Runyan, M. C., Schwarz, R., Sheehy, C. D., Staniszewski, Z. K., Sudiwala, R. V., Teply, G. P., Tolan, J. E., Trangsrud, A., Tucker, R. S., Turner, A. D., Vieregg, A. G., Weber, A., Wiebe, D. V., Wilson, P., Wong, C. L., Yoon, K. W., and Zmuidzinas, J., “Antenna-coupled TES Bolometers Used in BICEP2, Keck Array, and Spider,” *Astrophysical Journal* **812**, 176/1–17 (2015).
- [94] Defrance, F., Jung-Kubiak, C., Rahiminejad, S., Macioce, T., Sayers, J., Connors, J., Radford, S. J. E., Chattopadhyay, G., and Golwala, S. R., “Flat Low-Loss Silicon Gradient Index Lens for Millimeter and Submillimeter Wavelengths,” *Journal of Low Temperature Physics* **199**, 376–383 (2020).
- [95] Defrance, F., Jung-Kubiak, C., Gill, J., Rahiminejad, S., Macioce, T., Sayers, J., Chattopadhyay, G., and Golwala, S. R., “Flat silicon gradient index lens with deep reactive-ion-etched 3-layer anti-reflection structure for millimeter and submillimeter wavelengths.” physics.optics/2401.17637, submitted to *IEEE Transactions on Terahertz Science and Technology* (2024).
- [96] Gao, J., Daal, M., Vayonakis, A., Kumar, S., Zmuidzinas, J., Sadoulet, B., Mazin, B. A., Day, P. K., and LeDuc, H. G., “Experimental evidence for a surface distribution of two-level systems in superconducting lithographed microwave resonators,” *Applied Physics Letters* **92**, 2505/1–3 (2008).
- [97] Hähnle, S., Kouwenhoven, K., Buijtenorp, B., Endo, A., Karatsu, K., Thoen, D. J., Murugesan, V., and Baselmans, J. J. A., “Superconducting Microstrip Losses at Microwave and Submillimeter Wavelengths,” *Physical Review Applied* **16**, 014019/1–8 (2021).

- [98] Buijtenorp, B. T., Vollebregt, S., Karatsu, K., Thoen, D. J., Murugesan, V., Kouwenhoven, K., Hähnle, S., Baselmans, J. J. A., and Endo, A., “Hydrogenated Amorphous Silicon Carbide: A Low-Loss Deposited Dielectric for Microwave to Submillimeter-Wave Superconducting Circuits,” *Physical Review Applied* **18**, 064003/1–7 (2022).
- [99] Kaplan, S. B., Chi, C. C., Langenberg, D. N., Chang, J. J., Jafarey, S., and Scalapino, D. J., “Quasiparticle and phonon lifetimes in superconductors,” *Physical Review B* **14**(11), 4854–4873 (1976).
- [100] Sayers, J., Bockstiegel, C., Brugger, S., Czakon, N. G., Day, P. K., Downes, T. P., Duan, R. P., Gao, J., Gill, A. K., Glenn, J., Golwala, S. R., Hollister, M. I., Lam, A., LeDuc, H. G., Maloney, P. R., Mazin, B. A., McHugh, S. G., Miller, D. A., Mroczkowski, A. K., Noroozian, O., Nguyen, H. T., Schlaerth, J. A., Siegel, S. R., Vayonakis, A., Wilson, P. R., and Zmuidzinas, J., “The status of MUSIC: the multiwavelength submillimeter inductance camera,” in [*Society of Photo-Optical Instrumentation Engineers (SPIE) Conference Series*], **9153**, 915304/1–18, SPIE, Bellingham, Washington (2014). to be posted on astro-ph.IM.
- [101] Hollister, M. I., Czakon, N. G., Day, P. K., Downes, T. P., Duan, R., Gao, J., Glenn, J., Golwala, S. R., LeDuc, H. G., Mazin, B. A., Maloney, P. R., Noroozian, O., Nguyen, H. T., Sayers, J., Schlaerth, J. A., Siegel, S., Vaillancourt, J., Vayonakis, A., Wilson, P. R., and Zmuidzinas, J., “The cryomechanical design of MUSIC: a novel imaging instrument for millimeter-wave astrophysics at the Caltech Submillimeter Observatory,” in [*Millimeter, Submillimeter, and Far-Infrared Detectors and Instrumentation for Astronomy V*], *Society of Photo-Optical Instrumentation Engineers (SPIE) Conference Series* **7741**, 77411L/1–12, SPIE, Bellingham, Washington (2010).
- [102] Wollack, E. J., Fixsen, D. J., Henry, R., Kogut, A., Limon, M., and Mirel, P., “Electromagnetic and Thermal Properties of a Conductively Loaded Epoxy,” *International Journal of Infrared and Millimeter Waves* **29**, 51–61 (2008).
- [103] Siegel, S. R., *A Multiwavelength Study of the Intracluster Medium and the Characterization of the Multi-wavelength Sub/millimeter Inductance Camera*, PhD thesis, California Institute of Technology, Pasadena, California, USA (2016).
- [104] Wollack, E. J., Datesman, A. M., Jhabvala, C. A., Miller, K. H., and Quijada, M. A., “A broadband micro-machined far-infrared absorber,” *Review of Scientific Instruments* **87**, 054701 (2016).
- [105] Xu, Z., Chesmore, G. E., Adachi, S., Ali, A. M., Bazarko, A., Coppi, G., Devlin, M., Devlin, T., Dicker, S. R., Gallardo, P. A., Golec, J. E., Gudmundsson, J. E., Harrington, K., Hattori, M., Kofman, A., Kiuchi, K., Kusaka, A., Limon, M., Matsuda, F., McMahan, J., Nati, F., Niemack, M. D., Suzuki, A., Teply, G. P., Thornton, R. J., Wollack, E. J., Zannoni, M., and Zhu, N., “The Simons Observatory: metamaterial microwave absorber and its cryogenic applications,” *Applied Optics* **60**, 864–874 (2021).
- [106] Inoue, Y., Hasegawa, M., Hazumi, M., Takada, S., and Tomaru, T., “Development of an epoxy-based millimeter absorber with expanded polystyrenes and carbon black for an astronomical telescope,” *Applied Optics* **62**, 1419 (2023).
- [107] Pisano, G., Dunscombe, C., Hargrave, P., Shitvov, A., and Tucker, C., “Thin flexible multi-octave metamaterial absorber for millimeter wavelengths,” *Applied Optics* **62**, 2317–2328 (2023).
- [108] McHugh, S., Mazin, B. A., Serfass, B., Meeker, S., O’Brien, K., Duan, R., Raffanti, R., and Werthimer, D., “A readout for large arrays of microwave kinetic inductance detectors,” *Review of Scientific Instruments* **83**, 044702/1–9 (2012).
- [109] <https://casper.berkeley.edu/wiki/ROACH>.
- [110] Duan, R., McHugh, S., Serfass, B., Merrill, A., Czakon, N. G., Day, P. K., Downes, T. P., Gao, J., Glenn, J., Golwala, S. R., Hollister, M. I., LeDuc, H. G., Mazin, B. A., Maloney, P. R., Noroozian, O., Nguyen, H. T., Sayers, J., Schlaerth, J. A., Siegel, S., Vaillancourt, J., Vayonakis, A., Wilson, P. R., and Zmuidzinas, J., “An open-source software-defined radio readout for MKIDs,” in [*Millimeter, Submillimeter, and Far-Infrared Detectors and Instrumentation for Astronomy V*], *Society of Photo-Optical Instrumentation Engineers (SPIE) Conference Series* **7741**, 77411V/1–10, SPIE, Bellingham, Washington (2010).
- [111] Duan, R. and Golwala, S., “Readout for kinetic-inductance-detector-based submillimeter radio astronomy,” in [*Proceedings of the SPIE, Vol. 11453: Millimeter, Submillimeter, and Far-Infrared Detectors and Instrumentation for Astronomy X*], *Society of Photo-Optical Instrumentation Engineers (SPIE) Conference Series* **11453**, 114531Z, SPIE, Bellingham, Washington (2020).

- [112] Sinclair, A. K., Stephenson, R. C., Hoh, J., Gordon, S. B., and Mauskopf, P. D., “On the development of a reconfigurable readout for superconducting arrays,” in [*Millimeter, Submillimeter, and Far-Infrared Detectors and Instrumentation for Astronomy X*], Zmuidzinas, J. and Gao, J.-R., eds., *Society of Photo-Optical Instrumentation Engineers (SPIE) Conference Series* **11453**, 114531T/1–9, SPIE Press, Bellingham, WA (2020).
- [113] Sinclair, A. K., Stephenson, R. C., Roberson, C. A., Weeks, E. L., Burgoyne, J., Huber, A. I., Mauskopf, P. M., Chapman, S. C., Austermann, J. E., Choi, S. K., Duell, C. J., Fich, M., Groppi, C. E., Huber, Z., Niemack, M. D., Nikola, T., Rossi, K. M., Sriram, A., Stacey, G. J., Szakiel, E., Tsuchitori, J., Vavagiakis, E. M., and Wheeler, J. D., “CCAT-prime: RFSoc based readout for frequency multiplexed kinetic inductance detectors,” in [*Millimeter, Submillimeter, and Far-Infrared Detectors and Instrumentation for Astronomy XI*], Zmuidzinas, J. and Gao, J.-R., eds., *Society of Photo-Optical Instrumentation Engineers (SPIE) Conference Series* **12190**, 121900W/1–20, SPIE Press, Bellingham, WA (2022).
- [114] Sinclair, A. K., Burgoyne, J. R., Li, Y., Duell, C., Chapman, S. C., Huber, A. I., and Xie, R., “Breaking the 10 mW/pixel Limit for Kinetic Inductance Detector Readout Electronics.” astro-ph.IM/2305.00928, in *Proceedings of the 2022 International Symposium on Terahertz Technology* (2023).
- [115] Sinclair, A. K., Burgoyne, J., Huber, A. I., Murphy, C., Choi, S. K., Duell, C. J., Huber, Z. B., Li, Y., Chapman, S. C., Niemack, M. D., Nikola, T., Vavagiakis, E. M., Walker, S., Wheeler, J. D., Austermann, J., Lin, L., Xie, R., Zou, B., and Mauskopf, P. D., “CCAT: Detector Noise Limited Performance of the RFSoc-based Readout Electronics for mm/sub-mm/far-IR KIDs.” astro-ph.IM/2406.14892, to appear in *Proceedings of the SPIE* (2024).
- [116] Siegel, S. R., “Noise performance of the multiwavelength sub/millimeter inductance camera (MUSIC) detectors,” *Journal of Instrumentation* **10**, C07016/0–7 (2015).
- [117] Sayers, J., Zemcov, M., Glenn, J., Golwala, S. R., Maloney, P. R., Siegel, S. R., Wheeler, J., Bockstiegel, C., Brugger, S., Czakon, N. G., Day, P. K., Downes, T. P., Duan, R. P., Gao, J., Hollister, M. I., Lam, A., LeDuc, H. G., Mazin, B. A., McHugh, S. G., Miller, D. A., Mroczkowski, T. K., Noroozian, O., Nguyen, H. T., Radford, S. J. E., Schlaerth, J. A., Vayonakis, A., Wilson, P. R., and Zmuidzinas, J., “Peculiar Velocity Constraints from Five-band SZ Effect Measurements toward RX J1347.5-1145 with MUSIC and Bolocam from the CSO,” *Astrophysical Journal* **820**, 101/1–13 (2016).
- [118] Asboth, V., Conley, A., Sayers, J., Béthermin, M., Chapman, S. C., Clements, D. L., Cooray, A., Dannerbauer, H., Farrah, D., Glenn, J., Golwala, S. R., Halpern, M., Ibar, E., Ivison, R. J., Maloney, P. R., Marques-Chaves, R., Martinez-Navajas, P. I., Oliver, S. J., Pérez-Fournon, I., Riechers, D. A., Rowan-Robinson, M., Scott, D., Siegel, S. R., Vieira, J. D., Viero, M., Wang, L., Wardlow, J., and Wheeler, J., “HerMES: a search for high-redshift dusty galaxies in the HerMES Large Mode Survey - catalogue, number counts and early results,” *Monthly Notices of the Royal Astronomical Society* **462**, 1989–2000 (2016).
- [119] McCrackan, M., Ma, Z., DeNigris, N. S., Ryan, C., Souccar, K., Wilson, G. W., Aretxaga, I., Bij, A., Fissel, L., Golec, J. E., Gutermuth, R., Lee, D., Novak, G., Thiel, F., Walker, S., and Zaragoza-Cardiel, J., “The TolTEC camera: the `citlali` data reduction pipeline engine,” in [*Software and Cyberinfrastructure for Astronomy VII*], *Society of Photo-Optical Instrumentation Engineers (SPIE) Conference Series* **12189**, 121891H/1–16, SPIE Press, Bellingham, WA (2022).
- [120] Guruswamy, T., Goldie, D. J., and Withington, S., “Quasiparticle generation efficiency in superconducting thin films,” *Superconducting Science and Technology* **27**, 055012/1–7 (2014).