

Beyond Winning Strategies: Admissible and Admissible Winning Strategies for Quantitative Reachability Games

Karan Muvvala¹, Qi Heng Ho¹, Morteza Lahijanian¹

¹University of Colorado Boulder

Abstract

Classical reactive synthesis approaches aim to synthesize a reactive system that always satisfies a given specifications. These approaches often reduce to playing a two-player zero-sum game where the goal is to synthesize a winning strategy. However, in many pragmatic domains, such as robotics, a winning strategy does not always exist, yet it is desirable for the system to make an effort to satisfy its requirements instead of “giving up”. To this end, this paper investigates the notion of *admissible* strategies, which formalize “doing-your-best”, in quantitative reachability games. We show that, unlike the qualitative case, quantitative admissible strategies are history-dependent even for finite payoff functions, making synthesis a challenging task. In addition, we prove that admissible strategies always exist but may produce undesirable optimistic behaviors. To mitigate this, we propose *admissible winning* strategies, which enforce the best possible outcome while being admissible. We show that both strategies always exist but are not memoryless. We provide necessary and sufficient conditions for the existence of both strategies and propose synthesis algorithms. Finally, we illustrate the strategies on gridworld and robot manipulator domains.

1 Introduction

Reactive Synthesis is the problem of automatically generating reactive systems from logical specifications, first proposed by Church (1963). Its applications span a wide range of domains, including robotics (McMahon et al. 2023; He et al. 2017; Kress-Gazit, Lahijanian, and Raman 2018), program synthesis (Pnueli and Rosner 1989), distributed systems (Filippidis and Murray 2016), formal verification (Kupferman and Vardi 2001), and security (Zhou and Foley 2003). Existing approaches to reactive synthesis usually boil down to computing a strategy over a game between a System (Sys) and an Environment (Env) player, with the goal of finding a *winning* strategy, which guarantees the Sys player achieves its objectives regardless of the Env player’s moves. In quantitative settings, the game incorporates a payoff requirement as part of the Sys player’s objectives. In many scenarios, however, a winning strategy may not exist, resulting in a failure in the synthesis algorithm. Prior works relax this requirement using the notions of *best effort* (Aminof et al. 2021) and *admissibility* (Berwanger 2007; Brandenburger, Friedenberg, and Keisler 2008). Best effort is specific to qualitative games, while admissibility is recently studied

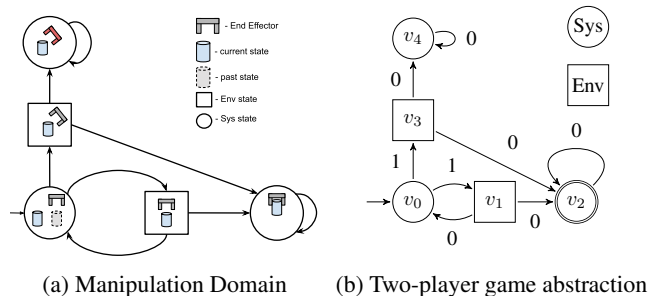

Figure 1: (a) Robotic manipulator in the presence of human. (b) Game abstraction, where weights represent robot energy.

in quantitative games under strong assumptions on the Env player, namely, rationality and known objectives (Brengruier et al. 2016). This paper aims to study admissible strategies without these assumptions in quantitative reachability games with a particular focus on applications in robotics.

Consider the example in Fig. 1 with a robot (Sys player) and a human (Env player) operating in shared workspace. The robot is tasked with grasping the bin. Since the human can intervene by moving the bin before the robot completes its grasp, there is no winning strategy that enforces completion of the task under the *worst-case* Env strategy. However, in such cases it is still desirable for the robot to make an effort to satisfy its requirements instead of “giving up”.

To this end, this paper studies admissible strategies (Faella 2009; Berwanger 2007) in quantitative reachability games without assumptions on rationality and the objectives of the Env player. These games can model quantitative reactive synthesis for finite-behaviors expressed in, e.g., syntactically co-safe Linear Temporal Logic (LTL) (Kupferman and Vardi 2001) and LTL over finite behaviors (LTL_f) (De Giacomo and Vardi 2013). We show that admissible strategies relax requirement of winning strategies, and always exist. We prove that, unlike the qualitative setting, quantitative admissible strategies are history-dependent even for finite payoff functions. Then, we show that such strategies can produce overly optimistic behaviors, which may be undesirable for robotics applications. To mitigate this, we propose *admissible winning* strategies, which have the desirable property of enforcing specification satisfaction when possible while be-

ing admissible. We prove that, similar to admissible strategies, admissible winning strategies always exist and require finite memory. Then, we provide necessary and sufficient conditions for the existence of both strategies and propose synthesis algorithms. Finally, we provide various robotic examples to show that admissible and admissible winning strategies provide desirable and flexible behaviors without a-priori knowledge of the objectives of other agents.

Our contributions are (i) analysis of admissible strategies in quantitative reachability games without assumptions on rationality and objective of the Env player, including proofs that such strategies always exist, require finite memory, and necessary and sufficient conditions for their existence, (ii) introduction and analysis of novel notion of admissible winning strategies to mitigate over-optimism in admissible strategies, (iii) synthesis algorithms for both strategies, and (iv) illustrative examples on gridworld and manipulation domains, showing emergent behaviors.

Related Work Several works explore alternatives to winning strategies. Specifically, Faella (2009) investigates various concepts in qualitative games with reachability objectives within a zero-sum framework. They focus solely on the Sys player’s objective without making any assumptions about the Env player. They use the notion of admissibility to define the notion of *best-effort* (BE). Aminof et al. (2021); De Giacomo, Parretti, and Zhu (2023) further examine the complexity of synthesizing BE strategies, showing that it can be reduced to standard algorithms, with memoryless strategies being sufficient. In contrast, our work considers quantitative reachability games where the objective is to reach a goal state with minimal total cost. We show that memoryless strategies are insufficient in our context, and our synthesis approach does not reduce to standard algorithms.

The notion of admissibility has also been explored in normal form games (Brandenburger, Friedenberg, and Keisler 2008; Apt 2011). In qualitative games with logical specifications (extensive form), admissibility has been investigated for n-player infinite games, where each player has their own objective and is assumed to play admissibly with respect to that objective – referred to as *assume admissible* (AA). Berwanger (2007) was the first to formalize this notion of AA for games played on graphs. Subsequently, Brenguier, Raskin, and Sassolas (2014); Brenguier, Raskin, and Sankur (2015) establish the complexity and give algorithms for ω -regular objectives. In our settings, we consider reachability games that terminate in finite time. Notably, we make no assumptions about the Env player, i.e. we neither know Env player’s objective nor require them to play admissibly.

The work closest to ours is by Brenguier et al. (2016), who study admissibility in quantitative settings. They extend prior works (Brenguier, Raskin, and Sassolas 2014; Brenguier, Raskin, and Sankur 2015) on infinite duration qualitative games to quantitative objectives. They analyze and give necessary and sufficient conditions for admissible strategies to exist. Unlike their work, in our settings, we consider finite duration games and appropriately define our payoff over finite traces. We show our game is always determined and thus optimal worst-case and cooperative strategies always

exist. While our analysis shares some conceptual similarities with theirs, addressing the finite play setting requires a distinct theoretical approach compared to infinite plays. Brenguier et al. (2016) give a sketch of their algorithm based on parity games. We, however, present a detailed yet simpler synthesis algorithm. We also analyze emergent behavior under admissible strategies in robotics settings. We observe that these strategies can be overly optimistic. To address this, we identify the underlying cause and propose the concept of admissible winning strategies to mitigate such optimism.

2 Problem Formulation

The overarching goal of this work is quantitative reactive synthesis for LTL_f or cosafe LTL specifications where satisfaction cannot necessarily be guaranteed. This problem reduces to reachability analysis in quantitative games played between the Sys and Env players (Baier and Katoen 2008). For the sake of generality, we focus on these games.

2-Player Quantitative Games and Strategies

Definition 1 (2-player Quantitative Game). A two-player turn-based quantitative game is a tuple $\mathcal{G} = (V, v_0, A_s, A_e, \delta, C, V_f)$, where

- $V = V_s \cup V_e$ is a finite set of states, where V_s and V_e are disjoint and belong to the Sys and Env player,
- $v_0 \in V$ is the initial state,
- A_s and A_e are the finite sets of actions for the Sys and Env player, respectively,
- $\delta : V \times (A_s \cup A_e) \rightarrow V$ is the transition function such that, for $i, j \in \{s, e\}$ and $i \neq j$, given state $v \in V_i$ and action $a \in A_i$, the successor state is $\delta(v, a) \in V_j$,
- $C : V \times (A_s \cup A_e) \rightarrow \mathbb{N} \cup \{0\}$ is the cost (energy) function such that, for every $(v, a) \in V_s \times A_s$, $C(v, a) > 0$, otherwise 0, and
- $V_f \subseteq V$ is a set of goal (final) states.

We assume that the game is non-blocking. There is at least one outgoing transition from every state, i.e., $\forall v \in V$ and $\forall a \in A$, $\delta(v, a) \neq \emptyset$. Note that the Env action cost is zero since we are solely interested in the Sys player objectives and action costs, and we make no assumption about the objective of the Env player. Finally, we assume that our transition function is deterministic and injective, i.e., $\delta(v, a) = \delta(v, a') \iff a = a'$.

The evolution of game \mathcal{G} starts from v_0 and is played in turns between the Sys and Env player. At state $v \in V_i$, where $i \in \{s, e\}$, Player i picks an action $a \in A_i$ and incurs cost $C(v, a)$. Then, the game evolves to the next state according to the transition function $\delta(v, a) \in V_j$, where $j \neq i$. Then, Player j picks an action, and the process repeats. The game terminates if a goal state in V_f is reached. The players choose actions according to a strategy.

Definition 2 (Strategy). A strategy σ (τ) is a function that maps a finite sequence of states to a Sys (Env) action, such that $\sigma : V^* \cdot V_s \rightarrow A_s$ and $\tau : V^* \cdot V_e \rightarrow A_e$, where \cdot is the concatenation operator. We denote Σ and \mathbb{T} as the set of all strategies for the Sys and Env player, respectively. A strategy is called memoryless or positional if it only depends on the last state in the sequence.

Given strategies σ and τ , a unique sequence of states, called *play* and denoted by $P^{v_0}(\sigma, \tau)$, is induced from v_0 . A play can be finite $P^{v_0}(\sigma, \tau) := v_0 v_1 \dots v_n \in V^*$ or infinite $P^{v_0}(\sigma, \tau) := v_0 v_1 \dots \in V^\omega$. We denote by $\text{Plays}^v := \{P^v(\sigma, \tau) \mid \sigma \in \Sigma, \tau \in \mathbb{T}\}$ the set of plays starting from v under every Sys and Env strategy. $\text{Plays}^v(\sigma)$ is the set of plays induced by a fixed strategy σ and every Env strategy. We note that a finite play occurs iff a goal state is reached.

A finite prefix of a play is called the history h . We define $|h|$ the length of the history and h_j for $0 \leq j \leq |h| - 1$ as the $(j + 1)^{\text{th}}$ state in the sequence. The last vertex of a history h is defined as $\text{last}(h) := h_{|h|-1}$. We denote the set of plays with common prefix h as $\text{Plays}^h := \{P^h = h \cdot P \mid P \in \text{Plays}^v(\sigma, \tau), \sigma \in \Sigma, \tau \in \mathbb{T}, v = \delta(\text{last}(h), \sigma(h)) \text{ if } v \in V_s, \text{ else } v = \delta(\text{last}(h), \tau(h))\}$.

In a qualitative reachability game, the objective of the Sys player is to choose σ such that every play in $\text{Plays}^{v_0}(\sigma)$ reaches a state in V_f . In a quantitative reachability game, the Sys player has an additional objective of minimizing the total cost of its actions along the play, called the payoff.

Definition 3 (Total Payoff). *Given strategies $\sigma \in \Sigma$ and $\tau \in \mathbb{T}$, total-payoff is defined as the sum of all the action costs given by C along the induced play $P^{v_0}(\sigma, \tau) = v_0 v_1 \dots v_n$ where $n \in \mathbb{N} \cup \{\infty\}$, i.e.,*

$$\text{Val}(P^{v_0}(\sigma, \tau)) := \sum_{i=0}^{n-1} C(v_i, a_i, v_{i+1}), \quad (1)$$

where $a_i = \sigma(v_0 \dots v_i)$ if $v_i \in V_s$, or else $a_i = \tau(v_0 \dots v_i)$.

Note that, for a play with infinite length $|P^{v_0}(\sigma, \tau)| = \infty$, $\text{Val}(P^{v_0}(\sigma, \tau)) = \infty$. We now define two notions of payoff for a game \mathcal{G} that formalizes best-case and worst-case scenarios for the Sys player with respect to Val .

Definition 4 (Cooperative & Adversarial Values). *Given Sys strategy σ and history h , let $h \cdot P^h(\sigma, \tau)$ denote a play that extends history h , where σ and τ are strategies compatible with h . The cooperative value $\text{cVal}(h, \sigma)$ is the payoff of the play such that the Env player plays minimally, i.e.,*

$$\text{cVal}(h, \sigma) = \min_{\tau \in \mathbb{T}} \text{Val}(h \cdot P^h(\sigma, \tau)). \quad (2)$$

Similarly, the adversarial value $\text{aVal}(h, \sigma)$ is the payoff where the Env player plays maximally, i.e.,

$$\text{aVal}(h, \sigma) = \max_{\tau \in \mathbb{T}} \text{Val}(h \cdot P^h(\sigma, \tau)). \quad (3)$$

We denote by $\text{cVal}(h)$ and $\text{aVal}(h)$ the optimal cooperative and adversarial values for history h , respectively, i.e.,

$$\text{cVal}(h) = \min_{\sigma \in \Sigma} \text{cVal}(h, \sigma) \text{ and } \text{aVal}(h) = \min_{\sigma \in \Sigma} \text{aVal}(h, \sigma).$$

We say a Sys strategy $\sigma_{\text{win}} \in \Sigma$ is *winning* if $\text{aVal}(h, \sigma_{\text{win}}) < \infty$. If σ_{win} exists, the Sys player can force a visit to V_f for all Env strategies, guaranteeing its reachability objective. In classical quantitative reactive synthesis, the interest is in a σ_{win} that achieves the optimal $\text{aVal}(v_0)$.

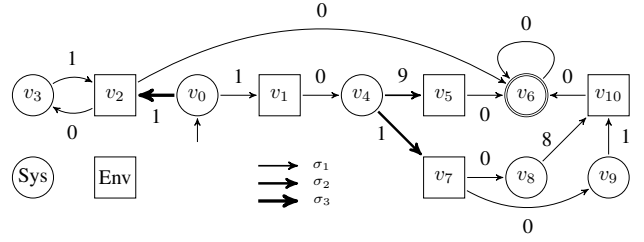

Figure 2: Illustrative game. v_0 is initial and v_6 is goal state.

Beyond Winning Strategies

In many applications, when a winning strategy does not exist, it is desirable for the Sys player to adopt a strategy that ensures the best possible outcome. For game \mathcal{G} in Fig. 1, σ_{win} does not exist but it is better for the Sys player to keep trying, i.e., move to v_1 or v_3 rather than giving up. To capture this intuition, we turn to the classical notion of dominance.

Definition 5 (Dominance (Brenquier et al. 2016; Berwanger 2007)). *Given two Sys strategies $\sigma, \sigma' \in \Sigma$, we say*

- σ very weakly dominates σ' , denoted by $\sigma \succeq \sigma'$, if σ does at least as well as σ' :

$$\text{Val}(P^v(\sigma, \tau)) \leq \text{Val}(P^v(\sigma', \tau)) \quad \forall \tau \in \mathbb{T}. \quad (4)$$

- σ weakly dominates σ' , denoted by $\sigma \succ \sigma'$, if $\sigma \succeq \sigma'$ and σ sometimes does better than σ' :

$$\text{Val}(P^v(\sigma, \tau)) < \text{Val}(P^v(\sigma', \tau)) \quad \exists \tau \in \mathbb{T}. \quad (5)$$

Dominance induces a partial order on Sys strategies, whose maximal elements are called admissible strategies. Strategies that are not dominated are always admissible.

Definition 6 (Admissible Strategy). *A strategy σ is called admissible if it is not weakly dominated by any other Sys player strategy, i.e., $\nexists \sigma' \in \Sigma$ s.t. $\sigma' \succ \sigma$.*

Example 1. *In the game in Fig. 2, let $\sigma_1 : (v_0 \rightarrow v_1), (v_4 \rightarrow v_5)$, $\sigma_2 : (v_0 \rightarrow v_1), (v_4 \rightarrow v_7)$, and $\sigma_3 : (v_0 \rightarrow v_2), (v_3 \rightarrow v_2)$. As $\sigma_2 \succ \sigma_1$, σ_1 is not admissible. But, σ_3 is not weakly dominated by σ_2 as there exists a play under which σ_3 does strictly better than σ_2 for every play in $\text{Plays}^{v_0}(\sigma_2)$. Hence, σ_3 and σ_2 are both admissible.*

Brandenburger, Friedenber, and Keisler (2008) rationalize a player playing admissibly to be doing their *best*. Thus, the first problem we consider is the synthesis of admissible strategies for Sys player in \mathcal{G} .

Problem 1 (Admissible Strategy Synthesis). *Given a 2-player quantitative reachability game \mathcal{G} and energy budget $\mathcal{B} \in \mathbb{N}$, synthesize the set of all admissible strategies Σ_{adm} such that, for every $\sigma \in \Sigma_{\text{adm}}$, there exists $\tau \in \mathbb{T}$ under which $\text{Val}(P^{v_0}(\sigma, \tau)) \leq \mathcal{B}$.*

Intuitively, $\sigma \in \Sigma_{\text{adm}}$ allows the Sys player to do its best without any assumptions about the Env player. In qualitative settings, winning strategies are always admissible (Brenquier, Raskin, and Sankur 2015, Lemma 8). In quantitative settings, however, winning strategies are not necessarily admissible (e.g., σ_1 in the game in Fig. 2). Thus, to compute

enforceable admissible strategies, we introduce the notion of admissible winning strategy.

Definition 7 (Admissible Winning Strategy). *Given budget $\mathcal{B} \in \mathbb{N}$, strategy σ is called admissible winning for the Sys player if it is admissible and $\forall h \in \text{Plays}^{v_0}(\sigma)$ if $\text{aVal}(h) < \infty$ then $\text{Val}(h \cdot P^h(\sigma, \tau)) \leq \mathcal{B}$ for all $\tau \in \mathbb{T}$.*

For the game in Fig. 2, σ_3 is admissible but not enforcing as it can not ensure always reaching the goal state. σ_1 is winning but not admissible. σ_2 is admissible winning, which is more desirable than the other two.

Problem 2 (Admissible Winning Strategy Synthesis). *Given a 2-player quantitative reachability game \mathcal{G} and energy budget $\mathcal{B} \in \mathbb{N}$, synthesize the set of all admissible winning strategies Σ_{adm}^{win} .*

In Section 3, we show how to solve Problem 1 by providing necessary and sufficient conditions for a strategy to be admissible. In Section 4, we identify the class of admissible strategies that are admissible winning and give an algorithm to solve Problem 2.

3 Admissible Strategies

To have a sound and complete algorithm for the synthesis of Σ_{adm} , we need to first understand the characteristics and properties of admissible strategies. Prior works in qualitative reachability games show that synthesis can be reduced to strategies with *value-preserving* property (defined below). We show that in our quantitative setting, this property does *not* hold. Thus, we investigate the appropriate conditions that characterize admissible strategies. We identify two classes of strategies that are not only sufficient but also necessary for a strategy to be admissible. Finally, we show how memoryless strategies are not sufficient for admissibility and provide a synthesis algorithm.

Admissible Strategies are not Value-Preserving

The reachability objective in \mathcal{G} naturally partitions the set of states V into three subsets: the set of states from which the Sys player (i) can force a visit to V_f under every Env strategy, (ii) can not reach V_f under any Env strategy, and (iii) may reach V_f only under some Env strategies. We can formalize these sets using $\text{cVal}(v)$ and $\text{aVal}(v)$:

$$\begin{aligned} \text{winning region: } V_{win} &= \{v \in V \mid \text{aVal}(v) < \infty\}, \\ \text{losing region: } V_{los} &= \{v \in V \mid \text{aVal}(v) = \text{cVal}(v) = \infty\}, \\ \text{pending region: } V_{pen} &= \{v \in V \mid \text{aVal}(v) = \infty, \\ &\quad \text{cVal}(v) < \infty\}. \end{aligned}$$

Note V_{win} , V_{los} , and V_{pen} define a partition for V , i.e., their union is V and their pair-wise intersection is the empty set. Based on these sets, we characterize value-preserving strategies according to the notion of value for each state. Let $\text{sVal} : V \rightarrow \{-1, 0, 1\}$ be a state-value function such that $\text{sVal}(v) = 1$ if $v \in V_{win}$, 0 if $v \in V_{pen}$, -1 if $v \in V_{los}$.

Definition 8 (Value-Preserving). *We say history h is value-preserving if $\text{sVal}(h_j) \leq \text{sVal}(h_{j+1})$ for all $0 \leq j < |h| - 1$. Strategy σ is value preserving, if every $h \in \text{Plays}^{v_0}(\sigma)$ is value preserving.*

	SC	WCo-Op	mSC	Adm.	Adm. winning
Value-preserving	✗	✓	✓	✗	✓
Winning	✗	✓	✓	✗	✓
Memoryless	✗	✓	✗	✗	✗
Algorithm	Sec. 3	Sec. 3	Sec. 4	Sec. 3	Sec. 4

Table 1: Properties of strategies

Let us now look at two classical notions for strategies defined for quantitative games and discuss their value-preserving property. We say σ is a *worst-case optimal* strategy (**WCO**) if $\text{aVal}(h, \sigma) = \text{aVal}(h)$. If at the current state v , $\text{sVal}(v) = 1$, then an optimal winning strategy σ_{win} exists such that all plays in $\text{Plays}^v(\sigma_{win})$ are value-preserving. Since σ_{win} is **WCO**, every **WCO** strategy in V_{win} is also value preserving. If $\text{sVal}(v) \neq -1$, a *cooperatively-optimal* (**Co-Op**) strategy σ exists such that $\text{cVal}(h, \sigma) = \text{cVal}(h)$. Unlike worst-case optimal strategies, **Co-Op** are not value-preserving. In Fig. 2, σ_1 and σ_2 are **WCO** while σ_3 is **Co-Op**. The following lemma shows that admissible strategies do not guarantee value-preserving property.

Lemma 1. *Admissible strategies are not always value preserving.*

Unlike the qualitative setting (Faella 2009; Aminof et al. 2020), Lemma 1 shows that we cannot characterize admissible strategies solely on the basis of **WCO** strategies as they are not value-preserving in our quantitative setting. In the next section, we discuss two new categories of strategies derived from **WCO** and **Co-Op** that are always admissible. We then discuss their properties and show that they are also necessary conditions for admissibility. Table 1 summarizes properties of all new strategies we define hereafter.

Characterization of Admissible Strategies

For every history h , we observe that strategies that are cooperative optimal have the least payoff. Thus, every σ that is **Co-Op** is admissible as there does not exist σ' that weakly dominates it. We now define *strongly cooperative* condition (**SC**) which generalizes **Co-Op**. Intuitively, strategies that are **SC** have a lower payoff than the worst-case optimal payoff at h . In case, a lower payoff cannot be obtained, **SC** are worst-case optimal.

Definition 9 (**SC**). *Strategy σ is Strongly Cooperative (**SC**) if for every $h \in \text{Plays}^{v_0}(\sigma)$ one of the following two conditions holds: (i) if $\text{cVal}(h) < \text{aVal}(h)$ then $\text{cVal}(h, \sigma) < \text{aVal}(h)$, or (ii) if $\text{cVal}(h) = \text{aVal}(h)$ then $\text{aVal}(h, \sigma) = \text{cVal}(h, \sigma) = \text{aVal}(h)$.*

In the game in Fig. 2, both σ_2 and σ_3 are **SC** strategies.

Let σ' be a strategy that is not **SC**. If $\text{cVal}(h, \sigma') > \text{aVal}(h)$ then σ' always has a payoff worse than a **WCO** strategy. If $\text{cVal}(h, \sigma') = \text{aVal}(h)$ then σ' does as well as a **WCO** strategy but never better. Thus, σ' does not weakly dominate a **SC** strategy, resulting in the following lemma.

Lemma 2. *All **SC** strategies are admissible.*

From Lemma 2, it suffices for us to show that **SC** strategies always exist to prove that admissible strategies always

exist. Unfortunately, **SC** strategies are history-dependent, i.e., we need to reason over every state along a history to check for admissibility.

Theorem 1. *Memoryless strategies are not sufficient for **SC** strategies.*

We now look at another interesting class of strategy that is always admissible. For every history h , **WCO** strategies always guarantee the worst-case payoff. A subset of **WCO** strategies that are also cooperative optimal ensures that such strategies enforce a worst-case payoff while safely minimizing the payoff. We call such strategies *Worst-case Cooperative Optimal* strategies (**WCo-Op**).

Definition 10 (WCo-Op). *Strategy σ is Worst-case Cooperative Optimal (**WCo-Op**) if, for all $h \in \text{Plays}^{v_0}(\sigma)$,*

$$\text{aVal}(h, \sigma) = \text{aVal}(h) \text{ and } \text{cVal}(h, \sigma) = \text{acVal}(h),$$

where $\text{acVal}(h) := \min\{\text{cVal}(h, \sigma') \mid \sigma' \in \Sigma, \text{aVal}(h, \sigma) \leq \text{aVal}(h)\}$ is the optimal adversarial-cooperative value of h .

In the game in Fig. 2, only σ_2 is **WCo-Op** strategy. That is because action $v_4 \rightarrow v_7$ belongs to an admissible strategy as it has the minimum cooperative value while ensuring the worst-case optimal payoff. Here $\text{aVal}(v_4, \sigma_2) = \text{aVal}(v_4) = 9$; $\text{cVal}(v_4, \sigma_2) = 2$.

Let σ' be a strategy that is not **WCo-Op** and **WCO**. If σ is **WCO**, then the worst-case payoff of σ' is greater than σ 's worst-case payoff. As there exists a play under σ' that does strictly worse than all plays under σ , it can not dominate σ . Thus, σ is admissible.

Lemma 3. *All **WCo-Op** strategies are admissible.*

From Lemma 3, it suffices for us to show that **WCo-Op** strategies always exist for admissible strategies to always exist. Interestingly, unlike prior work (Brenquier et al. 2016), in our case, **WCo-Op** strategies do always exist and at least one is memoryless. The latter is desirable because memoryless strategies can be computed efficiently using fixed-point like algorithms (Baier and Katoen 2008).

Theorem 2. ***WCo-Op** strategies always exist and at least one is memoryless.*

A consequence of Thm. 2 is that a subset of admissible strategies, precisely **WCo-Op** strategies, are history-independent even for a payoff that is history-dependent. Thus, for σ to be admissible, it is sufficient to be **SC** or **WCo-Op**, i.e.,

$$(\text{cVal}(h, \sigma) < \text{aVal}(h)) \vee \quad (6a)$$

$$(\text{aVal}(h) = \text{aVal}(h, \sigma) \wedge \text{cVal}(h, \sigma) = \text{acVal}(h)) \quad (6b)$$

As shown below (Thm. 3), **SC** and **WCo-Op** are also necessary conditions for admissibility. This becomes useful for synthesizing the set of all admissible strategies.

Existence of Admissible Strategies

By simplifying Eq. (6), we get the following theorem.

Theorem 3. *A strategy σ is admissible if, and only if, $\forall h \in \text{Plays}^{v_0}(\sigma)$ with $\text{last}(h) \in V_s$, the following holds*

$$(\text{cVal}(h, \sigma) < \text{aVal}(h)) \vee \quad (7a)$$

$$(\text{aVal}(h) = \text{aVal}(h, \sigma) = \text{cVal}(h, \sigma) = \text{acVal}(h)). \quad (7b)$$

Analogously, a strategy σ is not admissible if there exists another strategy σ' that weakly dominates it. Formally, $\sigma' \succ \sigma$ if, and only if, $\forall h \in \text{Plays}^{v_0}(\sigma)$, the following holds:

$$(\text{cVal}(h, \sigma) \geq \text{aVal}(h) \wedge \text{aVal}(h, \sigma) > \text{aVal}(h)) \vee \quad (8a)$$

$$(\text{aVal}(h) = \text{aVal}(h, \sigma) = \text{cVal}(h, \sigma) \wedge \text{acVal}(h) < \text{aVal}(h)) \quad (8b)$$

Lemma 4. *Strategy σ is weakly dominated if, and only if, negation of Eq. (7) holds.*

For history h , Eq. (8a) implies there exists another strategy σ' that is **WCO** and thus has a lower adversarial value than $\text{aVal}(h, \sigma)$. Further, the cooperative value under strategy σ is either worse or equal to $\text{aVal}(h)$. Thus, σ' weakly dominates σ . In Eq. (8b), σ is not **WCo-Op** as there exists σ' with lower cooperative optimal payoff while being worst-case optimal. Thus, σ' weakly dominates σ .

Theorem 4. *There always exists an admissible strategy in a 2-player, turn-based, total-payoff, reachability game \mathcal{G} .*

Observe that Thm. 3 characterizes the set of all admissible strategies and Thm. 4 establishes their existence in full generality for 2-player turn-based games with reachability objectives. For computability consideration, we bound the payoffs associated with plays to a given budget \mathcal{B} so that the set of all admissible strategies is finite. This is a reasonable assumption as, in many real-world applications, systems usually have limited resources like battery.

Admissible Strategy Synthesis

Given \mathcal{G} and budget \mathcal{B} , we first construct a game tree arena that captures all plays with payoff less than or equal to \mathcal{B} . Next, we show that the payoff function on this tree is history-independent, which allows us to modify Thm. 3 and compute a finite set of aVals. We first conclude the following from Lemma 2 and Thm 1.

Corollary 1. *Memoryless strategies are not sufficient for admissible strategies.*

A consequence of Corollary 1 is that we cannot use a backward induction-based algorithm to compute these strategies. Thus, we use a forward search algorithm that starts from the initial state and recursively checks whether the admissibility constraints are satisfied.

Game Tree Arena The algorithm is outlined in Alg. 1. Given game \mathcal{G} and budget \mathcal{B} , we construct a tree of plays \mathcal{G}' by unrolling \mathcal{G} until the payoff associated with a play exceeds \mathcal{B} or a goal state is reached. Every play in \mathcal{G} corresponds to a branch in \mathcal{G}' . Every play that reaches a goal state with a payoff $b \leq \mathcal{B}$ in \mathcal{G} is a play that ends in a leaf node in \mathcal{G}' , which is marked as a goal state for Sys player. The leaf nodes in \mathcal{G}' that correspond to the plays with payoff $b > \mathcal{B}$ in \mathcal{G} are assigned a payoff of $+\infty$. Further, in \mathcal{G}' , the weights along all the edges are zero, and the payoffs are strictly positive only when a play reaches a leaf node, otherwise it is zero. By construction, the payoff function Val is history-independent in \mathcal{G}' . Informally, a history-independent

Algorithm 1: Pseudocode for Problem 1

Input : Game \mathcal{G} , Budget \mathcal{B}
Output: Strategy Σ_{adm}

- 1 $\mathcal{G}' \leftarrow$ Unroll \mathcal{G} up until payoff \mathcal{B}
- 2 $aVal; cVal \leftarrow$ ValueIteration (\mathcal{G}')
- 3 **forall** v in \mathcal{G}' **do** $acVal(v) \leftarrow$ as per Def. 10;
- 4 **if** $\mathcal{B} < cVal(v_0)$ **then return** \mathcal{G} ;
- 5 $h.push((v_0, \{\delta(v_0, a_s)\}))$ # let h be a stack
- 6 **while** $h \neq \emptyset$ **do**
- 7 $v, \{v'\} \leftarrow h[-1]$
- 8 **try** $v' \leftarrow next(iter(\{v'\}))$:
- 9 **if** $v \in V_s$ and $((9a) \vee (9b))$ holds **then**
- 10 $h.push((v', \{\delta(v', a_e)\}))$
- 11 $\Sigma_{adm} : h \rightarrow v'$ # Add only states in h
- 12 **if** $v \in V_e$ **then** $h.push((v', \{\delta(v', a_s)\}))$;
- 13 **catch StopIteration:** $h.pop()$;
- 14 **return** Σ_{adm}

Val assigns values to plays according to only the current state and does not depend on the history of visited states. Then, Thm. 3 can be restated as the following lemma.

Lemma 5. *Given \mathcal{G}' , strategy σ is admissible if, and only if, $\forall h \in \text{Plays}^{v_0}(\sigma)$ with $\text{last}(h) \in V_s$ and $v' = \delta(\text{last}(h), \sigma(h))$, the following holds,*

$$(cVal(v') < \min\{aValues\}) \vee \quad (9a)$$

$$(aVal(\text{last}(h)) = aVal(v') = cVal(v') = acVal(\text{last}(h))) \quad (9b)$$

where $aValues := \{aVal(v) | v \in h\}$ is the set of adversarial values along history h .

In Alg. 1, we first construct \mathcal{G}' as discussed before. Then, we compute $aVal$ and $cVal$ values for each state in \mathcal{G}' using the Value Iteration algorithm (Brihaye et al. 2017). If $\mathcal{B} < cVal(v_0)$, then there does not exist a play that reaches a goal state in \mathcal{G}' . Thus, all strategies in \mathcal{G} are admissible. To compute admissible strategies on \mathcal{G}' , we use a DFS algorithm to traverse every play and check if the admissibility criteria from Lemma 5 is satisfied. If yes, we add the history and the successor state to Σ_{adm} . We repeat this until every state in \mathcal{G}' is explored. This algorithm is sound and complete with polynomial time complexity.

Theorem 5 (Sound and Complete). *Given \mathcal{G} and \mathcal{B} , Algorithm 1 returns the set of all admissible strategies Σ_{adm} and has polynomial time complexity.*

4 Admissible Winning Strategies

Although value preservation is a desirable attribute, Lemma 1 shows that admissible strategies do not ensure this. In contrast, an admissible winning strategy is value-preserving and enforces reaching a goal state from the winning region. For instance, for the game in Fig. 2, an admissible winning strategy commits to v_1 from v_0 , which is value-preserving. This is desirable as it ensures reaching v_6 , while the other admissible strategies do not.

Here, we identify the subset of admissible strategies that are not value-preserving (aka, optimistic strategy), and prove that if they exist, they must be **SC**. Next, we propose **mSC** that are admissible winning and show that **mSC** and **WCo-Op** are admissible winning. Finally, we show that they always exist and give our synthesis algorithm.

Optimistic Strategy

In Sec. 3, we show that **SC** strategies are willing to risk a higher payoff ($aVal(\sigma(h)) > cVal(h, \sigma)$) in the hopes that the Env will cooperate, i.e., they are optimistic.

Definition 11 (Optimistic Strategy). *Strategy σ is an optimistic strategy if, and only if, σ is admissible but not value preserving.*

We now show that if optimistic strategies exist, then they must be **SC** strategies. This implies, **WCo-Op** strategies are never optimistic strategies.

Lemma 6. *If an optimistic strategy exists, it must be **SC** strategy.*

Thus, to enforce value-preserving, we modify Def. 9.

Definition 12 (**mSC**). *For all $h \in \text{Plays}^{v_0}(\sigma)$, strategy σ is **mSC**, if σ is **SC** and value-preserving, i.e., if $sVal(\text{last}(h)) = 1$ then $sVal(\delta(\text{last}(h), \sigma(h))) = 1$.*

We say that every strategy that is either **WCo-Op** or **mSC** is admissible winning as they are value preserving and admissible. In Fig. 2, both σ_2 and σ_3 are admissible, but σ_3 is not **mSC** as it is not value preserving. Thus, only σ_2 is admissible winning strategy.

Theorem 6. *A strategy σ is admissible winning if, and only if, $\forall h \in \text{Plays}^{v_0}(\sigma)$ with $\text{last}(h) \in V_s$, the following holds*

$$\left((cVal(h, \sigma) < aVal(h)) \wedge \quad (10a)$$

$$(sVal(\text{last}(h)) = 1 \implies sVal(\delta(\text{last}(h), \sigma(h))) = 1) \right) \vee$$

$$(aVal(h) = aVal(h, \sigma) = cVal(h, \sigma) = acVal(h)) \quad (10b)$$

The additional term in Eq. (10a) in comparison to Eq. (6a) constrains a strategy σ that satisfies **SC** condition in the winning region to action(s) such that $\delta(\text{last}(h), \sigma(h)) \in V_{win}$. For all h with $\text{last}(h) \notin V_{win}$, the condition is the same as the **SC** condition in Eq. (6a).

Lemma 7 (Existence of admissible winning strategies). *There always exists an admissible winning strategy in a 2-player, turn-based, total-payoff, reachability games \mathcal{G} .*

Admissible Winning Strategy Synthesis

Here, we give the algorithm to solve Problem 2. Similar to admissible strategies, admissible winning strategies are history-dependent as shown by the next theorem.

Theorem 7. *Memoryless strategies are not sufficient for admissible winning strategies.*

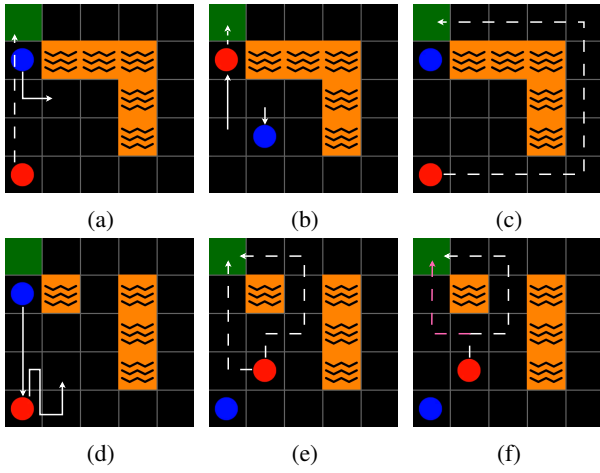

Figure 3: Top Row: (b) σ_{adm} for $\mathcal{B} = 5$ and (c) σ_{adm}^{win} for $\mathcal{B} = 12$. Bottom Row $\mathcal{B} = 12$: (e) σ_{adm} and (f) σ_{adm}^{win} .

Thus, memoryless strategies are not sufficient for strategies to be admissible winning. The algorithm is the same as Alg. 1 except for checking the admissibility criteria. The construction of the tree, the syntax, and semantics are as outlined in Sec. 3. We modify the admissibility checking criteria in Line 9 of Alg. 1 to $cVal(v') < \min\{aValues\}$ and $\neg(v \in V_{win}) \vee (v' \in V_{win})$. This modification expresses the value-preserving term from Eq. (10a).

Theorem 8 (Sound and Complete). *Given \mathcal{G} and \mathcal{B} , the algorithm described returns the set of all admissible winning strategies Σ_{adm}^{win} .*

5 Examples

We now discuss the emergent behavior under admissible and admissible winning strategies in two settings: (i) a gridworld domain, where two agents take actions in turns, and (ii) a manipulator domain, where a robotic arm and a human operate in a shared workspace. For both domains, the task φ is specified using LTL_f formulas. We first construct a game abstraction \mathcal{G} . Next, we construct a deterministic finite automaton (DFA) for the task (Fuggitti 2019) and take the product to construct the product (DFA) game, where the objective for the Sys player is to reach a set of goal (accepting) states. See (Muvvala, Amorese, and Lahijanian 2022; Watanabe et al. 2021) for more details. Code is included in the supplementary material and will be made public upon publication.

Gridworld Fig. 3 illustrates a gridworld domain with Sys (red), Env (blue), goal (green), and lava (orange) states. The objective for Sys is to reach the goal state while avoiding the Env player. The players should not enter lava states and the Env player can not traverse through the goal state. Action cost is 1 for all Sys player actions. The game is played in turns starting with Sys player where both players take one step in each cardinal direction per turn.

In Fig. 3, dashed line represents dominant strategy for Sys player from current state and solid line represents past actions. Fig. 3a and 3d illustrate the initial position of both

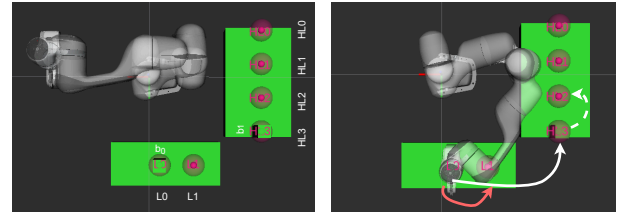

Figure 4: Left: Initial setup. Right: Strategy σ_{adm}^{win} (red) and σ_{adm} (solid white).

players for two scenarios, 3b & 3e shows σ_{adm} , and 3c & 3f show σ_{adm}^{win} strategy. In Fig. 3a, a winning strategy exists if $\mathcal{B} \geq 12$ but in Fig. 3d no winning strategy exists. In Fig. 3b, for $\mathcal{B} = 5$, σ_{adm} exists and it relies on Env’s cooperation to reach goal state. Note that $\sigma_{adm}^{win} \equiv \sigma_{adm}$ as there is no winning region. In Fig. 3c, σ_{adm}^{win} exists and commits to go around and reach goal state while σ_{adm} strategy does not. For Fig. 3d - 3f, given history, the Sys player is in V_{win} . Under strategy σ_{adm} in 3e, the Sys player can go west (in V_{pen}) or north (in V_{win}). Nonetheless, σ_{adm}^{win} in 3f commits to going north as it is winning, and there also exists a shorter safer path (pink) to goal state if Env cooperates.

Manipulator Domain This domain considers a manipulator arm (Sys) operating in presence of a human (Env). In Fig. 4, only Sys can manipulate boxes at location “L#” (bottom) while both players can moves boxes at “HL#” (right) locations. Fig. 4-left shows the initial setup: b_0 at L0 and b_1 and HL3. Objective for Sys is: either b_0 at L1 or b_0 at HL3 and b_1 at HL2 and never b_0 at HL0. It is more expensive for Sys to operate at L# locations than to operate at HL# locations. Note that a winning strategy from the initial state exists.

Under σ_{adm}^{win} , Sys player places b_0 at L1 as this always ensure task completion. We note that strategy that places b_0 at HL0 will never be admissible. Under σ_{adm} , Sys player transits to box b_0 and grasps it. As the human cooperates, Sys finishes the task by placing b_0 at HL3. There exists human actions that can force Sys player to violate the task once b_0 is in HL#. Thus, σ_{adm} generates optimistic behaviors.

6 Conclusion

This paper relaxes the requirement of winning strategies in quantitative, reachability games using the notion of admissibility. While we show that admissible strategies are desirable in such settings, they are hard to synthesize due to their history-dependence. We show that such strategies can produce overly optimistic behaviors, and propose admissible winning strategies to mitigate them. We specifically show that admissible winning strategies are appropriate for robotics applications and their synthesis does not require more effort than synthesizing admissible strategies. Future work should explore derivatives of admissible winning strategies that are more risk-averse, like regret-minimizing admissible strategies.

References

- Aminof, B.; De Giacomo, G.; Lomuscio, A.; Murano, A.; Rubin, S.; et al. 2020. Synthesizing strategies under expected and exceptional environment behaviors. In *IJCAI*, 1674–1680.
- Aminof, B.; De Giacomo, G.; and Rubin, S. 2023. Reactive Synthesis of Dominant Strategies. *Proceedings of the AAAI Conference on Artificial Intelligence*, 37(5): 6228–6235.
- Aminof, B.; De Giacomo, G.; Sasha, R.; et al. 2021. Best-effort synthesis: Doing your best is not harder than giving up. In *Proceedings of the Thirtieth International Joint Conference on Artificial Intelligence, IJCAI 2021*.
- Apt, K. R. 2011. *A Primer on Strategic Games*, 1–37. Cambridge University Press.
- Baier, C.; and Katoen, J.-P. 2008. *Principles of model checking*. MIT press.
- Berwanger, D. 2007. Admissibility in infinite games. In *Annual Symposium on Theoretical Aspects of Computer Science*, 188–199. Springer.
- Brandenburger, A.; Friedenberg, A.; and Keisler, H. J. 2008. Admissibility in games 1. *Econometrica*, 76(2): 307–352.
- Brenquier, R.; Pérez, G. A.; Raskin, J.-F.; and Sankur, O. 2016. Admissibility in Quantitative Graph Games. In *36th IARCS Annual Conference on Foundations of Software Technology and Theoretical Computer Science (FSTTCS 2016)*, volume 65, 42:1–42:14.
- Brenquier, R.; Raskin, J.-F.; and Sankur, O. 2015. Assume-Admissible Synthesis. In *26th International Conference on Concurrency Theory (CONCUR 2015)*, volume 42 of *Leibniz International Proceedings in Informatics (LIPIcs)*, 100–113.
- Brenquier, R.; Raskin, J.-F.; and Sassolas, M. 2014. The complexity of admissibility in omega-regular games. In *Proceedings of the Joint Meeting of the Twenty-Third EACSL Annual Conference on Computer Science Logic (CSL) and the Twenty-Ninth Annual ACM/IEEE Symposium on Logic in Computer Science (LICS)*, 1–10.
- Brihaye, T.; Geeraerts, G.; Haddad, A.; and Monmege, B. 2017. Pseudopolynomial iterative algorithm to solve total-payoff games and min-cost reachability games. *Acta Informatica*, 54: 85–125.
- Church, A. 1963. Application of recursive arithmetic to the problem of circuit synthesis. *Journal of Symbolic Logic*, 28(4): 289–290.
- De Giacomo, G.; Parretti, G.; and Zhu, S. 2023. Symbolic LTL f Best-Effort Synthesis. In *European Conference on Multi-Agent Systems*, 228–243. Springer.
- De Giacomo, G.; and Vardi, M. Y. 2013. Linear Temporal Logic and Linear Dynamic Logic on Finite Traces. In *Int. Joint Conf. on Artificial Intelligence, IJCAI '13*, 854–860. AAAI Press.
- Faella, M. 2009. Admissible strategies in infinite games over graphs. In *International Symposium on Mathematical Foundations of Computer Science*, 307–318. Springer.
- Filippidis, I.; and Murray, R. M. 2016. Symbolic construction of GR(1) contracts for systems with full information. In *2016 American Control Conference (ACC)*, 782–789.
- Floyd, R. W. 1962. Algorithm 97: shortest path. *Communications of the ACM*, 5(6): 345–345.
- Fuggitti, F. 2019. LTLf2DFA Tool. <http://ltlf2dfa.diag.uniroma1.it>.
- He, K.; Lahijanian, M.; Kavraki, L. E.; and Vardi, M. Y. 2017. Reactive synthesis for finite tasks under resource constraints. In *Int. Conf. on Intel. Robots and Sys.*, 5326–5332.
- Khachiyan, L.; Boros, E.; Borys, K.; Elbassioni, K.; Gurvich, V.; Rudolf, G.; and Zhao, J. 2008. On short paths interdiction problems: Total and node-wise limited interdiction. *Theory of Computing Systems*, 43(2): 204–233.
- Kress-Gazit, H.; Lahijanian, M.; and Raman, V. 2018. Synthesis for Robots: Guarantees and Feedback for Robot Behavior. *Annual Review of Control, Robotics, and Autonomous Systems*, 1(1): 211–236.
- Kupferman, O.; and Vardi, M. Y. 2001. Model checking of safety properties. *Formal Methods in System Design*, 19(3): 291–314.
- Leyton-Brown, K.; and Shoham, Y. 2008. *Further Solution Concepts for Normal-Form Games*, 15–30. Cham: Springer International Publishing. ISBN 978-3-031-01545-8.
- McMahon, J.; Ahmed, N.; Lahijanian, M.; Amorese, P.; Deka, T.; Muvvala, K.; Shakerin, K.; Slack, T.; and Wakayama, S. 2023. REASON-RECOURSE Software for Science Operations of Autonomous Robotic Landers. In *2023 IEEE Aerospace Conference*, 1–11.
- Mehlhorn, K.; and Sanders, P. 2008. *Shortest Paths*, 191–215. Berlin, Heidelberg: Springer Berlin Heidelberg. ISBN 978-3-540-77978-0.
- Muvvala, K.; Amorese, P.; and Lahijanian, M. 2022. Let's Collaborate: Regret-based Reactive Synthesis for Robotic Manipulation. In *2022 International Conference on Robotics and Automation (ICRA)*, 4340–4346.
- Pnueli, A.; and Rosner, R. 1989. On the synthesis of a reactive module. In *Proceedings of the 16th ACM SIGPLAN-SIGACT symposium on Principles of programming languages*, 179–190.
- Watanabe, K.; Renninger, N.; Sankaranarayanan, S.; and Lahijanian, M. 2021. Probabilistic specification learning for planning with safety constraints. In *2021 IEEE/RSJ International Conference on Intelligent Robots and Systems (IROS)*, 6558–6565.
- Zhou, H.; and Foley, S. N. 2003. Fast automatic synthesis of security protocols using backward search. In *Proceedings of the 2003 ACM Workshop on Formal Methods in Security Engineering, FMSE '03*, 1–10. New York, NY, USA: Association for Computing Machinery.

A Appendix

Derivation of Eq. (7) We can simplify Eqs. (6a) and (6b). By definition, $\forall h \in \text{Plays}^v$,

$$\text{aVal}(h, \sigma) \geq \text{aVal}(h) \geq \text{cVal}(h, \sigma).$$

Given strategy σ , in Eq. (6b), it needs to satisfy the condition $\text{aVal}(h, \sigma) \leq \text{aVal}(h)$ for σ to be adversarial-cooperative. Thus, a strategy σ that satisfies $\text{aVal}(h, \sigma) > \text{aVal}(h)$ is not a valid strategy. Hence, $\text{aVal}(h, \sigma) = \text{aVal}(h) > \text{cVal}(h, \sigma)$ or $\text{aVal}(h, \sigma) = \text{aVal}(h) = \text{cVal}(h, \sigma)$. The former is subsumed by Eq. (6a) while the latter is not. Thus by simplifying the equations, we get Eq. (7).

A.1 Proof of Lemma 1

Proof. For the proof, it is sufficient to show a counterexample. In Example 1, for \mathcal{G} in Fig. 2, all states $v \in V \setminus \{v_2, v_3\}$ belong to V_{win} and hence $\text{sVal}(v) = 1$. States v_2 and v_3 belong to V_{pen} thus $\text{sVal}(v_2) = \text{sVal}(v_3) = 0$. Both, σ_2 and σ_3 are admissible strategies as shown in Example 1. But, under σ_3 , the possible plays are, $v_0(v_2v_3)^\omega$, $v_0(v_2v_3)^*v_6$, and $v_0v_2v_6$. Thus, under σ_3 , there exists a play that starts in the winning region and does *not* stay in the winning region. For plays induced by σ_2 , all states in all the plays belong to the winning region. Hence, there exists an admissible strategy that is not value-preserving. \square

A.2 Proof of Lemma 2

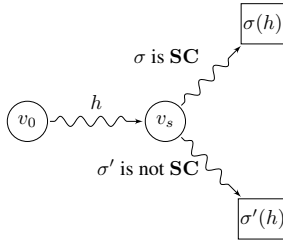

Figure 5: SC proof example

Proof. Let σ be SC. Assume there exists $\sigma' \neq \sigma$ that is compatible with history h , $\text{last}(h) = v_s$, and “splits” at v_s as shown in Fig. 5. Thus, $\sigma(h) \neq \sigma'(h)$. We note that only two cases for a strategy are possible, i.e., it is either SC or not. Further, let’s assume that σ' weakly dominates σ . We prove that σ' can not weakly dominate σ .

Case I $\text{cVal}(h) < \text{aVal}(h)$: As σ' is not SC this implies $\text{cVal}(h, \sigma') \geq \text{aVal}(h)$ and as $\text{cVal}(h, \sigma) \leq \text{aVal}(h, \sigma)$ for any $\sigma \in \Sigma$, we get

$$\text{aVal}(h, \sigma') \geq \text{cVal}(h, \sigma') \geq \text{aVal}(h) > \text{cVal}(h, \sigma).$$

On simplifying, we get $\text{aVal}(h, \sigma') \geq \text{aVal}(h) > \text{cVal}(h, \sigma)$. This statement implies that there exists $\tau \in \mathbb{T}$ such that $\text{Val}(h \cdot P^h(\sigma', \tau)) > \text{Val}(h \cdot P^h(\sigma, \tau))$. Note that since, $\text{Val}(h \cdot P^h(\sigma, \tau)) = \text{Val}(h) + \text{Val}(P^{v_s}(\sigma, \tau))$ we get $\text{Val}(P^{v_s}(\sigma', \tau)) > \text{Val}(P^{v_s}(\sigma, \tau))$. This contradicts the assumption that σ' dominates σ as σ' should always have a payoff that is equal to or lower than σ .

Algorithm 2: Value Iteration

Input : Game \mathcal{G}
Output: Optimal σ_{win}, V_{win}
 /* W - function that maps state to values in $\mathbb{R} \cup \infty$ */

- 1 $W_{win} \leftarrow \infty; W'_{win} \leftarrow \infty;$
- 2 $\sigma_{win} \leftarrow \emptyset;$
- 3 **forall** v in V_f **do** $W_{win}(v) \leftarrow 0;$
 /* Compute Winning region and Winning strategy */
- 4 **while** $W'_{win} \neq W_{win}$ **do**
- 5 $W'_{win} = W_{win}$
- 6 **for** $v \in V \setminus V_f$ **do**
 /* For aVal Value Iteration */
 $W_{win}(v) = \max(C(v, a) + W'_{win}(v'))$ if $v \in V_e$
 /* For cVal Value Iteration */
 $W_{win}(v) = \min(C(v, a) + W'_{win}(v'))$ if $v \in V_e$
 $W_{win}(v) =$
 $\min(C(v, a) + W'_{win}(v'))$ if $v \in V_s$
 $\sigma_{win}(v) =$
 $\arg \min_a(C(v, a) + W'_{win}(v'))$ if $v \in V_s$
- 11 $V_{win} \leftarrow \{v \mid W_{win}(v) \neq \infty \forall v \in V\}$
- 12 **return** σ_{win}, V_{win}

Case II $\text{cVal}(h) = \text{aVal}(h)$: For this case we get,

$$\text{aVal}(h, \sigma') \geq \text{cVal}(h, \sigma') \geq \text{aVal}(h) = \text{cVal}(h) = \text{cVal}(h, \sigma).$$

This implies that $\text{cVal}(h, \sigma') \geq \text{cVal}(h)$. But, since σ' dominates σ , there should exist a strategy $\tau \in \mathbb{T}$ under which σ' does strictly better than σ . Since, $\text{cVal}(h, \sigma') \geq \text{cVal}(h) \forall \tau \in \mathbb{T}$, it implies that there does not exist a payoff $\text{Val}(P^{v_s}(\sigma', \tau))$ that has a payoff strictly less than $\text{cVal}(h, \sigma) = \text{cVal}(h)$. Thus, σ' does not dominate σ .

We can repeat this for all histories h in $\text{Plays}^{v_0}(\sigma)$. Hence, every σ that is SC is admissible. \square

A.3 Proof of Theorem 1

Proof. To prove this it is sufficient to show an example. Consider the game \mathcal{G} in Fig. 6. Let us consider strategies: $\sigma_1 : (v_0 \rightarrow v_1), (v_3 \rightarrow v_6), (v_7 \rightarrow v_8)$, $\sigma_2 : (v_0 \rightarrow v_1), (v_3 \rightarrow v_6), (v_7 \rightarrow v_9)$, $\sigma_3 : (v_0 \rightarrow v_2), (v_4 \rightarrow v_6), (v_7 \rightarrow v_9)$, and $\sigma_4 : (v_0 \rightarrow v_2), (v_4 \rightarrow v_6), (v_7 \rightarrow v_8)$. Note, σ_1, σ_2 and σ_3, σ_4 only differ at state v_7 . Further, \mathcal{G} is a tree-like arena where we define payoff as follows, if $\text{last}(h)$ is a leaf node, then $\text{Val}(\text{last}(h)) > 0$ else, it is 0. Thus, the payoff function is history-independent, i.e., $\text{Val}(h) = \text{Val}(\text{last}(h))$. Hence, it is sufficient to look at the last state along h to compute optimal adversarial and cooperative values, i.e., $\text{aVal}(h) = \text{aVal}(\text{last}(h))$ and $\text{cVal}(h) = \text{cVal}(\text{last}(h))$.

For the play induced by σ_1 ,
 $\text{cVal}(v_0, \sigma_1) < \text{aVal}(v_0), \text{cVal}(v_0v_1v_3, \sigma_1) <$

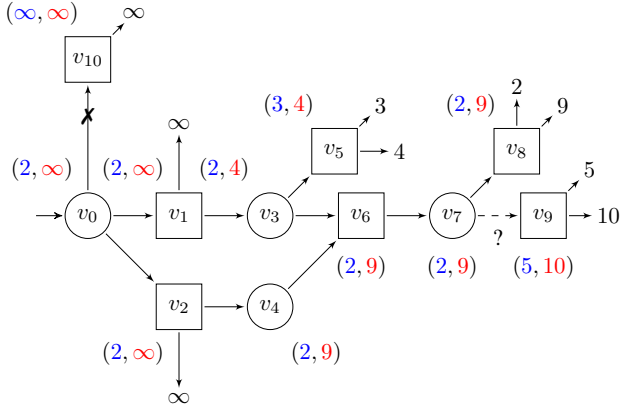

Figure 6: Illustrative example \mathcal{G} : for all $h \in \text{Plays}^{v_0}$ we define $\text{Val} = 0$ if $\text{last}(h)$ is not leaf node else $\text{Val} > 0$. The payoffs associated with plays are shown along the edges in black. The values in blue and red are $c\text{Val}(v)$ and $a\text{Val}(v)$.

$a\text{Val}(v_0v_1v_3), \dots, c\text{Val}(v_0v_1v_3v_6v_7, \sigma_1) < a\text{Val}(v_0v_1v_3v_6v_7)$. Thus, $c\text{Val}(h, \sigma_1) < a\text{Val}(h)$ for all the histories h compatible with σ_1 . For the play induced by σ_2 , $c\text{Val}(v_0, \sigma_2) < a\text{Val}(v_0)$, but $c\text{Val}(v_0v_1v_3, \sigma_2) > a\text{Val}(v_0v_1v_3)$. Notice that $c\text{Val}(v_0v_1v_3v_6, \sigma_2) < a\text{Val}(v_0v_1v_3v_6)$ and thus we need to check admissibility for all histories h compatible with σ . Hence, for history $h := v_0v_1v_3$, σ_2 is not **SC**. If $h = v_0v_2v_4v_6$, then strategy σ_3 and σ_4 are both admissible. Thus, σ_3 and σ_4 are both **SC** strategies. This proves that **SC** strategies are history-dependent. \square

A.4 Proof of Lemma 3

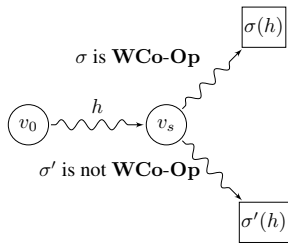

Figure 7: **WCo-Op** proof example

Proof. Let σ be a **WCo-Op**. Assume there exists $\sigma' \neq \sigma$ that is compatible with history h , $\text{last}(h) = v_s$, and “splits” at v_s as shown in Figure 7. Thus, $\sigma(h) \neq \sigma'(h)$. We note that only two cases for a strategy are possible, i.e., it is either **WCo-Op** or not. Further, let’s assume that σ' weakly dominates σ . We prove that σ' can not weakly dominate σ .

We first note that, by definition, we have $a\text{Val}(h, \sigma) \geq a\text{Val}(h)$ for all $\sigma \in \Sigma$. If $a\text{Val}(h, \sigma) = a\text{Val}(h)$ then it is

WCO else it is not. For strategy σ' compatible with h ,

$$\neg \mathbf{WCo-Op} \implies \left(a\text{Val}(h, \sigma') > a\text{Val}(h) \vee \left(a\text{Val}(h, \sigma') = a\text{Val}(h) \wedge c\text{Val}(h, \sigma') \neq ac\text{Val}(h) \right) \right).$$

Case I σ' is not **WCO**: This implies that $a\text{Val}(h) \neq a\text{Val}(h, \sigma')$. As σ' is not **WCO**, it implies that there exists an adversarial strategy $\tau \in \mathbf{T}$ for which the payoff $\text{Val}(h \cdot P^{v_s}(\sigma', \tau)) > \text{Val}(h \cdot P^{v_s}(\sigma, \tau))$. Since, $\text{Val}(h \cdot P^{v_s}(\sigma, \tau)) = \text{Val}(h) + \text{Val}(P^{v_s}(\sigma, \tau))$, we get $\text{Val}(P^{v_s}(\sigma', \tau)) > \text{Val}(P^{v_s}(\sigma, \tau))$. This contradicts our assumption that $\sigma' \succ \sigma$ as σ' should never do worse than σ .

Case II σ' is **WCO** but $c\text{Val}(h, \sigma') \neq ac\text{Val}(h)$: For this case we have $a\text{Val}(h) = a\text{Val}(h, \sigma') \geq c\text{Val}(h, \sigma') \wedge c\text{Val}(h, \sigma') > c\text{Val}(h, \sigma) = ac\text{Val}(h)$. This implies that there exists a play under σ such that payoff $\text{Val}(P^{v_s}(\sigma, \tau)) < \text{Val}(P^{v_s}(\sigma', \tau))$. This contradicts our statement as $\sigma \succ \sigma'$.

Thus, every strategy that is **WCo-Op** is admissible. \square

A.5 Proof of Theorem 2

Proof. We begin by showing that memoryless strategies are sufficient for optimal $c\text{Val}$ and $a\text{Val}$. For **Co-Op** strategies, the game can be viewed as a single-player as both players are playing cooperatively. Thus, synthesizing a witnessing strategy σ for **Co-Op** reduces to the classical shortest path problem in a weighted graph. This can be solved in polynomial time using Dijkstra’s and Floyd Warshall’s algorithms when the weights are non-negative and arbitrary (Floyd 1962; Mehlhorn and Sanders 2008).

In the adversarial setting, Khachiyan et al. (2008) show that memoryless strategies are sufficient for two-player, non-negative weights scenario. Thus, we have that $c\text{Val}(h, \sigma) = c\text{Val}(\text{last}(h), \sigma)$ for **Co-Op** and $a\text{Val}(h, \sigma) = a\text{Val}(\text{last}(h), \sigma)$ for **WCO**.

Next, we show that for a given history h , memoryless strategies are sufficient to be optimal adversarial-cooperative. We show this by proving that $c\text{Val}(\text{last}(h), \sigma) = ac\text{Val}(h)$. Given history h , we define $a\text{Val}(\mathcal{G}, h)$ and $c\text{Val}(\mathcal{G}, h)$ to be the optional adversarial and cooperative value in \mathcal{G} . We extend the definition to $ac\text{Val}(\mathcal{G}, h)$ accordingly. We denote by $\Sigma(\mathcal{G})$ and $\mathbf{T}(\mathcal{G})$ the set of all valid strategies in \mathcal{G} .

Given \mathcal{G} , history h , we define \mathcal{G}' to be the subgame such that the initial state in \mathcal{G}' is $\text{last}(h)$ and every state in \mathcal{G}' satisfies condition $a\text{Val}(\mathcal{G}, v) \leq a\text{Val}(\mathcal{G}, h) \forall v \in V$. We note that $a\text{Val}(\mathcal{G}, v_f) = c\text{Val}(\mathcal{G}, v_f) = 0$ and $a\text{Val}(\mathcal{G}, v) \geq c\text{Val}(\mathcal{G}, v) \neq 0 \forall v \notin V_f$. Thus, every subgame \mathcal{G}' will include the goal states $v \in V_f$. As \mathcal{G}' is the subgame of \mathcal{G} the strategies in \mathcal{G}' can be uniquely mapped to \mathcal{G} . Notice that $\Sigma(\mathcal{G}') \subseteq \Sigma(\mathcal{G})$ where $\Sigma(\mathcal{G}')$ is the set of all valid strategies in \mathcal{G}' . The weights of the edges in \mathcal{G}' are the same as \mathcal{G} .

First, we will show that every state that is reachable in \mathcal{G}' has at least one outgoing edge. Next, we will show that the cooperative value of \mathcal{G}' at the initial state $\text{last}(h)$ is exactly the optimal adversarial-cooperative value of h in \mathcal{G} ,

i.e., $cVal(\mathcal{G}', \text{last}(h)) = acVal(\mathcal{G}', \text{last}(h)) = acVal(\mathcal{G}, h)$. As memoryless strategies are sufficient for optimal cooperative value and strategies in \mathcal{G}' can be uniquely mapped to \mathcal{G} , we will conclude that memoryless strategies are sufficient to be optimal **WCo-Op** strategy.

Every reachable vertex in \mathcal{G}' has at least one outgoing edge: By Thm. 4, given \mathcal{G} , history h , there always exists a witnessing strategy σ such that $aVal(\mathcal{G}, h, \sigma) \leq aVal(\mathcal{G}, h)$. By construction, we have that $aVal(\mathcal{G}', v) \leq aVal(\mathcal{G}, h)$. If v is a Sys player state in \mathcal{G}' , then there always exists an action that corresponds to σ such that $\sigma(v)$ is a valid edge in \mathcal{G}' . If v is a state \mathcal{G}' and belongs to V_e then, by definition, for all the valid actions a_e , $aVal(\mathcal{G}', v') \leq aVal(\mathcal{G}', v)$ where $v' = \delta(v, a_e)$. Thus, all edges from $v \in V_e$ will be present in \mathcal{G}' . Thus, any vertex reachable from $\text{last}(h)$ has at least one outgoing edge in \mathcal{G}' .

For any history h , $cVal(\mathcal{G}', \text{last}(h)) = acVal(\mathcal{G}, h)$: We first observe that any state whose $aVal(\mathcal{G}, v) > aVal(\mathcal{G}, h)$, will not be present in \mathcal{G}' . Thus, for any prefix h' of the plays starting from $\text{last}(h)$ in \mathcal{G}' , will have their $aVal(\mathcal{G}', \text{last}(h')) \leq aVal(\mathcal{G}, h)$. Further, all the plays that satisfy the $acVal(\mathcal{G}, h)$ condition will be captured in \mathcal{G}' too. Thus, $acVal(\mathcal{G}', \text{last}(h)) = acVal(\mathcal{G}, h)$. Now, consider alternate strategy $\sigma' \neq \sigma$ where $\sigma', \sigma \in \Sigma(\mathcal{G}')$. We note that both σ and σ' are valid strategies in \mathcal{G} too. Here σ is a strategy such that $aVal(\mathcal{G}', v, \sigma) \leq aVal(\mathcal{G}, h)$. σ' can be **Co-Op** optimal in \mathcal{G} , i.e., $cVal(\mathcal{G}, h, \sigma') < acVal(\mathcal{G}, h)$, but $aVal(\mathcal{G}, h, \sigma') > aVal(\mathcal{G}, h)$ by definition of adversarial-cooperative value. As, $aVal(\mathcal{G}, h, \sigma') > aVal(\mathcal{G}, h)$, the state $\sigma'(h)$ will not be present in \mathcal{G}' . Inductively, for every history h' , starting from $\text{last}(h)$ in \mathcal{G}' , we have that $\sigma'(h')$ will not be present in \mathcal{G}' . As every state that belongs $\sigma'(h')$ does not exist in \mathcal{G}' , $cVal(\mathcal{G}', \text{last}(h')) \not\leq acVal(\mathcal{G}, h)$. Further, $cVal(\mathcal{G}', \text{last}(h')) \not\leq acVal(\mathcal{G}, h)$ as $cVal(\mathcal{G}', \text{last}(h')) > acVal(\mathcal{G}, h) \implies aVal(\mathcal{G}', \text{last}(h')) > acVal(\mathcal{G}, h)$. This contradicts \mathcal{G}' by construction. Thus, $cVal(\mathcal{G}', \text{last}(h)) = acVal(\mathcal{G}, h)$. Since, $acVal(\mathcal{G}', \text{last}(h)) = acVal(\mathcal{G}, h)$ we get $cVal(\mathcal{G}', \text{last}(h)) = acVal(\mathcal{G}', \text{last}(h)) = acVal(\mathcal{G}, h)$. As memoryless strategies are sufficient for witnessing optimal cooperative value, this implies that memoryless strategies are sufficient for a strategy to be adversarial-cooperative optimal.

Since memoryless strategies are sufficient for **WCO** conditions and adversarial-cooperative optimal conditions, this implies that memoryless strategies are sufficient for **WCo-Op** strategies. \square

A.6 Proof of Theorem 3

Proof. Given an admissible strategy σ , and prefix $h \in \text{Plays}^{v_0}(\sigma)$, we want to prove that $\sigma \iff \text{SC} \vee \text{WCo-Op}$, i.e., σ is the witnessing strategies that satisfies **SC** or **WCo-Op** conditions.

We will prove the statement using the following tautology

$$(A \iff B) \iff [(B \implies A) \wedge (\neg B \implies \neg A)]$$

where A is the logical statement that σ is admissible and B is the logical statement that implies that ei-

ther $cVal(h, \sigma) < aVal(h)$ or $aVal(h) = aVal(h, \sigma) = cVal(h, \sigma) = acVal(h, \sigma)$ is true. Note that all the plays in the game start from v_0 , and thus, all prefixes start from v_0 .

Case I: ($\neg B \implies \neg A$) $\neg B$ is equivalent to Eq. (8). Let Eq. (8a) hold, i.e., $cVal(h, \sigma) \geq aVal(h) \wedge aVal(h, \sigma) > aVal(h)$. Let us assume that there exists $\sigma' \neq \sigma$, which is compatible with prefix h and is **WCO** afterward. That is, σ' is the witnessing strategy for **WCO** after prefix h and thus $aVal(h, \sigma') = aVal(h)$. We now claim that σ' weakly dominates σ .

For σ' to weakly dominate σ , it needs to have a payoff always lower than or equal to the payoff associated with σ . Since $aVal(h, \sigma) > aVal(h) = aVal(h, \sigma')$ that means there exists a $\tau \in T$ for which $Val(h \cdot P^h(\sigma', \tau)) < Val(h \cdot P^h(\sigma, \tau))$. Further, we have that $cVal(h, \sigma) \geq aVal(h, \sigma')$ which implies that for any $\tau \in T$ which is compatible with prefix h , the payoff $Val(h \cdot P^h(\sigma, \tau)) \geq Val(h \cdot P^h(\sigma', \tau))$. Since, $Val(h \cdot P^h(\sigma, \tau)) = Val(h) + Val(P^h(\sigma, \tau))$, we get $Val(P^h(\sigma, \tau)) \geq Val(P^h(\sigma', \tau))$ for all $\tau \in T$. Thus, for all Env player strategies, the payoff associated with σ' is less than or equal to σ . Thus, σ' weakly dominates σ .

Now, let Eq. (8b) hold, i.e., $aVal(h) = aVal(h, \sigma) = cVal(h, \sigma) \wedge acVal(h) < aVal(h)$. By definition of $acVal(h)$, there exists σ' that is **WCo-Op** and $\sigma' \neq \sigma$ such that $cVal(h, \sigma') = acVal(h)$ and $cVal(h, \sigma') < aVal(h)$ and σ' is compatible with prefix h . This implies that for some $\tau \in T$ which is compatible with prefix h , the payoff $Val(h \cdot P^h(\sigma', \tau)) < Val(h \cdot P^h(\sigma, \tau)) \implies Val(P^h(\sigma', \tau)) < Val(P^h(\sigma, \tau))$. Further, $aVal(h, \sigma') \leq aVal(h) = cVal(h, \sigma)$. This implies that for all $\tau \in T$ compatible with prefix h , $Val(h \cdot P^h(\sigma', \tau)) \leq Val(h \cdot P^h(\sigma, \tau)) \implies Val(P^h(\sigma', \tau)) \leq Val(P^h(\sigma, \tau))$. Hence, σ' weakly dominates σ .

Case II: ($B \implies A$) Assume that for all prefixes h of $\text{Plays}^{v_0}(\sigma)$ we have that Eq. (7) holds such that σ is the witnessing strategy for **SC** or **WCo-Op**. Now, let σ' be another strategy which is compatible with prefix h but “splits” at h , i.e., $\sigma(h) \neq \sigma'(h)$. Let us assume that σ' weakly dominates σ . We will show a contradiction.

Let Eq. (6a) hold, i.e., σ is **SC** and σ' is not. We can use Lemma 2 to show that σ' does not weakly dominate σ . Similarly, if Eq. (6b) holds, then σ is **WCo-Op**. As Eq. (6a) does not hold, therefore Eq. (6b) must hold. We can use Lemma 3 to show that σ' does not weakly dominate σ . Thus, σ' does not weakly dominate σ and hence σ is admissible.

Since we have shown both ($\neg B \implies \neg A$) and ($B \implies A$), hence, for all prefixes starting from v_0 , Eqs. (6a) and (6b) are necessary and sufficient conditions for strategy σ to be admissible. \square

A.7 Proof of Lemma 4

Proof. We need to prove that $\neg \text{Eq. (7)} \equiv \text{Eq. (8)}$. To prove this, we prove that $\neg \text{Eq. (8)} \equiv \text{Eq. (7)}$.

We first observe that,

$$\neg(\text{Eq. (8a)} \vee \text{Eq. (8b)}) = \neg \text{Eq. (8a)} \wedge \neg \text{Eq. (8b)}.$$

where,

$$\neg \text{Eq. (8a)} = c\text{Val}(h, \sigma) < a\text{Val}(h) \vee a\text{Val}(h, \sigma) \leq a\text{Val}(h)$$

By rewriting the equation, we get

$$\begin{aligned} c\text{Val}(h, \sigma) < a\text{Val}(h) \\ \vee (c\text{Val}(h, \sigma) \geq a\text{Val}(h) \wedge a\text{Val}(h, \sigma) \leq a\text{Val}(h)) \end{aligned}$$

Rearranging the term inside the bracket, we get, $a\text{Val}(h, \sigma) \leq a\text{Val}(h) \leq c\text{Val}(h, \sigma)$. Since, $a\text{Val}(h, \sigma) \geq c\text{Val}(h, \sigma)$ for any h , we get $a\text{Val}(h, \sigma) = a\text{Val}(h) = c\text{Val}(h, \sigma)$. Thus, $\neg \text{Eq. (8a)}$ is

$$c\text{Val}(h, \sigma) < a\text{Val}(h) \vee (a\text{Val}(h, \sigma) = a\text{Val}(h) = c\text{Val}(h, \sigma)) \quad (11)$$

Now, let us take the negation of Eq. (8b). Thus,

$$\begin{aligned} \neg [a\text{Val}(h) = a\text{Val}(h, \sigma) = c\text{Val}(h, \sigma)] \\ \vee \neg [ac\text{Val}(h) < a\text{Val}(h)] \end{aligned}$$

On simplifying $\neg \text{Eq. (8b)}$, we get

$$\begin{aligned} [a\text{Val}(h) = a\text{Val}(h, \sigma) = c\text{Val}(h, \sigma)] \\ \implies \neg [ac\text{Val}(h) < a\text{Val}(h)] \\ a\text{Val}(h) = a\text{Val}(h, \sigma) = c\text{Val}(h, \sigma) \implies ac\text{Val}(h) \geq a\text{Val}(h) \quad (12) \end{aligned}$$

By substituting values for $\neg \text{Eq. (8a)} \wedge \neg \text{Eq. (8b)}$, we get

$$\begin{aligned} c\text{Val}(h, \sigma) < a\text{Val}(h) \vee \\ (a\text{Val}(h, \sigma) = a\text{Val}(h) = c\text{Val}(h, \sigma)) \wedge \\ (a\text{Val}(h) = a\text{Val}(h, \sigma) = c\text{Val}(h, \sigma) \implies \\ ac\text{Val}(h) \geq a\text{Val}(h)) \\ c\text{Val}(h, \sigma) < a\text{Val}(h) \vee (a\text{Val}(h, \sigma) = a\text{Val}(h) = c\text{Val}(h, \sigma) \\ \wedge a\text{Val}(h) = a\text{Val}(h, \sigma) = c\text{Val}(h, \sigma) \\ \implies ac\text{Val}(h) \geq a\text{Val}(h)) \end{aligned}$$

On simplifying,

$$\begin{aligned} c\text{Val}(h, \sigma) < a\text{Val}(h) \vee (a\text{Val}(h) = a\text{Val}(h, \sigma) = c\text{Val}(h, \sigma) \\ \implies ac\text{Val}(h) \geq a\text{Val}(h)) \end{aligned}$$

By definition, $ac\text{Val}(h) \leq a\text{Val}(h)$. Thus, we can simplify the equation to be

$$\begin{aligned} (c\text{Val}(h, \sigma) < a\text{Val}(h)) \vee \\ (a\text{Val}(h) = a\text{Val}(h, \sigma) = c\text{Val}(h, \sigma) = ac\text{Val}(h)) \end{aligned}$$

Hence, we get that $\neg \text{Eq. (8)} = \text{Eq. (7)}$. \square

Algorithm 3: Admissible Synthesis

Input : Game \mathcal{G} , Budget \mathcal{B}
Output: Strategy Σ_{adm}

```

1  $\mathcal{G}' \leftarrow$  Unroll  $\mathcal{G}$  up until Payoff  $\mathcal{B}$ 
  /* VI from Alg. 2 */
2  $a\text{Val} \leftarrow$  min-max ValueIteration ( $\mathcal{G}'$ )
3  $c\text{Val} \leftarrow$  min-min ValueIteration ( $\mathcal{G}'$ )
4 for  $v \in V_s$  in  $\mathcal{G}'$  do
5    $ac\text{Val}(v) = \min\{c\text{Val}(v') \mid a\text{Val}(v') \leq$ 
      $a\text{Val}(v) \text{ where } v' \text{ is valid successor(s)}\}$ 
6 if  $\mathcal{B} < c\text{Val}(v_0)$  then
7   return  $\Sigma_{adm} := \Sigma$ 
  /* Compute Admissible strategies-DFS */
8  $h; a\text{Values} \leftarrow$  initialize empty stack
9  $h.\text{push}((v_0, \{\delta(v_0, a_s)\}))$ 
10  $a\text{Values}.\text{push}(a\text{Val}(v_0))$ 
11 while  $h \neq \emptyset$  do
12    $v, \{v'\} \leftarrow h[-1]$ 
13   try:
14      $v' \leftarrow \text{next}(\text{iter}(\{v'\}))$ 
15     if  $v \in V_s$  then
16       forall  $s$  in  $h$  do  $hist := [s[0]];$ 
17       if  $c\text{Val}(v') < \min\{a\text{Values}\}$  then
18          $h.\text{push}((v', \{\delta(v', a_e)\}))$ 
19          $\Sigma_{adm} : hist \rightarrow v'$ 
20          $a\text{Values}.\text{push}(a\text{Val}(v'))$ 
21       else if  $a\text{Val}(v) = a\text{Val}(v') = c\text{Val}(v') =$ 
          $ac\text{Val}(v)$  then
22          $h.\text{push}((v', \{\delta(v', a_e)\}))$ 
23          $\Sigma_{adm} : hist \rightarrow v'$ 
24          $a\text{Values}.\text{push}(a\text{Val}(v'))$ 
25       if  $v \in V_e$  then
26          $h.\text{push}((v', \{\delta(v', a_s)\}))$ 
27          $a\text{Values}.\text{push}(a\text{Val}(v'))$ 
28     catch StopIteration:
29        $h.\text{pop}()$ 
30        $a\text{Values}.\text{pop}()$ 
31 return  $\Sigma_{adm}$ 

```

A.8 Proof of Theorem 4

Proof. The result follows from Thm. 3 that states that **SC** or **WCo-Op** are necessary and sufficient conditions for a strategy to be admissible. Using the results of (Brihaye et al. 2017, Thm. 1), we show that the value iteration algorithm on \mathcal{G} will converge after finite iterations to a fixed point. Then, using (Brihaye et al. 2017, Corollary 18 and Proposition 19), we prove that witnessing strategies for **WCO** and **Co-Op** always exists.

Further, from Thm. 2, we know that for any history h , $ac\text{Val}(h)$ is same as the optimal cooperative value in the sub-game starting from $\text{last}(h)$. Thus, witnessing strategies for **WCO** and **Co-Op** are sufficient conditions for

WCo-Op always exist.

Let us now define Strongly Cooperative Optimal strategy (**SCO**). See Def. 13 for a formal definition. A strategy that is **SCO** is also **SC** by definition. Thus, it suffices for us to prove that **SCO** always exists to show that **SC** always exists. For any history h , **SCO** is a strategy such that if $cVal(h) < aVal(h)$ then $cVal(h, \sigma) = cVal(h)$ and if $cVal(h) = aVal(h)$ then $aVal(h, \sigma) = aVal(h)$. We observe that $cVal(h, \sigma) = cVal(h)$ is definition for **Co-Op** and by definition $cVal(h) \leq aVal(h)$ and thus $cVal(h, \sigma) \leq aVal(h)$. As witnessing strategy for **Co-Op** always exists, **SCO** strategies always exist. Thus, **SC** always exists.

As **SC** and **WCo-Op** are necessary and sufficient (from Thm. 4), we conclude that admissible strategies always exist. \square

A.9 Note on Theorem 4

Brihaye et al., Corollary 18 is the proof for the existence of finite memory strategy for Sys player when the values of every state, after running the value iteration algorithm, are finite, i.e., not $\pm\infty$. When the weights in \mathcal{G} are non-negative, we can compute witnessing *optimal memoryless* strategies for **WCO** and **Co-Op** (Khachiyan et al. 2008). This is because there does not exist Negative-Cycle (NC) plays (plays whose payoff is negative) in \mathcal{G} that can “fool” the Sys player to choose NC plays rather than reaching the goal state (Brihaye et al. 2017). For states that belong to V_{los} , all valid actions from every state belong to an optimal strategy. If $v_0 \in V_{win}$, then an optimal memoryless strategy σ exists which is **WCO** such that $aVal(v_0, \sigma) < \infty$. If $v \notin V_{win}$, then Sys player is “trapped,” and there does not exist a strategy that enforces reaching a goal state. From such states, $aVal(v, \sigma) = \infty \forall \sigma \in \Sigma$. If $v_0 \in V_{pen}$, then an optimal memoryless strategy σ exists which is **Co-Op** such that $cVal(v_0, \sigma) < \infty$. If $v \in V_{los}$ then $cVal(v, \sigma) = aVal(v, \sigma) = \infty$ by definition and thus under no strategy for Sys and Env player can the play ever reach a goal state. Thus, a worst-case optimal strategy for Sys player picks an action indifferently when it is not in the winning region.

A.10 Proof of Lemma 5

Proof. We first show that Val is indeed history-independent on \mathcal{G}' . For all h in \mathcal{G}' , such that $last(h)$ is a not leaf node, as all the weights in \mathcal{G}' are 0, the payoff value for any prefix of history h is exactly 0. Informally, A history-independent Val is a function such that the payoff is independent of the sequence of states visited. Formally, $Val(h_{\leq j}) = Val(h) \forall j \in \mathbb{N}_{\leq |h|-1}$. Here, $h_{\leq j}$ is a finite prefix of h until the $(j+1)^{th}$ state, and $\mathbb{N}_{\leq k}$ is the set of natural numbers smaller or equal to k .

For all histories h , in \mathcal{G}' , such that $last(h)$ is a leaf node, by construction, the payoff is associated with the last state, i.e., $Val(h) = Val(last(h))$. Specifically, $Val(h) = Val(last(h)) \leq \mathcal{B}$ if the leaf node is a goal state for the Sys player else $Val(h) = Val(last(h)) = \infty$. Thus,

$$\begin{aligned} cVal(h) &= \min_{\sigma \in \Sigma} \min_{\tau \in T} Val(last(P^{v_0}(\sigma, \tau))) \\ aVal(h) &= \min_{\sigma \in \Sigma} \max_{\tau \in T} Val(last(P^{v_0}(\sigma, \tau))) \end{aligned}$$

From above, we have that $aVal(h) = aVal(last(h))$ and $cVal(h) = cVal(last(h))$, and $acVal(h) = \min\{cVal(last(h), \sigma) | \sigma \in \Sigma, aVal(last(h), \sigma) \leq aVal(last(h))\}$. Thus, for $v' := \sigma(h)$, we can rewrite Eq. (6b) and get Eq. (9b).

While it is sufficient to look only at the last state along a history h to compute $aVal$, for **SC** condition, $cVal(v') < aVal(last(h))$ does not imply that $cVal(v') < aVal(h_{\leq j}) \forall j \in \mathbb{N}_{|h|-1}$. This is also evident from Figure 6 where the adversarial values for Sys player states along $h := v_0 v_1 v_3 v_6 v_7$ and $v' := v_9$ is $aVal(v_0) = \infty$; $aVal(v_3) = 4$; $aVal(v_7) = 9$. While $cVal(v_9) < aVal(v_7)$, $cVal(v_9) > aVal(v_3)$.

Thus, we need to check if $cVal(v') < aVal(v)$ ($\iff cVal(v') < \min\{aVal(v)\}$) for all Sys player states along h to check for admissibility of strategy σ compatible with h . As $aVal$ is history-independent, there are finitely many adversarial values for a given graph \mathcal{G}' , and thus $\{aVal(v)\}$ is finite in size.

For **WCo-Op** condition, it is sufficient to evaluate $acVal$, $aVal$, and $cVal$ at $last(h)$ to compute the corresponding optimal values for payoff independent functions. Thus, to check if $aVal(h) = aVal(h, \sigma)$ it suffices to check $aVal(last(h)) = aVal(last(h), \sigma)$. We can make the same argument for $cVal(last(h), \sigma) = acVal(last(h))$. Hence, we get the equations in Lemma 5. \square

A.11 Proof of Theorem 5

Proof. Let us define $aVal(\mathcal{G}, v)$ and $cVal(\mathcal{G}, v)$ to be the optional adversarial and cooperative value for state v in \mathcal{G} . We extend the definition to $acVal(\mathcal{G}, v)$ accordingly. We begin our proof by first noting that \mathcal{G}' is a finite tree arena where the leaf nodes are partitioned into goal states for the Sys player and sink states. By construction, every state that is not a leaf node in \mathcal{G}' has at least one outgoing edge. Only plays that reach a goal state in \mathcal{G}' have a finite payoff value. Plays that fail to reach a goal state have a payoff of $+\infty$. Thus, using Khachiyan et al. (2008)’s algorithm, we can compute optimal $aVal(\mathcal{G}', v)$ and $cVal(\mathcal{G}', v)$ and the corresponding witnessing strategies. Thus, game \mathcal{G}' is well-formed, which implies **SC** and **WCo-Op** always exists (from Thm. 4). Hence, there always exists an admissible strategy in \mathcal{G}' .

Next, using Lemma 5, we see that the payoff function for \mathcal{G}' is history-independent. Thus, checking for admissibility along a play reduces to checking for the adversarial and cooperative values at each state along a play \mathcal{G}' . If $\mathcal{B} < cVal(\mathcal{G}, v_0)$, then there does not exist a play that reaches a goal state in \mathcal{G}' . Hence, $aVal(\mathcal{G}', v) = cVal(\mathcal{G}', v) = +\infty \forall v \in V$ and every valid action from every state is part of a strategy that is admissible. The Sys player may choose σ indifferently in such cases. If $\mathcal{B} \geq cVal(\mathcal{G}, v_0)$, there exists at least one play for which the payoff is finite. Hence, there exist states along such plays for which $cVal(\mathcal{G}', v) \neq \infty$ and for all states $aVal(\mathcal{G}', v) \leq \infty$ for every play.

In Thm. 1, we show that even for a tree-like arena whose payoff function is also history-independent, the admissibility of an action depends on the history. As a consequence of Corollary 1, we use Depth First Search (DFS) based approach to explore nodes along each play until all the

Algorithm 4: Admissible Winning Synthesis

Input : Game \mathcal{G} , Budget \mathcal{B}
Output: Strategy Σ_{adm}^{win}

```
1  $\mathcal{G}' \leftarrow$  Unroll  $\mathcal{G}$  up until Payoff  $\mathcal{B}$ 
  /* VI from Alg. 2 */
2 aVal;  $V_{win} \leftarrow$  min-max ValueIteration ( $\mathcal{G}'$ )
3 cVal  $\leftarrow$  min-min ValueIteration ( $\mathcal{G}'$ )
4 for  $v \in V_s$  in  $\mathcal{G}'$  do
5   acVal( $v$ ) = min{cVal( $v'$ ) | aVal( $v'$ )  $\leq$ 
   aVal( $v$ ) where  $v'$  is valid successor(s)}
6 if  $\mathcal{B} <$  cVal( $v_0$ ) then
7   return  $\Sigma_{adm}^{win} := \Sigma$ 
  /* Compute Admissible strategies-DFS */
8  $h, aValues \leftarrow$  initialize empty stack
9  $h.push((v_0, \{\delta(v_0, a_s)\}))$ 
10  $aValues.push(aVal(v_0))$ 
11 while  $h \neq \emptyset$  do
12    $v, \{v'\} \leftarrow h[-1]$ 
13   try:
14      $v' \leftarrow$  next(iter( $\{v'\}$ ))
15     if  $v \in V_s$  then
16       forall  $s$  in  $h$  do  $hist := [s[0]]$ ;
17       if cVal( $v'$ )  $<$  min{aValues} then
18         if  $\neg(v \in V_{win}) \vee (v' \in V_{win})$  then
19            $h.push((v', \{\delta(v', a_e)\}))$ 
20            $\Sigma_{adm}^{win} : hist \rightarrow v'$ 
21            $aValues.push(aVal(v'))$ 
22         else if aVal( $v$ ) = aVal( $v'$ ) = cVal( $v'$ ) =
23         acVal( $v$ ) then
24            $h.push((v', \{\delta(v', a_e)\}))$ 
25            $\Sigma_{adm}^{win} : hist \rightarrow v'$ 
26            $aValues.push(aVal(v'))$ 
27         if  $v \in V_e$  then
28            $h.push((v', \{\delta(v', a_s)\}))$ 
29            $aValues.push(aVal(v'))$ 
29   catch StopIteration:
30      $h.pop()$ 
31      $aValues.pop()$ 
32 return  $\Sigma_{adm}^{win}$ 
```

nodes are explored. At each state, we check if the **SC** or **WCo-Op** conditions are satisfied. If yes, then we add that history and the corresponding successor state as an admissible strategy to the set of all admissible strategies. Alg. 1 returns such a strategy, and hence, the strategy returned is correct. \square

A.12 Proof of Lemma 6

Proof. Given \mathcal{G} , the initial state of the game can belong to three regions. Thus, v_0 is either part of the losing, pending,

Qualitative	Quantitative	
	SC	WCo-Op
$-1 \rightarrow -1$	$-1 \rightarrow -1$	$-1 \rightarrow -1$
$0 \rightarrow 0, 1$	$0 \rightarrow 0, 1$	$0 \rightarrow 0, 1$
$1 \rightarrow 1$	$1 \rightarrow 1, 0$	$1 \rightarrow 1$

Table 2: Value preservation: In qualitative settings, an admissible strategy never decreases its value. In quantitative settings, an admissible strategy **SC** can decrease its state value (in red).

or winning region. From Thm. 3, a strategy σ is admissible if, and only if, it is **SC** or **WCo-Op**.

Case I: $v_0 \in V_{los}$ By definition, there does not exist a play that reaches the goal state from v_0 . Thus, for all histories h , $cVal(h) = aVal(h) = \infty$. If σ is **SC** then $cVal(h, \sigma) = aVal(h)$ which is true for every strategy in \mathcal{G} . Thus, if $v_0 \in V_{los}$ then every strategy is **SC** strategy. If σ is **WCo-Op**, then $aVal(h) = aVal(h, \sigma)$ and $cVal(h, \sigma) = acVal(h)$. Since, for all histories h , $aVal(h) = cVal(h) = \infty$ we have that $acVal(h, \sigma) = \infty$. Thus, every action from every state in \mathcal{G} belongs to an admissible strategy σ that is **WCo-Op**.

Case II: $v_0 \in V_{pen}$ If $v_0 \in V_{pen}$, then there exists a play that reaches the goal state in \mathcal{G} . If σ is **SC** then it must satisfy, either $cVal(h, \sigma) < aVal(h)$ or $cVal(h, \sigma) = aVal(h, \sigma) = aVal(h)$. We note that $cVal(v) < \infty$ and $aVal(v) = \infty$ for all $v \in V_{pen}$. Let $last(h) \in V_{pen}$, then $cVal(h) < aVal(h)$. If $\sigma(h) \in V_{los}$, then $cVal(h, \sigma) = \infty \not< aVal(h)$ thus σ is not **SC** strategy. For any prefix h that ends in Sys player state in the pending region, if σ is **SC**, then $\sigma(h) \in V_{win} \cup V_{pen}$. Thus, $sVal(v) \in \{0, 1\}$ for all states in plays induced by strategy σ which is **SC**.

Let σ be **WCo-Op** strategy and $h \in Plays^{v_0}(\sigma)$ such that $last(h) \in V_{pen}$. Then, by definition, if $\sigma(h) \in V_{los}$ then $cVal(h, \sigma) \neq acVal(h)$ as $cVal(h, \sigma) = \infty$ for all prefixes h . Thus, if σ is **WCo-Op** strategy then $\sigma(h) \in V_{pen} \cup V_{win}$. Thus, $sVal(v) \in \{0, 1\}$ for all states in plays induced by strategy σ which is **WCo-Op**. Hence, every strategy that is **SC** or **WCo-Op** is value preserving if $last(h) \in V_{pen}$.

Case III: $v_0 \in V_{win}$ For this case, there exists a winning strategy σ_{win} from the initial state. Thus, $sVal(v) = 1$, for all the states in plays induced by the winning strategy as they always stay in the winning region. As every optimal winning strategy satisfies $aVal(h) = aVal(h, \sigma)$, it is worst-case optimal. Let Σ_{win} and Σ_{WCo-Op} be the set of all winning and worst-case cooperative optimal strategies. Then, by definition, we have $\Sigma_{WCo-Op} \subseteq \Sigma_{win}$ in the winning region and every **WCo-Op** strategy is optimal winning strategy. Hence, **WCo-Op** strategies are value-preserving.

Now, let σ be **SC** such that $last(h) \in V_{win}$. Then if $\sigma(h) \in V_{los}$ then $cVal(h, \sigma) > aVal(h)$. If $\sigma(h) \in \{V_{pen} \cup V_{win}\}$ then $cVal(h, \sigma)$ can be less than $aVal(h)$. Thus, for all prefixes h such that $last(h) \in V_{win}$, if σ is **SC** then it is not value preserving.

From above, we have that, for any history h , **WCo-Op**

are value preserving strategies and hence are not optimistic strategies. For histories h where $\text{last}(h) \in V_{win}$, if σ is **SC** then it *may not* be value-preserving. Thus, if an optimistic strategy exists, then it is a **SC** strategy. Table 2 summarizes the value preservation property for admissible strategies in different regions in the game. \square

A.13 Proof of Theorem 6

In order to prove this, we will first show that every strategy that is either **mSC** or **WCo-Op** is admissible winning.

Lemma 8. *All mSC strategies are admissible winning*

Proof. By definition, a strategy that is **mSC** is (i) **SC** and (ii) value-preserving. From Lemma 6, if there exists an optimistic strategy σ , then a strategy exists that is **SC** are *not* value-preserving. Specifically, for any history h , if $\text{last}(h) \in V_{win}$, then $\sigma(h) \in V_{win} \cup V_{pen}$ and thus σ is not value-preserving.

Further, for history h , if $\text{last}(h) \in V_{pen} \cup V_{los}$ then a strategy that is **mSC** is also **SC**. Thus, we only look at the case where $\text{last}(h) \in V_{win}$. If $\text{last}(h) \in V_{win}$ then a strategy σ is **mSC**, if $c\text{Val}(h) < a\text{Val}(h)$ then $c\text{Val}(h, \sigma) < a\text{Val}(h) \wedge a\text{Val}(\sigma(h)) \neq \infty$ else if $c\text{Val}(h) = a\text{Val}(h)$ then $a\text{Val}(h, \sigma) = c\text{Val}(h, \sigma) = a\text{Val}(h)$.

Thus, we need to prove that every play in $\text{Plays}^h(\sigma)$ reaches a goal state with a payoff less than or equal to \mathcal{B} , i.e., $a\text{Val}(h, \sigma) \leq \mathcal{B}$ or $a\text{Val}(h) \leq \mathcal{B}$. For the second condition, if $c\text{Val}(h) = a\text{Val}(h)$ then σ is worst-case optimal as $a\text{Val}(h, \sigma) = a\text{Val}(h)$. By definition, all worst-case optimal strategies ensure reaching the goal state such that $a\text{Val}(h) \leq \mathcal{B}$. Thus, strategy σ that is **WCO** and **mSC** will reach a goal state with a payoff less than or equal to \mathcal{B} .

For the second condition, if $c\text{Val}(h) < a\text{Val}(h)$ then strategy σ is **mSC** if $c\text{Val}(h, \sigma) < a\text{Val}(h) \wedge a\text{Val}(\sigma(h)) \neq \infty$, that is, σ is **SC** and never takes an action from $\text{last}(h)$ in winning region that evolves to the pending or losing region (as such actions do not satisfy $(s\text{Val}(\text{last}(h)) = 1 \implies s\text{Val}(\delta(\text{last}(h), \sigma(h)))) = 1$). Thus, every play under strategy σ will remain in the winning region. As from every state in the winning region, there exists a winning strategy such that $a\text{Val}(h) < \infty$, the plays under a value-preserving **mSC** strategy always remain in the winning region, and thus value-preserving **mSC** is a winning strategy. Thus, every strategy that **mSC** is admissible winning. \square

Lemma 9. *All WCo-Op strategies are admissible winning*

Proof. From Lemma 3, we have that every strategy σ that is **WCo-Op** is admissible. For a strategy to be admissible winning, it needs to satisfy an additional requirement that: $\forall h \in \text{Plays}^{v_0}(\sigma), a\text{Val}(h) < \infty \implies \text{Val}(h \cdot P^h(\sigma, \tau)) \leq \mathcal{B}$ for all Env player strategy.

Informally, if there exists an optimal winning strategy σ from history h , then all plays under strategy σ should reach a goal state with payoff less than or equal to \mathcal{B} , i.e., $a\text{Val}(h, \sigma) \leq \mathcal{B}$. As $a\text{Val}(h) = a\text{Val}(h, \sigma)$, we have $a\text{Val}(h) \leq \mathcal{B}$.

By definition, a **WCo-Op** strategy σ' is a strategy that is worst-case optimal i.e., $a\text{Val}(h, \sigma') = a\text{Val}(h)$. Thus, every strategy that is **WCo-Op** will also be a **WCO** strategy. Thus, σ' ensures $a\text{Val}(h, \sigma') = a\text{Val}(h) = a\text{Val}(h, \sigma)$. Thus, $a\text{Val}(h, \sigma') \leq \mathcal{B}$.

Hence, every strategy that is **WCo-Op** is admissible winning. \square

Now we use the same techniques from Thm. 3 to prove that **mSC** and **WCo-Op** are necessary and sufficient conditions for a strategy to be admissible winning.

Proof of Thm. 6. We first start by noting the following. From Lemma 4, we have that negation of Eqs. (10a) and (10b) is as follows:

$$\left((c\text{Val}(h, \sigma) \geq a\text{Val}(h) \wedge a\text{Val}(h, \sigma) > a\text{Val}(h)) \vee \right. \quad (13a)$$

$$\left. \neg(p \implies q) \right) \quad (13b)$$

$$\left(a\text{Val}(h) = a\text{Val}(h, \sigma) = c\text{Val}(h, \sigma) \wedge \right. \quad (13c)$$

$$\left. ac\text{Val}(h) < a\text{Val}(h) \right)$$

Here is p and q are logical propositions that correspond to $s\text{Val}(\text{last}(h)) = 1$ and $s\text{Val}(\delta(\text{last}(h), \sigma(h))) = 1$, respectively. Thus, by tautology, $\neg(p \implies q)$ is true if and only if $s\text{Val}(\text{last}(h)) = 1$ is true and $s\text{Val}(\delta(\text{last}(h), \sigma(h))) = 1$ is false. Informally, $\neg(p \implies q)$ is true if $\text{last}(h)$ belongs to the winning region but $\sigma(h)$ does not belong to the winning region. Further, Eq. (13a) is the same as Eq. (8a) and Eq. (13c) is the same as Eq. (8b). Given an admissible winning strategy σ , and prefix $h \in \text{Plays}^{v_0}(\sigma)$, we want to prove that $\sigma \iff \text{mSC} \vee \text{WCo-Op}$, i.e., σ is the witnessing strategies that satisfies **mSC** or **WCo-Op** conditions. We use the following tautology to prove iff condition.

$$(A \iff B) \iff [(B \implies A) \wedge (\neg B \implies \neg A)]$$

Here A is the logical statement that σ is admissible winning as per Def. 7 and B is the logical statement that implies either Eq. (10a) or Eq. (10b) is true.

Case I: $(\neg B \implies \neg A)$ For all $h \in \text{Plays}^{v_0}$, if $\text{last}(h) \in V_{pen} \cup V_{los}$ then **mSC** strategies are the same as the **SC** strategy. Thus, from Thm. 4's Case I we have that any strategy σ that satisfies Eq. (13a) is weakly dominated by another strategy that is **WCO**. Thus, σ is not admissible, i.e., $\neg A$ holds. if $\text{last}(h) \in V_{win}$, then σ either satisfies Eq. (13a) or Eq. (13b). We note that Eqs. (13a) and (13b) can be rewritten as:

$$c\text{Val}(h, \sigma) < a\text{Val}(h) \implies \neg(p \implies q)$$

Thus, if σ satisfies $c\text{Val}(h, \sigma) < a\text{Val}(h)$ (it is **SC**) then $\neg(p \implies q)$ is true, i.e., $\text{last}(h) \in V_{win}$ and $\sigma(h) \notin V_{win}$. From Lemma 6, we have that for every play under strategy σ with $\text{last}(h) \in V_{win}$, $\sigma(h) \in V_{win} \cup V_{pen}$. As $\sigma(h) \notin V_{win} \implies \sigma(h) \in V_{pen}$. If $\sigma(h) \in V_{pen}$ then by definition, there exists an Env strategy such that $\text{Val}(h \cdot P^h(\sigma, \tau)) = \infty$. Thus, σ is not a winning strategy. Hence, σ is not admissible winning and $\neg A$ holds.

For any history $h \in \text{Plays}^{v_0}$, if strategy σ satisfies Eq. (13c) then from Thm. 4’s Case I, we have that there exists σ' that is **WCo-Op** that does as good as σ and there exists a play under σ' with a payoff strictly lower than any payoff under strategy σ . Thus, σ is not admissible, and $\neg A$ holds.

Case II: ($B \implies A$) Assume that for all prefixes h of $\text{Plays}^{v_0}(\sigma)$ we have that Eqs. (10a) and (10b) hold such that σ is the witnessing strategy for either **mSC** or **WCo-Op**. From Lemma 8 and 9, we have a strategy that is either **mSC** or **WCo-Op** is always admissible winning.

Since we have shown both ($\neg B \implies \neg A$) and ($B \implies A$), hence, for all prefixes starting from v_0 , Eqs. (10a) and (10b) are necessary and sufficient conditions for strategy σ to be admissible winning. \square

A.14 Proof of Lemma 7

Proof. From Thm. 6 we have that **WCo-Op** is a necessary and sufficient condition for a strategy to be admissible winning. From Thm. 2, we have that **WCo-Op** always exists. Thus, we conclude that admissible winning strategies always exist.

Further, we can show that **mSC** strategies always exist. To prove this, we observe that **mSC** is a subset of **SC**. Specifically, $\forall h \in \text{Plays}^h(\sigma)$ such that $\text{aVal}(h) < \infty$, **mSC** are exactly the strategies that are **SC** and value-preserving. From Lemma 8, we have that **mSC** are winning strategies for all h such that $\text{aVal}(h) < \infty$. Thus, witnessing strategies for worst-case strategies from the winning region is a sufficient condition for **mSC** to always exist. From (Brihaye et al. 2017) and A.9, we can compute witnessing strategies for all worst-case values for every history h in \mathcal{G} . Thus, **mSC** strategies always exist. \square

A.15 Proof of Theorem 7

Proof. By definition a strategy σ is admissible winning if it **SC** and $\text{sVal}(\text{last}(h)) = 1 \implies \text{sVal}(\delta(\text{last}(h), \sigma(h))) = 1$. We observe that the value-preserving constraint is Markovian, i.e., it only depends on $\text{last}(h)$ (last state along a history) and $\delta(\text{last}(h), \sigma(h))$ (the next state under strategy σ). Thus, it is sufficient to check for the value-preserving constraint memoryless-ly, i.e., independent of the sequence of states in h .

From Thm. 1, we know that we need to keep track of states along a history to check if $\text{cVal}(h, \sigma) < \text{aVal}(h)$ (**SC** condition) is satisfied. Thus, memoryless strategies are not sufficient for admissible winning strategies. \square

A.16 Proof of Theorem 8

Proof. From Sec. 4, we have that Alg. 4 is same as Alg. 3 except for the admissibility checking criteria.

The only difference in Eqs. (10a) and (10b) and Eq. (7) is the value preserving constraint. We observe that $\text{sVal}(\text{last}(h)) = 1 \implies \text{sVal}(\delta(\text{last}(h), \sigma(h))) = 1$ constraint is Markovian, i.e., it only depends on $\text{last}(h)$ (last state along a history) and $\delta(\text{last}(h), \sigma(h))$ (the next state

under strategy σ). By tautology, we express the above statement as

$$\neg(\text{sVal}(\text{last}(h)) = 1) \vee (\text{sVal}(\delta(\text{last}(h), \sigma(h))) = 1).$$

As $\text{sVal}(v) = 1$ only in the winning region, we have the following equivalent statement $\neg(v \in V_{win}) \vee (v' \in V_{win})$ where $v := \text{last}(h)$ and $v' := \delta(\text{last}(h), \sigma(h))$. Thus, modifying the admissibility checking criteria in Line 9 of Alg. 1 to $\text{cVal}(v') < \min\{\text{aValues}\}$ and $\neg(v \in V_{win}) \vee (v' \in V_{win})$ is sufficient to capture the admissibility criteria for **mSC**. Thus, from Thms. 5 and 6, we have that Alg. 4 returns the set of all admissible winning strategies, is sound and correct. \square

A.17 Note on Alg. 2

Alg. 2 is the Value Iteration algorithm for computing optimal Vals and optimal strategy from every state in \mathcal{G} (Brihaye et al. 2017)[Adapted and Modified from Algo. 1]. Line 7 and Line 8 correspond to computation when the Env player is playing adversarially (maximally) and cooperatively (minimally), respectively. When Env is playing adversarially, Alg. 2 returns optimal **aVal** and worst-case optimal strategy **WCO**. For a **aVal** computation, σ_{win} is the optimal winning strategy from every state in V_{win} .

When Env is playing cooperatively, Alg. 2 returns optimal **cVal** and cooperative optimal strategy **Co-Op**. For **cVal** computation, $\sigma_{win} = \sigma_{coop}$ and V_{win} is the set of states from which $\text{cVal}(v) \neq \infty$. We can observe that the algorithm is based on fixed point computation, and thus, the algorithm runs in polynomial time.

A.18 Note on Alg. 3 and Alg. 4

Alg. 3 and Alg. 4 compute admissible and admissible winning strategies, respectively. The key components are unrolling the graph, running value iteration, and an algorithm for Depth-First Search (DFS). The DFS algorithm searches over \mathcal{G}' iteratively rather than recursively in order to avoid Python’s low recursion limit. Specifically, the algorithm explores states in preorder fashion. Alg. 2 gives the outline to compute optimal **aVal** and **cVal** and the corresponding witness strategies. See A.17 for more details. After we unroll the graph, we compute **aVal**, **cVal**, and **acVal** for every state and finally run the DFS algorithm for strategy synthesis.

We initialize a stack h to keep track of states visited so far, and their corresponding adversarial values are added to **aValues**’s stack. Note, h is a stack of tuples where the first element is the states visited, and the second element is an iterator (Line 14 in Algs. 3 and 4) over the successors of v in \mathcal{G}' . We start the search by adding the initial state to h and iterate over its successors v' using the `next` operator. After exploring a successor v' , we break out of the `try` block and explore the successors of v' . Once, we explore all the successors of a state, we pop that state from h and **aValues** stacks and continue till every state has been popped from h . The highlighted section in Algs. 3 and 4 show the difference in admissibility checking in both algorithms.

B Note on SCO vs SC

Brenquier et al. define strongly-cooperative optimal strategies in order to show that every **SCO** is admissible. Then, they proceed to show that **SCO** strategies always exist in determined (well-formed as per their terminology) games, i.e., you can always find a strategy σ such that $\text{aVal}(h) = \text{aVal}(h, \sigma)$ and $\text{cVal}(h) = \text{cVal}(h, \sigma)$ for every $h \in \text{Plays}^v(\sigma)$.

In our case, we define **SC** strategy that is a superset of **SCO**. **SCO** are maximal in dominance order, but so are **SC**.

Definition 13 (SCO). For all $h \in \text{Plays}^{v_0}(\sigma)$, strategy σ is *Strongly Cooperative Optimal (SCO)*, if $\text{cVal}(h) < \text{aVal}(h)$ then $\text{cVal}(h, \sigma) = \text{cVal}(h)$; if $\text{cVal}(h) = \text{aVal}(h)$ then $\text{aVal}(h, \sigma) = \text{aVal}(h)$.

Lemma 10. All **SCO** strategies are admissible.

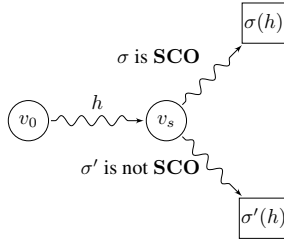

Figure 8: **SCO** proof example

Proof. Let σ be **SCO**. Assume there exists $\sigma' \neq \sigma$ that is compatible with history h , $\text{last}(h) = v_s$, and “splits” at v_s as shown in Figure 8. Thus, $\sigma(h) \neq \sigma'(h)$. We note that only two cases for a strategy are possible, i.e., it is either **SCO** or not. Further, let’s say that σ' weakly dominates σ . We show that σ' does not weakly dominate σ .

Case I $\text{cVal}(h) < \text{aVal}(h)$: As σ' is not **SCO** this implies $\text{cVal}(h, \sigma') \geq \text{aVal}(h)$ and as $\text{cVal}(h, \sigma) \leq \text{aVal}(h, \sigma)$ for any $\sigma \in \Sigma$, we get

$$\text{aVal}(h, \sigma') \geq \text{cVal}(h, \sigma') \geq \text{aVal}(h) > \text{cVal}(h) = \text{cVal}(h, \sigma).$$

On simplifying, we get $\text{aVal}(h, \sigma') \geq \text{aVal}(h) > \text{cVal}(h, \sigma)$. This statement implies that there exists $\tau \in \mathbb{T}$ such that $\text{Val}(h \cdot P^{v_s}(\sigma', \tau)) > \text{Val}(h \cdot P^{v_s}(\sigma, \tau))$. Note that since, $\text{Val}(h \cdot P^{v_s}(\sigma, \tau)) = \text{Val}(h) + \text{Val}(P^{v_s}(\sigma, \tau))$ we get $\text{Val}(P^{v_s}(\sigma', \tau)) > \text{Val}(P^{v_s}(\sigma, \tau))$. This contradicts the assumption that σ' dominates σ as σ' should always have a payoff that is equal to or lower than σ .

Case II $\text{cVal}(h) = \text{aVal}(h)$: For this case we get,

$$\text{aVal}(h, \sigma') \geq \text{cVal}(h, \sigma') \geq \text{aVal}(h) = \text{cVal}(h) = \text{cVal}(h, \sigma).$$

This implies that $\text{cVal}(h, \sigma') \geq \text{cVal}(h)$. But, since σ' dominates σ , there should exist a strategy $\tau \in \mathbb{T}$ under which σ' does strictly better than σ . Since, $\text{cVal}(h, \sigma') \geq \text{cVal}(h) \forall \tau \in \mathbb{T}$, it implies that there does not exist a payoff $\text{Val}(P^{v_s}(\sigma', \tau))$ that has a payoff strictly less than $\text{cVal}(h, \sigma) = \text{cVal}(h)$. Thus, σ' does not dominate σ .

We can repeat this for all histories h in $\text{Plays}^{v_0}(\sigma)$. Hence, every σ that is **SCO** is admissible. \square

Intuitively, **SCO** strategies, just like **SC**, let the Sys player take a “riskier” action as long there exists a lower payoff along that play. This makes the strategy optimistic.

C More admissible strategy properties

Lemma 11. Given \mathcal{G} , and strategy σ that is admissible, $\forall h \in \text{Plays}^h(\sigma)$ such that $\text{aVal}(h) < \infty$, $\sigma \neq \sigma_{win}$

Proof. Proof by Lemma 1. We first observe that an optimal winning strategy σ_{win} satisfies the condition $\text{aVal}(h, \sigma_{win}) = \text{aVal}(h)$. Thus, σ_{win} enforce reaching a goal state for all Env player strategies $\tau \in \mathbb{T}$. Thus, every σ_{win} ensures that every state for every play in $\text{Plays}^v(\sigma_{win})$ belongs to V_{win} . Hence, from Lemma 1, we have that not all admissible strategies are **WCO**.

In Fig. 2, a Sys player strategy that commits to v_1 from v_0 is **WCO**. Thus, actions $v_4 \rightarrow v_5$ and $v_4 \rightarrow v_7$ belong to strategy that is **WCO**. But, only action $v_4 \rightarrow v_7$ belongs to an admissible strategy as there exists a better payoff while enforcing the worst-case optimal payoff. Therefore, not every **WCO** strategy is an admissible strategy. \square

Thus, from Lemma 11, we have that admissible strategies are not equivalent to winning strategies.

C.1 When are WCO admissible?

Another interesting characterization of admissible strategy is as follows. Given history h , if $\text{acVal}(h) = \text{aVal}(h)$, then the adversarial-cooperative value and adversarial value for h are the same. This implies, strategy σ that is **WCO** is also **WCo-Op**. Thus, σ that is worst-case optimal is admissible.

Lemma 12. All worst-case optimal (**WCO**) strategies are admissible if $\text{acVal}(h) = \text{aVal}(h)$,

Proof. A strategy σ that witnesses $\text{acVal}(h)$ is maximal in order. There does not exist another strategy that ensures a lower payoff while being **WCO**. There might exist σ' that achieves lower payoff against some adversary but will receive higher payoff against another adversary, i.e., $\text{aVal}(h, \sigma') > \text{aVal}(h)$. Hence, σ' does not dominate σ . Thus, if $\text{acVal}(h) = \text{aVal}(h)$, then all **WCO** strategies are admissible. Further, if $\text{acVal}(h) < \text{aVal}(h)$, then a worst-case optimal strategy σ is admissible if, and only if, $\text{cVal}(h, \sigma) < \text{aVal}(h)$ and $\text{cVal}(h, \sigma) = \text{acVal}(h)$. \square

D Clarification - Qualitative vs. Quantitative

D.1 Existing Qualitative Dominance Definition

These notions are common in the Formal Methods community where the objective is Boolean and the corresponding payoff is binary (win or lose (Berwanger 2007)).

Definition 14 (Dominance (Quant - very weakly dominating) (Aminof et al. 2021)). Given two Sys strategies $\sigma, \sigma' \in \Sigma$, we say σ dominates σ' , denoted by $\sigma \succeq \sigma'$, if for every env strategy $\tau \in \mathbb{T}$, $P^{v_0}(\sigma', \tau) \models \varphi \rightarrow P^{v_0}(\sigma, \tau) \models \varphi$.

Intuitively, given two strategies σ and σ' for the agent, we say that σ dominates σ' if σ is as good as σ' for some environment strategies τ . We note that Strict Dominance was

NOT defined using the definition env. (Aminof et al. 2021; Aminof, De Giacomo, and Rubin 2023).

Definition 15 (Strict Dominance (Quant - weakly dominating)). *Given two Sys strategies $\sigma, \sigma' \in \Sigma$, we say σ strictly dominates σ' , denoted by $\sigma \succ \sigma'$, if $\sigma \succeq \sigma'$ and $\neg(\sigma' \succeq \sigma)$.*

We say σ strictly dominates σ' if it does as good as σ' and is better than σ' in at least one case. Note, better \rightarrow reaching a goal state for Two-player Reachability games.

Definition 16 (admissible (Berwanger 2007)). *A strategy is called admissible for the Sys player if it is not dominated (\succ ; as per Def. 15) by any other strategy of the Sys player.*

Definition 17 (Best-Effort (Aminof et al. 2021; Aminof, De Giacomo, and Rubin 2023; Faella 2009)). *A strategy is called Best-Effort for the Sys player if it is not dominated (\succ ; as per Def. 15) by any other strategy of the Sys player.*

So, by definition, in Qualitative settings, both Best-Effort and Admissible strategies are equivalent (Aminof et al. 2021; Aminof, De Giacomo, and Rubin 2023). The same is not true in the Quantitative settings.

Qualitative	Quantitative
Dominance (Def. 14)	Very weakly dominating (Def. 5)
strict dominance (Def. 15)	weakly dominating (Def. 5)
N.A.	strictly dominating (Def. 5)
Admissible \equiv BE	Admissible (BE - N.A.)

Table 3: Equivalent definition of dominance across qualitative (Aminof et al. 2021; Berwanger 2007) and quantitative papers (Leyton-Brown and Shoham 2008; Brenguier et al. 2016)