

Analysis of the *JWST* spectra of the kilonova accompanying GRB 230307A

J. H. Gillanders * & S. J. Smartt 

Astrophysics sub-Department, Department of Physics, University of Oxford, Keble Road, Oxford, OX1 3RH, UK

Accepted XXX. Received YYY; in original form ZZZ

ABSTRACT

Kilonovae are key to advancing our understanding of *r*-process nucleosynthesis. To date, only two kilonovae have been spectroscopically observed, AT 2017gfo and AT 2023vfi. Here, we present an analysis of the *James Webb Space Telescope* spectra obtained +29 and +61 days post-merger for AT 2023vfi. After re-reducing and photometrically flux-calibrating the data, we empirically model the observed X-ray to mid-infrared continua with a power law and a blackbody, to replicate the non-thermal afterglow and apparent thermal continuum $\gtrsim 2 \mu\text{m}$. We fit Gaussians to the apparent emission features, obtaining line centroids of 20218^{+37}_{-38} , 21874 ± 89 and $44168^{+153}_{-152} \text{ \AA}$, and velocity widths spanning $0.057 - 0.110 c$. These line centroid constraints facilitated a detailed forbidden line identification search, from which we shortlist a number of *r*-process species spanning all three *r*-process peaks. We rule out Ba II and Ra II as candidates and propose Te I–III, Er I–III and W III as the most promising ions for further investigation, as they plausibly produce multiple emission features from one (W III) or multiple (Te I–III, Er I–III) ion stages. We compare to the spectra of AT 2017gfo, which also exhibit prominent emission at $\sim 2.1 \mu\text{m}$, and conclude that [Te III] $\lambda 21050$ remains the most plausible cause of the observed $\sim 2.1 \mu\text{m}$ emission in both kilonovae. However, the observed line centroids are not consistent between both objects, and they are significantly offset from [Te III] $\lambda 21050$. The next strongest [Te III] transition at 29290 \AA is not observed, and we quantify its detectability. Further study is required, with particular emphasis on expanding the available atomic data to enable quantitative non-LTE spectral modelling.

Key words: gamma-ray burst: individual: GRB 230307A — neutron star mergers — line: identification — atomic data

1 INTRODUCTION

The rapid neutron-capture process (*r*-process) is responsible for synthesising approximately half of the elements heavier than the iron peak (i.e., those with atomic number, $Z \gtrsim 30$) in the Universe (Cowan et al. 2021). There are a number of proposed production sites for *r*-process nucleosynthesis (Arnould et al. 2007; Thielemann et al. 2011). The explosive deaths of massive stars have been linked as viable production sites for decades, with core-collapse supernovae (SNe; Takahashi et al. 1994; Woosley et al. 1994; Qian & Woosley 1996), magneto-rotational SNe (Symbalisty et al. 1985; Winteler et al. 2012; Mösta et al. 2018), and collapsars (MacFadyen & Woosley 1999; Cameron 2003; Pruet et al. 2003; Siegel et al. 2019) all having been proposed to support the extreme conditions needed to initiate the *r*-process. Compact binary mergers have also been proposed as ideal production sites; i.e., the merger of a neutron star (NS) with a companion NS or a stellar-mass black hole (BH) (Lattimer & Schramm 1974; Symbalisty & Schramm 1982; Eichler et al. 1989; Li & Paczyński 1998; Freiburghaus et al. 1999; Rosswog et al. 1999). In these cases, the radioactive decay from the ensemble of newly synthesised unstable heavy isotopes powers an electromagnetic (EM) transient, dubbed a kilonova (KN; Metzger et al. 2010). To date, the only direct observations we have of *r*-process nucleosynthesis are associated with KNe. The first spectroscopically observed KN event was discovered in August 2017 (AT 2017gfo; Abbott et al. 2017) with

the second observed ~ 5.5 years later, in March 2023 (AT 2023vfi, associated with GRB 230307A; Levan et al. 2024; Yang et al. 2024).

Spectroscopic observations obtained for AT 2017gfo presented the first opportunity to use spectral data to unravel the composition of freshly synthesised *r*-process material. Several works have modelled the spectra of AT 2017gfo, with the aim of linking specific spectral features to individual *r*-process species. Specific features have been proposed to be due to Cs and Te (Smartt et al. 2017), Sr (Watson et al. 2019; Domoto et al. 2021; Gillanders et al. 2022), He (Perego et al. 2022; Tarumi et al. 2023), La and Ce (Domoto et al. 2022), Y (Sneppen & Watson 2023), Rb (Pognan et al. 2023), and Te (Hotokezaka et al. 2023; Gillanders et al. 2024).

Emphasis has been placed on the proposed identifications of Sr in the photospheric stage (Watson et al. 2019) and Te as a nebular emission line (Hotokezaka et al. 2023; Gillanders et al. 2024), since these are even- Z elements that correspond to the first and second *r*-process abundance peaks, respectively. As such, these elements will be abundant across many different *r*-process scenarios. Gillanders et al. (2022) present plausible composition profiles for kilonovae (based on different Y_e nucleosynthetic trajectories extracted from a realistic hydrodynamical simulation of a binary neutron star merger from Bauswein et al. 2013; Goriely et al. 2011, 2013, 2015), which identify both Sr and Te as potentially abundant elements. Therefore, observing evidence of these elements seems plausible, at least from a nucleosynthetic standpoint. However, KN ejecta possess rapid expansion velocities ($v_{\text{ej}} \gtrsim 0.1 c$), which leads to broad and blended spectral features, making line identification studies difficult (Shingles et al. 2023; Collins et al. 2024). One solution to this problem is

* E-mail: james.gillanders@physics.ox.ac.uk

to probe longer wavelengths, into the near-infrared (NIR) and mid-infrared (MIR), where the effects of line blending are reduced due to the lower density of transitions at these longer wavelengths. An alternative workaround to remove ambiguity surrounding the presence of a particular species is to identify multiple features produced by the same element. However, none of the above proposed identifications are linked to more than a single feature.

For the Te identification in AT 2017gfo, [Hotokezaka et al. \(2023\)](#) propose a [Te III] transition between two fine-structure levels in the ground configuration (with a rest wavelength, $\lambda_{\text{vac}} = 21050 \text{ \AA}$), as the cause for an observed emission feature at $\sim 21000 \text{ \AA}$ in the +7.4 – 10.4 d X-shooter spectra of AT 2017gfo. [Gillanders et al. \(2024\)](#) empirically modelled all spectral features in the late-time spectra of AT 2017gfo, and found that this emission feature is best explained by a superposition of two emission components, with peak wavelengths of 20590 and 21350 \AA . [Gillanders et al. \(2024\)](#) independently proposed the same [Te III] transition as a candidate for one of these components, but show alternative matches to what may be relatively prominent forbidden transitions belonging to other species. The [Te III] $\lambda 21050$ has been astrophysically observed in planetary nebulae ([Madonna et al. 2018](#)).

For feature identifications in the spectroscopic observations of AT 2023vfi, [Levan et al. \(2024\)](#) propose the emission feature present in the +29 and +61 d *James Webb Space Telescope* (*JWST*) NIRSpec spectra at $\sim 21500 \text{ \AA}$ is caused by the same [Te III] transition as proposed for AT 2017gfo. [Gillanders et al. \(2023a\)](#) present modelling of these same *JWST* spectra, and identify the same spectral feature. They show that the feature at +29 d can be fit with either one or two components, with peak wavelengths of $\approx 21200 \text{ \AA}$ (one component) or ≈ 20500 and 22800 \AA (two components). Prominent emission persists at this wavelength position to the later +61 d *JWST* spectrum, and [Gillanders et al. \(2023a\)](#) estimate a peak wavelength of $\approx 22000 \text{ \AA}$. [Gillanders et al. \(2023a\)](#) propose the [Te III] 21050 \AA transition as a likely contributor to this emission, but also suggest alternative identifications.

In this paper, we empirically model a re-reduced and carefully calibrated version of the *JWST* spectra of AT 2023vfi. We carry out an extensive analysis of the spectral features, and search for candidate transitions in both the +29 and +61 d spectra, beyond the [Te III] transition proposed by [Levan et al. \(2024\)](#) and [Gillanders et al. \(2023a\)](#). We quantify whether the $\sim 2.1 \mu\text{m}$ emission feature necessitates multiple components, or whether a single component can satisfactorily reproduce the data. For comparison, we also re-analyse the late-time AT 2017gfo spectra in an identical manner, to enable robust comparison between the common $\sim 2.1 \mu\text{m}$ emission present in both kilonovae. With constraints on feature properties, we then perform a line identification search, to constrain the most likely contributing species and highlight them as the most pertinent subjects for future detailed atomic data studies.

We present our paper in the following manner. In Section 2, we summarise the reduction steps for the AT 2023vfi spectroscopic data that we analyse in this work. We also present the AT 2017gfo spectra that we model here and compare with AT 2023vfi. In Section 3, we describe our method of fitting the spectra, and we present our results. Section 4 contains the details of our line identification search, and here we discuss the favoured candidate transitions. We also present comparisons to previous line identification studies, and to AT 2017gfo. Finally, we conclude in Section 5.

Throughout this manuscript, we adopt the convention of expressing luminosity and flux densities in wavelength space; i.e., $F, L \propto \lambda^{-1}$.

2 SPECTRA

Here we briefly outline the sources of spectral data we analyse in this work, both for AT 2023vfi and AT 2017gfo.

2.1 AT 2023vfi

For our analysis of AT 2023vfi, we model the *JWST* NIRSpec spectra obtained +28.9 and +61.4 days post-explosion (the explosion time is well-constrained due to the detection of the γ -ray burst; [Fermi GBM Team 2023](#)). We opted to perform our own extractions of the 1D spectra of AT 2023vfi.

We first downloaded the level 3 data products derived from the two epochs of NIRSpec observations, available via the MAST web-pages.¹ We note that these level 3 data products were reprocessed on 11th June 2024 with an updated calibration software pipeline² and with updated reference data,³ and so should now represent an improvement over the original data products released at the time of observation and those presented by [Levan et al. \(2024\)](#) and [Gillanders et al. \(2023a\)](#). These 2D spectra are presented in Figures 1 and 2.

We extracted the transient spectrum from these following the method outlined by [Horne \(1986\)](#). We centred an aperture (of width ten pixels) on the transient trace and extracted a 1D spectrum, where the flux values were computed based on the weighted pixel values across the width of the aperture, and the associated error was computed from their variance (see [Horne 1986](#), for further details). This method represents the optimal technique for spectral extraction, and combined with the most recent reprocessing, represents the best quality 1D spectra products. The reduced spectra span a wavelength range, $6010 \lesssim \lambda \lesssim 52920 \text{ \AA}$.⁴ We note the spectra have a strong dispersion relation between pixel and wavelength scale, with mean values of 105, 65 and 32 \AA pix^{-1} estimated from the central, reddest and bluest ten pixels, respectively. The coarsest dispersion of 200 \AA pix^{-1} is at $\approx 15500 \text{ \AA}$.

These Horne-extracted NIRSpec spectra were then flux-calibrated using a linear scaling function to match the contemporaneous NIRCam photometry from [Levan et al. \(2024\)](#). These photometry estimates have been corrected to account for the contamination from the diffraction spike from a nearby foreground star (which contaminates both the NIRCam and NIRSpec observations). Thus, these photometry values represent the true flux of the transient. Calibrating our 1D NIRSpec spectra to these data therefore allows us to effectively correct for (i.e., remove) the contribution from the diffraction spike.

To visualise the observations and the associated sources of contamination, in Figure 3 we present the *F277W* NIRCam images from +29 and +61 d, with the slit positions from the NIRSpec observations overlaid. The images are centred on the position of AT 2023vfi, with the neighbouring background galaxy and contaminating diffraction spike also visible. The overlaid slit positions represent the position and angle of each of the four NIRSpec sub-exposures. At +29 d, the slit positions were well-placed, such that AT 2023vfi was centred close to the centre of the slit in each sub-exposure. The background galaxy was partially sampled at the northern edge of the slit, and we note that the galaxy is offset spatially along the length of the

¹ <https://mast.stsci.edu/portal/Mashup/Clients/Mast/Portal.html>

² cal_ver = 1.13.3

³ CRDS_CTX = jwst_1237.pmap

⁴ This range is slightly smaller than the full wavelength extent of NIRSpec, since we clipped a small amount of extremely noisy data from the blue and red edges.

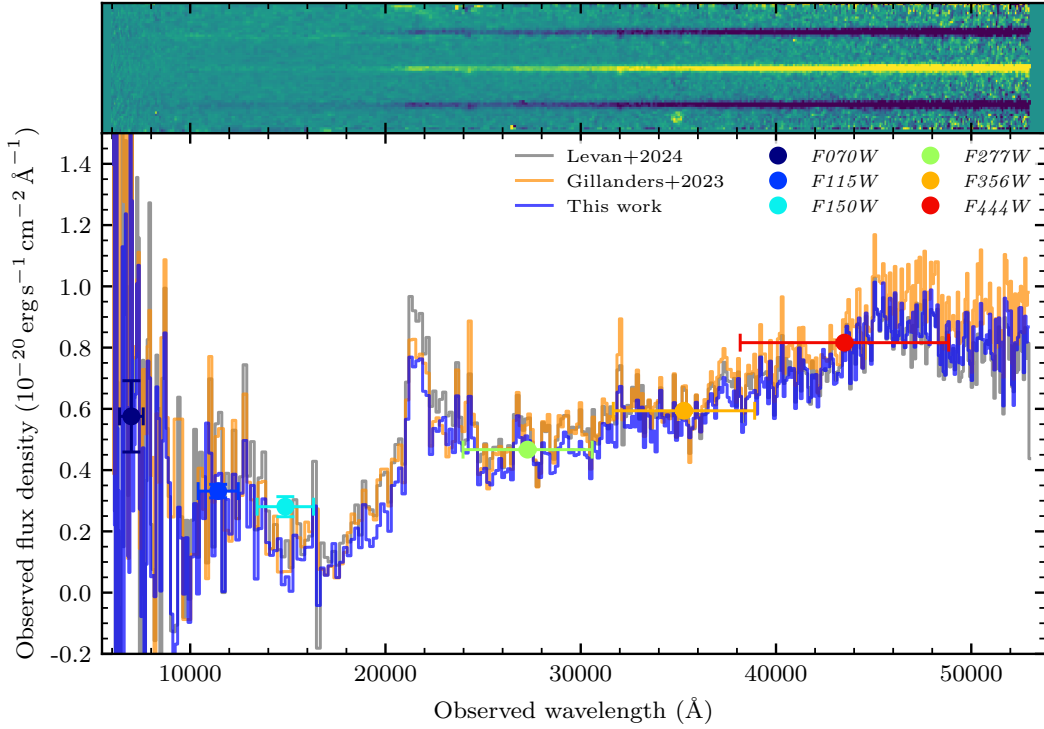

Figure 1. *Upper:* +29 day 2D NIRSpect *JWST* spectrum of AT 2023vfi. Note the presence of the three emission features from the background galaxy visible slightly offset from the transient trace, as discussed in the main text. *Lower:* Comparison of the different published versions of the +29 day NIRSpect *JWST* spectrum of AT 2023vfi (first presented by [Levan et al. 2024](#) and [Gillanders et al. 2023a](#); grey and orange, respectively) with the version presented in this work (blue). The observed contemporaneous NIRCAM photometry from [Levan et al. \(2024\)](#) is overlaid. No extinction or redshift corrections have been applied; all data are plotted as in the observer frame.

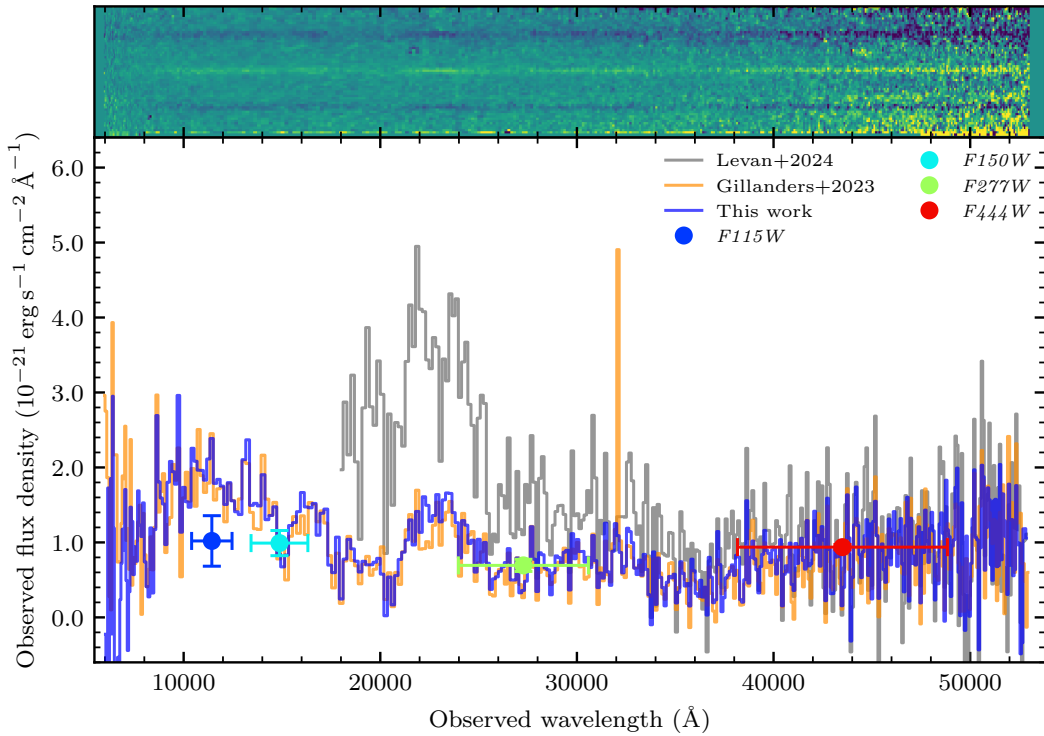

Figure 2. Same as Figure 1, but for the *JWST* NIRSpect and NIRCAM observations at +61 days.

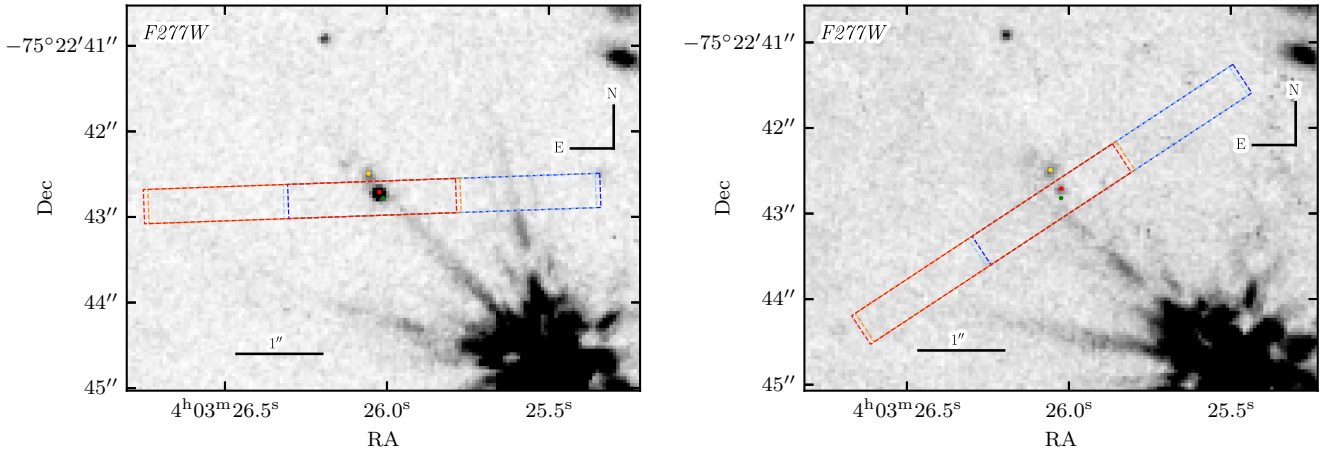

Figure 3. *Left:* +29 d NIRCcam $F277W$ image of the field of AT 2023vfi/GRB 230307A. The location of AT 2023vfi and the background galaxy are both marked (red and gold dots, respectively). The target location of AT 2023vfi for this set of observations is marked with a green dot, and corresponds to the central point of the NIRSspec observations. The four dithered NIRSspec slit positions have been overlaid (dashed rectangles). The transient and background galaxy are both clearly visible in the image. The contaminating diffraction spike is also visible. *Right:* Same as the left panel, but for the +61 d NIRCcam and NIRSspec observations.

slit, leading to spatially distinct emission in the 2D spectrum (see Figure 1).

The background galaxy contamination in the 2D NIRSspec spectrum allows the redshift of this galaxy to be estimated. In our new reduction, we see evidence for three emission lines at 23670, 24317 and 32042 Å (see Figure 1), which, if produced by H β , [O III] λ 5006.84 and H α , respectively, correspond to a redshift, $z = 3.87$, in good agreement with that reported by Levan et al. (2024).

At +61 days, the transient has faded substantially, and the slit angle employed was different. In Figure 3, we again see that the position of AT 2023vfi is covered by each of the four dithered NIRSspec exposures. However, the orientation of the slit is now such that the background galaxy was not in any of the NIRSspec sub-exposures. As a result, we do not see evidence for the prominent galaxy emission lines that were present in the +29 d observation. The observations are again contaminated by the diffraction spike, and as the transient has faded substantially between +29 and +61 days, the relative contamination is much greater. This leads to a significant excess of flux blueward of $\sim 2 \mu\text{m}$, and, following our flux calibration method outlined above, we cannot recover a spectrum that matches the photometric observations across the full NIRSspec $\approx 0.7\text{--}5.3 \mu\text{m}$ wavelength range (see Figure 2).

In the previous version of the +61 d spectrum, there was a strong single pixel excess centred at $\approx 32090 \text{ \AA}$, which initially appeared to be due to H α emission from the background galaxy at $z \approx 3.87$. However, the reprocessed data products do not contain this prominent emission spike. Upon further investigation, we determine it was likely the result of a hot pixel or a cosmic ray artefact that has now been successfully masked out in the new reduction of the data. It was simply coincidental that it lay close to H α at $z = 3.87$.

Here we make our reduced *JWST* spectra publicly available and accessible to the community (see Data Availability). These spectra are the best available versions of these two *JWST* NIRSspec observations of AT 2023vfi. As such, we suggest these are the versions that should be used for future analysis of this event. In Figures 1 and 2, we present the reductions of the +29 and +61 day spectra compared with the contemporaneous NIRCcam photometry, as well as the previously

published reductions of these spectra (from Levan et al. 2024 and Gillanders et al. 2023a).

Before modelling the spectra, we need to account for extinction and redshift effects. The extinction along the line of sight to AT 2023vfi is estimated to be $E(B - V) = 0.0758$ AB mag (Schlafly & Finkbeiner 2011), and so we de-redden our *JWST* spectra by this factor. To shift the observed spectra to the transient’s rest frame, we need an accurate redshift. The probable host galaxy of AT 2023vfi has an estimated redshift, $z = 0.0647 \pm 0.0003$ (Gillanders et al. 2023b; Levan et al. 2024; Yang et al. 2024). Therefore, we blueshift the spectra by this factor to account for redshift effects.

Finally, for ease of comparison to AT 2017gfo, we opted to convert the observed flux in the *JWST* spectra of AT 2023vfi to luminosity. The redshift of AT 2023vfi ($z = 0.0647 \pm 0.0003$) corresponds to a luminosity distance, $D_L \approx 302$ Mpc (assuming Planck Λ CDM cosmology with a Hubble constant, $H_0 = 67.4 \text{ km s}^{-1} \text{ Mpc}^{-1}$, $\Omega_M = 0.315$ and $\Omega_\Lambda = 0.685$; Planck Collaboration et al. 2020).

2.2 AT 2017gfo

For the spectral analysis of AT 2017gfo, we utilise the sequence of X-shooter spectra obtained by Pian et al. (2017) and Smartt et al. (2017). Specifically, we use the flux-calibrated spectral data set publicly released by the ENGRAVE collaboration (Ackley et al. 2020). These have been flux-calibrated to photometry, corrected for line-of-sight extinction, and shifted to the rest frame. This spectral data set is readily accessible via the ENGRAVE webpage⁵ (along with release notes detailing the calibration and post-processing steps) and WISEREP⁶ (Yaron & Gal-Yam 2012).

As for AT 2023vfi, we convert the spectra of AT 2017gfo to luminosity, using $D_L \approx 40.4$ Mpc (e.g., Hjorth et al. 2017) for the distance to AT 2017gfo.

⁵ www.engage-eso.org/AT2017gfo-Data-Release

⁶ <https://wiserep.weizmann.ac.il>

3 SPECTRAL FITTING

3.1 AT 2023vfi

To model the *JWST* spectra of AT 2023vfi, we need to account for the different components contributing to the observed flux. There is evidence of contribution from a non-thermal afterglow component, a thermal component, and two broad emission-like features in excess of the continuum (centred at ~ 2.1 and $4.4 \mu\text{m}$). The high-energy observations of the non-thermal afterglow component can be readily fit with a single-component power law. This component extends to longer wavelengths, but in the wavelength range of the *JWST* NIRSpec spectra, it is expected to be subdominant (Gillanders et al. 2023a; Yang et al. 2024). Above $\sim 2 \mu\text{m}$, the spectrum of AT 2023vfi exhibits a rising red continuum, resembling of a blackbody profile. Here we perform an empirical fit to the observed spectra, accounting for the contribution from all components; i.e., the non-thermal afterglow (AG), the thermal blackbody (BB), and the emission-like features (approximated as Gaussians), using:

$$L = L_{\text{AG}} + L_{\text{BB}} + \sum_i (L_{\text{G}}), \quad (1)$$

where L is the total observed luminosity density, and L_{AG} , L_{BB} , and L_{G} are the observed luminosity densities from the AG, BB, and Gaussian emission components. These contributions are computed using:

$$L_{\text{AG}} = \alpha \cdot \lambda^\beta, \quad (2)$$

$$L_{\text{BB}} = \pi B(\lambda, T_{\text{ph}}) \cdot 4\pi R_{\text{ph}}^2, \quad (3)$$

$$L_{\text{G}} = a \cdot \exp\left[-\frac{(\lambda - b)^2}{2c^2}\right], \quad (4)$$

where λ is wavelength, α and β are the AG amplitude and exponent, respectively, $B(\lambda, T_{\text{ph}})$ is the Planck function, given by:

$$B(\lambda, T_{\text{ph}}) = \frac{2hc^2}{\lambda^5} \left(\exp\left[\frac{hc}{\lambda k_{\text{B}} T_{\text{ph}}}\right] - 1 \right)^{-1}, \quad (5)$$

T_{ph} and R_{ph} are the photospheric temperature and radius, and a , b and c are the height, centroid and standard deviation (i.e., ‘width’) of the Gaussian profile, with i representing the number of Gaussian profiles needed to reproduce the observed emission-like features.

We perform an empirical fit to the observed data using Markov Chain Monte Carlo (MCMC) techniques, to deduce the best-fitting parameters for our simple model described above. To best constrain the contribution of the sub-dominant (at least in the wavelength range of NIRCам and NIRSpec) afterglow, we fit the data in two stages. First, we fit the NIRCам photometry jointly with inter/extrapolated X-ray data, to estimate the continuum (i.e., L_{AG} and L_{BB}) properties. Yang et al. (2024) present *XMM-Newton* and *Chandra* data for GRB 230307A, up to +37 days post-explosion. Here we interpolate (for +29 d) and extrapolate (for +61 d) these X-ray data to estimate the high-energy contribution of the AG at the phases of the *JWST* observations. Although there is some uncertainty associated with our inter/extrapolations, these data provide the best possible constraints for the non-thermal afterglow at the phases of the *JWST* observations.

Then, we use these best-fitting parameters as constraints for the fitting of the NIRSpec data, which allows us to also extract the best-fitting parameters of the Gaussian components, in addition to improving the robustness of the estimated BB properties. We jointly fit the two epochs of observations together, as there are multiple parameters that can be fixed to reduce the degeneracy in our modelling;

these include the exponent of the afterglow (β), and the centroids and ‘widths’ of the Gaussian profiles (i.e., we only allow the feature amplitudes to vary between +29 and +61 days).

Finally, before fitting the data we perform two ‘data cleaning’ steps, to better enable reliable fitting of the NIRSpec data. First, we mask the prominent background galaxy emission in the +29 d spectrum (see Section 2.1). Second, the *JWST* observations are contaminated by a diffraction spike from a nearby foreground star (see Section 2.1 and Figure 3). As we were unable to correct for this contamination at shorter wavelengths in the +61 d spectrum, we truncate the data with $\lambda < 18000 \text{ \AA}$ (observer frame, as in Levan et al. 2024).

3.1.1 +29 day JWST observation

Our best-fitting model for the +29 day NIRSpec spectrum is presented in Figure 4, and the associated best-fitting parameters are summarised in Tables 1 and 2. For completeness, we present our best-fitting model extended to include the X-ray data that were used to constrain the AG component in Figure A1.

We find good agreement to the X-ray photometry and NIRSpec spectrum by invoking an afterglow amplitude, $\alpha = 6.0_{-1.4}^{+2.0} \times 10^{-39}$ and exponent, $\beta = -1.31 \pm 0.03$, and a blackbody with photospheric temperature and radius, $T_{\text{ph}} = 660 \pm 10 \text{ K}$ and $R_{\text{ph}} = 6.01 \pm 0.14 \times 10^{15} \text{ cm}$. These values are generally in line with those presented by previous works that fit the NIRSpec data (Gillanders et al. 2023a; Levan et al. 2024). Accurately accounting for the contribution of the continuum enables study of the spectral features that cause deviations from this \sim smooth model continuum. Visually, there appear to be three broad emission-like features; a blend of two features centred at $\sim 2.1 \mu\text{m}$, and a third centred at $\sim 4.4 \mu\text{m}$ (first identified by Levan et al. 2024).

We find the emission feature at $\sim 2.1 \mu\text{m}$ is best reproduced by the superposition of two distinct Gaussians, with central wavelengths of 20218_{-38}^{+37} and $21874 \pm 89 \text{ \AA}$. Levan et al. (2024) invoke two components to reproduce this $\sim 2.1 \mu\text{m}$ feature; they report line centroids of 20285 ± 10 and $22062 \pm 10 \text{ \AA}$, both with $v_{\text{FWHM}} = 0.064 \text{ c}$. However, a single emission feature is then invoked when attributing it to [Te III] (see Section 4.4.1). Gillanders et al. (2023a) also fit this feature, and present results obtained from invoking one or two components. For their two-component model, they report feature centroids, $\lambda \approx 20500, 22800 \text{ \AA}$, and widths, $v_{\text{FWHM}} \approx 0.079, 0.064 \text{ c}$. The variation between the results of Levan et al. (2024) and Gillanders et al. (2023a) can be interpreted as being due to the effects of different normalisation techniques. Both works fit the continuum slightly differently, which after subtraction leads to some deviation in the perceived feature centroids. The results from our analysis in this work somewhat agree with these previous estimates, but here we perform a (formally) more robust approach of simultaneously fitting the continuum contribution while also fitting the emission features, instead of subtracting the continuum contribution before feature fitting (as in Gillanders et al. 2023a; Levan et al. 2024). The latter approach may not accurately account for the uncertainty in the continuum when obtaining the best-fitting Gaussian parameters.

The feature at $\sim 4.4 \mu\text{m}$ can be well-reproduced with a single Gaussian component, with a centroid, $\lambda = 44168_{-152}^{+153} \text{ \AA}$, and $v_{\text{FWHM}} = 0.110_{-0.003}^{+0.001} \text{ c}$. Levan et al. (2024) do not perform any fitting of this feature. Gillanders et al. (2023a) report a line centroid, $\lambda \approx 43900 \text{ \AA}$, and width, $v_{\text{FWHM}} \approx 0.093 \text{ c}$. Our result presented here is somewhat deviant to this previously reported value, likely for the reason outlined above.

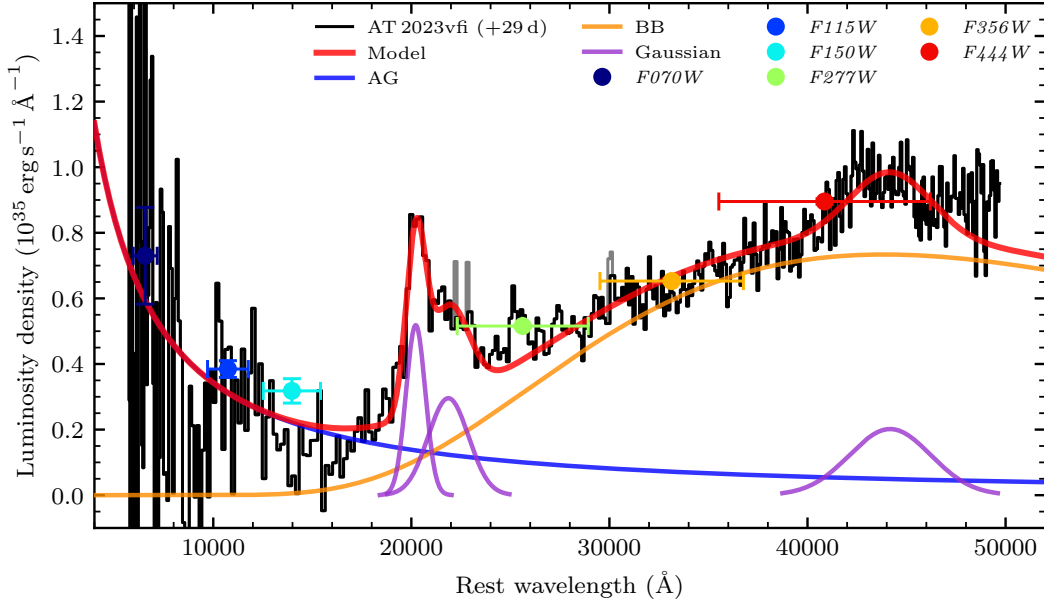

Figure 4. +29 day *JWST* NIRSpect spectrum of AT 2023vfi (black), compared to our best-fitting model (red). The background galaxy emission lines have been masked. The individual continuum components (i.e., AG, BB) are plotted (blue and orange, respectively), as are the individual Gaussian components (purple). The contemporaneous NIRCcam photometry is overlaid. Both the NIRCcam and NIRSpect data have been corrected for line-of-sight extinction, and shifted to the rest frame (see Section 2.1 for details).

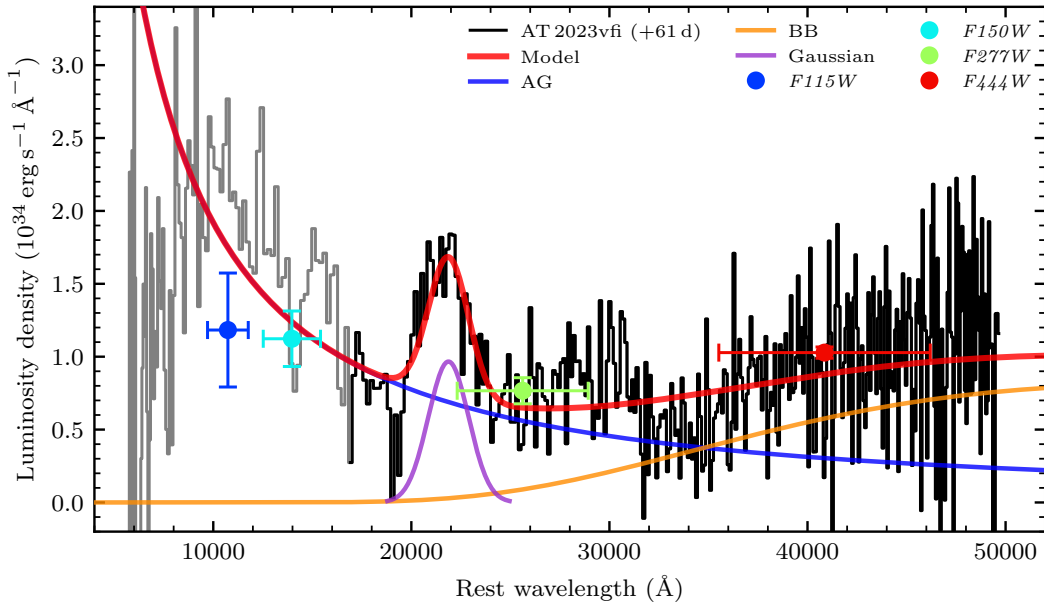

Figure 5. Same as Figure 4, but for the +61 day *JWST* NIRSpect spectrum of AT 2023vfi. Here the contaminated blue end of the spectrum has been masked.

3.1.2 +61 day *JWST* observation

Performing a similar analysis on the +61 d spectrum proves more difficult, since the transient has faded significantly, causing a drop in the signal-to-noise ratio (SNR). Additionally, it is no longer clear whether the spectrum can be accurately represented by a thermal continuum. Nevertheless, we apply the same method and recover a reasonable match to the data. We present our best-fitting model in Figures 5 and A2, and associated model parameters in Tables 1 and 2.

Our best-fitting model invokes an afterglow amplitude, $\alpha = 3.4^{+1.1}_{-0.8} \times 10^{39}$, with the same exponent as for +29 d ($\beta = -1.31 \pm 0.03$), and a blackbody with photospheric temperature and radius, $T_{\text{ph}} = 500^{+30}_{-20}$ K and $R_{\text{ph}} = 3.95^{+0.62}_{-0.61} \times 10^{15}$ cm. The decrease in α is expected, and is consistent with a fading source.

Table 1. Best-fitting continuum parameters for the *JWST* NIRSpec spectra of AT 2023vfi, and for the +10.4 d X-shooter spectrum of AT 2017gfo.

Phase (days)	α (10^{39})	β	T_{ph} (K)	R_{ph} (10^{15} cm)	v_{ph} (c)
AT 2023vfi					
+29	$6.0^{+2.0}_{-1.4}$	-1.31 ± 0.03	660 ± 10	6.01 ± 0.14	0.080 ± 0.002
+61	$3.4^{+1.1}_{-0.8}$	"	500^{+30}_{-20}	$3.95^{+0.62}_{-0.61}$	0.025 ± 0.004
AT 2017gfo					
+10.4	–	–	1630^{+150}_{-110}	$2.09^{+0.42}_{-0.43}$	$0.077^{+0.015}_{-0.016}$

Note. Errors are quoted to 1σ significance.

Table 2. Best-fitting parameters for the emission features in the *JWST* NIRSpec spectra of AT 2023vfi, and for the +10.4 d X-shooter spectrum of AT 2017gfo.

Phase (days)	Approx. λ_{peak} (μm)	λ_{peak} (\AA)	v_{FWHM} (c)	Peak (10^{34} erg s $^{-1}$ \AA^{-1})	Luminosity (10^{37} erg s $^{-1}$)
AT 2023vfi					
+29	2.0	20218^{+37}_{-38}	$0.057^{+0.006}_{-0.005}$	$5.17^{+0.35}_{-0.34}$	≈ 6.4
+29	2.2	21874 ± 89	$0.109^{+0.002}_{-0.004}$	2.96 ± 0.20	≈ 7.6
+29	4.4	44168^{+153}_{-152}	$0.110^{+0.001}_{-0.003}$	2.01 ± 0.14	≈ 10
+61	2.2	21874 ± 89	$0.109^{+0.002}_{-0.004}$	0.97 ± 0.09	≈ 2.5
AT 2017gfo					
+10.4	2.05	20530^{+140}_{-190} *	0.130 ± 0.011 *	34 ± 19	≈ 100
+10.4	2.13	21300^{+330}_{-260} *	"	62 ± 17	≈ 180

Note. Errors are quoted to 1σ significance.

* Our fitting procedure invokes fixed centroids and v_{FWHM} values across the +7.4 – 10.4 d sequence of X-shooter spectra of AT 2017gfo. Thus, the λ_{peak} and v_{FWHM} values quoted here for the +10.4 d spectrum also represent the best-fitting values across the +7.4, +8.4 and +9.4 d spectra.

We find no reason to invoke a variation in β ,⁷ indicating there is no evolution in the AG slope between +29 and +61 days (see also Yang et al. 2024).

Visually, there is still a clear flux excess at $\sim 2.1 \mu\text{m}$, the location of prominent emission at +29 days. There does not appear to be any similar excess at $\sim 4.4 \mu\text{m}$, the location of the other prominent flux excess at +29 days.

We find that we can adequately match this emission component by invoking the same centroid and width as was needed to reproduce the redder component of the blended $\sim 2.1 \mu\text{m}$ feature at +29 days (i.e., $\lambda = 21874 \pm 89 \text{\AA}$ and $v_{\text{FWHM}} = 0.109^{+0.002}_{-0.004}$ c). Levan et al. (2024) do not analyse this feature at +61 days. Gillanders et al. (2023a) fit it as a single component, and retrieve a line centroid, $\lambda \approx 22000 \text{\AA}$, and width, $v_{\text{FWHM}} \approx 0.173$ c. The mismatch between this previously reported value and our result here is again likely down to the different approaches for how the continuum was treated (see Section 3.1.1).

Next, we look at – and compare to – the prominent emission features in AT 2017gfo. For consistency, we need to first analyse them in a similar manner.

3.2 AT 2017gfo

As highlighted in Section 1, there is a notable emission feature present at $\sim 2.1 \mu\text{m}$ in the spectra of both AT 2023vfi and AT 2017gfo. This is easily visually inferred by comparing the spectra of both

transients (see e.g., Figure 14). To quantify the agreement between this feature in these two different transient events, we perform the same analysis on the late-time X-shooter spectra of AT 2017gfo as we performed above for the two *JWST* spectra of AT 2023vfi (as described in Section 3.1), with one exception. The viewing angle of AT 2017gfo was sufficiently off-axis ($\lesssim 30^\circ$; Hotokezaka et al. 2019; Dhawan et al. 2020; Wang et al. 2023) for the contribution of the afterglow contribution at the times and wavelengths sampled by X-shooter to be negligible, and so we do not include an afterglow component in our fitting routines (i.e., we fit the data considering L_{BB} and L_{G} contributions only).

The late-phase spectra of AT 2017gfo (> 7 days) are not easily reproduced by a single-temperature blackbody profile (see e.g., Waxman et al. 2018; Gillanders et al. 2022). The near-ultraviolet (near-UV) and optical wavelengths ($\lambda < 7000 \text{\AA}$) exhibit blanketed flux suppression, while there are multiple prominent spectral features across the $\sim 0.3 - 2.5 \mu\text{m}$ window of X-shooter (see e.g., Gillanders et al. 2022, 2024). However, the NIR regime above $\sim 1.5 \mu\text{m}$ for the +7.4 – 10.4 day X-shooter spectra can be well-reproduced with a single-temperature blackbody and three emission features centred at $\sim 1.6, 2.05$ and $2.13 \mu\text{m}$. Since we are interested specifically in the properties of the emission around $\sim 2.1 \mu\text{m}$ for comparison to AT 2023vfi, we focus our efforts on only modelling the NIR regime ($\lambda = 1.5 - 2.5 \mu\text{m}$) in this fashion, and ignore the complex continuum and spectral features at shorter wavelengths.

We stress that the continuum T and R values invoked in this analysis are not meant to be interpreted as estimates for the photospheric temperature and radius; the values obtained are merely those that were estimated through our simple empirical modelling to repro-

⁷ Performing an independent fitting process to the +29 and +61 d spectra recovers matching β values.

duce the ‘local continuum’ of the two NIR emission features from 1.5 – 2.5 μm . These values should not be used to infer the photospheric properties across the full X-shooter-sampled wavelength range (if a ν -independent photospheric approximation is even a valid assumption at these late phases).

3.2.1 +7.4 – 10.4 day X-shooter observations

Here we fit the +7.4 – 10.4 day X-shooter spectra with fixed feature centroids and widths, while the feature peak and continuum values are allowed to freely vary between epochs. From this approach, we obtain reasonable fits for the 1.5 – 2.5 μm spectral range for all four epochs (see Figure B1). The best-fitting parameters invoked for our fitting of the +10.4 d spectrum are presented in Tables 1 and 2.

With our local continua reasonably well parameterised, we now focus on the properties of the emission features. While we have fit the $\sim 1.6 \mu\text{m}$ emission component to accurately constrain the NIR X-shooter data, we are not specifically interested in the results obtained for this feature. Nevertheless, for posterity and for comparison with the work of Gillanders et al. (2024), we present them here. For the $\sim 1.6 \mu\text{m}$ feature, we find best-fitting values for the centroid and velocity width of $\lambda_{\text{peak}} = 15860 \pm 90 \text{ \AA}$ and $v_{\text{FWHM}} = 0.080^{+0.028}_{-0.018} c$, respectively. Gillanders et al. (2024) estimate $\lambda_{\text{peak}} \approx 15800 \text{ \AA}$ and $v_{\text{FWHM}} \approx 0.097 c$, which agree well with our new estimates. For the blended $\sim 2.1 \mu\text{m}$ emission feature, Gillanders et al. (2024) estimate $\lambda_{\text{peak}} \approx 20590, 21350 \text{ \AA}$ with $v_{\text{FWHM}} \approx 0.130 c$ for both components. Again, these values match our new estimates well ($\lambda_{\text{peak}} = 20530^{+140}_{-190}, 21300^{+330}_{-260} \text{ \AA}$ and $v_{\text{FWHM}} = 0.130 \pm 0.011 c$ for both components). We note that in Gillanders et al. (2024), they assumed a flat local continuum, normalised the spectrum, and then modelled each emission feature with a Gaussian profile (one or multiple). Here we perform a more complete analysis, whereby we simultaneously model the continuum and emission features. Despite the different treatments for the local continua, we obtain similar results for the properties of the emission features.

Our models here reproduce the data well, as shown by the comparisons presented in Figure B1. We conclude that a single transition at 1.5860 μm , and two blended transitions at 2.0530 and 2.1300 μm can explain the spectra well, but the velocity width of the lines are discrepant, with $v_{\text{FWHM}}(c) = 0.080^{+0.028}_{-0.018}$ for the 1.5860 μm line and $v_{\text{FWHM}}(c) = 0.130 \pm 0.011$ for the 2.0530, 2.1300 μm lines (see Table 2). This may indicate that they arise from different regions of the ejecta. Alternatively, it could be evidence for these features being composed of a blend of multiple/many emission lines, in which case we cannot accurately constrain the velocity of the line-forming region via this fitting procedure.

4 LINE IDENTIFICATION SEARCH

With accurate estimates for the positions of the feature centroids in the *JWST* spectra of AT2023vfi (and the late-time X-shooter spectra of AT2017gfo), we now perform a detailed line identification study to search for candidate transitions that plausibly produce these emission features. Here we focus specifically on forbidden transitions, which are expected to dominate late-time emission features in kilonova spectra.

Forbidden transitions have already been shown to be important for understanding the nebular spectral features of core-collapse and type Ia SNe (see e.g., Mazzali et al. 2001; Dessart & Hillier 2011; Jerkstrand 2017; Shingles et al. 2020), and several works have also highlighted their importance and the potential effects they may have

on late-phase KN spectra (e.g., Hotokezaka et al. 2021, 2022; Pognan et al. 2022a,b, 2023). However, at least for the KN case, detailed forbidden transition studies are hampered by the incompleteness of the line lists for r -process species. Therefore, recent studies have resorted to using forbidden line information derived from theoretical calculations (Hotokezaka et al. 2021; Pognan et al. 2023). These typically have uncertain wavelengths, which impacts line identification studies.

Gillanders et al. (2024) follow a different approach to search for candidate forbidden transitions that may be responsible for producing the emission features in the late-phase spectra of the kilonova AT2017gfo. They used the level information from the National Institute of Standards and Technology Atomic Spectra Data base (NIST ASD; Kramida et al. 2023) to estimate the transition wavelengths for all possible transitions between all levels of each ion. Then, by considering the transition rules for forbidden transitions, a shortlist was obtained for each ion under investigation. Since all energy levels within the NIST ASD have been critically evaluated, they possess accurate energies, meaning the transitions derived via this method have robust wavelengths, accurate enough for line identification studies. However, this method does suffer from the issue of not providing oscillator strengths and collision strengths. Such information is needed to undertake a quantitative study of KNe including non-local thermodynamic equilibrium (non-LTE) effects, such as that carried out by Pognan et al. (2023).

Throughout this section, unless otherwise highlighted, we quote the wavelengths of the transitions as in vacuum; to access the equivalent air wavelengths, see Table 3.

4.1 Methodology

Here we follow the method presented by Gillanders et al. (2024). Below we summarise the main steps, and highlight any deviations from the previously established methodology.

We begin by extracting the level information from the NIST ASD (Kramida et al. 2023) for all elements with $Z = 30 - 92$ (Zn to U), for the lowest four ionisation stages (neutral to triply ionised; i.e., $\text{I} - \text{IV}$). Previous analysis focussed on $Z = 38 - 92$ (Sr to U), and on the lowest three ion stages (neutral to doubly ionised; motivated by LTE ionisation arguments). Here we extend our analysis to lower Z (for completeness and to capture line information for the lightest species; see Figure 8) and we also consider the triply ionised stage. While we do not anticipate significant quantities of ejecta material to be triply ionised due to thermal ionisation effects, it is reasonable to expect this level of ionisation can be achieved through non-thermal mechanisms (see Pognan et al. 2023).

With this level information, we compute the wavelengths of all possible transitions between all levels for each ion. We truncate the list to exclude any lines that originate from an upper level with energy greater than the first ionisation limit (also extracted from the NIST ASD; Kramida et al. 2023). Both M1 and E2 transitions require parity to be conserved. M1 transitions can only possess variations in quantum J number, $\Delta J = 0, \pm 1$ (but not $J = 0 \leftrightarrow 0$), while E2 transitions can only have $\Delta J = 0, \pm 1, \pm 2$ (but not $J = 0 \leftrightarrow 0, 0 \leftrightarrow 1$ or $1/2 \leftrightarrow 1/2$). We apply these additional restrictions to our line lists, and discard any transitions that do not obey these criteria. Finally, for the transitions that possess level information expressed in the LS -coupling formalism, we apply the LS -coupling rules, and discard transitions that do not comply.

In a nebular regime, the emitted line luminosity (L_{em}) for a tran-

sition can be expressed by:

$$L_{\text{em}} = A_{\text{UL}} \cdot N_{\text{U}} \left(\frac{hc}{\lambda_{\text{vac}}} \right), \quad (6)$$

where A_{UL} and λ_{vac} are the Einstein A -value and vacuum wavelength of the transition, respectively, and N_{U} is the number of atoms/ions excited to the upper level. As our synthetic line lists do not possess any estimates for intrinsic line strengths, we assume equal Einstein A -coefficients for all transitions ($A_{\text{UL}} = 1 \text{ s}^{-1}$), meaning the *relative* line luminosities for a species depend only on N_{U} and λ_{vac} .

We estimate level populations using the Boltzmann equation:

$$N_{\text{U}} = N_{\text{T}} \left(\frac{g_{\text{U}}}{Z} \right) \cdot \exp \left[-\frac{E_{\text{U}}}{k_{\text{B}}T} \right], \quad (7)$$

where N_{T} is the total number of atoms or ions, g_{U} is the statistical weight of the upper level, Z is the LTE partition function, E_{U} is the energy of the upper level, and T is the temperature. However, we cannot directly constrain N_{U} without estimates for the ejecta mass and composition, and so we instead compute relative level populations, which only depend on g_{U} , E_{U} and T . We compute our level population estimates for three representative temperature cases:

- $T = 1000 \text{ K}$, motivated by the continuum T estimates for the *JWST* NIRSpec spectra of AT 2023vfi (see Section 3.1),
- $T = 3000 \text{ K}$, motivated by continuum T estimates for the late-time X-shooter spectra of AT 2017gfo (see e.g., Waxman et al. 2018),
- $T = 5000 \text{ K}$, which represents the proposed typical temperature for nebular phase KN ejecta (see e.g., Hotokezaka et al. 2021).

With these relative level populations, we compute luminosity estimates for each transition (as in Equation 6), normalised to the line with the largest luminosity that has a wavelength within $\lambda = 1 - 5 \mu\text{m}$ (the approximate range of rest wavelengths of AT 2023vfi sampled by the *JWST* NIRSpec observations).⁸ Since we are interested in the forbidden transitions we expect to be most prominent for each species, we cut any from our shortlists that have a line strength < 0.01 that of the strongest line in our wavelength range.

Finally, we have estimates for the centroids of the observed emission features of AT 2023vfi (and AT 2017gfo; see Section 3). We report a candidate transition for these features if it satisfies the following criteria:

- It is expected to be (one of) the strongest emission transition(s) for the species,
- It does not possess a large number of other transitions that are also expected to be prominent, but which do not correspond to any observed emission,
- It lies within a $0.04 c$ Doppler width of the measured centroid of the line (justified in Section 4.2),
- The upper energy level of the transition has $E_{\text{U}} \leq 4 \text{ eV}$.⁹

While this approach does come with some uncertainty, it is capable of returning a subset of viable candidate line identifications (as previously demonstrated for the case of AT 2017gfo; see Gillanders et al. 2024), which we present in Section 4.3.

We note that our approach and results presented here are easily updated when Einstein A -values become available. Due to how we have performed our analysis, one can simply multiply our relative

line strength estimates by the A -values to get updated line strengths (for LTE level populations at $T = 3000 \text{ K}$).

4.2 Wavelength windows for line search

In Gillanders et al. (2024), a transition was considered to be coincident with the observed emission features if it lies within a Doppler width of $0.02 c$ from the measured centroid of the emission features. Here we relax this tolerable window to $0.04 c$ (see Section 4.1) based on a number of points, presented below.

Our approach assumes that the observed emission features are dominated by emission from a single transition (or a small subset of transitions) from a single ion, centred on (or close to) the rest wavelengths of the lines. As such, our shortlisting approach suffers from two limitations.

First, we are not able to fully capture the effects of features being offset from their rest wavelengths. In nebular phase spectra of SNe, it is common to see emission features centred on their rest wavelengths, but we note there are a number of exceptions to this. In some fast-fading transients, significant offsets have been observed for the [Ca II] doublet transitions. Foley (2015) study the properties of 13 Ca-strong transients, and estimate the velocity shifts present in the nebular-phase [Ca II] spectral features. These values vary across the sample, but are on the order of $\sim 1000 \text{ km s}^{-1}$ ($0.003 c$). The largest measured shift is -1730 km s^{-1} ($-0.006 c$), and belongs to SN 2012hn.

Other transients aside from Ca-strong SNe also exhibit velocity shifts. AT 2018kzr was a rapidly declining transient suggested to be produced by the merger of an oxygen–neon white dwarf star with either a neutron star or a (stellar mass) black hole (McBrien et al. 2019; Gillanders et al. 2020; see also Bobrick et al. 2022). The late-time spectra obtained for AT 2018kzr possessed prominent Ca II NIR triplet features, from which a velocity shift of -2300 km s^{-1} ($-0.008 c$) was measured (Gillanders et al. 2020). We note that observing a shift in this WD–NS/BH merger system is relevant, as GRB 230307A is also likely produced by a merger system.

Finally, SN 2019bkc is an unusual Ca-strong transient with an extremely rapid evolution (Chen et al. 2020; Prentice et al. 2020). Notably, the late-time spectral observations presented by Prentice et al. (2020) exhibit extremely blueshifted Ca II and [Ca II] features. Prentice et al. (2020) measure these offsets and record blueshifts for the Ca II NIR triplet and [Ca II] doublet transitions of $10000 - 12000 \text{ km s}^{-1}$ ($0.033 - 0.040 c$). Prentice et al. (2020) note that the late-time spectra also plausibly contain two O I emission features ($\lambda 7772, 9263$) which exhibit a $\sim 10000 \text{ km s}^{-1}$ ($0.033 c$) blueshift.

With the exception of the tentative O I features in SN 2019bkc, it seems that Ca II is the ion that predominantly exhibits velocity offsets in explosive transient observations. This may be due to the high opacity associated with the NIR triplet, and if so, indicates that these observed offsets result from some type of opacity effect, rather than bulk velocity or ejecta inhomogeneity effects.

Clearly it is possible, at least in some cases, for feature offsets to be observed in late-time spectra of explosive transients. The magnitude of any feature offsets in late-time KN spectra is hard to quantify given the lack of observed systems and the lack of robust feature identifications, with one notable exception. Gillanders et al. (2024) present analysis of the post-photospheric phase spectra of AT 2017gfo, with a focus on fitting the prominent emission features at late times. There they measure the centroid of a prominent emission feature at $\sim 1.08 \mu\text{m}$ in the +7.4 d X-shooter spectrum of AT 2017gfo. Assuming this feature is dominated by late-time Sr II NIR triplet emission,

⁸ Note the slightly different approach to that presented by Gillanders et al. (2024). There, they presented the relative upper level population as a representation for transition strength.

⁹ We set this deliberately high threshold to account for any non-thermal and non-LTE excitation effects.

they estimate that the feature possesses a redshifted offset velocity of 9800 km s^{-1} ($0.033 c$).

Given the set of example cases above, clearly it is possible for some systems to produce emission features somewhat deviant from the rest wavelengths of the transitions powering them. Such effects in the case of AT 2023vfi may impact our ability to infer the correct line identifications for the observed emission features, as in Section 4.3.

Second, our assumption that the emission features are dominated by emission from a single ion may impact our inferences of the true feature centroids. There are expected to be many forbidden transitions belonging to the heavy r -process species that have been synthesised, and as such line blending may be common. Quantitative modelling of KN spectra has shown that the assumption of a single strong emitter being completely responsible for emission features may be overly simplistic (see e.g., Kasen et al. 2017; Pognan et al. 2023; Shingles et al. 2023). However, without the ability to undertake detailed modelling of KNe at late times, with full atomic line lists for all relevant r -process elements, we cannot quantify the likelihood of this scenario in the case of AT 2023vfi.

To account for the above effects, we set our tolerable window to a Doppler width of $0.04 c$ (compared to the $0.02 c$ tolerable window of Gillanders et al. 2024) and perform a search for candidate transitions, which we present below (Section 4.3). This approach allows us to capture a larger subset of transitions that may contribute to these features (allowing for the effects above) without having to undertake a quantitative detailed investigation; such a study with detailed radiative transfer is earmarked for future investigation. In the figures showing candidate transitions (e.g., Figure 6) we highlight both the 0.02 and $0.04 c$ tolerable windows separately for clarity.

4.3 Candidate ions

The transitions we recover for our analysis that can plausibly power the observed emission features in the *JWST* NIRSpec spectra of AT 2023vfi are summarised in Table 3. We present the estimated relative strength of all transitions for the $T = 3000 \text{ K}$ case, and where variations in T significantly impact our results, we discuss the potential implications. We recover a list of possible contributing species, which we discuss in turn below. Where we present the number of transitions recovered by our analysis, this corresponds to all transitions that satisfy all steps of our shortlisting process, as listed in Section 4.1.

4.3.1 Candidate transitions for the $2.0218 \mu\text{m}$ observed feature

- **[Ba II]:** We recover two transitions for [Ba II], with wavelengths of 17622 and 20518 \AA (see Figure 9). There is no observational evidence for the stronger 17622 \AA transition. At lower T , the 20518 \AA becomes the dominant transition, but we still expect the 17622 \AA line to persist.

- **[Ho IV]:** Seven lines recovered from our shortlisting; the most prominent has a wavelength of 19806 \AA , and lies within our $0.04 c$ tolerable window (see Figure C1).

- **[Er I]:** We recover 46 lines, but many of these lie close to our lower bound on relative strength, and so are expected to be negligibly weak. We identify a strong line at a wavelength of 19860 \AA , just within our tolerable threshold for the $2.0218 \mu\text{m}$ emission feature (see Figure 11). The next most prominent transition lies at 14371 \AA , for which we do not see evidence in the observations.

- **[Er II]:** We recover 51 lines in our analysis, but as in the Er I case, many of these are expected to be negligibly weak. There are three

strong lines at 19483 , 21312 and 20148 \AA , which are coincident with the $2.0218 \mu\text{m}$ (19483 , 20148 \AA) and $2.1874 \mu\text{m}$ features (21312 \AA). There are four other prominent lines between $\sim 1.4 - 1.5 \mu\text{m}$, for which we do not see prominent emission in the observations (see Figure 11).

- **[Er III]:** Four lines satisfy our cuts, with the strongest having a wavelength of 19678 \AA , coincident with the $2.0218 \mu\text{m}$ feature (see Figure 11). We find a weaker (but still prominent) contaminant line at 14348 \AA that does not match the data.

- **[Os I]:** We recover 22 lines, of which only three are expected to be prominent; these have wavelengths of 19440 , 24042 and 36490 \AA (see Figure C2). The strongest line at $T = 3000 \text{ K}$ is the 19440 \AA transition, the one coincident with the $2.0218 \mu\text{m}$ feature. These other lines do not match the observational data. At higher T , the contaminant lines become less prominent (see Figure C14 to visualise line strength estimates across the range of explored T values).

- **[Ir II]:** We shortlist 12 lines from our analysis, but the line at 20886 \AA is expected to be much stronger than the rest (see Figure C3).

- **[Ra II]:** One line recovered in our analysis within our wavelength cut of $1 \leq \lambda \leq 5 \mu\text{m}$; it has a wavelength of 20587 \AA (see Figure 9).

4.3.2 Candidate transitions for the $2.1874 \mu\text{m}$ observed feature

- **[Kr III]:** We shortlist two transitions, with wavelengths of 21986 and 18822 \AA . The 21986 \AA transition is predicted to be significantly more prominent than the 18822 \AA transition, as needed to match observation (see Figure C4).

- **[Pd III]:** We recover four transitions, of which two are expected to be most prominent; these have wavelengths of 21338 and 30967 \AA (see Figure C5). The 21338 \AA transition increases in relative strength with increasing T , but we find that across our range of T values considered, the contaminant 30967 \AA line is always dominant (see Figure C15 to visualise line strength estimates across the range of explored T values).

- **[Ag III]:** We recover a single transition, with a wavelength of 21696 \AA , coincident with the $2.1874 \mu\text{m}$ feature (see Figure C6).

- **[Te I]:** Two transitions shortlisted from our analysis; these have wavelengths of 21049 and 21247 \AA . The 21049 \AA line lies exactly between the estimated centroids of the 2.0218 and $2.1874 \mu\text{m}$ features. The 21247 \AA transition is coincident with the observed emission feature at $2.1874 \mu\text{m}$ in both the +29 and +61 d spectra (see Figure 6). The 21049 \AA transition is $\sim 3\times$ stronger, due to it having a $3\times$ larger statistical weight for its upper level ($g_u = 3$ versus 1; the upper level energies are near-identical). Both transitions are too blue to satisfy our $0.02 c$ tolerable window for the $2.1874 \mu\text{m}$ feature, but lie within our expanded $0.04 c$ range.

- **[Te III]:** Only three transitions are recovered from our analysis, with the strongest having a wavelength of 21050 \AA (at an almost identical wavelength to the [Te I] transition discussed above). This transition lies exactly between the estimated centroids of the 2.0218 and $2.1874 \mu\text{m}$ emission features. It makes our selection cut as it lies within the $0.04 c$ range of the $2.1874 \mu\text{m}$ feature (see Figure 6). The other two transitions have wavelengths of 12248 and 29290 \AA , and there is no observational evidence for either of them in the observed data. While subdominant to the 21050 \AA line, we still expect them to be detectable based on our analysis here.

- **[Er II]:** See Section 4.3.1. The 21312 \AA line is coincident with the $2.1874 \mu\text{m}$ feature (see Figure 11).

- **[Hf I]:** We recover 12 lines from our analysis, with the strongest three having wavelengths, $\lambda = 42433$, 21893 and 45229 \AA , and $L_{\text{em}} = 1.0$, 0.86 and 0.42 respectively (see Figure C7). The 21893 \AA

line is coincident with the $2.1874\ \mu\text{m}$ feature, while the 42433 and $45229\ \text{\AA}$ transitions lie blueward and slightly redward of the $4.4168\ \mu\text{m}$ feature centroid (but lie within the $0.04\ \text{c}$ tolerable window), respectively.

- **[W III]:** We recover 13 transitions that satisfy our cuts, of which only five are expected to be prominent; these have wavelengths (ordered by line strength) of 22416, 44322, 24866, 45352 and $31003\ \text{\AA}$ (see Figure 12). The strongest transition at $T = 3000\ \text{K}$ ($22416\ \text{\AA}$) is coincident with the $2.1874\ \mu\text{m}$ feature, and the 44322, $45352\ \text{\AA}$ lines are coincident with the $4.4168\ \mu\text{m}$ feature. The other two prominent transitions do not match the observational data.

- **[Pt II]:** Eight transitions recovered, but two are expected to be much more prominent than the others. These have wavelengths and strengths, $\lambda_{\text{vac}} = 11877, 21883\ \text{\AA}$, and $L_{\text{em}} = 1.0, 0.69$, respectively (see Figure 13). The $11877\ \text{\AA}$ line is expected to be more prominent, although at higher T , the relative strength of the $21883\ \text{\AA}$ line increases.

4.3.3 Candidate transitions for the $4.4168\ \mu\text{m}$ observed feature

- **[Se III]:** We shortlist just two transitions, with wavelengths of 25401 and $45549\ \text{\AA}$. There is no observational evidence in support of the $25401\ \text{\AA}$ line, but the $45549\ \text{\AA}$ line lies within the tolerable range of the $4.4168\ \mu\text{m}$ feature (see Figure C8).

- **[Nb IV]:** Four lines are shortlisted, but the only one we expect to be prominent has a wavelength of $42637\ \text{\AA}$ (see Figure C9).

- **[In I]:** We recover a single line with a wavelength of $45196\ \text{\AA}$ (see Figure C10).

- **[Te II]:** We recover two transitions, but only the $45466\ \text{\AA}$ line is expected to be prominent (see Figure 6).

- **[Ce IV]:** We recover only one transition with a wavelength of $44391\ \text{\AA}$, coincident with the $4.4168\ \mu\text{m}$ feature (see Figure C11).

- **[Sm IV]:** We recover 26 lines in our analysis, with the strongest four having wavelengths of $35024, 37010, 39485$ and $43656\ \text{\AA}$ (see Figure C12). The $43656\ \text{\AA}$ line is the most prominent transition across our range of T values, but the contaminant lines increase in relative strength with increasing T (see Figure C16 to visualise the variation in relative line strength estimates across the range of explored T values). We find we best match the data with low T , which reduces the prominence of the $35024, 37010$ and $39485\ \text{\AA}$ lines, in addition to the grouping of contaminant lines between $\sim 1 - 2\ \mu\text{m}$ (see Figures C12 and C16).

- **[Hf I]:** See Section 4.3.2 and Figure C7. The 42433 and $45229\ \text{\AA}$ lines are coincident with the $4.4168\ \mu\text{m}$ feature.

- **[W III]:** See Section 4.3.2 and Figure 12. The second and fourth strongest transitions at $T = 3000\ \text{K}$ (44322 and $45352\ \text{\AA}$, respectively) are coincident with the $4.4168\ \mu\text{m}$ feature. At lower T , the $44322\ \text{\AA}$ becomes the most prominent transition (see Figure C17 to visualise line strength estimates across the range of explored T values).

- **[Ac I]:** Three transitions recovered, but only one is expected to be prominent; it has a wavelength of $44814\ \text{\AA}$ (see Figure C13).

4.4 Discussion

From our line identification analysis, we have produced a shortlist of candidate species that may feasibly be contributing to the observed emission features in the +29 and +61 day *JWST* NIRSpec spectra of AT 2023vfi. This list of ions includes the ‘light’ ($30 \leq Z \leq 56$) r -process species Se III, Kr III, Nb IV, Pd III, Ag III, In I, Te I–III and Ba II, the lanthanide ($57 \leq Z \leq 71$) species Ce IV, Sm IV, Ho IV and

Er I–III, and the ‘heavy’ ($72 \leq Z \leq 92$) r -process species Hf I, W III, Os I, Ir II, Pt II, Ra II and Ac I.

The majority of the lines that we shortlist here and expect to be most prominent correspond to fine-structure transitions between the ground terms of the species under investigation. These transitions are expected to be among the most prominent forbidden emission transitions, and are expected to dominate nebular phase emission in kilonovae (see Hotokezaka et al. 2022).

While our shortlist of candidates seems long, we note that it provides a significant reduction to the list of possible ions that warrant prioritised detailed atomic data studies for advancing our understanding of KNe, specifically AT 2023vfi. Given the number of elements considered in this line identification search ($30 \leq Z \leq 92$) and four ionisation stages for each element, the initial list of ions under consideration was 252; our shortlist here contains just 23 ions. This analysis here represents an order-of-magnitude reduction in the ions that should be investigated first to more completely model the spectra of AT 2023vfi. As such, we propose the list above represents the ions that should be investigated to more fully understand the late-time emission present in AT 2023vfi.

While all of the above proposed species warrant further study, below we discuss a few ions of particular interest.

4.4.1 [Te I], [Te II] and [Te III]

Much has been made of the possible detection of Te (specifically Te III) in the spectra of both AT 2017gfo and AT 2023vfi (Hotokezaka et al. 2023; Gillanders et al. 2023a, 2024; Levan et al. 2024). The line that has sparked such conclusions is the result of a [Te III] fine-structure transition with a rest wavelength, $\lambda_{\text{vac}} = 21050\ \text{\AA}$. This line has been observed in NIR spectra of two planetary nebulae by Madonna et al. (2018), who quote a measured line position of $2.1019\ \mu\text{m}$. This transition lies redward of the observed $2.0218\ \mu\text{m}$ emission feature, and blueward of the observed $2.1874\ \mu\text{m}$ emission feature. It is shortlisted here in this work as it lies within the $0.04\ \text{c}$ tolerable window of the $2.1874\ \mu\text{m}$ observed emission feature (see Figure 6 and Table 3). In fact, this transition lies exactly at the average of the two observed peaks ($\lambda_{\text{AV}} = 21046\ \text{\AA}$). For Te III to be responsible for producing either of these observed features, we would need some opacity, line blanketing or bulk velocity offset effects to explain why the observed peaks are shifted from the rest wavelength of the transition. While we cannot rule out such effects, and thus cannot rule out Te III being the source of (one of) the emission feature(s) observed in both AT 2017gfo and AT 2023vfi, we also cannot definitively state that Te III is the source. Thus, caution should be applied to this (and any other) proposed line identification until more robust evidence is presented (e.g., multiple emission features well-matched by several transitions from the same ion; cf., Ca II H&K and NIR triplet transitions in SN spectra).

Another point of consideration with regards [Te III] as a source of the observed emission is that we find that there are three transitions that we expect to be prominent, with wavelengths, $\lambda_{\text{vac}} = 12248, 21050$ and $29290\ \text{\AA}$. All three of these are transitions between the fine-structure levels in the ground term ($5s^2 5p^2\ ^3P$), all of which we expect to be significantly populated. As such, all three of these transitions are expected to be somewhat prominent in our analysis, with the $21050\ \text{\AA}$ line being the strongest (see Figure 6). There is no obser-

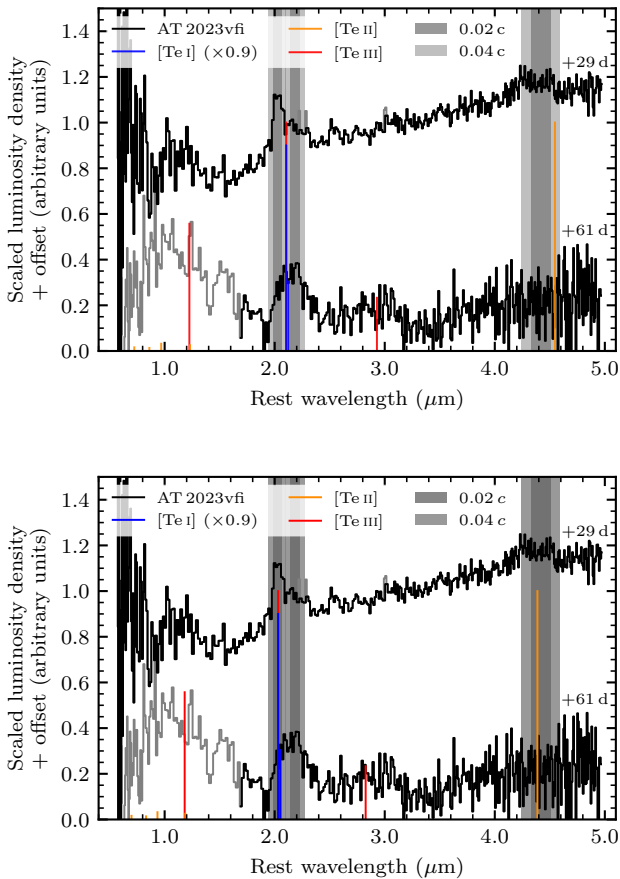

Figure 6. *Upper:* Comparison of our [Te I], [Te II] and [Te III] emission line spectra and the (arbitrarily re-scaled and offset) +29 and +61 d JWST spectra of AT 2023vfi (annotated with their phase relative to the GRB trigger). The vertical bands represent the 0.02 and 0.04 c tolerable windows considered for each feature (dark and light grey, respectively), where lines that lie within these bands are considered to plausibly match the observed emission features. Emission lines are plotted with their relative strengths (computed for $T = 3000$ K) reflected by their prominence. The lines have been normalised for each ion such that the strongest line between $1 - 5 \mu\text{m}$ has a luminosity value of 1 (we re-scale [Te I] by a constant factor to improve clarity between the overlapping [Te I] $\lambda 21049$ and [Te III] $\lambda 21050$ lines). *Lower:* Same as the upper panel, but with a constant blueshift of $0.035 c$ applied to all emission lines of [Te I], [Te II] and [Te III].

vational evidence for the 12248^{10} and 29290 \AA lines. Madonna et al. (2018) present A -values for a number of [Te III] transitions, including the three shortlisted here in this work. They quote $A_{UL} = 0.012, 1.19$ and 0.52 s^{-1} for the $12248, 21050$ and 29290 \AA lines, respectively. With this additional information, it is clear that the 12248 \AA line will be much weaker than our estimate here, and thus not detectable.

With our relative line strength estimates for [Te III] and the measured luminosity estimates for the +29 and +61 d 2.0218 and $2.1874 \mu\text{m}$ emission features (see Table 2), we compute the expected emission profiles for the [Te III] 29290 \AA line. By assuming that the emission feature at $2.0218 \mu\text{m}$ is powered entirely by [Te III] $\lambda 21050$,

¹⁰ There may be a noisy flux excess present in the +29 d JWST spectrum of AT 2023vfi that is coincident with the location of this 12248 \AA transition; see the discussion in Section 4.4.5.

we can compute the emitted luminosity of the 29290 \AA line from our relative strength estimates and the A -values from Madonna et al. (2018). We maintain the same v_{FWHM} value, and assume the same offset as observed between the 21050 \AA line and the $2.0218 \mu\text{m}$ emission feature ($\Delta\lambda = -832 \text{ \AA}$; i.e., the emission feature computed for 29290 \AA is centred at 28458 \AA). We also perform the same process for the $2.1874 \mu\text{m}$ emission feature at both +29 and +61 d, and centre it on 30114 \AA . These computed emission line profiles are presented in Figure 7.

We find that at $T = 5000 \text{ K}$, the expected emission from the 29290 \AA line barely rises above the continuum noise at both +29 and +61 days; therefore, it seems plausible that our observations contain prominent [Te III] emission from the 21050 \AA line, but no detectable signal from the 12248 and 29290 \AA lines. The relative strength of the 29290 \AA line decreases with decreasing T , and so for the other temperatures explored in this work ($T = 1000, 3000 \text{ K}$), the 29290 \AA line is expected to be even weaker than the profiles shown in Figure 7. Hotokezaka et al. (2023) find that this 29290 \AA line is not prominent in their models for the $+7.4 - 10.4 \text{ d}$ X-shooter spectra of AT 2017gfo (assuming $T_e = 2000 \text{ K}$), although they note the line becomes more prominent with increasing T . Their models do have a prominent feature close to this wavelength, but it is attributed to more prominent emission from [Os II]. We agree with the conclusion of Hotokezaka et al. (2023) that higher T is necessary for this line to become prominent, and we also conclude that it is likely not detectable above the noise in the existing JWST spectra of AT 2023vfi.

Finally, we estimate that if the upper level population was $\sim 3\times$ higher than that computed assuming LTE level populations at $T = 5000 \text{ K}$, the 29290 \AA line would become detectable. Deviations from LTE level population estimates of this magnitude may be obtainable when considering full non-thermal and non-LTE effects.

For the [Te I] case, we find that there are two transitions that are expected to be prominent, both of which lie within the $0.04 c$ tolerable window of the $2.1874 \mu\text{m}$ feature; these have $\lambda_{\text{vac}} = 21049$ and 21247 \AA (see Figure 6 and Table 3). As in the [Te III] case, these lines do not exactly match the feature centroids at either 2.0218 or $2.1874 \mu\text{m}$. We note that the 21049 \AA line exactly matches the average of the two observed emission peaks. The same arguments for [Te III] apply here too – perhaps some bulk offset or line blending effect is conspiring to shift the apparent feature peak away from the rest wavelengths of these lines. Also, we note that we typically would not expect significant neutral Te to exist alongside doubly ionised material in an LTE regime; however, non-LTE and non-thermal effects can cause multiple ion stages to co-exist, and so it remains possible that some combination of Te I, II and III all exist in some significant fraction and contribute to the observed emission features (see Pognan et al. 2022a). Hotokezaka et al. (2023) suggest that the contribution of [Te I] emission compared to [Te III] in AT 2017gfo should be sub-dominant.

Finally, Te II only possesses a single strong transition in our analysis, with $\lambda_{\text{vac}} = 45466 \text{ \AA}$. We find this line lies within the $0.04 c$ tolerable window of the emission feature at $4.4168 \mu\text{m}$. It is too red to exactly match the emission feature, but as noted above, this offset may be explainable. Clearly, if Te II exists in any significant quantity in the ejecta, the most promising method of detection would be emission centred near 45466 \AA . Also, it may be possible in some regimes for singly ionised Te to co-exist alongside doubly ionised and/or neutral Te. In this case, the identification of emission features belonging to multiple ionisation stages of Te is notable, as, if true, it would mark the first instance of multiple features in KN spectra being linked to the same element.

We note that all proposed line identifications for Te I, II and III

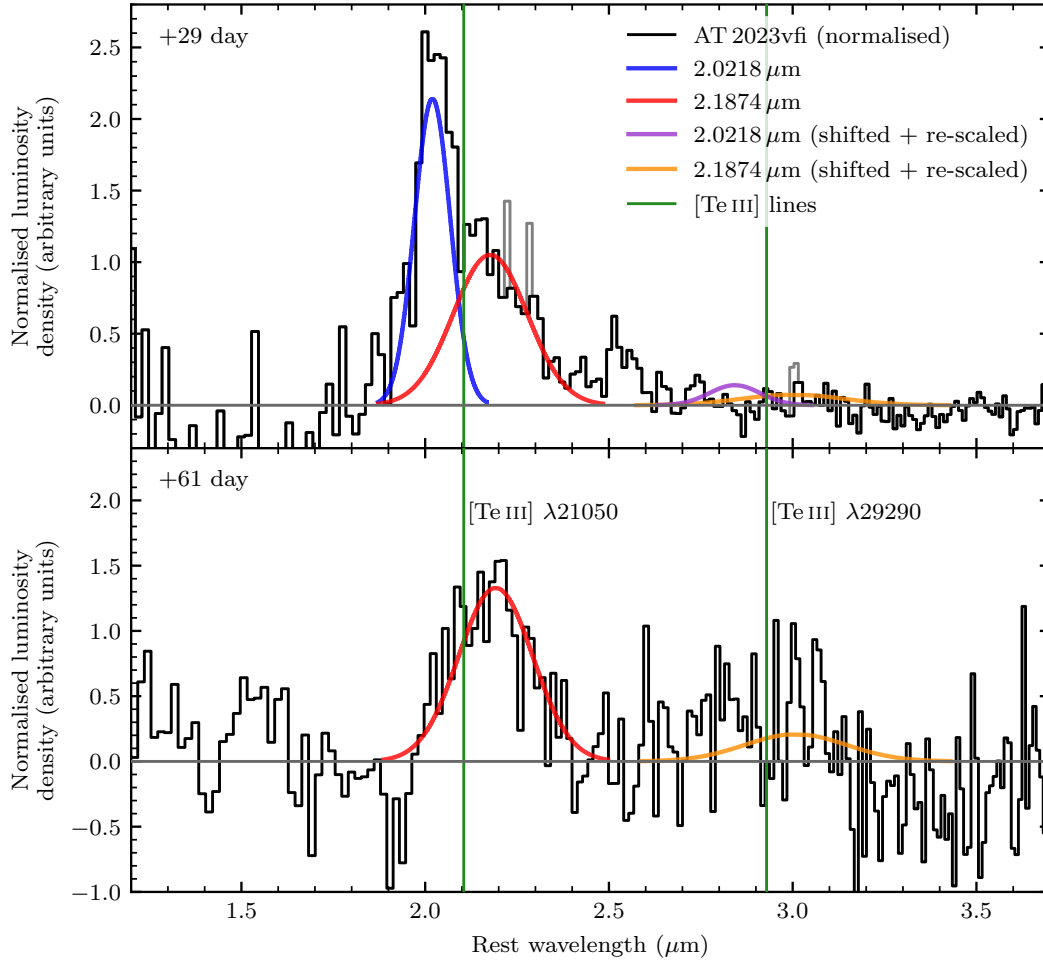

Figure 7. *Upper:* +29 day *JWST* spectrum of AT 2023vfi, continuum-subtracted (model AG+BB continuum; see Table 1) and normalised (black), compared with our best-fitting model Gaussian fits for the 2.0218 and 2.1874 μm features (blue and red, respectively). The emission line profiles for the [Te III] 29290 \AA line are computed assuming these two emission features are powered by [Te III] $\lambda 21050$ (see the main text), and are also plotted (purple and orange, respectively). The rest wavelengths of the [Te III] $\lambda\lambda 21050$, 29290 lines are marked (vertical green lines). *Lower:* Same as the upper panel, but for the +61 day *JWST* spectrum and the 2.1874 μm feature.

are systematically too red to exactly match the centroids of the 2.0218 and 4.4168 μm features. However, a common blueshift of $\approx 0.025 - 0.045 c$ shifts all prominent Te lines to match (i.e., to lie within the 0.02 c window) the 2.0218 and 4.4168 μm feature centroids (see Figure 6). This consistent offset indicates the presence of some residual opacity effect that impacts Te across the $\sim 2.0 - 4.5 \mu\text{m}$ wavelength range, or some bulk velocity/inhomogeneity in the ejecta material that results in Te disproportionately moving away from the observer.

To check whether the identification of [Te III] $\lambda 21050$ is reasonable, we estimate the required mass of Te III needed to produce the measured luminosity of the observed emission features (reported in Table 2). Assuming the 2.0218 μm (2.1874 μm) feature at +29 d is dominated by emission from the Te III $\lambda 21050$ line, we use Equations 6 and 7 to compute the approximate mass of Te III ($M_{\text{Te III}}$) needed to power the feature to be $M_{\text{Te III}} \approx 3.3 \times 10^{-5} M_{\odot}$ ($M_{\text{Te III}} \approx 3.9 \times 10^{-5} M_{\odot}$). The mass needed to power the 2.1874 μm emission at +61 d is $M_{\text{Te III}} \approx 1.3 \times 10^{-5} M_{\odot}$. Levan et al. (2024) estimate the Te III mass in the line-forming region of the ejecta of AT 2023vfi needed to power the observed flux at $\sim 2.1 \mu\text{m}$ at +29 d to be $\approx 10^{-3} M_{\odot}$. This value is somewhat higher (factor of ≈ 30)

than our estimate, for two main reasons. First, we have estimated the mass of Te III needed to power one component of the blended $\sim 2.1 \mu\text{m}$ emission, whereas Levan et al. (2024) estimate the Te III mass by considering the entire flux density across the wavelength range of the blended emission feature (2.02 – 2.48 μm , observer frame). Therefore, they are estimating a larger mass of Te III since they are fitting a larger line luminosity ($L_{\text{line}} \approx 3 \times 10^{38} \text{ erg s}^{-1}$, versus our estimate of $6.4 \times 10^{37} \text{ erg s}^{-1}$; see Table 2). Second, we have assumed LTE level populations, whereas Levan et al. (2024) have considered non-LTE effects for their calculation. Our LTE level populations may overestimate the upper level population, leading to a smaller inferred mass than that estimated by Levan et al. (2024).

Although visually the observed features and the rest wavelengths of the Te I–III transitions do not perfectly match, there is clear motivation for a more detailed investigation into the possible identification of Te. Te is an ideal candidate element for further study, since it possesses multiple transitions from multiple ion stages that match the observed emission features, and it is expected to be abundant across a range of r -process scenarios (owing to it being an even- Z element that lies at the top of the second r -process peak; see Figure 8 and e.g., Seeger

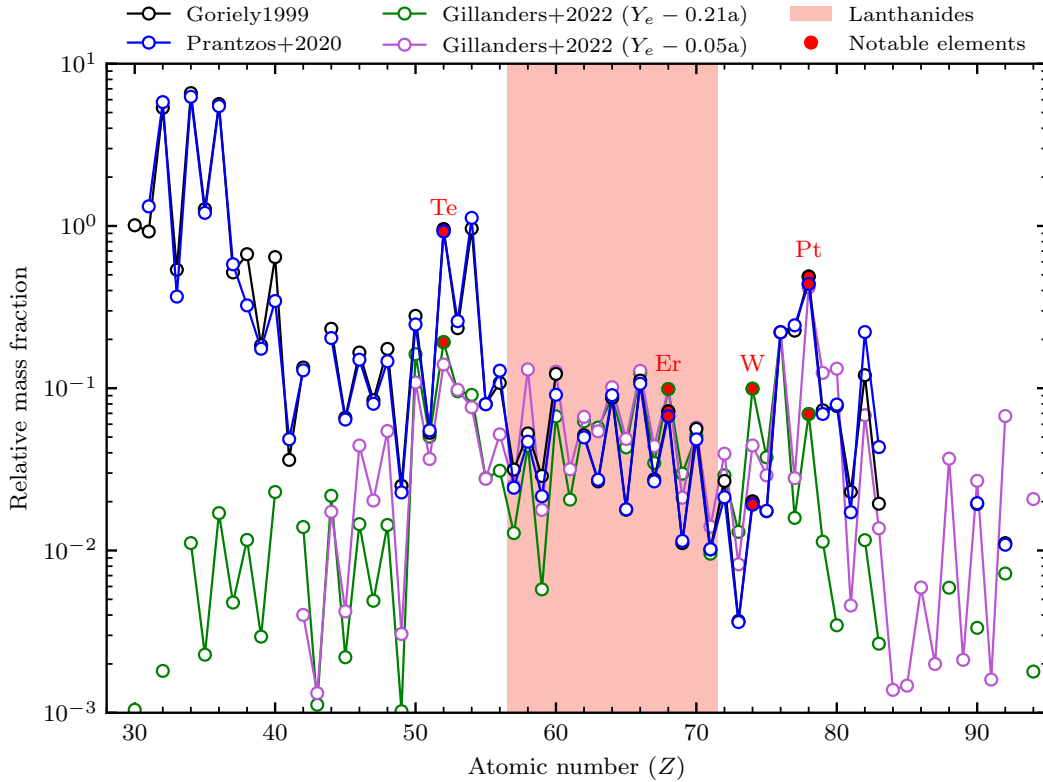

Figure 8. Mass fraction distributions of the r -process elements in the Solar system, as estimated by Goriely (1999) and Prantzos et al. (2020) (black and blue, respectively). We also show two of the composition profiles presented by Gillanders et al. (2022), to illustrate the possible deviation from the Solar r -process distribution for two characteristic Y_e regimes ($Y_e = 0.21, 0.05$; green and purple, respectively). All abundance patterns have been scaled such that they have identical relative mass fractions for Os ($Z = 76$). The lanthanide elements are highlighted by a vertical pink band, and we mark the locations of a number of notable elements (with red dots) discussed in the main text (Section 4.4).

et al. 1965; Goriely 1999; Sneden et al. 2008; Thielemann et al. 2011, 2017; Prantzos et al. 2020; Cowan et al. 2021).

In Figure 8 we present the Solar r -process abundance profiles, as estimated by Goriely (1999) and Prantzos et al. (2020). In both, Te is the seventh most abundant element (and is the second most abundant element for $Z \geq 38$). We also present two composition profiles from Gillanders et al. (2022), which show the predicted composition for binary neutron star (BNS) merger ejecta with characteristic Y_e values of 0.21 and 0.05 (derived from a nucleosynthetic calculation based on the dynamical mass ejection of a realistic hydrodynamical simulation of a BNS merger; Goriely et al. 2011, 2013, 2015; Bauswein et al. 2013). For the $Y_e = 0.21$ and $Y_e = 0.05$ models, Te is the second and third most abundant element (across all Z), respectively. Clearly, Te is an intrinsically abundant r -process element, and so it seems natural to expect an element as abundant as Te to be detectable in the observed spectra.

To summarise, the [Te III] 21050 Å line lies exactly between the 2.0218 and 2.1874 μm emission features (see Figure 6), and we expect this line to be prominent. Thus, we agree with Levan et al. (2024) and Gillanders et al. (2023a) that the [Te III] 21050 Å transition is the current most likely candidate for producing (one of) the emission feature(s) at $\sim 2.1 \mu\text{m}$ in AT 2023vfi. However, given the blended line profile at +29 d and the evolution to +61 d (with an apparent different profile), and the non-negligible offset from both the 2.0218 and 2.1874 μm components, we stop short of confirming the presence of [Te III] emission in the *JWST* spectroscopic obser-

vations of AT 2023vfi. Further work is needed before drawing such a conclusion. Specifically, focus should be placed on obtaining detailed atomic data for the lowest few ion stages, including estimates for transition strengths and collisional information. These data could then be used for quantitative non-LTE spectral modelling of KNe (as in, e.g., Pognan et al. 2023; Shingles et al. 2023), to confirm whether the observed offsets and double profile can be explained with opacity effects (or bulk velocity flows). This would also confirm whether the other transitions of Te III (and of Te I and II) are also expected to be prominent and contribute to the observed spectra.

4.4.2 [Ba II] and [Ra II]

We find that [Ba II] possesses two prominent forbidden transitions, with $\lambda_{\text{vac}} = 17622$ and 20518 Å (see Figure 9). Levan et al. (2024) also shortlist [Ba II] 20518 Å as a possible source of the 2.0218 μm feature in AT 2023vfi. These two transitions originate from the $5p^6 5d^2 D$ levels, and de-excite to the ground state ($5p^6 6s^2 S$). These doublet transitions, and the Ba II system as a whole, is analogous to the well-studied Ca II system (as illustrated in Figure 10), as they are both Group 2 elements. In the Ca II case, the forbidden doublet transitions (with $\lambda_{\text{vac}} = 7293.5$ and 7325.9 Å) are routinely detected as a blend of prominent emission in late-phase supernova spectra (see e.g., Li & McCray 1993; Jerkstrand et al. 2012; Kumar et al. 2022). The close-lying upper levels in the Ca II case results in small wavelength spacing between the doublet transitions ($\Delta\lambda \approx 30$ Å; see

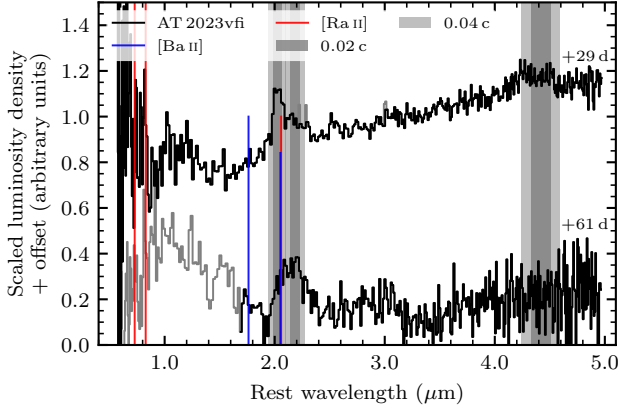

Figure 9. Same as Figure 6, but here we present the emission line spectra for [Ba II] and [Ra II].

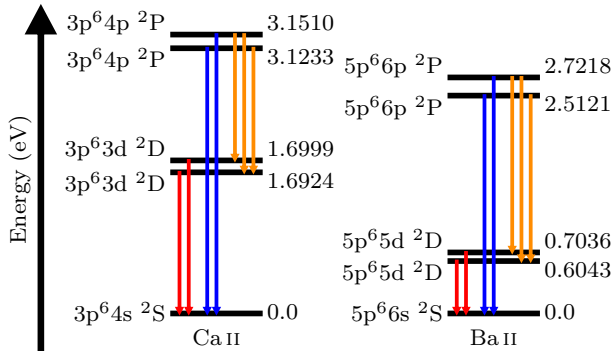

Figure 10. Energy level diagrams for the first five levels of Ca II and Ba II. The levels are annotated with their configuration and term (left), and their corresponding energies (in eV; right). Close-lying levels have been slightly offset for clarity. For the Ca II ion, different sets of transitions have been marked with coloured arrows. The [Ca II] doublet, the H&K resonance doublet and the NIR triplet transitions are marked with red, blue and orange arrows, respectively. The equivalent transitions in the Ba II ion are marked in the same manner. All lines are presented as emission transitions.

Figure 10), and so they appear as a single, blended emission feature. In the Ba II case however, the larger upper level separation results in well-spaced doublet lines, separated by $\Delta\lambda \approx 2900 \text{ \AA}$ (see Figure 10).

We find that both of these [Ba II] lines may be prominent and observable as individual strong emission features, centred at 17622 and 20518 \AA (see Figure 9). By considering the statistical weights and upper level populations, and estimating the resultant line luminosities, we find that the 17622 \AA transition should be more luminous than its counterpart at 20518 \AA by a factor of ≈ 1.2 (for $T = 3000 \text{ K}$). Hence if one of these lines is present in the observations, then the other must also be present and observable (barring extreme line blanketing effects). Thus, although the [Ba II] 20518 \AA transition has a wavelength coincident with the emission feature at 2.0218 μm , we ultimately rule Ba II out as a candidate ion, since there is no evidence in the observational data for any emission at 17622 \AA .

We find good agreement between the [Ra II] 20587 \AA line and the observed 2.0218 μm emission feature (see Figure 9). However,

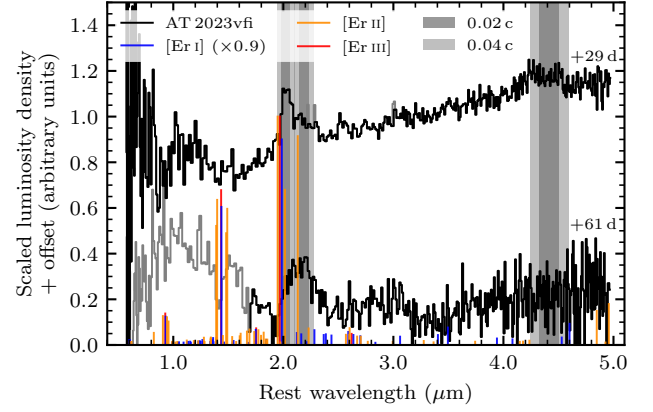

Figure 11. Same as Figure 6, but here we present the emission line spectra for [Er I], [Er II] and [Er III]. We arbitrarily re-scale [Er I] by a constant factor to improve clarity with overlapping lines.

Ra II is also a Group 2 element, and thus a homologue of Ba II and Ca II. We find that the equivalent transitions to the [Ca II] doublet (which have $\lambda_{\text{vac}} = 7276.4, 8275.2 \text{ \AA}$ in the Ra II case) are expected to be $\sim 1000\times$ stronger than this 20587 \AA transition. Although the observational data are very noisy $\lesssim 1 \mu\text{m}$, it seems unlikely that such prominent emission from this [Ra II] doublet would not be observationally detected in the AT 2023vfi spectra. Therefore, we ultimately rule out Ra II as a viable candidate ion for the 2.0218 μm feature.

4.4.3 [Er I], [Er II] and [Er III]

We find that Er I, II and III all have their strongest lines coincident with the 2.0218 and 2.1874 μm emission features (see Figure 11 and Table 3). The [Er I] $\lambda 19860$ and [Er II] $\lambda 20148$ lines lie within the 0.02 c window for the 2.0218 μm feature, while all other matching lines ([Er II] $\lambda\lambda 19483, 21312$, [Er III] $\lambda 19678$) all lie at the blue edges of the 0.04 c tolerable windows for the 2.0218 and 2.1874 μm features. This grouping of lines, belonging to the lowest three ion stages of Er, all plausibly contribute to the emission features at 2.0218 and 2.1874 μm .

However, we find a number of contaminant lines clustered at $\sim 1.4 - 1.5 \mu\text{m}$, which are expected to also be prominent. There is no evidence for any excess emission at this wavelength range in either the +29 or +61 d spectra. Although this may be explained by some line blanketing effect from other species, which would act to suppress the emission from these lines, it is not clear if such extreme blanketing is possible at the wavelengths and phases under consideration. It is also possible that our estimated A -values and/or upper level populations for these contaminant transitions are over-estimates, such that these lines are weaker than we have calculated. As such, we conclude that quantitative modelling (with more complete atomic data) is needed to explore the possible effects of line blanketing, and whether some combination of Er I–III are the species responsible for the 2.0218 and 2.1874 μm emission features in the *JWST* spectra of AT 2023vfi. Despite this apparent discrepancy with the observational data, we find that Er is the lanthanide most likely to have multiple ions contributing to the emission features in AT 2023vfi. Thus, we highlight Er I–III as priority lanthanide species that warrant further detailed atomic data study.

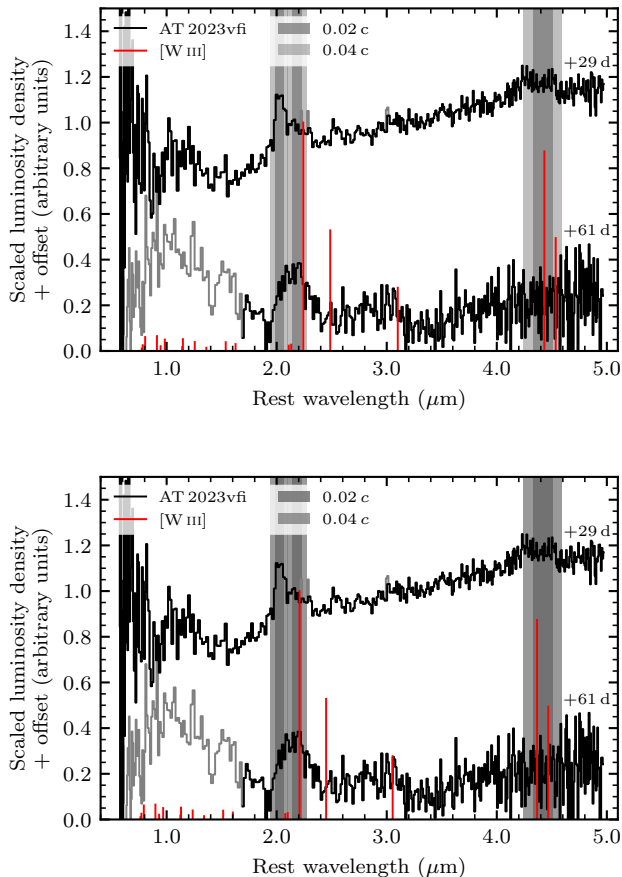

Figure 12. *Upper:* Same as Figure 6, but here we present the emission line spectrum for [W III]. *Bottom:* Same as the upper panel, but with a constant blueshift of 0.015 c applied to all emission lines of [W III].

4.4.4 [W III]

We find that W III has a number of prominent lines in close agreement with the observed emission features of AT 2023vfi; these include the 22416, 44322 and 45352 Å transitions (see Figure 12 and Table 3). The 44322 Å line lies within the 0.02 c window for the 4.4168 μm feature. This line is the most prominent in our analysis at $T = 1000$ K, and second most prominent at $T = 3000$ K (see Figure C17). The most prominent line at $T = 3000$ K is the 22416 Å transition, which lies within the 0.04 c range of the 2.1874 μm transition. The third line (45352 Å) lies within the 0.04 c window for the 4.4168 μm feature. There are two other prominent lines (at $T = 3000$ K) that do not match any observed emission features (with wavelengths of 24866 and 31003 Å).

If AT 2023vfi underwent heavy r -process nucleosynthesis, and material was synthesised up to the third r -process peak, then we may expect a significant quantity of W to be produced. Although W ($Z = 74$) is not that abundant relative to the third r -process peak elements Os, Ir, Pt and Au ($Z = 76, 77, 78$ and 79 , respectively) in the Solar r -process distribution (Goriely 1999; Prantzos et al. 2020, see Figure 8), individual systems undergoing r -process nucleosynthesis can deviate substantially from this average r -process distribution. This is evidenced by the composition profiles presented by e.g., Gillanders et al. (2022), where W constitutes a few per cent of the mass fractions, at least for low Y_e regimes. The $Y_e - 0.21a$

and $Y_e - 0.05a$ composition profiles of Gillanders et al. (2022) are presented in Figure 8, and there we see that W is relatively more abundant than in the Solar r -process distributions. In particular, for the $Y_e - 0.21a$ composition profile, W is predicted to be the fifth most abundant r -process element across all Z .

If the bulk of W is doubly ionised, then the strongest traces of this element at late phases are likely to be the lines reported here. While the 22416 and 45352 Å lines require some explanation for the small offset between the observed 2.1874 and 4.4168 μm features and their rest wavelengths (see the discussion above for the Te case; i.e., Section 4.4.1), the 44322 Å line agrees well with the observed peak of the 4.4168 μm feature. Perhaps this feature is powered by [W III] λ 44322 emission and the other transitions contribute to their respective coincident emission components, but are not the dominant transition, hence the apparent offset. Alternatively, some velocity offset, as in the Te case (see Section 4.4.1) could explain the observed feature offsets. Applying a blueshift of $\approx 0.01 - 0.02 c$ aligns the 22416, 44322 and 45352 Å transitions with the observed centroids of the 2.1874 and 4.4168 μm emission features (i.e., they lie within the 0.02 c windows of the respective features; see Figure 12).

The identification of three prominent transitions, all belonging to W III, coincident with two of the observed emission components in AT 2023vfi is encouraging. This presents a potential identification whereby multiple features may be attributable to several transitions belonging to a single ion. Further investigation is needed for W III; specifically, a complete list of forbidden transitions with computed intrinsic line strengths, as well as collisional rate estimates are needed to enable detailed non-LTE modelling (as noted above for the case of Te; see Section 4.4.1).

4.4.5 [Pt II]

We identify two prominent [Pt II] lines here; one at 21883 Å, which is coincident with the 2.1874 μm feature, and the other at 11877 Å (see Figure 13 and Table 3). Curiously, this 11877 Å line aligns with a noisy flux excess present in the observational data from +29 d. While the SNR of the spectrum at these wavelengths is low and thus we do not independently identify it as a prominent emission feature, we note that this [Pt II] 11877 Å line agrees well with this excess (which also appears to be present in the photometric data; see Figure 4).

Gillanders et al. (2021) present detailed atomic data for Pt I–III (see also Bromley et al. 2023), which they use to generate synthetic spectra for forbidden emission for each ion. They find that the two strongest lines in their analysis for Pt II are also the 11877 and 21883 Å transitions we shortlist here. Their data includes A -values for all transitions, and for the 11877 and 21883 Å lines they quote A -values of 9.05 and 2.54 s^{-1} , respectively. Considering this additional information, we conclude that our shortlisted 21883 Å line is expected to be weaker than our estimate here ($\approx 0.3\times$ as strong).

From a nucleosynthetic standpoint, one expects Pt to be prevalent in KN ejecta. In the Solar r -process abundance of Goriely (1999) (Prantzos et al. 2020), Pt is the fifth (third) most abundant r -process element for $Z \geq 38$ (see Figure 8). In the $Y_e - 0.05a$ composition profile presented by Gillanders et al. (2022) (see also Figure 8), Pt is actually the most abundant element by mass. Thus, assuming AT 2023vfi underwent heavy r -process nucleosynthesis, we can reasonably expect Pt to be present, and if it were to produce detectable forbidden emission, we expect it to be attributable predominantly to the 11877 and 21883 Å lines.

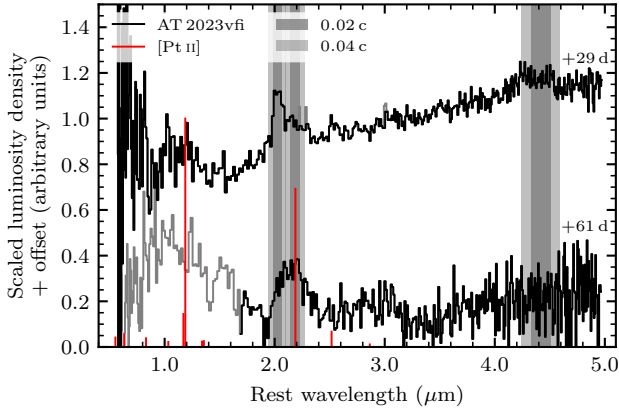

Figure 13. Same as Figure 6, but here we present the emission line spectra for [Pt II].

4.5 Comparison with previous line identification studies

4.5.1 AT 2023vfi

Levan et al. (2024) analyse the *JWST* spectra of GRB 230307A and propose [Te III] as the source of the emission at $\sim 2.1 \mu\text{m}$. Although they empirically model the $\sim 2.1 \mu\text{m}$ flux excess as two blended emission components, they invoke a single component when attributing it to [Te III]; they do not discuss in detail the apparent discrepancy with the rest wavelength of the prominent 21050 Å line and the observed feature emission. They also find in their modelling that [W III] $\lambda 44322$ and [Se III] $\lambda 45549$ can plausibly produce detectable emission at $\sim 4.5 \mu\text{m}$. Here we note that we recover the same proposed identifications for [Te III], [W III] and [Se III], although we expand the list of plausible candidate ions to also include other species.

Gillanders et al. (2023a) present an independent study of the spectra of GRB 230307A, and propose a number of candidate ions. Notably, they do not shortlist [Se III] as a candidate ion for the $\sim 4.4 \mu\text{m}$ emission component, as here we (and Levan et al. 2024) have shortlisted in our analyses. The analysis presented here is more robust than that presented by Gillanders et al. (2023a). Not only have we re-reduced and carefully flux-calibrated the *JWST* NIRSpec spectra to obtain the best available version of these data, we have also improved upon the spectral fitting procedure, providing us with more reliable estimates for the continuum and feature emission properties. As such, we have a better estimate of the feature centroids, for which accurate values are of paramount importance in these types of line identification searches. Thus, we argue that the list of proposed line identifications presented here represents a significant improvement over previous searches, and the ions proposed here are those that warrant further prioritised study.

4.5.2 AT 2017gfo

Hotokezaka et al. (2023) present an analysis of the late-time X-shooter spectra of AT 2017gfo, and show that, assuming the solar *r*-process abundance profile for the first *r*-process peak and above (i.e., $A \geq 88$), one expects the most prominent emission to arise from [Te III] $\lambda 21050$. Their models with Te emission provide a reasonable match to the data, although they do not reproduce the apparent redshifting nature of the $\sim 2.1 \mu\text{m}$ emission across the +7.4 – 10.4 d sequence of X-shooter spectra.

If the contribution from lighter species is also considered (i.e., $A \geq 69$; again invoking the solar *r*-process abundance profile), Hotokezaka et al. (2023) find that strong emission arises from [Kr III] $\lambda 21986$ and [Se IV] $\lambda 22850$. Both of these lines are too red to produce the $\sim 2.1 \mu\text{m}$ emission in AT 2017gfo, but here we shortlist the [Kr III] line as a candidate for the $2.1874 \mu\text{m}$ feature in AT 2023vfi (the [Se IV] line is also too red to match the $2.1874 \mu\text{m}$ feature).

Gillanders et al. (2024) present an analysis of the post-photospheric phase spectra of AT 2017gfo, and shortlist a number of species that plausibly produce the $\sim 2.1 \mu\text{m}$ emission. They find the data are best reproduced by invoking two blended emission components (with centroids of 20590, 21350 Å), with the apparent redshifting nature of the feature across the late-time spectra readily explained by an evolution in the relative strengths of the two emission components.

They favour [Te III] $\lambda 21050$ as a promising candidate for (one of the components of) the emission at $2.1 \mu\text{m}$ in AT 2017gfo, but they present alternative species that may also contribute to this emission. We recover a number of their shortlisted ions here as candidates for the emission in AT 2023vfi ([Pd III], [Ag III], [Te I], [Te III], [Ba II], [Er II] and [Ir II]).

4.6 Comparison with AT 2017gfo

In Figure 14, we compare the +10.4 day X-shooter spectrum of AT 2017gfo with the +29 and +61 day *JWST* NIRSpec spectra of AT 2023vfi. The presence of prominent emission in all spectra at $\sim 2.1 \mu\text{m}$ is clear. While the emission in the +10.4 d AT 2017gfo and +29 d AT 2023vfi spectra in both cases seems to be composed of two blended emission components, it is more visually apparent in the +29 d AT 2023vfi spectrum. Fitting the spectra in a consistent manner (see Section 3) favours similar, but not exactly matching, line centroids for the two components in each system. For AT 2017gfo, we constrain the line centroids to be 20530^{+140}_{-190} and 21300^{+330}_{-260} Å, while for AT 2023vfi we estimate centroids of 20218^{+37}_{-38} and 21874 ± 89 Å (see Table 2).

Considering the tolerable ranges we invoked for our line identification searches (0.02 and 0.04 c), there is significant overlap between the shortlisted lines for each system (see Figure 14). It seems natural to expect such prominent emission at very similar wavelengths in both systems to be attributed to some common species present in the ejecta material of both systems. In this case, the small deviation in feature centroids can be explained by e.g., different ejecta distribution, different opacity effects, or the blending of contributing (but not dominating) emission from other species. Further study is needed to more fully investigate the effects of line blending and opacity to determine whether the blended emission at $\sim 2.1 \mu\text{m}$ in both AT 2017gfo and AT 2023vfi can be explained by a common source. For now, it seems likely that [Te III] contributes to (or dominates) this emission in both systems (as proposed by Hotokezaka et al. 2023; Gillanders et al. 2023a, 2024; Levan et al. 2024).

5 CONCLUSIONS

AT 2023vfi, the kilonova associated with GRB 230307A, is just the second kilonova to be observed spectroscopically. It also marks the

¹¹ We shortlist [Ba II] here as a candidate ion, but ultimately rule it out following some additional considerations (see Section 4.4.2). This argument also applies to the observations of AT 2017gfo; i.e., we rule out [Ba II] as a candidate ion for AT 2017gfo.

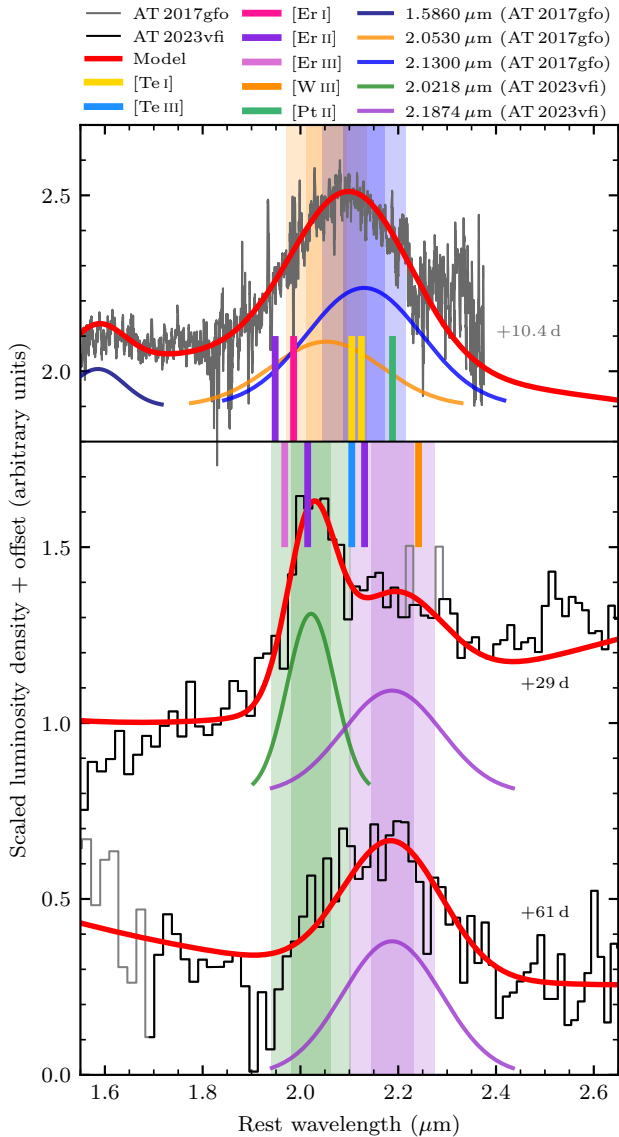

Figure 14. Comparison between the +10.4 d X-shooter spectrum of AT 2017gfo (top) and the +29 (middle) and +61 d (bottom) *JWST* NIRSpec spectra of AT 2023vfi. Our best-fitting models (see Section 3) are overlaid, with the constituent Gaussian emission components for each model also plotted. The 0.02 and 0.04 c tolerable windows for the 2.0530, 2.1300 (AT 2017gfo), 2.0218 and 2.1874 μm (AT 2023vfi) features are also plotted (dark and light shaded bands correspond to the 0.02 and 0.04 c tolerable windows, respectively; coloured to match the corresponding Gaussian emission component). The shortlisted line identifications highlighted in Section 4.4 are plotted as vertical bars, centred on their rest wavelengths.

first *JWST* observations of a kilonova, with two NIRSpec spectra obtained at phases of +29 and +61 days post-GRB. In this paper, we took an empirical approach to fitting the observed spectra. After re-reducing the spectra and calibrating to contemporaneous *JWST* NIRCам photometry, we estimated the continuum properties and fit the observed flux excesses at ~ 2.1 and $4.4 \mu\text{m}$, which we interpret as emission features. The X-ray to MIR continua can be well-matched by the combination of a power law and a blackbody, representative of the contributions of the non-thermal afterglow and the rising red-con-

tinuum at wavelengths $\geq 2 \mu\text{m}$, respectively. We also fit the prominent flux excesses as Gaussian emission features, and find the +29 day spectrum is best fit invoking three emission components at 20218^{+37}_{-38} , 21874 ± 89 and $44168^{+153}_{-152} \text{ \AA}$. The $\sim 2.1 \mu\text{m}$ flux excess at +61 days is well-reproduced by a single component with the same centroid and width as the $21874 \pm 89 \text{ \AA}$ feature invoked at +29 days. The Gaussian features have velocity widths of $0.057 \lesssim v_{\text{FWHM}}(c) \lesssim 0.110$.

We undertook a complete line identification search, with all publicly available atomic data, considering forbidden transitions for the lowest four ionisation stages (neutral to triply ionised) of the elements with atomic number, $Z = 30\text{--}92$. We shortlisted a number of ions that have transitions coincident with the observed emission features. This list includes the ‘light’ ($Z \leq 56$) *r*-process species Se III, Kr III, Nb IV, Pd III, Ag III, In I, Te I–III, and Ba II, the lanthanide ($57 \leq Z \leq 71$) species Ce IV, Sm IV, Ho IV, and Er I–III, and the ‘heavy’ ($Z \geq 72$) *r*-process species Hf I, W III, Os I, Ir II, Pt II, Ra II, and Ac I.

Considering all possible transitions and *r*-process element abundance patterns, we conclude that the astrophysically observed [Te III] 21050 \AA line remains the best candidate to explain the observed emission profiles at 2.0218 and 2.1874 μm in AT 2023vfi. This is in agreement with previous work (Gillanders et al. 2023a; Levan et al. 2024), but we highlight that the rest wavelength of [Te III] $\lambda 21050$ does not match the centroid of either of the components (it is offset by $v \approx 0.04 c$); instead, it resides exactly at the average of the two. Strong optical depth effects or bulk velocity structure would be required to reconcile the observed feature positions with the rest wavelength of the line. Te III has another expected transition at 29290 \AA that we do not detect. However, we estimate it should be around 10 per cent (20 per cent) of the luminosity of the [Te III] $\lambda 21050$ line at $T = 3000 \text{ K}$ ($T = 5000 \text{ K}$) and the noise in the NIRSpec data around this wavelength would preclude a detection. W III can plausibly match multiple emission features; we find good agreement between its 22416, 44322 and 45352 \AA transitions and the 2.1874 and 4.4168 μm emission features. These ions are of particular interest since they are both even- Z elements that lie at the top of the second (Te), or close to the third (W), *r*-process abundance peaks.

We quantitatively compared the 2.1 μm features of AT 2023vfi and AT 2017gfo. The wavelength coincidence of these features has been noted by Levan et al. (2024) and Gillanders et al. (2023a), who invoked [Te III] $\lambda 21050$ as the explanation. Similar to our analysis of the AT 2023vfi feature, we find that two components are preferred to fit the feature in AT 2017gfo. However, the measured line centres are neither coincident between the two kilonovae, nor consistent with a single velocity offset. These inconsistencies prevent us from confirming that the [Te III] 21050 \AA transition is definitely the cause of the emission in both objects, but it remains the most likely.

Our analysis suffers from two limitations, the first of which is incomplete atomic data, specifically: (i) the incomplete line lists for the heavy *r*-process elements, which are typically lacking in forbidden transition wavelengths and intrinsic line strengths, and (ii) the non-existence of collisional information for most of the *r*-process species. Non-LTE effects are crucial to fully understand late-time properties of kilonova ejecta, but without these data, here we are limited to using LTE approximations for our level population calculations. Second, our approach does not account for complex radiative transfer and non-LTE effects. A detailed study, utilising quantitative kilonova modelling codes (such as e.g., ARTIS or SUMO; Kromer & Sim 2009; Jerkstrand et al. 2011; Shingles et al. 2020, 2023; Pognan et al. 2022a,b, 2023) should be undertaken, to fully analyse these *JWST* spectra of AT 2023vfi. While we get good agreement here to the continua of the observed spectra invoking a thermal blackbody

component, it remains unclear whether this is physically reasonable at such late phases, or whether the data are actually produced via some other mechanism; e.g., fluorescence.

These *JWST* data of AT 2023vfi are vital for advancing our understanding of the late-phase evolution of KNe, especially in the NIR. Hence we have taken care to perform a detailed extraction and flux calibration of these data, which we make public for use in future studies. *JWST* will play a large part in advancing our understanding of a growing set of kilonova events.

ACKNOWLEDGEMENTS

We thank Alex J. Cameron, Andrew J. Levan and Lauren Rhodes for discussions regarding the reduction and interpretation of the *JWST* NIRSpec spectra, Stuart A. Sim for discussions surrounding our line identification search, Lauren Rhodes and Shubham Srivastav for assistance with data visualisation, and the *JWST* help desk for assisting with data interpretation. SJS acknowledges funding from STFC Grants ST/Y001605/1, ST/X006506/1 and ST/T000198/1, and a Royal Society Research Professorship.

DATA AVAILABILITY

Our reductions of the *JWST* NIRSpec spectra of AT 2023vfi presented in this paper are publicly available at <https://ora.ox.ac.uk/objects/uuid:5032f338-aff0-4089-9700-03dc5c965113>. The X-shooter spectra of AT 2017gfo are publicly available at www.engrave-eso.org/AT2017gfo-Data-Release and <https://wiserep.weizmann.ac.il>. The photometry utilised in this paper has previously been published (see Levan et al. 2024 for the *JWST* data, and Yang et al. 2024 for the *XMM-Newton* and *Chandra* data).

REFERENCES

- Abbott B. P., et al., 2017, *ApJ*, **848**, L12
- Ackley K., et al., 2020, *A&A*, **643**, A113
- Arnould M., Goriely S., Takahashi K., 2007, *Phys. Rep.*, **450**, 97
- Bauswein A., Goriely S., Janka H. T., 2013, *ApJ*, **773**, 78
- Birch K. P., Downs M. J., 1994, *Metrologia*, **31**, 315
- Bobrick A., Zenati Y., Perets H. B., Davies M. B., Church R., 2022, *MNRAS*, **510**, 3758
- Bromley S. J., McCann M., Loch S. D., Ballance C. P., 2023, *ApJS*, **268**, 22
- Cameron A. G. W., 2003, *ApJ*, **587**, 327
- Chen P., et al., 2020, *ApJ*, **889**, L6
- Collins C. E., et al., 2024, *MNRAS*, **529**, 1333
- Cowan J. J., Sneden C., Lawler J. E., Aprahamian A., Wiescher M., Langanke K., Martínez-Pinedo G., Thielemann F.-K., 2021, *Reviews of Modern Physics*, **93**, 015002
- Dessart L., Hillier D. J., 2011, *MNRAS*, **410**, 1739
- Dhawan S., Bulla M., Goobar A., Sagués Carracedo A., Setzer C. N., 2020, *ApJ*, **888**, 67
- Domoto N., Tanaka M., Wanajo S., Kawaguchi K., 2021, *ApJ*, **913**, 26
- Domoto N., Tanaka M., Kato D., Kawaguchi K., Hotokezaka K., Wanajo S., 2022, *ApJ*, **939**, 8
- Eichler D., Livio M., Piran T., Schramm D. N., 1989, *Nature*, **340**, 126
- Fermi GBM Team 2023, GRB Coordinates Network, **33405**, 1
- Foley R. J., 2015, *MNRAS*, **452**, 2463
- Freiburghaus C., Rosswog S., Thielemann F. K., 1999, *ApJ*, **525**, L121
- Gillanders J. H., Sim S. A., Smartt S. J., 2020, *MNRAS*, **497**, 246
- Gillanders J. H., McCann M., Sim S. A., Smartt S. J., Ballance C. P., 2021, *MNRAS*, **506**, 3560
- Gillanders J. H., Smartt S. J., Sim S. A., Bauswein A., Goriely S., 2022, *MNRAS*, **515**, 631
- Gillanders J. H., et al., 2023a, *arXiv e-prints*, p. arXiv:2308.00633
- Gillanders J., O'Connor B., Dichiara S., Troja E., 2023b, GRB Coordinates Network, **33485**, 1
- Gillanders J. H., Sim S. A., Smartt S. J., Goriely S., Bauswein A., 2024, *MNRAS*, **529**, 2918
- Goriely S., 1999, *A&A*, **342**, 881
- Goriely S., Bauswein A., Janka H.-T., 2011, *ApJ*, **738**, L32
- Goriely S., Sida J. L., Lemaître J. F., Panebianco S., Dubray N., Hilaire S., Bauswein A., Janka H. T., 2013, *Phys. Rev. Lett.*, **111**, 242502
- Goriely S., Bauswein A., Just O., Pllumbi E., Janka H. T., 2015, *MNRAS*, **452**, 3894
- Hjorth J., et al., 2017, *ApJ*, **848**, L31
- Horne K., 1986, *PASP*, **98**, 609
- Hotokezaka K., Nakar E., Gottlieb O., Nissanke S., Masuda K., Hallinan G., Mooley K. P., Deller A. T., 2019, *Nature Astronomy*, **3**, 940
- Hotokezaka K., Tanaka M., Kato D., Gaigalas G., 2021, *MNRAS*, **506**, 5863
- Hotokezaka K., Tanaka M., Kato D., Gaigalas G., 2022, *MNRAS*, **515**, L89
- Hotokezaka K., Tanaka M., Kato D., Gaigalas G., 2023, *MNRAS*, **526**, L155
- Jerkstrand A., 2017, *Spectra of Supernovae in the Nebular Phase*. Springer International Publishing, Cham, pp 795–842, doi:10.1007/978-3-319-21846-5_29
- Jerkstrand A., Fransson C., Kozma C., 2011, *A&A*, **530**, A45
- Jerkstrand A., Fransson C., Maguire K., Smartt S., Ergon M., Spyromilio J., 2012, *A&A*, **546**, A28
- Kasen D., Metzger B., Barnes J., Quataert E., Ramirez-Ruiz E., 2017, *Nature*, **551**, 80
- Kramida A., Ralchenko Y., Reader J., NIST ASD Team 2023, *NIST Atomic Spectra Database* (version 5.11) [Online], Available: <https://physics.nist.gov/asd>. National Institute of Standards and Technology, Gaithersburg, MD., doi:10.18434/T4W30F
- Kromer M., Sim S. A., 2009, *MNRAS*, **398**, 1809
- Kumar B., Singh A., Sahu D. K., Anupama G. C., 2022, *ApJ*, **927**, 61
- Lattimer J. M., Schramm D. N., 1974, *ApJ*, **192**, L145
- Levan A. J., et al., 2024, *Nature*, **626**, 737
- Li H., McCray R., 1993, *ApJ*, **405**, 730
- Li L.-X., Paczyński B., 1998, *ApJ*, **507**, L59
- MacFadyen A. I., Woosley S. E., 1999, *ApJ*, **524**, 262
- Madonna S., et al., 2018, *ApJ*, **861**, L8
- Mazzali P. A., Nomoto K., Patat F., Maeda K., 2001, *ApJ*, **559**, 1047
- McBrien O. R., et al., 2019, *ApJ*, **885**, L23
- Metzger B. D., et al., 2010, *MNRAS*, **406**, 2650
- Morton D. C., 2000, *ApJS*, **130**, 403
- Mösta P., Roberts L. F., Halevi G., Ott C. D., Lippuner J., Haas R., Schnetter E., 2018, *ApJ*, **864**, 171
- Perego A., et al., 2022, *ApJ*, **925**, 22
- Pian E., et al., 2017, *Nature*, **551**, 67
- Planck Collaboration et al., 2020, *A&A*, **641**, A6
- Pognan Q., Jerkstrand A., Grumer J., 2022a, *MNRAS*, **510**, 3806
- Pognan Q., Jerkstrand A., Grumer J., 2022b, *MNRAS*, **513**, 5174
- Pognan Q., Grumer J., Jerkstrand A., Wanajo S., 2023, *MNRAS*, **526**, 5220
- Prantzos N., Abia C., Cristallo S., Limongi M., Chieffi A., 2020, *MNRAS*, **491**, 1832
- Prentice S. J., et al., 2020, *A&A*, **635**, A186
- Pruet J., Woosley S. E., Hoffman R. D., 2003, *ApJ*, **586**, 1254
- Qian Y. Z., Woosley S. E., 1996, *ApJ*, **471**, 331
- Rosswog S., Liebendörfer M., Thielemann F. K., Davies M. B., Benz W., Piran T., 1999, *A&A*, **341**, 499
- Ryabchikova T., Piskunov N., Kurucz R. L., Stempels H. C., Heiter U., Pakhomov Y., Barklem P. S., 2015, *Phys. Scr.*, **90**, 054005
- Schlaflly E. F., Finkbeiner D. P., 2011, *ApJ*, **737**, 103
- Seeger P. A., Fowler W. A., Clayton D. D., 1965, *ApJS*, **11**, 121
- Shingles L. J., et al., 2020, *MNRAS*, **492**, 2029
- Shingles L. J., et al., 2023, *ApJ*, **954**, L41
- Siegel D. M., Barnes J., Metzger B. D., 2019, *Nature*, **569**, 241

Table 3. List of candidate transitions for the inferred emission features at 2.0218, 2.1874 and 4.4168 μm . For each transition, we provide the species, wavelength (in vacuum and in air), line strength, and the level information (configuration, term, quantum J number and energy) for both the upper and lower levels.

Species	λ_{vac} (Å)	λ_{air} (Å)	Line strength ^a ($T = 3000$ K)	Lower level				Upper level			
				Configuration	Term	J	Energy (eV)	Configuration	Term	J	Energy (eV)
2.0218 μm feature (0.02 c)											
[⁵⁶ Ba II]	20518	20512	0.84	6s	² S	1/2	0.000	5d	² D	3/2	0.604
[⁶⁸ Er I]	19860	19855	1.0	4f ¹² 6s ²	³ H	6	0.000	4f ¹² 6s ²	³ F	4	0.624
[⁶⁸ Er II]	20148	20143	0.68	–	–	11/2	0.055	–	–	7/2	0.670
[⁸⁸ Ra II]	20587	20581	1.0	7p	² P ^o	1/2	2.647	7p	² P ^o	3/2	3.249
2.0218 μm feature (0.04 c)											
[⁶⁷ Ho IV]	19806	19800	1.0	4f ¹⁰	⁵ I	8	0.000	4f ¹⁰	⁵ I	7	0.626
[⁶⁸ Er II]	19483	19478	1.0	–	–	13/2	0.000	–	–	9/2	0.636
[⁶⁸ Er III]	19678	19673	1.0	4f ¹²	³ H	6	0.000	4f ¹²	³ F	4	0.630
[⁷⁶ Os I]	19440	19435	1.0	5d ⁶ 6s ²	⁵ D	4	0.000	5d ⁷ (⁴ F)6s	⁵ F	5	0.638
[⁷⁷ Ir II]	20886	20880	1.0	5d ⁷ (⁴ F)6s	⁵ F	5	0.000	5d ⁷ (⁴ F)6s	⁵ F	4	0.594
2.1874 μm feature (0.02 c)											
[³⁶ Kr III]	21986	21980	1.0	4s ² 4p ⁴	³ P	2	0.000	4s ² 4p ⁴	³ P	1	0.564
[⁴⁷ Ag III]	21696	21690	1.0	4d ⁹	² D	5/2	0.000	4d ⁹	² D	3/2	0.571
[⁷² Hf I]	21893	21887	0.86	5d ² 6s ²	³ F	2	0.000	5d ² 6s ²	³ F	4	0.566
[⁷⁸ Pt II]	21883	21877	0.69	5d ⁸ 6s	⁴ F	9/2	0.593	5d ⁸ 6s	⁴ F	7/2	1.160
2.1874 μm feature (0.04 c)											
[⁴⁶ Pd III]	21338	21332	0.52	4d ⁸	³ F	4	0.000	4d ⁸	³ F	2	0.581
[⁵² Te I]	21049	21044	1.0	5p ⁴	³ P	2	0.000	5p ⁴	³ P	1	0.589
[⁵² Te I]	21247	21241	0.34	5p ⁴	³ P	2	0.000	5p ⁴	³ P	0	0.584
[⁵² Te III]	21050	21044	1.0	5s ² 5p ²	³ P	0	0.000	5s ² 5p ²	³ P	1	0.589
[⁶⁸ Er II]	21312	21306	0.91	–	–	11/2	0.055	–	–	9/2	0.636
[⁷⁴ W III]	22416	22409	1.0	5d ⁴	⁵ D	0	0.000	5d ⁴	⁵ D	2	0.553
4.4168 μm feature (0.02 c)											
[⁵⁸ Ce IV]	44391	44379	1.0	5p ⁶ 4f	² F ^o	5/2	0.000	5p ⁶ 4f	² F ^o	7/2	0.279
[⁶² Sm IV]	43656	43645	1.0	4f ⁵	⁶ H ^o	5/2	0.000	4f ⁵	⁶ H ^o	9/2	0.284
[⁷⁴ W III]	44322	44310	0.87	5d ⁴	⁵ D	0	0.000	5d ⁴	⁵ D	1	0.280
[⁸⁹ Ac I]	44814	44802	1.0	6d ⁷ s ²	² D	3/2	0.000	6d ⁷ s ²	² D	5/2	0.277
4.4168 μm feature (0.04 c)											
[³⁴ Se III]	45549	45537	0.56	4s ² 4p ²	³ P	1	0.216	4s ² 4p ²	³ P	2	0.488
[⁴¹ Nb IV]	42637	42625	1.0	4d ²	³ F	2	0.000	4d ²	³ F	4	0.291
[⁴⁹ In I]	45196	45183	1.0	5s ² 5p	² P ^o	1/2	0.000	5s ² 5p	² P ^o	3/2	0.274
[⁵² Te II]	45466	45453	1.0	5s ² 5p ³	² D ^o	3/2	1.267	5s ² 5p ³	² D ^o	5/2	1.540
[⁷² Hf I]	42433	42421	1.0	5d ² 6s ²	³ F	2	0.000	5d ² 6s ²	³ F	3	0.292
[⁷² Hf I]	45229	45217	0.42	5d ² 6s ²	³ F	3	0.292	5d ² 6s ²	³ F	4	0.566
[⁷⁴ W III]	45352	45339	0.49	5d ⁴	⁵ D	1	0.280	5d ⁴	⁵ D	2	0.553

Note. λ_{air} values have been computed assuming the standard vacuum-to-air conversion from VALD3 (see Birch & Downs 1994; Morton 2000; Ryabchikova et al. 2015).

^a Line strength represents the normalised line luminosity values (L_{em}) we computed for each transition (see Section 4.1 for details).

^o Denotes an odd parity.

Smartt S. J., et al., 2017, *Nature*, 551, 75

Snedden C., Cowan J. J., Gallino R., 2008, *ARA&A*, 46, 241

Sneppen A., Watson D., 2023, *A&A*, 675, A194

Symbalisty E., Schramm D. N., 1982, *Astrophys. Lett.*, 22, 143

Symbalisty E. M. D., Schramm D. N., Wilson J. R., 1985, *ApJ*, 291, L11

Takahashi K., Witt J., Janka H. T., 1994, *A&A*, 286, 857

Tarumi Y., Hotokezaka K., Domoto N., Tanaka M., 2023, *arXiv e-prints*, p.

[arXiv:2302.13061](https://arxiv.org/abs/2302.13061)

Thielemann F. K., et al., 2011, *Progress in Particle and Nuclear Physics*, 66, 346

Thielemann F. K., Eichler M., Panov I. V., Wehmeyer B., 2017, *Annual Review of Nuclear and Particle Science*, 67, 253

Wang Y.-Y., Tang S.-P., Jin Z.-P., Fan Y.-Z., 2023, *ApJ*, 943, 13

Watson D., et al., 2019, *Nature*, 574, 497

Waxman E., Ofek E. O., Kushnir D., Gal-Yam A., 2018, *MNRAS*, **481**, 3423
 Winteler C., Käppeli R., Perego A., Arcones A., Vasset N., Nishimura N.,
 Liebendörfer M., Thielemann F. K., 2012, *ApJ*, **750**, L22
 Woosley S. E., Wilson J. R., Mathews G. J., Hoffman R. D., Meyer B. S.,
 1994, *ApJ*, **433**, 229
 Yang Y.-H., et al., 2024, *Nature*, **626**, 742
 Yaron O., Gal-Yam A., 2012, *PASP*, **124**, 668

APPENDIX A: AT 2023vfi EXTENDED FIGURES

Here we present the best-fitting models for the +29 and +61 day *JWST* NIRSpec spectra of AT 2023vfi extended to shorter wavelengths, to illustrate model agreement with the inter/extra-polated X-ray data (see Section 3.1).

APPENDIX B: AT 2017gfo SPECTRAL FITTING

Here we present our best-fitting models for the +7.4 – 10.4 day X-shooter spectra of AT 2017gfo, as discussed in the main text (see Section 3.2).

APPENDIX C: ADDITIONAL LINE ID PLOTS

In this section we present the figures for the candidate ions shortlisted in Section 4.3 that were not presented in the main text.

We also present sequences of synthetic spectra for a number of ions, as noted in the main text ([Pd III], [Sm IV], [W III] and [Os I]; see Section 4.3), illustrating how they vary across our range of explored T values ($T \in [1000, 3000, 5000]$ K).

This paper has been typeset from a $\text{\TeX}/\text{\LaTeX}$ file prepared by the author.

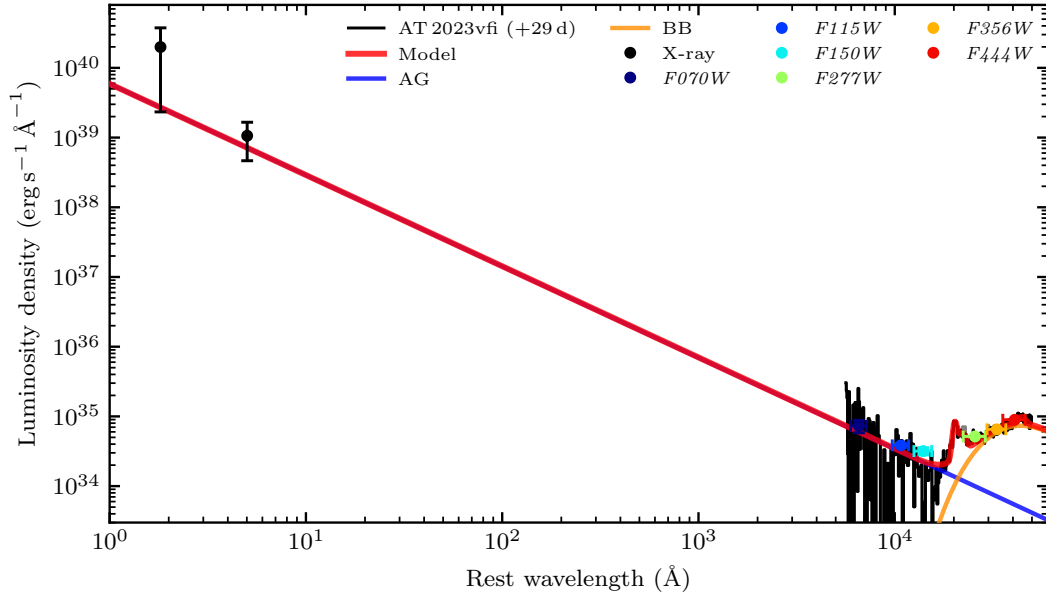

Figure A1. Same as Figure 4, but plotted in log space to accommodate the inclusion of our interpolated X-ray data (black circles; these plotted errors do not include any estimate for the uncertainty associated with data interpolation).

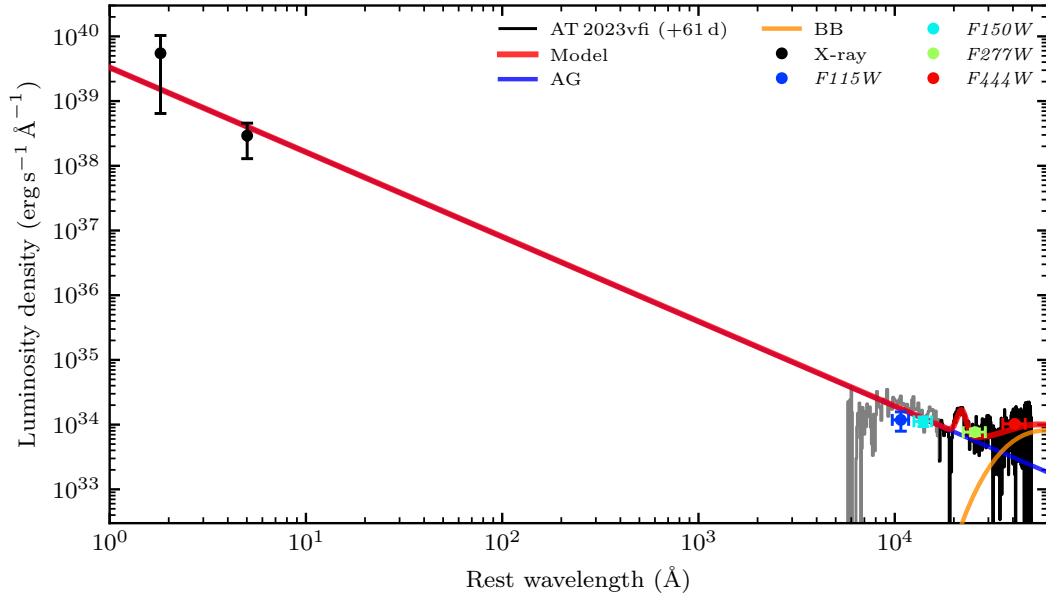

Figure A2. Same as Figure 5, but plotted in log space to accommodate the inclusion of our extrapolated X-ray data (black circles; these plotted errors do not include any estimate for the uncertainty associated with data extrapolation).

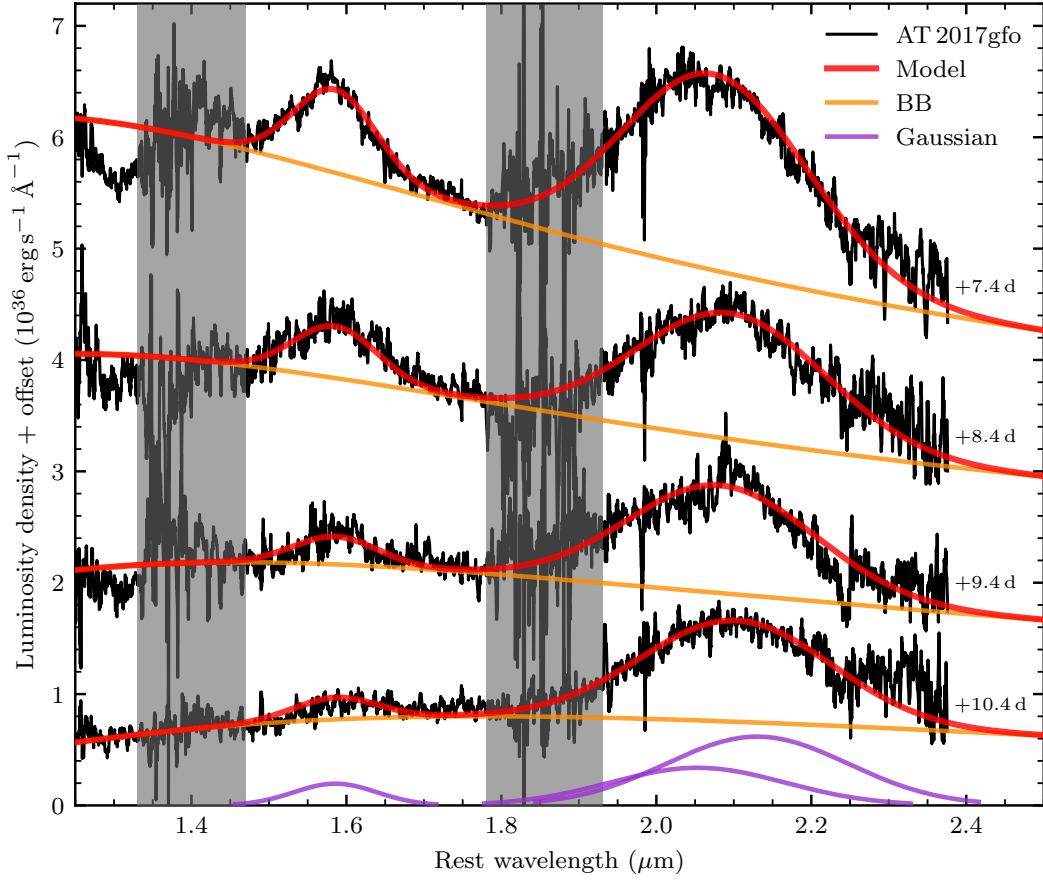

Figure B1. Sequence of late-time (+7.4 – 10.4 d) X-shooter spectra of AT 2017gfo (black) compared with our best-fitting models (red), offset (by 3.2×10^{36} , 2.2×10^{36} and $10^{36} \text{ erg s}^{-1} \text{ \AA}^{-1}$ for the +7.4, +8.4 and +9.4 d spectra, respectively) for clarity. The observed spectra are annotated with their phase relative to GW trigger. The continuum BB components for each model are plotted (orange), as are the individual Gaussian components for the +10.4 d model. These Gaussian components have identical centroids and widths across all phases. The vertical grey bands correspond to strong telluric regions.

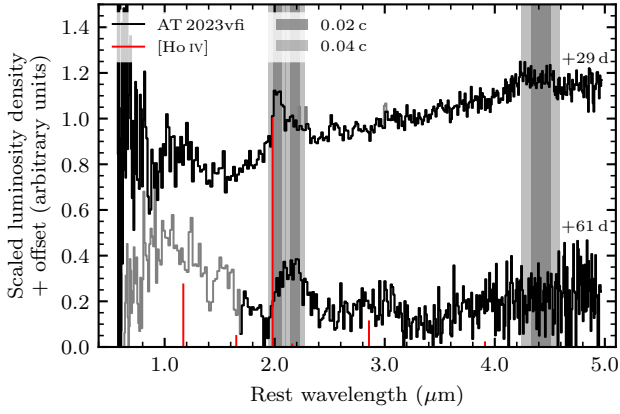

Figure C1. Same as Figure 6, but here we present the emission line spectra for [Ho iv].

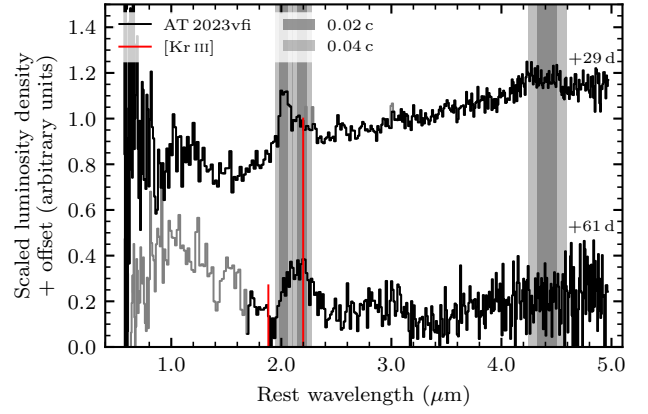

Figure C4. Same as Figure 6, but here we present the emission line spectra for [Kr iii].

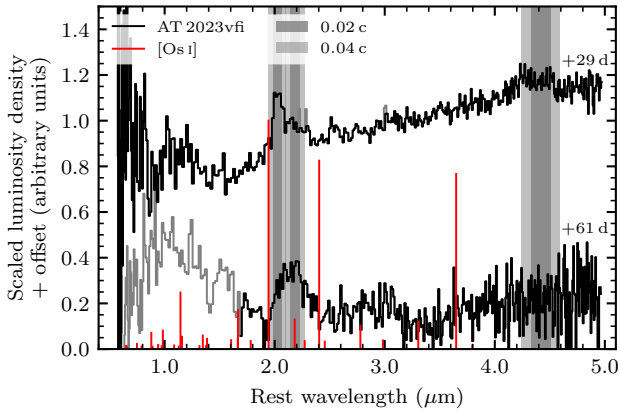

Figure C2. Same as Figure 6, but here we present the emission line spectra for [Os i].

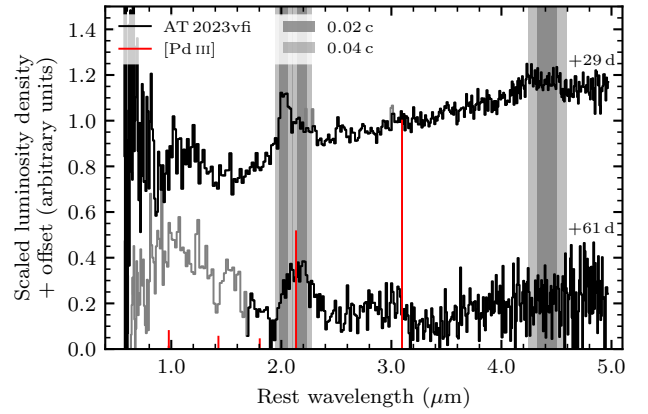

Figure C5. Same as Figure 6, but here we present the emission line spectra for [Pd iii].

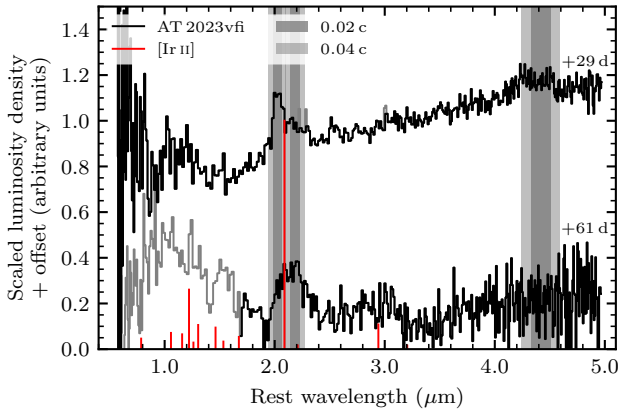

Figure C3. Same as Figure 6, but here we present the emission line spectra for [Ir ii].

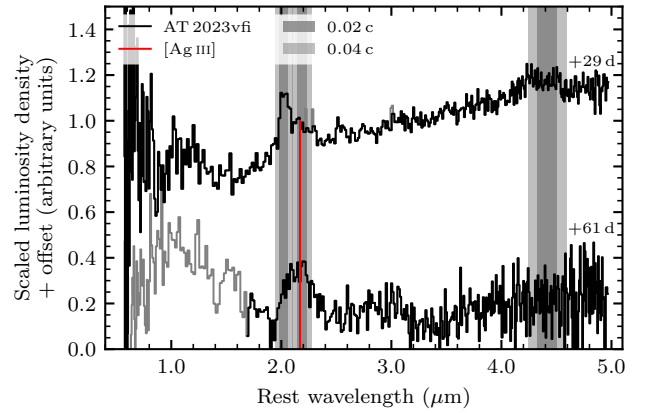

Figure C6. Same as Figure 6, but here we present the emission line spectra for [Ag iii].

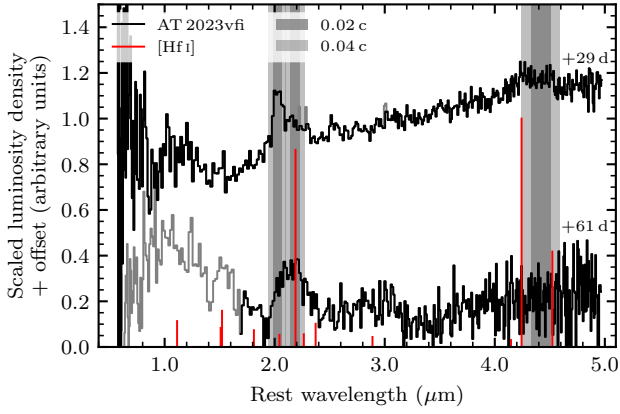

Figure C7. Same as Figure 6, but here we present the emission line spectra for [Hf I].

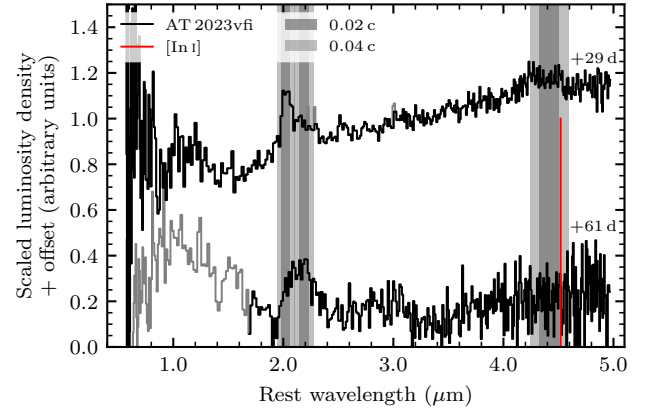

Figure C10. Same as Figure 6, but here we present the emission line spectra for [In I].

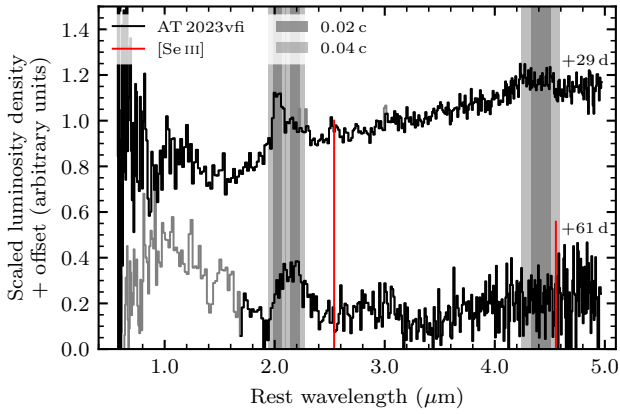

Figure C8. Same as Figure 6, but here we present the emission line spectra for [Se III].

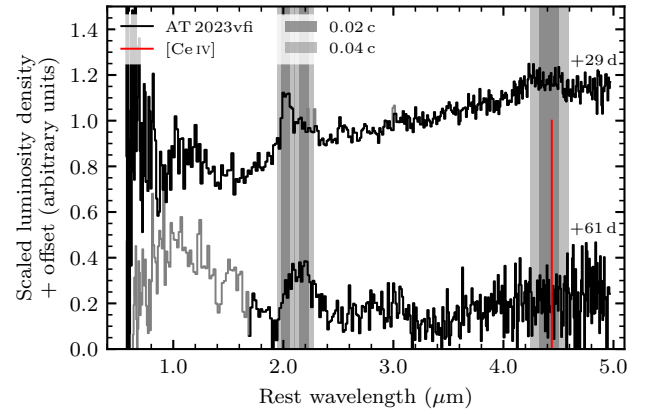

Figure C11. Same as Figure 6, but here we present the emission line spectra for [Ce IV].

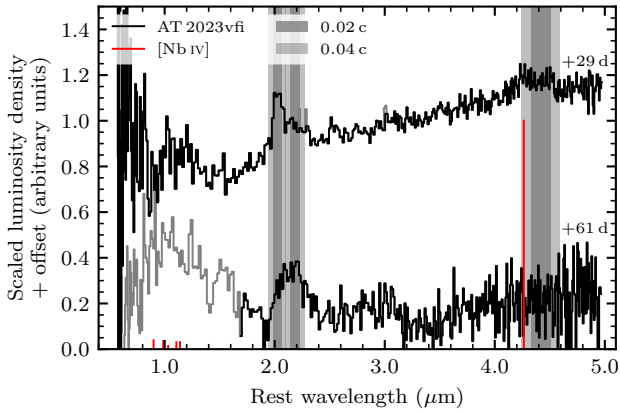

Figure C9. Same as Figure 6, but here we present the emission line spectra for [Nb IV].

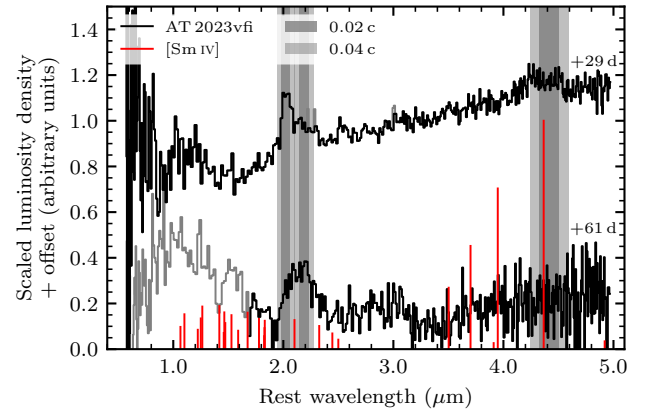

Figure C12. Same as Figure 6, but here we present the emission line spectra for [Sm IV].

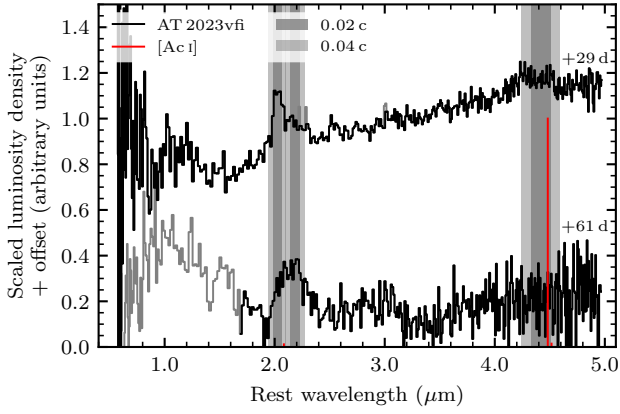

Figure C13. Same as Figure 6, but here we present the emission line spectra for [Ac I].

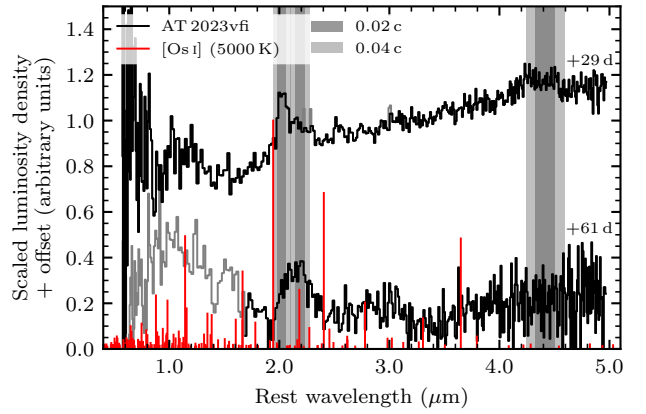
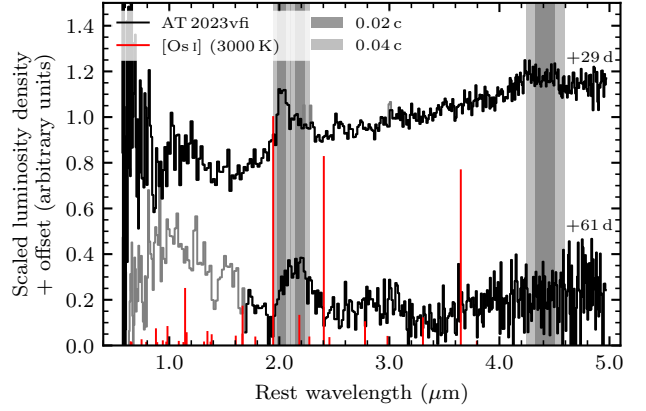
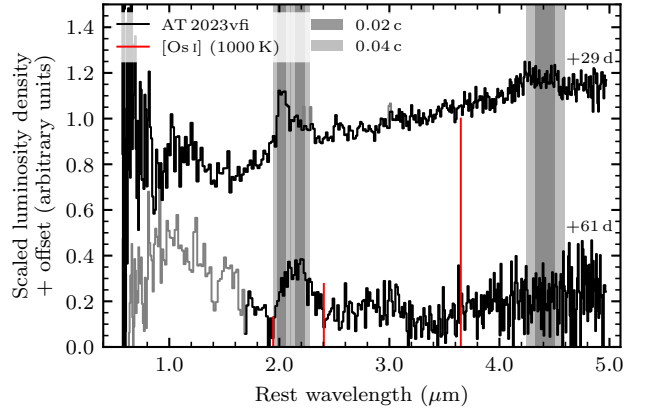

Figure C14. Same as Figure 6, but here we instead present the emission lines for a single species across the range of temperature values probed in our analysis. In this case, we present the relative strengths of the emission transitions of [Os I] at $T = 1000$ K (top), $T = 3000$ K (middle), and $T = 5000$ K (bottom).

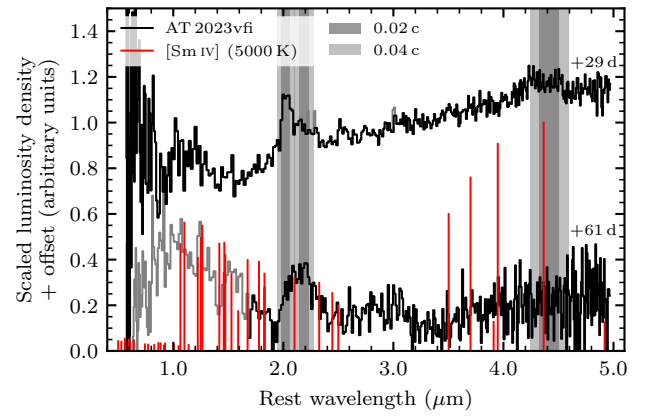
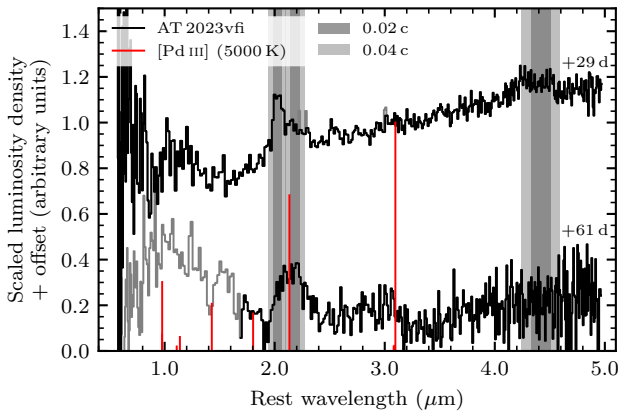
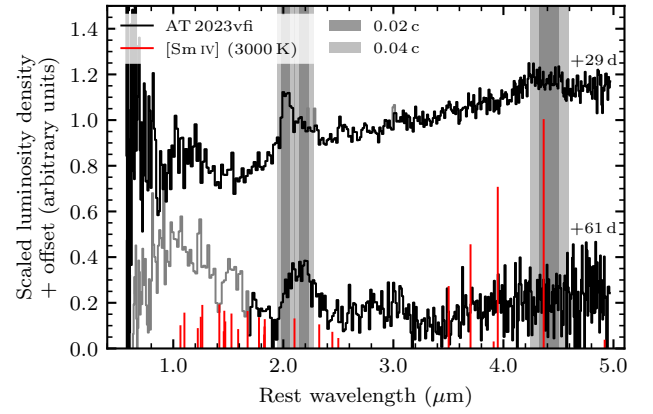
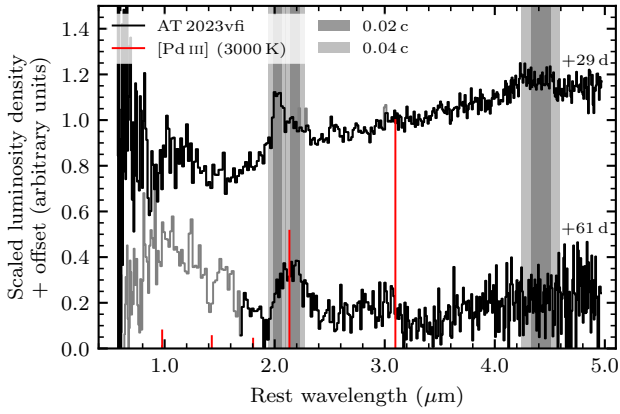
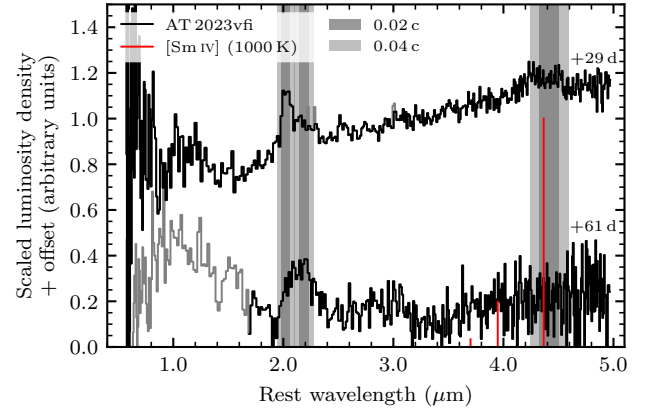
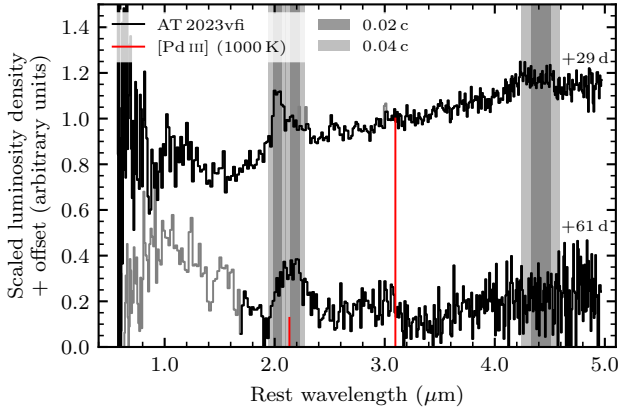

Figure C15. Same as Figure C14, but in this case, we present the line information for [Pd III].

Figure C16. Same as Figure C14, but in this case, we present the line information for [Sm IV].

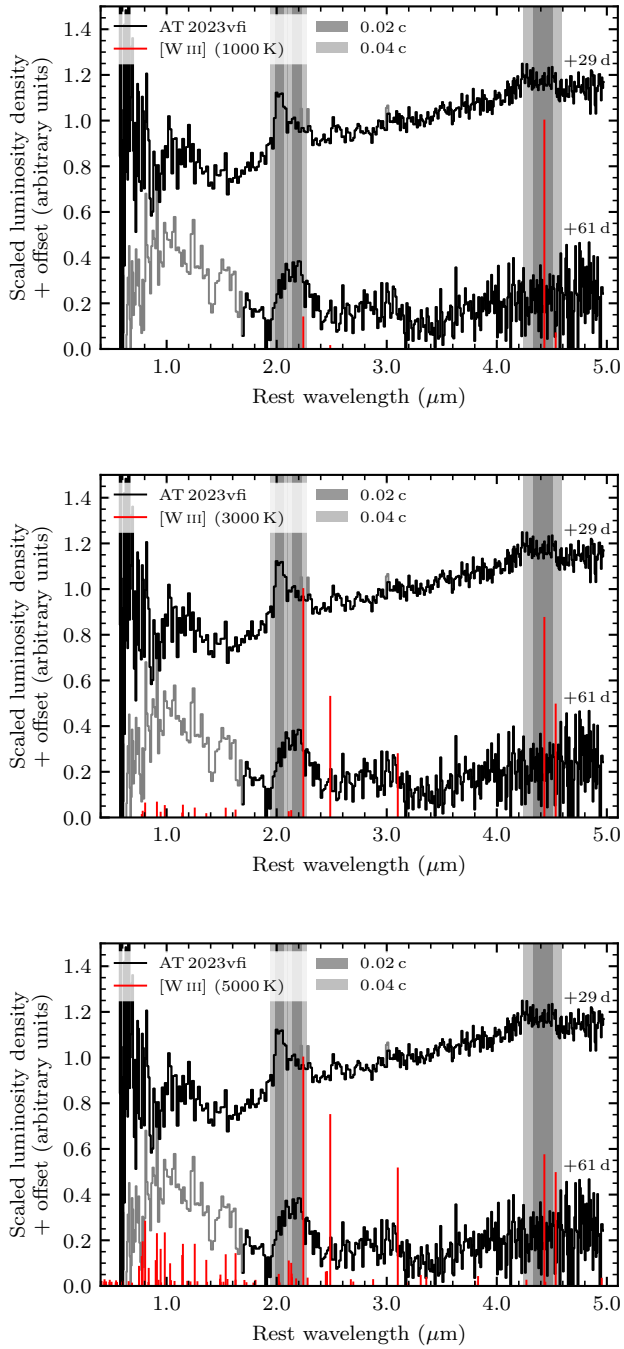

Figure C17. Same as Figure C14, but in this case, we present the line information for [W III].