

Multi-qubit state visualizations to support problem solving – a pilot study

Jonas Bley^{1*}, Eva Rexigel¹, Alda Arias¹, Lars Krupp^{2,3},
Steffen Steinert^{4,5}, Nikolas Longen², Paul Lukowicz^{2,3},
Stefan Küchemann⁴, Jochen Kuhn⁴,
Maximilian Kiefer-Emmanouilidis^{1,2,3}, Artur Widera^{1*}

¹Department of Physics and Research Center OPTIMAS, RPTU
Kaiserslautern-Landau, Kaiserslautern, 67663, Germany.

²Department of Computer Science and Research Initiative QC-AI, RPTU
Kaiserslautern-Landau, Kaiserslautern, 67663, Germany.

³Embedded Intelligence, German Research Center for Artificial
Intelligence, Kaiserslautern, 67663, Germany.

⁴Faculty of Physics, Chair of Physics Education,
Ludwig-Maximilians-Universität München (LMU Munich), Munich,
80539, Germany.

⁵Department of Electrical and Computer Engineering, RPTU
Kaiserslautern-Landau, Kaiserslautern, 67663, Germany.

*Corresponding author(s). E-mail(s): jonas.bley@rptu.de;
widera@physik.uni-kl.de;

Contributing authors: rexigel@physik.uni-kl.de;
a.ariassuarez@rhrk.uni-kl.de; lars.krupp@dfki.de;
steinert.steffen@physik.uni-muenchen.de; nlongen@rhrk.uni-kl.de;
paul.lukowicz@dfki.de; s.kuechemann@physik.uni-muenchen.de;
jochen.kuhn@lmu.de; maxkieber@physik.uni-kl.de;

Abstract

In the rapidly evolving interdisciplinary field of quantum information science and technology, a big obstacle is the necessity of understanding high-level mathematics to solve complex problems. Visualizations like the (dimensional) circle notation enable us to visualize not only single-qubit but also complex multi-qubit states, entanglement, and quantum algorithms. Current findings in educational

research suggest that incorporating visualizations in settings of problem solving can have beneficial effects on students' performance and cognitive load compared to solely relying on symbolic problem solving content. In this pilot study, we aim to take a first step to identify in which contexts students benefit from the presentation of visualizations of multi-qubit systems in addition to mathematical formalism. We compare students' performance, time taken, and cognitive load when solving problems using the mathematical-symbolic Dirac notation alone with using it accompanied by the circle notation or the dimensional circle notation in single- and multi-qubit systems. Although little overall differences in students' performance can be detected depending on the presented representations, we observe that problem-solving performance is student- and context-dependent. In addition, the results indicate reduced cognitive load when participants are presented with visualization. The results are discussed with respect to relevant design aspects for future studies.

Keywords: Multi-qubit systems, Visualizations, Quantum operations, Entanglement, Multiple external representations, Cognitive load

1 Introduction

The interdisciplinary nature of the field of Quantum Information Science and Technology (QIST) necessitates endeavors to educate workforce with many different backgrounds [1]. This implies that the quantum education community needs to find ways to facilitate the introduction to QIST to a broad audience. One way of facilitating such an introduction is the use of suitable representations, including visualization, to convey nontrivial quantum concepts [2].

Visualization is generally considered a useful tool in Science, Technology, Engineering & Mathematics (STEM) education [3–8] and in QIST education in particular [2, 9, 10]. In educational psychology, the Design, Functions, Tasks (DeFT) framework by Ainsworth [11] considers how and why to use multiple external representations (MERs). Combined with Cognitive Load Theory (CLT) [12], it offers theoretical predictions for possible benefits in learning and testing using MERs. It is unknown whether and under which conditions learning and problem solving are supported by providing visualization in addition to the mathematical symbolic representation (e.g., the Dirac notation) in quantum computing education. With this study, our objective is to take the first step in investigating whether visualizations provide a benefit to solve problems in QIST, when provided in addition to the Dirac notation, and under which circumstances possible benefits occur.

QIST is based on mathematics, in particular, linear algebra in complex Hilbert spaces [13, 14]. This is because quantum states can be represented as vectors in these Hilbert spaces, and quantum operations correspond to unitary operations or projections. To combat the high level of abstraction in this mathematical field and gain some intuition, a multitude of visualizations are available. For example, there exist broad geometric depictions of quantum states and entanglement as shown in [13, 15–17]. The Bloch sphere is a popular representation for single-qubit systems, that can help make respective quantum operations more intuitive by relating them to rotations and projections in three-dimensional space [18]. It can also be used to show multi-qubit states [19–22]. The diagrammatic ZX-calculus [23–26] can be used to describe specific quantum operations and whole algorithms in a “LEGO-like” manner [27], simplifying the standard quantum circuit notation. With so called color code, quantum error correction algorithms can be visually depicted as acting on hypercubes or hypercube-like lattices [28–31]. The DROPS representation utilises generalized Wigner functions to visualize quantum states, entanglement and quantum operations in an operator-basis [32–34].

All of these visualizations use other bases than the computational $(0,1)$ -basis. However, in this work, we focus on the computational basis as it is often used for introductory purposes [35]. The Circle Notation (CN) (section 2.1) is a visual representation of the complex amplitudes of states in the computational basis using circles with gauges [36]. While CN aligns the amplitudes in a row as you would when writing out states in the Dirac notation, qubits can also be assigned axes in space [37]. This dimensional approach has the possible benefit of making quantum operations more intuitive and can be combined with CN (then called Dimensional Circle Notation (DCN)). It can be used to visualize the entanglement properties of qubit systems [38].

In this pilot study, we take a first step in exploring the possible benefits of presenting students with CN or DCN, in addition to the Dirac notation. Participants are tasked with predicting the effect of different quantum operations and finding entanglement properties of quantum states of one-, two-, and three-qubit systems. For this purpose, an array of test items covering these domains was created.

The paper is structured as follows. First, we introduce the research background. This includes visualization of quantum states and entanglement with DCN in section 2 and the background of learning and testing with MERs and Cognitive Load Theory (CLT) in section 3. We follow with the research questions in 4 and describe the study design in section 5. The results are presented and discussed in section 6. We conclude and provide an outlook for future research in section 7.

2 Visualizing quantum states and entanglement

The Circle Notation (CN) is introduced in Section 2.1 and the Dimensional Circle Notation (DCN) in section 2.2. How such dimensional notations can be used to visualize entanglement is discussed in Section 2.3.

2.1 Circle notation

The Circle Notation uses filled circles with pointers to visualize the amplitudes $c_i = re^{i\varphi}$ of a quantum state $|\psi\rangle = \sum_i c_i |i\rangle$. We refer to qubit states using the computational basis, which means that i is written in binary form, with the rightmost digit being the least significant and also the number corresponding to the first qubit. The magnitude r is represented by the radius of the filling circle and the gauge at an angle φ , measured counterclockwise from the vertical axis, as shown in figure 1. Because a quantum state is normalized, that is, $\sum_i |c_i|^2 = 1$, the sum of the areas of the inner circles is π . Each area can be interpreted as the measurement probability of the corresponding basis state.

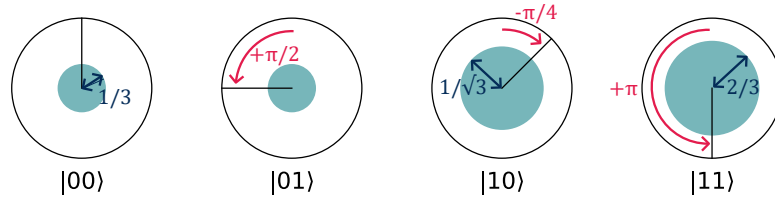

Fig. 1: The state $|\psi\rangle = \frac{1}{3}|00\rangle + \frac{1}{3}e^{i\pi/2}|01\rangle + \frac{1}{\sqrt{3}}e^{-i\pi/4}|10\rangle - \frac{2}{3}|11\rangle$ in CN [36].

2.2 Dimensional circle notation

In dimensional notations, every qubit is assigned an axis in space [37, 38]. DCN is such an extension of CN. For comparison, figure 2 shows the same state as figure 1

in DCN. For further clarification, we also compare the use of a Hadamard gate that creates or destroys superposition for CN and DCN in figure 3.

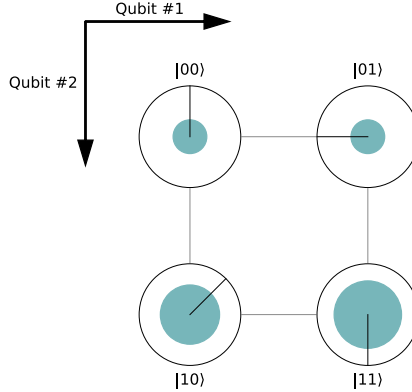

Fig. 2: The same state as in figure 1, $|\psi\rangle_{\#2\#1} = \frac{1}{3} |00\rangle + \frac{1}{3} e^{i\pi/2} |01\rangle + \frac{1}{\sqrt{3}} e^{-i\pi/4} |10\rangle - \frac{2}{3} |11\rangle$, in DCN [37, 38].

2.3 Entanglement

In the computational basis, separability of pure states can be seen as symmetry apart from a complex factor with respect to every qubit of the system [38]. This is described by the following theorem [39]:

Theorem 1. *Let $\alpha, \beta, c_i \in \mathbb{C}$. An n -qubit state $|\psi\rangle = \sum_{i=0}^{2^n-1} c_i |i\rangle$ is $2 \cdot 2^{n-1}$ separable into $|\psi\rangle = (\alpha |0\rangle + \beta |1\rangle) \otimes \sum_{i=0}^{2^{n-1}-1} c'_i |i\rangle$ if and only if for all $i \in \{0, \dots, 2^{n-1} - 1\}$ either $c_{2^{n-1}+i} = 0$ or there exists a ratio $r \in \mathbb{C}$ such that $c_i = r c_{2^{n-1}+i}$.*

This ratio r is the complex factor that can be seen in separable states in dimensional notations. To see this factor in two-qubit systems, one needs to observe whether there is symmetry along the axis of one qubit, apart from a complex factor, the ratio r . In the absence of symmetry, the system is entangled. Similarly, in three-qubit systems, one can spot whether a qubit is separable from the rest of the system, i.e., not entangled with it, if there is symmetry in regard to the plane perpendicular to that qubit's axis. A system is called partially separable if only a subset of the qubits of that system are separable from that system. This is shown in figure 4.

3 Problem solving with multiple external representations

In this section, we consider the effects of including multiple external representations (MERs) in problem-solving tasks. In doing so, we refer to the functions of MERs according to Ainsworth's Design, Functions, Tasks (DeFT) framework [11] in section

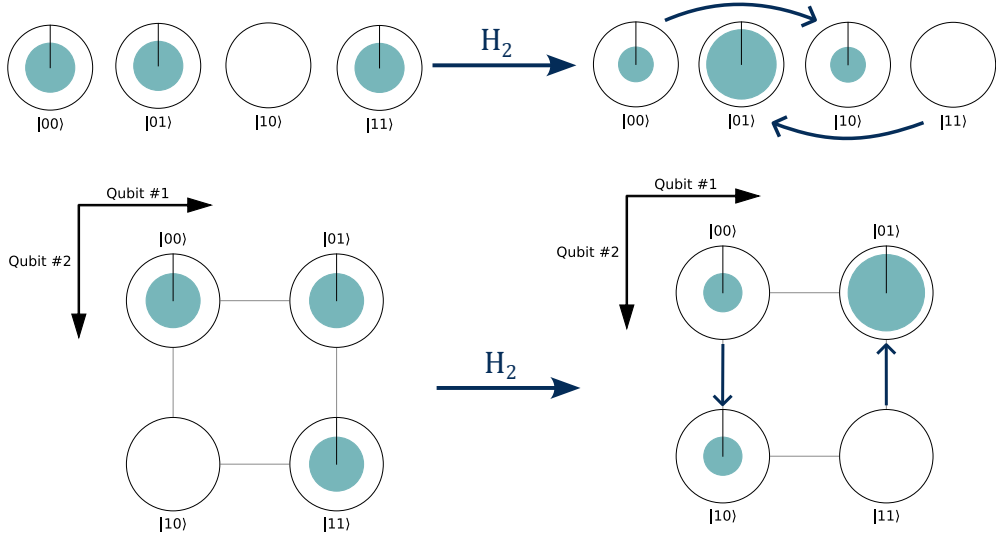

Fig. 3: Hadamard gate on the second qubit in the state $|\psi\rangle_{\#2\#1} = \frac{1}{\sqrt{3}}|00\rangle + \frac{1}{\sqrt{3}}|01\rangle + \frac{1}{\sqrt{3}}|11\rangle$ in CN and DCN. The Hadamard gate creates and destroys superpositions, i.e., it is defined as $H|0\rangle = 1/\sqrt{2}(|0\rangle + |1\rangle)$ and $H|1\rangle = 1/\sqrt{2}(|0\rangle - |1\rangle)$. It can be seen as acting on pairs of states where qubit #1 is constant, i.e., acting on the axis of qubit #2 in the dimensional notation [37].

3.1, and the effects on cognitive load that go along with the use of MERs in section 3.2.

3.1 Functions of multiple external representations

Based on educational research, it is well known that learning and problem solving in STEM can be supported by focusing not only on text-based and mathematical-symbolic representations (e.g., written text and formulas) but also on visualizations (e.g., pictures and diagrams) [40, 41]. From a theoretical perspective, the benefit of learning with text accompanied by visualization can be explained by an efficient use of information processing and the working memory dual-channel structure. When learning with text-based or mathematical-symbolic representations alone, the processing load of information is solely on the verbal channel of working memory. However, when learning with text and visualization, both the verbal and visual channels of working memory are activated and integrated in the construction of coherent mental schemata [42, 43]. This distributed information processing across two channels reduces the load on each single channel and, thus, the risk of cognitive overload.

Within her Design, Functions, Tasks (DeFT) framework, Ainsworth [11] has formulated three main functions of MERs to support learning. First, MERs can *complement each other* by containing different information or supporting different processes. Second, they can *constrain each other*, e.g., by familiarity or inherent properties. Third, incorporating MERs can *construct deeper understanding* as learners are confronted

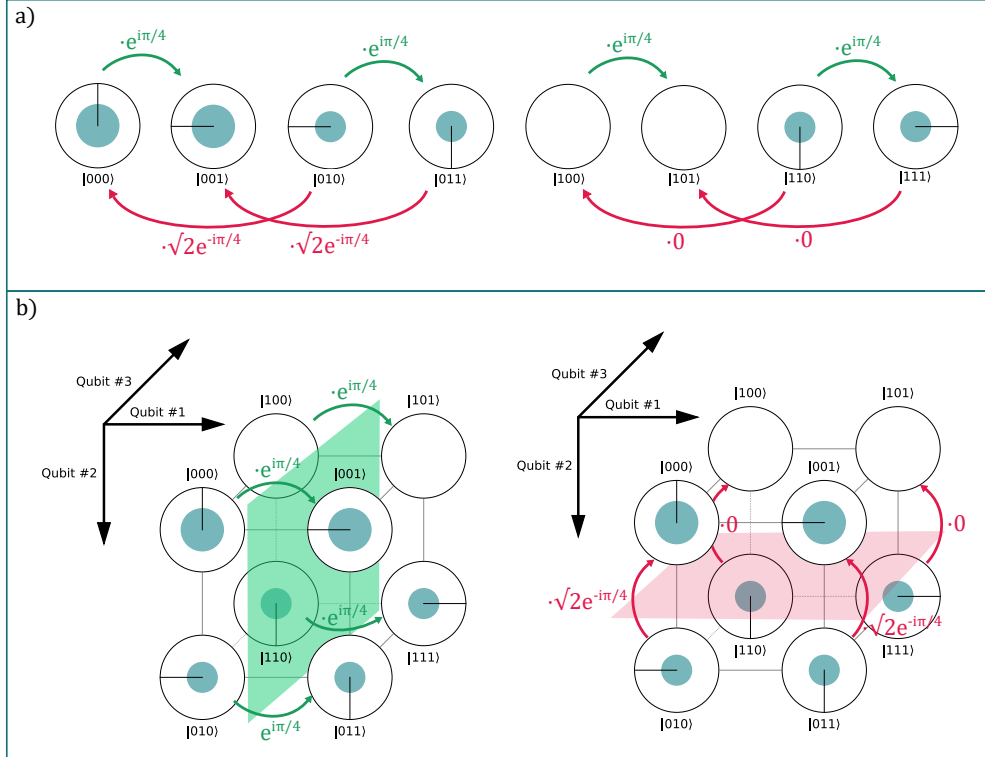

Fig. 4: Partial separability of the state $|\psi\rangle_{\#1\#2\#3} = \frac{1}{2}|000\rangle + \frac{1}{2}e^{i\pi/2}|001\rangle + \frac{1}{2\sqrt{2}}e^{i\pi/2}|010\rangle - \frac{1}{2\sqrt{2}}|011\rangle - \frac{1}{2\sqrt{2}}|110\rangle + \frac{1}{2\sqrt{2}}e^{-i\pi/2}|111\rangle$ [38]. a) Separability in standard circle notation in terms of qubit #1 can be seen by the fact that there exists a ratio $r_1 = e^{i\pi/4}$ (in green) such that for any coefficients c_{xy0} and c_{xy1} , $c_{xy1} = r_1 e^{i\pi/4} c_{xy0}$ is the same everywhere. However, as is shown in red, this is not the case for qubit #2. b) As depicted on the left hand side, the state is separable in terms of qubit #1, because the state is symmetric apart from a complex factor in terms of qubit #1. This is apparent by the green symmetry plane. For the other two qubits, there exists no such ratio, i.e., no such symmetry planes, as shown here for qubit #2 with the red plane.

with the abstraction of the underlying knowledge structures, the extension of knowledge to an unknown representation or improving the understanding of the relations between different representations.

Referring to the DeFT framework, we especially make use of the representations complementary functions, by visualizing qubit characteristics and gate operations additionally to the common mathematical-symbolic description. As students are provided with both representations, they have further access to QIST content knowledge compared to the mathematical description alone. In addition to this, our aim is to facilitate the understanding of the corresponding mathematical descriptions. When using both visual and mathematical representations, students can be supported in

extending existing knowledge structures to mathematical descriptions. For example, in the context of entanglement, dimensional visualizations like DCN provide new representations of the separability of qubit systems or even subsystems [38].

However, incorporating additional representations imposes an extra cognitive load on students, as they must not only understand how each representation conveys information but also how to translate between different representations. Therefore, the learning effectiveness of MERs does not only rely on the learning material but also on the characteristics of the learner [11, 44]. To learn and solve problems with MERs efficiently, students must possess representational competence [45]. Representational competence is divided into conceptual competencies (visual understanding, i.e., the ability of connecting the representation to concepts and understanding of the main features, and connectional understanding, i.e., the ability to connect and compare the representation to other representations), perceptual competencies (visual fluency, i.e., efficiency of connecting the representation to concepts and the ability to work effectively in the representation, and connectional fluency, i.e., efficiency and flexibility of connecting multiple representations to each other and switching between them), and lastly meta-representational skills (i.e., the ability to choose suitable representations) [6].

To summarize, alternative representations of multi-qubit systems in QIST to the Dirac notation can be used to visualize entanglement and the actions of gate operations. They can also enable instructors to encode information in an easily accessible representation to take advantage of MERs for these complex concepts. Using MERs, however, only deems benefits if the learner possesses representational competence.

3.2 Cognitive load

It is essential to consider the cognitive load imposed on students when designing tasks and learning materials, as working memory capacity is a major limiting factor in learning and problem solving [46]. In the original version of Cognitive Load Theory (CLT) Sweller divided cognitive load into three categories: extraneous cognitive load (ECL), intrinsic cognitive load (ICL) and germane cognitive load (GCL) [47]. ECL is unnecessary cognitive load imposed on the learner by design, i.e. the way the material is presented. ECL should be reduced to improve the performance of students. ICL, on the other hand, is cognitive load that is inherent to the task or the learning content and cannot be reduced by extraneous factors. GCL is described as the effort to construct “schemata”, that is, mental patterns and categorizations that allow students to infer meaning from the learning material. To support students in the construction of cognitive schemata, materials should be designed such that ECL is low, but GCL is high.

In order to reduce ECL, there are various effects to consider when designing tasks or learning materials [48]. Here, we summarize the effects that are relevant to this study. The *split-attention effect* suggests that ECL is increased, when MERs are spatially or temporally separated. In our case, when presenting CN or DCN and Dirac notation, the representations of the same quantum state should be close to each other. The *redundancy effect* suggests that displaying unnecessary additional information can lead to an increase in ECL. This effect could lead to additional ECL when CN

or DCN is presented in addition to the Dirac notation, if the representation does not offer additional value to the learner. Whether this is the case should mainly depend on the representational competence of the learner.

When incorporating a visualization in addition to the Dirac notation, learner characteristics can determine whether the visualization helps or not. For example, a novice might, in some cases, benefit from using the visual representation of a complex number in Circle Notation, while an expert might never need to use a second representation, and the additional representation just adds to ECL. This effect is called the *expertise reversal effect* [49]. On the other hand, it could be the case that someone who understands the action of gates and the definition of separability in dimensional notation, i.e., has representational understanding, benefits from DCN in these contexts. More generally, these two effects are forms of *aptitude-treatment interactions* [50].

3.3 Time taken

The time it takes a student to answer a question correctly depends on different factors. The distance-difficulty hypothesis proposed in [51], and revised in [52], predicts that the logarithm of the time taken to answer the questions is proportional to the distance of the students' ability to the difficulty of the question. In [53], it was confirmed that in complex tasks, students who took longer also performed better. In [54], it was found that children with higher levels of ability take longer to incorrectly solve the questions, so the distance-difficulty hypothesis holds in this context. Considering the impact of providing a visualization on the question difficulty, if one finds that participants take longer amount of times on questions with a visualization, it could mean that the question was made less difficult by providing a visualization, bringing the question difficulty closer to the ability level of the student.

When only considering time taken for correctly solved questions, most of the results where the question was above the skill level of the participant are eliminated (except for those questions that were correctly solved by random chance). Therefore, when considering time taken only for correctly solved questions, one considers more of the students that are above or at matching ability level to the question's difficulty. If a question becomes trivial for a student when presented with a visualization, they will take less time for correctly solved questions. Therefore, when requiring that both the question without visualization and with visualization is solved correctly, on average the time taken should be lower if the question did, in fact, get easier by providing a visualization.

In summary, the time taken for task solving is a multidimensional construct. Clear results are expected to be very difficult to obtain, as there are so many factors that play a role. However, according to the distance-difficulty hypothesis [51, 52], the time taken could be used as a metric (albeit weak) to determine how suitable the given tasks were to the level of ability of the students. Here, all answers, correct or incorrect, should be considered. In addition, a close analysis of the dependence of the difficulty of the question on the time taken for correct answers could provide further details on the benefits of providing a visualization.

4 Research Questions

Based on current educational research, we expect that the use of CN and DCN can utilize the known advantages of learning with MERs in QIST by constructing deeper understanding of entanglement and complementing the mathematical symbolic Dirac notation by offering new strategies to predict the outcome of quantum gate operations. In this study, our objective is to take a first step towards verifying this expectation, by comparing the task solving abilities of participants in the Dirac notation with those where the Dirac notation is accompanied by CN or DCN. In addition, we take into account the representational competence of the participants, more specifically, the conceptual competencies of representational and connectional understanding and the perceived cognitive load during tasks without and with visualization. Here, we refer to representational understanding instead of visual understanding (see [6]), including the competency with complex numbers in mathematical symbolic notation. Because the supposed benefits, in addition to being likely learner-dependent, are also likely to be context-dependent, we investigate the effects of presenting a visualization in different contexts, that is, measurements, various unitary operations, and entanglement & separability.

We formulate the following research questions.

1. In what contexts does incorporating CN and DCN support students' answer correctness and time taken in task solving on quantum operations and entanglement?
2. How does the inclusion of the visualizations affect cognitive load?
3. How are performance and cognitive load affected by representational and connectional understanding?

5 Methods

In order to gain precise insights into the effects and relevant conditions of including CN and DCN in students' problem solving, we decided to compare students' performance and cognitive load with and without visualization intrapersonally for each participant and relate it to connectional understanding. As is the nature of a pilot study, our aim is also to learn about the suitability of the questions that are presented to the participants.

5.1 Structure of the study

The study consisted of three online multiple choice tests about one-, two-, and three-qubit systems, respectively. The surveys took about 45 minutes each. The participants received 10€ compensation per survey.

In each survey, except for the first, the participants were randomly assigned to two groups, where one group was presented with CN and one group was presented with DCN throughout the survey. Each survey was separated into two equivalent parts, A and B, where (mostly) questions using the same contexts (gate operations, measurements, entanglement, and separability) were asked in part A and B. One group was presented with visualization in part A and without visualization in part B

(group vis-math) and one group was presented without visualization in part A and with visualization in part B (group math-vis).

5.2 Participants

In the survey of the one-, two- and three-qubit systems, there were 17, 21 and 15 participants. We asked for demographic information at the end of the first survey.

8 of the 17 participants in the first survey stated that they had been introduced to the Dirac notation before and 9 of the 17 participants stated that they were introduced to CN before the day of the survey. From the participant group for the study on one-(two-)(three-)qubit systems, 1(1)(1) was in the age range 18-21, 12(11)(9) were in the age range 22-25 and 3(2)(3) were in the age range 26-30. 16(14)(13) were male participants and 1(1)(1) female. The highest level of educational achievement was high school graduation for 4(3)(4) participants, completed Bachelor's degree for 9(7)(5) participants, completed master's degree for 3(3)(3) participants, and completed Ph.D. for 1(1)(1) participant. There was 1(1)(1) participant in the field of Economics, 8(8)(7) participants in Information/Computer Science, 3(3)(2) participants in Computer Science and Engineering, 4(4)(4) participants in Mathematics, and 1(1)(1) participant in Physics.

5.3 Introductory slides

At the beginning of each survey, participants were given the following introductory slides (in the corresponding visualization, CN or DCN, that they were assigned):

- Visualization of qubit states
- Action of single-qubit gates in single-qubit systems
- Action of multi-qubit gates in multi-qubit systems (only shown in the second and third survey)
- Measurement probabilities and the resulting state
- Separability and Entanglement (only shown in the second and third survey)

An example slide is shown in figure 5. The introductory material is given in the supplementary material.

5.4 Representational understanding

In the beginning of the first survey (one qubit), we asked participants if they had previously been introduced to the Dirac notation and if they had been introduced to CN before. Then, we asked them one question on the multiplication of complex numbers and one on the Euler formula (e.g., translating between $e^{i\pi/2}$ and $1/\sqrt{2} + i/\sqrt{2}$), and similar questions using only CN. An example is shown in figure 6. In addition, participants were asked their confidence on each of these questions on a Likert scale from 0 (random guess) to 4 (very sure). We did not repeat this test in the other surveys due to time restrictions.

Please read the following info on single-qubit gates in two-qubit systems.

In two-qubit systems, single-qubit gates change all instances of that qubit as part of the system.

For example, the X_y -gate swaps coefficients of basis states of a given two-qubit state such that the basis states are swapped in terms of qubit y :

$$1/2 |00\rangle + 1/\sqrt{2} e^{-i\pi/4} |01\rangle - 1/\sqrt{12} |10\rangle + 1/\sqrt{6} e^{3i\pi/4} |11\rangle \rightarrow_{X_1} 1/\sqrt{2} e^{-i\pi/4} |00\rangle + 1/2 |01\rangle + 1/\sqrt{6} e^{3i\pi/4} |10\rangle - 1/\sqrt{12} |11\rangle$$

$$1/2 |00\rangle + 1/\sqrt{2} e^{-i\pi/4} |01\rangle - 1/\sqrt{12} |10\rangle + 1/\sqrt{6} e^{3i\pi/4} |11\rangle \rightarrow_{X_2} -1/\sqrt{12} |00\rangle + 1/\sqrt{6} e^{3i\pi/4} |01\rangle + 1/2 |10\rangle + 1/\sqrt{2} e^{-i\pi/4} |11\rangle$$

In dimensional circle notation, the gates are applied along the axis of the targeted qubit on every pair of states like a single-qubit gate.

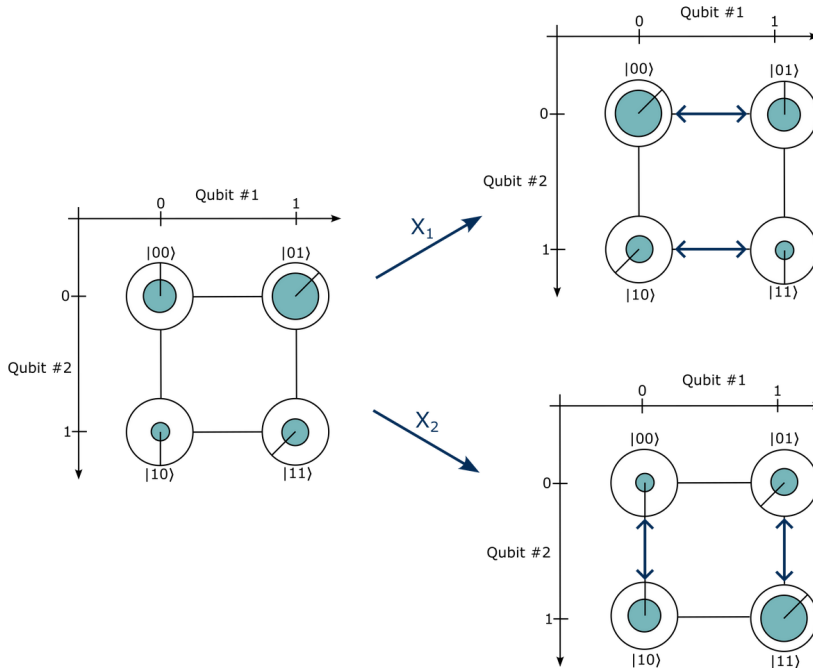

Fig. 5: Introductory example slide for the action of single-qubit gates in two-qubit systems visualized in DCN.

5.5 Connectional understanding

To measure connectional understanding, we measure the translation competence of participants between Dirac notation and visualization. After the introductory slides, the participants were asked four questions (six questions in the two-qubit survey) to translate between their assigned visualization and the Dirac notation. two (three in the two-qubit survey) of these questions were about translating from Dirac notation to visualization, and two (three) were about translating back. One question was about translating phase, one was about translating magnitude, and in the two-qubit survey, we added one question that asked about both. An example task in the three-qubit survey is shown in figure 7.

What is the result of the following multiplication in circle notation?

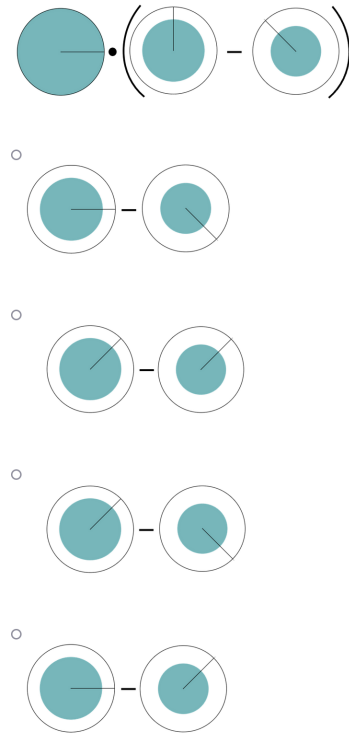

Fig. 6: Example question for representational understanding in Circle Notation for the calculation $e^{-i\pi/2} \cdot (\frac{\sqrt{2}}{\sqrt{3}} - \frac{1}{\sqrt{3}}e^{i\pi/4}) = \frac{\sqrt{2}}{\sqrt{3}}e^{-i\pi/2} - \frac{1}{\sqrt{3}}e^{-i\pi/4}$. The correct answer is the bottom most.

5.6 Quantum Operations & entanglement

We tested the visualizations in one-, two-, and three-qubit systems. The most standard quantum gates, the X, Z, and Hadamard gates, were tested for all sizes of qubit systems. In addition, the measurement probabilities and the resulting state after measurements were asked in all surveys. The phase gate was only tested in the one-qubit survey, while in the two- and three-qubit surveys the CNOT gate, (partial) separability, and (partial) entanglement were also tested. All the questions used in the study are provided in the supplementary material. Figure 8 shows an example task of the effect of a Hadamard gate in a two-qubit system.

5.7 Cognitive load

The perceived cognitive load was measured after each part of the survey, A and B. The following Cognitive Load test items were chosen, as suggested in [55]:

What is the following state in circle notation?

$$\frac{1}{\sqrt{6}} |000\rangle + \frac{1}{\sqrt{6}} e^{-i\pi/2} |010\rangle + \frac{1}{\sqrt{6}} e^{3i\pi/4} |011\rangle + \frac{1}{\sqrt{6}} |100\rangle + \frac{1}{\sqrt{6}} e^{i\pi/4} |101\rangle + \frac{1}{\sqrt{6}} e^{i\pi/3} |110\rangle$$

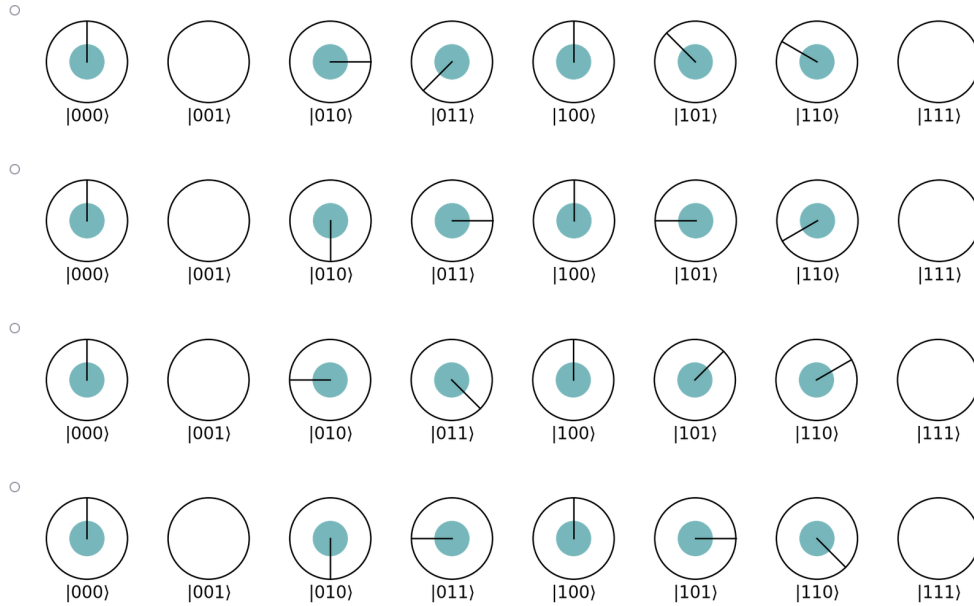

Fig. 7: Example question for translating from Dirac notation to Circle Notation. The correct answer is the top most.

ICL question 1: For the tasks of survey part A/B, many things needed to be kept in mind simultaneously.

ICL question 2: The tasks of survey part A/B were very complex.

GCL question 1: For the tasks of survey part A/B, I had to highly engage myself.

GCL question 2: For the tasks of survey part A/B, I had to think intensively what things meant.

ECL question 1: During the tasks of survey part A/B, it was exhausting to find the important information.

ECL question 2: The design of the tasks of survey part A/B was very inconvenient for learning.

ECL question 3: During the tasks of survey part A/B, it was difficult to recognize and link the crucial information.

Possible answers were on a Likert scale from 0 (completely wrong) to 6 - absolutely right.

The naive questionnaire of [55] was chosen to measure GCL, because we concluded that the GCL test items of the first iteration fit our use case of problem solving tasks better. Due to the limited effects of the naive GCL items in [55], the GCL measurement should be critically viewed. However, the items used measure the perceived mental

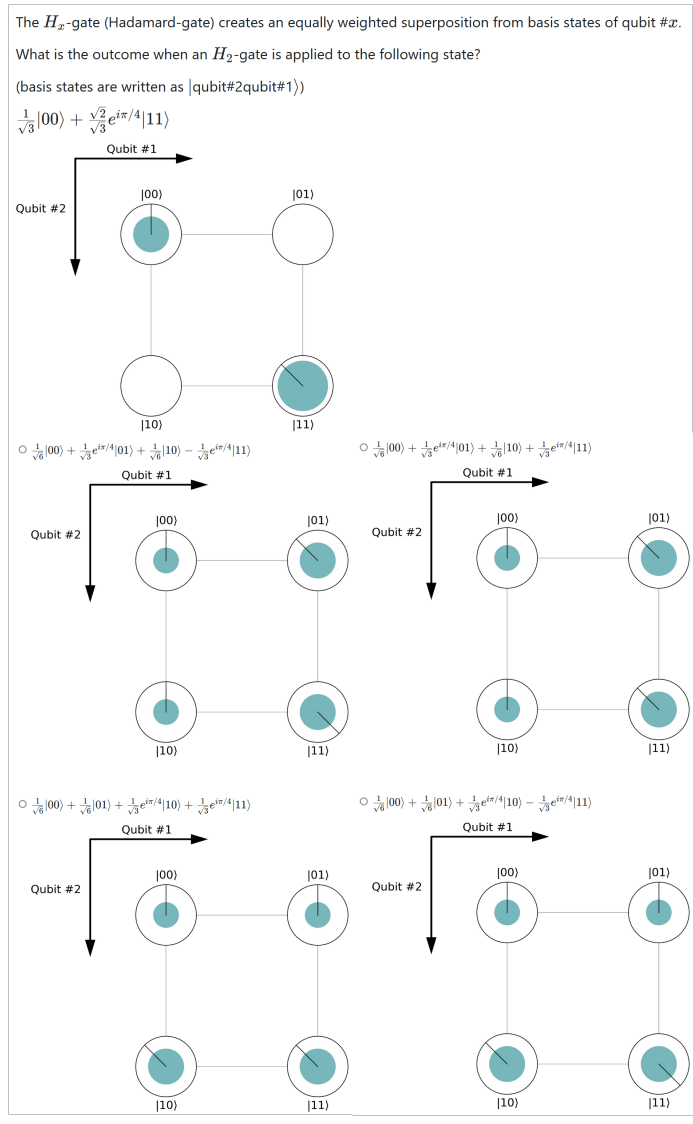

Fig. 8: Example task of predicting the outcome of a Hadamard gate. The correct answer is the one in the top left.

effort of the participants (literally, the perceived level of cognitive engagement and the intensity of thinking), which is supposedly linked to GCL [56].

6 Results & Discussion

In the following, we refer to group math-vis as the group that was assigned questions without visualization in survey part A and questions with visualization in part B. Vice versa, the group vis-math was assigned questions with visualization in survey part A and questions without visualization in part B.

Due to the low number of participants, statistical analysis is limited. We show the standard deviation, where applicable, to describe the variance of the obtained data.

Table 1 summarizes the average translation competence, average scores, and average times for correctly solved questions. In addition, it shows the differences of these performance metrics with visualization minus without visualization. Average ICL, GCL and ECL and the corresponding differences (between with visualization and without visualization) are shown in 2. Figure 9 shows the average score per participant, and figure 10 the average time taken for correctly solved questions. The influence of translation competence on ICL, GCL and ECL as well as the average cognitive load is shown in figures 11, 12 and 13 for tasks with one, two, and three qubits.

Table 1: Average scores and time taken (in seconds) for correctly solved questions, and the difference of the performance metrics with visualization minus without.

number of qubits	one	two		three	
visualization	CN	CN	DCN	CN	DCN
avg. transl. comp.	0.85±0.23	0.85±0.14	0.71±0.24	0.85±0.17	0.9±0.12
score w/o vis.	0.67±0.24	0.62±0.28	0.56±0.24	0.62±0.26	0.69±0.3
score with vis.	0.68±0.24	0.63±0.25	0.53±0.29	0.68±0.25	0.62±0.27
score difference	0.0±0.29	0.01±0.22	-0.02±0.27	0.06±0.1	-0.07±0.15
time w/o vis.	104±74	82±47	121±58	105±32	148±136
time with vis.	88±56	113±76	139±99	119±76	116±61
time difference	-16±65	32±51	17±67	14±57	-32±87

Means and standard deviations are calculated taking the averages over the participants individual results.

Detailed results are described in the appendix A. In the following, we discuss the results obtained regarding answer correctness and time taken for correct answers for the one-qubit (section 6.1), two-qubit (section 6.2.1 and 6.2.2) and three-qubit (section 6.3.1 and 6.3.2) surveys. We summarize the discussion in section 6.4.

6.1 One-qubit systems

In the first survey, participants were asked to find

- a state that is equal to another state apart from a global phase
- the resulting state after application of an X gate (only in part A) or a Z gate (only in part B), phase gate, and a Hadamard (H) gate
- the probability of finding a particular result upon measurement of a given state, and

Table 2: Average ICL, GCL and ECL with and without visualization, and the corresponding differences of with visualization minus without.

number of qubits	one	two		three	
visualization	CN	CN	DCN	CN	DCN
ICL w/o vis.	3.75±0.97	4.2±0.6	4.7±1.49	4.62±0.99	4.4±1.36
ICL with vis.	3.64±1.04	3.89±0.99	4.0±1.54	4.4±1.11	4.0±1.0
ICL difference	-0.08±1.07	-0.22±0.79	-0.5±1.28	-0.25±1.2	0.0±1.22
GCL w/o vis.	4.12±1.41	4.67±0.82	4.91±1.0	4.89±1.37	4.6±1.5
GCL with vis.	3.94±1.26	4.11±0.74	4.73±1.05	4.4±1.36	4.0±1.41
GCL difference	-0.12±1.27	-0.62±0.99	-0.18±0.83	-0.44±1.26	-0.6±1.62
ECL w/o vis.	2.88±1.67	2.67±0.75	3.95±1.42	3.05±1.17	3.3±1.6
ECL with vis.	2.76±1.54	2.72±0.82	3.64±1.62	2.75±1.33	2.5±1.1
ECL difference	-0.12±2.21	0.06±1.34	-0.32±1.5	-0.3±1.33	-0.8±2.11

Means and standard deviations are calculated taking the averages over the participants individual results.

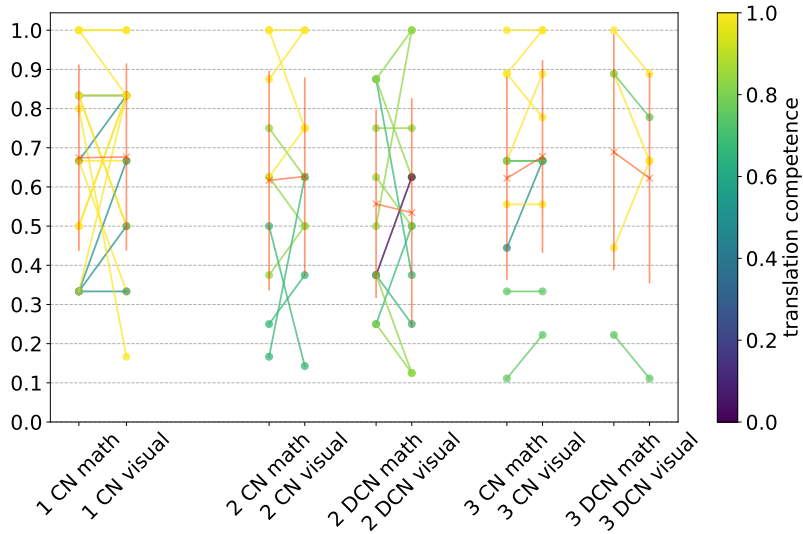

Fig. 9: Average scores for different numbers of qubits. Two points connected by a line represent an individual participant, colored according to the translation competence score of the participant in that survey. Mean and standard error are shown in orange.

- the resulting state after measurement.

The average scores for single-qubit questions are shown in table A1 and the average times for correctly solved questions are shown in table A2. Figure A3 shows the combined average score per question and figure A4 shows the combined average time taken (for all answers, not only the correct ones).

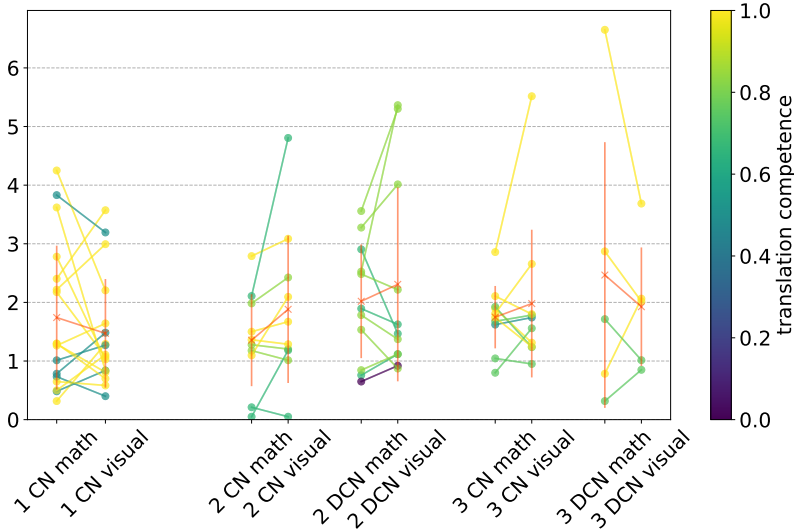

Fig. 10: Average time taken per participant for correctly solved questions and translation competence. Two points connected by a line represent an individual participant, colored according to the translation competence score of the participant in that survey. Mean and standard error are shown in orange. Times above 20 minutes were excluded.

During part A, group math-vis solved questions without visualization with an average score of 0.67 ± 0.13 and an average time of 2.09 ± 1.27 minutes for correctly solved questions, while group vis-math answered the same questions with visualization with an average score of 0.5 ± 0.24 and an average time of 1.09 ± 0.41 minutes. During part B, the average scores were 0.67 ± 0.15 (group vis-math) and 0.83 ± 0.12 (group math-vis), respectively, at average times for correctly solved questions of 1.81 ± 1.28 and 2.01 ± 1.88 minutes. When combining parts A and B of the survey, the average scores were 0.68 ± 0.15 without visualization and 0.71 ± 0.18 with visualization, at 1.44 ± 0.49 and 1.1 ± 0.67 minutes.

Group math-vis scored higher than group vis-math in both parts of the survey, regardless of whether visualization was presented (see table A1), especially when asked about the relation of probabilities of measuring 0 or 1 in both parts of the survey (0.62 to 0.25) and in the global phase questions of part B (1.0 to 0.62). Knowing the probabilities and the state of the qubit after measurement could be more closely related to the previous knowledge of the students than whether CN is presented. In this domain, group math-vis appears to have had higher previous knowledge than group vis-math. In the global phase question, we see the largest score difference among all question types within the group math-vis with an average score of 0.56 without visualization, as compared to 1 with visualization. It could be the case that, here, the group math-vis especially benefited from the visualization. This could be an indicator

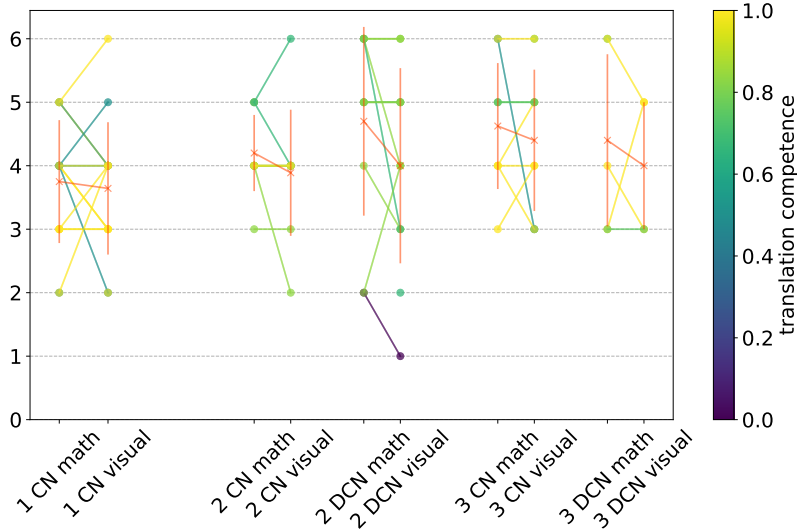

Fig. 11: Intrinsic Cognitive Load (ICL) by number of qubits, without visualization (math) and with visualization. Two points connected by a line represent single participants, colored according to the translation competence score of the participant in that survey. Mean and standard error are shown in orange.

of a beneficial effect of the visual depiction of a complex phase with a gauge, depending on the learner.

Although group math-vis scored higher with visualization, the contrary is true for group vis-math. These effects could be due to the characteristics of the learners or the difference in difficulty of the questions in parts A and B of the survey. Questions with visualization were solved correctly faster than questions without visualization, except for the global phase question. This could indicate that visualization made the questions easier to solve for those students who already knew how to solve them, according to the distance-difficulty hypothesis [51, 52].

Representational understanding

Participants were asked to calculate Euler formula identities and similar questions to translate between CN to a complex number. In addition, they were asked to multiply numbers written in Dirac notation and CN as shown in figure 6. Then they were asked to rate their confidence in the question from 0 (random guess), 1 (very unsure) to 4 (very sure). The correct answers were weighted (multiplied by $x/4$, where x is the confidence). The weighted (unweighted) average mathematics representational understanding was 0.76 ± 0.25 (0.87 ± 0.23). The weighted (unweighted) average CN representational understanding was 0.47 ± 0.34 (0.69 ± 0.32). The average weighted (unweighted) difference of CN representational understanding minus mathematics representational understanding was -0.29 ± 0.23 (-0.18 ± 0.19).

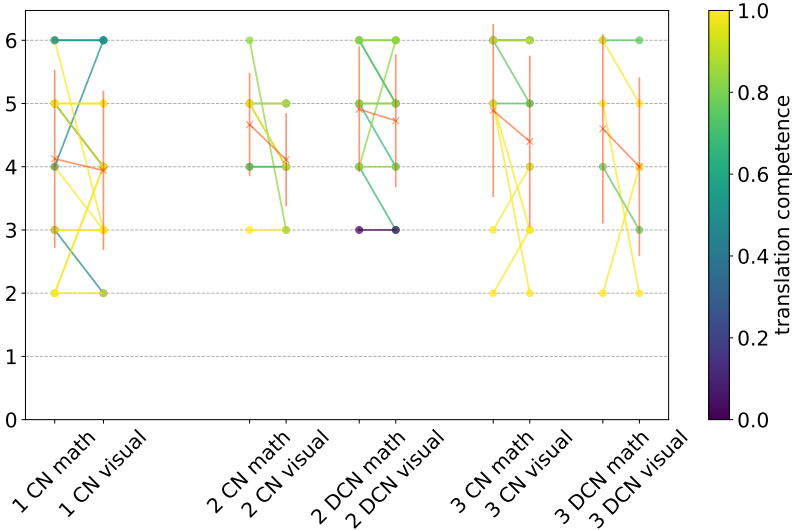

Fig. 12: Germane Cognitive Load (GCL) by number of qubits, without visualization (math) and with visualization. Two points connected by a line represent single participants, colored according to the translation competence score of the participant in that survey. Mean and standard error are shown in orange.

Figure 14 shows, for each participant in the first survey, the difference in scores (with visualization minus without visualization) and figure 15 the difference in time, both plotted against the difference in representational understanding between visualization and math. Figure 16 shows the dependency of the difference in intrinsic, germane, and ECL on the representational understanding difference.

No one scored higher with CN than with the Dirac notation (weighted or unweighted), suggesting that the representational understanding of most of the participants with the visualization was lower than that of the D notation. This could perhaps explain the rather low impact of the visualization, as the results suggest that other factors play a bigger role. It is possible that presenting the visualization to students with high representational understanding with CN but low representational understanding with the Dirac notation has greater benefits. However, such students might be difficult to find.

All in all, there is no clear evidence that the visualization provides a general benefit, but there is also no evidence that the visualization provides no benefit. Possible effects are probably learner- and context-dependent. It is worth investigating further under which circumstances benefits occur. In one-qubit systems, the CN is merely a visual representation of complex numbers, providing an aid, in theory, complementary to the Dirac notation. In two- and three-qubit systems, DCN is an extension of CN that could provide additional benefits due to the introduction of dimensionality.

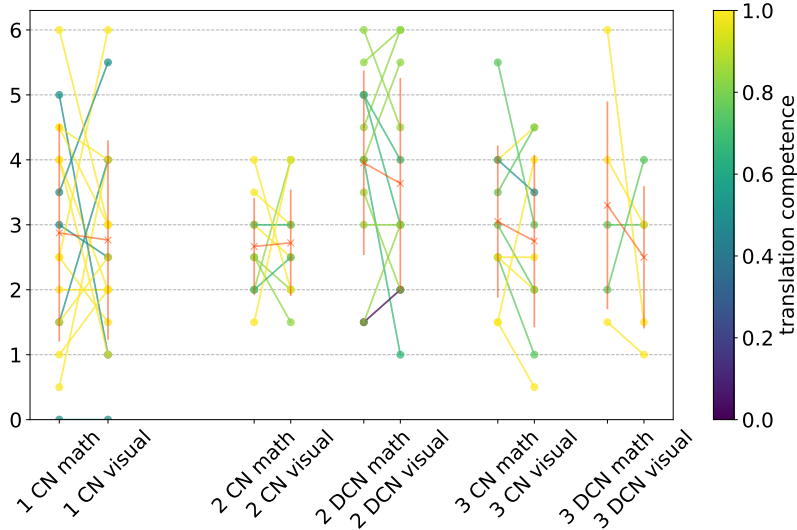

Fig. 13: Extraneous Cognitive Load (ECL) by number of qubits, without visualization (math) and with visualization. Two points connected by a line represent single participants, colored according to the translation competence score of the participant in that survey. Mean and standard error are shown in orange.

Translation competence and cognitive load

On average translation competence, 12 students achieved perfect scores and 5 students achieved a score of 0.5. The students who did not score perfectly also scored lower in the rest of the survey (0.5 ± 0.21 to 0.75 ± 0.21 without visualization and 0.63 ± 0.19 to 0.69 ± 0.25 with visualization) and took a smaller amount of time on the correctly solved questions (82 ± 74 to 114 ± 71 seconds without visualization and 86 ± 57 to 89 ± 55 seconds with visualization) than the students who solved the translation questions perfectly. Obtaining only two average scores for translation competence does not leave much room for interpretation of the correlation between translation competence and score difference.

Average ECL (2.88 ± 1.67 with visualization and 2.76 ± 1.54 without) was lower than the average ICL (3.75 ± 0.97 with visualization and 3.64 ± 1.04 without) and GCL (3.94 ± 1.26 with visualization and 4.13 ± 1.41 without). In the difference of perceived ECL of survey parts supported by visualization minus parts not supported by visualization, the numbers fluctuate much more (as can be seen in the high variance, depicted in table 1). This high variance could indicate a large dependency of ECL reduction due to visualization on learner characteristics.

There is no apparent sign of cognitive load being linked to translation competence, although it is difficult to say due to the coarse resolution of translation competence, as most participants had a perfect score on the test items. All in all, in the one-qubit system, due to the large fluctuations, one cannot conclude that the visualization provides a benefit in terms of cognitive load. This requires further investigation.

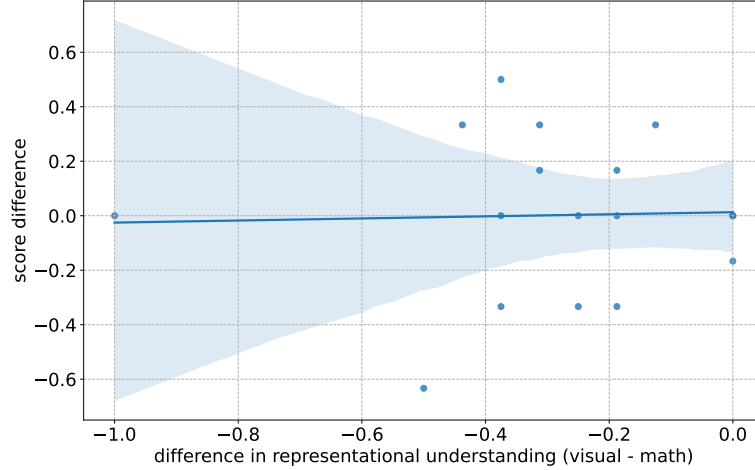

Fig. 14: Difference of average score (with CN minus without CN) plotted against difference of representational understanding (with CN minus without CN) in the one-qubit survey. The linear regression has slope $b = 0.04$, intercept $a = 0.01$, Pearson $r = 0.03$ at $p = 0.91$, standard error $\sigma = 0.32$. The shaded areas represents a 95% confidence interval.

6.2 Two-qubit systems

In both parts of the second survey, participants were split into two groups, one presented with CN and one presented with DCN, and were asked to find:

- the resulting state after application of an X gate, a Z gate, and a Hadamard (H) gate,
- the probability of finding a particular result upon measurement of a given state,
- the resulting state after application of a CNOT gate,
- a separable state and an entangled state (between non-separable, or non-entangled states, respectively), and
- a combination of two gates that were applied to transform one given state into another given state (“guess-the-gates” (gtg) questions).

The average scores for two-qubit questions are shown in table A3 and the average times for correctly solved questions are shown in table A4. In the latter, the combined score of part A and part B show only cases where participants managed to solve both questions, i.e. both questions on the same concept with and without visualization, correctly. Figure A3 shows the combined average score per question and figure A4 shows the combined average time taken (for all answers, not only the correct ones).

6.2.1 Two-qubit systems with Circle Notation

During part A, participants assigned to the CN group solved the questions without visualization with an average score of 0.72 ± 0.14 with an average time of 1.54 ± 0.62

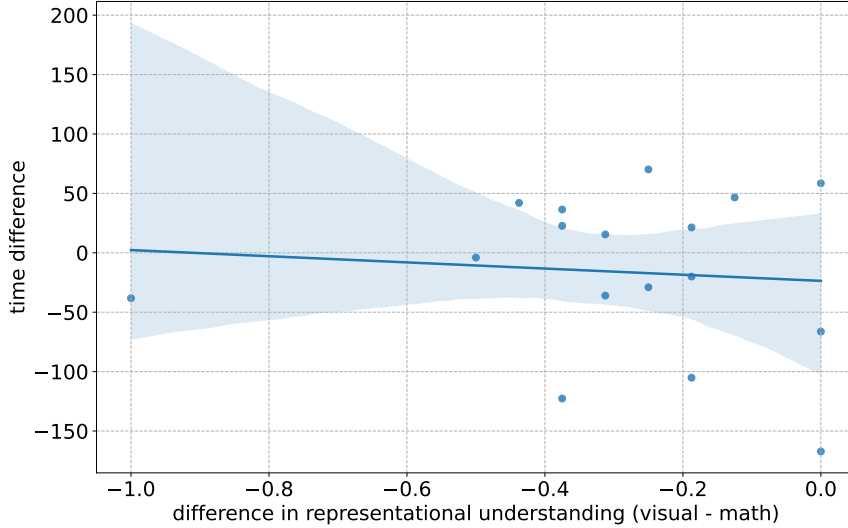

Fig. 15: Average time taken for correct answers (with CN minus without CN) plotted against difference of representational understanding (with CN minus without CN) in the one-qubit survey. The linear regression has slope $b = -26$, intercept $a = -24$, Pearson $r = -0.09$ at $p = 0.73$ and standard error $\sigma = 73$. The shaded areas represents a 95% confidence interval.

minutes for correctly solved questions, while the other group answered the same questions with visualization with an average score of 0.65 ± 0.26 with an average time of 2.18 ± 1.02 minutes. During part B, the mean scores with and without visualization were 0.55 ± 0.17 and 0.62 ± 0.12 , respectively, at average times for correctly solved questions of 1.46 ± 0.67 and 1.68 ± 1.12 minutes. When combining parts A and B of the survey, the average scores were 0.64 ± 0.13 without CN and 0.64 ± 0.12 with CN, at 1.48 ± 0.51 and 1.98 ± 1.05 minutes.

In both survey parts, we see group math-vis scoring higher or the same as group vis-math on all questions except the separability and entanglement questions, where group vis-math scored higher. This could be explained with learner characteristics, such as the specific competence to identify entanglement. In addition, the vis-math group scored higher on these questions when presented with visualization. Perhaps, the group used a strategy of comparing circles similar to that shown in figure 4, to identify separability and entanglement in CN, which the other group did not know. The H gate question shows a large difference in score between the two groups, where group math-vis scored 0.8 without visualization and group vis-math only 0.2. This, again, could hint towards the Hadamard gate question performance being especially prone to learner prerequisites. Using the average of all the questions, there is no increase in the average score when participants solved questions with visualization, with 64% being correctly solved in both cases.

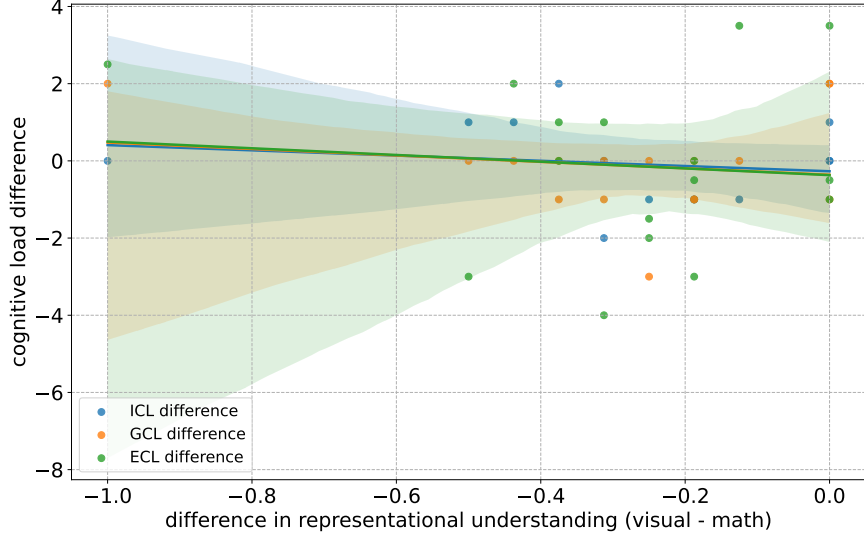

Fig. 16: Perceived intrinsic, germane and ECL difference (with CN minus without CN) and their dependency on the representational understanding difference (again, with CN minus without CN) in the one-qubit survey. Shown are also the linear regressions between the three variables and the representational understanding difference with slope b and intercept a . Pearson's r , p value and standard error σ are as follows. ICL: $b = -0.68$, $a = -0.27$, $r = -0.16$, $p = 0.59$, $\sigma = 1.2$ GCL: $b = -0.83$, $a = -0.36$, -0.16 , $p = 0.56$, $\sigma = 1.4$ ECL: $b = -0.87$, $a = -0.37$, $r = -0.09$, $p = 0.73$, $\sigma = 2.5$. The shaded areas represent 95% confidence intervals.

Participants took longer when presented with the visualization when solving questions correctly, except for only a few questions, namely the *gtg* questions in both survey parts and the X gate question in survey part B. The H gate and separability questions of part B were solved only marginally faster when presented with CN. The overall longer time taken for questions with visualization (113 ± 76 seconds) than questions without visualization (82 ± 47 seconds) could be a result of visualization bringing the questions further toward the level of the participant's ability, according to the distance-difficulty hypothesis [51, 52]. The high variance in the time taken for correct answers could be a result of not controlling the survey environments. In addition, for many questions, there is only a small number of data points to consider since this number depends on the number of participants that solved these questions correctly.

Translation competence and cognitive load

Similarly to the one-qubit survey, participants scored 0.85 ± 0.14 in translating between CN and Dirac notation. Again, we see that participants who scored perfectly when solving these questions also scored higher in the rest of the survey (0.88 ± 0.15 without and 0.88 ± 0.13 with visualization) than participants without a perfect score

(0.44 ± 0.20 without visualization and 0.46 ± 0.17 with visualization). Translation competence therefore could be a good predictor for student performance overall. The reason could be that students more familiar with CN are also more familiar with basic quantum computing concepts, since CN is usually used to teach such concepts.

The group of participants with perfect translation scores also took more “reasonable” amounts of time to correctly solve questions, that is, the variance in time taken was lower (1.67 ± 0.65 seconds without visualization and 2.03 ± 0.67 with visualization) than in the group without a perfect translation competence score (1.13 ± 0.79 seconds without visualization and 1.78 ± 1.52 with visualization). Presumably, students that don’t know the answer and choose to take a guess will take a short amount of time, while students that try hard to find an answer in tasks where this would not be necessary for students with high previous knowledge, will take a long time. Therefore, a higher variance in the time taken for task solving could be expected for lower-performing students. This is expected according to the distance-difficulty hypothesis [51, 52].

There is no observable correlation between translation competence and the average score difference. This could be due to participants choosing one representation over the other when solving the questions, such that translation competence does not play a role for the performance. Translating between the representations is not necessary to solve these tasks. In future studies, eye tracking could be used to investigate whether participants translate between representations or stay only in one.

The results are similar to the results of the one-qubit survey with respect to perceived cognitive load. Average ICL (4.2 ± 0.6 without and 3.89 ± 0.99 with visualization) and GCL (4.67 ± 0.82 without and 4.11 ± 0.74 with visualization) are higher than average ECL (2.7 ± 0.75 without and 2.72 ± 0.82 with visualization). It seems that on average, the questions succeed in offering a high amount of intrinsic difficulty, while the design of the questions does not contribute too much. However, it cannot be stated that there is a significant difference in cognitive load when participants were presented with CN as compared to when they only used the Dirac notation.

6.2.2 Two-qubit systems with Dimensional Circle Notation

During part A, group math-vis solved questions without visualization with an average score of 0.56 ± 0.22 with an average time of 2.4 ± 0.59 minutes for correctly solved questions, while group vis-math answered the same questions with an average score of 0.6 ± 0.24 with an average time of 3.57 ± 2.66 minutes. During part B, the average scores were 0.55 ± 0.24 and 0.48 ± 0.26 , respectively, at average times for correctly solved questions of 2.56 ± 1.73 and 3.62 ± 2.12 minutes. When combining parts A and B of the survey, the average scores were 0.56 ± 0.2 without visualization and 0.53 ± 0.2 with visualization, at 2.96 ± 2.22 and 5.24 ± 5.93 minutes.

In all question types, one group performed better than the other group in both part A and part B (regardless of whether visualization is presented). The difference between the scores of the groups is particularly apparent in the H gate, entanglement, and CNOT gate questions in favor of group vis-math (0.5 to 0.17, 0.7 to 0.42, and 0.9 to 0.69, respectively) and the gtg and separability questions in favor of group math-vis (0.42 to 0.1 and 0.67 to 0.5, respectively). This consistency can possibly be explained

by learner prerequisites that predict the performance in these questions better than whether visualization is presented or not. In addition, this could be a manifestation of the context dependency of student competence, i.e., a student being competent with one quantum process does not necessarily mean that the student is also competent with other processes. Group vis-math scored lower on the gtg question in both parts of the survey than on all other questions. In addition, group math-vis scored lower on the gtg question with visualization than on the gtg question without visualization. This is consistent with the lower performance of the group on the H gate question, because the H gate was part of the gtg question in survey part B but not of the gtg question in survey part A. Group math-vis appeared to have lower competence with the H gate than group vis-math.

Considering the amount of time spent for correctly solved questions, we see outliers of more than 6 minutes in the group vis-math on the Z gate A, H gate A, and H gate questions of part B. Participants took, on average, longer when presented with visualization than when they were not. This is largely due to these outliers, as, when removing the outliers, the difference is only marginal (1 minute 58 seconds without visualization to 2 minutes and 5 seconds with visualization).

Translation competence and cognitive load

In the two-qubit survey, translation competence was lower in the DCN group at 0.71 ± 0.25 than in the CN group at 0.85 ± 0.23 . In addition, no one in the DCN group correctly answered all the translation questions. The average scores in this survey were also lower than in all other surveys, at 0.56 ± 0.2 without visualization and 0.53 ± 0.2 with visualization.

For participants of the DCN group, ICL was slightly higher than for participants of the CN group when solving math questions at 4.7 ± 1.36 , as compared to 3.89 ± 1.0 , and we see indications of reductions in ICL and ECL when participants are presented with DCN of -0.5 ± 1.35 and -0.32 ± 1.57 , respectively, with a rather large fluctuation of this difference. We do not see a similar reduction in GCL as we do in the CN group. In total, these results indicate that there could be reductions in ICL and ECL when students are presented with DCN. The large fluctuation of this supposed reduction could indicate that the possible benefit of DCN presentation in cognitive load would depend on the learner.

ECL in general is high compared to all the other surveys at 3.95 ± 1.42 without visualization and 3.64 ± 1.62 with visualization. These results could indicate an anti-correlation between translation competence and ECL that future studies could look into further. Students with higher representational competence should experience less GCL when solving tasks where this representational competence is necessary [56]. In addition, if students can adopt new strategies to solve questions using DCN rather than the Dirac notation, a reduction in ICL could be theoretically explainable, if these strategies themselves make it easier to solve the task. These results warrant further investigation into the exact conditions under which the presentation of DCN has a positive impact on ICL and ECL.

6.3 Three qubits

In the third survey, participants were asked to find:

- the resulting state after application of an X gate, a Z gate, and a Hadamard (H) gate,
- the probability of finding a particular result upon measurement of a given state,
- the resulting state after a measurement,
- the resulting state after application of a CNOT gate,
- a fully separable state and a fully entangled state (between partially separable/entangled states), and
- a combination of two gates that were applied to transform one given state into another given state (“guess the gates” (gtg) questions).

The average scores for the three-qubit questions are shown in table A5 and the average times for correctly solved questions are shown in table A6. In the latter, the combined score of part A and part B show only cases where participants managed to solve both questions, i.e., two questions of the same topic, correctly. Figure A5 shows the combined average score per question and figure A6 shows the combined average time taken (for all answers, not just the correct ones). Cases where a participant took more than 20 minutes for one question were excluded as we find that these are unreasonable times for these tasks.

6.3.1 Three-qubit systems with Circle Notation

During part A, participants assigned to the math-vis group solved the questions without visualization with an average score of 0.58 ± 0.26 and an average time of 1.77 ± 0.94 minutes for correctly solved questions, while the group vis-math solved the same questions with visualization with an average score of 0.76 ± 0.28 and an average time of 3.0 ± 1.63 minutes for correctly solved questions. During part B, the average scores were 0.67 ± 0.31 and 0.6 ± 0.25 for the two groups, respectively, with average times for correctly solved questions of 2.43 ± 1.26 and 1.25 ± 0.45 minutes. When combining parts A and B of the survey, the average scores were 0.62 ± 0.28 without visualization and 0.68 ± 0.25 with visualization, at 2.38 ± 1.33 and 2.37 ± 1.51 minutes.

In general, the participants scored marginally higher when presented with CN (0.68 ± 0.25) than when presented with no visualization (0.62 ± 0.28). The results of the H gate and gtg questions could indicate that there was a benefit in presenting the visualization to the participants in these contexts, as both groups scored higher here when presented with visualization (0.9 compared to 0.6 for the H gate question and 0.6 compared to 0.1 for the gtg question). In the entanglement question, group math-vis scored higher (0.6 without visualization and 0.4 with visualization) than group vis-math (0.2 with and without visualization) in both parts of the survey, while in the Z gate and measurement probability questions, all participants in the vis-math group correctly solved the questions in both parts of the survey, while 60% of participants in the math-vis group correctly solved these questions in both cases. This could indicate differences in context-dependent competence of the two groups, similar to what we observed in the two-qubit survey. Group math-vis appeared to have not benefited from

visualization in the separability, entanglement, and CNOT gate questions, scoring 0.2 and 0.4, 0.4 and 0.6, and 0.6 and 0.8, without and with visualization, respectively, while the vis-math group scored the same with and without visualization on the X gate, Z gate, measurement probability, separability, and entanglement questions (1.0, 1.0, 1.0, 0.4, and 0.2, respectively).

In summary, we see that the X gate, Z gate, CNOT gate, and measurement probability questions. At the same time, the results warrant further investigation in the regime of the more complex H gate, gtg, separability, and entanglement questions to find the reasons for the increase in performance with visualization in the H gate and gtg questions and the lack of performance difference in the measurement state, separability, and entanglement questions. To benefit from visualization in the context of separability and entanglement, students may need a thorough introduction to the strategy to identify separability and entanglement (figure 4).

Translation competence and cognitive load

In the three-qubit survey, participants presented with CN scored on average 0.85 ± 0.17 on the translation competence questions, in line with the results of the one- and two-qubit CN survey. Participants who scored perfectly in translation competence also scored comparatively high in the rest of the survey at 0.8 ± 0.16 without visualization and 0.84 ± 0.17 with visualization, compared to 0.44 ± 0.21 and 0.51 ± 0.19 for the other participants. However, we do not see expression of this translation competence in an improvement of score when presented with visualization.

When participants are presented with CN, we observe indications of a reduction in ICL, GCL and ECL of -0.25 ± 1.28 , -0.44 ± 1.33 and -0.3 ± 1.4 , respectively. These results justify further investigation into the circumstances under which a reduction in cognitive load occurs by presentation of CN. We see a generally lower ECL (3.05 ± 1.17 without and 2.75 ± 1.33 with visualization) than ICL (4.63 ± 0.99 without and 4.4 ± 1.11 with visualization) and GCL (4.89 ± 1.37 without and 4.40 ± 1.36 with visualization), indicating that participants perceived the questions themselves as difficult, but less so their design.

6.3.2 Three-qubit systems with Dimensional Circle Notation

During part A, participants assigned to the DCN group solved questions without visualization with an average score of 0.89 ± 0.21 with an average time of 4.75 ± 1.77 minutes for correctly solved questions, while the same questions with visualization were answered with an average score of 0.6 ± 0.24 with an average time of 2.32 ± 0.63 minutes. During part B, the average scores were 0.56 ± 0.16 and 0.72 ± 0.34 , respectively, at average times for correctly solved questions of 2.0 ± 1.34 and 2.29 ± 1.33 minutes. When combining parts A and B of the survey, the average scores were 0.69 ± 0.15 without visualization and 0.62 ± 0.29 with visualization, at 3.03 ± 0.78 and 2.44 ± 0.9 minutes.

Group math-vis consists of two students and group vis-math of three participants. Hence, the resolution on the average score value per question is rather coarse. Due to the large impact a single persons performance can have on the results, it is difficult to draw any conclusions. Future studies could focus more on the impact of

DCN in the domain of three qubits, in particular. If there is any benefit of visualizing quantum states representing qubits as axes in space, one would expect the benefit to be the largest here because the difference between the dimensional approach and the approach of standard CN is larger the higher the number of qubits in the system. Similarly to the results for the answer correctness, it would be unreasonable to make statements about time taken for correct answers due to the small number of participants.

Translation competence and cognitive load

The impact of the results of one participant seems too large to make any assumptions about the translation competence and cognitive load in the three-qubit DCN context.

6.4 Summary of discussion & Limitations

In general, we do not see indications of a large change in performance when participants are presented with a visualization (see table 1). There are slight indications of context-dependent performance increases with visualization. This is apparent in the global phase question of the one-qubit survey, the Z gate, the measurement probability, and the separability question of the two-qubit CN survey, the H gate question of the two-qubit DCN survey, and the H gate and gtg questions of the three-qubit CN survey. However, context-dependent learner characteristics seem to have a greater impact on performance than the presence or absence of a visualization. Some groups seem to perform better than other groups specifically in certain types of questions, as we see in the two-qubit CN survey in the X gate, the H gate, separability and entanglement questions, all questions in the two-qubit DCN survey, and in the Z gate, measurement probability, entanglement, CNOT gate, and guess-the-gates questions in the three-qubit CN survey.

In order to find indicators of complexity and suitability of questions, we considered the time taken for all answers, not just correct ones (see figure A2, figure A4 and figure A6 for the one-, two- and three-qubit surveys, respectively). During the one-qubit survey, the global phase and the Hadamard gate question took the participants the longest time. During the two-qubit survey, the same was the case for the guess-the-gates and measurement probability questions for participants in the CN survey, and the guess-the-gates, H gate, and Z gate questions for participants of the DCN survey (see figure A4). In the three-qubit survey, participants presented with both CN and DCN took the longest in the guess-the-gates and H gate questions (see figure A6). Long times could in some cases be due to greater complexity and in some cases to the distance-difficulty hypothesis [51, 52], which would state that these questions were also the most suitable for the participants in terms of level of ability.

We also measured the cognitive load imposed on the students during all parts of all surveys. The generally high ICL and average scores between 0.5 and 0.7 indicate that the difficulty of the problems was adequate overall. We see reductions in cognitive load when students are presented with visualization in both CN and DCN surveys. ECL is mostly lower than ICL and GCL, except for the two-qubit DCN survey. It could be the case that the amount of space DCN takes up compared to CN leads to increased ECL, due to participants not being able to see all answers at once (which means page

scrolling becomes necessary), resulting in a possible split-attention effect [57]. On the other hand, the lower translation competence of participants in the two-qubit DCN survey could also be a reason for the higher ECL.

In this study, we have seen how performance can be context-dependent. The cognitive load might also be context dependent. The cognitive load results give an overview of the cognitive load with and without visualization, but one cannot make assumptions for specific contexts with these measurements. It can also be taken into account that measurements of cognitive load after multiple questions could be biased toward the most recently answered questions, which would be the measurement questions in the one-qubit survey and the guess-the-gates questions in the two- and three-qubit surveys.

In general, due to small sample sizes (especially in the three-qubit DCN survey) and large fluctuations (possibly due to large deviations of learner prerequisites), we can only suspect indicators of positive effects of presenting a visualization regarding performance and cognitive load. The circumstances and contexts in which these possible effects occur should be investigated more thoroughly. Reevaluation of the test instrument can be based on fine tuning to make the questions in parts A and B of the surveys more similar. In addition, future studies could further investigate the competence of students when presented with only a visualization and how this representational competence impacts possible benefits of presenting a visualization in addition to the Dirac notation.

7 Conclusion & Outlook

The results of this study, although inconclusive, open up a wide range of questions to investigate in future studies. As we see some students benefiting from the visualization (in terms of performance increase and cognitive load reduction) and some not, it will be interesting to investigate further under which circumstances exactly students benefit from the visualization. Especially contexts within the three-qubit DCN setting should be investigated more thoroughly, as the number of participants in this survey was low. In addition, here DCN differs the most from the other two representations, since the number of steps necessary to transform CN to DCN is larger the more qubits the system has. Our results indicate a dependency of the results on context-dependent learner characteristics. Therefore, future studies should control for these characteristics in a more detailed way to draw conclusions regarding the potential benefit of the visualizations, e.g., by constricting the context by focusing on a specific type of question. If future studies find significant benefits of visualization, the exact reasons for this could remain unclear, as learners could have used the visualization as support, complementary to the mathematical notation, or have worked exclusively in the visualization. Eye tracking could be used to account for this [58].

Representational competence as a learner characteristic is theoretically the deciding factor for whether a visualization supports learning. Therefore, it could be considered to measure representational competence more thoroughly in future studies. This could be done, for example, by increasing the number of translation competence

questions that measure connectional understanding, and finding other ways to measure representational competence that also includes visual understanding of CN or DCN and quantum operations in these visualizations.

In general, we saw indications of reductions in perceived cognitive load by presenting CN or DCN. Due to the consistency in which this occurs, it is possible that there are beneficial effects regarding a reduction of cognitive load when students are presented with a visualization. A decrease in ECL should, in theory, lead to improved learning outcomes when learning with visualization, if this decrease coincides with an increase in germane cognitive load [59, 60]. If we find a decrease in all types of cognitive load, it could be that the questions become inherently easier when asked and solved in CN or DCN. Another point to consider is that the cognitive load induced on the learner could be context-dependent, i.e., for some question types, cognitive load change by presentation of a visualization might differ from other question types. In addition, learning with visualization could also improve the competency of participants when solving questions in uncomplemented Dirac notation. Investigating further whether there is any statistical significant benefit for students presented with visualization, and under which circumstances and in which contexts this occurs, could therefore be of great interest to the quantum education community.

Eye tracking studies can be used to control which representation is used during task solving and can be combined with cognitive load measurements to investigate the intricacies of cognitive processes during task solving [58]. Going beyond static multiple external representations, conveying processes in DCN using video sequences and sound could be worth studying. Furthermore, investigating learning outcomes by including interactivity in the teaching process, for example, by gamification, could be an alternative path forward, as there already exists a multitude of quantum games [61] where DCN could be incorporated. Also, the possible beneficial effects of other visualization techniques and their context- and learner-dependency remain to be investigated in multi-qubit systems. In conclusion, the benefits of the use of visualizations in quantum education have yet to be explored in a carefully curated way. In this work, we took a first step towards answering the question in which circumstances visualizations can support students in the field of Quantum Information Science & Technology.

Declarations

Availability of data and materials. The datasets generated and analyzed during the current study are available in the following repository: <https://doi.org/10.5281/zenodo.11258603>.

Competing interests. The authors declare that they have no conflict of interest.

Ethical Approval. All procedures performed in the study were in accordance with the ethical standards of the institutional and/or national research committee and with the declaration of Helsinki of 1964 and its subsequent amendments or comparable ethical standards. The study involved data collection in three online surveys. Participation in this study was voluntary and anonymous. The data collected included

participants' age, gender, field of study, and highest educational achievement. Data of participants is kept confidential and used solely for research purposes.

Informed Consent. Informed consent was obtained from all individual participants included in the study, in each survey.

Authors' contributions. J.B., E.R., A.A., S.K., J.K., M.K.-E., and A.W. designed the study. J.B., L.K., S.S., P.L., and M.K.-E. collected the data. J.B., E.R., A.A., and A.W. analyzed and discussed the data. L.K. and S.S. programmed the questionnaire website. L.K. and N.L. programmed and updated the DCN webtool. J.B., E.R., S.K., and M.K.-E. wrote the first draft of the manuscript. A.A. and A.W. reviewed the manuscript and provided feedback. P.L., J.K., M.K.-E., and A.W. supervised the study. All authors have read and approved the final manuscript.

Acknowledgements. The authors thank all the study participants.

J.B., E.R., A.A., M. K-E., P.L., and A.W. acknowledge support by the Quant-TUK project at the RPTU in Kaiserslautern, supported by the Federal Ministry of Education and Research (FKZ13N15995).

M.K-E., P.L., and A.W. acknowledge support from the Quantum Initiative Rhineland-Palatinate (QUIP) and the Research Initiative Quantum Computing for Artificial Intelligence (QC-AI).

L.K., S.S., N.L. and P.L. acknowledge support by the KI4TUK project at the RPTU in Kaiserslautern, supported by the Federal Ministry of Education and Research (BMBF) under grant number 16DHBKI058.

S.K. and J.K. acknowledge support by the Quantum Lifelong Learning (QL3) project at the LMU Munich, supported by the Federal Ministry of Education and Research (BMBF) under grant number 13N16024, and the DigiQ project (EU), supported by the European Union's Digital Europe program under grant number 101084035.

Appendix A Detailed Results

We show detailed results for single-qubit (Section A.1), two-qubit (Section A.2) and three-qubit studies (Section A.3). We describe the average correctness per question with and without visualization and survey parts A and B and the combined score of part A and B. Then, we do the same for average time taken for correct answers, considering for the combination of parts A and B only cases where both questions of each topic, with and without visualization, were answered correctly.

A.1 one-qubit survey

The average scores for single-qubit questions are shown in table A1 and average times for correctly solved questions in table A2. In the latter, the combined score of part A and part B show only cases where participants managed to solve both questions, i.e. both questions on the same concept with and without visualization, correctly. Figure A1 shows the combined average score per question and figure A2 shows the combined average time taken (for all answers, not just the correct ones). Cases in which a participant took more than 20 minutes for one question were excluded.

During part A, group math-vis solved questions without visualization with an average score of 0.67 ± 0.13 and an average time of 2.09 ± 1.27 minutes for correctly solved questions, while group vis-math answered the same questions with visualization with an average score of 0.5 ± 0.24 and an average time of 1.09 ± 0.41 minutes. During part B, the average scores were 0.67 ± 0.15 (group vis-math) and 0.83 ± 0.12 (group math-vis), respectively, at average times for correctly solved questions of 1.81 ± 1.28 and 2.01 ± 1.88 minutes. When combining parts A and B of the survey, the average scores were 0.68 ± 0.15 without visualization and 0.71 ± 0.18 with visualization, at 1.44 ± 0.49 and 1.1 ± 0.67 minutes.

In survey part A, group math-vis scored higher than group vis-math on the global phase, X gate, phase gate, H gate, measurement probability, and measurement state questions with an average score of 0.67 ± 0.13 to 0.5 ± 0.24 on these questions and did not score lower on any questions. Group math-vis took longer on correct answers to the X gate, phase gate, H gate, and measurement state questions with an average of 151 ± 74 to 56 ± 22 seconds while taking less time on the global phase and measurement probability questions with 84 ± 4 to 75 ± 1 seconds.

In part B of the survey, group math-vis scored higher than group vis-math on the global phase Z gate, H gate, measurement probability, and measurement state questions, with an average of 0.84 ± 0.13 to 0.62 ± 0.14 . Group vis-math scored higher on the phase gate question, with 0.88 to 0.78 . Group math-vis took more time on the global phase, Z gate, and measurement state questions with 178 ± 120 to 140 ± 85 seconds and group vis-math took longer on phase gate, H gate and measurement probability questions with 77 ± 23 to 63 ± 19 seconds.

When presented with visualization, group math-vis scored higher on the global phase, H gate, measurement probability, and measurement state questions with average scores of 0.86 ± 0.14 to 0.67 ± 0.14 . When presented questions with visualization, group math-vis took longer on the global phase question with 177 to 77 seconds and took a shorter amount of time on the phase gate, H gate, measurement probability,

and measurement state questions with 104 ± 43 to 56 ± 21 seconds than when the group was not presented with a visualization. Group vis-math scored higher when presented without visualization on the global phase, phase gate, H gate, and measurement probability question with scores of 0.66 ± 0.18 to 0.5 ± 0.23 . Group vis-math took longer on the measurement probability and measurement state questions when presented with visualization with 57 ± 23 to 37 ± 15 seconds and took less time on the global phase, phase gate, and H gate questions with 118 ± 43 to 63 ± 20 seconds.

Table A1: Average scores for one-qubit questions, with and without visualization (N=17).

survey part	A		B		combined	
question	w/o vis. ¹	with vis. ²	w/o vis. ²	with vis. ¹	w/o vis. ³	with vis. ³
global phase	0.56	0.5	0.62	1.0	0.59	0.76
X gate	0.56	0.25	-	-	-	-
Z gate	-	-	0.62	0.78	-	-
phase gate	0.78	0.75	0.88	0.78	0.82	0.76
H gate	0.67	0.62	0.75	0.78	0.71	0.71
measurement probability	0.56	0.12	0.38	0.67	0.47	0.41
measurement state	0.89	0.75	0.75	1.0	0.82	0.88
Mean	0.67 ± 0.13	0.5 ± 0.24	0.67 ± 0.16	0.83 ± 0.12	0.68 ± 0.15	0.71 ± 0.18

Note: questions are shown in order of appearance in the study.

¹N = 9

²N = 8

³N = 17

⁴Standard deviation is used for confidence intervals.

A.2 two-qubit survey

Table A3 lists the average scores and table A4 lists the average time taken for correctly solved one-qubit questions, with and without visualization, for surveys that were taken supported by CN and DCN. Figure A3 shows the combined average score per question and figure A4 shows the combined average time taken (for all answers, not just correct ones). Cases where a participant took more than 20 minutes for one question were excluded.

A.2.1 Circle Notation

During part A, participants assigned to the CN group solved questions without visualization with an average score of 0.72 ± 0.14 with an average time of 1.54 ± 0.62 minutes for correctly solved questions, while the same questions with CN were answered with an average score of 0.65 ± 0.26 with an average time of 2.18 ± 1.02 minutes. During part B, the average scores with and without visualization were 0.55 ± 0.17 and 0.62 ± 0.12 , respectively, at average times for correctly solved questions of 1.46 ± 0.67 and 1.68 ± 1.12 minutes. When combining survey parts A and B, the average scores were 0.64 ± 0.13 without CN and 0.64 ± 0.12 with CN, at 1.48 ± 0.51 and 1.98 ± 1.05 minutes.

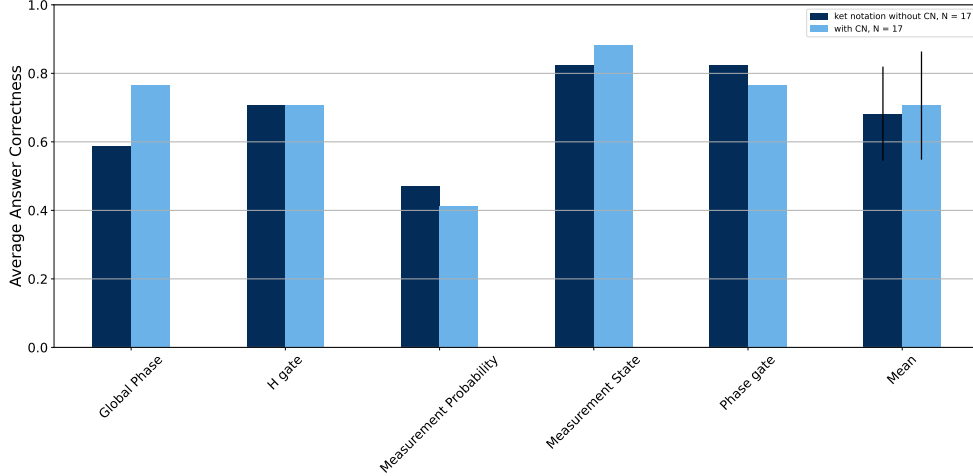

Fig. A1: Average score for each question in minutes in the one-qubit survey, for questions were participants were presented with CN (dark blue) and questions were the participants weren't presented with CN (light blue). (N=17).

While group math-vis, that was assigned questions without CN first, scored higher than group vis-math on the X gate and H gate questions in survey part A with, on average, 0.9 ± 0.1 to 0.3 ± 0.1 , the inverse is apparent for the separability and entanglement questions, where group vis-math scored higher than group math-vis 1.0 to 0.7 ± 0.1 . Group vis-math, with CN, took longer to correctly solve the X gate, Z gate, H gate, measurement probability, separability, entanglement, and CNOT gate questions with 132 ± 61 to 86 ± 32 seconds and took less time on the gtg questions with 140 to 125 seconds.

In survey part B, group math-vis (that was now given questions with CN) scored higher than group vis-math on the X gate, Z gate, H gate, measurement probability, and gtg questions with respective average scores 0.68 ± 0.1 to 0.44 ± 0.08 and group vis-math scored higher than group math-vis on the separability, entanglement, and CNOT gate questions with 0.73 ± 0.09 to 0.53 ± 0.09 . In this survey part, group math-vis, with CN, took longer on the Z gate, measurement probability, entanglement, and CNOT gate questions with, on average, 126 ± 74 to 61 ± 15 seconds while taking less time on the X gate, H gate, separability, and gtg questions with 114 ± 34 to 75 ± 34 seconds on these questions on average.

Comparing within each group, group math-vis scored higher than itself on the Z gate question with CN with 0.8 to 0.6 , and scored worse with CN than without CN on the X gate, H gate, entanglement, and CNOT gate questions with 0.85 ± 0.09 to 0.6 ± 0.14 . When solving questions correctly, group math-vis took longer on the X gate, H gate, measurement probability, and CNOT gate questions when presented with CN, with 138 ± 71 to 84 ± 39 seconds, while taking a shorter amount of time on the Z gate, separability, entanglement, and gtg questions with 101 ± 27 to 64 ± 9 seconds.

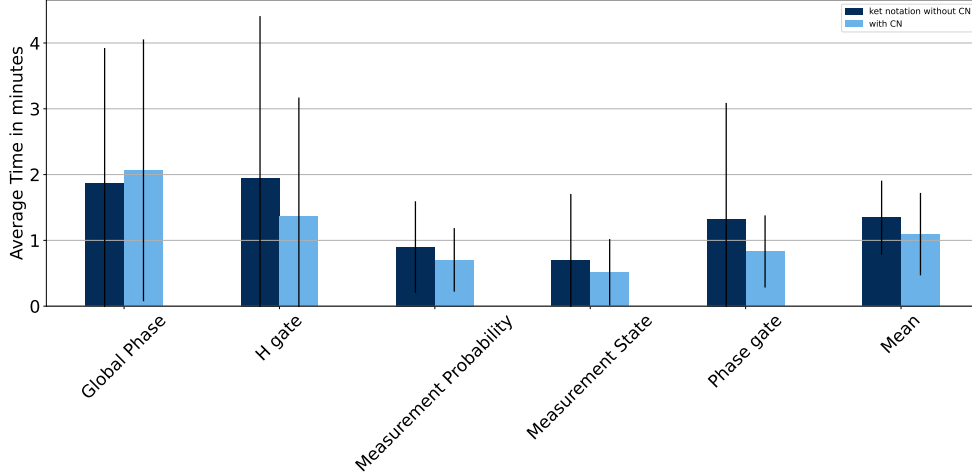

Fig. A2: Average time taken for each question in minutes in the one-qubit survey, for questions were participants were presented with CN (dark blue) and questions were the participants weren't presented with CN (light blue). (N=17).

When presented with CN, group vis-math scored higher than when presented with a visualization on the Z gate, measurement probability, separability, entanglement, and gtg questions with, on average, with 0.76 ± 0.2 to 0.52 ± 0.16 . The group scored higher when solving questions without CN on the X gate and H gate questions with 0.5 ± 0.1 to 0.3 ± 0.1 . They took longer with CN when solving the Z gate, measurement probability, separability, entanglement, and CNOT gate questions correctly, with an average of 142 ± 68 to 60 ± 14 seconds, and took less time on the X gate, H gate, and gtg questions when presented with CN, with 134 ± 8 to 112 ± 22 seconds.

A.2.2 Dimensional Circle Notation

During part A, participants assigned to the DCN group solved questions without visualization with an average score of 0.56 ± 0.22 with an average time of 2.4 ± 0.59 minutes for correctly solved questions, while the same questions with visualization were answered with an average score of 0.6 ± 0.24 with an average time of 3.57 ± 2.66 minutes. During part B, the average scores were 0.55 ± 0.24 and 0.48 ± 0.26 , respectively, at average times for correctly solved questions of 2.56 ± 1.73 and 3.62 ± 2.12 minutes. When combining the survey parts A and B, the average scores were 0.56 ± 0.2 without visualization and 0.53 ± 0.2 with visualization, at 2.96 ± 2.22 and 5.24 ± 5.93 minutes.

In both survey parts, on the X gate, Z gate, separability, and gtg questions, group math-vis scored higher than group vis-math. In part A, this was 0.67 ± 0.2 to 0.45 ± 0.22 and in part B, with 0.62 ± 0.27 to 0.5 ± 0.3 . On the other hand, group vis-math scored higher than group math-vis on the H gate, measurement probability, entanglement, and CNOT gate questions 0.75 ± 0.17 to 0.46 ± 0.18 in part A and 0.6 ± 0.14 to 0.33 ± 0.12 in part B.

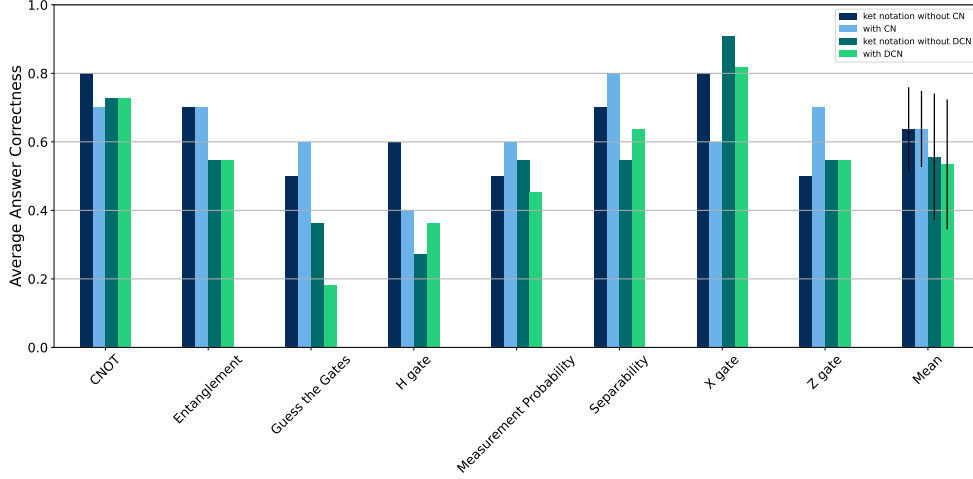

Fig. A3: Average score for each question in minutes in the two-qubit survey, separated by participants who were presented with CN (blue, N=10) and participants who were presented with DCN (green, N=11). Darker colors are for questions where participants were not presented with a visualization and lighter colors for questions where participants were presented with a visualization.

In survey part A, group math-vis took longer on the measurement probability, entanglement, CNOT gate, and gtg questions with 157 ± 22 to 117 ± 35 seconds and less time on the X gate, Z gate, H gate, and separability questions with 312 ± 186 to 131 ± 37 seconds. In survey part B, group math-vis took longer on the X gate, measurement probability, entanglement, and CNOT gate questions with 170 ± 83 to 90 ± 9 seconds and group vis-math took longer on the Z gate, H gate, and separability questions with 238 ± 95 to 210 ± 106 seconds.

Group math-vis had a higher score on the Z gate and separability questions with DCN with, on average, 0.75 ± 0.08 to 0.5 ± 0.0 while performing worse in this regard with DCN on the X gate, measurement probability, entanglement, CNOT, and gtg questions with 0.67 ± 0.18 to 0.43 ± 0.23 . The group took longer with DCN when correctly solving the X gate, Z gate, H gate, measurement probability, entanglement, and gtg questions with 255 ± 114 to 143 ± 38 seconds and took less time on the separability and CNOT questions with 146 ± 0 to 103 ± 3 seconds.

Supported by DCN, group vis-math scored higher on the H gate, entanglement, CNOT, and gtg questions with 0.65 ± 0.3 to 0.45 ± 0.3 while scoring worse on the Z gate and separability questions with 0.6 ± 0.0 to 0.4 ± 0.0 . On the X gate, Z gate, measurement probability, separability, and CNOT questions, group vis-math took longer with DCN, with 230 ± 184 to 124 ± 42 seconds, while taking longer without DCN on the H gate and entanglement questions with 227 ± 143 to 225 ± 142 seconds.

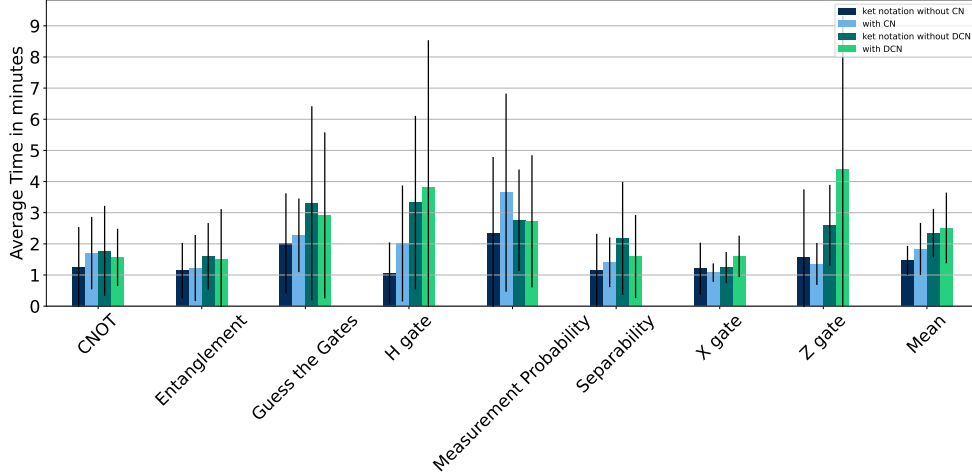

Fig. A4: Average time taken for each question in minutes in the two-qubit survey, separated by participants who were presented by CN (blue, $N=10$) and participants who were presented with DCN (green, $N=11$). Darker colors are for questions where participants were not presented with a visualization and lighter colors for questions where participants were presented with a visualization.

A.3 three-qubit survey

Table A5 lists the average scores and table A6 lists the average time taken for correctly solved one-qubit questions, with and without visualization, for surveys that were taken supported by CN and DCN. Figure A5 shows the combined average score per question and figure A6 shows the combined average time taken (for all answers, not just the correct ones). Cases in which a participant took more than 20 minutes for one question were excluded.

A.3.1 Circle Notation

During part A, participants assigned to the CN group solved questions without visualization with an average score of 0.58 ± 0.26 and an average time of 1.77 ± 0.94 minutes for correctly solved questions, while the same questions with visualization were answered with an average score of 0.76 ± 0.28 and an average time of 3.0 ± 1.63 minutes. During part B, the average scores were 0.67 ± 0.31 and 0.6 ± 0.25 , respectively, at average times for correctly solved questions of 2.43 ± 1.26 and 1.25 ± 0.45 minutes. When combining parts A and B of the survey, the average scores were 0.62 ± 0.28 without visualization and 0.68 ± 0.25 with visualization, at 2.38 ± 1.33 and 2.37 ± 1.51 minutes.

In survey part A, group math-vis, that was presented questions without CN first, scored higher than group vis-math on the entanglement question with 0.6 to 0.2. Group vis-math scored higher on the Z gate, the H gate, the measurement probability, the CNOT, and the gtg questions with 0.92 ± 0.1 to 0.52 ± 0.27 . In this survey part,

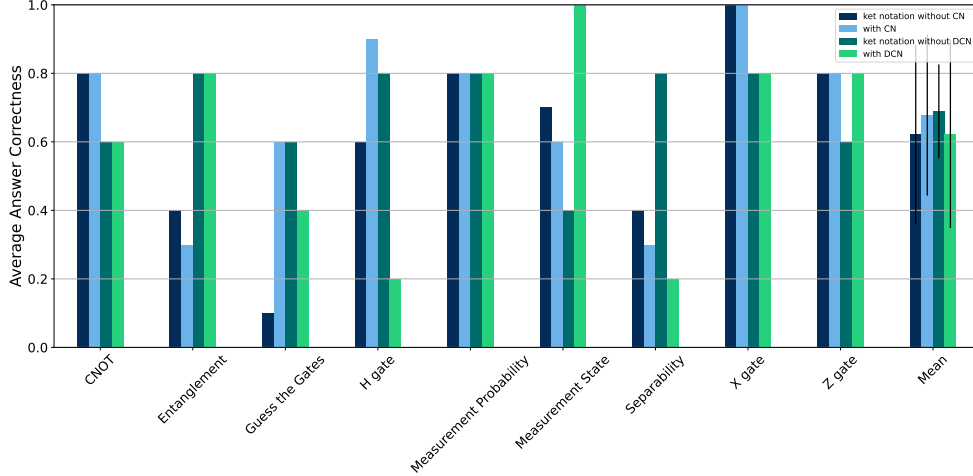

Fig. A5: Average score for each question in minutes in the three-qubit survey, separated by participants who were presented by CN (blue, N=10) and participants who were presented with DCN (green, N=5). Darker colors are for questions where participants were not presented with a visualization and lighter colors for questions where participants were presented with a visualization.

group math-vis took longer when solving the entanglement question correctly, with 152 to 126 seconds, while group vis-math took longer for correct solutions to the X gate, Z gate, H gate, measurement probability, measurement state, separability, and CNOT gate questions, with 183 ± 101 to 100 ± 53 seconds.

In survey part B, group math-vis scored higher on the H gate, entanglement, and gtg questions with 0.6 ± 0.28 to 0.33 ± 0.19 , while group vis-math scored higher on the Z gate, measurement probability, measurement state, separability, and CNOT gate questions with 0.8 ± 0.22 to 0.52 ± 0.16 . Group vis-math took longer on all questions in survey part B with 146 ± 71 to 75 ± 26 seconds.

Group math-vis, that was presented questions without CN first, scored higher on the H gate and gtg questions with 0.7 ± 0.3 to 0.3 ± 0.3 with CN. The group scored worse with CN on the separability, entanglement, and CNOT gate questions by a score difference of 0.6 ± 0.16 to 0.4 ± 0.16 . With CN. Participants in the group took longer when solving the X gate, Z gate and separability questions correctly, 70 ± 5 to 63 ± 6 seconds, while taking less time on the H gate, measurement probability, measurement state, entanglement, CNOT gate, and gtg questions with 132 ± 52 to 69 ± 27 seconds.

Group vis-math, that was presented questions with CN first, scored higher on the H gate, CNOT gate, and gtg questions with CN with 0.87 ± 0.09 to 0.53 ± 0.25 . The group scored lower with CN on the measurement state question with 0.8 to 0.6. When presented with CN, participants in the group took longer on the Z gate, H gate, measurement probability, measurement state, separability, and CNOT gate questions, with 198 ± 101 to 130 ± 49 seconds. They took less time on the X gate, entanglement, and gtg questions, with 178 ± 93 to 143 ± 53 seconds.

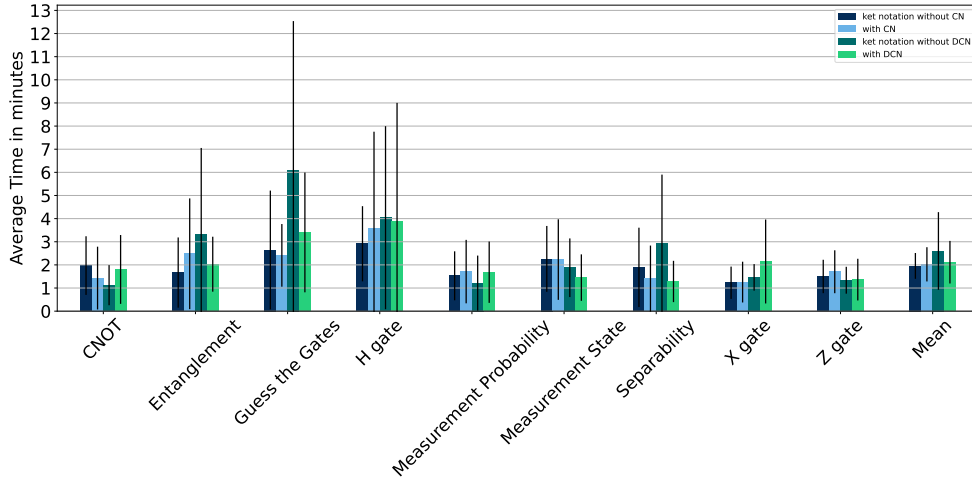

Fig. A6: Average time taken for each question in minutes in the three-qubit survey, separated by participants who were presented by CN (blue, $N=10$) and participants who were presented with DCN (green, $N=5$). Darker colors are for questions where participants were not presented with a visualization and lighter colors for questions where participants were presented with a visualization.

A.3.2 Dimensional Circle Notation

During part A, participants assigned to the DCN group solved questions without visualization with an average score of 0.89 ± 0.21 with an average time of 4.75 ± 1.77 minutes for correctly solved questions, while the same questions with visualization were answered with an average score of 0.6 ± 0.24 with an average time of 2.32 ± 0.63 minutes. During part B, the average scores were 0.56 ± 0.16 and 0.72 ± 0.34 , respectively, at average times for correctly solved questions of 2.0 ± 1.34 and 2.29 ± 1.33 minutes. When combining parts A and B of the survey, the average scores were 0.69 ± 0.15 without visualization and 0.62 ± 0.29 with visualization, at 3.03 ± 0.78 and 2.44 ± 0.9 minutes.

Group math-vis, that was assigned questions without DCN first, scored higher than group vis-math on the X gate, Z gate, H gate, measurement probability, separability, entanglement, CNOT, and gtg questions in survey part A, with 0.94 ± 0.17 to 0.5 ± 0.24 . The inverse is apparent for the measurement state question, where group vis-math scored higher than group math-vis with 1 to 0.5. Group vis-math, with DCN, took longer to correctly solve the Z gate, measurement probability, separability, entanglement, and gtg questions, with 371 ± 353 to 154 ± 143 seconds, whereas group math-vis took longer for correctly solving the X gate, measurement state, and CNOT gate questions, 115 ± 52 to 76 ± 25 seconds.

In survey part B, group math-vis (that now was presented questions with DCN) scored higher than group vis-math on the X gate, Z gate, measurement probability, measurement state, entanglement, and CNOT gate questions with 0.92 ± 0.19 to

0.5±0.17 and group vis-math scored higher than group math-vis on the H gate, separability, and gtg questions with 0.67±0.0 to 0.33±0.24. In this survey part, group math-vis, with DCN, took longer on the X gate, measurement probability, measurement state, entanglement, and CNOT gate questions, with 163±57 to 103±43 seconds, while taking less time on the Z gate, H gate, and gtg questions, with 118±10 to 94±14 seconds.

Comparing within each group, group math-vis scored higher with DCN on the measurement state question with 1 to 0.5, and scored lower with DCN than without DCN on the H gate, Separability, and CNOT gate questions by averages of 1.0±0.0 to 0.33±0.24. When solving questions correctly, group math-vis took longer on the X gate, Z gate, measurement state, and CNOT gate questions when presented with DCN, with 155±67 to 75±21 seconds, while taking less time on the H gate, measurement probability, Entanglement, and gtg questions, 511±333 to 119±35 seconds.

When presented with DCN, group vis-math scored higher than itself on the Z gate, measurement state, and CNOT gate questions by, on average, 0.78±0.16 to 0.33±0.0. The group scored higher when solving questions without DCN on the H gate, Separability, and gtg questions with 0.67±0.0 to 0.22±0.16. They took longer with DCN when solving the X gate, measurement probability, and gtg questions correctly, 230±154 to 84±41 seconds, and took less time on the Z gate, measurement state, separability, entanglement, and CNOT gate questions when presented with DCN, on average 144±38 to 85±20 seconds.

Appendix B Data processing

During this study, some technical issues arose due to a short termed set up of the surveys: On the first day of the study, 12 May 2024, we noticed that answer IDs were saved randomly, could not scrape the data, and therefore lost data of seven participants of the one-qubit survey. In addition, we had to remove one guess-the-gates question from the analysis of the results of the second survey because it was incorrectly incorporated into the survey, so the participants got exactly the same question without DCN and with DCN in survey part A and B. In addition, we had to remove the two-qubit question that asked for the state after a measurement due to an error in the answer. Also, we had some cases where participants randomly jumped within the survey, especially during survey 1, due to server issues that we fixed later. This led to some questions being answered twice by the same person. We corrected for all of this in the data.

Table A2: Average time taken for correct answers to one-qubit questions, with and without visualization in minutes ($N=17$).

survey part	A		B		combined	
	w/o vis. ¹	with vis. ²	w/o vis. ²	with vis. ¹	w/o vis. ³	with vis. ³
global phase	1.28±0.63(6)	1.48±1.57(5)	2.94±2.99(6)	2.95±2.2(10)	1.63±1.08(10)	2.26±2.27(10)
X gate	4.31±2.61(5)	1.52±0.92(3)	-	-	-	-
Z gate	-	-	3.69±5.56(5)	5.43±4.11(7)	-	-
phase gate	1.65±2.49(8)	1.01±0.44(7)	1.19±1.05(9)	0.87±0.42(7)	1.47±1.99(11)	0.93±0.46(11)
H gate	2.93±2.9(7)	0.68±0.41(6)	1.78±2.74(6)	1.5±0.83(7)	2.13±2.59(10)	0.84±0.4(10)
measurement probability	1.23±1.0(6)	1.33(1)	0.86±0.59(4)	0.81±0.58(6)	1.13±0.96(6)	0.91±0.61(6)
measurement state	1.14±1.39(9)	0.55±0.24(7)	0.38±0.17(6)	0.54±0.68(9)	0.83±1.14(14)	0.55±0.55(14)
Mean	2.09±1.27	1.09±0.41	1.81±1.28	2.01±1.88	1.44±0.49	1.1±0.67

Note: The number of participants N that solved the question correctly and are therefore included in the average is shown in brackets. Standard deviations are shown where $N > 1$. The confidence interval of the mean is the mean of the standard deviations.

¹ $N = 9$

² $N = 8$

³ $N = 17$

⁴Confidence intervals are the average of the standard deviations.

Table A3: Average scores for two-qubit questions, with and without visualization (N=21).

Circle Notation¹						
survey part	A		B		combined	
question	w/o vis. ²	with vis. ²	w/o vis. ²	with vis. ²	w/o vis. ¹	with vis. ¹
X gate	1.0	0.4	0.6	0.8	0.8	0.6
Z gate	0.6	0.6	0.4	0.8	0.5	0.7
H gate	0.8	0.2	0.4	0.6	0.6	0.4
measurement probability	0.6	0.6	0.4	0.6	0.5	0.6
Separability	0.6	1.0	0.8	0.6	0.7	0.8
Entanglement	0.8	1.0	0.6	0.4	0.7	0.7
CNOT gate	0.8	0.8	0.8	0.6	0.8	0.7
gtg	0.6	0.6	0.4	0.6	0.5	0.6
Mean	0.72±0.14	0.65±0.26	0.55±0.17	0.62±0.12	0.64±0.13	0.64±0.12

Dimensional Circle Notation¹						
survey part	A		B		combined	
question	w/o vis. ³	with vis. ²	w/o vis. ²	with vis. ³	w/o vis. ⁴	with vis. ⁴
X gate	1.0	0.8	0.8	0.83	0.91	0.82
Z gate	0.5	0.4	0.6	0.67	0.55	0.55
H gate	0.17	0.6	0.4	0.17	0.27	0.36
measurement probability	0.5	0.6	0.6	0.33	0.55	0.45
Separability	0.5	0.4	0.6	0.83	0.55	0.64
Entanglement	0.5	0.8	0.6	0.33	0.55	0.55
CNOT gate	0.67	1.0	0.8	0.5	0.73	0.73
gtg	0.67	0.2	0.0	0.17	0.36	0.18
Mean	0.56±0.22	0.6±0.24	0.55±0.24	0.48±0.26	0.56±0.2	0.53±0.2

questions are shown in order of appearance in the study.

¹N = 10

²N = 5

³N = 6

⁴N = 11

Table A4: Average time taken for correct answers to two-qubit questions in minutes ($N = 22$).

survey part	Circle Notation ¹					
	A		B		combined	
question	w/o vis. ²	with vis. ³	w/o vis. ³	with vis. ²	w/o vis. ¹	with vis. ¹
X gate	0.71±0.16(5)	1.34±0.06(2)	2.05±1.06(3)	0.8±0.35(5)	0.95±0.39(6)	1.08±0.23(6)
Z gate	1.11±0.24(3)	1.51±0.21(3)	0.68±0.08(2)	0.98±0.7(5)	1.02±0.26(4)	1.35±0.53(4)
H gate	0.93±0.96(5)	2.18(1)	2.28±0.83(2)	2.2±0.64(3)	1.15±0.96(3)	2.2±0.64(3)
measurement probability	2.38±0.33(3)	4.58±2.83(3)	1.38±0.34(2)	4.12±4.42(3)	2.0±0.67(4)	4.39±3.42(4)
Separability	1.78±1.34(3)	1.87±0.61(5)	0.95±0.94(4)	0.84±0.25(3)	1.3±1.2(7)	1.38±0.7(7)
Entanglement	1.47±0.39(4)	1.73±1.21(5)	1.09±0.33(3)	1.24±0.12(2)	1.36±0.43(5)	1.86±1.13(5)
CNOT gate	1.59±1.77(5)	2.14±1.31(4)	0.92±0.57(4)	2.08±0.77(3)	1.65±1.41(7)	2.11±1.11(7)
g†g	2.34±2.01(3)	2.08±0.61(3)	2.34±2.29(2)	1.17±1.04(3)	2.41±2.37(4)	1.48±0.91(4)
Mean	1.54±0.62	2.18±1.02	1.46±0.67	1.68±1.12	1.48±0.51	1.98±1.05

survey part	Dimensional Circle Notation ¹					
	A		B		combined	
question	w/o vis. ²	with vis. ³	w/o vis. ³	with vis. ²	w/o vis. ¹	with vis. ¹
X gate	1.13±0.38(6)	1.77±0.67(4)	1.35±0.65(4)	1.7±0.66(5)	1.29±0.49(9)	1.73±0.67(9)
Z gate	2.42±1.12(3)	9.83±7.95(2)	3.25±0.98(3)	2.95±2.69(4)	3.0±0.93(3)	8.84±6.83(3)
H gate	2.73(1)	6.12±7.98(3)	6.17±1.65(2)	5.88(1)	7.82(1)	17.4(1)
measurement probability	3.22±1.7(3)	2.91±1.62(3)	1.71±0.26(3)	5.13±3.27(2)	1.86±0.34(4)	2.65±1.48(4)
Separability	2.43±1.85(3)	3.08±1.99(2)	2.48±2.22(3)	1.68±0.9(5)	2.83±2.03(5)	2.14±1.51(5)
Entanglement	2.27±0.49(3)	1.39±1.4(4)	1.41±0.95(3)	2.77±2.48(2)	1.81±0.95(5)	2.09±2.04(5)
CNOT gate	2.45±1.94(4)	1.57±1.0(5)	1.56±0.87(4)	1.77±0.75(3)	2.1±1.65(7)	1.83±0.83(7)
g†g	2.53±0.68(4)	1.9(1)	(0)	7.07(1)	(0)	(0)
Mean	2.4±0.59	3.57±2.96	2.56±1.73	3.62±2.12	2.96±2.22	5.24±5.93

Note: The number of participants N that solved the question correctly and are therefore included in the average is shown in brackets. Standard deviations are shown where $N > 1$. The confidence interval of the mean is the mean of the standard deviations.

¹ $N = 11$

² $N = 6$

³ $N = 5$

Table A5: Average scores for three-qubit questions, with and without visualization (N=15).

Circle Notation ¹						
survey part	A		B		combined	
question	w/o vis. ²	with vis. ²	w/o vis. ²	with vis. ²	w/o vis. ¹	with vis. ¹
X gate	1.0	1.0	1.0	1.0	1.0	1.0
Z gate	0.6	1.0	1.0	0.6	0.8	0.8
H gate	0.6	0.8	0.6	1.0	0.6	0.9
measurement probability	0.6	1.0	1.0	0.6	0.8	0.8
measurement state	0.6	0.6	0.8	0.6	0.7	0.6
Separability	0.4	0.4	0.4	0.2	0.4	0.3
Entanglement	0.6	0.2	0.2	0.4	0.4	0.3
CNOT gate	0.8	1.0	0.8	0.6	0.8	0.8
gtg	0.0	0.8	0.2	0.4	0.1	0.6
Mean	0.58±0.26	0.76±0.28	0.67±0.31	0.6±0.25	0.62±0.28	0.68±0.25

Dimensional Circle Notation ²						
survey part	A		B		combined	
question	w/o vis. ³	with vis. ⁴	w/o vis. ⁴	with vis. ³	w/o vis. ²	with vis. ²
X gate	1.0	0.67	0.67	1.0	0.8	0.8
Z gate	1.0	0.67	0.33	1.0	0.6	0.8
H gate	1.0	0.0	0.67	0.5	0.8	0.2
measurement probability	1.0	0.67	0.67	1.0	0.8	0.8
measurement state	0.5	1.0	0.33	1.0	0.4	1.0
Separability	1.0	0.33	0.67	0.0	0.8	0.2
Entanglement	1.0	0.67	0.67	1.0	0.8	0.8
CNOT gate	1.0	0.67	0.33	0.5	0.6	0.6
gtg	0.5	0.33	0.67	0.5	0.6	0.4
Mean	0.89±0.21	0.56±0.27	0.56±0.16	0.72±0.34	0.69±0.15	0.62±0.29

Standard deviations are shown, where $N > 1$.

¹N = 10

²N = 5

³N = 2

⁴N = 3

Table A6: Average time taken for correct answers to three-qubit questions in minutes (N=15).

survey part	Circle Notation ¹					
	A		B			
question	w/o vis. ²	with vis. ²	w/o vis. ¹	with vis. ¹		
X gate	0.94±0.36(5)	1.46±1.16(5)	1.52±0.82(5)	1.05±0.34(5)	1.23±0.7(10)	1.26±0.88(10)
Z gate	1.03±0.04(3)	2.02±1.18(5)	1.53±0.87(5)	1.17±0.29(3)	1.35±0.73(8)	1.7±1.04(8)
H gate	3.72±1.74(3)	6.82±5.99(4)	3.64±1.59(3)	1.85±0.53(5)	3.68±1.67(6)	4.79±5.26(6)
measurement probability	1.42±0.66(3)	2.7±1.17(5)	1.27±0.87(5)	0.44±0.2(3)	1.32±0.8(8)	1.85±1.43(8)
Separability	1.92±0.1(3)	3.53±1.2(3)	2.75±1.71(4)	1.28±0.44(3)	2.14±1.31(6)	2.41±1.44(6)
Entanglement	1.19±0.36(2)	3.1±1.92(2)	2.18±0.28(2)	1.27(1)	2.01±0.46(2)	1.23±0.04(2)
CNOT gate	2.53±2.24(3)	2.1(1)	2.27(1)	1.16±0.14(2)	3.07±1.89(3)	1.47±0.46(3)
g†g	1.41±0.46(4)	1.68±1.72(5)	1.6±0.94(4)	1.06±0.04(3)	1.53±0.8(7)	1.48±1.49(7)
Mean	(0)	3.59±1.35(4)	5.13(1)	1.98±0.42(2)	5.13(1)	5.13(1)
	1.77±0.94	3.0±1.63	2.43±1.26	1.25±0.45	2.38±1.33	2.37±1.51
Dimensional Circle Notation ²						
X gate	1.83±0.42(2)	3.11±2.38(2)	1.49±0.43(2)	1.94±0.69(2)	1.66±0.45(4)	2.52±1.84(4)
Z gate	1.23±0.55(2)	0.97±0.1(2)	1.95(1)	1.88±1.25(2)	1.47±0.56(3)	1.61±1.09(3)
H gate	8.02±3.47(2)	(0)	1.79±0.51(2)	1.32(1)	4.55(1)	1.32(1)
measurement probability	2.43±1.0(2)	1.12±0.04(2)	0.52±0.09(2)	2.35±1.9(2)	1.48±1.19(4)	1.74±1.48(4)
Separability	1.05(1)	1.08±0.2(3)	1.77(1)	2.0±1.4(2)	1.41±0.36(2)	0.83±0.23(2)
Entanglement	3.66±2.66(2)	1.57(1)	3.51±3.28(2)	(0)	6.78(1)	1.57(1)
CNOT gate	6.12±4.09(2)	1.88±0.52(2)	2.1±1.93(2)	2.76±1.43(2)	4.11±3.78(4)	2.32±1.16(4)
g†g	0.89±0.18(2)	1.55±0.62(2)	2.68(1)	4.52(1)	1.88±0.81(2)	2.72±1.79(2)
Mean	17.48(1)	7.28(1)	2.18±1.78(2)	1.52(1)	3.97(1)	7.28(1)
	4.75±5.37	2.32±2.12	2.0±0.82	2.29±1.01	3.03±1.91	2.44±1.92

Note: The number of participants N that solved the question correctly and are therefore included in the average is shown in brackets. Standard deviations are shown where N > 1. The confidence interval of the mean is the mean of the standard deviations.

¹N = 10

²N = 5

³N = 2

⁴N = 3

References

- [1] Meyer, J.C., Passante, G., Pollock, S.J., Wilcox, B.R.: Today's interdisciplinary quantum information classroom: Themes from a survey of quantum information science instructors. *Phys. Rev. Phys. Educ. Res.* **18**, 010150 (2022) <https://doi.org/10.1103/PhysRevPhysEducRes.18.010150>
- [2] Goorney, S., Bley, J., Heusler, S., Sherson, J.: *A Framework for Curriculum Transformation in Quantum Information Science and Technology Education* (2023)
- [3] Gilbert, J.K. (ed.): *Visualization in Science Education*. Springer, Dordrecht (2005). <https://doi.org/10.1007/1-4020-3613-2> . <http://link.springer.com/10.1007/1-4020-3613-2> Accessed 2024-02-15
- [4] Evagorou, M., Erduran, S., Mäntylä, T.: The role of visual representations in scientific practices: from conceptual understanding and knowledge generation to 'seeing' how science works. *International Journal of STEM Education* **2**(11) (2015) <https://doi.org/10.1186/s40594-015-0024-x>
- [5] Kim, M., Jin, Q.: Studies on visualisation in science classrooms: a systematic literature review. *International Journal of Science Education* **44**(17), 2613–2631 (2022) <https://doi.org/10.1080/09500693.2022.2140020> <https://doi.org/10.1080/09500693.2022.2140020>
- [6] Rau, M.A.: Conditions for the effectiveness of multiple visual representations in enhancing stem learning. *Educational Psychology Review* **29**, 717–761 (2017)
- [7] Opfermann, M., Schmeck, A., Fischer, H.E.: Multiple representations in physics and science education—why should we use them? *Multiple representations in physics education*, 1–22 (2017)
- [8] Munfaridah, N., Avraamidou, L., Goedhart, M.: The use of multiple representations in undergraduate physics education: what do we know and where do we go from here? *Eurasia Journal of Mathematics, Science and Technology Education* **17**(1), 1934 (2021)
- [9] Allen, E.C.: *Picture This: The Value of Multiple Visual Representations for Student Learning of Quantum Concepts in General Chemistry*. ProQuest, Ann Arbor, MI, US (2015)
- [10] Liu, J., Franklin, D.: Introduction to quantum computing for everyone: Experience report. In: *Proceedings of the 54th ACM Technical Symposium on Computer Science Education V. 1. SIGCSE 2023*, pp. 1157–1163. Association for Computing Machinery, New York, NY, USA (2023). <https://doi.org/10.1145/3545945.3569836> . <https://doi.org/10.1145/3545945.3569836>

- [11] Ainsworth, S.: Deft: A conceptual framework for considering learning with multiple representations. *Learning and instruction* **16**(3), 183–198 (2006)
- [12] Mayer, R.E.: In: Mayer, R.E.E. (ed.) *Cognitive Theory of Multimedia Learning*. Cambridge Handbooks in Psychology, pp. 43–71. Cambridge University Press, Cambridge, England (2014)
- [13] Bengtsson, I., Życzkowski, K.: *Geometry of Quantum States: An Introduction to Quantum Entanglement*. Cambridge University Press, Cambridge, England (2006). <https://doi.org/10.1017/CBO9780511535048>
- [14] Watrous, J.: *The Theory of Quantum Information*. Cambridge University Press, Cambridge, England (2018)
- [15] Brody, D.C., Hughston, L.P.: Geometric quantum mechanics. *Journal of Geometry and Physics* **38**(1), 19–53 (2001) [https://doi.org/10.1016/S0393-0440\(00\)00052-8](https://doi.org/10.1016/S0393-0440(00)00052-8)
- [16] Vollbrecht, K.G.H., Werner, R.F.: Entanglement measures under symmetry. *Phys. Rev. A* **64**, 062307 (2001) <https://doi.org/10.1103/PhysRevA.64.062307>
- [17] Heusler, S., Schlummer, P., Ubben, M.S.: The topological origin of quantum randomness. *Symmetry* **13**(4) (2021) <https://doi.org/10.3390/sym13040581>
- [18] Hu, P., Li, Y., Mong, R.S.K., Singh, C.: Student understanding of the bloch sphere. *European Journal of Physics* **45**(2), 025705 (2024) <https://doi.org/10.1088/1361-6404/ad2393>
- [19] Mäkelä, H., Messina, A.: N-qubit states as points on the bloch sphere. *Physica Scripta* **2010**(T140), 014054 (2010) <https://doi.org/10.1088/0031-8949/2010/T140/014054>
- [20] Boyer, M., Liss, R., Mor, T.: Geometry of entanglement in the bloch sphere. *Phys. Rev. A* **95**, 032308 (2017) <https://doi.org/10.1103/PhysRevA.95.032308>
- [21] Gamel, O.: Entangled bloch spheres: Bloch matrix and two-qubit state space. *Phys. Rev. A* **93**, 062320 (2016) <https://doi.org/10.1103/PhysRevA.93.062320>
- [22] Kemp, C.J.D., Cooper, N.R., Ünal, F.N.: Nested-sphere description of the n -level chern number and the generalized bloch hypersphere. *Phys. Rev. Res.* **4**, 023120 (2022) <https://doi.org/10.1103/PhysRevResearch.4.023120>
- [23] Backens, M.: The ZX-calculus is complete for stabilizer quantum mechanics. *New Journal of Physics* **16**(9), 093021 (2014) <https://doi.org/10.1088/1367-2630/16/9/093021>
- [24] Hadzihasanovic, A.: A diagrammatic axiomatisation for qubit entanglement. In: 2015 30th Annual ACM/IEEE Symposium on Logic in Computer Science, pp.

- 573–584 (2015). <https://doi.org/10.1109/LICS.2015.59>
- [25] Ng, K.F., Wang, Q.: A universal completion of the ZX-calculus (2017)
- [26] Backens, M., Kissinger, A.: ZH: A complete graphical calculus for quantum computations involving classical non-linearity. *Electronic Proceedings in Theoretical Computer Science* **287**, 23–42 (2019) <https://doi.org/10.4204/eptcs.287.2>
- [27] Coecke, B., Horsman, D., Kissinger, A., Wang, Q.: Kindergarden quantum mechanics graduates ...or how i learned to stop gluing lego together and love the zx-calculus. *Theoretical Computer Science* **897**, 1–22 (2022) <https://doi.org/10.1016/j.tcs.2021.07.024>
- [28] Bombin, H., Martin-Delgado, M.A.: Topological quantum distillation. *Phys. Rev. Lett.* **97**, 180501 (2006) <https://doi.org/10.1103/PhysRevLett.97.180501>
- [29] Kubica, A., Yoshida, B., Pastawski, F.: Unfolding the color code. *New Journal of Physics* **17**(8), 083026 (2015) <https://doi.org/10.1088/1367-2630/17/8/083026>
- [30] Aadel, Y., Belhaj, A., Bensed, M., Benslimane, Z., Sedra, M.B., Segui, A.: Qubit Systems from Colored Toric Geometry and Hypercube Graph Theory*. *Communications in Theoretical Physics* **68**(3), 285 (2017) <https://doi.org/10.1088/0253-6102/68/3/285>
- [31] Vasmer, M., Kubica, A.: Morphing quantum codes. *PRX Quantum* **3**(3) (2022) <https://doi.org/10.1103/prxquantum.3.030319>
- [32] Garon, A., Zeier, R., Glaser, S.J.: Visualizing operators of coupled spin systems. *Phys. Rev. A* **91**, 042122 (2015) <https://doi.org/10.1103/PhysRevA.91.042122>
- [33] Leiner, D., Zeier, R., Glaser, S.J.: Symmetry-adapted decomposition of tensor operators and the visualization of coupled spin systems. *Journal of Physics A: Mathematical and Theoretical* **53**(49), 495301 (2020) <https://doi.org/10.1088/1751-8121/ab93ff>
- [34] Koczor, B., Zeier, R., Glaser, S.J.: Time evolution of coupled spin systems in a generalized wigner representation. *Annals of Physics* **408**, 1–50 (2019) <https://doi.org/10.1016/j.aop.2018.11.020>
- [35] Nielsen, M.A., Chuang, I.L.: *Quantum Computation and Quantum Information: 10th Anniversary Edition*. Cambridge University Press, Cambridge, England (2010)
- [36] Johnston, E.R., Harrigan, N., Gimeno-Segovia, M.: *Programming Quantum Computers: Essential Algorithms and Code Samples*. O’Reilly Media, Incorporated, Sebastopol, California, US (2019)
- [37] Just, B.: *Quantum Computing Compact*, 2nd edn. Springer, Berlin, Germany

(2023). First edition released in 2020 in German

- [38] Bley, J., Rexigel, E., Arias, A., Longen, N., Krupp, L., Kiefer-Emmanouilidis, M., Lukowicz, P., Donhauser, A., Küchemann, S., Kuhn, J., Widera, A.: Visualizing entanglement in multiqubit systems. *Phys. Rev. Res.* **6**, 023077 (2024) <https://doi.org/10.1103/PhysRevResearch.6.023077>
- [39] JORRAND, P., MHALLA, M.: Separability of pure n-qubit states: Two characterizations. *International Journal of Foundations of Computer Science* **14**(05), 797–814 (2003) <https://doi.org/10.1142/S0129054103002035>
- [40] Ainsworth, S.: In: Mayer, R.E., Fiorella, L. (eds.) *The Multiple Representations Principle in Multimedia Learning*. Cambridge Handbooks in Psychology, pp. 158–170. Cambridge University Press, Cambridge, England (2021)
- [41] Hu, L., Chen, G., Li, P., Huang, J.: Multimedia effect in problem solving: A meta-analysis. *Educational Psychology Review* **33**(4), 1717–1747 (2021) <https://doi.org/10.1007/s10648-021-09610-z>
- [42] Schnotz, W.: In: Mayer, R. (ed.) *An Integrated Model of Text and Picture Comprehension*. Cambridge Handbooks in Psychology, pp. 49–70. Cambridge University Press, Cambridge, England (2005)
- [43] Mayer, R.E.: In: Mayer, R.E., Fiorella, L. (eds.) *Cognitive Theory of Multimedia Learning*. Cambridge Handbooks in Psychology, pp. 57–72. Cambridge University Press, Cambridge, England (2021)
- [44] Cooper, J.L., Sidney, P.G., Alibali, M.W.: Who benefits from diagrams and illustrations in math problems? ability and attitudes matter. *Applied Cognitive Psychology* **32**(1), 24–38 (2018)
- [45] Fredlund, T., Linder, C., Airey, J., Linder, A.: Unpacking physics representations: Towards an appreciation of disciplinary affordance. *Physical Review Special Topics-Physics Education Research* **10**(2), 020129 (2014)
- [46] Sweller, J., Merrienboer, J.J.G., Paas, F.G.W.C.: Cognitive architecture and instructional design. *Educational Psychology Review* **10**(3), 251–296 (1998) <https://doi.org/10.1023/A:1022193728205>
- [47] Sweller, J.: Cognitive load during problem solving: Effects on learning. *Cognitive Science* **12**(2), 257–285 (1988) [https://doi.org/10.1016/0364-0213\(88\)90023-7](https://doi.org/10.1016/0364-0213(88)90023-7)
- [48] Sweller, J.: Element interactivity and intrinsic, extraneous, and germane cognitive load. *Educational Psychology Review* **22**(2), 123–138 (2010) <https://doi.org/10.1007/s10648-010-9128-5>

- [49] Slava Kalyuga, P.C. Paul Ayres, Sweller, J.: The expertise reversal effect. *Educational Psychologist* **38**(1), 23–31 (2003) https://doi.org/10.1207/S15326985EP3801_4
- [50] Yeh, Y.-c.: In: Seel, N.M. (ed.) *Aptitude-Treatment Interaction*, pp. 295–298. Springer, Boston, MA (2012). https://doi.org/10.1007/978-1-4419-1428-6_582 . https://doi.org/10.1007/978-1-4419-1428-6_582
- [51] Thissen, D.: 9 - timed testing: An approach using item response theory. In: Weiss, D.J. (ed.) *New Horizons in Testing*, pp. 179–203. Academic Press, San Diego (1983). <https://doi.org/10.1016/B978-0-12-742780-5.50019-6> . <https://www.sciencedirect.com/science/article/pii/B9780127427805500196>
- [52] Ferrando, P.J., Lorenzo-Seva, U.: An item response theory model for incorporating response time data in binary personality items. *Applied Psychological Measurement* **31**(6), 525–543 (2007)
- [53] Goldhammer, F., Naumann, J., Stelter, A., Tóth, K., Rölke, H., Klieme, E.: The time on task effect in reading and problem solving is moderated by task difficulty and skill: Insights from a computer-based large-scale assessment. *Journal of Educational Psychology* **106**(3), 608–626 (2014) <https://doi.org/10.1037/a0034716>
- [54] Tancoš, M., Chvojka, E., Jabøurek, M., Portešová, Š.: Faster smarter: Children with higher levels of ability take longer to give incorrect answers, especially when the task matches their ability. *Journal of Intelligence* **11**(4) (2023) <https://doi.org/10.3390/jintelligence11040063>
- [55] Klepsch, M., Schmitz, F., Seufert, T.: Development and validation of two instruments measuring intrinsic, extraneous, and germane cognitive load. *Frontiers in Psychology* **8**, 1997 (2017) <https://doi.org/10.3389/fpsyg.2017.01997>
- [56] DeLeeuw, K.E., Mayer, R.E.: A comparison of three measures of cognitive load: Evidence for separable measures of intrinsic, extraneous, and germane load. *Journal of Educational Psychology* **100**(1), 223–234 (2008) <https://doi.org/10.1037/0022-0663.100.1.223>
- [57] Chandler, P., Sweller, J.: The split-attention effect as a factor in the design of instruction. *British Journal of Educational Psychology* **62**(2), 233–246 (1992)
- [58] Hahn, L., Klein, P.: Eye tracking in physics education research: A systematic literature review. *Phys. Rev. Phys. Educ. Res.* **18**, 013102 (2022) <https://doi.org/10.1103/PhysRevPhysEducRes.18.013102>
- [59] Merriënboer, J.J.G., Sweller, J.: Cognitive load theory and complex learning: Recent developments and future directions. *Educational Psychology Review* **17**(2), 147–177 (2005) <https://doi.org/10.1007/s10648-005-3951-0>

- [60] Gerjets, P., Scheiter, K., Cierniak, G.: The scientific value of cognitive load theory: A research agenda based on the structuralist view of theories. *Educational Psychology Review* **21**, 43–54 (2009) <https://doi.org/10.1007/s10648-008-9096-1>
- [61] Seskir, Z.C., Migdał, P., Weidner, C., Anupam, A., Case, N., Davis, N., Decaroli, C., Ercan, I., Foti, C., Gora, P., Jankiewicz, K., La Cour, B.R., Yago Malo, J., Maniscalco, S., Naeemi, A., Nita, L., Parvin, N., Scafirimuto, F., Sherson, J.F., Surer, E., Wootton, J., Yeh, L., Zabello, O., Chiofalo, M.: Quantum games and interactive tools for quantum technologies outreach and education. *Optical Engineering* **61**(08) (2022) <https://doi.org/10.1117/1.oe.61.8.081809>