

The Qudit ZH Calculus for Arbitrary Finite Fields: Universality and Application

Dichuan (David) Gao

Department of Computer Science
University of Oxford
Oxford, UK

dichuan.gao@maths.ox.ac.uk

We propose a generalization of the graphical ZH calculus to qudits of prime-power dimensions $q = p^f$, implementing field arithmetic in arbitrary finite fields. This is an extension of a previous result [17] which implemented arithmetic of prime-sized fields; and an alternative to a result in [3] which extended the ZH to implement cyclic ring arithmetic in $\mathbb{Z}/q\mathbb{Z}$ rather than field arithmetic in \mathbb{F}_q . We show this generalized ZH calculus to be universal over matrices $\mathbb{C}^{q^n} \rightarrow \mathbb{C}^{q^m}$ with entries in the ring $\mathbb{Z}[\omega]$ where ω is a p th root of unity. As an illustration of the necessity of such an extension of ZH for field rather than cyclic ring arithmetic, we offer a graphical description and proof for a quantum algorithm for polynomial interpolation. This algorithm relies on the invertibility of multiplication, and therefore can only be described in a graphical language that implements field, rather than ring, multiplication.

1 Introduction

The ZH calculus is one of three popular graphical calculi for reasoning about quantum computation; the other two being the ZX and the ZW calculi [6]. Each of these three calculi are useful for different types of reasoning: the ZX calculus represents the Clifford+Phase gateset most naturally [9, 8, 10, 22]; the ZW calculus is able to represent sums of linear maps naturally with its W gate [21, 19, 14] and helps us to reason about photonic and fermionic computations [11, 12, 20]; and the ZH calculus yields the Toffoli+Hadamard gateset in a much simpler way than the other two [1, 2, 17].

At its core, the ZH calculus is able to represent the Toffoli gate elegantly because one of its primitive generators, the H-box, implements the multiplication operation “ \cdot ” on the computational basis (otherwise called the AND gate in the qubit case). This then makes it easy to obtain the Toffoli gate

$$T = \sum_{x,y,z \in \mathbb{F}_2} |x,y,z \oplus (x \cdot y)\rangle \langle x,y,z|$$

in a diagrammatic form.

For qubits, the ZH calculus has been shown to be universal [1]; and an elegant set of rewrite rules in the ZH calculus has been proven complete [2]. The universality result has in turn been generalized to qudits of prime dimension p by Roy et.al. [17]. In qudits of prime dimension, owing to the existence of a ring isomorphism $\mathbb{F}_p \cong \mathbb{Z}/p\mathbb{Z}$, the above-mentioned AND gate naturally generalizes to the field multiplication in \mathbb{F}_p . The resulting graphical calculus remains universal, although no completeness result has been given.

This qudit ZH calculus was further generalized by de Beaudrap and East to arbitrary dimensions d . [3]. In their generalization, the generalized AND gate becomes ring multiplication in $\mathbb{Z}/d\mathbb{Z}$. But of course, for arbitrary finite fields \mathbb{F}_q where q is not prime, we have $\mathbb{F}_q \not\cong \mathbb{Z}/q\mathbb{Z}$ as rings. Thus, the

generalized ZH calculus by de Beaudrap and East would not naturally implement field multiplication in these non-prime finite fields. This is why we present an alternative generalization of the qudit ZH calculus - one which implements the field multiplication of \mathbb{F}_q , rather than the ring multiplication of $\mathbb{Z}/q\mathbb{Z}$. The price of faithfully representing field multiplication of arbitrary finite fields, however, is that in non-prime dimensions we lose flexsymmetry of the H-box [1]. However, as we shall see in sections 2.3 and 4, this loss of flexsymmetry is only up to a dualizer, which corresponds to an algebraic operation, which turns out to be useful.

In section 2 we construct the finite field ZH calculus from its basic generators, and give some simple results characterizing this calculus. We then prove, in section 3, the universality of this calculus over matrices of $\mathbb{Z}[\omega]$ where ω is a p th root of unity. Finally in section 4 we demonstrate the usefulness of a finite field ZH calculus by diagrammatically proving the correctness of a quantum polynomial interpolation algorithm, which relies on the invertibility of multiplication in the computational basis - that is, the fact that it is a field.

2 The ZH Calculus for Arbitrary Finite Fields

2.1 Algebraic Background

It is well known that if p is a prime number, and $q = p^t$ for some $t \in \mathbb{N}$, then there exists a field \mathbb{F}_q of cardinality q and character p , namely the splitting field of the polynomial $g(x) = x^q - x$ over the prime field \mathbb{F}_p . Every finite field is of this form [15]. Since splitting fields are unique up to isomorphism, we simply speak of \mathbb{F}_q as *the* finite field of size q .

When $t = 1$, we have $\mathbb{F}_q = \mathbb{F}_p \cong \mathbb{Z}/p\mathbb{Z}$. But when $t \neq 1$, the field \mathbb{F}_q is not cyclic, meaning $\mathbb{F}_q \not\cong \mathbb{Z}/q\mathbb{Z}$ as rings. There is then no group embedding $\mathbb{F}_q \hookrightarrow S^1$ where S^1 is the multiplicative group of the unit circle in the complex plane. This is a problem for the construction of a ZH calculus: one wants to define the H gate as the map

$$n \text{ : } \begin{array}{c} \diagup \\ \diagdown \end{array} \begin{array}{c} \diagdown \\ \diagup \end{array} \text{ : } m \stackrel{?}{=} \frac{1}{\sqrt{q}} \sum_{\substack{j_1, \dots, j_m \in \mathbb{F}_q \\ i_1, \dots, i_n \in \mathbb{F}_q}} \omega^{j_1 \dots j_m i_1 \dots i_n} |j_1\rangle \dots |j_m\rangle \langle i_1| \dots \langle i_n|$$

where ω is a root of unity. But this is nonsensical, for what does it mean to raise ω to the power of an element of a field \mathbb{F}_q which has no interpretation as $\mathbb{Z}/q\mathbb{Z}$? To make sense of that, there needs to be a map $j \mapsto \omega^j$ which is a group embedding $\mathbb{F}_q \hookrightarrow S^1$; but there is no such embedding. This is essentially the complaint in Roy et.al. that prevented a full generalization of ZH to arbitrary dimensions [17].

However, this difficulty can be overcome by representing \mathbb{F}_q concretely as a vector space over \mathbb{F}_p . The Primitive Element Theorem (See Ch. IV Thm. 4.6 of Lang [15]) tells us that finite field extensions are always simple extensions, meaning that $\mathbb{F}_q = \mathbb{F}_p(\kappa)$ for some $\kappa \in \mathbb{F}_q$. Then the irreducible polynomial of κ over \mathbb{F}_p is of degree $q/p = t$; and the set $\{1, \kappa, \dots, \kappa^{t-1}\}$ forms a basis of \mathbb{F}_q as a vector space over \mathbb{F}_p . That is, every element $j \in \mathbb{F}_q$ can be written as a sum $j = j_0 + j_1 \kappa + \dots + j_{t-1} \kappa^{t-1}$ for unique coefficients $j_0, \dots, j_{t-1} \in \mathbb{F}_p$.

Definition 2.1. By a **simply presented finite field** we mean a pair (\mathbb{F}_q, κ) such that $\mathbb{F}_q = \mathbb{F}_p(\kappa)$.

A simply presented finite field (\mathbb{F}_q, κ) comes with a bilinear map

$$(-|-)_{\kappa} : \mathbb{F}_q \times \mathbb{F}_q \rightarrow \mathbb{F}_p$$

given by dot-product over the basis $\{1, \kappa, \dots, \kappa^{t-1}\}$. This bilinear map varies as κ varies; and in general the choice of κ is not canonical for any given finite field \mathbb{F}_q .

However, none of the statements in the rest of this paper depend on a *particular* choice of a simple presentation; any choice works just as well. So for the rest of the paper we will abuse notation slightly and denote $(-|-)_{\kappa}$ as $(-|-)$, and speak of (\mathbb{F}_q, κ) just as the field \mathbb{F}_q . The question of compatibility between multiple simple presentations will arise in ZH calculi of mixed wire types (wires corresponding to different finite fields); but that is left to future work.

By construction $(-|-)$ is symmetric in the sense that $(i|j) = (j|i)$ for any $i, j \in \mathbb{F}_q$; but it is not “flexsymmetric” in the sense that in general $(ij|k) \neq (j|ik)$:

Definition 2.2. Let $j \in \mathbb{F}_q$. Then the map $M_j : x \mapsto j \cdot x$ is a linear map $\mathbb{F}_q \rightarrow \mathbb{F}_q$. So it has a transpose M_j^{\top} such that for all $x, y \in \mathbb{F}_q$,

$$(M_j x | y) = (x | M_j^{\top} y)$$

call this map $M_j^{\top} : \mathbb{F}_q \rightarrow \mathbb{F}_q$ the **transpose multiplication** by j . It is not in general a field homomorphism, but it is a linear map over \mathbb{F}_p . Moreover, it is bijective if and only if M_j is bijective, if and only if $j \neq 0$.

This gives us enough tools to present the following useful lemma, which begins to resemble the path-sum formalism:

Lemma 2.1. *If $j \in \mathbb{F}_q$; and ω is a primitive p th root of unity in \mathbb{C} , then*

$$\sum_{k \in \mathbb{F}_q} \omega^{(j|k)} = \begin{cases} 0 & j \neq 0 \\ q & j = 0 \end{cases}$$

Proof. First suppose $j \neq 0$. Then the transpose multiplication M_j^{\top} is bijective. Therefore:

$$\sum_{k \in \mathbb{F}_q} \omega^{(j|k)} = \sum_{k \in \mathbb{F}_q} \omega^{(1|M_j^{\top} k)} = \sum_{k' \in \mathbb{F}_q} \omega^{(1|k')} = p^{t-1} \cdot \sum_{\theta=0}^{p-1} \omega^{\theta} = 0$$

where the second equality uses the bijectivity of M_j^{\top} to allow for a change-of-variable; and the third equality follows from the fact that $(1|-) : \mathbb{F}_q \rightarrow \mathbb{F}_p$ is a projection whose kernel is of size p^{t-1} .

The other case where $j = 0$ is straight forward, as $(0|k) = 0$ for any k . \square

Before we move onto defining our graphical calculus, we remind the reader of the following generalization of Fermat’s Little Theorem, which becomes useful in section 3 for universality:

Lemma 2.2. *The multiplicative group of the nonzero elements \mathbb{F}_q^{\times} is cyclic.*

Proof. See Ch. IV Cor. 1.10 of Lang [15]. \square

2.2 Generators of the Finite Field ZH

Definition 2.3. For a simply presented finite field (\mathbb{F}_q, κ) with character p , think of $\mathbb{C}^q \cong \mathbb{C}[\mathbb{F}_q]$ as the Hilbert space with the elements of \mathbb{F}_q as its computational basis. The **phaseless finite field ZH-calculus** on (\mathbb{F}_q, κ) is a family of linear maps on \mathbb{C}^q represented by string diagrams generated by the following:

$$n \text{ : } \bigcirc \text{ : } m = \sum_{i \in \mathbb{F}_q} |i\rangle^{\otimes m} \langle i|^{\otimes n}$$

2.3 Finite Field Arithmetics from ZH

As we mentioned in the introduction (1), the power of the ZH calculus comes in part from the fact that it effortlessly implements both addition (XOR) and multiplication (AND) on the computational basis. We now describe the way in which this holds in our ZH calculus for non-prime sized finite fields. All propositions in this section are proven in appendix A.

Proposition 2.2. *The 1-to-1 X-spider is the same as applying the H-box twice, and acts on the computational basis as negation:*

$$\text{---}\bigcirc\text{---} = \text{---}\square\square\text{---} = \sum_{i \in \mathbb{F}_q} | -i \rangle \langle i | \quad (\text{neg})$$

Proposition 2.3. *The 2-to-1 X-spider followed by a 1-to-1 X-spider implements addition in \mathbb{F}_q , and the 0-to-1 X-spider is the additive identity $0 \in \mathbb{F}_q$*

$$\begin{array}{c} \boxed{q^{\frac{1}{2}}} \\ \diagup \quad \diagdown \\ \bigcirc \quad \bigcirc \end{array} \text{---} = \sum_{i, j \in \mathbb{F}_q} |i + j\rangle \langle i| \langle j| \quad \boxed{q^{-\frac{1}{2}}} \bigcirc \text{---} = |0\rangle \quad (+)$$

Proposition 2.4. *The 2-to-1 H-spider followed by an H^\dagger implements multiplication in \mathbb{F}_q , and the 0-to-1 H-spider followed by an H^\dagger is the multiplicative identity $1 \in \mathbb{F}_q$*

$$\begin{array}{c} \diagup \quad \diagdown \\ \square \quad \square \\ \dagger \quad \dagger \end{array} \text{---} = \sum_{i, j \in \mathbb{F}_q} |i \cdot j\rangle \langle i| \langle j| \quad \square \quad \square \quad \dagger \quad \dagger \text{---} = |1\rangle \quad (\text{m})$$

Proposition 2.5. *The following process implements the transpose multiplication map:*

$$\begin{array}{c} \diagup \\ \square \quad \dagger \\ \diagdown \end{array} \text{---} = \sum_{i, j \in \mathbb{F}_q} |M_j^\top i\rangle \langle i| \langle j| \quad (\text{mt})$$

This characterizes exactly how flexsymmetry fails in our finite field ZH calculus:

Corollary 2.1. *The transpose-multiply-onto-1 map*

$$\begin{array}{c} \diagup \\ \square \quad \dagger \\ \diagdown \end{array} \text{---} = \sum_{j \in \mathbb{F}_q} |M_j^\top 1\rangle \langle j|$$

is the dualizer that makes the finite field ZH calculus flexsymmetric up to dualizers (In the sense of Carette [5]).

Propositions 2.3 and 2.4 together allows us to define the generalized Pauli-X gate, which acts on the computational basis as $+1$:

$$\text{---}\oplus\text{---} := \begin{array}{c} \boxed{q^{\frac{1}{2}}} \\ \diagup \quad \diagdown \\ \bigcirc \quad \bigcirc \\ \diagdown \quad \diagup \\ \square \quad \dagger \end{array} \text{---} = \sum_{j \in \mathbb{F}_q} |j + 1\rangle \langle j|.$$

A major difference between the finite field ZH and the prime-dimensional ZH is that the additive structure on the computational basis is non-cyclic; and therefore one *cannot* obtain all computational basis states by simply starting from $|0\rangle$ and applying Pauli-X gates to it. It takes some work to retrieve all the computational basis states in the finite field ZH:

Lemma 2.3. *Let (\mathbb{F}_q, κ) be a simple presented finite field, and $j \in \mathbb{F}_q$ any field element. Then there exists a diagram in the phase-free finite field ZH calculus on (\mathbb{F}_q, κ) that represents $|j\rangle$.*

Proof. Since (\mathbb{F}_q, κ) is a simple presentation, any $j \in \mathbb{F}_q$ can be written as $j = j_0 + j_1\kappa + \dots + j_{t-1}\kappa^{t-1}$ for $j_0, \dots, j_{t-1} \in \mathbb{F}_p$. By propositions 2.3 and 2.4 we already have ZH diagrams implementing addition and multiplication; so it suffices to implement $j_\tau \in \mathbb{F}_p$ and κ^τ for all $\tau = 0, \dots, t-1$.

First, to implement the elements of \mathbb{F}_p : by proposition 2.3 we have $\boxed{q^{-\frac{1}{2}}}$ \circ — = $|0\rangle$, and so for any $n \in \mathbb{F}_p$, we have $\boxed{q^{-\frac{1}{2}}}$ \circ \oplus \dots \oplus — = $|n\rangle$.

Next, to implement κ^τ : recall that κ — = $q^{\frac{1}{2}}|\kappa\rangle$ is a generator of the phaseless finite field ZH-calculus on (\mathbb{F}_q, κ) . Raise it to the τ th power: $\boxed{q^{-\frac{1}{2}}}$ \circ κ \circ τ \oplus — = $|\kappa^\tau\rangle$.

Together these allow us to construct any computational basis state in the phase-free finite field ZH calculus. \square

Since, then, every computational basis state is constructible in the phase-free finite field ZH calculus, we will simply denote

$$\textcircled{j} \text{---} := q^{\frac{1}{2}}|j\rangle \quad \textcircled{j} \text{---} := \textcircled{j} \oplus \text{---} \quad (\text{bas})$$

for any $j \in \mathbb{F}_q$. We emphasize that these decorated lollipops are in the phase-free calculus. The Z-lollipop states are *not* self-conjugate; and so their transposes are not their adjoints. Indeed the conjugate of a Z-lollipop state is

$$\overline{(\textcircled{j} \text{---})} = \textcircled{j} \oplus \text{---} = \textcircled{j} \oplus \oplus \text{---} = \textcircled{-j} \text{---}$$

The following corollary follows directly from the definitions of the X- and Z-lollipops:

Corollary 2.2. *The X- and Z-lollipop states, up to a factor of \sqrt{q} , are orthonormal bases of \mathbb{C}^q , and are Fourier with respect to each other. That is:*

$$\textcircled{i} \text{---} \textcircled{-j} = \textcircled{i} \text{---} \textcircled{j} = q\delta_i^j \quad \textcircled{i} \text{---} \textcircled{j} = q^{\frac{1}{2}}\omega^{-(ij)}$$

We can then articulate the following corollary of propositions 2.4 and 2.5, which follow immediately from the fact that field multiplication by nonzero elements is invertible:

Corollary 2.3. *For $j \in \mathbb{F}_q^\times$, the following processes are unitary:*

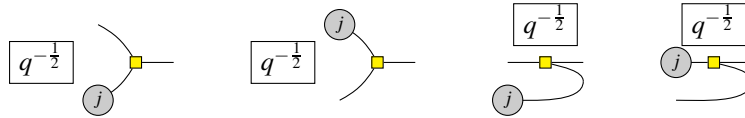

2.4 Rewrite Rules

In Backens et al. [2] a set of eight rewrite rules, each intuitively corresponding to an algebraic fact about $\mathbb{Z}/2\mathbb{Z}$, were introduced for the qubit ZH calculus. In figure 1, similarly, we present a set of nine rules for the finite field ZH calculus, each corresponding to an algebraic fact about \mathbb{F}_q .

The soundness of these rules is proven in appendix B. Note that we have not mentioned here the rule that four fourier transforms in a row makes the identity. This is because this rule is derivable from the other rules shown in figure 1. The derivation is identical to that found in section 3 of [17].

2. The Z-spider suffices to implement Schur products. So the problem is reduced to that of expressing any pseudo-binary matrix.
3. Any pseudo-binary matrix $M : \mathbb{C}^{q^n} \rightarrow \mathbb{C}^{q^m}$ can be encoded as a propositional formula ϕ with $n + m$ variables over $(\mathbb{F}_q, +, -, \cdot, =)$ such that $\phi(i_1, \dots, i_n, j_1, \dots, j_m) \leftrightarrow m_{i_1, \dots, i_n}^{j_1, \dots, j_m} = 1$.
4. Any propositional formula $\phi(x_1, \dots, x_n)$ corresponds to a polynomial $f_\phi \in \mathbb{F}_q[x_1, \dots, x_n]$ such that $f_\phi(i_1, \dots, i_n) = 0 \leftrightarrow \phi(i_1, \dots, i_n)$.
5. For any polynomial $f \in \mathbb{F}_q[x_1, \dots, x_n]$, there exists an n -input 1-output phase-free ZH diagram D_f that acts on the computational basis as:

$$D_f|i_1 \dots i_n\rangle = \begin{cases} |0\rangle & f(i_1, \dots, i_n) = 0 \\ |1\rangle & f(i_1, \dots, i_n) \neq 0 \end{cases}$$

6. For any $r \in R$, then, we can post-select on D_f with the phased H-box $\text{---} \boxed{r} = \sum_j r^{(1|j)} \langle j|$ to obtain a (phased) ZH diagram D with n inputs and no outputs, such that

$$D|i_1 \dots i_n\rangle = \begin{cases} 1 & f(i_1, \dots, i_n) = 0 \\ r & f(i_1, \dots, i_n) \neq 0 \end{cases}$$

7. Using facts 3-6 together, given any pseudo-binary matrix M that is $q^n \times q^m$, there is a (phased) ZH diagram D with $n + m$ inputs and no outputs such that $D|i_1, \dots, i_n, j_1, \dots, j_m\rangle = m_{i_1, \dots, i_n}^{j_1, \dots, j_m}$. The corresponding $n \rightarrow m$ diagram given by the Choi-Jamiołkowski isomorphism (bending the last m wires) then implements M .

The proofs for facts 1, 2, 3, 6, and 7 are identical to that in the case of prime-dimensional qudits. Since for these facts no change is required whatsoever, we will not set out the proofs again here, and refer readers to section 4 of [17]. What does change, however, are the proofs for the facts 4 and 5. We prove these below as lemmas. Taken together, this completes the proof for theorem 3.1. \square

Lemma 3.1. *Let $\phi(x_1, \dots, x_n)$ be a propositional formula on $(\mathbb{F}_q, +, -, \cdot, =)$. There exists a polynomial $f_\phi \in \mathbb{F}_q[x_1, \dots, x_n]$ such that for all $i_1, \dots, i_n \in \mathbb{F}_q$, $f_\phi(i_1, \dots, i_n) = 0 \leftrightarrow \phi(i_1, \dots, i_n)$.*

Proof. We prove by induction on the complexity of ϕ . Any term with n variables in $(\mathbb{F}_q, +, -, \cdot, =)$ is by construction a polynomial in $\mathbb{F}_q[x_1, \dots, x_n]$. The only relation symbol is $=$. So if ϕ is atomic, it must be of form $\phi = (f_1(x_1, \dots, x_n) = f_2(x_1, \dots, x_n))$ for polynomials $f_1, f_2 \in \mathbb{F}_q[x_1, \dots, x_n]$. Then $f_\phi = f_1 - f_2$ satisfies the requirement of the theorem. Now for the inductive step:

1. If $\phi = \neg\phi'$ for some formula ϕ' , then set $f_\phi = 1 - (f_{\phi'})^{q-1}$. Then, if ϕ' is true, we have $f_\phi = 1 - 0 = 1$, so $f_\phi \neq 0$ when ϕ is false. Conversely, if ϕ' is false, we have $f_{\phi'} \neq 0$, and so by lemma 2.2, $(f_{\phi'})^{q-1} = 1$, and so $f_\phi = 0$.
2. If $\phi = \phi' \vee \phi''$ for formulae ϕ', ϕ'' , then set $f_\phi = f_{\phi'} \cdot f_{\phi''}$. Then we have $f_\phi = 0 \leftrightarrow ((f_{\phi'} = 0) \vee (f_{\phi''} = 0)) \leftrightarrow (\phi' \vee \phi'') = \phi$.

This completes the induction. \square

Lemma 3.2. *For any polynomial $f \in \mathbb{F}_q[x_1, \dots, x_n]$ there exists a phase-free ZH diagram D_f that acts on the computational basis as*

$$D_f|i_1 \dots i_n\rangle = \begin{cases} |0\rangle & f(i_1, \dots, i_n) = 0 \\ |1\rangle & f(i_1, \dots, i_n) \neq 0 \end{cases}$$

Proof. The construction proceeds in two steps. First, we construct a diagram D'_f with n input wires and 1 output wire such that $D'_f|i_1, \dots, i_n\rangle = |f(i_1, \dots, i_n)\rangle$. We then post-compose D'_f with the map

$$\text{---} \circlearrowleft \text{---} \begin{matrix} :q-1 \\ \vdots \\ 1 \end{matrix} \text{---} \text{---} \text{---} = \sum_{j \in \mathbb{F}_q} |j^{q-1}\rangle \langle j|$$

which, by lemma 2.2, sends $|0\rangle \mapsto |0\rangle$, and all nonzero $|j\rangle \mapsto |1\rangle$. This gives us D_f .

So it remains only to construct D'_f , the diagram that acts on the computational basis as the polynomial itself. We do this by induction on n . If $n = 0$ then f is just a constant $f = j \in \mathbb{F}_q$. Lemma 2.3 gives us a phase-free ZH diagram $\text{---} \text{---} \text{---} \text{---} \text{---} = q^{-\frac{1}{2}}|j\rangle$. So constants are constructible in the phase-free ZH calculus.

Now for the inductive step: since $\mathbb{F}_q[x_1, \dots, x_n] = \mathbb{F}_q[x_1, \dots, x_{n-1}][x_n]$, so f can be written as $f = f_0 + f_1x_n + \dots + f_kx_n^k$ for some collection f_0, \dots, f_k of polynomials in $\mathbb{F}_q[x_1, \dots, x_{n-1}]$. By the inductive hypothesis there are phase-free ZH diagrams corresponding to each f_i . Then the following phase-free diagram constructs f :

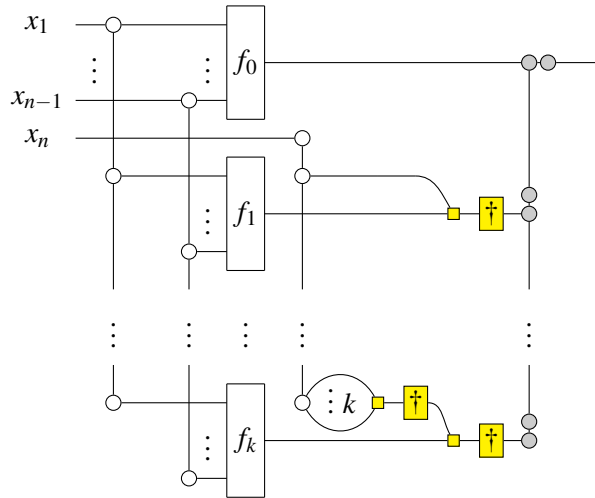

The correctness of this construction is readily verified by propositions 2.3 and 2.4. □

4 An Example: The Polynomial Interpolation Algorithm

Suppose we are given oracular access to a polynomial $f \in \mathbb{F}_q[x]$ of known degree d : $f(x) = a_dx^d + \dots + a_1x + a_0$, but we do not know the coefficients a_d, \dots, a_0 . The polynomial interpolation problem asks us to infer the values of the coefficients with the fewest possible queries to the oracle.

On classical computers it is known that $d + 1$ queries are needed, and is also clearly sufficient: for that would provide us with $d + 1$ linear equations between $d + 1$ unknown quantities. For quantum computers, it was initially shown by Kane and Kutin [13], and independently by Meyer and Pommershein [16], that at least $\frac{d+1}{2}$ queries are needed to compute the coefficients with bounded error. Subsequently it was shown by Boneh and Zhandry [4] that d quantum queries suffice, therefore giving a quantum-speedup of at least 1 query. Finally it was shown by Childs et. al. in 2016 [7] that the lower bound $\frac{d+1}{2}$ is in fact tight: there exists a way to compute the coefficients with bounded error with only that many quantum queries.

Here we present a diagrammatic account of Boneh and Zhandry's [4] algorithm to reduce the number of queries by 1. Begin by noticing that a classical computer can reduce the degree- d problem to a degree-1 problem in only $d - 1$ classical queries. So it suffices to find a quantum algorithm that interpolates a degree-one polynomial in one single quantum query.

So let $f(x) = ax + b$, with $a \in \mathbb{F}_q^\times$ and $b \in \mathbb{F}_q$. We begin by extending f linearly to $F : \mathbb{C}^q \rightarrow \mathbb{C}^q$:

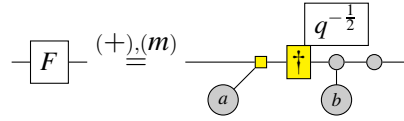

and constructing the following quantum oracle:

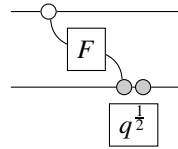

Inputting the uniform superposition to the first register, and the 0 basis state to the second, we obtain:

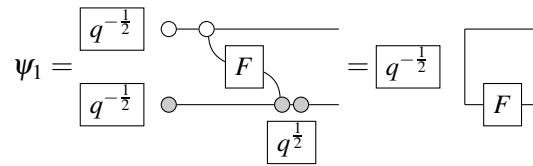

Now we define the following controlled unitary U :

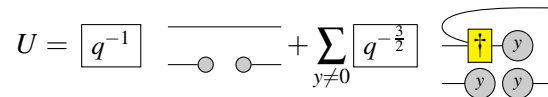

recall that the H-spider bit of the nonzero terms is indeed unitary by proposition 2.3. We then apply this unitary to the state ψ_1 , intermediated by an H-gate on the bottom register:

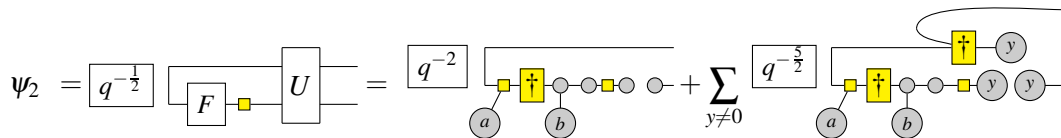

Now let's focus on the $y \neq 0$ terms in the above ψ_2 , as that's where the bulk of the magic happens:

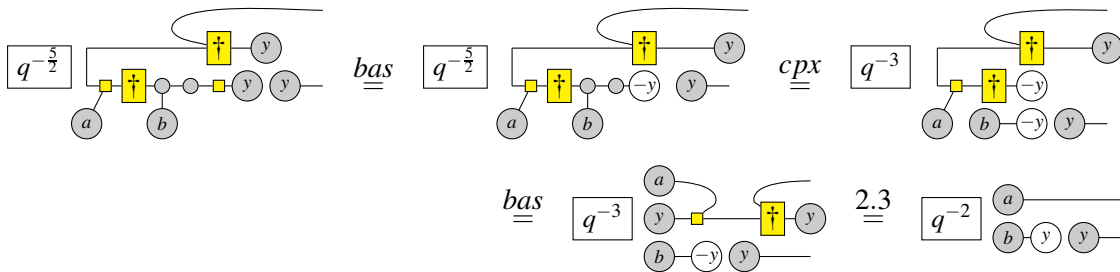

Where the last step relies on proposition 2.3, and the fact that $y \neq 0$. So:

$$\psi_2 = \boxed{q^{-2}} \left[\text{Circuit with } a, b, \text{ and } \dagger \text{ gates} \right] + \sum_{y \neq 0} \boxed{q^{-2}} \left[\text{Circuit with } a, b, y, y \text{ gates} \right]$$

The contents of the first term in ψ_2 is useless to us. So we now perform a non-demolition projective measurement on the second register. To do so, we introduce some classical registers. We now use bolded lines to denote quantum systems, viewed in the mixed-state formalism, and thin lines to denote classical systems viewed probabilistically. Let:

$$\Psi_2 = \text{double}(\psi_2)$$

Where the "doubling" is the movement to the CPM construction, so that vectors become density matrices, and linear transformations become operators between density matrices, in Selinger's sense [18]. Define the projective measurement

$$P = \left[\text{Circuit with } q^{-\frac{5}{2}} \text{ gate} \right] + \sum_{y \neq 0} \left[\text{Circuit with } q^{-\frac{5}{2}} \text{ gate and } y, y, 1 \text{ gates} \right]$$

Applying P to the second register of Ψ_2 and measuring the outcome, we get

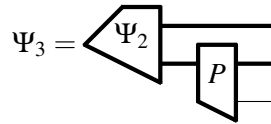

We post-select on the classical output for 1. The probability that the projective measurement returns 0 is just the probability that the linear function f returns 0 when the input is uniformly random. But since any linear function on \mathbb{F}_q is bijective, so the probability that f returns 0 is just $1/q$. Thus the probability that P returns 0 is also $1/q$.

$$\Psi_3|_{y \neq 0} = \frac{q}{q-1} \left[\text{Circuit with } \Psi_2 \text{ and } P \text{ gates} \right] = \frac{q}{q-1} \text{double} \left(\sum_{y \neq 0} \boxed{q^{-2}} \left[\text{Circuit with } a, b, y, y \text{ gates} \right] \right)$$

Now we simply hit the second register with the inverse Fourier transform and measure, obtaining

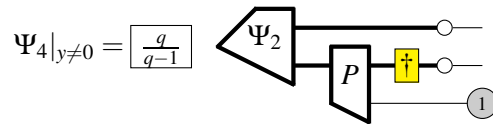

The first register is sure to return a ; whereas the probability that the second register returns b is

$$\frac{q}{q-1} \text{double} \left(\sum_{y \neq 0} \boxed{q^{-2}} \left[\text{Circuit with } b, -y, y, b \text{ gates} \right] \right) = \frac{q}{q-1} \left(\sum_{y \neq 0} \frac{1}{q} \omega^{(b|y) - (b|y)} \right)^2 = \frac{q}{q-1} \left(\frac{q-1}{q} \right)^2 = \frac{q-1}{q}$$

where the first equality uses corollary 2.2. Thus the second register returns b with a probability of $\frac{q-1}{q}$.

So, to sum up, the quantum polynomial interpolation algorithm is:

Algorithm 4.1. Given a classical oracle $g : \mathbb{F}_q \rightarrow \mathbb{F}_q$ a polynomial of known degree d :

1. Use $d - 1$ classical queries to reduce the problem of finding the coefficients of g to the problem of finding the coefficients of a degree-1 polynomial $f(x) = ax + b$ with unknown $a \in \mathbb{F}_q^\times$ and $b \in \mathbb{F}_q$.
2. Extend f linearly to a transformation $F : \mathbb{C}^q \rightarrow \mathbb{C}^q$, and build the following quantum oracle:

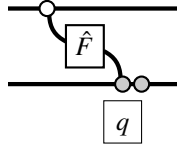

3. Make a single query to the oracle with the uniform superposition as the first input and the zeroth basis state as the second input; and then apply the following operations:

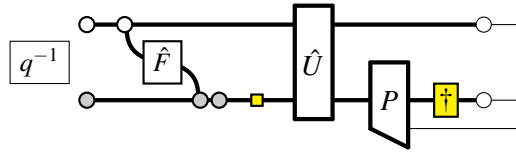

where

$$\hat{U} = \text{double} \left(\begin{array}{c} \boxed{q^{-1}} \text{ --- } \text{---} \text{---} \\ \text{---} \text{---} \end{array} + \sum_{y \neq 0} \boxed{q^{-\frac{3}{2}}} \begin{array}{c} \text{---} \text{---} \text{---} \\ \text{---} \text{---} \end{array} \begin{array}{c} \text{---} \text{---} \text{---} \\ \text{---} \text{---} \end{array} \right)$$

$$P = \begin{array}{c} \text{---} \text{---} \\ \boxed{q^{-\frac{5}{2}}} \end{array} + \sum_{y \neq 0} \begin{array}{c} \text{---} \text{---} \\ \boxed{q^{-\frac{5}{2}}} \end{array} \begin{array}{c} \text{---} \text{---} \\ \text{---} \end{array}$$

4. The right-most classical output is 0 with probability $1/q$. In that case, abort and restart. Else, the first classical output is a with probability 1, and the second classical output is b with probability $(q - 1)/q$.

5 Conclusion

We have presented an extension of the ZH calculus to Hilbert spaces of prime-power dimensionality $q = p^t$, such that the generalized AND gate constructed from the H-boxes corresponds to field multiplication in the finite field \mathbb{F}_q . We have shown that this finite field ZH calculus, with phases, is universal over matrices with entries in the ring $\mathbb{Z}[\omega]$. The usefulness of an extension of this form is demonstrated by its ability to reason elegantly about the quantum polynomial interpolation algorithm.

An obvious direction for future research is to consider the completeness of the rewrite rules presented in section 2.4. A rule that was present in [2], corresponding to the fact that a field has no zero-divisor, is missing in our ruleset. It remains to be seen whether there is an adequate replacement rule to be found for the finite field ZH, or whether the rule is in fact redundant.

Another direction is to consider whether the phase-free finite field ZH calculus is also universal. To prove universality for the phase-free calculus, one would need what is known as a "successor gadget" helping one walk over the necessary phases for a single-output H-lollipop [17]. The technique for constructing such a gadget, and indeed the 0-phased H-lollipop itself, requires some further work.

References

- [1] Miriam Backens & Aleks Kissinger (2019): *ZH: A Complete Graphical Calculus for Quantum Computations Involving Classical Non-linearity*. *Electronic Proceedings in Theoretical Computer Science* 287, pp. 23–42, doi:10.4204/EPTCS.287.2. Available at <http://arxiv.org/abs/1805.02175v2>.
- [2] Miriam Backens, Aleks Kissinger, Hector Miller-Bakewell, John van de Wetering & Sal Wolfs (2023): *Completeness of the ZH-calculus*. *Compositionality* 5, p. 5, doi:10.32408/compositionality-5-5. Available at <http://arxiv.org/abs/2103.06610>. ArXiv:2103.06610 [quant-ph].
- [3] Niel de Beaudrap & Richard D. P. East (2023): *Simple ZX and ZH calculi for arbitrary finite dimensions, via discrete integrals*. Available at <http://arxiv.org/abs/2304.03310>. ArXiv:2304.03310 [quant-ph].
- [4] Dan Boneh & Mark Zhandry (2013): *Quantum-Secure Message Authentication Codes*. In David Hutchison, Takeo Kanade, Josef Kittler, Jon M. Kleinberg, Friedemann Mattern, John C. Mitchell, Moni Naor, Oscar Nierstrasz, C. Pandu Rangan, Bernhard Steffen, Madhu Sudan, Demetri Terzopoulos, Doug Tygar, Moshe Y. Vardi, Gerhard Weikum, Thomas Johansson & Phong Q. Nguyen, editors: *Advances in Cryptology – EUROCRYPT 2013*, 7881, Springer Berlin Heidelberg, Berlin, Heidelberg, pp. 592–608. Series Title: Lecture Notes in Computer Science.
- [5] Titouan Carette: *Wielding the ZX-calculus, Flexsymmetry, Mixed States, and Scalable Notations*.
- [6] Titouan Carette & Emmanuel Jeandel (2020): *A Recipe for Quantum Graphical Languages*, pp. 17 pages, 616891 bytes. doi:10.4230/LIPICS.ICALP.2020.118. Available at <https://drops.dagstuhl.de/entities/document/10.4230/LIPICS.ICALP.2020.118>. Artwork Size: 17 pages, 616891 bytes ISBN: 9783959771382 Medium: application/pdf Publisher: Schloss Dagstuhl – Leibniz-Zentrum für Informatik.
- [7] Andrew M. Childs, Wim van Dam, Shih-Han Hung & Igor E. Shparlinski (2016): *Optimal quantum algorithm for polynomial interpolation*, pp. 13 pages, 505775 bytes. doi:10.4230/LIPICS.ICALP.2016.16. Available at <http://arxiv.org/abs/1509.09271>. ArXiv:1509.09271 [quant-ph].
- [8] Bob Coecke & Ross Duncan (2011): *Interacting Quantum Observables: Categorical Algebra and Diagrammatics*. *New Journal of Physics* 13(4), p. 043016, doi:10.1088/1367-2630/13/4/043016. Available at <http://arxiv.org/abs/0906.4725>. ArXiv:0906.4725 [quant-ph].
- [9] Bob Coecke & Aleks Kissinger (2017): *Picturing Quantum Processes: A First Course in Quantum Theory and Diagrammatic Reasoning*, 1 edition. Cambridge University Press, doi:10.1017/9781316219317. Available at <https://www.cambridge.org/core/product/identifier/9781316219317/type/book>.
- [10] Alexander Cowtan, Silas Dilkes, Ross Duncan, Will Simmons & Seyon Sivarajah (2020): *Phase Gadget Synthesis for Shallow Circuits*. *Electronic Proceedings in Theoretical Computer Science* 318, pp. 213–228, doi:10.4204/EPTCS.318.13. Available at <http://arxiv.org/abs/1906.01734>. ArXiv:1906.01734 [quant-ph].
- [11] Giovanni de Felice, Amar Hadzihasanovic & Kang Feng Ng (2019): *A diagrammatic calculus of fermionic quantum circuits*, doi:10.23638/LMCS-15(3:26)2019. Available at <http://arxiv.org/abs/1801.01231>. ArXiv:1801.01231 [quant-ph].
- [12] Amar Hadzihasanovic (2017): *The algebra of entanglement and the geometry of composition*, doi:10.48550/arXiv.1709.08086. Available at <http://arxiv.org/abs/1709.08086>. ArXiv:1709.08086 [quant-ph].
- [13] Daniel M. Kane & Samuel A. Kutin (2010): *Quantum interpolation of polynomials*. Available at <http://arxiv.org/abs/0909.5683>. ArXiv:0909.5683 [quant-ph].
- [14] Mark Koch (2022): *Quantum Machine Learning using the ZXW-Calculus*, doi:10.48550/arXiv.2210.11523. Available at <http://arxiv.org/abs/2210.11523>. ArXiv:2210.11523 [quant-ph].
- [15] Serge Lang (2002): *Algebra*. *Graduate Texts in Mathematics* 211, Springer New York, New York, NY, doi:10.1007/978-1-4613-0041-0. Available at <http://link.springer.com/10.1007/978-1-4613-0041-0>.

- [16] David A. Meyer & James Pommersheim (2010): *On the uselessness of quantum queries*. Available at <http://arxiv.org/abs/1004.1434>. ArXiv:1004.1434 [quant-ph].
- [17] Patrick Roy, John van de Wetering & Lia Yeh (2023): *The Qudit ZH-Calculus: Generalised Toffoli+Hadamard and Universality*. *Electronic Proceedings in Theoretical Computer Science* 384, pp. 142–170, doi:10.4204/EPTCS.384.9. Available at <http://arxiv.org/abs/2307.10095>. ArXiv:2307.10095 [quant-ph].
- [18] Peter Selinger (2007): *Dagger Compact Closed Categories and Completely Positive Maps*. *Electronic Notes in Theoretical Computer Science* 170, pp. 139–163, doi:10.1016/j.entcs.2006.12.018. Available at <https://linkinghub.elsevier.com/retrieve/pii/S1571066107000606>.
- [19] Razin A. Shaikh, Quanlong Wang & Richie Yeung (2023): *How to Sum and Exponentiate Hamiltonians in ZXW Calculus*. *Electronic Proceedings in Theoretical Computer Science* 394, pp. 236–261, doi:10.4204/EPTCS.394.14. Available at <http://arxiv.org/abs/2212.04462>. ArXiv:2212.04462 [quant-ph].
- [20] Quanlong Wang (2021): *A non-anyonic qudit ZW-calculus*, doi:10.48550/arXiv.2109.11285. Available at <http://arxiv.org/abs/2109.11285>. ArXiv:2109.11285 [quant-ph].
- [21] Quanlong Wang, Richie Yeung & Mark Koch (2022): *Differentiating and Integrating ZX Diagrams with Applications to Quantum Machine Learning*, doi:10.48550/arXiv.2201.13250. Available at <http://arxiv.org/abs/2201.13250>. ArXiv:2201.13250 [quant-ph].
- [22] John van de Wetering (2020): *ZX-calculus for the working quantum computer scientist*, doi:10.48550/arXiv.2012.13966. Available at <http://arxiv.org/abs/2012.13966>. ArXiv:2012.13966 [quant-ph].

A Soundness of Finite Field Arithmetics in ZH

Claim. (Proposition 2.2) *The 1-to-1 X-spider is the same as applying the H-box twice, and acts on the computational basis as negation:*

$$\text{---}\bigcirc\text{---} = \text{---}\square\square\text{---} = \sum_{i \in \mathbb{F}_q} |-i\rangle\langle i| \quad (\neg)$$

Proof.

$$\begin{aligned} \text{---}\bigcirc\text{---} &= \text{---}\square\bigcirc\square\text{---} \\ &\stackrel{(id)}{=} \text{---}\square\square\text{---} \\ &= \frac{1}{q} \sum_{i,j,k \in \mathbb{F}_q} \omega^{(i|j)} \omega^{(j|k)} |k\rangle\langle i| \\ &= \frac{1}{q} \sum_{i,j,k \in \mathbb{F}_q} \omega^{(j|i+k)} |k\rangle\langle i| \\ &\stackrel{2.1}{=} \sum_{i \in \mathbb{F}_q} |-i\rangle\langle i| \end{aligned}$$

□

Claim. (Proposition 2.3) *The 2-to-1 X-spider implements addition in \mathbb{F}_q , and the 0-to-1 X-spider is the additive identity $0 \in \mathbb{F}_q$:*

$$\begin{aligned} \text{---}\bigcirc\text{---} &= |i+j\rangle \quad (+) \\ \text{---}\square\text{---} &= |0\rangle \quad (0) \end{aligned}$$

Proof.

$$\begin{aligned}
 \begin{array}{c} \boxed{q^{\frac{1}{2}}} \\ \circ \text{---} \circ \end{array} &= \begin{array}{c} \boxed{q^{-\frac{1}{2}}} \\ \circ \text{---} \square \text{---} \square \text{---} \square \end{array} \\
 &= \frac{1}{q} \sum_{k,l \in \mathbb{F}_q} \omega^{-(l|k)} \omega^{(k|i)} \omega^{(k|j)} |l\rangle \\
 &= \frac{1}{q} \sum_{k,l \in \mathbb{F}_q} \omega^{(k|i+j-l)} |l\rangle \\
 &\stackrel{2.1}{=} |i+j\rangle \\
 \begin{array}{c} \boxed{q^{-\frac{1}{2}}} \\ \circ \text{---} \end{array} &= \begin{array}{c} \boxed{q^{-\frac{1}{2}}} \\ \circ \text{---} \square \end{array} \\
 &= \frac{1}{q} \sum_{k,l} \omega^{(l|k)} |l\rangle \\
 &\stackrel{2.1}{=} |0\rangle.
 \end{aligned}$$

□

Claim. (Proposition 2.4) The 2-to-1 H-spider followed by the inverse Fourier transform, implements multiplication in \mathbb{F}_q , and the 0-to-1 H-spider followed by the inverse Fourier transform is the multiplicative identity $1 \in \mathbb{F}_q$:

$$\begin{aligned}
 \begin{array}{c} \text{)} \\ \square \text{---} \end{array} \boxed{\dagger} &= |i \cdot j\rangle & (\cdot) \\
 \square \text{---} \boxed{\dagger} &= |1\rangle & (1)
 \end{aligned}$$

Proof.

$$\begin{aligned}
 \begin{array}{c} \text{)} \\ \square \text{---} \end{array} \boxed{\dagger} &= \frac{1}{q} \sum_{k,l \in \mathbb{F}_q} \omega^{-(l|k)} \omega^{(k|ij)} |l\rangle \\
 &= \frac{1}{q} \sum_{k,l \in \mathbb{F}_q} \omega^{(l-ij|k)} |l\rangle \\
 &\stackrel{2.1}{=} \frac{1}{q} \cdot q |i \cdot j\rangle \\
 &= |i \cdot j\rangle \\
 \square \text{---} \boxed{\dagger} &= \frac{1}{q} \sum_{k,l \in \mathbb{F}_q} \omega^{-(l|k)} \omega^{(k|1)} |l\rangle \\
 &= \frac{1}{q} \sum_{k,l \in \mathbb{F}_q} \omega^{(k|1-l)} |l\rangle \\
 &\stackrel{2.1}{=} |1\rangle.
 \end{aligned}$$

□

Claim. (Proposition 2.5) The following process implements the transpose multiplication map:

$$\text{---} \boxed{+} \text{---} = |M_j^\top i\rangle \tag{1}$$

Proof.

$$\begin{aligned} \text{---} \boxed{+} \text{---} &= \frac{1}{q} \sum_{k,l \in \mathbb{F}_q} \omega^{-(l|k)} \omega^{(kj|i)} |l\rangle \\ &= \frac{1}{q} \sum_{k,l \in \mathbb{F}_q} \omega^{-(l|k)} \omega^{(k|M_j^\top i)} |l\rangle \\ &= \frac{1}{q} \sum_{k,l \in \mathbb{F}_q} \omega^{(M_j^\top i - l|k)} |l\rangle \\ &\stackrel{2.1}{=} |M_j^\top i\rangle \end{aligned}$$

□

Claim. (Corollary 2.1) The transpose-multiply-onto-1 map

$$\text{---} \boxed{+} \text{---} = \sum_{j \in \mathbb{F}_q} |M_j^\top(1)\rangle \langle j|$$

is the dualizer giving (quasi)-flexsymmetry to the finite-field ZH calculus.

Proof. This follows directly from H-box fusion (hs), which is proven independently in appendix B. The following is just an unfusing of the H-box:

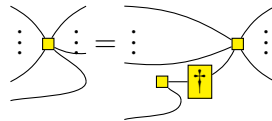

□

B Soundness of Rewrite Rules

Claim. *The following equations hold when the ZH calculus is interpreted as linear maps:*

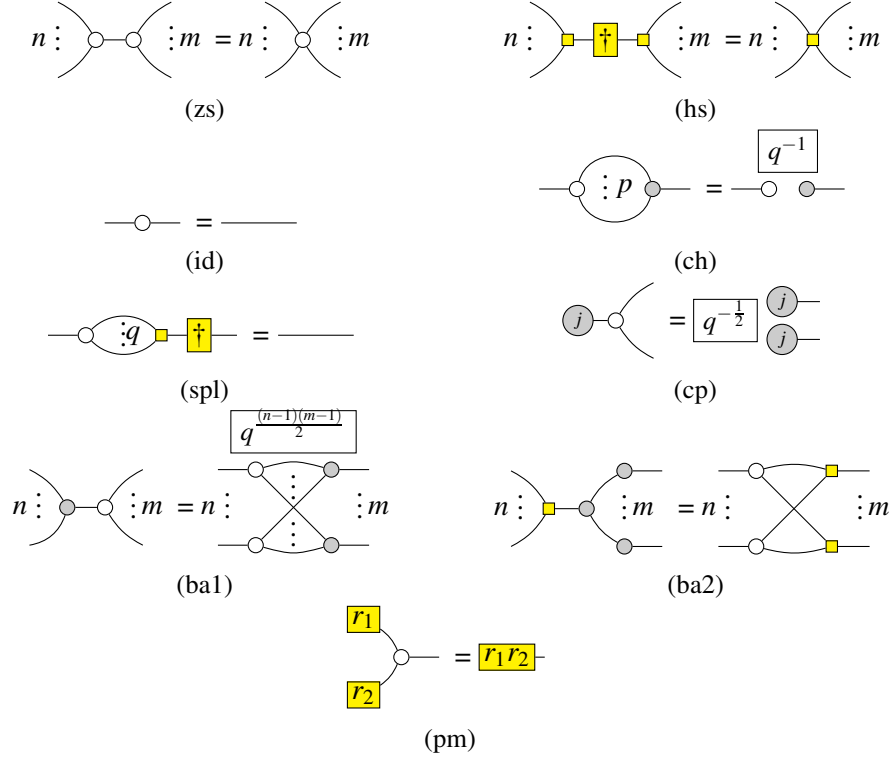

Proof. (Of the zs rule) The (zs) rule encodes the information that copying is coassociative:

$$\begin{aligned}
 n \vdots \left(\text{comultiplication} \right) \vdots m &= \left(\sum_{j \in \mathbb{F}_q} |j\rangle^{\otimes m} \langle j| \right) \circ \left(\sum_{i \in \mathbb{F}_q} |i\rangle \langle i|^{\otimes n} \right) \\
 &= \sum_{j \in \mathbb{F}_q} |j\rangle^{\otimes m} \langle j| j \rangle \langle j|^{\otimes n} \\
 &= \sum_{j \in \mathbb{F}_q} |j\rangle^{\otimes m} \langle j|^{\otimes n} \\
 &= n \vdots \left(\text{comultiplication} \right) \vdots m.
 \end{aligned}$$

□

Proof. (Of the hs rule) The (hs) rule encodes the information that multiplication is associative:

$$\begin{aligned}
n \text{ : } \left[\text{---} \square \text{---} \right] \text{ : } m &= q^{-\frac{3}{2}} \sum_{\substack{j_1, \dots, j_m \\ i_1, \dots, i_n \in \mathbb{F}_q \\ k, l}} \omega^{(i_1 \dots i_n | k) - (k | l) + (l | j_1 \dots j_m) | j_1 \dots j_m} \langle i_1 | \dots \langle i_n | \\
&= q^{-\frac{3}{2}} \left(\sum_{j_1, \dots, j_m, l} \omega^{(l | j_1 \dots j_m) | j_1 \dots j_m} \langle l | \right) \circ \left(\sum_{i_1, \dots, i_n, k, l} \omega^{(i_1 \dots i_n - l | k) | l} \langle i_1 | \dots \langle i_n | \right) \\
&= q^{-\frac{1}{2}} \left(\sum_{j_1, \dots, j_m, l} \omega^{(l | j_1 \dots j_m) | j_1 \dots j_m} \langle l | \right) \circ \left(\sum_{i_1, \dots, i_n} |i_1 \dots i_n\rangle \langle i_1 | \dots \langle i_n | \right) \\
&= q^{-\frac{1}{2}} \sum_{\substack{i_1, \dots, i_n \\ j_1, \dots, j_m}} \omega^{(i_1 \dots i_n | j_1 \dots j_m) | j_1 \dots j_m} \langle i_1 | \dots \langle i_n | \\
&= n \text{ : } \left[\text{---} \square \text{---} \right] \text{ : } m.
\end{aligned}$$

□

Proof. (Of the id rule) The (id) rule encodes the resolution of identity:

$$\text{---} \circ \text{---} = \sum_{j \in \mathbb{F}_q} |j\rangle \langle j| = \mathbf{1}$$

□

Proof. (Of the ch rule) The (ch) rule encodes the information that the character of \mathbb{F}_q is p :

$$\begin{aligned}
\text{---} \circ \text{---} \text{ : } p &= q^{-\frac{1}{2}} \sum_{j \in \mathbb{F}_q} |p \cdot j\rangle \langle j| \\
&= q^{-\frac{1}{2}} \sum_{j \in \mathbb{F}_q} |0\rangle \langle j| \\
&= q^{-1} \left(q^{\frac{1}{2}} |0\rangle \right) \circ \left(\sum_{j \in \mathbb{F}_q} \langle j| \right) \\
&= \boxed{q^{-1}} \\
&= \text{---} \circ \text{---}
\end{aligned}$$

□

Proof. (Of the spl rule) The (spl) rule encodes the information that every element of \mathbb{F}_q is a root of the polynomial $x^q - x$:

$$\begin{aligned}
\text{---} \circ \text{---} \text{ : } q &= \sum_{j \in \mathbb{F}_q} |j^q\rangle \langle j| \\
&= \sum_{j \in \mathbb{F}_q} |j\rangle \langle j| \\
&= \mathbf{1}.
\end{aligned}$$

where the second equality follows from the fact that every element of \mathbb{F}_q is a root of the polynomial $x^q - x$. \square

Proof. (Of the cp rule) The (cp) rule encodes the information that the Z-spider copies computational basis states:

$$\begin{aligned} \text{Z-spider}(j) &= \left(\sum_{i \in \mathbb{F}_q} |i\rangle |i\rangle \langle i| \right) \circ \left(q^{\frac{1}{2}} |j\rangle \right) \\ &= q^{\frac{1}{2}} |j\rangle |j\rangle \\ &= \boxed{q^{-\frac{1}{2}}} \text{X-spider}(j). \end{aligned}$$

\square

Proof. (Of the ba1 rule) The (ba1) rule encodes the fact that addition is deterministic, and so commutes with copying. Begin by proving the rule for the special case in which $n = 1$:

$$\begin{aligned} \text{X-spider}(m) &\stackrel{2.2}{=} \sum_{j \in \mathbb{F}_q} |-j\rangle^{\otimes m} \langle j| \\ &= \text{Z-spider}(m). \end{aligned}$$

Then, from the fact that the x-spiders implement addition (2.3), and the fact that addition is deterministic, we have

$$\boxed{q^{\frac{n-1}{2}}} \text{X-spider}(n) \text{X-spider}(m) = \boxed{q^{\frac{(n-1)m}{2}}} \text{X-spider}(m)$$

Post-composing on both sides with x-spiders we have

$$\boxed{q^{\frac{n-1}{2}}} \text{X-spider}(n) \text{X-spider}(m) \text{X-spider}(m) = \boxed{q^{\frac{(n-1)m}{2}}} \text{X-spider}(m) \text{X-spider}(m)$$

Applying the special case rule for $n = 1$ to the left-hand-side, and simplifying, we get

$$\text{X-spider}(n) \text{X-spider}(m) \text{X-spider}(m) = \boxed{q^{\frac{(n-1)(m-1)}{2}}} \text{X-spider}(m) \text{X-spider}(m)$$

\square

Proof. (Of the ba2 rule) The (ba2) rule encodes the fact that multiplication is deterministic, and so commutes with copying. Since the inverse-Fourier transform is unitary, we just have to prove the equality after post-composing both sides with inverse-Fourier transforms. The left-hand-side becomes

$$\begin{aligned}
 & \text{Diagram 1} = \text{Diagram 2} \\
 & = \text{Diagram 3} \\
 & = \text{Diagram 4} \\
 & = \left(\sum_k | -k \rangle^{\otimes m} \langle k | \right) \circ (| -i_1 \cdot \dots \cdot i_n \rangle \langle i_1 | \dots \langle i_n |) \\
 & = \sum_{i_1, \dots, i_n} |i_1 \cdot \dots \cdot i_n \rangle^{\otimes m} \langle i_1 | \dots \langle i_n |
 \end{aligned}$$

While the right-hand-side becomes

$$\text{Diagram 5} = \sum_{i_1, \dots, i_n} |i_1 \cdot \dots \cdot i_n \rangle^{\otimes m} \langle i_1 | \dots \langle i_n |$$

□

Proof. (Of the pm rule) The (pm) rule is a special case of the fact that the Z-spider implements Schur product of states, and thereby serves as a product on the ring of phases R :

$$\begin{aligned}
 & \text{Diagram 6} = \sum_{j \in \mathbb{F}_q} r_1^{(1|j)} r_2^{(1|j)} |j \rangle \\
 & = \sum_{j \in \mathbb{F}_q} (r_1 r_2)^{(1|j)} |j \rangle \\
 & = \text{Diagram 7}
 \end{aligned}$$

□