

Wastewater-based Epidemiology for COVID-19 Surveillance and Beyond: A Survey

Chen Chen^{a,*}, Yunfan Wang^a, Gursharn Kaur^b, Aniruddha Adiga^b, Baltazar Espinoza^b, Srinivasan Venkatramanan^b, Andrew Warren^b, Bryan Lewis^b, Justin Crow^c, Rekha Singh^c, Alexandra Lorentz^d, Denise Toney^d and Madhav Marathe^{a,b}

^aDepartment of Computer Science, University of Virginia, Charlottesville, 22904, United States

^bBiocomplexity Institute and Initiative, University of Virginia, Charlottesville, 22904, United States

^cVirginia Department of Health, Richmond, 23219, United States

^dDivision of Consolidated Laboratory Services, Department of General Services, Richmond, 23219, United States

ARTICLE INFO

Keywords:
Wastewater
Epidemiology
Infectious disease
COVID-19
Survey

ABSTRACT

The pandemic of COVID-19 has imposed tremendous pressure on public health systems and social economic ecosystems over the past years. To alleviate its social impact, it is important to proactively track the prevalence of COVID-19 within communities. The traditional way to estimate the disease prevalence is to estimate from reported clinical test data or surveys. However, the coverage of clinical tests is often limited and the tests can be labor-intensive, requires reliable and timely results, and consistent diagnostic and reporting criteria. Recent studies revealed that patients who are diagnosed with COVID-19 often undergo fecal shedding of SARS-CoV-2 virus into wastewater, which makes wastewater-based epidemiology for COVID-19 surveillance a promising approach to complement traditional clinical testing. In this paper, we survey the existing literature regarding wastewater-based epidemiology for COVID-19 surveillance and summarize the current advances in the area. Specifically, we have covered the key aspects of wastewater sampling, sample testing, and presented a comprehensive and organized summary of wastewater data analytical methods. Finally, we provide the open challenges on current wastewater-based COVID-19 surveillance studies, aiming to encourage new ideas to advance the development of effective wastewater-based surveillance systems for general infectious diseases.

1. Introduction

The pandemic of COVID-19 has posed significant challenges to public health systems and the global economy, thereby urging the need for effective surveillance methods to monitor the prevalence of the disease within communities. Conventional surveillance methods are heavily dependent on clinical test data, such as positive test cases and hospitalizations. The inherent limitation of clinical data-based surveillance methods lies in their limited coverage, labor intensity, and data staleness due to prolonged test procedures. In order to estimate the prevalence of the disease and detect potential outbreaks in a more timely fashion, wastewater-based epidemiology (WBE¹) surveillance has been identified as complementary to clinical methods.

WBE has been successfully used for monitoring the use of pharmaceuticals (Bischel et al., 2015), illicit drugs (Zucato et al., 2008), flu prevalence (Heijnen and Medema, 2011), and polio outbreaks (Brouwer et al., 2018). Recent research suggests that monitoring the SARS-CoV-2 and other disease levels in wastewater can be a reliable way to understand the disease prevalence in addition to the clinical test results (Safford et al., 2022). Specifically, the wastewater samples can be collected from manholes in the targeted communities or from the wastewater treatment plants (WWTPs) in the sewersheds. The collected samples are then tested to quantify the concentration and the total load of the SARS-CoV-2 virus. The resulting viral concentration/load can be viewed as a comprehensive snapshot of disease prevalence within the community. By collectively analyzing the viral data from multiple timestamps, the trajectory of the disease may be estimated, which can be further used for trend projection. Figure 1 shows the overview of the wastewater-based epidemic surveillance system.

While a promising tool, wastewater-based COVID-19 surveillance and beyond is subject to some key limitations and challenges. The first challenge is the variability in viral shedding rates. Specifically, individuals of different symptom severity and age groups may contribute virus to the sewage system at significantly different rates, thus making it hard to approximate the infected population from wastewater viral load. Second, the wastewater viral load may get underestimated due to dilution in the sewer system, in-sewer transportation loss, degradation of the virus, and

*Corresponding author

chenannie45@gmail.com (C. Chen); yunf.wang@outlook.com (Y. Wang); fug3aj@virginia.edu (G. Kaur); aa5dw@virginia.edu (A. Adiga); be8dq@virginia.edu (B. Espinoza); sv8nv@virginia.edu (S. Venkatramanan); sasw3xp@virginia.edu (A. Warren); bl4zc@virginia.edu (B. Lewis); justin.crow@vdh.virginia.gov (J. Crow); rekha.singh@vdh.virginia.gov (R. Singh); alexandra.lorentz@dgs.virginia.gov (A. Lorentz); denise.toney@dgs.virginia.gov (D. Toney); marathe@virginia.edu (M. Marathe)

ORCID(s): 0000-0002-7423-0090 (C. Chen)

¹In this paper, our primary focus is on the surveillance perspective of WBE when using the term "WBE". All acronyms that appear more than once in the paper are summarized in Appendix Table 5.

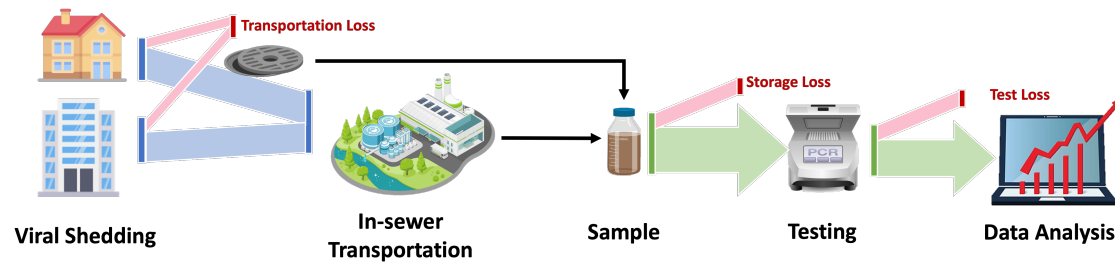

Figure 1: Overview of Wastewater-based Epidemiology Surveillance System.

also the test procedures used. Such loss is inevitable and could lead to missed cases or delayed alerts for outbreaks. On the other hand, the sewershed population, wastewater flow variations, and sample methods may also affect the representativeness of the viral level in the test sample to the disease prevalence of the entire community. Therefore, approximating the actual viral load that flows into the sewage system from degraded signals requires careful modeling and analysis. The last challenge is the integration of wastewater analysis with conventional surveillance results (e.g. reported cases, hospitalization). Wastewater-based surveillance data provides a comprehensive snapshot of disease prevalence within the whole community but with potentially considerable degradation. In contrast, conventional surveillance results are accurate but only cover a limited portion of the infected population. Effectively combining the two data sources can be problematic as the studied populations are not well aligned.

In this paper, we survey the current literature that encompasses critical facets of wastewater-based surveillance for COVID-19, including wastewater sampling techniques, sample testing methodologies, data analysis methods, available datasets at the global level, and the extension to other infectious diseases. Furthermore, we highlight the ongoing challenges in the wastewater-based COVID-19 surveillance systems and hope to inspire continued innovation and development in the domain. It is worth mentioning that the data analytic methods for COVID-19 can be easily generalized to the surveillance tasks for other infectious diseases summarized in Kilaru et al. (2023).

Differences with Existing Surveys. Existing surveys on wastewater-based COVID-19 surveillance are predominantly focused on sampling methods, virus detection and quantification, and surveillance system design (Sharara et al., 2021; Polo et al., 2020; Shah et al., 2022; Hamouda et al., 2021). In Ciannella et al. (2023); Li et al. (2023c), the two surveys have covered the correlation analysis between viral concentration and clinical test results, but the studies are not comprehensive enough to cover all the critical aspects of the analysis (e.g., sample type, sample frequency, correlation metrics). To the best of our knowledge, this is a thorough survey that focuses on summarizing the state-of-the-art analytical methods used in wastewater-based COVID-19 surveillance and beyond.

Survey Structure. The remainder of this survey is organized as follows, Section 2 and Section 3 briefly introduce the current advances in wastewater sampling and sample testing. Section 4 covers different aspects of wastewater analytic methods. Section 5 provides a comprehensive list of wastewater datasets for SARS-CoV-2 surveillance. Section 6 discusses the current limitations and challenges of wastewater-based COVID-19 surveillance systems, and Section 7 concludes the survey.

2. Literature Collection and Organization

Following the guidance of the Preferred Reporting Items for Systematic Reviews and Meta-Analyses (PRISMA) method proposed by Page et al. (2021), we conduct the systematic literature review (SLR).

2.1. Literature Searching Methods

Before initiating the systematic research collection, we carried out an unstructured exploration of some commonly used terms and ideas concerning the topic. Keywords such as "wastewater", "epidemiology", "WBE", "COVID-19/SARS-CoV-2", "analysis", "modeling", and "surveillance" were commonly used to identify records of peer-reviewed articles in the multidisciplinary literature.

Based on the previous research review, we chose the following databases for our search:

- Web of Science: www.webofscience.com
- Scopus: www.scopus.com
- Engineering Village: www.engineeringvillage.com
- PubMed: www.pubmed.ncbi.nlm.nih.gov

We divided the wastewater-based COVID-19 surveillance problem into two phases for a full-extent study: data collection and data analysis. The data collection part includes sampling, data acquisition and pre-processing, quantification and normalization, etc. The data analysis part includes the analytical models for the WBE data. We conducted two separate searches on the database, each using different search phrases as indicated in Table 1. Such search settings are designed to return as many topic-related results as possible. After that, we filtered and de-duplicated the results to do further analysis.

Table 1
Literature searching settings.

	Boolean operator	Keywords
Data Collection		COVID OR SARS-CoV-2
	AND	wastewater sample
	AND	virus OR viral
	AND	sampl* OR detect*
	AND	RNA OR ribonucleic acid OR genet*
	AND	"procedure" OR "protocol" OR method* OR quantif* OR estimat* OR measur* *pcr*
Data Analysis		COVID OR SARS-CoV-2
	AND	"wastewater-based epidemiology" or WBE
	AND	surveill* OR monitor* OR track*
	AND	predict* OR forecast* OR foreshadow* OR trend
	AND	analy* OR statisti* OR model* OR correlate* OR relation*

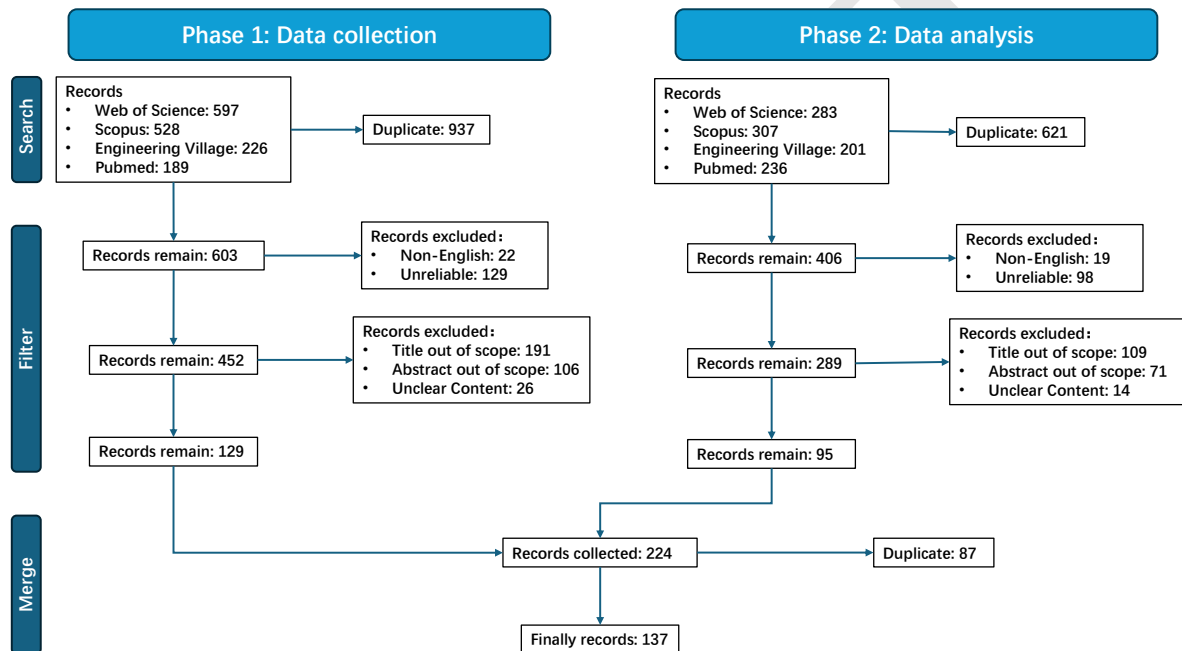

Figure 2: Publication selection process: PRISMA-based flowchart.

2.2. Filtering and Selection

The criteria provided in Table 1 were used to search the four literature databases in the time range from January 2020 to October 2023. From an initial total of 2,567 discovered literature records, we first utilized Zotero to detect duplicate records individually for each search. Next, we applied language filters to choose only English publications. To ensure the reliability of the selected studies, we only keep original, peer-reviewed articles in our results, leaving out other publishing forms like reviews, short communications, technical reports, letters, notes, abstracts, and surveys. Any work that was accessible yet unpublished was also disqualified. After that, we screened the content and selected the literature that is closely related to the perspective of this study based on the article titles and abstracts, and finally, we got 137 related articles. The detailed process and outcome are shown in Figure 2.

3. Wastewater Sampling

Sampling is a critical step for wastewater-based COVID-19 surveillance, which defines the surveillance scope for the disease. In particular, sampling through the sewage can effectively monitor the viral level at a community level or building level; while sampling at the wastewater treatment plant can estimate the infection level at the sewershed level. In addition to the sample location, sample frequency, sample type, and sample method may also affect the effectiveness of disease surveillance and prevalence estimation. This section summarizes the key findings for the above three aspects of wastewater sampling.

Sample Frequency. WBE is an important tool in monitoring the prevalence of SARS-CoV-2 in the community. Depending on the goal of surveillance, sampling frequency can vary. To screen for the presence of the virus, sampling once per week may be sufficient. To identify infection trends,

Table 2

Comparison between sampling methods.

	Advantages	Limitations
Grab Sampling (One-time sample)	<ul style="list-style-type: none"> • Fast and simple data gathering satisfies the time-sensitive surveillance needs. • Easy to implement due to its simplicity. 	<ul style="list-style-type: none"> • Unable to capture temporal variations and may lead to misrepresentation.
Composite Sampling (Pool of samples)	<ul style="list-style-type: none"> • Collecting and averaging multiple samples over a period provide a more representative picture of viral load. • Reducing the risk of missing short-term fluctuations leading to more reliable estimates. 	<ul style="list-style-type: none"> • Complexity of implementation due to its requirement of sophisticated equipment and more human efforts. • The degradation of the virus RNA over time can affect the accuracy of the results.
Passive Sampling (Accumulation)	<ul style="list-style-type: none"> • Less labor-intensive and more cost-effective. Easy to deploy and retrieve, suitable for remote or difficult-to-access locations. • Time-integrated sampling can give a more comprehensive picture of viral prevalence. 	<ul style="list-style-type: none"> • Careful calibration and standardization are needed to eliminate the errors caused by the difference in sampling devices and environmental conditions. • The flow rates and other physical factors can result in potential bias.

at least three sampling points within a trend period of interest are needed. The National Wastewater Surveillance System (NWSS) suggests using a 15-day surveillance window for trend reporting (CDC).

Sample Type. Wastewater can be sampled both from sewer systems such as sewage networks and wastewater treatment facilities, and non-sewered systems such as rivers and canals. As the virus concentration in non-sewered systems can be strongly affected by environmental factors, it is hard to make meaningful comparisons between samples collected under different environmental conditions. Therefore, most of the existing wastewater studies tend to focus on samples collected from treatment facilities as shown in Table 4. The wastewater samples collected from sewer systems can be categorized into two different types: (1) untreated wastewater from upstream sewage networks like manholes or treatment plant influent, and (2) treated wastewater from primary sludge in the treatment plant after the first solids removal stage. The advantage of using untreated wastewater from the upstream network or influents is that it can reflect fine-grained viral levels in targeted communities (Layton et al., 2022; Cohen et al., 2022; Rondeau et al., 2023). However, most untreated wastewater samples need to be concentrated prior to viral extraction. For the treated wastewater samples from primary sludge, the concentration step can be eliminated but the viral level in the sample can only be used to evaluate the disease prevalence in the entire sewershed.

Sample Method. To collect wastewater samples, there are three commonly used methods: grab, composite and passive sampling. The grab method collects a fixed amount of wastewater at a certain time. The composite method collectively pools multiple grab samples over a certain period of time. While the passive sampling method places devices in wastewater streams to accumulate contaminants without the need for continuous manual intervention.

In Gerrity et al. (2021), a wastewater study in Southern Nevada showed that the SARS-CoV-2 concentration in the composite sample is 10× higher than the early-morning

grab samples. In Augusto et al. (2022), a similar study was conducted to evaluate the variability of SARS-CoV-2 RNA concentration in grab and composite samples from both wastewater treatment plants and sewer manholes in Brazil. Their study showed no significant difference between the viral concentrations of the grab and composite samples. In particular, the concentrations of composite samples showed greater agreement with concentrations of grab samples collected between 8 a.m. to 10 a.m. The low variability between the two types of samples was also observed in a study at a wastewater treatment plant in Norfolk, Virginia (Curtis et al., 2020). However, the variability may get amplified when calculating the daily viral load (viral load = viral concentration × daily influent flow) from the viral concentrations. Based on previous studies' experience, we summarize the advantages and limitations of different sample methods in Table 2. Moreover, according to the literature we reviewed, we provide a sampling method selection guideline by considering different factors in real applications as shown in Figure 3.

4. Sample Testing

Sample testing aims to estimate the viral concentration from the wastewater samples, which directly affects the usefulness of downstream data analytic models. Generally, the testing step includes sample pre-processing and virus detection/quantification. To account for the viral loss in the testing step, some lab control methods were introduced to the process. Recent studies suggest that the tested viral concentration should also be normalized with the population served by the sewer system. Correspondingly, different normalization methods were incorporated into the virus quantification model. In this section, we summarize the key advances in sample pre-processing, virus detection and quantification, lab control methods, and normalization methods.

Sample Pre-processing. The wastewater samples need to be properly processed before being tested. The purpose

Factor Method	Objective of the surveillance	Population Size and Diversity	Resource Availability	Data Accuracy and Reliability
Grab	<ul style="list-style-type: none"> Rapid situation assessment; Short-term forecasting 	<ul style="list-style-type: none"> Small 	<ul style="list-style-type: none"> More resources needed 	<ul style="list-style-type: none"> Normal demand
Composite	<ul style="list-style-type: none"> Understanding spatial, social and temporal variability; Long-term monitoring 	<ul style="list-style-type: none"> Large 	<ul style="list-style-type: none"> More resources needed 	<ul style="list-style-type: none"> Higher demand
Passive	<ul style="list-style-type: none"> Variant detection; Broadly detecting the early occurrence; Long-term monitoring 	<ul style="list-style-type: none"> Large 	<ul style="list-style-type: none"> Limited 	<ul style="list-style-type: none"> Normal demand

Figure 3: The guidance of sampling method selection. Each column represents a condition to be considered and each box indicates which sampling method we should choose under given circumstances.

of sample pre-processing is to remove solids (Jmii et al., 2021) and inactivate virus/bacteria (Reynolds et al., 2022). To remove the solids from the sample, centrifugation, and filtration can be performed. Specifically, the filtration needs to be done with large pore sizes ($5\mu\text{m}$ or larger) per CDC's guidance (CDC). In Yanaç et al. (2022), the authors suggested that SARS-CoV-2 RNA might predominate in solids. Therefore, concentration methods focusing on both supernatant and solid fractions may perform better for virus recovery. For the viral inactivation, effective procedures include thermal treatment (Calderón-Franco et al., 2022; McMinn et al., 2021), UV light (Castiglioni et al., 2022; Pellegrinelli et al., 2022) or chemical treatment (Tomasino et al., 2021). Another key step before sample testing is sample concentration, which can help with the detection of SARS-CoV-2 RNA. The concentration step is particularly helpful for untreated wastewater samples as compared to the treated samples as mentioned in the previous section. Effective concentration approaches include ultrafiltration (Dumke et al., 2021; Hasing et al., 2021), filtration through electronegative membrane (Barril et al., 2021; Jmii et al., 2021), centrifugal ultrafiltration (Anderson-Coughlin et al., 2021), ultracentrifugation (Zheng et al., 2022), polyethylene glycol (PEG) precipitation (Alexander et al., 2020; Farkas et al., 2021), skim milk flocculation (Pino et al., 2021; Philo et al., 2021), and aluminum flocculation (Pino et al., 2021; Salvo et al., 2021).

Virus Detection and Quantification. With proper pre-processing and concentration, the wastewater sample is then ready to be tested for SARS-CoV-2 RNA detection and quantification. The key step for the method is to quantify the targeted genetic materials (i.e., SARS-CoV-2 N1, N2 and E genes (Lu et al., 2020; Corman et al., 2020)) with the polymerase chain reaction (PCR). The main step for the PCR test is using special chemicals and enzymes to amplify the targeted genetic materials in cycles. Once the target genes are amplified, they become detectable by lab methods and can be further interpreted to get the viral concentration

in the sample. The most common way for RNA detection and quantification is polymerase chain reaction (PCR)-based quantification (Ni et al., 2021). In practice, there are different PCR procedures used for SARS-CoV-2 RNA quantification, including RT-LAMP (reverse transcription loop-mediated isothermal amplification) (Amoah et al., 2021), RT-qPCR (reverse transcription-quantitative polymerase chain reaction) (Ahmed et al., 2020a), variations of RT-qPCR (La Rosa et al., 2020; Navarro et al., 2021), and RT-ddPCR (RT-droplet digital PCR) (Flood et al., 2021). In addition to the viral concentration, the number of amplification cycles used to detect the target genes (i.e., the C_t value) can also be used as a criterion to quantify the viral load. Specifically, the lower the C_t value, the greater the amount of viral RNA present in the original sample and vice versa.

Calibration. The amount of SARS-CoV-2 virus in the wastewater sample is subject to loss during the sample pre-processing and testing steps. The lost amount may vary by sample quality and testing methods. To assess the lost amount during the process, a frequently used calibration method is matrix recovery control. A matrix recovery control is a virus that is biologically similar to SARS-CoV-2. Some commonly used control viruses include murine coronavirus (also called murine hepatitis virus), bacteriophage phi6, Pepper Mild Mottle virus (PMMoV), bovine coronavirus, bovine respiratory syncytial virus, and human coronavirus OC43 (Ahmed et al., 2020b; Torii et al., 2022; Hata et al., 2020; LaTurner et al., 2021; Nagarkar et al., 2022). Specifically, the matrix recovery control is spiked into the wastewater sample at a known concentration prior to the pre-processing step. The concentration of the control virus will be tested again after the testing step. The ratio of the virus concentrations before pre-processing and after testing can be used to estimate the recovery rate of the SARS-CoV-2 virus during the entire procedure. **Normalization.** To enable the comparison of viral concentrations across locations and over time, the raw concentrations often need to be normalized by the daily wastewater flow and the

population served by the sewer system. As the number of people contributing to the sewershed may vary over time due to factors like tourism and commuting, it is critical to utilize human fecal normalization to account for such changes.

Human fecal normalization aims to estimate the human fecal content by targeting the organisms that are specific to human feces. Commonly used fecal indicator viral molecular targets include Pepper Mild Mottle virus (PM-MoV) and crAssphage (Rosario et al., 2009; Wilder et al., 2021). In D'Aoust et al. (2021b), it was shown that PM-MoV RNA is relatively stable under different environmental conditions and therefore can boost the correlation between viral signals and COVID-19 cases. The bacterial molecular targets include *Bacteroides* HF183 and *Lachnospiraceae* Lachno3 (Seurinck et al., 2005; Feng et al., 2018).

Quality Control and Quality Assurance Quality control (QC) and quality assurance (QA) are critical for ensuring the reliability and accuracy of WBE data for COVID-19 surveillance, which should be employed at every step of the process. Standardized sample collection techniques are the first step in the protocol, which could reduce variability and eliminate contamination. Every sample batch is subjected to stringent quality control measures, such as the use of non-template controls to identify contamination, positive controls to verify assay sensitivity, extraction controls to verify the effectiveness of nucleic acid isolation, and processing blanks to monitor for procedural contamination (Flood et al., 2021; de Freitas Bueno et al., 2022; Flood et al., 2023). In (WRF, 2020), the Water Research Foundation (WRF) provided a checklist for QC and QA during the method development process. In particular, the validation of the assay should include (1) initial precision and recovery controls; (2) matrix spike; (3) estimate of the limit of detection and limit of quantification; and (4) reporting of the equivalent volume of sample analyzed. Once an assay has been developed and validated, the minimally acceptable QA/QC standards for every assay include (1) detection assay controls; (2) ongoing precision recovery; (3) reporting of the equivalent volume of sample analyzed; and (4) periodic matrix control spikes. On the other hand, to maintain data consistency throughout the analytical phase, routine proficiency testing, calibration, and maintenance should be conducted for all equipments. What is more, comprehensive training programs for personnel, detailed documentation of procedures, and continuous monitoring and evaluation to facilitate ongoing improvements should be included in the QC/QA framework to make sure that the WBE data is reliable and robust.

5. Data Analytics for Wastewater-based COVID-19 Surveillance

In this section, we review the current literature on wastewater data analytic methods from four perspectives, which include viral shedding studies, correlation analysis, estimation models, and uncertainty analysis. Specifically for the estimation models, we divide the current methods

into model-driven methods and data-driven methods. The organization of this section is illustrated in Figure 4.

5.1. Viral Shedding Studies

The existing viral shedding studies are focused on quantifying the amount of SARS-CoV-2 virus in different types of human waste from infected individuals² and the shedding duration of the virus.

Shedding Amount. Gupta et al. (2020) reviewed the literature describing COVID-19 patients tested for fecal virus. The review shows that only 53.9% of the infected individuals tested for fecal RNA were positive. A more detailed study was conducted in Jones et al. (2020), which suggests that the SARS-CoV-2 RNA can be detected not only in feces but also occasionally in urine. The likelihood of SARS-CoV-2 being transmitted via feces or urine appears much lower due to the lower relative amounts of virus present in feces/urine. Consequently, the likelihood of infection due to contact with sewage-contaminated water (e.g. swimming, surfing, angling) or food (e.g. salads, shellfish) is extremely low or negligible based on very low abundances and limited environmental survival of SARS-CoV-2. Similar findings were also discovered in Wölfel et al. (2020), where a virological assessment of hospitalized patients with COVID-19 was conducted. Their study indicates that the infectious SARS-CoV-2 virus is exclusively derived from throat or lung samples, but never from blood, urine, or stool samples.

To calibrate the shedding rate of infected individuals, Schmitz et al. studied the WBE for SARS-CoV-2 by enumerating the asymptomatic COVID-19 cases in a university campus (Schmitz et al., 2021). The study found that 79.2% of SARS-CoV-2 infections were asymptomatic and only 20.8% were symptomatic. To calculate the shedding rate, positive detected cases from the day before, day-of, and four days after sampling were included in the count of infected individuals contributing to viral shedding. The results showed that the mean fecal shedding rate by the N1 gene was $7.30 \pm 0.67 \log_{10} \text{ gc/g-feces}$ (log gene copies per gram-feces).

In addition to the general shedding study on infected individuals, a later study was conducted to explore the association between patient ages and viral shedding amount based on the data from two wastewater sites in Massachusetts (Omori et al., 2021). Specifically, the viral load in wastewater was modeled as a combination of viruses contributed by different age groups. By incorporating the case count delay, the wastewater viral load was fitted with the daily case count by different age groups. The results indicate that the virus contribution rate of patients from the 80+ yr age group can be 1.5 times larger than the corresponding rate of patients from the 0–19 yr age group.

Shedding Duration. A study from Gupta et al. (2020) suggests that the duration of fecal viral shedding mostly ranges from 1 to 33 days after a negative nasopharyngeal swab. Similar findings were also reported in Wu et al. (2020). Moreover, Wölfel et al. (2020) reveals that fecal

²In the context of this paper, "cases" and "infected individuals" have the same meaning and can be used interchangeably.

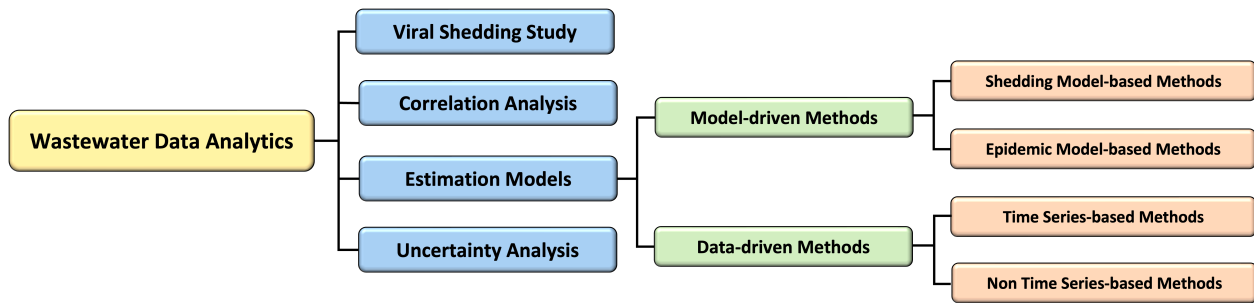

Figure 4: The overview of wastewater data analytics.

virus shedding peaks in the symptomatic period, and declines in the post-symptomatic phase. Miura et al. (2021) modeled the viral shedding kinetics with the collected data under the Bayesian framework. In particular, the duration of viral shedding and the concentration of virus copies in feces over time are jointly estimated. The results showed that the median concentration of SARS-CoV-2 in feces was 3.4 (95% CrI³: 0.24–6.5) log gc/g-feces over the entire shedding period, and the duration of viral shedding is 26.0 days (95% CrI: 21.7–34.9) from symptom onset date.

5.2. Correlation Analysis

The correlations between the wastewater viral level and the clinical data (e.g. cases, hospitalization, death) are extensively studied in the current literature. A detailed summarization of correlation studies can be found in Appendix Table 4. To evaluate the correlation between viral data and clinical data, several different correlation metrics are used in the current literature, which include Pearson correlation, R^2 for the linear regression model, Spearman's rank correlation, and Kendall's τ correlation. Specifically, the Pearson correlation evaluates the strength and direction of the linear relationship between the clinical data and wastewater level, which can be sensitive to noisy data points or outliers. The R^2 is used to illustrate how much of the variance in the dependent variable can be predicted from the independent variables. Particularly, higher R^2 values indicate that the clinical data can be well-fitted by wastewater viral data with a linear relationship. To relax the correlation from linear constraints, Spearman's rank correlation is used to evaluate the rank consistency between the two data series. Similarly, Kendall's τ correlation is also occasionally used to solve the small sample size problem and the tied values problem, which is defined by the concordance of data pairs. Here, we summarize the key findings from the correlation analysis.

Influential Factors for Correlation. The correlation strength between wastewater viral data and clinical data can be affected by many factors. Li et al. (2023c) conducted a systematic review and meta-analysis on the correlation between SARS-CoV-2 RNA concentration and COVID-19 cases. The review suggested that the correlation coefficients are potentially affected by environmental factors (e.g. temperature, humidity), epidemiological conditions (e.g. vaccination

rate, clinical test coverage), WBE sampling design (e.g. sampling method and frequency), and catchment population (e.g. human mobility, demographics of inhabitants) (Li et al., 2023c; Jiang et al., 2022; Rasero et al., 2022; Kuhn et al., 2022; Pillay et al., 2021). In particular, larger variations in air temperature and clinical testing coverage, and the increase of catchment size have strong negative impacts on the correlation between viral concentration and COVID-19 cases. The sampling techniques have a negligible impact on the correlation but increasing the sampling frequency can improve the correlation. Moreover, extensive correlation studies suggested that the correlation between viral concentration and new cases (either daily new or weekly new cases) is stronger than that of active cases and cumulative cases. Also, as the shedding duration of the SARS-CoV-2 virus can be as long as several weeks, the correlations between wastewater viral data and reported cases are often stronger in the pre-peak phase than in the post-peak phase (Róka et al., 2021). Normalizing viral data with fecal indicators can also improve the analysis (Róka et al., 2021; Scott et al., 2021; Tandukar et al., 2022; Nagarkar et al., 2022; D'Aoust et al., 2021a,b; Perez-Zabaleta et al., 2023; Mohapatra et al., 2023). In addition to the aforementioned factors, the availability of home test kits has significantly affected the correlation between wastewater viral data and clinical data. Varkila et al. (2023) analyzed the time series of 268 counties in 22 states from January to September 2022. The study showed that SARS-CoV-2 wastewater metrics accurately reflected high clinical rates of disease in early 2022, but this association declined over time as home testing increased.

Varying Lag Time. Aside from the correlation strength, many existing correlation studies also investigated the lag time between clinical data and wastewater viral load. In most cases, the viral load in wastewater is a leading indicator for clinical data, with leading time ranging from 1 day to 2 weeks during peak times considering the time-lag between infection and test confirmation, and asymptomatic infections (Yanaç et al., 2022; Lemaitre et al., 2020). However, the viral load may become a lagging indicator during the infection declining phase due to prolonged viral shedding duration (Gerrity et al., 2021). On the other hand, the lag time for different clinical data types may follow different distributions as well. In general, the lag times of positive tests are shorter than the hospitalization admissions. The lag of

³CrI: Credible Interval.

hospitalization is further shorter than the death cases (Peccia et al., 2020; D'Aoust et al., 2021a; Krivoňáková et al., 2021).

It is worth mentioning that the lag time may vary significantly by time, location, and catchment population due to the variant accessibility of testing resources and epidemiological conditions of the population (Zhao et al., 2022; Kuhn et al., 2022; Bertels et al., 2023; Acosta et al., 2022; López-Peñalver et al., 2023; Belmonte-Lopes et al., 2023). For example, as the pandemic progressed, many countries have improved their testing infrastructure and reporting systems, leading to more rapid and reliable clinical data. Consequently, the reduction in report delays effectively shortened the lag time observed in WBE studies. However, in the endemic stage, where cases may be underreported due to the availability of home-test kits and reduced report efforts, the correlation between viral loads in wastewater and reported clinical cases has become less robust.

Correlation with Estimated Prevalence. In some areas, the wastewater viral data was used to estimate the disease prevalence in the sewersheds by leveraging the personal shedding rate and Monte Carlo simulations (Wang et al., 2021; de Freitas Bueno et al., 2022). The estimated prevalence was found to be significantly higher than the reported clinical cases in the area due to asymptomatic cases and unreported cases. To thoroughly understand the gap between disease prevalence and reported cases, Layton et al. performed randomized door-to-door nasal swab sampling events in different Oregon communities to infer the community COVID-19 prevalence (Layton et al., 2022). The estimated prevalence data was then compared with the reported positive cases and the wastewater concentration in the community. Statistical results show that the wastewater viral concentrations were more highly correlated with the estimated community prevalence than with clinically reported cases. Similar results were also observed in Claro et al. (2021); Pillay et al. (2021); González-Reyes et al. (2021); de Sousa et al. (2022); Saththasivam et al. (2021).

5.3. Estimation Models

5.3.1. Model-driven Methods

Shedding Model-based Methods. The key idea for shedding model-based estimation methods is to directly use viral concentration/load and human shedding profiles to estimate the total infected population. The pioneer work was proposed in Ahmed et al. (2020a, 2021), which studied the WBE for SARS-CoV-2 in Australia. In particular, the prevalence of SARS-CoV-2 in the sewershed was estimated using the following formula:

$$I = \frac{c * f}{p * s} \quad (1)$$

with

$$\begin{aligned} c &= \frac{\text{RNA copies}}{\text{liter wastewater}} & f &= \frac{\text{liter wastewater}}{\text{day}} \\ p &= \frac{\text{gram feces}}{\text{person per day}} & s &= \frac{\text{RNA copies}}{\text{gram feces}} \end{aligned} \quad (2)$$

where the infected population I is derived from the viral concentration c , wastewater flow rate f , fecal production rate p , and fecal shedding rate s . The uncertainty and the variability of the independent variables were approximated using a Monte Carlo approach, which yielded a reasonable result that agrees with the clinical observations. Similar analysis was also applied in Brazil (Claro et al., 2021; de Sousa et al., 2022), South Africa (Pillay et al., 2021), Mexico City (González-Reyes et al., 2021), Tehran (Amereh et al., 2022), Winnipeg (Yanaç et al., 2022), Southern Nevada (Gerrity et al., 2021), Denmark (Nauta et al., 2023), and Qatar (Saththasivam et al., 2021). The simple shedding model in Equation 1 can be easily modified to account for the viral decay (Yanaç et al., 2022), the variability on shedding load, the infection-to-confirmation case delay (Fernandez-Cassi et al., 2021), and urine viral shedding (Pillay et al., 2021) scenarios. In de Sousa et al. (2022), the model is further developed into a user-friendly web application, pySewage (de Sousa et al.), to predict the number of infected people based on the detected viral load in wastewater samples, which may be applied to monitor ongoing outbreaks.

Epidemic Model-based Methods. Another line of model-driven methods is to fit the wastewater data into epidemiological models like the susceptible-exposed-infectious-recovered model (SEIR-model (Anderson and May, 1979)) to infer the dynamics of the disease. The framework was first proposed in McMahan et al. (2021). Specifically, the framework assumes that the spread of COVID-19 follows the SEIR model and that the viral load in wastewater is solely contributed by the infected population as illustrated in the left panel of Figure 5. Let $V_{ij}(t)$ denote the virus shed by individual i on day t , who become infected on day j , then $V_{ij}(t)$ can modeled by a simple equation below

$$\begin{aligned} V_{ij}(t) = \delta_{ij} \{ & 10^{\frac{\phi_{ij}(t-j)}{5}} I(j < t \leq 5 + j) \\ & + 10^{\psi_{ij} \frac{-(\phi_{ij}-\psi_{ij})(t-5-j)}{5}} I(t > 5 + j) \} \end{aligned} \quad (3)$$

where δ_{ij} is the number of grams of feces contributed by the i th individual who was infected on the j th day, ϕ_{ij} is the \log_{10} maximum RNA copies per gram of feces being shed, and ψ_{ij} is the \log_{10} RNA copies per gram of feces being shed 25 days after being infected. To further account for viral decay in the sewage system, a holding time and system temperature-dependent decay model is applied to V_{ij} to approximate the viral loss in the collected samples. The proposed framework was fitted into the wastewater surveillance data in South Carolina from May 2020 to August 2020. The model prediction reveals that the rate of unreported COVID-19 cases was approximately 11 times than that of confirmed cases, which aligns well with the independent estimation of the ascertainment rate in South Carolina. Following the same framework, McMahan et al. propose to calibrate the SEIR model within a small community for fine-grained analysis (McMahan et al., 2022). The study was carried out on a university campus by analyzing the viral RNA copy

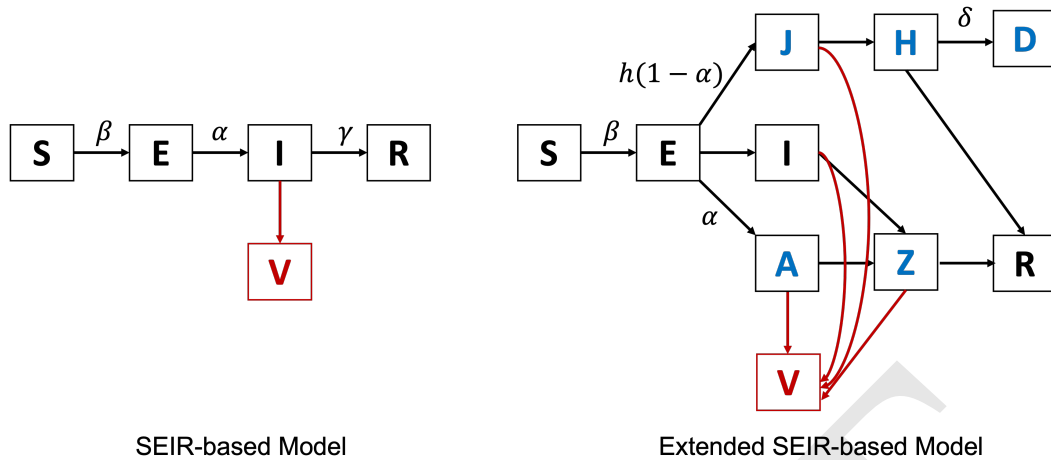

Figure 5: The SEIR model and extended SEIR model used in the current literature.

rates in sewage and the number of SARS-CoV-2 saliva-test-positive individuals among students (McMahan et al., 2022). A strong correlation was observed between the RNA copy rates and the number of infected individuals. The study also suggested that the most sensitive parameter in calibrating the SEIR model is the maximum shedding rate. Regressing the saliva-test-positive infected individuals on predictions from the SEIR model based on the RNA copy rates yielded a slope of 0.87, which further demonstrated the effectiveness of the proposed framework. In Phan et al. (2023), Phan et al. extended the framework to incorporate the effect of temperature on viral loss into the model. The extended model was tested on the wastewater data in the Greater Boston Area from October 2020 to January 2021. The results showed that the model can successfully recapitulate the temporal dynamics of viral load in wastewater and predicted the true number of cases peaked earlier and higher than the number of reported cases by 6–16 days during the second wave of the pandemic in the area.

Directly inferring the SEIR model from the viral load in wastewater may yield unstable results due to noisy viral fluctuations. To address this issue, some statistical models were explored to reconstruct the epidemic model. Fazli et al. (2021) proposed to utilize the partially observed Markov processes model (POMP (King et al., 2016)) to infer the population in S, E, I, R compartments respectively from the observed viral load and reported cases. Depending on the usage of observed data, three different variants were derived from the framework, which includes "SEIR-VY", "SEIR-V" and "SEIR-Y". Specifically, model "SEIR-VY" uses both viral load and case counts to fit the parameters, whereas model "SEIR-Y" and "SEIR-V" utilizes only case counts and viral load, respectively. The evaluation results demonstrated that a simple SEIR model based on viral load data can reliably predict the number of infections in the near future. Another direction of the study was to use the extended Kalman filter (EKF (Kalman, 1960)) to reconstruct the SEIR model (Proverbio et al., 2022). The proposed framework

was used to infer shedding populations, the effective reproduction number, and future epidemic projections. The framework was tested on the wastewater data from different regions. The results showed that the inferred case number is well correlated with the true detected case numbers with correlation coefficients ranging between 0.7 and 0.9. The study also validated that frequent sampling improves the model calibration and the subsequent reconstruction performance.

The limitation of the previously mentioned SEIR-based framework is that it assumes all the infected individuals follow the same shedding model. In reality, the shedding models of asymptomatic infections and hospitalized infections may vary significantly from each other. To address this issue, Nourbakhsh et al. presented an extended SEIR model as illustrated in the right panel of Figure 5 (Nourbakhsh et al., 2022). Specifically, the infected individuals are further categorized into four subgroups: infection (I), infectious and later admitted to hospital (J), asymptomatic infectious (A), and hospitalized (H). Furthermore, considering some recovered cases may still shedding virus through feces, the recovered group is also divided into two subgroups: non-infectious but still shedding virus (Z) and recovered (R). The model was fitted by the clinical data (both hospitalization and confirmed cases) from three Canadian cities and has provided good estimation on actual prevalence, effective reproduction number, and future incidences. In addition, the model was also used to perform exploratory simulations to quantify the effect of surveillance effectiveness, public health interventions, and vaccination on the discordance between clinical and wastewater data.

The aforementioned frameworks are predominately based on single-strain epidemic analysis, which cannot effectively deal with the spread dynamics of multiple strains. Pell et al. (2023) presented a four-dimensional modified SIR model to study disease dynamics when two strains are circulating in the population. The study was applied to understand the emergence of the SARS-CoV-2 Delta variant in the presence of the Alpha variant using the wastewater data from

Massachusetts. In the model, a time delay is incorporated to account for temporary cross-immunity induced by the previous infection with the established (or dominant) strain. The study finds that the time delay does not influence the stability of equilibrium and is hence a harmless delay. However, the equilibrium is governed by the basic reproduction numbers of the two strains in nontrivial ways due to the inclusion of cross-immunity.

5.3.2. Data-driven Methods

Time Series-based Methods. In exploiting the predictive power of the wastewater data from a data-driven perspective, some time series-based methods have demonstrated their effectiveness in short-term forecast tasks. Karthikeyan et al. (2021) experimented with the multivariate autoregressive integrated moving average (ARIMA) model to predict the number of new positive cases from the historical case data, wastewater data, and sample collection date in San Diego from July to October 2020. Specifically, the model was used for 1-week to 3-week advance case predictions. To evaluate the model, the Pearson correlation r between the observed cases and predicted cases and the Root Mean Squared Error ($RMSE$) of predicted cases were calculated. For the 1, 2, and 3-week advance forecast tasks, the correlation coefficient and $RMSE$ were $r = 0.79, 0.69,$ and 0.47 and $RMSE = 50, 59,$ and $70,$ respectively.

In Cao and Francis (2021), a vector autoregression (VAR) model was utilized to predict new cases from historical cases and viral concentration in Indiana (PA) from April 2020 to February 2021. The Mean Average Percentage Error (MAPE) for 1-3 week case predictions were 11.85%, 8.97% and 21.57%, respectively. The study suggests that short time series can reliably predict cases 1-week ahead but are not adequate for predicting cases 3 weeks ahead. To improve the robustness of long-term prediction tasks, a longer time series is needed. Moreover, the paper also studied whether different representations of viral data would affect the prediction results. Their study shows that the log-scaled representation of viral concentration has the best interpretation ability of the data, while the original viral concentration has a stronger forecasting ability under the VAR model framework.

The ARIMA model and VAR model were systematically compared in a wastewater surveillance study in Detroit from September 2020 to August 2021 (Zhao et al., 2022). The study showed that the autoregression model with seasonal patterns (SARIMA) and the VAR model are more effective in predicting COVID-19 incidence compared to the ARIMA model. Specifically, the correlation between VAR predicted cases and observed cases is around 0.95 to 0.96 for the 1-week advance forecast task. Similarly, the correlation for the SARIMA-model is around 0.94 to 0.95. While for the ARIMA model, the correlation is only around 0.4 to 0.67.

Another line of time series-based methods is derived from the spatiotemporal methods, which take both spatial information of sewersheds and temporal information of viral load into account in the estimation model. Li et al.

(2023a) proposed a spatially continuous statistical model that quantifies the relationship between viral concentration and a collection of covariates including socio-demographics, land cover and virus-associated genomic characteristics at the sewersheds while accounting for spatial and temporal correlation. The model is used to predict the weekly viral concentration at the population-weighted centroid of the 32,844 Lower Super Output Areas (LSOAs) in England, then aggregate these LSOA predictions to the Lower Tier Local Authority level (LTLA). In addition, the model is also used to quantify the probability of change directions (decrease or increase) in viral concentration over short periods.

Non-time Series-based Methods. A wide range of regression models have been applied to the wastewater data for case prediction due to the ease of implementation and explainability. The simplest regression model assumes that the number of cumulative cases at time $t + \tau$ is linearly related to the viral concentration at time t , and has demonstrated its effectiveness for short-term case prediction (Joseph-Duran et al., 2022). Li et al. (2023b) applied the random forest model to predict COVID-19-induced weekly new hospitalizations in 159 counties across 45 states in the United States of America (USA). In particular, different models were established to predict three different hospitalization indicators: weekly new hospitalizations, census inpatient sum, census inpatient average. For each hospitalization indicator, a variety of features, such as Community Vulnerability Index (Smittenaar et al., 2021), vaccination coverage, population size, weather, viral concentration, and wastewater temperature, were fed into the model. The study showed that the model can accurately predict the county-level weekly new admissions, allowing a preparation window of 1-4 weeks. In addition, it also suggests updating the training model periodically to ensure accuracy and transferability, with mean absolute error within 4-6 patients/100k population for upcoming weekly new hospitalization numbers. Aberi et al. (2021) compared eight different regression models for COVID-19 surveillance with the wastewater data from four treatment plants in Austria from May to December 2020. The tested models include Linear Regression (LR), Polynomial Regression (PL), k Nearest Neighbor (KNN), Multilayer Perceptron (MLP), Support Vector Regression (SVR), Generalized Additive Models (GAM), Decision Tree (DT) and Random Forest (RF). The study showed that simple models like PL and KNN outperform more complex models such as GAM, SVR, and MLP with slight differences. Similarly, Vallejo et al. applied linear regression, generalized additive model and locally estimated scatterplot smoothing model (LOESS) for COVID case prediction in Northwest Spain (Vallejo et al., 2022). In addition to the wastewater data, some relevant atmospheric variables (e.g. rainfall, humidity, temperature) are also considered in the models. The results showed that the LOESS model yields the least prediction error with $R^2 = 0.88$. The R^2 for the linear and GAM model are 0.85 and 0.87, respectively. By changing the prediction period, the study found that the reliability of the model predictions could change by time due to different causes such as the change of

Wastewater-based epidemiology survey

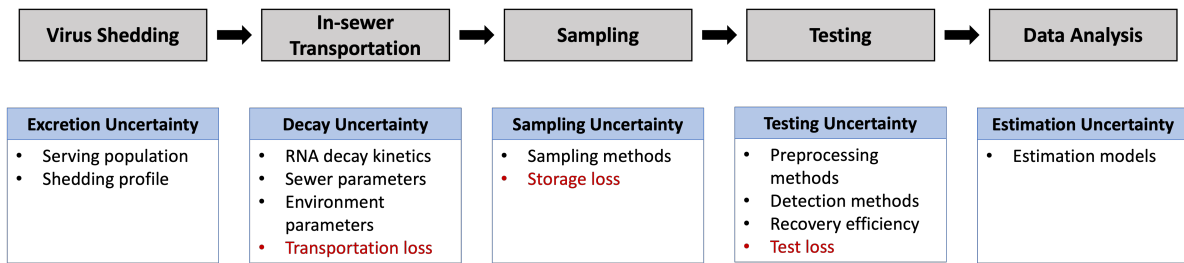

Figure 6: The uncertainty of wastewater-based COVID-19 surveillance.

SARS-CoV-2 variants. In Anneser et al. (2022), the linear and the GAM model were compared with Poisson model and Negative Binomial model to predict the cases from the wastewater data in the three New England regions. The models that fit the data best were linear, GAM, and Poisson model with very small differences on R^2 and $RMSE$. The same set of models were tested on the wastewater data in Oklahoma city from November 2020 to March 2021, with some sociodemographic factors (e.g. age, race and income) considered in the models (Kuhn et al., 2022). The best results were obtained using a multivariate Poisson model. Consistent with the finding in Vallejo et al. (2022), the performance of the Poisson model varies by the time of study. Specifically, its accuracy decayed from 92%, during November 2020 until the end of January 2021, to 59% during February and March 2021. In Morvan et al. (2022), the shedding model in (1) and gradient boosted regression trees (GBRT) were combined to estimate the COVID prevalence in England with the wastewater data from 45 sewage sites. The estimated prevalence was within 1.1% of the estimates from representative prevalence survey (Morvan et al., 2022). In Xiao et al. (2022), the changing dynamics between the reported cases and wastewater viral load were explicitly studied. Specifically, the clinical reported cases were modeled as the convolution between the scaled wastewater data and an unknown transfer function. It was hypothesized that the transfer function could be fit by a beta distribution. The model was fit into the wastewater surveillance data in the Boston area from March 2020 to May 2021. The results showed that the transfer function has a broad peak and long tail before mid August 2020, indicating that the process of infected individuals getting counted as cases has a broad distribution, with some individuals getting reported very quickly but others taking up to weeks. In this case, wastewater viral load can be used as an early indicator of disease dynamics before clinical test results come back positive. After mid August, the transfer function becomes more sharply peaked, indicating that wastewater and reported cases track each other closely. Consequently, wastewater viral load have less utility as an early warning signal as increased clinical testing capacity effectively captures new infections in a timely manner.

In addition to the aforementioned simple regression models, some deep learning-based models are also explored for the wastewater-based epidemic surveillance tasks (Zhu et al., 2022; Jiang et al., 2022; Li et al., 2021a; Galani

et al., 2022). Specifically, the artificial neural network model (ANN) and adaptive neuro fuzzy inference system (ANFIS) have proven effective in different studies for case prediction tasks when compared with linear models and random forest (Li et al., 2021a). By incorporating the catchment information, weather, clinical testing coverage, and vaccination rate features into the ANN model, the effective reproduction rate can be estimated as studied in Jiang et al. (2022).

Aside from the effectiveness of learning models, the features used to feed the learning models may also have an impact on the prediction results. In Li et al. (2021a), the study indicated that the air and wastewater temperature played a critical role in the prevalence estimation by data-driven models. Also, normalizing and smoothing the wastewater data (Aberi et al., 2021) or transforming the viral load into log scale (Vallejo et al., 2022) can help in fitting the models as well. To better understand the spread of the disease and the effect of public health response, Xiao et al. proposed to monitor the ratio between wastewater viral load and clinical cases (WC-ratio) and the time lag between wastewater and clinical reporting in addition to viral load alone (Xiao et al., 2022). Specifically, when the WC ratio is high, it implies that the existing testing capacity has not kept pace with exponentially rising new cases, which nevertheless are detected in wastewater surveillance. Conversely, a low WC ratio indicates that clinical tests are capturing the majority of infections reflected in wastewater viral load. When this ratio is stable and low, it implies that the existing testing capacity is sufficient to assess the extent of new infections. The time lag, on the other hand, may reflect the accessibility of test facilities. Kuhn et al. (2022) showed the lag was significantly lower for areas with a higher household income and a higher proportion of the population aged 65 or older, but higher for areas with a high proportion of Hispanic inhabitants.

5.4. Uncertainty Analysis

The accuracy of wastewater-based COVID-19 surveillance is limited by the uncertainty and inevitable viral loss introduced in each process step. Wade et al. (2022) analyzed different sources of uncertainty, which include (1) serving population, which may change by the population immigration across regions; (2) fecal shedding rate, which varies among individuals and over the infection course; (3) sewage network characteristics, such as the percentage of

gravity or pressurized pipes, the size of the network, and retention capacity; (4) sampling strategies; and (5) sample testing methods. In Figure 6, we summarize the possible uncertainties introduced in each key steps of the WBE system.

Li et al. (2021b) systematically studied the uncertainty in estimating SARS-CoV-2 prevalence by WBE. The study suggested that the uncertainty caused by the excretion rate can become limited for the prevalence estimation when the number of infected persons in the catchment area is more than 10. As for the sampling methods, grab sampling contributed the highest uncertainty (around 30% on average) while a continuous flow-proportional sampling method showed <10% uncertainty. The uncertainty introduced at the testing stage was the dominant factor. Therefore, it is important to use surrogate viruses as internal or external standards during the virus test process. Overall, WBE can be considered as a reliable complementary surveillance strategy for SARS-CoV-2 with reasonable uncertainty (20–40%).

It is worth mentioning that the missing values and outliers in the collected WBE data may also impact the output of estimation models. Unfortunately, the remedy strategies are not frequently discussed in most of the literature. In general, the missing values within a short time interval can be effectively imputed by leveraging the observed nearby data points. Some useful methods include mean imputation, simple interpolation methods (e.g., linear interpolation, spline interpolation), or even some time-series based methods as introduced in Fang and Wang (2020). While to detect the outliers, we can utilize some well-established time-series abnormally detection methods as introduced in Shaukat et al. (2021).

6. Case Study

This section presents the application of WBE and its influence on public health initiatives through case studies from different regions. Additionally, it discusses the possibility of expanding and maintaining WBE as a regular surveillance technique for COVID-19 and other infectious diseases.

6.1. NWSS in the U.S.

In the United States, the CDC led the National Wastewater Surveillance System (NWSS) in September 2020 to respond to the COVID-19 epidemic. CDC developed NWSS to track the presence of SARS-CoV-2 in wastewater samples collected across the country (CDC, 2023).

The CDC uses the following procedures for surveillance: (1) collect wastewater samples from treatment plants in the sewersheds; (2) send samples to environmental or public health labs for SARS-CoV-2 testing; (3) submit testing data to CDC through the online NWSS Data Collation and Integration for Public Health Event Response (DCIPHER) portal; (4) analyze the reported data with the NWSS DCIPHER system and report the findings to the health department for COVID-19 response; (5) publish the results through the CDC's COVID Data Tracker.

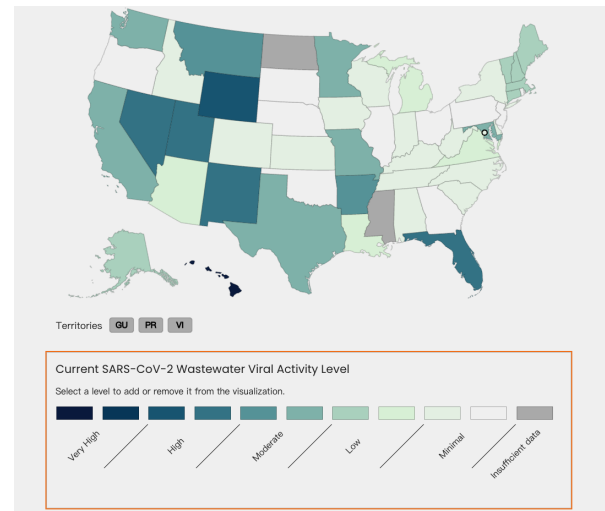

Figure 7: Current Viral Activity Levels Given by CDC (2024a)

The NWSS is implemented in all 50 states, 3 territories, and 5 tribal organizations as shown in Figure 7, which provides early detection of changes in disease trends before trends are seen in clinical cases. This information can be used to prepare healthcare providers and hospital systems for upcoming increases in clinical visits, hospitalizations, and demands from other public health prevention efforts. Such wastewater monitoring data is complementary to other public health surveillance data, which enables better variants tracking and outbreak detection. The monitoring system is fast and efficient due to its independence from the medical systems, which makes it able to circumvent the potential delay caused by healthcare accessibility, test availability, and also the incubation period.

In addition to COVID-19, the CDC also uses the NWSS to monitor the Mpox and Influenza A as shown in Figure 8 and Figure 9 (CDC, 2024c). In particular, the Mpox virus detection in wastewater is tracked in a rolling window of 4 weeks. The detection results are classified into 4 categories, which include “Consistent Detection” when the Mpox virus was detected in more than 80% of samples in the past 4 weeks AND the most recent detection was within the past 2 weeks; “Intermittent Detection” when the virus was detected in 1% to 80% of samples in the past 4 weeks AND the most recent detection was within the past 2 weeks; “No Detection” when the virus was not detected in any samples from the site in the past 4 weeks OR the most recent detection was more than 2 weeks ago; and “No Recent Data” when too few samples were submitted (fewer than 3) in the past 4 weeks. On the other hand, in the Influenza A monitoring program, sampling sites are categorized based on the current level of influenza A compared to the past levels at the same site during the 2023–2024 influenza season. When influenza A virus levels are at the 80th percentile or higher, CDC will start collaborate with relevant partners to understand the factors that could be contributing to these levels.

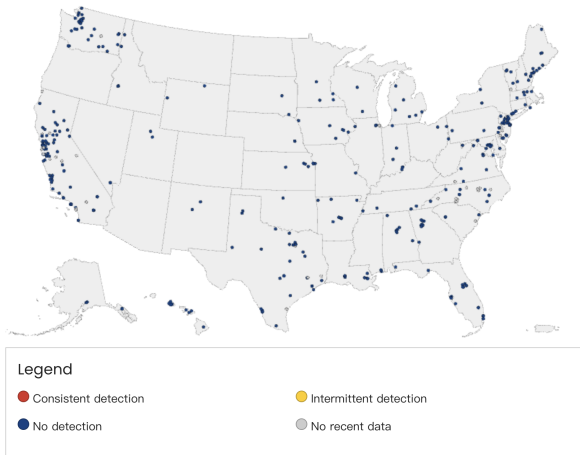

Figure 8: Mpx Virus Detection in Wastewater (CDC, 2024d)

According to the working experience of the CDC, wastewater surveillance data are most useful when used with other data, such as overall levels of the virus in wastewater, historical wastewater data for that location, geographical context, and clinical cases. These data can be used to refine the wastewater monitoring results and help to gain a more comprehensive analysis. The key limitation of the wastewater surveillance system is bounded by the detection limits of the testing methods. In particular, when the viral concentration is lower than the limits of detection, the viral level can not be effectively approximated by the testing methods. Consequently, low levels of infection in a community would not be captured by the wastewater surveillance method.

6.2. Surveillance in Other Countries

Since early 2020, the UK has been analyzing wastewater for SARS-CoV-2 RNA. The Environmental Monitoring for Health Protection (EMHP) SARS-CoV-2 wastewater monitoring program is led by the UK Health Security Agency (UKHSA) and runs in partnership with multiple government agencies, water companies, and universities. The program provides coverage for approximately 74% of the population in England (EMHP, 2022). The first detections of the SARS-CoV-2 virus in the UK were made in wastewater samples that were originally taken for polio surveillance. Since then, separate wastewater surveillance initiatives in England, Scotland, and Wales starting in the early summer of 2020 have demonstrated their effectiveness in COVID-19 surveillance (Wade et al., 2020). As the epidemic began to decline after 2022, the EMHP monitoring program was scaled down and paused at the end of March 2022.

In China, urban sewage surveillance program was added to the Program for Prevention and Control of Novel Coronavirus Infections issued in 2023. Through community sewage monitoring, areas where infected persons may present are identified on time. Possible infected persons can then be traced and found with the help of other surveillance methods. The sewage surveillance at treatment plants is

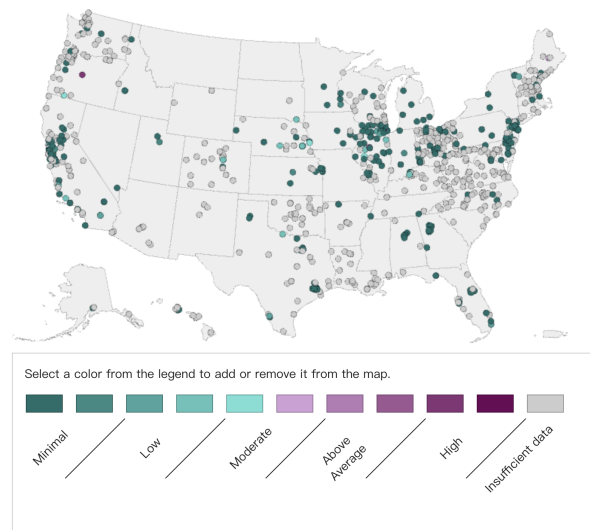

Figure 9: Wastewater Data for Influenza A (CDC, 2024b)

therefore used as a key auxiliary method in assessing the epidemiological trends of COVID-19 infections in available areas in China (NDCPA, 2023).

In Canada, the government has created a wastewater dashboard that allows people to track and compare COVID-19, Influenza A, Influenza B, and RSV levels over time in some communities in Canada. The data is from 62 sites, representing 49.58% of the Canadian population (Canada.ca, 2022). In South Africa, the wastewater surveillance is conducted by the National Institute for Communicable Diseases (NICD) to support the government's response to infectious disease threats, including COVID-19, Meningococcal disease, Typhoid, Shigellosis and Viral Hemorrhagic Fevers (VHF) (NICD, 2023). In New Zealand, the Institute of Environmental Science and Research (ESR) tested wastewater for the presence of SARS-CoV-2 across the country, which helped the government to identify outbreaks from 2020 to 2022. This surveillance is now used to understand disease trends in communities and to monitor variants. In their surveillance system, most wastewater samples are collected by autosamplers, which greatly reduces human efforts in the process. For places where such passive sampling is not available, grab sampling are used as an alternative (ESR, 2023).

Wastewater-based surveillance of COVID-19 has been successfully used in many countries around the world. Such surveillance methods can be further scaled up to become a routine surveillance tool. To do so, we should make more efforts on (1) developing automated sampling and testing techniques to reduce labor costs; and (2) conducting extensive research on broad-spectrum surveillance methods to monitor multiple virus simultaneously.

7. Datasets

This section summarizes the global wastewater datasets that are publicly available in Table 3. The data were collected

up to September 1, 2024. For each dataset, the country, data granularity, area covered, time granularity, time span, current status, and corresponding website are listed. The data granularity represents the aggregation level of wastewater signals, which could range from building-level to country-level. The area covered column shows the monitoring area of the dataset. Time granularity is used to indicate the sampling frequency of the wastewater data. Specifically, for the datasets labeled with '>1/week', more than one data point were observed in one week overall, but the actual weekly samples may vary along the course. The time span specifies the sampling period of the dataset, while the 'live' column indicates whether the data on the website is still getting updated or not. Lastly, the 'website' column gives the link to the dataset.

8. Future Directions and Challenges

Wastewater-based epidemiology has been used as an effective tool to complement conventional clinical testing methods for COVID-19 and other infectious disease surveillance. Although substantial efforts have been made in the area, there are still many challenges to be addressed in future research. These important problems that are worth exploring are identified as follows.

Shedding Variability. Current studies predominantly assume that the infected individuals follow a uniform shedding model with only a few works to account for the variability of the shedding profile. In fact, the shedding amount and duration of SARS-CoV-2 in feces can vary widely between individuals and over time. Factors such as the stage of infection, disease severity, vaccination condition, and individual health condition may all affect the shedding profile. As the shedding model is often directly used to estimate the disease prevalence together with the total viral load in the wastewater, it is therefore crucial to construct customized shedding profiles for different infected individuals.

Sample Testing and Virus Quantification. Long-term wastewater-based COVID-19 surveillance is an economical way to detect the outbreak of disease and emerging variants (Karthikeyan et al., 2022; Lamba et al., 2022). One critical problem for the surveillance systems is the allocation of test resources. To be specific, given a limited budget for sample test resources, it is important to choose the sampling locations and frequency by considering the catchment size, and serving population in the area so that potential outbreaks can be detected as early as possible. On the other hand, the virus quantified in the wastewater sample may not reflect the actual amount of virus entering the sewage system because of the limited sensitivity of lab methods and viral decay in the sewage system. Therefore, it is crucial to improve the lab testing methods and understand the virus decay model under various environmental parameters (e.g., temperature, wastewater pH, etc.). In addition, it is essential to extend the current COVID-19 surveillance framework to other infectious diseases, so that it can be reused as a general disease monitoring and early warning system.

Data Analytics. The majority of the existing literature takes the wastewater data as a standalone signal for epidemic analysis from site to site, while little effort has been made to study the wastewater data from multiple sites collectively for spatial-temporal pattern analysis. Compared to the standalone analysis, the spatial-temporal analysis is more useful for reconstructing the epidemic process at a panoramic scale. In particular, for some large metropolitan areas that can be divided into multiple sewersheds, local residents may contribute to different sites due to the commute from residential areas to commercial areas. In this way, it is hard to recover the disease spread process without tackling the interdependency across sites. The main obstacle to this research direction is the comparability of the data from different sites. Specifically, the sample collection methods, testing methods, and sewage system structure may vary by site. Correspondingly, the same viral load from different sewersheds may represent different epidemic conditions in reality. To this end, how to effectively compile those data into a uniform framework can be a challenging task to address. Moreover, the uncertainties introduced in the wastewater analytic pipeline are not negligible as explained in Section 5.4. Therefore, it is important to quantify the uncertainty together with the prediction results to ensure the reliability of the results.

Multimodality Data Integration The accuracy and timeliness of COVID-19 prevalence estimates can be greatly improved by integrating WBE data with other modality data, such as clinical test data, mobility data, demographic data, and environmental data (Hopkins et al., 2023). Numerous previous studies have demonstrated a strong correlation between WBE data and clinical data. Based on this correlation and the rapidity of WBE, wastewater monitoring data is often used as an early warning signal (D'Aoust et al., 2021a). In turn, clinical data and hospitalization data can be used as truth values to correct the analytical model of WBE. As the model continues to get corrected, the predictions would become more accurate. Another factor affecting the accuracy of surveillance is population distribution, as the serving population size can have a direct impact on the wastewater viral level. In addition, static demographic information, including age, sex, and socioeconomic status, can also help contextualize the WBE data. On the other hand, population movements across sewersheds should also be considered in the analytical model as they could affect regional population size and thus viral loads. In this scenario, mobility data from mobile phones and transportation systems can provide insights into population movement patterns, helping to identify potential hotspots and transmission routes. Integrating this data with WBE can therefore enhance the understanding of viral spread within and between different communities.

Table 3: Current Wastewater Publicly Available Datasets for COVID-19 Surveillance.

Country	Data Granularity	Area Covered	Time Granularity	Time Span	Live	Websites
USA	Country/Region/ County	Nationwide (240 counties)	Weekly	Jan 2020 - Current	Yes	https://biobot.io/data/
USA	County/State/ WWTP	Nationwide	Weekly	Aug 2022 - Current	Yes	https://covid.cdc.gov/covid-data-tracker/#wastewater-surveillance
USA	Country/Region/ WWTP	Nationwide	>1/week	Jul 2020 - Current	Yes	https://data.wastewaterscan.org/
USA	WWTP	Gilbert, AZ	>1/week	Jun 2020 - May 2022	No	https://tog.maps.arcgis.com/apps/dashboards
USA	WWTP	Flagstaff, AZ	Weekly	Oct 2021 - Current	Yes	https://pathogen-intelligence.tgen.org/VECTRSurveillance/flagstaff/
USA	Community	Tempe, AZ	Weekly	Mar 2020 - Current	Yes	https://wastewater.tempe.gov/pages/biomarker-covid19#COVID-19-Dashboard
USA	WWTP	California	>1/week	Dec 2020 - Current	Yes	https://www.cdph.ca.gov/Programs/CID/DCDC/Pages/COVID-19/CalSuWers-Dashboard.aspx
USA	WWTP	Davis, CA	Daily	Nov 2020 - Current	Yes	https://healthydavistogther.org/wastewater/
USA	Community	UC Davis, CA	Daily	Sept 2021 - Current	Yes	https://campusready.ucdavis.edu/testing-response/dashboard
USA	Community	Marin, CA	1-3/week	Sept 2021 - Current	Yes	https://coronavirus.marinhhs.org/surveillance
USA	County/WWTP/ Community	Central valley, CA	3/week	Nov 2020 - Current	Yes	https://healthycvtogether.org/data-main/covid/
USA	WWTP	Santa Clara, CA	Daily	Oct 2020 - Current	Yes	https://covid19.sccgov.org/dashboard-wastewater#3925188384-738865471
USA	WWTP	San Luis Obispo, CA	Daily	May 2022 - Current	Yes	https://www.slocounty.ca.gov/COVID-19/Data.aspx#Wastewater
USA	WWTP	Santa Barbara, CA	Weekly	May 2021 - Current	Yes	https://www.sbcwastewater.org/dashboard
USA	WWTP	San Bernardino, CA	Weekly	Sept 2020 - May 2023	No	https://lookerstudio.google.com/u/0/reporting/430e67c8-acaf-4574-a2d4-48d0b665ab05/page/MhOC
USA	WWTP	Palm Springs, CA	Weekly	Jan 2022 - Jul 2023	No	https://www.palmspringsca.gov/government/departments/community-economic-development-department/wastewater-treatment-plant-covid-19-test-reports
USA	WWTP	UC San Diego, CA	Daily	Feb 2021 - Current	Yes	https://blink.ucsd.edu/safety/resources/public-health/covid-19/dashboard.html
USA	WWTP	San Diego, CA	Daily	Feb 2021 - Current	Yes	https://searchcovid.info/dashboards/wastewater-surveillance/
USA	WWTP	Colorado	>1/week	Aug 2021 - Current	Yes	https://cdphe.maps.arcgis.com/apps/dashboards/d79c193c3938470ca4bcc4823328946b
USA	WWTP	4 cities in CT	Daily	Aug 2022 - Current	Yes	https://yalecovidwastewater.com/sars-cov-2/
USA	WWTP/Building	UConn, CT	>1/week	Apr 2023 - Current	Yes	https://covid-testing.uconn.edu/dashboard/
USA	WWTP/Community	New Castle, DE	Weekly	May 2020 - Sept 2023	No	https://techimpact.shinyapps.io/ncco_wastewater/
USA	WWTP	St. Augustine, FL	Weekly	Apr 2020 - Mar 2021	No	https://data-staug.opendata.arcgis.com/apps/STAU::covid-19-wastewater-testing-dashboard/explore
USA	County/WWTP	Georgia	2/week	Apr 2022 - Current	Yes	https://wastewatersurveillance.s3.amazonaws.com/ExternalNWSS_20231011.html#summary-report
USA	Community/Building	Georgia Tech, GA	>1/week	Aug 2022 - Current	Yes	https://health.gatech.edu/coronavirus/monitoring-covid/
USA	County	Hawaii	Biweekly	Sept 2022 - Current	Yes	https://health.hawaii.gov/coronavirusdisease2019/what-you-should-know/covid-19-data-reports/
USA	City	Boise, ID	Daily-3/week	May 2020 - Current	Yes	https://www.cityofboise.org/departments/mayor/covid-19-information/wastewater-testing/
USA	County/WWTP	Idaho	>1/week	Jun 2021 - Current	Yes	https://public.tableau.com/app/profile/idaho.division.of.public.health/viz/DPHIIdahoCOVID-19Dashboard/Home
USA	WWTP	Illinois	>1/week	Nov 2021 - Current	Yes	https://iws.uillinois.edu/wastewater-treatment-plants/?page=1
USA	WWTP	Kendall, IL	>1/week	Nov 2020 - Jun 2022	No	https://portal.rjngroup.com/arcgisportal/apps/opsdashboard/index.html#594d4b1b2dd840958cedb50b1381982b
USA	WWTP/Community	Chicago	2/week	Mar 2022 - Current	Yes	https://www.chicago.gov/city/en/sites/covid-19/home/covid-19-wastewater-surveillance.html
USA	State/WWTP	Indiana	>1/week	Feb 2020 - Current	Yes	https://www.coronavirus.in.gov/indiana-covid-19-dashboard-and-map/wastewater-dashboard/
USA	WWTP	Cedar Rapids, IA	>1/week	Oct 2021 - Current	Yes	https://www.cedar-rapids.org/residents/utilities/covid-19.php
USA	City	Louisville, KY	Weekly	Sept 2022 - Current	Yes	https://louisville.edu/envirome/thecoimmunityproject/dashboard
USA	WWTP	Maine	Weekly	May 2020 - Aug 2023	No	https://www.maine.gov/dhhs/mecdc/infectious-disease/epi/airborne/coronavirus/wastewater-reports.shtml
USA	WWTP/Community	Montgomery, MD	2/week	Oct 2022 - Current	Yes	https://montgomerycountymd.gov/covid19/data/wastewater-surveillance.html
USA	WWTP/Community	Eastern MA	Daily	Mar 2020 - Current	Yes	https://www.mwra.com/biobot/biobotdata.htm
USA	Community	Boston, MA	2/week	Jan 2023 - Current	Yes	https://www.boston.gov/government/cabinets/boston-public-health-commission/covid-19-boston#wastewater-reports

USA	WWTP	Massachusetts	>1/week	Feb 2020 - Current	Yes	https://www.mass.gov/info-details/wastewater-surveillance-reporting
USA	Community	Cambridge	Weekly	Oct 2020 - Current	Yes	https://cityofcambridge.shinyapps.io/COVID19/#shiny-tab-wastewater
USA	WWTP	Southeast Michigan	Daily	Jul 2021 - Current	Yes	https://um.wastewatermonitoring.dataapi.org/
USA	WWTP	Michigan	Weekly	Jun 2021 - Current	Yes	https://www.michigan.gov/coronavirus/stats/wastewater-surveillance/dashboard/sentinel-wastewater-epidemiology-evaluation-project-sweep
USA	WWTP/Community	Michigan	>1/week	Apr 2020 - Dec 2020	No	https://storymaps.arcgis.com/stories/f2996168197c4bffa05e76b893fd9a8e
USA	WWTP/Community/ Building	Michigan	Weekly	Apr 2020 - Current	Yes	https://gisportal.state.mi.us/portal/apps/insights/index.html#/view/52bbb104ed574887918f990af9f3debe
USA	WWTP	Twin Cities, MN	Daily	Nov 2020 - Aug 2023	No	https://metrotransitm.shinyapps.io/metc-wastewater-covid-monitor/
USA	State/WWTP	Minnesota	>1/week	Jan 2023 - Current	Yes	https://umn.maps.arcgis.com/apps/dashboards/fd0350c812334c5f9733ca5b6186db0d
USA	State/WWTP	Missouri	Weekly	Jul 2020 - Current	Yes	https://storymaps.arcgis.com/stories/f7f5492486114da6b5d6fdc07f81aacf
USA	City	Montana	>1/week	Mar 2020 - Dec 2022	No	https://www.healthygallatin.org/coronavirus-covid-19/wastewater-data/
USA	WWTP	Grand Island, NE	Weekly	Feb 2022 - Current	Yes	https://cdhd.ne.gov/how-do-i/find/covid-wastewater-reports.html
USA	City/Community/ Building	Southern Nevada	Weekly/Monthly	Aug 2020 - Aug 2023	Yes	https://empower.unlv.edu/
USA	County/City	Nevada	Weekly	May 2020 - Oct 2022	No	https://thenevadaindependent.com/coronavirus-data-nevada
USA	WWTP	New Hampshire	Weekly	Oct 2022 - Current	Yes	https://wisdom.dhhs.nh.gov/wisdom/dashboard.html?topic=covid-19&subtopic=recurring-updates&indicator=covid-19-wastewater#tabnavbarid
USA	WWTP	New York	>1/week	Aug 2020 - Current	Yes	https://mbcolli.shinyapps.io/SARS2EWSP/#
USA	WWTP	North Carolina	>1/week	Jan 2021 - Current	Yes	https://covid19.ncdhhs.gov/dashboard/wastewater-monitoring
USA	WWTP	Western NC	>1/week	Jan 2021 - Jul 2022	No	https://wastewater.covid19.mathematica.org/
USA	WWTP	Huron, OH	2/week	Aug 2023 - Oct 2023	No	https://www.huroncohealth.com/public-information
USA	WWTP	Ohio	>1/week	Aug 2020 - Sept 2023	No	https://www.neorsd.org/ohio-coronavirus-wastewater-monitoring-network-data-for-northeast-ohio-regional-sewer-district/
USA	State/County/ City	Oklahoma	Weekly	Jul 2021 - Current	Yes	https://www.tulsa-health.org/community-health/illness-disease/coronavirus-disease-2019-covid-19/tulsa-county-covid-19-data
USA	City	Oregon	>1/week	Sept 2020 - Current	Yes	https://public.tableau.com/app/profile/oregon.health.authority.covid.19/viz/OregonsSARS-CoV-2WastewaterMonitoring/WastewaterDashboard
USA	County/WWTP	Pennsylvania	>1/week	Jul 2022 - Current	Yes	https://www.arcgis.com/apps/dashboards/ee27ed0a3a9f4d4bb380ec0eb1369a84
USA	County	Indiana, PA	Weekly	Aug 2020 - Sept 2023	No	https://www.indianaboro.com/news/categories/wastewater-surveillance
USA	County	Allegheny, PA	>1/week	Nov 2021 - Current	Yes	https://mcba.autonlab.org/covidashboard/public
USA	County	Chattanooga, TN	Weekly	May 2020 - Mar 2023	No	https://connect.chattanooga.gov/covid-biobot-analysis-reports/
USA	WWTP	Houston, TX	Weekly	Jul 2020 - Current	Yes	https://covidwtp.spatialstudieslab.org/?data_id=dataSource_14-b3436880c1ff47efb60e44ac78851c5e%3A20055%2CdataSource_18-WWTP_List%3A6&page=page_0
USA	WWTP	Utah	>1/week	Mar 2020 - Current	Yes	https://udwq.shinyapps.io/sarscov2_surv/
USA	WWTP	Burlington, VT	Weekly	Jul 2022 - Current	Yes	https://www.burlingtonvt.gov/covid-19/wastewater
USA	WWTP	Virginia	>1/week	Sept 2021 - Current	Yes	https://www.vdh.virginia.gov/coronavirus/see-the-numbers/covid-19-data-insights/sars-cov-2-in-wastewater/
USA	WWTP	Spokane, WA	Weekly	Dec 2021 - Current	Yes	https://covid.srhd.org/topics/spokane-county-case-data
USA	WWTP	Washington	>1/week	Oct 2021 - Current	Yes	https://doh.wa.gov/data-and-statistical-reports/diseases-and-chronic-conditions/communicable-disease-surveillance-data/respiratory-illness-data-dashboards/WasteWater
USA	State/WWTP	West Virginia	Weekly	Oct 2022 - Current	Yes	https://wvuvectors.shinyapps.io/WaTCH-WV/
USA	State/WWTP	Wisconsin	>1/week	Sept 2020 - Current	Yes	https://www.dhs.wisconsin.gov/covid-19/wastewater.htm
USA	WWTP	Wyoming	>1/week	Oct 2020 - Dec 2021	No	https://covidwastewatermonitor.wyo.gov/
Canada	Region/WWTP	Nationwide	>1/week	Oct 2020 - Current	Yes	https://health-infobase.canada.ca/covid-19/wastewater/
Canada	WWTP	Eastern Ontario	>1/week	Aug 2023 - Current	Yes	https://eohu.ca/en/covid/covid-19-status-update-for-eohu-region
Canada	WWTP	Kingston, ON	3-5/week	Nov 2022 - Current	Yes	https://app.powerbi.com/view?r=eyJrJoiMzgzZGFmNTAtZDcxNC00N2NiLTg0YmUtMGM5Y2ZmM5ODZkOTVjliwidCl6lk4M2JmOTVjLTAYnDYtNDg5MjY0YmMl4LTgwMWJkNTEwYjRmYSJ9&pageName=ReportSection567adb9a3e98e0661d
Canada	WWTP	Windsor-Essex, ON	5/week	Dec 2020 - Current	Yes	https://www.wechu.org/reports/local-covid-19-surveillance
Canada	WWTP	London, ON	3-5/week	Oct 2021 - Current	Yes	http://www.519covid.ca/
Canada	WWTP	Waterloo, ON	>1/week	Jan 2021 - Apr 2023	Yes	https://www.regionofwaterloo.ca/en/health-and-wellness/covid-19-wastewater-surveillance.aspx#
Canada	Region/City	Wellington, Dufferin, and Guelph, ON	Daily	Sept 2021 - Current	Yes	https://bi.wdgpulichealth.ca/respiratory-dashboard/
Canada	WWTP	Halton, ON	3-5/week	Jan 2023 - Current	Yes	https://www.halton.ca/For-Residents/Immunizations-Preventable-Disease/Diseases-Infections/COVID-19

Canada	WWTP	Toronto	>1/week	Feb 2021 - Current	Yes	https://www.toronto.ca/community-people/health-wellness-care/health-programs-advice/respiratory-viruses/covid-19/covid-19-pandemic-data/covid-19-wastewater-surveillance/
Canada	Province/Region	Ontario	3-5/week	Oct 2022 - Current	Yes	https://www.publichealthontario.ca/en/Data-and-Analysis/Infectious-Disease/COVID-19-Data-Surveillance/Wastewater
Canada	WWTP	York, ON	Daily	Nov 2020 - Current	Yes	https://www.york.ca/health/covid-19/covid-19-york-region#.Yd3nnYjMK3A?utm_source=newmarkettoday.ca&utm_campaign=newmarkettoday.ca%3A%20outbound&utm_medium=referral
Canada	WWTP	Peterborough, ON	5/week	Jul 2022 - Current	Yes	https://app.powerbi.com/view?r=eyJrJoiNDRhYWQ1NzktNjlkMi00Y1Y2Q2LW10NDIiOTQ0ZDU2MDk3YTlliwidCI6JjQ0OTJlODVlMTNzEiNGUzNy1hZjU1LT E4NTU3MjA2NDJjOCJ9&pageName=ReportSectionb42f1cb240c9ad8780d8
Canada	WWTP	Greater Sudbury, ON	3-5/week	Jan 2021 - Current	Yes	https://www.greatersudbury.ca/live/covid-19-coronavirus/measuring-sars-cov-2-in-wastewater-covid-19/
Canada	WWTP	Thunder Bay, ON	3-5/week	Dec 2021 - Current	Yes	https://www.tbdhu.com/datadashboard
Canada	City	Alberta	>1/week	Jul 2023 - Current	Yes	https://covid-tracker.chi-csm.ca/
Canada	WWTP	British Columbia	2-3/week	Jan 2022 - Current	Yes	https://bccde.shinyapps.io/respiratory_wastewater/#Viral_Load_Summary
Brazil	City	6 cities	Daily	Jun 2021 - Mar 2022	No	https://app.powerbi.com/view?r=eyJrJoiNzIxMjY1ZDZjZDYjNy00NTMwLW1wZm1tYmQwOWJhNzk3YmU1IiwidCI6JjE1NmU3MTc4LTA1ZmYtNGVmYy05OTY2LTU2ODFjE2MjA3MCI9&pageName=ReportSectiond497bb36400a320db4c7
Brazil	City	2 cities	Monthly	Apr 2020 - Aug 2022	No	https://coronavirus.saude.mg.gov.br/transparencia/monitoramento-covid-esgotos
New Zealand	Region/City	16 regions	Weekly	Jul 2022 - Current	Yes	https://esr-cri.shinyapps.io/wastewater/#region=Wellington&log_or_linear=linear&period=twelveMonthsButton
Australia	WWTP	Perth	Weekly	Jul 2022 - Current	Yes	https://www.health.wa.gov.au/articles/a_e/coronavirus/covid19-wastewater-surveillance
Australia	Region/City	Queensland	Daily	Jul 2020 - Sept 2022	No	https://www.data.qld.gov.au/dataset/queensland-wastewater-surveillance-for-sars-cov-2
Australia	Region/City	Sydney	Biweekly	Feb 2022 - Current	Yes	https://www.health.nsw.gov.au/Infectious/covid-19/Pages/reports.aspx
South Africa	Province/District/WWTP	9 Province/16 District/85 WWTP	Weekly	Feb 2021 - Dec 2022	No	https://wastewater.nicd.ac.za/
South Africa	Province	5 Province/10 District/76 WWTP	Weekly	Nov 2021 - Apr 2023	No	https://www.samrc.ac.za/wbe/
Austria	WWTP	10 regions in Austria	Daily	Jan 2022 - Current	Yes	https://abwassermonitoring.at/dashboard/
Belgium	WWTP/Regions	206 Municipalities in Belgium	2/week	Sep 2020 - Current	Yes	https://wastewater.sciensano.be/dashboard/covid19/en/
Czech Republic	WWTP	4 regions in Czech Republic	Weekly	Apr 2020 - Jan 2023	No	https://heis.vuv.cz/data/webmap/datovesady/projekty/covmon/default.asp?lang=cs&tab=6&wmap=https://covid-pulse.cy/
Cyprus	WWTP	Cyprus	Weekly	Oct 2021 - Oct 2022	No	https://www.ssi.dk/sygdomme-beredskab-og-forskning/sygdomsovervaagning/c/covid-19-spildevandsovervaagning
Denmark	Region	5 regions in Denmark	Weekly	Aug 2022 - Current	Yes	https://data.lageso.de/lageso/corona/corona.html#abwasser
Germany	WWTP/City	Berlin	Weekly	Apr 2022 - Current	Yes	https://www.bay-voc.lmu.de/abwassermonitoring
Germany	Region	Bavarian municipalitie	Weekly	Nov 2022 - Current	Yes	https://www.bay-voc.lmu.de/abwassermonitoring
Greece	City	Athens	Daily	Apr 2020 - Nov 2022	No	http://trams.chem.uoa.gr/covid-19/
Finland	City	13 Cities/Regions in Finland	Weekly/Monthly	Oct 2022 - Current	Yes	https://www.thl.fi/episeuranta/jatevesi/wastewater_weekly_report.html
Lithuania	WWTP/City	3 regions in Lithuania	Weekly	Nov 2022 - Current	Yes	https://nvsc.lrv.lt/lt/informacija-visuomenei-apie-covid-19/covid/sars-cov-2-stebejimas-nuotekose/stebesenos-rezultatai
Luxembourg	WWTP	Luxembourg	Weekly	May 2020 - Current	Yes	https://www.list.lu/en/covid-19/coronastep/
Netherlands	Regions	Netherlands	3/week	Sep 2020 - Current	Yes	https://coronadashboard.rijksoverheid.nl/landelijk/rioolwater
Norway	WWTP/City	5 areas in Norway	Weekly	May 2022 - Current	Yes	https://www.fhi.no/en/in/surveillance/wastewater-surveillance-of-infectious-diseases/results-from-wastewater-surveillance/
Poland	WWTP	Warsaw	Weekly	Mar 2022 - Current	Yes	https://www.mpwik.com.pl/view/monitoring-wirusa-sars-cov-2-w-sciekach-w-aglomeracji-warszawskiej#S.embed_link-K.C-B.1-L.4.zw
Slovakia	Region	7 regions in Slovakia	Weekly	May 2021 - Current	Yes	https://www.uvzsr.sk/sk/web/uvzen
Slovenia	Country	12 regions in Slovenia	Weekly	Mar 2020 - Current	Yes	https://covid-19.sledilnik.org/en/stats
Spain	Region	5 regions in Spain	Weekly	Apr 2020 - Mar 2022	No	https://edarbens.es/covid19/
Spain	Region	Catalonia	Weekly	Jun 2020 - Current	Yes	https://sarsaigua.icra.cat/
Spain	Region	Madrid	Weekly	Feb 2021 - Current	Yes	https://www.canaldeisabelsegunda.es/sistema-vigia
Sweden	WWTP/City	26 WWTPs in Sweden	Weekly/Monthly	Feb 2020 - Current	Yes	https://www.pathogens.se/dashboards/wastewater/
Switzerland	WWTP/City	Switzerland	Daily/Weekly	Mar 2020 - Current	Yes	https://sensors-eawag.ch/sars/lugano.html
Switzerland & Lichtenstein	WWTP/City	Switzerland & Lichtenstein	Daily/Weekly	Feb 2022 - Current	Yes	https://www.covid19.admin.ch/en/epidemiologic/waste-water

Switzerland	WWTP/City	14 Regions in Switzerland	Daily/Weekly	Jan 2020 - Current	Yes	https://cov-spectrum.org/story/wastewater-in-switzerland
United Kingdom	Region	Scotland	Daily/Weekly	Jun 2020 - Current	Yes	https://informatics.sepa.org.uk/RNAmonitoring/
United Kingdom	Region	Scotland	Daily/Weekly	May 2020 - Current	Yes	https://scotland.shinyapps.io/phs-respiratory-covid-19/
United Kingdom	Region	England	Weekly	Jul 2021 - Mar 2022	No	https://www.gov.uk/government/collections/monthly-statistics-for-the-environmental-monitoring-for-health-protection-emhp-wastewater-program-england#latest-report
United Kingdom	Region	Wales	5/week	Feb 2022 - Jul 2023	No	https://www.gov.wales/wastewater-monitoring-reports-coronavirus
Bangladesh	Region	6 regions in Bangladesh		Nov 2021 - Aug 2023	No	https://erin-wettstone.shinyapps.io/Dashboard_V6/
China	Region	Hongkong	Weekly	May 2022 - Current	Yes	https://www.chp.gov.hk/en/resources/29/100148.html
India	WWTP/City	Bangalore	Weekly	Aug 2021 - Jun 2023	No	https://storymaps.arcgis.com/stories/c42be68c85634d19a5d92873a10bda66
India	City	Jodhpur	4/week	Feb 2023 - Jun 2023	No	https://storymaps.arcgis.com/stories/d376cf3e75204234a9dc6541ecad5a98
India	City	Pune	Daily/Weekly	Aug 2021 - Current	Yes	https://www.pkc.org.in/pkc-focus-area/health/waste-water-surveillance/wws-covid-dashboard-pune/
Israel	Region	Israel	Weekly	May 2022 - Jul 2023	No	https://app.powerbi.com/view?r=eyJrIjoiOTYwNDQ3NzItMTk5Ni00NzNmLTlhMmEtMzk3NmI1NmFkZjhlIiwidCI6ImlzYzdlZDM0LWQxZjAtNDg5Zi05YzllLW00YmNlYTk0YmJlNCIsImMiOiJ9&pageName=ReportSection0f78f45a748a997ecd43
Japan	Region	Komatsu City	Weekly	Dec 2022 - Current	Yes	https://www.city.komatsu.lg.jp/soshiki/jougesuidoukanri/surveillance/14588.html

Ethical Concerns. WBE data may pose ethical or even legal concerns if not implemented properly. Although WBE data typically cannot identify individuals, when combined with other data sources, there are potential risks for privacy breaches. Therefore, ensuring anonymization and secure handling of data is essential to protect individual privacy. On the other hand, it is necessary to communicate with the public about how WBE data is used, its benefits for public health, and measures to protect privacy, so that implementation of WBE is well accepted by the general public. Lastly, developing legal frameworks that govern the use of WBE data is important to address potential liabilities and ensure ethical use. Effective measures along this direction include regulations on data collection, sharing, and usage rights.

9. Conclusion

Wastewater-based epidemiology has been demonstrated as a powerful tool for COVID-19 surveillance and trend projection within communities. This survey summarizes the wastewater sampling techniques, sample testing methods, data analytical models, and the existing wastewater datasets at a global level. In particular, this survey provides a new taxonomy of data analytical models to help the researcher and practitioner form a systematic view of the area. Most importantly, the reviewed data analytical models can be easily generalized to many other infectious diseases, which can be referred to as guidance to build general disease surveillance systems. Moreover, the comprehensive wastewater datasets at different granularity can serve as a benchmark for validating new surveillance models at various scales. Last but not least, the challenges in the area are discussed, which may help inspire researchers in their future research directions.

Acknowledgements. We thank members of the Biocomplexity COVID-19 Response Team and the Network Systems Science and Advanced Computing (NSSAC) Division of the University of Virginia for their thoughtful comments and suggestions related to epidemic modeling and response support. We also thank scientists at the Virginia Department of Health (VDH) and the Division of Consolidated Laboratory Services (DCLS) for their collaboration. This work was partially supported by University of Virginia Strategic Investment Fund award number SIF160, National Institutes of Health (NIH) Grant 1R01GM109718, NSF Expeditions in Computing Grant CCF-1918656, VDH Contract UVABIO610-GY23, NSF Grant CCF-1908308, PG-CoE CDC-RFA-CK22-2204, VDH Contract UVABIO610-GY23. Any opinions, findings, conclusions, or recommendations expressed in this publication are those of the authors and do not necessarily reflect the views of the funding agencies. This journal article was supported by the Office of Advanced Molecular Detection, Centers for Disease Control and Prevention through Cooperative Agreement Number CK22-2204. Its contents are solely the responsibility of the authors and do not necessarily represent the official views of the Centers for Disease Control and Prevention.

References

- Aberi, P., Arabzadeh, R., Insam, H., Markt, R., Mayr, M., Kreuzinger, N., Rauch, W., 2021. Quest for optimal regression models in SARS-Cov-2 wastewater based epidemiology. *International Journal of Environmental Research and Public Health* 18, 10778.
- Acosta, N., Bautista, M.A., Waddell, B.J., McCalder, J., Beaudet, A.B., Man, L., Pradhan, P., Sedaghat, N., Papparis, C., Bacanu, A., Hollman, J., Krusina, A., Southern, D.A., Williamson, T., Li, C., Bhatnagar, S., Murphy, S., Chen, J., Kuzma, D., Clark, R., Meddings, J., Hu, J., Cabaj, J.L., Conly, J.M., Dai, X., Lu, X., Chekouo, T., Ruecker, N.J., Achari, G., Ryan, M.C., Frankowski, K., Hubert, C.R., Parkins, M.D., 2022. Longitudinal SARS-Cov-2 RNA wastewater monitoring across a range of scales correlates with total and regional COVID-19 burden in a well-defined urban population. *Water Research* 220, 118611. URL: <https://www.sciencedirect.com/science/article/pii/S0043135422005644>, doi:<https://doi.org/10.1016/j.watres.2022.118611>.
- Agrawal, S., Orschler, L., Lackner, S., 2021. Long-term monitoring of SARS-Cov-2 RNA in wastewater of the frankfurt metropolitan area in Southern Germany. *Scientific Reports* 11, 5372.
- Ahmed, W., Angel, N., Edson, J., Bibby, K., Bivins, A., O'Brien, J.W., Choi, P.M., Kitajima, M., Simpson, S.L., Li, J., et al., 2020a. First confirmed detection of SARS-Cov-2 in untreated wastewater in australia: a proof of concept for the wastewater surveillance of COVID-19 in the community. *Science of The Total Environment* 728, 138764.
- Ahmed, W., Bertsch, P.M., Bivins, A., Bibby, K., Gathercole, A., Haramoto, E., Gyawali, P., Korajkic, A., McMinn, B.R., Mueller, J.F., et al., 2020b. Comparison of virus concentration methods for the RT-qPCR-based recovery of murine hepatitis virus, a surrogate for SARS-Cov-2 from untreated wastewater. *Science of The Total Environment* 739, 139960.
- Ahmed, W., Tschärke, B., Bertsch, P.M., Bibby, K., Bivins, A., Choi, P., Clarke, L., Dwyer, J., Edson, J., Nguyen, T.M.H., et al., 2021. SARS-Cov-2 RNA monitoring in wastewater as a potential early warning system for COVID-19 transmission in the community: A temporal case study. *Science of The Total Environment* 761, 144216.
- Ai, Y., Davis, A., Jones, D., Lemeshow, S., Tu, H., He, F., Ru, P., Pan, X., Bohrerova, Z., Lee, J., 2021. Wastewater SARS-Cov-2 monitoring as a community-level COVID-19 trend tracker and variants in Ohio, United States. *Science of The Total Environment* 801, 149757. URL: <https://www.sciencedirect.com/science/article/pii/S0048969721048324>, doi:<https://doi.org/10.1016/j.scitotenv.2021.149757>.
- Alahdal, H.M., Ameen, F., AlYahya, S., Sonbol, H., Khan, A., Alsofayan, Y., Alahmari, A., 2023. Municipal wastewater viral pollution in saudi arabia: effect of hot climate on COVID-19 disease spreading. *Environmental Science and Pollution Research* 30, 25050–25057.
- Alexander, M.R., Rootes, C.L., van Vuren, P.J., Stewart, C.R., 2020. Concentration of infectious SARS-Cov-2 by polyethylene glycol precipitation. *Journal of Virological Methods* 286, 113977.
- Amerah, F., Jahangiri-Rad, M., Mohseni-Bandpei, A., Mohebbi, S.R., Asadzadeh-Aghdaei, H., Dabiri, H., Eslami, A., Roostaei, K., Aali, R., Hamian, P., et al., 2022. Association of SARS-Cov-2 presence in sewage with public adherence to precautionary measures and reported COVID-19 prevalence in Tehran. *Science of The Total Environment* 812, 152597.
- Amoah, I.D., Mthethwa, N.P., Pillay, L., Deepnarain, N., Pillay, K., Awo-lusi, O.O., Kumari, S., Bux, F., 2021. RT-LAMP: a cheaper, simpler and faster alternative for the detection of SARS-Cov-2 in wastewater. *Food and Environmental Virology* 13, 447–456.
- Anderson, R.M., May, R.M., 1979. Population biology of infectious diseases: Part i. *Nature* 280, 361–367.
- Anderson-Coughlin, B.L., Shearer, A.E., Omar, A.N., Wommack, K.E., Kniel, K.E., 2021. Recovery of SARS-Cov-2 from wastewater using centrifugal ultrafiltration. *Methods and Protocols* 4, 32.
- Anneser, E., Riseberg, E., Brooks, Y.M., Corlin, L., Stringer, C., 2022. Modeling the relationship between SARS-Cov-2 RNA in wastewater or sludge and COVID-19 cases in three new england regions. *Journal of Water and Health* 20, 816–828.
- Augusto, M.R., Claro, I.C.M., Siqueira, A.K., Sousa, G.S., Caldereiro, C.R., Duran, A.F.A., de Miranda, T.B., Camillo, L.d.M.B., Cabral, A.D.,

- de Freitas Bueno, R., 2022. Sampling strategies for wastewater surveillance: Evaluating the variability of SARS-Cov-2 RNA concentration in composite and grab samples. *Journal of Environmental Chemical Engineering* 10, 107478.
- Bagutti, C., Alt Hug, M., Heim, P., Maurer Pekerman, L., Ilg Hampe, E., Hübner, P., Fuchs, S., Savic, M., Stadler, T., Topolsky, I., Icer Baykal, P., Dreifuss, D., Beerenwinkel, N., Tschudin Sutter, S., 2022. Wastewater monitoring of SARS-Cov-2 shows high correlation with COVID-19 case numbers and allowed early detection of the first confirmed b.1.1.529 infection in Switzerland: results of an observational surveillance study. *Swiss Medical Weekly* 152, w30202. URL: <https://smw.ch/index.php/smw/article/view/3226>, doi:10.4414/SMW.2022.w30202.
- Barril, P.A., Pianciola, L.A., Mazzeo, M., Ousset, M.J., Jaureguierry, M.V., Alessandrello, M., Sánchez, G., Oteiza, J.M., 2021. Evaluation of viral concentration methods for SARS-Cov-2 recovery from wastewater. *Science of The Total Environment* 756, 144105.
- Barrios, M.E., Díaz, S.M., Torres, C., Costamagna, D.M., Blanco Fernández, M.D., Mbayed, V.A., 2021. Dynamics of SARS-Cov-2 in wastewater in three districts of the Buenos Aires metropolitan region, Argentina, throughout nine months of surveillance: A pilot study. *Science of The Total Environment* 800, 149578. URL: <https://www.sciencedirect.com/science/article/pii/S0048969721046532>, doi:<https://doi.org/10.1016/j.scitotenv.2021.149578>.
- Belmonte-Lopes, R., Barquilha, C.E., Kozak, C., Barcellos, D.S., Leite, B.Z., da Costa, F.J.G., Martins, W.L., Oliveira, P.E., Pereira, E.H., Filho, C.R.M., et al., 2023. 20-month monitoring of SARS-Cov-2 in wastewater of Curitiba, in Southern Brazil. *Environmental Science and Pollution Research*, 1–15.
- Bertels, X., Hanoteaux, S., Janssens, R., Maloux, H., Verhaegen, B., Delputte, P., Boogaerts, T., van Nuijs, A.L., Brogna, D., Linard, C., et al., 2023. Time series modelling for wastewater-based epidemiology of COVID-19: A nationwide study in 40 wastewater treatment plants of Belgium, February 2021 to June 2022. *Science of The Total Environment* 899, 165603.
- Bischel, H.N., Duygan, B.D.Ö., Strande, L., Mc Ardell, C.S., Udert, K.M., Kohn, T., 2015. Pathogens and pharmaceuticals in source-separated urine in eThekweni, South Africa. *Water Research* 85, 57–65.
- Brouwer, A.F., Eisenberg, J.N., Pomeroy, C.D., Shulman, L.M., Hindiyeh, M., Manor, Y., Grotto, I., Koopman, J.S., Eisenberg, M.C., 2018. Epidemiology of the silent polio outbreak in Rahat, Israel, based on modeling of environmental surveillance data. *Proceedings of the National Academy of Sciences* 115, E10625–E10633.
- Calderón-Franco, D., Orschler, L., Lackner, S., Agrawal, S., Weissbrodt, D.G., 2022. Monitoring SARS-Cov-2 in sewage: Toward sentinels with analytical accuracy. *Science of The Total Environment* 804, 150244.
- Canada.ca, 2022. Covid-19 wastewater monitoring dashboard. URL: <https://health-infobase.canada.ca/covid-19/wastewater/>.
- Cao, Y., Francis, R., 2021. On forecasting the community-level COVID-19 cases from the concentration of SARS-Cov-2 in wastewater. *Science of The Total Environment* 786, 147451.
- Castiglioni, S., Schiarea, S., Pellegrinelli, L., Primache, V., Galli, C., Bubba, L., Mancinelli, F., Marinelli, M., Cereda, D., Ammoni, E., et al., 2022. SARS-Cov-2 RNA in urban wastewater samples to monitor the COVID-19 pandemic in Lombardy, Italy (March–June 2020). *Science of The Total Environment* 806, 150816.
- CDC, . National Wastewater Surveillance System. <https://www.cdc.gov/nwss/wastewater-surveillance.html>. Accessed: 2023-04-25.
- CDC, 2023. National wastewater surveillance system. URL: <https://www.cdc.gov/nwss/index.html>.
- CDC, 2024a. Covid-19 current wastewater viral activity levels map. URL: <https://www.cdc.gov/nwss/rv/COVID19-currentlevels.html>.
- CDC, 2024b. Influenza a virus wastewater data | national wastewater surveillance system | cdc.
- CDC, 2024c. Nwss wastewater monitoring in the u.s.
- CDC, 2024d. U.s. mpox wastewater data | national wastewater surveillance system | cdc.
- Ciannella, S., González-Fernández, C., Gomez-Pastora, J., 2023. Recent progress on wastewater-based epidemiology for COVID-19 surveillance: A systematic review of analytical procedures and epidemiological modeling. *Science of The Total Environment* 878, 162953.
- Claro, I.C.M., Cabral, A.D., Augusto, M.R., Duran, A.F.A., Graciosa, M.C.P., Fonseca, F.L.A., Speranca, M.A., de Freitas Bueno, R., 2021. Long-term monitoring of SARS-Cov-2 RNA in wastewater in Brazil: a more responsive and economical approach. *Water Research* 203, 117534.
- Cohen, A., Maile-Moskowitz, A., Grubb, C., Gonzalez, R.A., Ceci, A., Darling, A., Hungerford, L., Fricker Jr, R.D., Finkielstein, C.V., Pruden, A., et al., 2022. Subwatershed SARS-Cov-2 wastewater surveillance and COVID-19 epidemiology using building-specific occupancy and case data. *ACS Es&t Water* 2, 2047–2059.
- Corman, V.M., Landt, O., Kaiser, M., Molenkamp, R., Meijer, A., Chu, D.K., Bleicker, T., Brünink, S., Schneider, J., Schmidt, M.L., et al., 2020. Detection of 2019 novel coronavirus (2019-ncov) by real-time rt-pcr. *Eurosurveillance* 25, 2000045.
- Curtis, K., Keeling, D., Yetka, K., Larson, A., Gonzalez, R., 2020. Wastewater SARS-Cov-2 RNA concentration and loading variability from grab and 24-hour composite samples. *MedRxiv*, 2020–07.
- D'Aoust, P.M., Graber, T.E., Mercier, E., Montpetit, D., Alexandrov, I., Neault, N., Baig, A.T., Mayne, J., Zhang, X., Alain, T., et al., 2021a. Catching a resurgence: Increase in SARS-Cov-2 viral RNA identified in wastewater 48 h before COVID-19 clinical tests and 96 h before hospitalizations. *Science of The Total Environment* 770, 145319.
- D'Aoust, P.M., Mercier, E., Montpetit, D., Jia, J.J., Alexandrov, I., Neault, N., Baig, A.T., Mayne, J., Zhang, X., Alain, T., et al., 2021b. Quantitative analysis of SARS-Cov-2 RNA from wastewater solids in communities with low COVID-19 incidence and prevalence. *Water research* 188, 116560.
- Dumke, R., de la Cruz Barron, M., Oertel, R., Helm, B., Kallies, R., Berendonk, T.U., Dalpke, A., 2021. Evaluation of two methods to concentrate SARS-Cov-2 from untreated wastewater. *Pathogens* 10, 195.
- EMHP, 2022. Emhp wastewater monitoring of sars-cov-2 in england: 1 june 2021 to 7 march 2022. URL: <https://www.gov.uk/government/publications/monitoring-of-sars-cov-2-rna-in-england-wastewater-monthly-statistics-1-june-2021-to-7-march-2022/emhp-wastewater-monitoring-of-sars-cov-2-in-england-1-june-2021-to-7-march-2022>.
- ESR, 2023. New zealand national wastewater surveillance for covid-19. URL: <https://esr-cri.shinyapps.io/wastewater/>page=About.
- Fang, C., Wang, C., 2020. Time series data imputation: A survey on deep learning approaches. *arXiv preprint arXiv:2011.11347*.
- Farkas, K., Hillary, L.S., Thorpe, J., Walker, D.I., Lowther, J.A., McDonald, J.E., Malham, S.K., Jones, D.L., 2021. Concentration and quantification of SARS-Cov-2 RNA in wastewater using polyethylene glycol-based concentration and qRT-PCR. *Methods and Protocols* 4, 17.
- Fazli, M., Sklar, S., Porter, M.D., French, B.A., Shakeri, H., 2021. Wastewater-based epidemiological modeling for continuous surveillance of COVID-19 outbreak, in: 2021 IEEE International Conference on Big Data (Big Data), IEEE. pp. 4342–4349.
- Feng, S., Bootsma, M., McLellan, S.L., 2018. Human-associated lachnospiraceae genetic markers improve detection of fecal pollution sources in urban waters. *Applied and Environmental Microbiology* 84, e00309–18.
- Fernandez-Cassi, X., Scheidegger, A., Bänziger, C., Cariti, F., Corzon, A.T., Ganesanandamoorthy, P., Lemaitre, J.C., Ort, C., Julian, T.R., Kohn, T., 2021. Wastewater monitoring outperforms case numbers as a tool to track COVID-19 incidence dynamics when test positivity rates are high. *Water Research* 200, 117252.
- Fitzgerald, S.F., Rossi, G., Low, A.S., McAteer, S.P., O'Keefe, B., Findlay, D., Cameron, G.J., Pollard, P., Singleton, P.T., Ponton, K., et al., 2021. Site specific relationships between COVID-19 cases and SARS-Cov-2 viral load in wastewater treatment plant influent. *Environmental Science & Technology* 55, 15276–15286.
- Flood, M.T., D'Souza, N., Rose, J.B., Aw, T.G., 2021. Methods evaluation for rapid concentration and quantification of SARS-Cov-2 in raw wastewater using droplet digital and quantitative rt-pcr. *Food and*

- Environmental Virology 13, 303–315.
- Flood, M.T., Sharp, J., Bruggink, J., Cormier, M., Gomes, B., Oldani, I., Jimmy, L., Rose, J.B., 2023. Understanding the efficacy of wastewater surveillance for SARS-Cov-2 in two diverse communities. *Plos one* 18, e0289343.
- de Freitas Bueno, R., Claro, I.C.M., Augusto, M.R., Duran, A.F.A., Camillo, L.d.M.B., Cabral, A.D., Sodr e, F.F., Brand o, C.C.S., Vizzotto, C.S., Silveira, R., et al., 2022. Wastewater-based epidemiology: A Brazilian SARS-Cov-2 surveillance experience. *Journal of Environmental Chemical Engineering* 10, 108298.
- Galani, A., Aalizadeh, R., Kostakis, M., Markou, A., Alygizakis, N., Lytras, T., Adamopoulos, P.G., Peccia, J., Thompson, D.C., Kontou, A., et al., 2022. SARS-Cov-2 wastewater surveillance data can predict hospitalizations and ICU admissions. *Science of The Total Environment* 804, 150151.
- Gerrity, D., Papp, K., Stoker, M., Sims, A., Frehner, W., 2021. Early-pandemic wastewater surveillance of SARS-Cov-2 in Southern Nevada: Methodology, occurrence, and incidence/prevalence considerations. *Water Research X* 10, 100086.
- Gibas, C., Lambirth, K., Mittal, N., Juel, M.A.I., Barua, V.B., Brazell, L.R., Hinton, K., Lontai, J., Stark, N., Young, I., et al., 2021. Implementing building-level SARS-Cov-2 wastewater surveillance on a university campus. *Science of The Total Environment* 782, 146749.
- Giraud-Billoud, M., Cuervo, P., Altamirano, J.C., Pizarro, M., Aranibar, J.N., Catapano, A., Cuello, H., Masachessi, G., Vega, I.A., 2021. Monitoring of SARS-Cov-2 RNA in wastewater as an epidemiological surveillance tool in Mendoza, Argentina. *Science of The Total Environment* 796, 148887.
- Gonz lez-Reyes, J.R., Hern andez-Flores, M.d.I.L., Paredes-Zarco, J.E., T ellez-Jurado, A., Fayad-Meneses, O., Carranza-Ram rez, L., 2021. Detection of SARS-Cov-2 in wastewater northeast of Mexico City: Strategy for monitoring and prevalence of COVID-19. *International Journal of Environmental Research and Public Health* 18, 8547.
- Gupta, S., Parker, J., Smits, S., Underwood, J., Dolwani, S., 2020. Persistent viral shedding of SARS-Cov-2 in faeces—a rapid review. *Colorectal Disease* 22, 611–620.
- Hamouda, M., Mustafa, F., Maraqa, M., Rizvi, T., Hassan, A.A., 2021. Wastewater surveillance for SARS-Cov-2: Lessons learnt from recent studies to define future applications. *Science of The Total Environment* 759, 143493.
- Hasing, M., Yu, J., Qiu, Y., Maal-Bared, R., Bhavanam, S., Lee, B., Hruday, S., Pang, X., 2021. Comparison of detecting and quantifying SARS-Cov-2 in wastewater using moderate-speed centrifuged solids versus an ultrafiltration method. *Water* 13, 2166.
- Hata, A., Honda, R., Hara-Yamamura, H., Meuchi, Y., 2020. Identification of SARS-Cov-2 in wastewater in Japan by multiple molecular assays—implication for wastewater-based epidemiology (wbe). *MedRxiv*, 2020–06.
- Heijnen, L., Medema, G., 2011. Surveillance of influenza A and the pandemic influenza A (H1N1) 2009 in sewage and surface water in the Netherlands. *Journal of Water and Health* 9, 434–442.
- Hoar, C., Chauvin, F., Clare, A., McGibbon, H., Castro, E., Patinella, S., Katehis, D., Dennehy, J.J., Trujillo, M., Smyth, D.S., et al., 2022. Monitoring SARS-Cov-2 in wastewater during New York City's second wave of COVID-19: Sewershed-level trends and relationships to publicly available clinical testing data. *Environmental Science: Water Research & Technology* 8, 1021–1035.
- Hopkins, L., Persse, D., Caton, K., Ensor, K., Schneider, R., McCall, C., Stadler, L.B., 2023. Citywide wastewater SARS-Cov-2 levels strongly correlated with multiple disease surveillance indicators and outcomes over three COVID-19 waves. *Science of The Total Environment* 855, 158967.
- Jarvie, M.M., Reed-Lukomski, M., Southwell, B., Wright, D., Nguyen, T.N., 2023. Monitoring of COVID-19 in wastewater across the eastern upper peninsula of Michigan. *Environmental Advances* 11, 100326.
- Jiang, G., Wu, J., Weidhaas, J., Li, X., Chen, Y., Mueller, J., Li, J., Kumar, M., Zhou, X., Arora, S., et al., 2022. Artificial neural network-based estimation of COVID-19 case numbers and effective reproduction rate using wastewater-based epidemiology. *Water Research* 218, 118451.
- Jmii, H., Gharbi-Khelifi, H., Assaoudi, R., Aouni, M., 2021. Detection of SARS-Cov-2 in the sewerage system in Tunisia: A promising tool to confront COVID-19 pandemic. *Future Virology* 16, 751–759.
- Jones, D.L., Baluja, M.Q., Graham, D.W., Corbishley, A., McDonald, J.E., Malham, S.K., Hillary, L.S., Connor, T.R., Gaze, W.H., Moura, I.B., et al., 2020. Shedding of SARS-Cov-2 in feces and urine and its potential role in person-to-person transmission and the environment-based spread of COVID-19. *Science of The Total Environment* 749, 141364.
- Joseph-Duran, B., Serra-Compte, A., S rrias, M., Gonzalez, S., L pez, D., Prats, C., Catal , M., Alvarez-Lacalle, E., Alonso, S., Arnaldos, M., 2022. Assessing wastewater-based epidemiology for the prediction of SARS-Cov-2 incidence in Catalonia. *Scientific Reports* 12, 1–11.
- Kalman, R.E., 1960. A new approach to linear filtering and prediction problems. *Journal of Basic Engineering* 82 (Series D), 35–45.
- Karthikeyan, S., Levy, J.I., De Hoff, P., Humphrey, G., Birmingham, A., Jepsen, K., Farmer, S., Tubb, H.M., Valles, T., Tribelhorn, C.E., et al., 2022. Wastewater sequencing reveals early cryptic SARS-Cov-2 variant transmission. *Nature* 609, 101–108.
- Karthikeyan, S., Ronquillo, N., Belda-Ferre, P., Alvarado, D., Javidi, T., Longhurst, C.A., Knight, R., 2021. High-throughput wastewater SARS-Cov-2 detection enables forecasting of community infection dynamics in San Diego County. *Msystems* 6, e00045–21.
- Keshaviah, A., Huff, I., Hu, X.C., Guidry, V., Christensen, A., Berkowitz, S., Reckling, S., Noble, R.T., Clerkin, T., Blackwood, D., et al., 2022. Separating signal from noise in wastewater data: An algorithm to identify community-level COVID-19 surges. *medRxiv*, 2022–09.
- Kilaru, P., Hill, D., Anderson, K., Collins, M.B., Green, H., Kmush, B.L., Larsen, D.A., 2023. Wastewater surveillance for infectious disease: A systematic review. *American Journal of Epidemiology* 192, 305–322.
- King, A.A., Nguyen, D., Ionides, E.L., 2016. Statistical inference for partially observed Markov processes via the R package pomp. *Journal of Statistical Software* 69, 1–43.
- Kitakawa, K., Kitamura, K., Yoshida, H., 2023. Monitoring enteroviruses and SARS-Cov-2 in wastewater using the polio environmental surveillance system in Japan. *Applied and Environmental Microbiology* 89, e01853–22.
- Kitamura, K., Sadamasu, K., Muramatsu, M., Yoshida, H., 2021. Efficient detection of SARS-Cov-2 RNA in the solid fraction of wastewater. *Science of The Total Environment* 763, 144587.
- Krivo nkov, N.,  oltysov, A., Tams, M., Takc, Z., Krahulec, J., Ficek, A., Gl, M., Gall, M., Fehr, M., Krivjansk, A., et al., 2021. Mathematical modeling based on RT-qPCR analysis of SARS-Cov-2 in wastewater as a tool for epidemiology. *Scientific Reports* 11, 19456.
- Kuhn, K.G., Jarshaw, J., Jeffries, E., Adesigbin, K., Maytubby, P., Dundas, N., Miller, A.C., Rhodes, E., Stevenson, B., Vogel, J., et al., 2022. Predicting COVID-19 cases in diverse population groups using SARS-Cov-2 wastewater monitoring across Oklahoma City. *Science of The Total Environment* 812, 151431.
- La Rosa, G., Iaconelli, M., Mancini, P., Ferraro, G.B., Veneri, C., Bonadonna, L., Lucentini, L., Suffredini, E., 2020. First detection of SARS-Cov-2 in untreated wastewaters in Italy. *Science of The Total Environment* 736, 139652.
- Lamba, S., Daroch, N., Paul, K., Joshi, S.G., Mishra, R.K., Ramakrishnan, U., Ishtiaq, F., 2022. SARS-Cov-2 infection dynamics and genomic surveillance reveals early variant transmission in urban wastewater. *medRxiv*, 2022–07.
- Lara-Jacobo, L.R., Islam, G., Desaulniers, J.P., Kirkwood, A.E., Simmons, D.B., 2022. Detection of SARS-Cov-2 proteins in wastewater samples by mass spectrometry. *Environmental Science & Technology* 56, 5062–5070.
- LaTurner, Z.W., Zong, D.M., Kalvapalle, P., Gamas, K.R., Terwilliger, A., Crosby, T., Ali, P., Avadhanula, V., Santos, H.H., Weesner, K., et al., 2021. Evaluating recovery, cost, and throughput of different concentration methods for SARS-Cov-2 wastewater-based epidemiology. *Water Research* 197, 117043.
- Layton, B.A., Kaya, D., Kelly, C., Williamson, K.J., Alegre, D., Bachhuber, S.M., Banwarth, P.G., Bethel, J.W., Carter, K., Dalziel, B.D., et al.,

2022. Evaluation of a wastewater-based epidemiological approach to estimate the prevalence of SARS-Cov-2 infections and the detection of viral variants in disparate oregon communities at city and neighborhood scales. *Environmental Health Perspectives* 130, 067010.
- Lazuka, A., Arnal, C., Soyexu, E., Sampson, M., Lepeuple, A.S., Deleuze, Y., Pouradier Duteil, S., Lacroix, S., 2021. COVID-19 wastewater based epidemiology: long-term monitoring of 10 wwtp in france reveals the importance of the sampling context. *Water Science and Technology* 84, 1997–2013.
- Lemaitre, J.C., Perez-Saez, J., Azman, A.S., Rinaldo, A., Fellay, J., 2020. Assessing the impact of non-pharmaceutical interventions on SARS-Cov-2 transmission in switzerland. *medRxiv*, 2020–05.
- Li, G., Denise, H., Diggle, P., Grimsley, J., Holmes, C., James, D., Jersakova, R., Mole, C., Nicholson, G., Smith, C.R., et al., 2023a. A spatiotemporal framework for modelling wastewater concentration during the COVID-19 pandemic. *Environment International* 172, 107765.
- Li, L., Mazurowski, L., Dewan, A., Carine, M., Haak, L., Guarin, T.C., Dastjerdi, N.G., Gerrity, D., Mentzer, C., Pagilla, K.R., 2022. Longitudinal monitoring of SARS-Cov-2 in wastewater using viral genetic markers and the estimation of unconfirmed COVID-19 cases. *Science of The Total Environment* 817, 152958.
- Li, X., Kulandaivelu, J., Zhang, S., Shi, J., Sivakumar, M., Mueller, J., Luby, S., Ahmed, W., Coin, L., Jiang, G., 2021a. Data-driven estimation of COVID-19 community prevalence through wastewater-based epidemiology. *Science of The Total Environment* 789, 147947.
- Li, X., Liu, H., Gao, L., Sherchan, S.P., Zhou, T., Khan, S.J., van Loosdrecht, M.C., Wang, Q., 2023b. Wastewater-based epidemiology predicts COVID-19-induced weekly new hospital admissions in over 150 usa counties. *Nature Communications* 14, 4548.
- Li, X., Zhang, S., Sherchan, S., Orive, G., Lertxundi, U., Haramoto, E., Honda, R., Kumar, M., Arora, S., Kitajima, M., et al., 2023c. Correlation between SARS-Cov-2 RNA concentration in wastewater and COVID-19 cases in community: a systematic review and meta-analysis. *Journal of Hazardous Materials* 441, 129848.
- Li, X., Zhang, S., Shi, J., Luby, S.P., Jiang, G., 2021b. Uncertainties in estimating SARS-Cov-2 prevalence by wastewater-based epidemiology. *Chemical Engineering Journal* 415, 129039.
- López-Peñalver, R.S., Cañas-Cañas, R., Casaña-Mohedo, J., Benavent-Cervera, J.V., Fernández-Garrido, J., Juárez-Vela, R., Pellín-Carcelén, A., Gea-Caballero, V., Andreu-Fernández, V., 2023. Predictive potential of SARS-Cov-2 RNA concentration in wastewater to assess the dynamics of COVID-19 clinical outcomes and infections. *Science of The Total Environment* 886, 163935.
- Lu, X., Wang, L., Sakthivel, S.K., Whitaker, B., Murray, J., Kamili, S., Lynch, B., Malapatil, L., Burke, S.A., Harcourt, J., et al., 2020. US CDC real-time reverse transcription PCR panel for detection of severe acute respiratory syndrome coronavirus 2. *Emerging Infectious Diseases* 26, 1654.
- McMahan, C.S., Lewis, D., Deaver, J.A., Dean, D., Rennert, L., Kalbaugh, C.A., Shi, L., Kriebel, D., Graves, D., Popat, S.C., et al., 2022. Predicting COVID-19 infected individuals in a defined population from wastewater RNA data. *ACS Es&t Water* 2, 2225–2232.
- McMahan, C.S., Self, S., Rennert, L., Kalbaugh, C., Kriebel, D., Graves, D., Colby, C., Deaver, J.A., Popat, S.C., Karanfil, T., et al., 2021. COVID-19 wastewater epidemiology: a model to estimate infected populations. *The Lancet Planetary Health* 5, e874–e881.
- McMinn, B.R., Korajkic, A., Kelleher, J., Herrmann, M.P., Pemberton, A.C., Ahmed, W., Villegas, E.N., Oshima, K., 2021. Development of a large volume concentration method for recovery of coronavirus from wastewater. *Science of The Total Environment* 774, 145727.
- Medema, G., Heijnen, L., Elsinga, G., Italiaander, R., Brouwer, A., 2020. Presence of sars-coronavirus-2 RNA in sewage and correlation with reported COVID-19 prevalence in the early stage of the epidemic in the netherlands. *Environmental Science & Technology Letters* 7, 511–516.
- Miura, F., Kitajima, M., Omori, R., 2021. Duration of SARS-Cov-2 viral shedding in faeces as a parameter for wastewater-based epidemiology: Re-analysis of patient data using a shedding dynamics model. *Science of The Total Environment* 769, 144549.
- Mohapatra, S., Bhatia, S., Senaratna, K.Y.K., Jong, M.C., Lim, C.M.B., Gangesh, G.R., Lee, J.X., Giek, G.S., Cheung, C., Yutao, L., et al., 2023. Wastewater surveillance of SARS-Cov-2 and chemical markers in campus dormitories in an evolving COVID-19 pandemic. *Journal of Hazardous Materials* 446, 130690.
- Morvan, M., Jacomo, A.L., Souque, C., Wade, M.J., Hoffmann, T., Pouwels, K., Lilley, C., Singer, A.C., Porter, J., Evens, N.P., et al., 2022. An analysis of 45 large-scale wastewater sites in england to estimate SARS-Cov-2 community prevalence. *Nature Communications* 13, 4313.
- Nagarkar, M., Keely, S., Jahne, M., Wheaton, E., Hart, C., Smith, B., Garland, J., Varughese, E., Braam, A., Wiechman, B., et al., 2022. SARS-Cov-2 monitoring at three sewersheds of different scales and complexity demonstrates distinctive relationships between wastewater measurements and COVID-19 case data. *Science of The Total Environment* 816, 151534.
- Nauta, M., McManus, O., Franck, K.T., Marving, E.L., Rasmussen, L.D., Richter, S.R., Ethelberg, S., 2023. Early detection of local SARS-Cov-2 outbreaks by wastewater surveillance: a feasibility study. *Epidemiology & Infection* 151, e28.
- Navarro, A., Gómez, L., Sanseverino, I., Niegowska, M., Roka, E., Pedraccini, R., Vargha, M., Lettieri, T., 2021. SARS-Cov-2 detection in wastewater using multiplex quantitative pcr. *Science of The Total Environment* 797, 148890.
- NDCPA, 2023. National cdc: Covid-19 surveillance will be carried out in sewage treatment plants! URL: <https://www.h2o-china.com/news/340836.html>.
- Nemudryi, A., Nemudraia, A., Wiegand, T., Surya, K., Buyukyork, M., Cicha, C., Vanderwood, K.K., Wilkinson, R., Wiedenheft, B., 2020. Temporal detection and phylogenetic assessment of SARS-Cov-2 in municipal wastewater. *Cell Reports Medicine* 1.
- Ni, G., Lu, J., Maulani, N., Tian, W., Yang, L., Harliwong, I., Wang, Z., Mueller, J., Yang, B., Yuan, Z., et al., 2021. Novel multiplexed amplicon-based sequencing to quantify SARS-Cov-2 RNA from wastewater. *Environmental Science & Technology Letters* 8, 683–690.
- NICD, 2023. South africa national institute for communicable diseases. URL: <https://www.nicd.ac.za/about-us/>.
- Nkambule, S., Johnson, R., Mathee, A., Mahlangeni, N., Webster, C., Horn, S., Mangwana, N., Dias, S., Sharma, J.R., Ramharack, P., et al., 2023. Wastewater-based SARS-Cov-2 airport surveillance: key trends at the cape town international airport. *Journal of Water and Health* 21, 402–408.
- Nourbakhsh, S., Fazil, A., Li, M., Mangat, C.S., Peterson, S.W., Daigle, J., Langner, S., Shurgold, J., D'Aoust, P., Delatolla, R., et al., 2022. A wastewater-based epidemic model for SARS-Cov-2 with application to three canadian cities. *Epidemics* 39, 100560.
- Omori, R., Miura, F., Kitajima, M., 2021. Age-dependent association between SARS-Cov-2 cases reported by passive surveillance and viral load in wastewater. *Science of The Total Environment* 792, 148442.
- Ou, G., Tang, Y., Niu, S., Wu, L., Li, S., Yang, Y., Wang, J., Peng, Y., Huang, C., Hu, W., et al., 2023. Wastewater surveillance and an automated robot: effectively tracking SARS-Cov-2 transmission in the post-epidemic era. *National Science Review* 10, nwad089.
- Page, M.J., McKenzie, J.E., Bossuyt, P.M., Boutron, I., Hoffmann, T.C., Mulrow, C.D., Shamseer, L., Tetzlaff, J.M., Akl, E.A., Brennan, S.E., et al., 2021. The prisma 2020 statement: an updated guideline for reporting systematic reviews. *Bmj* 372.
- Peccia, J., Zulli, A., Brackney, D.E., Grubaugh, N.D., Kaplan, E.H., Casanovas-Massana, A., Ko, A.I., Malik, A.A., Wang, D., Wang, M., et al., 2020. Measurement of SARS-Cov-2 RNA in wastewater tracks community infection dynamics. *Nature Biotechnology* 38, 1164–1167.
- Pell, B., Brozak, S., Phan, T., Wu, F., Kuang, Y., 2023. The emergence of a virus variant: dynamics of a competition model with cross-immunity time-delay validated by wastewater surveillance data for COVID-19. *Journal of Mathematical Biology* 86, 1–34.
- Pellegrinelli, L., Castiglioni, S., Cocuzza, C.E., Bertasi, B., Primache, V., Schiarea, S., Salmoiraghi, G., Franzetti, A., Musumeci, R., Tilola, M., et al., 2022. Evaluation of pre-analytical and analytical methods for detecting SARS-Cov-2 in municipal wastewater samples in northern

- italy. *Water* 14, 833.
- Perez-Zabaleta, M., Archer, A., Khatami, K., Jafferli, M.H., Nandy, P., Atasoy, M., Birgersson, M., Williams, C., Cetecioglu, Z., 2023. Long-term SARS-Cov-2 surveillance in the wastewater of stockholm: What lessons can be learned from the swedish perspective? *Science of The Total Environment* 858, 160023.
- Phan, T., Brozak, S., Pell, B., Gitter, A., Xiao, A., Mena, K.D., Kuang, Y., Wu, F., 2023. A simple seir-v model to estimate COVID-19 prevalence and predict SARS-Cov-2 transmission using wastewater-based surveillance data. *Science of The Total Environment* 857, 159326.
- Philo, S.E., Keim, E.K., Swanstrom, R., Ong, A.Q., Burnor, E.A., Kossik, A.L., Harrison, J.C., Demeke, B.A., Zhou, N.A., Beck, N.K., et al., 2021. A comparison of SARS-Cov-2 wastewater concentration methods for environmental surveillance. *Science of The Total Environment* 760, 144215.
- Pillay, L., Amoah, I.D., Deepnarain, N., Pillay, K., Awolusi, O.O., Kumari, S., Bux, F., 2021. Monitoring changes in COVID-19 infection using wastewater-based epidemiology: A south african perspective. *Science of The Total Environment* 786, 147273.
- Pino, N.J., Rodriguez, D.C., Cano, L.C., Rodriguez, A., 2021. Detection of SARS-Cov-2 in wastewater is influenced by sampling time, concentration method, and target analyzed. *Journal of Water and Health* 19, 775–784.
- Polo, D., Quintela-Balaja, M., Corbishley, A., Jones, D.L., Singer, A.C., Graham, D.W., Romalde, J.L., 2020. Making waves: Wastewater-based epidemiology for COVID-19—approaches and challenges for surveillance and prediction. *Water Research* 186, 116404.
- Proverbio, D., Kemp, F., Magni, S., Ogorzaly, L., Cauchie, H.M., Gonçalves, J., Skupin, A., Aalto, A., 2022. Model-based assessment of COVID-19 epidemic dynamics by wastewater analysis. *Science of The Total Environment* 827, 154235.
- Rasero, F.J.R., Ruano, L.A.M., Del Real, P.R., Gómez, L.C., Lorusso, N., 2022. Associations between SARS-Cov-2 RNA concentrations in wastewater and COVID-19 rates in days after sampling in small urban areas of seville: A time series study. *Science of The Total Environment* 806, 150573.
- Reynolds, L.J., Gonzalez, G., Sala-Comorera, L., Martin, N.A., Byrne, A., Fennema, S., Holohan, N., Kuntamukkula, S.R., Sarwar, N., Nolan, T.M., et al., 2022. SARS-Cov-2 variant trends in ireland: Wastewater-based epidemiology and clinical surveillance. *Science of The Total Environment* 838, 155828.
- Róka, E., Khayer, B., Kis, Z., Kovács, L.B., Schuler, E., Magyar, N., Málnási, T., Oravecz, O., Pályi, B., Pándics, T., et al., 2021. Ahead of the second wave: Early warning for COVID-19 by wastewater surveillance in hungary. *Science of The Total Environment* 786, 147398.
- Rondeau, N.C., Rose, O.J., Alt, E.R., Ariyan, L.A., Elikan, A.B., Everard, J.L., Schreier, A.R., Tessler, M.E., Tulinsky, G.H., Vo, J.R., et al., 2023. Building-level detection threshold of SARS-Cov-2 in wastewater. *Microbiology Spectrum*, e02929–22.
- Rosario, K., Symonds, E.M., Sinigalliano, C., Stewart, J., Breitbart, M., 2009. Pepper mild mottle virus as an indicator of fecal pollution. *Applied and environmental microbiology* 75, 7261–7267.
- Rusiñol, M., Zammit, I., Itarte, M., Forés, E., Martínez-Puchol, S., Girones, R., Borrego, C., Corominas, L., Bofill-Mas, S., 2021. Monitoring waves of the COVID-19 pandemic: Inferences from wwtps of different sizes. *Science of The Total Environment* 787, 147463.
- Safford, H.R., Shapiro, K., Bischel, H.N., 2022. Wastewater analysis can be a powerful public health tool—if it's done sensibly. *Proceedings of the National Academy of Sciences* 119, e2119600119.
- Salvo, M., Moller, A., Alvareda, E., Gamazo, P., Colina, R., Victoria, M., 2021. Evaluation of low-cost viral concentration methods in wastewaters: Implications for SARS-Cov-2 pandemic surveillances. *Journal of Virological Methods* 297, 114249.
- Sangsanont, J., Rattanukul, S., Kongprajug, A., Chyerochana, N., Sresung, M., Sriporatana, N., Wanlapakorn, N., Poovorawan, Y., Mongkolsuk, S., Sirikanachana, K., 2022. SARS-Cov-2 RNA surveillance in large to small centralized wastewater treatment plants preceding the third COVID-19 resurgence in bangkok, thailand. *Science of The Total Environment* 809, 151169.
- Saththasivam, J., El-Malah, S.S., Gomez, T.A., Jabbar, K.A., Remanan, R., Krishnankutty, A.K., Ogunbiyi, O., Rasool, K., Ashhab, S., Rashkeev, S., et al., 2021. COVID-19 (SARS-Cov-2) outbreak monitoring using wastewater-based epidemiology in qatar. *Science of The Total Environment* 774, 145608.
- Schill, R., Nelson, K.L., Harris-Lovett, S., Kantor, R.S., 2023. The dynamic relationship between COVID-19 cases and SARS-Cov-2 wastewater concentrations across time and space: Considerations for model training data sets. *Science of The Total Environment* 871, 162069.
- Schmitz, B.W., Innes, G.K., Prasek, S.M., Betancourt, W.Q., Stark, E.R., Foster, A.R., Abraham, A.G., Gerba, C.P., Pepper, I.L., 2021. Enumerating asymptomatic COVID-19 cases and estimating SARS-Cov-2 fecal shedding rates via wastewater-based epidemiology. *Science of The Total Environment* 801, 149794.
- Scott, L.C., Aubee, A., Babahaji, L., Vigil, K., Tims, S., Aw, T.G., 2021. Targeted wastewater surveillance of SARS-Cov-2 on a university campus for COVID-19 outbreak detection and mitigation. *Environmental research* 200, 111374.
- Seurinck, S., Defoirdt, T., Verstraete, W., Siciliano, S.D., 2005. Detection and quantification of the human-specific hf183 bacteroides 16s rrna genetic marker with real-time pcr for assessment of human faecal pollution in freshwater. *Environmental microbiology* 7, 249–259.
- Shah, S., Gwee, S.X.W., Ng, J.Q.X., Lau, N., Koh, J., Pang, J., 2022. Wastewater surveillance to infer COVID-19 transmission: A systematic review. *Science of The Total Environment* 804, 150060.
- Sharara, N., Endo, N., Duvallet, C., Ghaeli, N., Matus, M., Heussner, J., Olesen, S.W., Alm, E.J., Chai, P.R., Erickson, T.B., 2021. Wastewater network infrastructure in public health: applications and learnings from the COVID-19 pandemic. *PLOS global public health* 1, e0000061.
- Shaukat, K., Alam, T.M., Luo, S., Shabbir, S., Hameed, I.A., Li, J., Abbas, S.K., Javed, U., 2021. A review of time-series anomaly detection techniques: A step to future perspectives, in: *Advances in Information and Communication: Proceedings of the 2021 Future of Information and Communication Conference (FICC)*, Volume 1, Springer. pp. 865–877.
- Smittenaar, P., Stewart, N., Sutermeister, S., Coome, L., Dibner-Dunlap, A., Jain, M., Caplan, Y., Campigotto, C., Sgaier, S.K., 2021. A COVID-19 community vulnerability index to drive precision policy in the us. *MedRxiv*, 2021–05.
- de Sousa, A.R.V., do Carmo Silva, L., de Curcio, J.S., da Silva, H.D., Eduardo Anunciação, C., Maria Salem Izacc, S., Neto, F.O.S., de Paula Silveira Lacerda, E., . pysewage. <http://www.pysewage.com.br>. Accessed: 2023-06-01.
- de Sousa, A.R.V., do Carmo Silva, L., de Curcio, J.S., da Silva, H.D., Eduardo Anunciação, C., Maria Salem Izacc, S., Neto, F.O.S., de Paula Silveira Lacerda, E., 2022. “pysewage”: a hybrid approach to predict the number of SARS-Cov-2-infected people from wastewater in brazil. *Environmental Science and Pollution Research* 29, 67260–67269.
- Street, R., Mathee, A., Mangwana, N., Dias, S., Sharma, J.R., Ramharack, P., Louw, J., Reddy, T., Brocker, L., Surujlal-Naicker, S., et al., 2021. Spatial and temporal trends of SARS-Cov-2 RNA from wastewater treatment plants over 6 weeks in cape town, south africa. *International Journal of Environmental Research and Public Health* 18, 12085.
- Tandukar, S., Sthapit, N., Thakali, O., Malla, B., Sherchan, S.P., Shakya, B.M., Shrestha, L.P., Sherchand, J.B., Joshi, D.R., Lama, B., et al., 2022. Detection of SARS-Cov-2 RNA in wastewater, river water, and hospital wastewater of nepal. *Science of The Total Environment* 824, 153816.
- Tomasino, M.P., Semedo, M., Vieira, P., Ferraz, E., Rocha, A., Carvalho, M.F., Magalhaes, C., Mucha, A.P., et al., 2021. SARS-Cov-2 RNA detected in urban wastewater from porto, portugal: Method optimization and continuous 25-week monitoring. *Science of The Total Environment* 792, 148467.
- Torii, S., Oishi, W., Zhu, Y., Thakali, O., Malla, B., Yu, Z., Zhao, B., Arakawa, C., Kitajima, M., Hata, A., et al., 2022. Comparison of five polyethylene glycol precipitation procedures for the rt-qpcr based recovery of murine hepatitis virus, bacteriophage phi6, and pepper mild mottle virus as a surrogate for SARS-Cov-2 from wastewater. *Science of The Total Environment* 807, 150722.

- Vallejo, J.A., Trigo-Tasende, N., Rumbo-Feal, S., Conde-Pérez, K., López-Oriona, Á., Barbeito, I., Vaamonde, M., Tarrío-Saavedra, J., Reif, R., Ladra, S., et al., 2022. Modeling the number of people infected with SARS-Cov-2 from wastewater viral load in northwest Spain. *Science of The Total Environment* 811, 152334.
- Varkila, M.R., Montez-Rath, M.E., Salomon, J.A., Yu, X., Block, G.A., Owens, D.K., Chertow, G.M., Parsonnet, J., Anand, S., 2023. Use of wastewater metrics to track COVID-19 in the US. *JAMA Network Open* 6, e2325591–e2325591.
- Wade, M., Jones, D., Singer, A., Hart, A., Corbishley, A., Spence, C., Morvan, M., Zhang, C., Pollock, M., Hoffmann, T., et al., 2020. Wastewater COVID-19 monitoring in the UK: Summary for Sage-19/11/20. Joint Biosecurity Centre.
- Wade, M.J., Lo Jacomo, A., Armenise, E., Brown, M.R., Bunce, J.T., Cameron, G.J., Fang, Z., Farkas, K., Gilpin, D.F., Graham, D.W., Grimsley, J.M., Hart, A., Hoffmann, T., Jackson, K.J., Jones, D.L., Lilley, C.J., McGrath, J.W., McKinley, J.M., McSparron, C., Nejad, B.F., Morvan, M., Quintela-Balaja, M., Roberts, A.M., Singer, A.C., Souque, C., Speight, V.L., Sweetapple, C., Walker, D., Watts, G., Weightman, A., Kasprzyk-Hordern, B., 2022. Understanding and managing uncertainty and variability for wastewater monitoring beyond the pandemic: Lessons learned from the United Kingdom national COVID-19 surveillance programmes. *Journal of Hazardous Materials* 424, 127456.
- Wadi, V.S., Daou, M., Zayed, N., Aljabri, M., Alsheraifi, H.H., Aldhaheeri, S.S., Abuoudah, M., Alhamadi, M., Aldhuhoori, M., Lopes, A., et al., 2023. Long-term study on wastewater SARS-Cov-2 surveillance across United Arab Emirates. *Science of The Total Environment* 887, 163785.
- Wang, P., Zarei-Baygi, A., Saucedo, C., Iskander, S.M., Smith, A.L., 2021. Long-term surveillance of wastewater SARS-Cov-2 in Los Angeles County. *Environmental Science: Water Research & Technology* 7, 2282–2294.
- Weidhaas, J., Aanderud, Z.T., Roper, D.K., VanDerslice, J., Gaddis, E.B., Ostermiller, J., Hoffman, K., Jamal, R., Heck, P., Zhang, Y., et al., 2021. Correlation of SARS-Cov-2 RNA in wastewater with COVID-19 disease burden in sewersheds. *Science of The Total Environment* 775, 145790.
- Westhaus, S., Weber, F.A., Schiwy, S., Linnemann, V., Brinkmann, M., Widera, M., Greve, C., Janke, A., Hollert, H., Wintgens, T., et al., 2021. Detection of SARS-Cov-2 in raw and treated wastewater in Germany—suitability for COVID-19 surveillance and potential transmission risks. *Science of The Total Environment* 751, 141750.
- Wilder, M.L., Middleton, F., Larsen, D.A., Du, Q., Fenty, A., Zeng, T., Insaf, T., Kilaru, P., Collins, M., Kmush, B., et al., 2021. Co-quantification of crassphage increases confidence in wastewater-based epidemiology for SARS-Cov-2 in low prevalence areas. *Water Research X* 11, 100100.
- Wölfel, R., Corman, V.M., Guggemos, W., Seilmaier, M., Zange, S., Müller, M.A., Niemeyer, D., Jones, T.C., Vollmar, P., Rothe, C., et al., 2020. Virological assessment of hospitalized patients with COVID-2019. *Nature* 581, 465–469.
- WRF, 2020. Water research foundation 2020 wastewater surveillance of the COVID-19 genetic signal in sewersheds. URL: https://www.waterrf.org/sites/default/files/file/2020-06/COVID-19_SummitHandout-v3b.pdf.
- Wu, Y., Guo, C., Tang, L., Hong, Z., Zhou, J., Dong, X., Yin, H., Xiao, Q., Tang, Y., Qu, X., et al., 2020. Prolonged presence of SARS-Cov-2 viral RNA in faecal samples. *The Lancet Gastroenterology & Hepatology* 5, 434–435.
- Wurtz, N., Lacoste, A., Jardot, P., Delache, A., Fontaine, X., Verlande, M., Annessi, A., Giraud-Gatineau, A., Chaudet, H., Fournier, P.E., et al., 2021. Viral RNA in city wastewater as a key indicator of COVID-19 recrudescence and containment measures effectiveness. *Frontiers in Microbiology* 12, 1157.
- Xiao, A., Wu, F., Bushman, M., Zhang, J., Imakaev, M., Chai, P.R., Duvallat, C., Endo, N., Erickson, T.B., Armas, F., et al., 2022. Metrics to relate COVID-19 wastewater data to clinical testing dynamics. *Water Research* 212, 118070.
- Yanaç, K., Adegoke, A., Wang, L., Uyaguari, M., Yuan, Q., 2022. Detection of SARS-Cov-2 RNA throughout wastewater treatment plants and a modeling approach to understand COVID-19 infection dynamics in Winnipeg, Canada. *Science of The Total Environment* 825, 153906.
- Zhao, L., Zou, Y., Li, Y., Miyani, B., Spooner, M., Gentry, Z., Jacobi, S., David, R.E., Withington, S., McFarlane, S., et al., 2022. Five-week warning of COVID-19 peaks prior to the Omicron surge in Detroit, Michigan using wastewater surveillance. *Science of The Total Environment* 844, 157040.
- Zheng, X., Deng, Y., Xu, X., Li, S., Zhang, Y., Ding, J., On, H.Y., Lai, J.C., Yau, C.I., Chin, A.W., et al., 2022. Comparison of virus concentration methods and RNA extraction methods for SARS-Cov-2 wastewater surveillance. *Science of The Total Environment* 824, 153687.
- Zhu, Y., Oishi, W., Maruo, C., Bandara, S., Lin, M., Saito, M., Kitajima, M., Sano, D., 2022. COVID-19 case prediction via wastewater surveillance in a low-prevalence urban community: a modeling approach. *Journal of Water and Health* 20, 459–470.
- Zuccato, E., Chiabrando, C., Castiglioni, S., Bagnati, R., Fanelli, R., 2008. Estimating community drug abuse by wastewater analysis. *Environmental Health Perspectives* 116, 1027–1032.

Appendix A

Table 4: Summarization of Correlation Studies between Viral Data and Clinical Data.

Location	Sampling			Total Samples	Corr. Type	Correlation			Ref.	
	Site/Pop.	Sample methods/Freq.	Study Period			Corr. Var. 1	Corr. Var. 2	Corr. Strength		Var. 2 Lag
Sendai Japan	1 WWTP 360,000	Grab 2/week (Tue & Thu, 10am)	Aug 2020 - Feb 2021	51	Spearman	2 week positive sample percentage 4 week positive sample percentage	2 week cumulative cases 4 week cumulative cases	0.4996 ($p < 0.05$) 0.7598 ($p < 0.05$)	9 days	Zhu et al. (2022)
Detroit USA	3 WWTPs 492,000 -1,482,000	24h composite weekly	Aug 2021 - Feb 2022	407	Pearson	Sum of viral conc. from 3 WWTPs by N1 gene Sum of viral conc. from 3 WWTPs by N2 gene	7-day moving avg. of COVID-19 cases	0.62 0.64	5 weeks	Zhao et al. (2022)
San Diego USA	1 WWTP 2.3 million	24h composite daily	Jul 2020 - Oct 2020	90	Pearson	Viral conc.	Daily hospital cases	0.75		Karthikeyan et al. (2021)
Budapest Hungary	3 WWTPs 1.8 million	24h composite & grab weekly (8 am-10 am)	Jun 2020 - Nov 2020	65	R^2 of linear regression	Sum of viral load from 3 WWTPs	7-day rolling avg. active cases Daily new cases Hospital cases Death cases	0.589 ($p < 0.001$) 0.67 ($p < 0.001$) 0.36 ($p < 0.01$) 0.235 ($p < 0.05$)	1 week 0 1 week 1 week	Róka et al. (2021)
Netherland	7 WWTPs 234,500 - 980,000	24h composite 8 days	Feb 2020 - Mar 2020	30	R^2 of linear regression	\log_{10} (viral load) by N1 gene \log_{10} (viral load) by N2 gene \log_{10} (viral load) by N3 gene C_t	\log_{10} (reported cases)	0.66 ($p < 0.01$) 0.59 ($p < 0.05$) 0.79 ($p < 0.001$) 0.77 ($p < 0.001$)		Medema et al. (2020)
Seville Spain	8 WWTPs 10,719 - 49,124	Grab weekly (9am-11am)	July 2020 - Jan 2021	199	Pearson	\log_{10} (population normalized viral load)	Active cases	0.52 0.51	4 days 6 days	Rasero et al. (2022)
Oklahoma City USA	13 manholes 3,729 - 52,323	Grab 2/week (10am-1pm)	Nov 2020 - Mar 2021		R^2 of linear regression	Avg. viral conc. from all locations Viral conc.	Reported cases in all areas Reported cases in sewershed	0.87 ($p < 0.01$) 0.41 - 0.95	7 days 4 - 10 days	Kuhn et al. (2022)
Los Angeles USA	5 WWTPs 150,000 - 4 million	24h composite weekly (1WWTP 2/week)	May 2020 - Mar 2021	250	Pearson	Viral conc. by N1 gene Viral conc. by N2 gene Smoothed viral conc. by N1 gene Smoothed viral conc. by N2 gene	New cases	0.88 ($p \ll 0.01$) 0.88 ($p \ll 0.01$) 0.94 ($p \ll 0.01$) 0.94 ($p \ll 0.01$)		Wang et al. (2021)
	1 WWTP	24h composite daily	Aug 16-22 2020	~7		Smoothed viral conc. by N1 gene Smoothed viral conc. by N2 gene		0.96 ($p < 0.005$) 0.96 ($p < 0.005$)	5 days 5 days	

Brazil	16 WWTPs & manholes 1,555,626 - 3,094,325	24h composite at WWTP 4h semi-composite at manhole	Jan 2021 - Jan2022		Spearman	Viral conc.	7-day cumulative new cases	0.41 - 0.63 ($p < 0.005$)		de Freitas Bueno et al. (2022)
Tulan University USA	Manholes <14,062	Grab weekly 10:30 am-11:30 am	Aug 2020 - Dec 2020	117	Spearman	Viral conc. by N1 gene Viral conc. by N2 gene	Reported cases Reported cases	0.5067 ($p < 0.0001$) 0.479 ($p < 0.0001$)		Scott et al. (2021)
Durham Canada	2 WWTPs 135,556 - 170,071	24h composite	Oct 2020 - Apr 2021	115	Pearson	Daily flow normalized pp1ab	Reported cases by onset date	0.4949 ($p < 0.0001$)	5 days	Lara-Jacobo et al. (2022)
Oregon USA	6 WWTPs 22 pump stations 10,853 - 258,910	24h composite 1-3/week	Apr 2020 - May 2021	52	Pearson	\log_{10} (viral conc.)	\log_{10} (reported cases/10,000) \log_{10} (estimated prevalence/10,000)	0.71 ($R^2 = 0.5$) 0.96 ($R^2 = 0.91$)		Layton et al. (2022)
North Carolina USA	19 WWTPs 3,500 - 550,000	24h composite 1-2/week	Jan 21 - Mar 22	1,783	Spearman	Arithmetic mean conc. of N1 & N2 genes normalized by flow rate and population	7-day rolling average of cases at the sewershed 7-day rolling average of cases at the county	0.47 - 0.88 0.55 - 0.9		Keshaviah et al. (2022)
Bratislava Slovak	2 WWTPs 0.6 million	24h composite weekly	Sep 2020 - Mar 2021	52	R^2 of linear regression	$\sqrt{\text{total viral load}}$ (from both WWTPs) $\ln(\text{total viral load})$ (from both WWTPs)	$\sqrt{\text{daily positive tests}}$ $\sqrt{\text{daily death cases}}$ $\sqrt{\text{weekly positive test}}$ $\sqrt{\text{weekly death cases}}$	0.5265 0.6189 0.8378 0.8321	12 days 27 days 2 weeks 4 weeks	Krivoňáková et al. (2021)
Mendoza Argentina	2 WWTPs 1.2 million	Grab weekly/biweekly (11am-1pm)	Jul 2020 - Jan 2021		Pearson	Viral conc. by N1 gene Viral conc. by N2 gene	Weekly reported cases	0.3185 - 0.5468, ($p \in [0.0069, 0.1386]$) 0.389 - 0.6282, ($p \in [0.1514 - 0.3946]$)		Giraud-Billoud et al. (2021)
Nepal	2 WWTPs, river, hospital, sewer	Grab	Jul 2020 - Feb 2021	84	Pearson	Viral conc.	Weekly new cases	0.47 - 0.5 ($p < 0.05$)		Tandukar et al. (2022)
Porto Portugal	2 WWTPs 370,000	24h composite weekly	Sep 2020 - Mar 2021	81	R^2 with linear regression	Viral conc. in liquid phase Viral conc. in solid phase	7-day moving avg. of new cases	0.2935 - 0.4223 ($p \in [4.6 \times 10^{-7}, 4.2 \times 10^{-5}]$) 0.1831 - 0.1865 ($p = 1.4 \times 10^{-3}$)		Tomasino et al. (2021)
Calgary Canada	3 WWTPs 6 sewers 1,441,268	24h composite ~3/week at WWTP biweekly at sewers	Jun 2020 - May 2021	222 from wwtp, 192 from neighborhood	Pearson	Viral conc.	5-day rolling avg. of new cases	0.33 - 0.82 ($p < 0.0001/p = 0.19$)	-4 - 4 weeks	Acosta et al. (2022)
Ohio USA	9 WWTPs 14,000 - 900,000	24h composite 2/week	Jul 2020 - Jan 2021	250	Pearson Spearman	Viral conc. Viral conc. Avg. viral conc. from all WWTPs	Reported cases on sampling date Reported cases on sampling date Reported cases on sampling date 3-day rolling avg. of reported cases 5-day rolling avg. of reported cases 7-day rolling avg. of reported cases	0.38 - 0.89 0.48 - 0.87 0.7 0.75 0.77 0.76		Ai et al. (2021)

Basel Switzerland	1 WWTP 273,075	24h composite during weekdays 48h composite during weekends 6/week	Jul 2021 - Dec 2021	179	Spearman	7-day median viral conc.	7-day median reported cases	0.9395	1 day	Bagutti et al. (2022)
Buenos Aires Argentina	3 WWTPs 1 manhole 3,500 - 35,407	Grab weekly (morning)	Jun 2020 - Apr 2021	172	Spearman	Viral conc.	10-day cumulative cases 15-day cumulative cases 20-day cumulative cases	0.476 - 0.795 ($p \in [1.98 \times 10^{-10}, 0.001]$) 0.443 - 0.807 ($p \in [6.23 \times 10^{-11}, 0.003]$) 0.499 - 0.812 ($p \in [4.085 \times 10^{-11}, 0.001]$)		Barrios et al. (2021)
Scotland	28 WWTPs 4,128 - 605,569	24h composite weekly	May 2020 - Jan 2021	989	Spearman	Viral conc. Viral load	Reported cases in the previous week Positive test rate Reported cases Positive test rate	0.79 0.83 0.91 0.77		Fitzgerald et al. (2021)
Attica Greece	1 WWTP 3,652,013	Composite daily	Aug 2020 - Mar 2021	203	R^2 of linear regression	Normalized viral load/100k inhabitants	4-day avg. positive cases 4-day avg. new hosp. admissions 4-day avg. new ICU admissions	0.947 0.888 0.877	3 - 4 days	Galani et al. (2022)
New York City USA	14 WWTPs 120,000 - 1.2million	24h composite 1-2/week	Aug 2020 - Jan 2021	~770	Spearman	Viral load	7-day avg. new cases	0.38 - 0.81		Hoar et al. (2022)
Northern Nevada, USA	3 WWTPs 390,750	Grab 3-5/week, (9am-12pm) 24h composite in 1 WWTP 7/week (Jul 2021-Sept 2021)	Jun 2020 - Sep 2021	614	Spearman	Viral conc. 7-day avg. viral conc. Viral conc. 7-day avg. viral conc.	Reported cases on sampling date 7-day avg. reported cases Lagged reported cases Lagged 7-day avg. reported cases	0.353 - 0.615 0.472 - 0.79 0.232 - 0.635 0.415 - 0.793	7 days 7 days	Li et al. (2022)
Hamilton USA	2 WWTPs 1 sewer 34,000 - 488,000	24h composite /3h composite weekly	May 2020 - Oct 2020	69	Pearson	Raw viral conc. by N1 gene Raw viral conc. by N2 gene Raw viral load by N1 gene Raw viral load by N2 gene Raw PMMoV normalized N1 gene Raw PMMoV normalized N2 gene OC43 recovery adjusted viral conc. by N1 gene OC43 recovery adjusted viral conc. by N2 gene OC43 recovery adjusted viral load by N1 gene OC43 recovery adjusted viral load by N2 gene	New cases	0.14 - 0.71 0.22 - 0.71 -0.063 - 0.7 0.014 - 0.7 0.1 - 0.63 0.15 - 0.61 0.31 - 0.63 0.31 - 0.68 0.16 - 0.58 0.17 - 0.64		Nagarkar et al. (2022)

						OC43 recovery adjusted PMMoV normalized N1 gene		0.25 - 0.64		
						OC43 recovery adjusted PMMoV normalized N2 gene		0.28 - 0.7		
Utah USA	10 WWTPs 9,095 - 515,494	24h composite	Apr 2020 - May 2020	126	Spearman	Viral load /person/day	Daily new cases Weekly cases/100k Lagged weekly cases/100k	0.54 ($p < 0.001$) 0.82 - 0.96 ($p < 0.003/p < 0.05$) 0.8 ($p < 0.01$)	1 week	Weidhaas et al. (2021)
Dublin Ireland	1 WWTP 1.9 million	24h composite 2/week	Jun 2020 - Aug 2021	99	Spearman	First order difference in N1 viral load First order difference in N1 viral conc.	First order difference in cases	0.5 ($p < 0.001$) 0.49 ($p < 0.001$)	0	Reynolds et al. (2022)
Catalonia Spain	10 WWTPs 7,000 - 1.5million	24h composite	Mar 2020 - Nov 2020	185	R^2 of linear regression	log(viral conc.) log(viral load)	log(cumulative cases in the following 7 days) log(cumulative cases in the previous 7 days) log(cumulative cases in the following 7 days) log(cumulative cases in the previous 7 days) log(cumulative cases in rolling 15 days) log(cumulative cases in the following 7 days) log(cumulative cases in the previous 7 days) log(cumulative cases in the following 7 days) log(cumulative cases in the previous 7 days) log(cumulative cases in rolling 15 days)	0.3839 0.2524 0.731 0.7092 0.6004 0.2839 0.1354 0.7515 0.7293 0.6691		Rusiñol et al. (2021)
Germany	9 WWTPs 120,000 - 2.4million	24h composite	Apr 2020		R^2 of linear regression	Viral load	Cumulative cases Acute cases Creatinine corrected cumulative cases Creatinine corrected acute cases	0.9730 0.9661 0.9603 0.9467		Westhaus et al. (2021)
Marseille France	Sewer 359,123 - 614,623	24h composite ~every 1.4days	Jul 2020 - Dec 2020	117	Cross correlation	Viral load	Reported cases	0.68 ($p < 0.01$)	0	Wurtz et al. (2021)
Frankfurt Germany	2 WWTPs 470,000 - 1.35 million	24h composite 2/week	Apr 2020 - Aug 2020	44	Spearman	Sum of viral load from both WWTPs	Reported cases/100k	0.7464 ($p = 0.00217$)		Agrawal et al. (2021)
Riyadh Saudi Arabia	3 WWTPs	Grab 1/month	Jun 2020 - Aug 2020	9	Spearman	C_T by N1 gene C_T by N2 gene C_T by E gene	Hospital reported cases 2 week after sampling	0.42 0.37 0.42		Alahdal et al. (2023)
Ottawa Canada	1 WWTP 1million	24h composite, every 2 days	Jun 2020 - Aug 2020		Pearson	PMMoV normalized viral load with N1 PMMoV normalized viral load with N2 gene PMMoV normalized viral load with N1 gene PMMoV normalized viral load with N2 gene	Daily new cases Positive test rate	0.673 ($p < 0.001$) 0.648 ($p < 0.001$) 0.468 ($p < 0.001$) 0.404 ($p < 0.001$)		D'Aoust et al. (2021a)

						PMMoV normalized viral load with N1 gene	Lagged daily new cases	0.703 ($p < 0.001$)	2 days	
						PMMoV normalized viral load with N2 gene		0.721 ($p < 0.001$)		
						PMMoV normalized viral load with N1 gene	Lagged hospital cases	0.741 ($p < 0.001$)	4 days	
						PMMoV normalized viral load with N2 gene		0.767 ($p < 0.001$)		
Ottawa & Gatineau Canada	2 WWTPs 280,000 - 1.1million	Grab every 2 weeks 24h composite every 2 days-1/week	Apr 2020 - Jun 2020	332	Pearson	Viral conc.	Daily cases	-0.209 - 0.399 ($p < 0.00$ */ $p = 0.003$)		
							Active cases	-0.233 - 0.95 ($p < 0.001$ / $p = 0.003$)		D'Aoust et al. (2021b)
							7-day rolling avg. positive rate	0.378 - 0.55 ($p < 0.001$ / $p = 0.003$)		
						Viral load	Daily cases	-0.48 - 0.05 ($p < 0.001$ / $p = 0.01$)		
							Active cases	-0.289 - 0.125 ($p < 0.001$ / $p = 0.298$)		
							7-day rolling avg. positive rate	-0.274 - 0.178 ($p \in [0.001, 0.008]$)		
						PMMoV normalized viral load	Daily cases	-0.48 - 0.05 ($p < 0.001$ / $p = 0.01$)		
							Active cases	-0.144 - 0.383 ($p \in [0.003, 0.049]$)		
							7-day rolling avg. positive rate	-0.022 - 0.639 ($p \in [0.003, 0.123]$)		
University of North Carolina Charlotte USA	building plumb & manholes	24h composite 3/week	Sep 2020 - Nov 2020	332	Pearson	Total number of positive wastewater samples	Daily new cases in the county	0.769		Gibas et al. (2021)
Bozeman USA	1 WWTP 49,831	24h composite	Mar 2020 - Apr 2020	17	Pearson	Viral conc.	Lagged cases by symptom onset date	0.972 - 0.995	-8 days	Nemudryi et al. (2020)
							Lagged positive tests	0.911 - 0.988	2 days	
Japan	2 WWTPs 1 manhole	Grab 1/week	Jun 2020 - Aug 2020	32	Spearman	Viral conc.	Number of case by report date	0.71 ($p < 0.01$)		Kitamura et al. (2021)
							Number of cases by symptom onset date	0.87 ($p < 0.001$)		
France	10 WWTPs 50,000 - 560,000	24h composite 2/week - 2/month	Jul 2020 - Dec 2020	138	Spearman	Viral conc. Viral load /100k inhabitant/day	log10 (7-day moving avg. incidence rate)	0.32 - 0.82		Lazuka et al. (2021)
								0.3 - 0.87		
Bangkok Thailand	19 WWTPs	24h composite	Jan 2021 - Apr 2021	132	Spearman	Positive rate of wastewater samples	Lagged 5-day avg. new cases	1	22 days	Sangsanont et al. (2022)
						log10(viral load)	Lagged new cases	0.85	23 - 24 days	
Cape Town South Africa	23 WWTPs	Grab 1/week (Monday)	Jul 2020 - Aug 2020	138	Spearman	Viral conc.	Reported cases	0.83 ($p = 0.0416$)		Street et al. (2021)
						PMMoV normalized total viral load from all WWTPs	Positive cases	0.84 ($p < 0.0001$)		
			Oct 2020 - Jan 2021 (Wave 2)				Number of patients in ICU	0.83 ($p < 0.0001$)		
				600	Pearson		Number of death	0.88 ($p < 0.0001$)		Perez-Zabaleta et al. (2023)
						PMMoV normalized total viral load from all WWTPs	Positive cases	0.88 ($p < 0.0001$)		
			Feb 2021 - May 2021 (Wave 3)				Number of patients in ICU	0.64 ($p = 0.0008$)		
						PMMoV normalized total viral load from all WWTPs	Positive cases	0.86 ($p < 0.0001$)		
			Apr 2020 - Jun 2022 (Entire Period)							

						Raw total viral load from all WWTPs		0.84		
						PMMoV normalized viral load	Positive cases in sewershed	$(p < 0.0001)$	0.85 - 0.88	
							14 day cumulative incidences	0.86	0	
			Nov 2020 - May 2021 (Wave 3)			Sum of viral conc. from all 3 WWTPs	Positive cases	0.85	0	
							Hospital cases	0.76	0	
							Critical hospital cases	0.65	-3 days	
							Death cases	0.04		
			Jun 21 - Jul 21 (Wave 5)	195	Pearson	Sum of viral conc. from all 3 WWTPs	14 day cumulative incidences	0.95		López-Peñalver et al. (2023)
							Positive cases	0.88		
							Hospital cases	0.64		
							Critical hospital cases	0.45		
							Death cases	0.29		
							14 day cumulative incidences	0.79	-1 day	
			Nov 21 - Jan 22 (Wave 6)			Sum of viral conc. from all 3 WWTPs	Positive cases	0.88	-2 days	
							Hospital cases	0.66	-1 day	
							Critical hospital cases	0.64	-1 day	
							Death cases	0.38		
Eastern upper Peninsula USA	13 WWTPs 3 sewers 280 - 19,668	Grab 1/week	Jun 2021 - Dec 2021		Spearman	Viral load	Clinical cases	0.48 - 0.89	0 - 7 days	Jarvie et al. (2023)
			Mar 2021 - Apr 2021 (Gamma wave)			Viral load	Positive tests	0.819 $(p < 0.01)$	3 days	
							Reported cases	0.786 $(p < 0.01)$	8 days	
							Active cases	0.747 $(p < 0.01)$	15 days	Belmonte-Lopes et al. (2023)
			Apr 2021 - Nov 2021 (Delta wave)	458	Spearman	Viral load	Positive tests	0.93 $(p < 0.01)$	3 days	
							Reported cases	0.938 $(p < 0.01)$	11 days	
							Active cases	0.936 $(p < 0.01)$	18 days	
			Nov 2021 - Nov 2022 (Omicron wave)			Viral load	Positive tests	0.927 $(p < 0.01)$	3 days	
							Reported cases	0.929 $(p < 0.01)$	5 days	
							Active cases	0.901 $(p < 0.01)$	10 days	
California USA	21 WWTPs 5 pump stations /manholes 2,200 - 4million	24h composite 1-5/week	Oct 2020 - Mar 2022	2,480	Kendall's τ -b	Viral conc. Flow normalized viral conc. PMMoV normalized viral conc.	7-day moving avg. cases	0.57 0.58 0.47		Schill et al. (2023)
			Aug 2020 - Jan 2021 (Wave 1)			Positive rate of wastewater samples	Positive rate of clinical tests	0.7	0	
			Jan 2021 - May 2021 (Wave 2)	16,858	Pearson	Positive rate of wastewater samples	Positive rate of clinical tests	-0.768 $(p < 0.0001)$	0	Wadi et al. (2023)
						Total viral load across the county	Weekly cases	-0.2 $(p = 0.3999)$		
			May 2021 - Dec 2021 (Wave 3)			Positive rate of wastewater samples	Positive rate of clinical tests	0.841 $(p < 0.0001)$	0	

			Dec 2021 - Apr 2022 (Wave 4)			Total viral load across the county	Weekly cases	0.88 ($p < 0.0001$)	
			May 2020 - Jun 2022 (Entire Period)			Positive rate of wastewater samples	Positive rate of clinical tests	0.504 ($p = 0.01$)	0
						Total viral load across the county	Weekly cases	0.671 ($p = 0.001$)	
						Total viral load across the county	Weekly cases	0.334 ($p = 0.004$)	
Cape Town South Africa	Pump station at Cape Town, International Airport	Grab, 1/week (Monday)	Dec 2020 - Feb 2021 (Alert L3) Oct 2021 - Dec 2021 (Alert L4) Dec 2020 - Jan 2022	55	Spearman	log(viral conc.)	Reported cases in Cape Town	0.54 ($p = 0.0084$)	
								0.69 ($p = 0.0046$)	
								0.52 ($p = 0.0001$)	-1 week
Michigan USA	2 WWTPs 25,000 - 110,267	24h composite, 1/week	Apr 2020 - Feb 2022	186	Pearson	Viral load /person/day with N1 gene	7-day avg. zipcode-level cases by symptom onset date	0.71 - 0.81 ($p < 0.0001$)	
							7-day avg. zipcode-level cases by referral date	0.62 - 0.72 ($p < 0.0001$)	Flood et al. (2023)
							7-day avg. county-level cases	0.53 - 0.59 ($p < 0.0001$)	
						Viral load /person/day with N2 gene	7-day avg. zipcode-level cases by symptom onset date	0.6 - 0.66 ($p < 0.0001$)	
							7-day avg. zipcode-level cases by referral date	0.51 - 0.6 ($p < 0.0001$)	
							7-day avg. county-level cases	0.46 - 0.56 ($p < 0.0001$)	
Northeastern Japan	2 WWTPs 200,000 - 500,000	Grab, 1/week- every 2 weeks	Aug 2020 - Nov 2021	81	Spearman	Viral conc.	New cases	0.61 ($p < 0.0001$)	Kitakawa et al. (2023)
Shenzhen China	2 WWTPs from hospital (emergency quarantine & whole hospital)	Grab 3/day (8am, 1pm, 6pm)	Aug 2022 - Sept 2022		Pearson	Emergency area viral conc.	Reported cases	0.76 ($p = 2.9 \times 10^{-6}$)	
							New cases	0.57 ($p = 1.6 \times 10^{-3}$)	Ou et al. (2023)
						Emergency area 10-day avg. viral conc.	Reported cases	0.99 ($p = 1 \times 10^{-13}$)	
						Whole hospital viral conc.	New cases	0.99 ($p = 8.4 \times 10^{-12}$)	
							Reported cases	0.64 ($p = 2.7 \times 10^{-4}$)	
National University of Singapore	7 sites divided into 28 discharge chambers 9,090	6h composite /12h composite	Jan 2021 - Mar 2022		Spearman	Aggregated weekly viral conc. at each site	Weekly reported cases at each site	0.5 - 0.76 ($p < 0.05$)	2 - 9 days
						aggregated weekly viral conc. over the campus	Weekly reported cases	0.76 ($p < 0.05$)	Mohapatra et al. (2023)
						PMMoV normalized viral conc.		0.78 ($p < 0.05$)	

Table 4 summarizes the correlation studies by their study location, sampling information (i.e., sampling site, method, frequency, and sampling period), and correlation details (i.e., correlation types, correlation variables, correlation strength, and time lag between the two variables). Specifically, the ‘Var. 2 lag’ column represents the lag of clinical data (i.e., *variable 2*) to viral levels (i.e., *variable 1*). Therefore, a negative lag time means the corresponding clinical data is leading the wastewater viral data. A positive lag time means the clinical data is lagging the viral data.

DRAFT

Appendix B

Table 5
Glossary of Terms

Name	Description
ANN	Artificial Neural Network model
ARIMA	AutoRegressive Integrated Moving Average
LOESS	Locally Estimated Scatterplot Smoothing model
LSOAs	Lower Super Output Areas
NWSS	National Wastewater Surveillance System
PCR	Polymerase Chain Reaction
PMMoV	Pepper Mild Mottle virus
QA	Quality Assurance
QC	Quality Control
RMSE	Root Mean Squared Error
SARIMA	AutoRegression Model with Seasonal Patterns
SEIR model	Susceptible Exposed Infectious Recovered model
VAR	Vector Autoregression
WBE	Wastewater-Based Epidemiology
WC ratio	the Ratio between Wastewater Viral Load and Clinical Cases

Appendix C

Correlation Metrics Details

This section will introduce the details of correlation metrics mentioned in section 5.2. Assume that the time series for wastewater viral data and clinical data are $X = \{x_1, x_2, \dots, x_n\}$ and $Y = \{y_1, y_2, \dots, y_n\}$ where the data pairs (x_t, y_t) are aligned at timestamp t . The correlations between the two time series under different metrics are defined as follows:

Pearson correlation: the Pearson correlation r_{XY} between time series X and Y is defined as

$$r_{XY} = \frac{\sum_{i=1}^n (x_i - \bar{x})(y_i - \bar{y})}{\sqrt{\sum_{i=1}^n (x_i - \bar{x})^2} \sqrt{\sum_{i=1}^n (y_i - \bar{y})^2}} \quad (4)$$

where $\bar{x} = \frac{1}{n} \sum_{i=1}^n x_i$ and $\bar{y} = \frac{1}{n} \sum_{i=1}^n y_i$ are the mean of the two series. The correlation score has a value between -1 and 1, which reflects the linear correlation of variables. One practical problem of Pearson correlation is its sensitivity to noise and outliers.

R² for linear regression model: assume that the clinical data Y can be fitted by the wastewater viral data X with linear regression model (e.g., $\hat{y}_i = a + bx_i$), then the coefficient of determination R^2 can be calculated as

$$R^2 = 1 - \frac{\sum_{i=1}^n (y_i - \hat{y}_i)^2}{\sum_{i=1}^n (y_i - \bar{y})^2} \quad (5)$$

The R^2 for the linear regression model can be used as a complementary metric for Pearson correlation as it provides

a clear interpretation in terms of variance explained by the model. Moreover, it can be extended to multiple regression scenarios where multiple sources of clinical data are integrated into the regression model, which can improve the robustness of the model under noisy settings.

Spearman's rank correlation: The Spearman's rank correlation is used to evaluate the rank consistency between two data series. To calculate the correlation between X and Y , the two time series need to be converted into series of ranks R_X and R_Y . The correlation coefficient would then be calculated as the Pearson correlation between R_X and R_Y . The advantage of Spearman's correlation is that X and Y can be related by any monotonic function rather than the linear correlation as in Pearson correlation.

Kendall's τ correlation: The Kendall's τ correlation is defined by the concordance of data pairs. Specifically, for any pairs of data (x_i, y_i) and (x_j, y_j) , the two pairs are considered concordant if the sort order of (x_i, x_j) and (y_i, y_j) agrees. Based on that, the correlation can be calculated as

$$\tau = \frac{\# \text{concordant pairs} - \# \text{discordant pairs}}{\text{total pairs}} \quad (6)$$

The Kendall's τ correlation is similar to Spearman's rank correlation but is generally preferred when the sample size is small and when there are many tied values in the time series.