

# Bosehedral: Compiler Optimization for Bosonic Quantum Computing

<sup>1</sup>Junyu Zhou, <sup>1</sup>Yuhao Liu, <sup>2</sup>Yunong Shi, <sup>3</sup>Ali Javadi-Abhari, <sup>1</sup>Gushu Li  
<sup>1</sup>University of Pennsylvania, <sup>2</sup>AWS Quantum Technology, <sup>3</sup>IBM Quantum

**Abstract**—Bosonic quantum computing, based on the infinite-dimensional qumodes, has shown promise for various practical applications that are classically hard. However, the lack of compiler optimizations has hindered its full potential. This paper introduces Bosehedral, an efficient compiler optimization framework for (Gaussian) Boson sampling on Bosonic quantum hardware. Bosehedral overcomes the challenge of handling infinite-dimensional qumode gate matrices by performing all its program analysis and optimizations at a higher algorithmic level, using a compact unitary matrix representation. It optimizes qumode gate decomposition and logical-to-physical qumode mapping, and introduces a tunable probabilistic gate dropout method. Overall, Bosehedral significantly improves the performance by accurately approximating the original program with much fewer gates. Our evaluation shows that Bosehedral can largely reduce the program size but still maintain a high approximation fidelity, which can translate to significant end-to-end application performance improvement.

## I. INTRODUCTION

Bosonic quantum computing, also known as continuous-variable quantum computing [18], is built upon Bosonic modes. Contrary to qubit-based discrete variable quantum computing, the basic information processing unit in Bosonic quantum computing, the qumode, by itself has an infinite-dimensional state space (shown in Fig. 1). Bosonic quantum computing (QC) is attractive for multiple reasons: long lifetimes of qumodes (e.g., superconducting cavities [34]), the ability to transduce between stationary and flying (e.g., photonic) information [24], etc. In particular, Bosonic QC has strong built-in information encoding and processing capability to naturally and efficiently encode certain computations, such as Boson sampling [3] and Gaussian Boson Sampling [13], with various practical applications [6] (e.g., graph clique [4], graph similarity [30], point process [15], and molecule vibrational spectra simulation [14]) that are hard for classical computing. Recently, the quantum advantage [21, 40, 41] has been experimentally demonstrated on several Bosonic QC platforms. Several startups are pursuing the commercialization of Bosonic QC with various technologies [1, 17, 22, 33].

Despite the great hardware progress, the development of software and compiler optimizations for Bosonic QC is far behind. Early efforts on programming and compilation for Bosonic QC, including Strawberry Fields [17], Bosonic Qiskit [32], and Perceval [22], provide basic programming interfaces and operation decomposition functions [10, 28] but miss program optimizations. To summarize, compilation for Bosonic QC is in its infancy. In contrast to qubit-based QC, rich libraries of compilation passes [26, 31] are non-existent, hindering the full exploitation of these computing platforms.

The complexity of devising compiler optimizations for Bosonic QC arises from the inherent infinite-dimensional

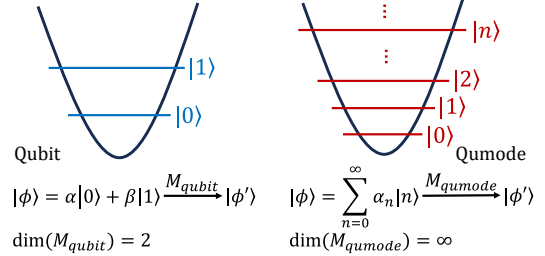

Fig. 1. Qubit vs Qumode

state space of each individual qumode [18]. All the gates manipulating the state of qumodes, even for a single qumode, have infinite-dimensional gate matrices. Thus, it is highly non-trivial for the quantum compiler that runs on a classical computer to derive equivalent program transformations for optimization. Traditional techniques employed for quantum program transformations on qubit-based devices, which rely on gate matrices, encounter substantial obstacles when confronting the infinite-dimensional qumode gate matrices.

In this paper, we tackle this grand challenge by investigating the compiler optimization in the **high-level semantics** of Bosonic QC. Instead of directly handling the infinite-dimensional gate matrices applied on the qumode state, the unique high-level semantics of Bosonic QC allow us to analyze and optimize the program components efficiently and effectively in a compact data structure. In particular, we focus on the linear interferometer, the pivotal component containing most of the gates in a (Gaussian) Boson sampling program (a widely used Bosonic QC paradigm illustrated in Fig. 2). A linear interferometer can be considered as a unitary matrix of size  $N \times N$  for an  $N$ -qumode program without losing any algorithmic information. All the program transformation and optimization techniques proposed in this paper can be reasoned about in the high-level unitary matrix.

To this end, we propose Bosehedral, an effective and efficient compiler optimization framework for (Gaussian) Boson sampling on Bosonic quantum hardware. In contrast to peephole approximations performed by qubit-based compilers [26, 31], Bosehedral can approximate and simplify circuits at a large scale by exploiting the global program semantics. **First**, Bosehedral optimizes the *qumode gate decomposition* for linear interferometers, which can be considered as adjusting the elimination patterns for different input high-level unitary matrices to maximize the occurrence of two-qumode gates with very small rotation angles. These small-angle gates are functionally akin to the identity and can be safely disregarded to reduce the gate error with minimal effect on the overall program semantics. **Second**, Bosehedral modifies the *logical-to-physical qumode mapping*, which can be considered as

applying row and column permutations on the high-level unitary. Bose can find better qumode mapping to further reduce rotation angles in the compiled two-qumode gates. The remapping is implemented via re-labeling the physical qumodes without any execution overhead. **Third**, Bosehedral comes with a *tunable probabilistic gate dropout* method to approximate linear interferometers. Gates with exceedingly small rotation angles will very likely be dropped, while gates with rotation angles near the threshold will be dropped probabilistically to average over the algorithmic approximation errors. As a result, Bosehedral can approximate (Gaussian) Boson sampling accurately using considerably fewer gates and thus substantially enhances the overall performance by largely mitigating the hardware error effects.

**Overall approximation effect reasoning** One key advantage of Bosehedral is that it can easily reason about the overall effect of the approximation during compilation time. After the gate decomposition and dropout, the global high-level semantics of the approximated program can be reconstructed by reversing the elimination process on the high-level unitary matrix. This is hard to achieve in the qubit-based approximation compilations because they usually rely on the unscalable low-level gate semantics and the gate matrices are exponentially large as the number of qubits increases.

Our experimental results show that Bosehedral can reduce gate by  $\sim 25\%$  to  $40\%$  but maintain program fidelity of  $\sim 98\%$  to  $99.9\%$  for various benchmarks and underlying architectures. Compared with the baseline Strawberry Fields [17], the divergence between the sampled output distribution in noisy simulation and the ideal output distribution is reduced by  $26.1\%$  on average, which translates to significant end-to-end application performance improvement as demonstrated in our detailed application studies.

Our major contributions can be summarized as follows:

- 1) We proposed Bosehedral, the first efficient and effective compiler optimization framework for (Gaussian) Boson sampling in Bosonic quantum computing.
- 2) Bosehedral overcomes the challenges of infinite-dimensional gate matrices by performing program analysis and compiler optimization at a high-level representation.
- 3) We proposed several compiler optimization algorithms for qumode gate decomposition, logical-to-physical qumode mapping, and probabilistic gate dropout for program simplification.
- 4) Our evaluation shows that Bosehedral can outperform baseline Bosonic quantum compilers by significantly improving the execution fidelity and the end-to-end application performance for various benchmarks and architectures.

## II. BACKGROUND

This section introduces the necessary background to understand the proposed compiler optimization techniques. We recommend [13, 18, 35] for more details about general Bosonic QC and Gaussian Boson sampling.

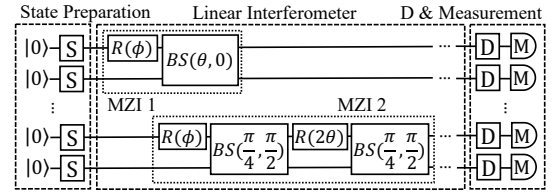

Fig. 2. Overview of a Gaussian Boson sampling (GBS) program

### A. Continuous Variable Quantum Computing

In discrete variable quantum computing, the basic information processing unit is a qubit, whose state lies in a two-dimensional Hilbert space spanned by two basis states  $|0\rangle$  and  $|1\rangle$ . In contrast, in the continuous variable scenario, the basic information processing unit is a Bosonic mode or qumode. Its state lies in infinite-dimensional Hilbert space spanned by the Fock basis:  $\{|n\rangle\}_{n=0}^{\infty}$ . For the  $k$ -th qumode, the annihilation operator  $\hat{a}_k$  and the creation operator  $\hat{a}_k^\dagger$  are defined as follows:

$$\begin{aligned}\hat{a}_k|n\rangle_k &= \sqrt{n}|n-1\rangle_k & \text{for } n \geq 1 \\ \hat{a}_k^\dagger|n\rangle_k &= \sqrt{n+1}|n+1\rangle_k & \text{for } n \geq 0\end{aligned}$$

and  $\hat{a}_k|0\rangle = 0$ . For an  $N$ -qumode system, we have the following operator vectors:

$$\hat{a} = (\hat{a}_1, \hat{a}_2, \dots, \hat{a}_N)^\top, \quad \hat{a}^\dagger = (\hat{a}_1^\dagger, \hat{a}_2^\dagger, \dots, \hat{a}_N^\dagger)^\top$$

Qumode gates are usually defined with the  $\hat{a}_k$ 's and  $\hat{a}_k^\dagger$ 's. Some common qumode gates used in this paper are listed in Fig. 2 and introduced in the following. **Squeezing Gate** is a single-qumode gate denoted by 'S'. A squeezing gate applied on the  $k$ -th qumode is defined as:  $S(\alpha) = \exp\left(\frac{1}{2}(\alpha^* \hat{a}_k^2 - \alpha \hat{a}_k^{\dagger 2})\right)$ , where  $\alpha \in \mathbb{C}$ . **Phase Shifter** is a single-qumode gate denoted by 'R'. A phase shifter applied on the  $k$ -th qumode is defined as:  $R(\phi) = \exp(i\phi \hat{a}_k^\dagger \hat{a}_k)$ , where  $\phi \in \mathbb{R}$ . **Beamsplitter** is a two-qumode gate denoted by 'BS'. A Beamsplitter applied on the  $k$ -th and  $l$ -th qumodes is defined as:  $BS(\theta, \phi) = \exp\left(\theta(e^{i\phi} \hat{a}_k \hat{a}_l^\dagger - e^{-i\phi} \hat{a}_k^\dagger \hat{a}_l)\right)$ , where  $\phi$  and  $\theta \in \mathbb{R}$ . **Displacement** is a single-qumode gate denoted by 'D'. A displacement gate applied on the  $k$ -th qumode is defined as:  $D(\alpha) = \exp(\alpha \hat{a}_k^\dagger - \alpha^* \hat{a}_k)$ , where  $\alpha \in \mathbb{C}$ . Note that all these gates have *infinitely-large gate matrices* as all  $\hat{a}_k$ s and  $\hat{a}_k^\dagger$ s are infinite-dimensional.

### B. Gaussian Boson Sampling

Gaussian Boson sampling (GBS) is a commonly used computation paradigm in Bosonic QC. As depicted in Fig. 2, a GBS program typically has three major steps: state preparation, linear interferometer, and measurement. Usually, all qumodes are initialized to the vacuum state  $|0\rangle$  with photon count 0. (Note that in Bosonic QC literature, many terms such as photons, interferometers, etc. are shared with photonics. However, in this paper, they represent purely software concepts, and can be implemented via diverse hardware platforms.) State preparation adds some photons to the system to prepare an initial state, which is done by applying squeezing gates in GBS. The prepared state will then be fed into a linear interferometer to perform a special calculation where the **high-**

**level semantics** is a unitary matrix  $\mathbf{U}$  applied on the vector of annihilation operators of the system and denoted as:

$$\hat{a} \rightarrow \hat{a}' = \mathbf{U}\hat{a}, \text{ where } \hat{a} = (\hat{a}_1, \hat{a}_2, \dots, \hat{a}_N)^T.$$

Finally, qumodes are measured. These measurements are typically performed on the Fock basis for GBS programs. Sometimes displacement gates are applied before the measurement, depending on the application.

The linear interferometer is the largest building block in GBS and needs to be decomposed into basic single- and two-qumode gates to be executed on hardware. A unitary matrix  $\mathbf{U}$  has the following decomposition formula [28]:

$$\mathbf{U} = \Lambda \left( \prod_{(m,n) \in \mathcal{S}} \mathbf{T}_{m,n}(\theta, \phi) \right) \quad (1)$$

Here  $\mathbf{T}_{m,n}(\theta, \phi)$  is a rotation in two-dimensional subspace, and  $\mathcal{S}$  is a set containing pairs that describe the information of the dimension where the rotation is acting on. We also call the parameter  $\theta$  as the rotation angle.  $\Lambda$  is the diagonal matrix whose diagonal entries  $\lambda_{ii}$  have modules  $|\lambda_{ii}| = 1$ . The matrix representation of  $\mathbf{T}_{m,n}(\theta, \phi)$  is:

$$\mathbf{T}_{m,n}(\theta, \phi) = \begin{array}{c} \text{column } m \qquad \qquad \text{column } n \\ \text{row } m \begin{pmatrix} \mathbb{I} & 0 & \cdots & 0 & 0 \\ 0 & e^{i\phi} \cos(\theta) & \cdots & -\sin(\theta) & 0 \\ \vdots & \vdots & \mathbb{I} & \vdots & \vdots \\ 0 & e^{i\phi} \sin(\theta) & \cdots & \cos(\theta) & 0 \\ 0 & 0 & \cdots & 0 & \mathbb{I} \end{pmatrix} \\ \text{row } n \end{array}$$

Each  $\mathbf{T}_{m,n}(\theta, \phi)$  can be implemented by an Mach-Zehnder interferometer (MZI) [27] circuit block applied on the  $m$ -th and  $n$ -th qumode [28]. This is the most expensive part of the computation due to noise. The error rate of a Beamsplitter can be over  $10\times$  higher than that of other single-qumode gates [8, 34]. One MZI block can be realized using a Phase Shifter  $R(\phi)$  on qumode  $m$  and a Beamsplitter  $BS(\theta, 0)$  on qumodes  $m$  and  $n$  ('MZI 1' in Fig. 2). Some Bosonic quantum hardware platforms only natively support fixed 50 : 50 Beamsplitters  $BS(\pi/4, \pi/2)$  [7]. In this way, one MZI block can be implemented with two Phase Shifters and two Beamsplitters ('MZI 2' in Fig. 2). The discussion in this paper assumes the first implementation, but our proposed techniques are equally effective if using the second implementation.

### C. Application Encoding in GBS

Many important applications can naturally be mapped to GBS, e.g., graph clique [4], graph similarity [30], point process [15], and molecule vibrational spectra simulation [14], and then solved with Bosonic QC [6]. These applications are hard on classical computers and are even not efficient in qubit-based QC. For example, molecule vibrational spectra simulation is modeling Bosons which have infinite-dimension state space. Bosonic QC has natural advantages here as the Bosons can be directly encoded in qumodes and the Boson operations are also usually natively supported on Bosonic QC hardware. These applications of different purposes can be programmed onto GBS devices by changing the qumode gates'

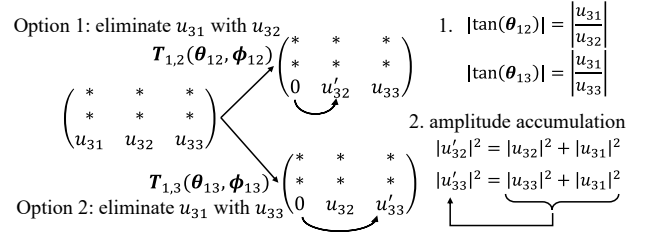

Fig. 3. Example of flexible decomposition

parameters and the linear interferometer's unitary matrix. The three-step overall GBS program structure remains unchanged. How to turn the application into its corresponding program parameter setup can be found in [6]. The techniques in this paper do not rely on any application-specific information.

## III. PROBLEM FORMULATION

In this section we introduce the high-level algorithmic optimization opportunity to overcome the challenge of infinite-dimensional qumode gate matrices and formulate our Bosonic compiler optimization problem.

### A. Opportunities from Decomposition Flexibility

The optimization opportunities come from the high-level algorithmic property of the  $\mathbf{T}_{m,n}(\theta, \phi)$  transformations. This transformation can be considered as using one entry in column  $n$  to eliminate the entry in column  $m$  in the unitary  $\mathbf{U}$ , similar to a Gaussian elimination process. Overall, the decomposition of  $\mathbf{U}$  is to find a series of  $\mathbf{T}_{m,n}(\theta, \phi)$  transformations to convert the unitary  $\mathbf{U}$  into a diagonal matrix. Note that the original decomposition formula in Equation (1) does not require any specific elimination order. Thus, the decomposition can be very flexible. Existing decomposition methods [10, 28] decompose the unitary into some special  $\mathbf{T}_{m,n}(\theta, \phi)$ 's where  $n = m + 1$  is always fixed. The optimization opportunities from the flexible decomposition were missed.

We first illustrate the flexible decomposition of the linear interferometer unitary with the example in Fig. 3. There are two decomposition options in Fig. 3 to perform elimination on the row  $(u_{31}, u_{32}, u_{33})$ . The first option in the upper half of Fig. 3 is to eliminate  $u_{31}$  with  $u_{32}$  using an MZI block  $\mathbf{T}_{1,2}(\theta_{12}, \phi_{12})$  on qumode 1 and 2. The parameters  $\theta_{12}$  and  $\phi_{12}$  are determined by  $u_{31}$  and  $u_{32}$  with following equation:

$$u_{31}e^{-i\phi_{12}} \cos(\theta_{12}) - u_{32} \sin(\theta_{12}) = 0 \quad (2)$$

We observe that there are two key properties of this elimination process that can help with the follow-up optimizations.

**First**, the rotation angle of the Beamsplitter in the generated MZI block satisfies:  $|\tan(\theta_{12})| = |u_{31}/u_{32}|$ . And we can notice that the parameter  $\theta_{12}$  will be very small when  $|u_{32}|$  is much larger than  $|u_{31}|$ . In this case, the Beamsplitter in the generated MZI block will be very close to an identity. Theoretically, the distance between a Beamsplitter with a small rotation angle  $\theta$  and the identity is bounded by  $\sim \theta^2/N$ .

**Second**, all the matrices we used in decomposition are unitary, and the norm in every column and every row is always

preserved. Therefore the amplitudes will be accumulated during the elimination. For example, in the first decomposition option in Fig. 3, the amplitude of the entry  $u_{31}$  will be accumulated into the new amplitude  $u'_{32}$  after the elimination with  $|u'_{32}|^2 = |u_{31}|^2 + |u_{32}|^2$ .

Another option shown in Fig. 3 is to eliminate  $u_{31}$  with  $u_{33}$ . This time the MZI block will be applied on qumode 1 and 3. The parameters and the amplitude accumulation will be different. This is a three-qumode example and the flexibility can be much larger with more qumodes.

### B. Compilation Problem Formulation

This paper also considers the hardware's characteristics. Similar to qubit-based quantum hardware, Bosonic quantum hardware suffers from noise, and it is desirable to reduce the number of gates, especially the expensive two-qumode Beamsplitters. We also consider the qumode connectivity constraints and only allow MZI blocks to be applied on physically-adjacent qumode pairs with native Beamsplitter support.

Here we formulate the compilation problem of this paper. Given the input GBS program and the underlying hardware constraints, Bosehdral needs to find 1) the logical-to-physical qumode mapping and 2) the decomposition of the linear interferometer unitary into hardware-supported MZI blocks. Moreover, to mitigate the hardware noise effects, Bosehdral aims to exploit the flexibility in decomposition such that the rotation angles in the generated Beamsplitters can be very small. These Beamsplitters are very close to the identity and can thus be dropped to mitigate their high gate error without significantly affecting the overall GBS program. Importantly, our method does not merely approximate the program, but it does so at the point of decomposition and mapping, and we have full control over the compiler output's accuracy.

## IV. ELIMINATION PATTERN FINDING

We will first introduce the unitary decomposition optimization in Bosehdral. Our objective is to maximize the generation of MZI blocks with small Beamsplitter rotation angles. Our decomposition approach will only generate MZI blocks that are compatible with the qumode without any remapping in the middle. We will assume a trivial logical-to-physical qumode mapping in this section and discuss the related further optimization in the next section. Our design is based on the widely used two-dimensional lattice hardware coupling structure. But our idea and design flow can be generalized to other layouts like triangular or hexagonal arrays.

### A. Elimination Pattern Template

We define an *elimination pattern template* to represent how the entries in the linear interferometer unitary  $U$  are eliminated. In this template, each node represents a qumode. When we eliminate one entry of one qumode  $i$  using the entry of another qumode  $j$ , we use a directed edge to connect the two corresponding qumodes from  $i$  to  $j$ .

**Baseline elimination** For example, the template in the upper part of Fig. 4 is the elimination template of existing

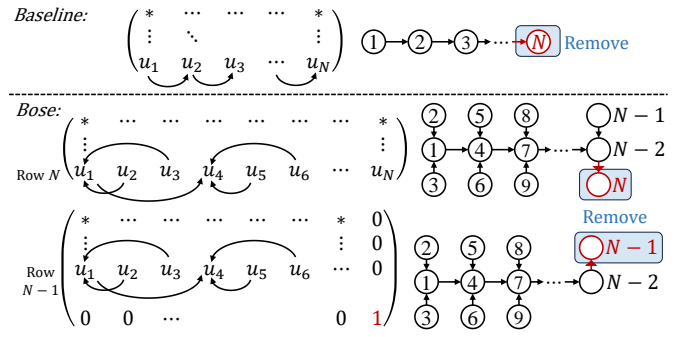

Fig. 4. Elimination pattern template: baseline vs Bosehdral

decomposition methods [10, 28]. It has a chain structure.  $u_1$  is first eliminated with  $u_2$  so there is an edge from qumode 1 to 2. Then  $u_2$  is eliminated with  $u_3$ ,  $u_4$  is eliminated with  $u_3$ , ..., and finally  $u_{N-1}$  is eliminated with  $u_N$ . After the elimination of the last row finishes,  $|u_N|$  should be 1 due to amplitude accumulation. Then for the next row  $N-1$ , the last node  $N$  in the elimination pattern is removed. The elimination of row  $N-1$  will follow the same pattern from  $u_1$  but terminate at  $u_{N-1}$ . The node  $N-1$  is then removed and the elimination of row  $N-2$  will begin. Such process repeats from row  $N$  to row 1 and all the nodes in the elimination pattern are removed.

Bosehdral leverages the elimination flexibility mentioned in Section III-A and redesigns a new elimination pattern. We first discuss the requirements and desired properties of such an elimination pattern graph.

First, the template must be a tree with all the directed edges from child nodes to parent nodes. As discussed in Section III-A, the amplitudes of the entries are accumulated during the elimination process. The directed edges in the graph then naturally represent the flow of the amplitude accumulation. To complete the elimination of one row in the unitary, all the amplitudes must be finally accumulated onto one entry and all other entries must be zeroed. A tree with all the directed edges from child nodes to parent nodes can naturally represent how the amplitudes are accumulated from the leaf nodes to the root node. The dependency is that the entry of a parent node can only eliminate the entry of one child node after the entry of this child node has eliminated the entries of all its child nodes. For example, in the middle of Fig. 4, we must first eliminate qumode 2 and 3 with qumode 1 before we can further eliminate qumode 1 with qumode 4.

Second, recall that we hope to generate MZI blocks with small Beamsplitter rotation angles for further optimization and approximation. This can be realized by eliminating a small entry with a large entry (recall the first property of elimination in Section III-A and Fig. 3). Meanwhile, the entries will become larger and larger as the elimination process gets close to the root due to the amplitude accumulation (the second property of elimination). If we can attach small entries to these entries with accumulated large amplitudes, we can create more large-small eliminations.

Finally, we also consider that this elimination pattern graph will later be physically realized in a two-dimensional lattice

coupling structure. Although we have not considered the actual mapping onto hardware, we require that each node in this graph can have at most four neighboring nodes, so that it can be later mapped onto the hardware without introducing complicated transformations.

With all these considerations, our elimination pattern template graph design is shown in the lower part of Fig. 4. Basically, we have a *main path* in this elimination pattern reflecting the main flow of amplitude accumulation (the chain of nodes 1, 4, ...). We can expect the amplitudes of previous nodes will be accumulated to the node throughout this main path, and they will be relatively large when they are used to eliminate other nodes. Thus for each node in the main path, we attach some leaf nodes as the *branches*. These branch nodes do not eliminate any other nodes so their amplitudes are expected to be small and large-small eliminations are created. Considering that each node has at most four neighbors, we attach two leaf nodes to each main path node, except the first and last node in the main path.

The elimination process is executed row by row from bottom to top. We start from row  $N$  and eliminate  $u_2$  and  $u_3$  with  $u_1$  first. Then  $u_1$  is eliminated with  $u_4$ . The elimination will follow the pattern on the right and finishes after accumulating all the amplitudes in row  $N$  to  $u_N$  and we have  $|u_N| = 1$ . All other entries in the column  $N$  will also become zero due to the column normalization of unitary matrices. Then we eliminate row  $N - 1$  and the node  $N$  is removed from the elimination pattern since there is no amplitude in the last entry of row  $N - 1$ . We also need a small modification at the end of the pattern, flipping the edge direction from  $N - 1$  to  $N - 2$ . This will make the elimination terminate at the  $N - 1$  node, which is a leaf node in the tree, and then this node  $N - 1$  is removed when eliminating the next row  $N - 2$ . Such an elimination process repeats from row  $N$  to 1. The MZI blocks in the decomposed circuit can be generated using the parameters of the  $\mathbf{T}_{m,n}(\theta, \phi)$ 's obtained in the elimination.

**Comparison against the baseline** Bose has a new elimination pattern that can leverage the properties of flexible elimination. By increasing the elimination happening between large and small entry pairs, our new elimination pattern can yield more MZI blocks with small rotation Beamsplitters to benefit follow-up optimization and approximation.

### B. Zigzag Elimination Pattern Embedding

The next step is to embed the elimination pattern into the actual hardware coupling graph, a two-dimensional lattice. We propose a Zigzag pattern embedding to maintain the overall structure in the original template. A general procedure is shown in Fig. 5 (a). We start the embedding by aligning the main path with the longer edge of the two-dimensional lattice. Here we start from the bottom left of the lattice and embed the pattern template in the first three rows. The start node of the main path is denoted as the ‘start point’. When the embedding reaches the right side, the main path will turn up and align with the column edge. Around the turning point, we may be unable to attach two branch nodes to each main path node. If

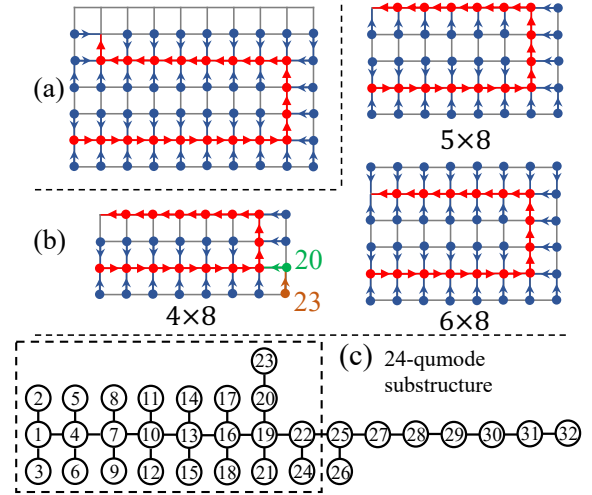

Fig. 5. Example of elimination pattern embedding

one node cannot be directly connected to the main path, we can attach it to one branch node (e.g., nodes 23 and 20 in Fig. 5 (b)). After we reach the next three rows, our main path will turn to the left and follow similar patterns to add branches. When we reach the left side, the main path will turn up again and finally formulate a Zigzag pattern. Depending on the result of the number of rows modulo 3, we may need to drop some branch nodes at the end. Fig. 5 (b) shows the three different cases. Finally, the main path will end on either the left or right edge at a point denoted as the ‘end point’.

### C. Sub-Pattern Selection

The last step is to select some of the physical qumodes for the follow-up computation when the total number of qumodes on the device exceeds the total number of logical qumodes in the program. Recall that the purpose of our template pattern is to use the entries on the main path to eliminate entries on the branches to produce small rotation angles. Therefore, we will select the qumodes on the main path connecting to more branch qumodes and disregard those main path qumodes with fewer branch qumodes.

Our physical qumode selection will first label all the physical qumodes based on a breadth-first-search starting with the first qumode (‘start point’) in the template pattern. Fig. 5 (c) shows an embedding structure that comes from a  $4 \times 8$  device. As shown in Fig. 5 (b), the qumodes that are far away from the start point will have fewer branches due to the edge of the two-dimensional lattice. We will choose the qumodes from the lower label to the higher label until the number of total qumodes is satisfied to implement the problem we are considering. An example of selecting a 24-qumode substructure from a 32-qumode  $4 \times 8$  device is in Fig. 5 (c).

## V. QUMODES MAPPING OPTIMIZATION

In the previous section, we select a hardware-compatible elimination pattern based on the trivial mapping. In this section, we will introduce how the logical-to-physical qumode mapping can be optimized to further improve the yield of small

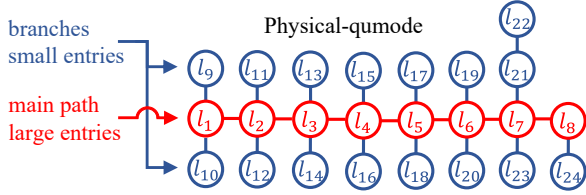

Fig. 6. Example of logical-to-physical mapping

Beamsplitter rotation angles via permutation operations that come with no execution overhead.

### A. Motivating Example

We introduce our qumode mapping algorithm with a motivating example considering the unitary decomposition in one row. Recall that the small rotation angles are expected to happen when we use a qumode in the main path of the pattern to eliminate another qumode on the branches. If we can map the qumodes with large entries in the unitary on the main path and those with small entries on the branches at the very beginning, the angles we produced during the elimination will be further reduced. Suppose we have a 24-dimensional vector:

$$(l_1, l_2, l_3, \dots, l_{24})$$

and we assume that their amplitudes satisfy  $|l_1| \geq |l_2| \geq \dots \geq |l_{24}|$  without loss of generality. In this example, we will perform elimination on this row using the 24-qumode elimination pattern from Fig. 5 (c).

A desired logical-to-physical qumode mapping of this example is depicted in Fig. 6. The 8-qumode row in the middle is our main path, with its branches on two sides. Since we want large entries to appear in the main path,  $l_1, l_2, \dots, l_8$  will be mapped to the main path from the start point because they are the largest one. After mapping the main path, we deal with the remaining branches, and the large entries remaining should be sent to the branch near the start point, thus  $l_9, l_{10}$  are branches to  $l_1$ , other mappings are similar. In this way, the accumulated amplitude will be even larger when the elimination process along the main path is approaching the end point, because the branch nodes with large amplitudes are attached close to the start point. The branch nodes attached to the main path nodes near the end point will have the smallest amplitudes.

A special case is that the qumode on the main path has 3 branch qumodes, like qumode contains  $l_7$  shown in Fig. 6. We will first map the larger one to the long branch, and the smaller one to the short branch. In Fig. 6, we put  $l_{21}$  and  $l_{22}$  to long side and  $l_{23}$  to the short side.

### B. Mapping via Permutation

The qumode mapping of GBS in this paper is highly different from its counterpart in discrete-variable quantum computing, the qubit mapping problem. The qubit mapping usually involves determining the initial logical-to-physical qubit layout and injecting SWAPs in the middle to resolve the dependencies for each two-qubit gate. In contrast, our mapping optimization will directly encode the mapping transition into the unitary, the high-level algorithmic representation of the linear interferometer. We identify that the qumode mapping in

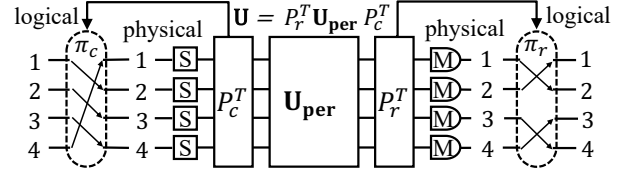

Fig. 7. Mapping via Permutation

GBS can be considered as adding permutation matrices before and after the unitary. And the permutation operations can be implemented without any additional gates.

We first show that performing the row permutation and column permutation to the unitary encoded in the GBS interferometer will not affect the final sampling result.

A matrix permutation can be expressed as:

$$\mathbf{U}_{\text{per}} = P_r \mathbf{U} P_c$$

where  $\mathbf{U}$  is the original matrix,  $\mathbf{U}_{\text{per}}$  is the matrix after permutation,  $P_r$  and  $P_c$  are row permutation and column permutation, respectively. We can rewrite the matrix  $\mathbf{U}$  as:

$$\mathbf{U} = P_r^T \mathbf{U}_{\text{per}} P_c^T$$

In this case, if we want to encode unitary matrix  $\mathbf{U}$  into the device, we can first encode the permutation  $P_c^T$ , then encode the unitary  $\mathbf{U}_{\text{per}}$ , and lastly encode another permutation  $P_r^T$ , as shown in Fig. 7.

Since the state preparation and measurement in GBS usually do not involve multi-qumode operations,  $P_c^T$  can be done by changing the initial logical-to-physical qumode mapping. Suppose the  $P_c^T$  is given by the following permutation:

$$i \rightarrow \pi_c(i)$$

this relationship means we transfer the qumode  $i$  into qumode  $\pi_c(i)$ , thus the physical qumode  $\pi_c(i)$  after  $P_c^T$  contains the qumode  $i$  before this permutation. As a result, to implement the same transformation we can omit the permutation  $P_c^T$  and map logical qumode  $i$  into the physical qumode  $\pi_c(i)$  directly, as shown on the left of Fig. 7.

Similarly for the permutation  $P_r^T$ , suppose we get *output* $_i$  in the physical qumode  $i$  after the unitary transformation  $\mathbf{U}_{\text{per}}$ , this output should lie in the physical qumode  $\pi_r(i)$  if we execute permutation  $P_r^T$ , where  $\pi_r(i)$  stands for the permutation given by  $P_r^T$ . Thus, instead of implementing the  $P_r^T$  in the circuit, we can directly obtain the output of logical qumode  $\pi_r(i)$  from the output of physical qumode  $i$ .

In summary, to obtain the GBS execution results with  $\mathbf{U}$  as the linear interferometer from the GBS experiments using the permuted unitary  $\mathbf{U}_{\text{per}}$ , we just need to relabel the qumodes before and after the GBS program based on the permutation matrices  $P_c^T$  and  $P_r^T$ .

### C. Two Properties of Elimination

We first introduce two mathematical properties of the elimination process. These two properties will guide the design of our qumode mapping algorithm. We use the example in Fig. 8. Suppose  $a$  and  $c$  have large amplitudes while  $b$  and  $d$  are much smaller. We use  $c$  to eliminate  $d$  in the last row.

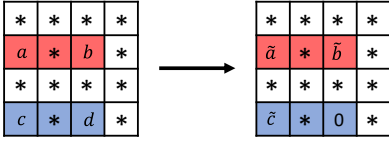

Fig. 8. Property of elimination

**First**, the elimination will not change the sum of the squares of the amplitudes in the region of a row containing all the entries that have changed in the elimination. In Fig. 8, we highlight the red region in the second row and the blue region in the last row. In the example, changes only happen in the first and third columns. The two highlighted regions contain all the entries that have changed values in the transformation. Note that:

$$\begin{cases} |a|^2 + |b|^2 = |\tilde{a}|^2 + |\tilde{b}|^2 \\ |c|^2 + |d|^2 = |\tilde{c}|^2 \end{cases}$$

Thus the sum of the squares of the amplitudes in the highlighted region will not change.

This property allows us to focus on the amplitude in the region as a whole instead of each entry's specific amplitude in this region. For example, in Fig. 8, when we decompose the last row, we may accumulate the amplitude of the first entry and second entry into the third entry. This process happens in the blue region, and then the third entry and the last entry can form a large-small pair to produce a small rotation angle. Because the sum of the squares of the amplitudes in the blue region is fixed, we can expect their amplitude accumulated as a whole to be large without checking each individual entry.

**Second**, the elimination for one row does not change the relative order of amplitudes of another row if the entries in both two rows are in decreasing order and the generated Beam-splitter rotation angle is small. That is, after the elimination, the amplitudes of  $\tilde{a}$  and  $\tilde{c}$  are still larger than that of  $\tilde{b}$ . This property can be understood with the formula that represents the elimination process:

$$\begin{cases} \tilde{a} = ae^{-i\phi} \cos(\theta) - b \sin(\theta), & \tilde{b} = ae^{-i\phi} \sin(\theta) + b \cos(\theta) \\ \tilde{c} = ce^{-i\phi} \cos(\theta) - d \sin(\theta), & 0 = ce^{-i\phi} \sin(\theta) + d \cos(\theta) \end{cases}$$

The last equation gives the relationship that:

$$|\tan(\theta)| = \left| \frac{d}{c} \right|$$

which indicates  $\theta$  is small since we assume  $d$  is small and  $c$  is large. From the first equation, we have the following:

$$\left| \frac{\tilde{a}}{a} \right| \geq |\cos(\theta)| - \left| \frac{b}{a} \right| |\sin(\theta)|$$

since  $\theta$  and  $\left| \frac{b}{a} \right|$  are small, the amplitude of  $\tilde{a}$  remains large. Similarly, the amplitude of  $\tilde{c}$  also remains large.

As for  $\tilde{b}$ , we can derive the inequality that:

$$\left| \frac{\tilde{b}}{a} \right| \leq |\sin(\theta)| + \left| \frac{b}{a} \right| |\cos(\theta)|$$

Since  $\theta$  and  $\left| \frac{b}{a} \right|$  are small, the amplitude of  $\tilde{b}$  remains small compared with  $a$ .

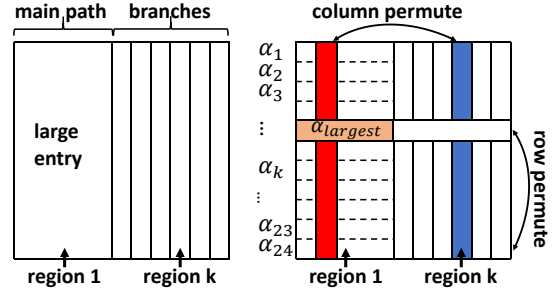

Fig. 9. Column and row permutations

This property is useful if we have a matrix in which the large entries appear in the beginning, and the small entries occur in the end for every row. Eliminating one of its rows won't change the order of absolute value in the remaining rows. As a result, if we find a good mapping for one of its rows (similar to the motivating example in Section V-A), the elimination of other rows can still benefit from this mapping after the elimination of this row.

#### D. Finding the Permutations

We now describe our mapping method based on the properties and observations above. We explain it using the 24-qumode elimination pattern in Fig. 6.

In the elimination pattern, there are 8 qumodes on the main path and 16 qumodes on the branches. Our objective is to map the large entries to the main path as much as possible. The first property allows us to consider the amplitudes in a region with multiple columns. So our first step is to move large entries to the left side via the column permutations. As depicted on the left of Fig. 9, we vertically divide the unitary into multiple regions. The first region is for the main path with 8 columns. The following regions are for the branches and each region corresponds to one branch. They usually have one or two columns because the branches have one or two qumodes.

After the column partition, we will calculate the sum of the squares of the amplitudes in the main path region in each row as shown on the right of Fig. 9. These summations are denoted as  $\{\alpha_1, \dots, \alpha_{24}\}$ . We denote the  $K$ -th largest one in this array as an indicator ( $K$  can be around the size of half of the unitary dimension). In practice, we select the value of  $K$  that can generate more small Beamsplitter rotation angles ( $\theta < 0.1$ ). This indicator generally represents the amplitudes of the main path region entries of the largest  $K$  rows. Then we try to exchange the columns in the main path region 1 with the columns of other regions. If we find that one exchange can increase the indicator, we will accept this exchange. Such a process will merge the large entries to the main path and the first few branches. With the recorded column exchanges, we will generate the overall column permutation.

We then find the row permutation. Since we decompose the unitary from the bottom row, we hope that rows with good numerical properties (i.e., those with large entries in the main path) are placed at the bottom. With those good rows at the bottom, we can take advantage of the second property of the

elimination process mentioned in Section V-C. These bottom rows are first executed and the elimination of these rows will not affect the good numerical properties of other rows. Overall, our row permutation is generated by reordering the rows based on the sum of the squares of the amplitudes in the main path region of each row.

## VI. PROBABILISTIC GATE DROPOUT

The previous optimizations on linear interferometer unitary decomposition and qumode mapping have increased the occurrence of small rotation angles in the Beamsplitters. In this section, we introduce the probabilistic gate dropout method that will select a sequence of rotation angles in the decomposition of unitary. The purpose of this probabilistic dropout method is to drop those Beamsplitters with very small rotation angles with high probabilities while those with rotation angles near the threshold will be dropped more randomly to average over the algorithmic errors incurred by the approximation.

**Reconstructing High-Level Semantics** One key advantage of Bosehedral is that Bosehedral can easily know the overall approximation effect after some gate dropout by reconstructing the high-level semantics from the decomposed gates. Recall the unitary decomposition formula in Equation 1. Once we drop some Beamsplitters, we can reuse this formula to calculate the approximated unitary by setting the  $\theta$ 's in the corresponding MZI blocks to be 0. For example, if we drop the Beamsplitter in the second and the third MZI blocks. We can just use the following formula to obtain the approximated unitary  $\mathbf{U}_{\text{app}}$  by setting  $\theta_2 = \theta_3 = 0$ :

$$\mathbf{U}_{\text{app}} = \Lambda(\mathbf{T}(\theta_1, \phi_1) \mathbf{T}(\theta_2 = 0, \phi_2) \mathbf{T}(\theta_3 = 0, \phi_3) \cdots)$$

Note that all the matrices in this formula have size  $N \times N$  so that the overall approximated unitary can be calculated efficiently. This allows us to easily know and tune how much approximation we will have during compilation time.

We now introduce our gate dropout method which monitors the overall approximation during dropout gate selection. After the decomposition, we will have  $N(N-1)/2$  MZI blocks with their Beamsplitter rotation angles  $\{\theta_1, \theta_2, \dots, \theta_{N(N-1)/2}\}$ . These angles will be selected using the following procedure.

- 1) We will select an accuracy threshold  $\tau$ . Then we find the angle threshold  $|\Theta|$  such that if we omit the rotations in which the angle's absolute value is less than  $|\Theta|$ , we can get the approximation unitary whose accuracy is just above the accuracy threshold  $\tau$ . Suppose there are  $M$  angles kept at this step.
- 2) All the angles are divided by  $|\Theta|$ . We will select a positive integer  $K$  and raise the absolute values of the angles in the list to the  $K$ -th power.

$$\{|\theta_1/\Theta|^K, |\theta_2/\Theta|^K, \dots, |\theta_{N(N-1)/2}/\Theta|^K\}$$

- 3) We normalize these new angles to construct a probability distribution:

$$p_i = \frac{|\theta_i/\Theta|^K}{\sum_{j=1}^{N(N-1)/2} |\theta_j/\Theta|^K}$$

TABLE I  
BENCHMARK INFORMATION

Benchmark	Qumode#	Squeezing	Displacement	Phase Shifter	Beamsplitter
DS	24	24	0	276	276
MC	24	24	0	276	276
GS	24	24	0	276	276
VS	24	24	24	276	276

This distribution represents how likely an angle  $\theta_i$  will be picked into matrix reconstruction. There are two special cases. If  $K = 1$ , we are randomly sampling the Beamsplitters by their rotation angle amplitudes. If  $K$  goes to infinite (usually 100 is enough), we simply drop the angles smaller than the angle threshold  $|\Theta|$ .

- 4) We select  $L$  as the number of iterations. We select  $M$  angles by the probability distribution for each iteration and reconstruct the approximation unitary matrix. We denote  $\tau_K$  as the average fidelity of the  $L$  iterations.
- 5) We find the positive integer  $K$  such that this process can maximize  $\tau_K$ . In this case, we are able to maximize the approximation accuracy with  $M$  MZI blocks.

After  $M$ ,  $|\Theta|$ , and  $K$  are determined, Bosehedral will generate the GBS circuit for each sample. One GBS program may require over thousands of repeated executions to obtain the final distribution. In each execution, we will use the probability distribution above to select  $M$  rotations and generate the GBS circuit with their associated MZI blocks.

## VII. EVALUATION

In this section, we evaluate Bosehedral by comparing with state-of-the-art baselines, analyze the effects of each optimization step, and perform end-to-end application performance studies.

### A. Experiments Setup

**Experiment Configurations:** To illustrate the effect of each optimization step, we design four experiment configurations. 1. 'Baseline' is to use the vanilla linear interferometer unitary decomposition [10] without any optimization. 2. 'Rot-Cut' is to directly drop gates under the baseline decomposition to reach a given unitary approximation rate. 3. 'Decomp-Opt' is to only use our optimized decomposition pattern with unitary approximation without qumode mapping optimization. 4. 'Full-Opt' is to apply all Bosehedral optimizations.

**Hardware Configuration:** Similar to the qubit-based superconducting quantum architectures, two-dimensional lattice coupling is widely adopted in both recent experimental progress [34] and schematic design of superconducting Bosonic processors [5]. We select three different 2D lattices:  $6 \times 6$ ,  $5 \times 7$ , and  $3 \times 8$ .

**Benchmarks:** We select four different typical GBS applications, Dense Subgraph (DS), Maximum Clique (MC), Graph Similarity (GS), and Molecule Vibration Spectra Simulation (VS), with four program instances for each benchmark. For DS, MC, and GS, we generate four random graphs of 24 nodes for each application and add edges between each pair of nodes with a probability of 0.7 to 0.9. The numbers of different types of gates for the benchmarks are listed in Table I. Note that for



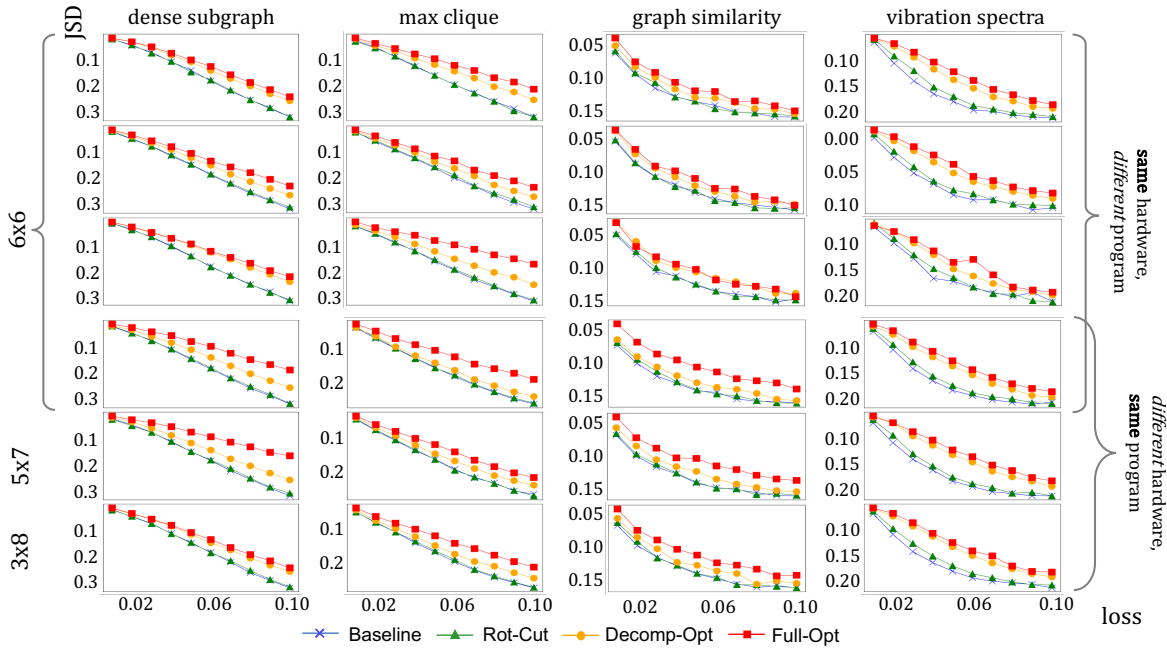

Fig. 10. Overall GBS execution quality improvement with Bosehdral optimizations

GBS programs, the numbers of gates mostly depend on the number of qumodes. For VS, we select the molecule Pyrrole using the data from Strawberry Fields [17]. We simulate its vibrational spectra at four temperatures (1000K, 750K, 500K, and 250K). All the programs in our benchmarks have 24 qumodes. This scale is limited by the classical simulator capability. One 24-qumode GBS experiment simulation requires a few CPU hours, and we report the simulation results of over 1000 GBS experiments in this paper.

**Metrics:** We use the Jensen-Shannon Divergence (JSD) [2] between the output distribution of the different experiment configurations and the standard output distribution as an application-independent metric to evaluate the improvement of Bosehdral. The standard distribution of each benchmark is generated by noise-free simulation of the original GBS program. The compilation effect is indicated by the fidelity of the approximated unitary matrix of the linear interferometer and the number of gates. The fidelity is defined as  $\text{tr}(\mathbf{U}_{app} \cdot \mathbf{U}^\dagger)/N$  for  $N$ -qumode programs where  $\mathbf{U}$  is the original  $N \times N$  unitary and  $\mathbf{U}_{app}$  is the approximated unitary. We also adopt application-specific metrics at the end to provide a more intuitive understanding of the end-to-end benefit of Bosehdral.

**Implementation:** We implemented Bosehdral in Python and leveraged basic infrastructure in Strawberry Fields [17]. Our noisy GBS simulation experiments are executed on the ‘Gaussian’ simulator backend in Strawberry Fields [17]. To the best of our knowledge, this is already the most advanced simulator available which can allow us to accurately simulate 24-qumode GBS experiments with noise. We simulate the gate photon loss error, which is the most significant error in Bosonic hardware and currently the only error type supported in the simulator, with an error rate ranging from 0.01 to 0.1 based on recent experimental data [8, 19]. Each GBS

TABLE II  
BEAMSPLITTER REDUCTION AND APPROXIMATED UNITARY FIDELITY

Benchmark & Fidelity	Rot-Cut	Decomp-Opt	Full-Opt (Avg. Beamsplitter #)
DS, 99.90%	4.3%	16.8%	28.8% (197)
MC, 99.96%	5.0%	18.4%	24.1% (210)
GS, 99.90%	3.4%	18.8%	26.0% (204)
VS, 98.00%	11.8%	34.7%	39.6% (167)

experiment is sampled by 10000 times. In the probabilistic gate dropout, the accuracy threshold  $\tau$  is set to be from 98.00% to 99.96%, then the Beamsplitter count  $M$  and angle threshold  $|\Theta|$  are determined as described in Section VI. The power index  $K$  is decided by repeating select  $M$  Beamsplitters and calculating the average unitary approximation fidelity in 10000 samples, and its value ranges from 20 to 100. The experiments are executed on a server with 16 CPU cores and 128GB memory.

### B. Overall Improvement

We first apply Bosehdral to approximate the linear interferometer to a certain fidelity for all the four benchmarks on the  $6 \times 6$  architecture, and the results are the first four rows in Fig. 10. The X-axis is the loss rate and the Y-axis is the Jensen-Shannon Divergence (JSD) between the output distribution of the standard output and the distribution of the corresponding experimental configuration. Each column represents one application and has four program instances for each. Table II shows the fidelities of the approximated unitaries and the gate count reduction Bosehdral is able to achieve. A small JSD will indicate better performance. It can be observed that as the loss increases, the JSD of ‘Full-Opt’ grows much slower than that of ‘Baseline’. On average, the JSD of ‘Full-Opt’ can be reduced by 31.6%, 33.8%, 12.6%, 26.4%, compared with ‘Baseline’ for the DS, MC, GS, and VS benchmarks, respectively. The great improvement comes from the fact that Bosehdral can approximate the linear

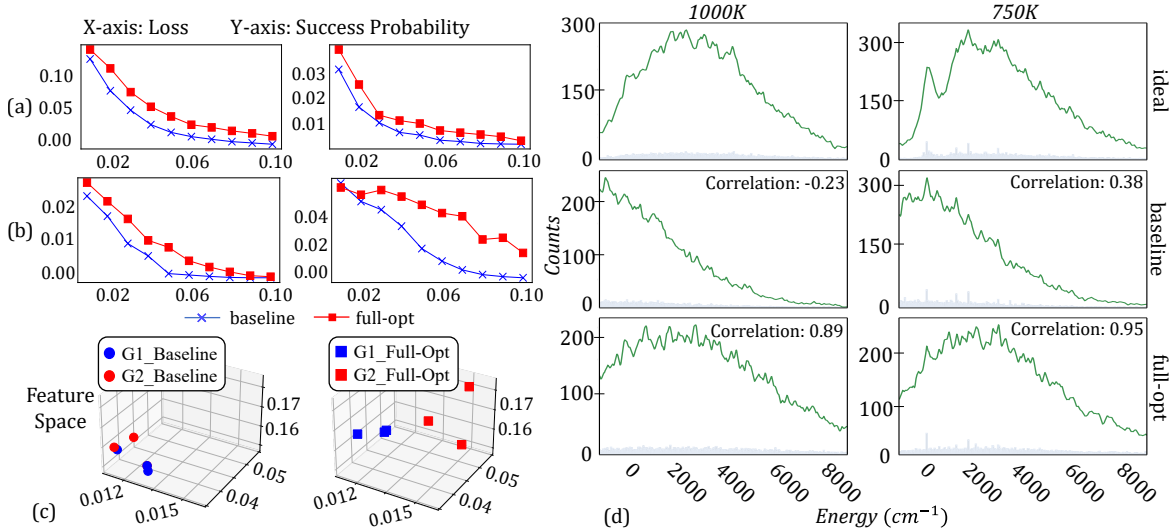

Fig. 11. End-to-end performance improvement. (a) Dense Subgraph, (b) Maximum Clique, (c) Graph Similarity, (d) Vibration Spectra

interferometer accurately using much fewer gates. As shown in Table II, ‘Full-Opt’ can reduce 28.8%, 24.1%, 26.0%, 39.6% Beamsplitters but still maintain the fidelity of the linear interferometer unitary over 99.90%, 99.96%, 99.90%, 98.00%, respectively. The average remaining Beamsplitter count for ‘Full-Opt’ is also in Table II. Note that the single-qumode gates are not changed in Bosehdral. In summary, with a tiny algorithmic error introduced in the unitary approximation, Bosehdral can improve the overall performance by largely mitigating the hardware error.

**Importance of new decomposition and mapping:** It can be observed that directly dropping the gates can hardly provide any improvement as the JSDs of ‘Baseline’ and Rot-Cut’ are very close (shown in Fig. 10). The Beamsplitter reduction is also very small (6.1% on average in Table II), indicating a large hardware error. These results suggest that the optimized decomposition pattern and qumode mapping is necessary to enable the optimizations in Bosehdral.

**Effect of Each Step:** The effect of the decomposition pattern optimization can be obtained by comparing ‘Decomp-Opt’ against ‘Baseline’. Fig. 10 shows that ‘Decomp-Opt’ can reduce the JSDs by 21.2%, 16.3%, 7.2%, 19.5%. Table II shows that ‘Decomp-Opt’ can reduce the gate count by 16.8%, 18.4%, 18.8%, 34.7%. The effect of qumode mapping can be observed when comparing ‘Full-Opt’ and ‘Decomp-Opt’. At the given approximated unitary fidelities, our logical-to-physical qumode mapping can further reduce the JSD by 10.4%, 17.5%, 5.4%, and 6.9% on average for the four benchmarks. Table II also shows that the Beamsplitter count reduction is increased by 12.0%, 5.7%, 7.2%, 4.9% (7.4% on average), respectively. The contribution breakdown between the decomposition optimization and the qumode mapping optimization is about 1.6 : 1 and 3.0 : 1 by comparing the JSD and Beamsplitter count reduction, respectively.

### C. Hardware Structure Impact

We also studied the impact of different hardware coupling structures, and the results are in the last three rows in Fig. 10.

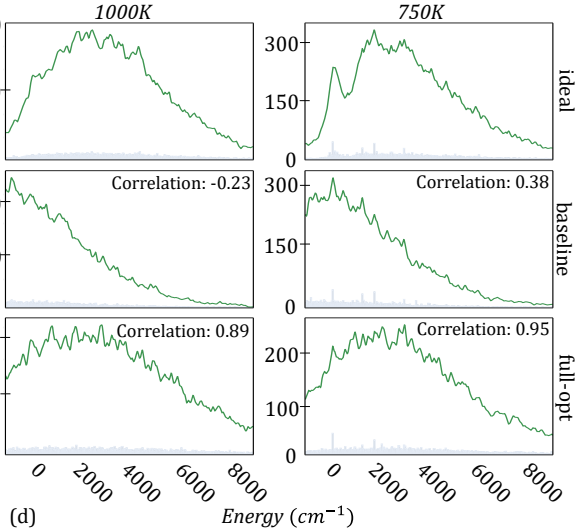

Each column represents one application, and each row represents one hardware structure. We select one program instance for each application (one random graph for DS, MC, GS, and the 750K temperature simulation for VS). The results of other program instances of one application are similar. It can be observed that the improvement of Bosehdral is not affected by changing to a different 2D lattice structure. On the  $5 \times 7$  and  $3 \times 8$  structures, the JSDs are reduced by 36.6%, 25.1%, 16.1%, 28.9% for the four benchmarks, which is similar to the improvement on  $6 \times 6$  structure.

### D. End-to-End Application Performance Improvement

In order to better understand the impact of Bosehdral optimizations on the end-to-end application performance, we append the post-GBS data processing for all the benchmarks and evaluate them case-by-case. The details of the post-processing procedures for the selected benchmarks are out-of-scope, but they can be found in [6].

**Dense Subgraph:** The GBS output will directly indicate a subgraph, and we measure the probability of successfully finding the densest subgraph of which the number of nodes is greater or equal to 10 in two of our random graphs, and the results are in Fig. 11 (a). The end-to-end success probability is increased by 64.1% on average after Bosehdral optimizations.

**Maximum Clique:** The GBS output will serve as an initial trial in a follow-up clique finding subroutine. We measure the probability of successfully finding the clique whose nodes are greater or equal to 10 in two random graphs, and the results are in Fig. 11 (b). The end-to-end success probability is increased by 72.9% on average after using Bosehdral.

**Graph Similarity:** The sampled output distribution will be converted into graph features. We randomly generate two highly-different graphs as two seeds and then generate two sets of similar graphs by adding small modifications to the two different seeds. Fig. 11 (c) shows the feature vectors in the feature space sampled from the graphs in the two similarity sets G1 and G2. On the left are the feature vectors obtained from ‘Baseline’. On the right are the feature vectors obtained

TABLE III  
PERFORMANCE AT DIFFERENT PROBLEM SCALES (FIDELITY=0.95)

Qumode #	10	15	20	60	100	200	500
BS Gate # drop	29.33%	34.9%	31.6%	27.6%	27.5%	27.3%	27.1%
Decomp time	0.013s	0.033s	0.056s	0.67s	2.4s	21.4s	615.6s
Total time	0.016s	0.039s	0.067s	0.85s	3.3s	32.3s	1071.1s

with ‘Full-Opt’. We can observe that the feature vectors are almost mixed for ‘Baseline’ as the significant photon loss error tends to lose information about the sampled graphs. But for the feature vectors of ‘Full-Opt’, they remain easily distinguishable for two clusters. We measure the distance between the two clusters’ central positions in Fig. 11 (c). It shows that the distance is increased by 135% after using Bose.

**Vibration Spectra:** We calculate the sampled molecule vibrational spectra using the GBS output. Fig. 11 (d) shows the simulated vibrational spectra at 1000K and 750K with loss at 0.02. The gray bars in the plot are the histogram of sampled energies and the green curve above is a Lorentzian broadening of the spectrum, which is a common practice in visualizing such a spectrum [6]. The first row is the standard vibrational spectra. The second row is the spectra obtained from the ‘Baseline’ configuration. The third row is the spectra obtained from ‘Full-Opt’. Compared with ‘Baseline’, the results of ‘Full-Opt’ are much more similar to the ideal spectra for both temperature settings. Quantitatively, the Pearson correlation coefficients between the spectra generated by ‘Baseline’ and the standard spectra are -0.23, 0.38 at 1000K and 750K, and the results of ‘Full-Opt’ have much higher correlation coefficients 0.89 and 0.95. A correlation coefficient closer to 1 is better. The spectra of the ‘Baseline’ tend to shift to the low energy side due to the photon loss during the simulation.

### E. Scalability Study

Although our GBS simulation is limited within 24 qumodes due to the complexity of classically simulating GBS, Bosehedral comes with great scalability and can be applied to much larger GBS programs. All the program analysis and compilation are performed on the high-level unitary representation of the linear interferometer, whose size grows linearly as the number of qumodes increases. The most time-consuming step is the matrix decomposition that has a complexity of  $O(N^3)$  where  $N$  is the number of qumodes. Here we select seven numbers of qumodes from 10 to 500. For each qumode count  $N$ , we randomly generate five unitaries as the interferometer, and then apply Bosehedral to optimize it with a unitary approximation fidelity at 95% on a  $3 \times \frac{N}{3}$  device. Table III shows the average results, including the gate count reduction, the decomposition time, and the total time, of applying full optimization on five random unitaries. Even for 500-qumode GBS programs, Bosehedral can still reduce the number of gates by 27.1% and the overall compilation time is less than half an hour.

## VIII. RELATED WORK

Bosehedral is a compiler framework that can effectively and efficiently optimize (Gaussian) Boson sampling for Bosonic QC. To the best of our knowledge, there is no closely related

work targeting the approximation of linear interferometers or the qumode mapping problem. We will briefly discuss the related works of the software frameworks for Bosonic QC, linear interferometer implementation, and approximated quantum compiler optimization.

**Bosonic Quantum Software Frameworks** There have been several early efforts on the software framework for programming and compilation of Bosonic QC, such as the Xanadu’s Strawberry Fields [17] and Quandela’s Perceval [22] from industry, as well as the Bosonic Qiskit [32] from academia. These works provide basic programming infrastructures for Bosonic QC but with almost no optimizations to the best of our knowledge. In addition, [16] studied the low-level pulse compilation for individual qumode gates with analytical solutions for a single superconducting qubit-qumode pair. [9] designed a language to describe the linear optic quantum circuit. [29] analyzed the continuous variable quantum compilation but failed to provide any actual optimizations. Unfortunately, none of them is able to simplify a Bosonic quantum program. As an initial effort, this paper identifies several new optimization opportunities for Bosonic quantum compilation and proposes the corresponding effective optimization algorithms.

**Linear Interferometer Implementation** To help design the linear optics experiments, previous works [10, 28] have studied how to implement a linear interferometer with available optics instruments. Their solutions later serve as the linear interferometer implementation methods in Bosonic QC software frameworks like the Strawberry Fields [17] and Perceval [22]. As introduced in Section IV-A (Fig. 4), they use a chain-structure elimination pattern with no remapping where it is hard to generate Beamsplitters with small rotations. In contrast, this paper redesigns the elimination pattern and adaptively remaps the qumodes to yield more Beamsplitters with small rotations and thus benefit the follow-up optimization.

**Approximated and Topology-Aware Quantum Compilation** The approximated or topology-aware compilation has been widely explored in qubit-based quantum computing. Notable examples include a series of works [11, 25, 36, 37, 39] in the BQSket project [38] as well as some other works [12, 20, 23]. However, due to the difficulty in evaluating the gate matrices when the number of qubits is large, their approximation calculation and topology-aware resynthesis are usually limited to small-scale circuit blocks at each step or special types of circuits. Moreover, such gate-matrix-based approaches are not applicable in Bosonic QC because of the built-in infinite-dimensional state spaces. This paper overcomes this challenge by leveraging the high-level scalable representation of general linear interferometers. And the proposed compilation techniques can easily control the overall approximation fidelity and perform large-scale topology-aware linear interferometer circuit synthesis and optimization.

## IX. CONCLUSION

This paper presented Bosehedral, an innovative and efficient compiler optimization framework tailored for (Gaussian) Boson sampling on Bosonic quantum hardware. By addressing

the challenge of infinite-dimensional qumode gate matrices and performing optimizations at a higher algorithmic level, Bosehdral significantly enhances the performance of Bosonic QC. The optimized qumode gate decomposition and logical-to-physical qumode mapping, along with the tunable probabilistic gate dropout method, demonstrate substantial improvements in reducing gate errors and approximating (Gaussian) Boson sampling with fewer gates. With Bosehdral, the full potential of Bosonic QC can be effectively harnessed, hastening the onset of a wide range of practical applications that were previously computationally intractable.

#### ACKNOWLEDGEMENT

We thank Nathan Wiebe and Steven Girvin for insightful discussions. This work was partially supported by NSF CAREER Award 2338773, and the U.S. Department of Energy, Office of Science, National Quantum Information Science Research Centers, Co-design Center for Quantum Advantage (C2QA) under contract number DE-SC0012704.

#### REFERENCES

- [1] “Careers // quantum circuits, inc.” <https://quantumcircuits.com/careers>, (Accessed on 11/21/2023).
- [2] “Jensen–shannon divergence - wikipedia,” [https://en.wikipedia.org/wiki/Jensen%E2%80%93shannon\\_divergence](https://en.wikipedia.org/wiki/Jensen%E2%80%93shannon_divergence), (Accessed on 08/06/2023).
- [3] S. Aaronson and A. Arkhipov, “The computational complexity of linear optics,” in *Proceedings of the Forty-Third Annual ACM Symposium on Theory of Computing*, ser. STOC ’11. New York, NY, USA: Association for Computing Machinery, 2011, p. 333–342. [Online]. Available: <https://doi.org/10.1145/1993636.1993682>
- [4] L. Banchi, M. Fingerhuth, T. Babej, C. Ing, and J. M. Arrazola, “Molecular docking with gaussian boson sampling,” *Science Advances*, vol. 6, no. 23, p. eaax1950, 2020. [Online]. Available: <https://www.science.org/doi/abs/10.1126/sciadv.aax1950>
- [5] A. Blais, A. L. Grimsmo, S. M. Girvin, and A. Wallraff, “Circuit quantum electrodynamics,” *Rev. Mod. Phys.*, vol. 93, p. 025005, May 2021. [Online]. Available: <https://link.aps.org/doi/10.1103/RevModPhys.93.025005>
- [6] T. R. Bromley, J. M. Arrazola, S. Jahangiri, J. Izaac, N. Quesada, A. D. Gran, M. Schuld, J. Swinarton, Z. Zabaneh, and N. Killoran, “Applications of near-term photonic quantum computers: software and algorithms,” *Quantum Science and Technology*, vol. 5, no. 3, p. 034010, may 2020. [Online]. Available: <https://dx.doi.org/10.1088/2058-9565/ab8504>
- [7] J. Carolan, C. Harrold, C. Sparrow, E. Martín-López, N. J. Russell, J. W. Silverstone, P. J. Shadbolt, N. Matsuda, M. Oguma, M. Itoh, G. D. Marshall, M. G. Thompson, J. C. F. Matthews, T. Hashimoto, J. L. O’Brien, and A. Laing, “Universal linear optics,” *Science*, vol. 349, no. 6249, pp. 711–716, 2015. [Online]. Available: <https://www.science.org/doi/abs/10.1126/science.aab3642>
- [8] B. J. Chapman, S. J. de Graaf, S. H. Xue, Y. Zhang, J. Teoh, J. C. Curtis, T. Tsunoda, A. Eickbusch, A. P. Read, A. Koottandavida, S. O. Mundhada, L. Frunzio, M. Devoret, S. Girvin, and R. Schoelkopf, “High-on-off-ratio beam-splitter interaction for gates on bosonically encoded qubits,” *PRX Quantum*, vol. 4, p. 020355, Jun 2023. [Online]. Available: <https://link.aps.org/doi/10.1103/PRXQuantum.4.020355>
- [9] A. Clément, N. Heurtel, S. Mansfield, S. Perdrix, and B. Valiron, “LO<sub>v</sub>-Calculus: A Graphical Language for Linear Optical Quantum Circuits,” in *47th International Symposium on Mathematical Foundations of Computer Science (MFCS 2022)*, ser. Leibniz International Proceedings in Informatics (LIPIcs), S. Szeider, R. Ganian, and A. Silva, Eds., vol. 241. Dagstuhl, Germany: Schloss Dagstuhl – Leibniz-Zentrum für Informatik, 2022, pp. 35:1–35:16. [Online]. Available: <https://drops.dagstuhl.de/opus/volltexte/2022/16833>
- [10] W. R. Clements, P. C. Humphreys, B. J. Metcalf, W. S. Kolthammer, and I. A. Walmsley, “Optimal design for universal multiport interferometers,” *Optica*, vol. 3, no. 12, pp. 1460–1465, Dec 2016. [Online]. Available: <https://opg.optica.org/optica/abstract.cfm?URI=optica-3-12-1460>
- [11] M. G. Davis, E. Smith, A. Tudor, K. Sen, I. Siddiqi, and C. Iancu, “Towards optimal topology aware quantum circuit synthesis,” in *2020 IEEE International Conference on Quantum Computing and Engineering (QCE)*, 2020, pp. 223–234. [Online]. Available: <https://doi.org/10.1109/QCE49297.2020.00036>
- [12] A. M.-v. de Griend and R. Duncan, “Architecture-aware synthesis of phase polynomials for nisq devices,” *arXiv preprint arXiv:2004.06052*, 2020. [Online]. Available: <https://arxiv.org/abs/2004.06052>
- [13] C. S. Hamilton, R. Kruse, L. Sansoni, S. Barkhofen, C. Silberhorn, and I. Jex, “Gaussian boson sampling,” *Phys. Rev. Lett.*, vol. 119, p. 170501, Oct 2017. [Online]. Available: <https://link.aps.org/doi/10.1103/PhysRevLett.119.170501>
- [14] J. Huh, G. G. Guerreschi, B. Peropadre, J. R. McClean, and A. Aspuru-Guzik, “Boson sampling for molecular vibronic spectra,” *Nature Photonics*, vol. 9, no. 9, pp. 615–620, aug 2015. [Online]. Available: <https://doi.org/10.1038/2Fnphton.2015.153>
- [15] S. Jahangiri, J. M. Arrazola, N. Quesada, and N. Killoran, “Point processes with gaussian boson sampling,” *Phys. Rev. E*, vol. 101, p. 022134, Feb 2020. [Online]. Available: <https://link.aps.org/doi/10.1103/PhysRevE.101.022134>
- [16] C. Kang, M. B. Soley, E. Crane, S. Girvin, and N. Wiebe, “Leveraging hamiltonian simulation techniques to compile operations on bosonic devices,” *arXiv preprint arXiv:2303.15542*, 2023. [Online]. Available: <https://arxiv.org/abs/2303.15542>
- [17] N. Killoran, J. Izaac, N. Quesada, V. Bergholm, M. Amy, and C. Weedbrook, “Strawberry fields: A software platform for photonic quantum computing,” *Quantum*, vol. 3, p. 129, mar 2019. [Online]. Available: <https://doi.org/10.22331/2Fq-2019-03-11-129>
- [18] S. Lloyd and S. L. Braunstein, “Quantum computation over continuous variables,” *Phys. Rev. Lett.*, vol. 82, pp. 1784–1787, Feb 1999. [Online]. Available: <https://link.aps.org/doi/10.1103/PhysRevLett.82.1784>
- [19] Y. Lu, A. Maiti, J. W. Garmon, S. Ganjam, Y. Zhang, J. Claes, L. Frunzio, S. Girvin, and R. J. Schoelkopf, “A high-fidelity microwave beamsplitter with a parity-protected converter,” *arXiv preprint arXiv:2303.00959*, 2023. [Online]. Available: <https://arxiv.org/abs/2303.00959>
- [20] L. Madden and A. Simonetto, “Best approximate quantum compiling problems,” *ACM Transactions on Quantum Computing*, vol. 3, no. 2, mar 2022. [Online]. Available: <https://doi.org/10.1145/3505181>
- [21] L. S. Madsen, F. Laudenbach, M. F. Askarani, F. Rortais, T. Vincent, J. F. F. Bulmer, F. M. Miatto, L. Neuhaus, L. G. Helt, M. J. Collins, A. E. Lita, T. Gerrits, S. W. Nam, V. D. Vaidya, M. Menotti, I. Dhand, Z. Vernon, N. Quesada, and J. Lavoie, “Quantum computational advantage with a programmable photonic processor,” *Nature*, vol. 606, no. 7912, pp. 75–81, Jun 2022. [Online]. Available: <https://doi.org/10.1038/s41586-022-04725-x>
- [22] N. Maring, A. Fyrrillas, M. Pont, E. Ivanov, P. Stepanov, N. Margaria, W. Hease, A. Pishchagin, T. H. Au, S. Boissier, E. Bertasi, A. Baert, M. Valdivia, M. Billard, O. Acar, A. Briussel, L. G. Mezher, S. C. Wein, A. Salavrakos, P. Sinnott, D. A. Fioretto, P.-E. Emeriau, N. Belabas, S. Mansfield, P. Senellart, J. Senellart, and N. Somaschi, “A general-purpose single-photon-based quantum computing platform,” 2023. [Online]. Available: <https://arxiv.org/abs/2306.00874>
- [23] S. Martiel and T. G. d. Brugière, “Architecture aware compilation of quantum circuits via lazy synthesis,” *Quantum*, vol. 6, p. 729, Jun. 2022. [Online]. Available: <https://doi.org/10.22331/q-2022-06-07-729>
- [24] A. Narla, S. Shankar, M. Hatridge, Z. Leghtas, K. M. Sliwa, E. Zalsgeller, S. O. Mundhada, W. Pfaff, L. Frunzio, R. J. Schoelkopf, and M. H. Devoret, “Robust concurrent remote entanglement between two superconducting qubits,” *Phys. Rev. X*, vol. 6, p. 031036, Sep 2016. [Online]. Available: <https://link.aps.org/doi/10.1103/PhysRevX.6.031036>
- [25] T. Patel, E. Younis, C. Iancu, W. de Jong, and D. Tiwari, “Quest: Systematically approximating quantum circuits for higher output fidelity,” in *Proceedings of the 27th ACM International Conference on Architectural Support for Programming Languages and Operating Systems*, ser. ASPLOS ’22. New York, NY, USA: Association for Computing Machinery, 2022, p. 514–528. [Online]. Available: <https://doi.org/10.1145/3503222.3507739>
- [26] Qiskit contributors, “Qiskit: An open-source framework for quantum computing,” 2023. [Online]. Available: <https://doi.org/10.5281/zenodo.2573505>

- [27] J. Rarity, P. Tapster, E. Jakeman, T. Larchuk, R. Campos, M. Teich, and B. Saleh, "Two-photon interference in a mach-zehnder interferometer," *Physical review letters*, vol. 65, no. 11, p. 1348, 1990.
- [28] M. Reck, A. Zeilinger, H. J. Bernstein, and P. Bertani, "Experimental realization of any discrete unitary operator," *Phys. Rev. Lett.*, vol. 73, pp. 58–61, Jul 1994. [Online]. Available: <https://link.aps.org/doi/10.1103/PhysRevLett.73.58>
- [29] F. Rueda and S. L. Alarcon, "Continuous variable quantum compilation," in *2021 International Conference on Computational Science and Computational Intelligence (CSCI)*, 2021, pp. 1765–1770. [Online]. Available: <https://doi.org/10.1109/CSCI54926.2021.00335>
- [30] M. Schuld, K. Brádler, R. Israel, D. Su, and B. Gupt, "Measuring the similarity of graphs with a gaussian boson sampler," *Physical Review A*, vol. 101, no. 3, mar 2020. [Online]. Available: <https://doi.org/10.1103/PhysRevA.101.032314>
- [31] S. Sivarajah, S. Dilkes, A. Cowtan, W. Simmons, A. Edgington, and R. Duncan, "t|ket>: a retargetable compiler for nisq devices," *Quantum Science and Technology*, vol. 6, no. 1, p. 014003, nov 2020. [Online]. Available: <https://dx.doi.org/10.1088/2058-9565/ab8e92>
- [32] T. J. Stavenger, E. Crane, K. C. Smith, C. T. Kang, S. M. Girvin, and N. Wiebe, "C2qa - bosonic qiskit," in *2022 IEEE High Performance Extreme Computing Conference (HPEC)*, 2022, pp. 1–8. [Online]. Available: <https://doi.org/10.1109/HPEC55821.2022.9926318>
- [33] C. Taballione, M. C. Anguita, M. de Goede, P. Venderbosch, B. Kassenberg, H. Snijders, N. Kannan, W. L. Vleeshouwers, D. Smith, J. P. Epping, R. van der Meer, P. W. H. Pinkse, H. van den Vlekkert, and J. J. Renema, "20-Mode Universal Quantum Photonic Processor," *Quantum*, vol. 7, p. 1071, Aug. 2023. [Online]. Available: <https://doi.org/10.22331/q-2023-08-01-1071>
- [34] C. S. Wang, J. C. Curtis, B. J. Lester, Y. Zhang, Y. Y. Gao, J. Freeze, V. S. Batista, P. H. Vaccaro, I. L. Chuang, L. Frunzio, L. Jiang, S. M. Girvin, and R. J. Schoelkopf, "Efficient multiphoton sampling of molecular vibronic spectra on a superconducting bosonic processor," *Phys. Rev. X*, vol. 10, p. 021060, Jun 2020. [Online]. Available: <https://link.aps.org/doi/10.1103/PhysRevX.10.021060>
- [35] C. Weedbrook, S. Pirandola, R. García-Patrón, N. J. Cerf, T. C. Ralph, J. H. Shapiro, and S. Lloyd, "Gaussian quantum information," *Rev. Mod. Phys.*, vol. 84, pp. 621–669, May 2012. [Online]. Available: <https://link.aps.org/doi/10.1103/RevModPhys.84.621>
- [36] M. Weiden, J. Kallor, J. Kubiatowicz, E. Younis, and C. Iancu, "Wide quantum circuit optimization with topology aware synthesis," in *2022 IEEE/ACM Third International Workshop on Quantum Computing Software (QCS)*, 2022, pp. 1–11. [Online]. Available: <https://doi.org/10.1109/QCS56647.2022.00006>
- [37] X.-C. Wu, M. G. Davis, F. T. Chong, and C. Iancu, "Reoptimization of quantum circuits via hierarchical synthesis," in *2021 International Conference on Rebooting Computing (ICRC)*, 2021, pp. 35–46. [Online]. Available: <https://doi.org/10.1109/ICRC53822.2021.00016>
- [38] E. Younis, C. C. Iancu, W. Lavrijsen, M. Davis, E. Smith, and USDOE, "Berkeley quantum synthesis toolkit (bqskit) v1," 4 2021. [Online]. Available: <https://www.osti.gov/servlets/purl/1785933>
- [39] E. Younis, K. Sen, K. Yelick, and C. Iancu, "Qfast: Conflating search and numerical optimization for scalable quantum circuit synthesis," in *2021 IEEE International Conference on Quantum Computing and Engineering (QCE)*, 2021, pp. 232–243. [Online]. Available: <https://doi.org/10.1109/QCE52317.2021.00041>
- [40] H.-S. Zhong, Y.-H. Deng, J. Qin, H. Wang, M.-C. Chen, L.-C. Peng, Y.-H. Luo, D. Wu, S.-Q. Gong, H. Su, Y. Hu, P. Hu, X.-Y. Yang, W.-J. Zhang, H. Li, Y. Li, X. Jiang, L. Gan, G. Yang, L. You, Z. Wang, L. Li, N.-L. Liu, J. J. Renema, C.-Y. Lu, and J.-W. Pan, "Phase-programmable gaussian boson sampling using stimulated squeezed light," *Phys. Rev. Lett.*, vol. 127, p. 180502, Oct 2021. [Online]. Available: <https://link.aps.org/doi/10.1103/PhysRevLett.127.180502>
- [41] H.-S. Zhong, H. Wang, Y.-H. Deng, M.-C. Chen, L.-C. Peng, Y.-H. Luo, J. Qin, D. Wu, X. Ding, Y. Hu, P. Hu, X.-Y. Yang, W.-J. Zhang, H. Li, Y. Li, X. Jiang, L. Gan, G. Yang, L. You, Z. Wang, L. Li, N.-L. Liu, C.-Y. Lu, and J.-W. Pan, "Quantum computational advantage using photons," *Science*, vol. 370, no. 6523, pp. 1460–1463, 2020. [Online]. Available: <https://www.science.org/doi/abs/10.1126/science.abe8770>