

ON THE STABILITY OF HYBRID POLYCYCLES

PAULO SANTANA¹ AND LEONARDO SERANTOLA¹

ABSTRACT. In this paper we provide the stability of generic polycycles of hybrid planar vector fields, extending previous known results in the literature. The polycycles considered here may have hyperbolic saddles, tangential singularities and jump singularities.

1. INTRODUCTION

Let X be a planar smooth vector field (i.e. of class C^∞). A *graphic* of X is a compact, non-empty invariant subset which is a continuous (not necessarily homeomorphic) image of \mathbb{S}^1 , composed by some singularities $p_1, \dots, p_n, p_{n+1} = p_1$ and distinct regular orbits L_1, \dots, L_n such that L_i is an orbit from p_{i+1} to p_i , see Figure 1.

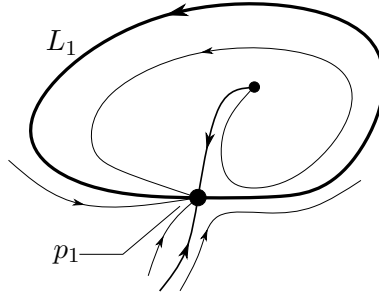

FIGURE 1. Illustration of a graphic given by the connection of the separatrix of a saddle-node with its parabolic sector.

A *polycycle* is a graphic with a well defined first return map on one of its sides. See Figure 2(a). In

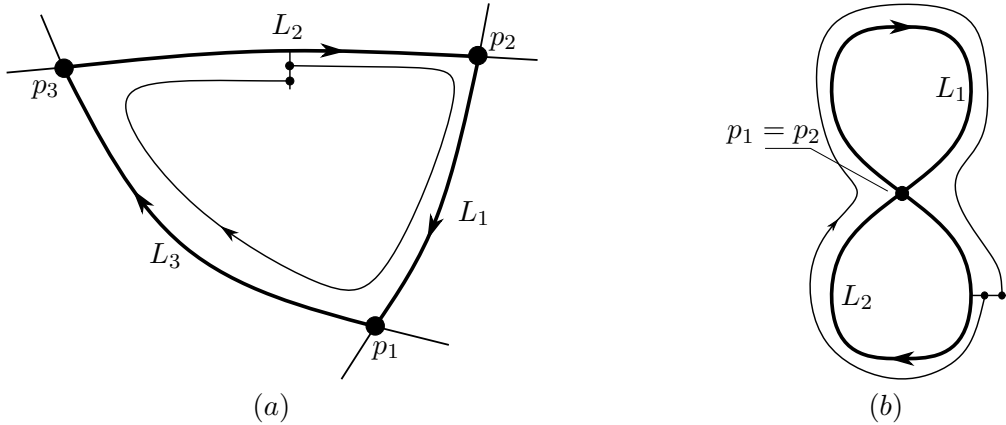

FIGURE 2. Illustration of a polycycle (a) homeomorphic and (b) not homeomorphic to \mathbb{S}^1 .

addition with singularities and periodic orbits, it follows from the Poincaré-Bendixson Theorem (see Perko [38, Section 3.7]) that graphics are the only possible limit sets of a bounded orbit of X . The study about polycycles goes back to Poincaré and Dulac [12] in the first half of the 20th century. In recent years there were many studies about graphics and polycycles, dealing for example with its cyclicity [8, 11, 16, 18, 19, 30, 32–34, 41], stability [14, 15] and the bifurcation of critical periodic orbits [28, 29]. In particular Cherkas [10] characterized the stability of polycycles under generic conditions. For more

2020 *Mathematics Subject Classification.* 34A38; 34C37; 34D45.

Key words and phrases. Hybrid dynamical systems; polycycles; singular cycles; graphics of a vector field.

details about the theory of polycycles in smooth vector fields, we refer to Roussarie [39, Chapter 5] and the references therein.

With the development of the *Filippov convention* [13] for non-smooth planar vector fields in the second half of the 20th century, it was natural to extend known results in the literature for smooth vector fields, to the Filippov one. On the wake of such effort, Buzzi et al [6] extended the Poincaré-Bendixson Theorem to the Filippov vector fields and proved that (pseudo) graphics and polycycles remain a very important limit set on Filippov systems, see Figure 3. It is also noted worthy to observe

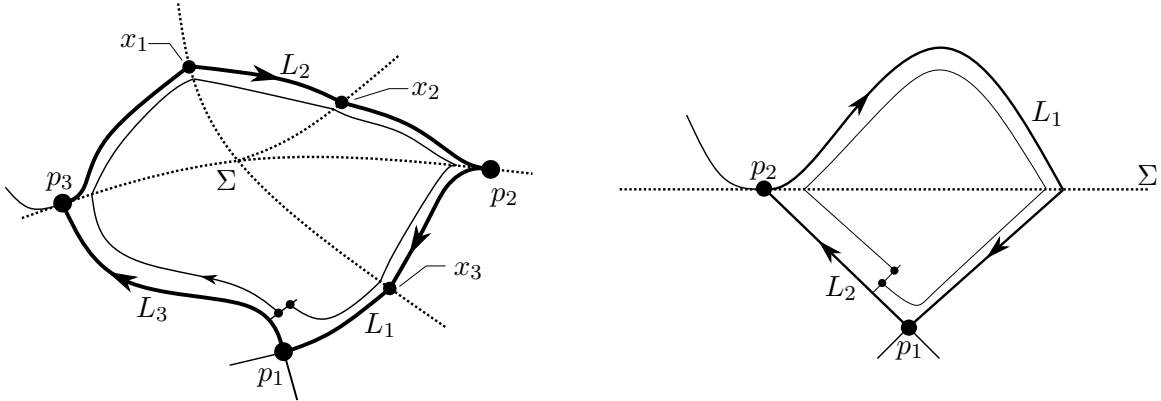

FIGURE 3. Illustration of a polycycle on planar Filippov systems.

the recent work of Han and Zhou [17] characterizing the stability of limit cycles in Filippov systems, extending the classical results of Poincaré first return map in the smooth case. In recent years there were many studies about graphics and polycycles in Filippov systems, dealing for example with its bifurcation diagrams [2, 3, 7, 24, 25, 37] and regularization [35, 36]. In particular the author in [43] extended the result of Cherka, characterizing the stability of polycycles in Filippov systems under generic conditions. For more details, we refer to Andrade, Gomide and Novaes [2] and the references therein.

With the recent development of the theory of *hybrid systems*, it is natural to seek for a generalization of the concepts and tools of smooth and Filippov systems to the hybrid framework. Roughly speaking, a hybrid dynamical system is a system that can both *flow* and *jump*, see Figure 4. For instance, for a

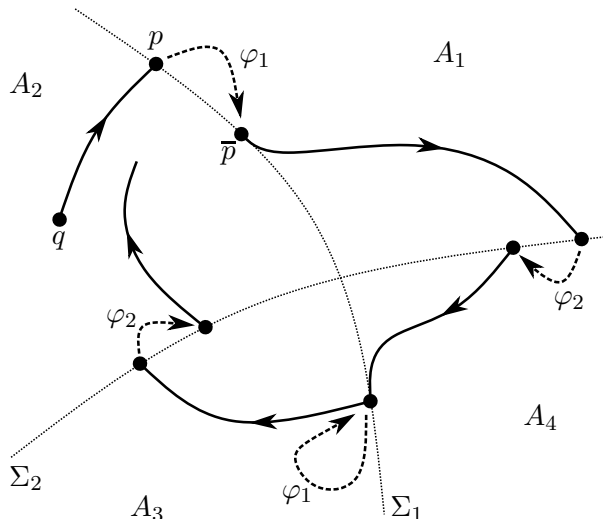

FIGURE 4. Illustration of an orbit of a hybrid system. The solid lines represent the orbit given by the flow of a smooth vector field. The dashed lines represent the instantaneous jump of a point p , given by a map φ_i , when it reaches the switching manifold $\Sigma = \Sigma_1 \cup \Sigma_2$.

generalization of the stability methods of Lyapunov functions, we refer to Akhmet [1, Chapter 5]. In this paper we generalize the concepts of Cherkas [10] and Santana [43] about the stability of polycycles

in smooth and Filippov systems to the hybrid framework. More precisely, suppose that we have a given planar hybrid system with a polycycle (such concepts will be properly defined later), see Figure 5. The goal of this paper is to approach such object and characterize its stability. There are some studies

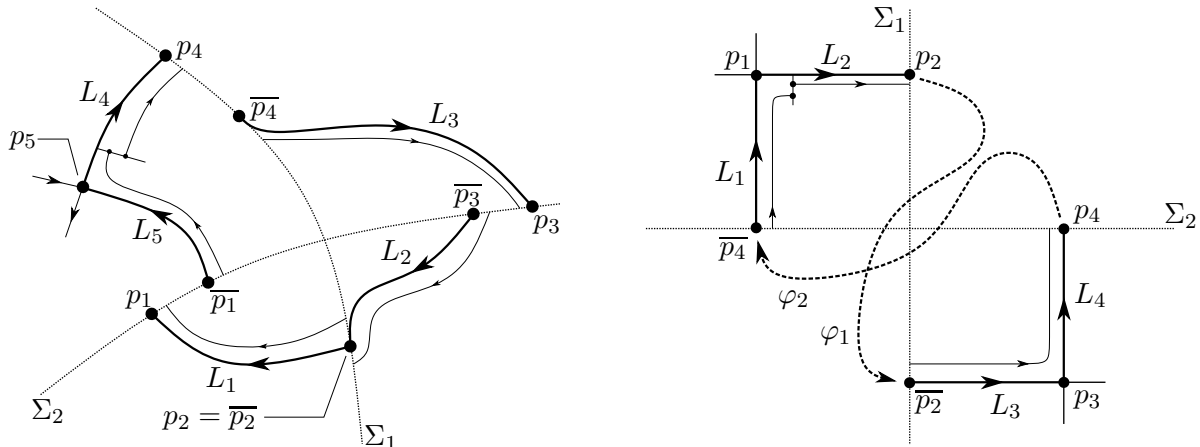

FIGURE 5. Illustration of polycycles in hybrid systems. Here \bar{p}_i denotes the image of p_i after the jump. Observe that a jump may keep p_i fixed while reversing the orientation, see p_2 on the left-hand side. In particular, polycycles can now be one-sided.

about polycycles in hybrid systems dealing, for example, with an extension of the Melnikov theory to study its cyclicity [21–23, 45]. Moreover, since Filippov systems can be seen as a particular case of a hybrid system (i.e. the case in which the jump is the identity map), simple hybrid systems are expected to have more limit cycles than their Filippov counterparts. For example, it follows from Llibre and Teixeira [27] that a Filippov system composed by two linear centers and such that the discontinuity is a straight line can not have limit cycles. However it follows from [20, 26] that when we allow this Filippov system *jump* at the discontinuity line we can have limit cycles. For an introduction about hybrid systems, we refer to the book of Schaft and Schumacher [40] and the paper of Branicky [9]. For a recent survey in the field, we refer to Belykh, Kuske, Porfiri and Simpson [4].

As anticipated in the above discussion, in this paper we study the stability of polycycles in hybrid systems, extending the results of Cherkas [10] and Santana [43] about its smooth and Filippov counterparts to the hybrid case. More precisely let X be a planar smooth vector field with a polycycle Γ , composed by n singularities p_1, \dots, p_n , all of them being hyperbolic saddles. Let $\nu_i < 0 < \lambda_i$ be the associated eigenvalues of the saddle p_i , $i \in \{1, \dots, n\}$. The *hyperbolicity ratio* of p_i is the positive real number given by

$$(1) \quad r_i = \frac{|\nu_i|}{\lambda_i}.$$

The *graphic number* of Γ is the positive real number given by

$$(2) \quad r = \prod_{i=1}^n r_i.$$

Cherkas [10] proved that if $r > 1$ (resp. $r < 1$), then Γ is stable (resp. unstable). In [43] the author extended (1), allowing the *tangential singularities* of a given polycycle in a Filippov system also have a well defined hyperbolicity ratio. With this extension it was possible to extend the results of Cherkas to the Filippov case. In this paper we generalize the notion of hyperbolicity ratio to include a new kind of singularity that appears in hybrid systems, which we call *jump singularities*. With this generalization we are now able to establish the notion of graphic number (2) and thus study the stability of a hybrid polycycle, which may contain hyperbolic saddles and tangential or jump singularities.

The paper is organized as follows. In Section 2 we have the precise statement of our main result. Section 3 is devoted to organize the preliminaries results. The main result is proved in Section 4.

2. STATEMENT OF THE MAIN RESULTS

Before we establish the technical definitions, we present one of the usual examples of an hybrid dynamical system. The *bouncing ball model* [26].

Example 1 (Example 1 of [26]). Consider the vertical motion of a ball dropped (or tossed) from an initial height $h > 0$, with initial velocity $v \in \mathbb{R}$ (here negative velocity means downwards following gravity, while positive velocity means that the ball was tossed upwards). If the ball is under the acceleration of constant gravity $g > 0$, then for $h > 0$ the state of the ball is governed by the system of differential equations,

$$(3) \quad \dot{h} = v, \quad \dot{v} = -g.$$

Therefore given any initial condition $q = (h_0, v_0)$, $h_0 > 0$, it follows from (3) that the ball reaches the ground $h = 0$ after a finite amount of time $t_0 > 0$, with velocity $v(t_0) < 0$. See Figure 11. At this instant the ball bounces back upwards and its velocity undergoes an instantaneous change

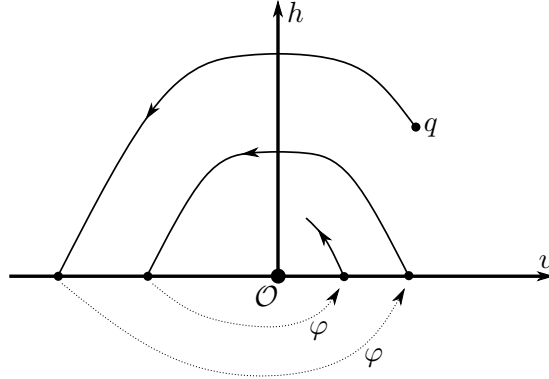

FIGURE 6. Illustration of an orbit of the bouncing ball model. For simplicity, we interchanged the coordinate axes.

$v(t_0) \mapsto -\rho v(t_0)$, modeled by an inelastic collision with dissipate factor $0 < \rho < 1$. That is, at $h = 0$ our system undergoes a jump (or reset) φ given by $\varphi(0, v) = (0, -\rho v)$. The reset map represents the instantaneous loss of energy that the ball suffers when hitting the ground. Observe that any orbit converges to the origin, which represents a ball standing still in the ground.

We now establish the necessary definitions and concepts for a proper statement of our main result. First, we start by defining what we mean by planar *hybrid system*.

Let $h_1, \dots, h_N: \mathbb{R}^2 \rightarrow \mathbb{R}$, $N \geq 1$, be C^∞ -functions having 0 as a regular value, i.e., such that $\nabla h_i(x, y) \neq (0, 0)$ for every $(x, y) \in h_i^{-1}(\{0\})$, where ∇h denotes the gradient vector of h . For each $i \in \{1, \dots, N\}$, let $\Sigma_i = h_i^{-1}(\{0\})$ and observe that Σ_i is a 1-dimensional manifold. Let also $\Sigma = \cup_{i=1}^N \Sigma_i$. Let $A_1, \dots, A_M \subset \mathbb{R}^2$, $M \geq 2$, be the open connected components of $\mathbb{R}^2 \setminus \Sigma$. For each $i \in \{1, \dots, M\}$, let X_i be a C^∞ -planar vector field defined over $\overline{A_i}$, where $\overline{A_i}$ denotes the topological closure of A_i . For each $i \in \{1, \dots, N\}$, let $\varphi_i: \Sigma_i \rightarrow \Sigma_i$ be a C^∞ -map. To simplify the notation, let $\mathfrak{X} = \{X_1, \dots, X_M\}$ and $\Phi = \{\varphi_1, \dots, \varphi_N\}$. Let $Z = Z(\mathfrak{X}, \Sigma, \Phi)$ be the associated *hybrid system*.

Before we state the way that the dynamics of Z works, we need to establish some nomenclatures. First, we say that X_1, \dots, X_M are the *components* of Z and that $\Sigma_1, \dots, \Sigma_N$ are the components of Σ . Let $p \in \Sigma$. We say that p is *regular* if the following statements hold.

- (a) There is a unique $i_0 \in \{1, \dots, N\}$ such that $p \in \Sigma_{i_0}$.
- (b) For every $i \in \{1, \dots, N\}$, with $i \neq i_0$, we have $\varphi_{i_0}(p) \notin \Sigma_i$.

To simplify the notation let $\bar{p} = \varphi_{i_0}(p)$. It follows from statement (a) that if $p \in \Sigma_{i_0}$ is regular, then there are exactly two connected components of $\mathbb{R}^2 \setminus \Sigma$ having p in its boundary. Moreover, h_{i_0} is strictly positive in one of such components and strictly negative in the other. Let A_p^+ (resp. A_p^-) be the unique connected component of $\mathbb{R}^2 \setminus \Sigma$ having p in its boundary and such that $h_{i_0}(x, y) > 0$ (resp. $h_{i_0}(x, y) < 0$) for every $(x, y) \in A_p^+$ (resp. $(x, y) \in A_p^-$). Similarly let $A_{\bar{p}}^+$ and $A_{\bar{p}}^-$ be the analogous connected components associated to \bar{p} . We now define the dynamics of Z . Let $q \in \mathbb{R}^2 \setminus \Sigma$ and let A_{j_0} be the unique connected component of $\mathbb{R}^2 \setminus \Sigma$ containing q and let X_{j_0} be the component of Z defined over $\overline{A_{j_0}}$. The orbit of Z through q is given as follows. First we let q follow the orbit of X_{j_0} . If such orbit never leaves A_{j_0} , then we are done, that is, the orbit of Z is given by the orbit of X_{j_0} . Hence suppose that the orbit of X_{j_0} through q intersects Σ in a point p . Suppose that $p \in \Sigma$ is regular and let \bar{p} , A_p^+ , A_p^- , $A_{\bar{p}}^+$ and $A_{\bar{p}}^-$ be given as above. Observe that either $A_{j_0} = A_p^+$ or $A_{j_0} = A_p^-$. Without loss

of generality suppose that $A_{j_0} = A_p^+$. After reaching p the orbit *jump* to \bar{p} . For simplicity let $A^- = A_{\bar{p}}^-$ and let X^- be the component of Z defined over A^- . Suppose now that the orbit $\gamma^-: [0, \varepsilon) \rightarrow \mathbb{R}^2$ of X^- through \bar{p} is well defined for some $\varepsilon > 0$, with $\gamma^-(0) = \bar{p}$ and is such that $\gamma(t) \in A^-$ for every $t \in (0, \varepsilon)$. Thus after it jumps from p to \bar{p} , we now let \bar{p} follows the orbit of X^- and thus we arrive at some $q_1 \in A^-$. In particular we arrive at some $q_1 \in \mathbb{R}^2 \setminus \Sigma$. Hence we now repeat the process, i.e., when the orbit of X^- through q_1 stays in A^- then we are done. If it does not then it intersects Σ in a point p_1 that we suppose to be regular and so on. See Figure 4.

We now briefly recall the notion of *crossing* and *tangential* points of Filippov systems, see Figure 7. Let $Y = (Y^+, Y^-, \Sigma)$ be a planar Filippov system such $\Sigma = h^{-1}(0)$, for some smooth function

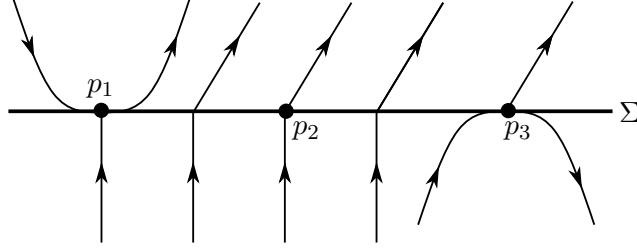

FIGURE 7. Illustration of a crossing p_2 and tangential points p_1 and p_3 of Y .

$h: \mathbb{R}^2 \rightarrow \mathbb{R}$, with 0 being a regular value. Suppose also that Y^+ (resp. Y^-) is a smooth planar system defined in the region $h(x, y) \geq 0$ (resp. $h(x, y) \leq 0$). Let $p \in \Sigma$. The *Lie derivative* of h in the direction of Y^+ (resp. Y^-) at p is given by

$$Y^+h(p) = \langle Y^+(p), \nabla h(p) \rangle \quad (\text{resp. } Y^-h(p) = \langle Y^-(p), \nabla h(p) \rangle),$$

where $\langle \cdot, \cdot \rangle$ denotes the standard inner product of \mathbb{R}^2 . In particular, observe that $Y^\pm h(p) = 0$ if, and only if, $Y^\pm(p)$ is tangent to Σ at p . Given $p \in \Sigma$, we say that p is a *crossing point* of Y if

$$Y^+h(p)Y^-h(p) > 0.$$

Moreover, we say that p is a *tangential singularity* of Y if

$$Y^+(p) \neq 0, \quad Y^-(p) \neq 0 \quad \text{and} \quad Y^+h(p)Y^-h(p) = 0.$$

Knowing that a Filippov system can be seen as a particular case of a hybrid system whose jumps are given by the identity map, we now propose the following generalization of crossing points and tangential singularities, see Figure 8.

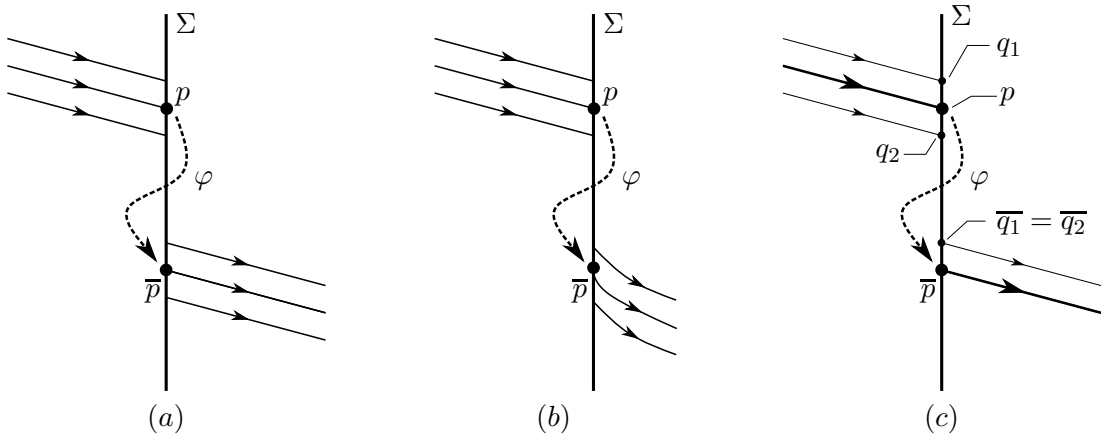

FIGURE 8. Illustration of a (a) jump crossing point, a (b) jump singularity satisfying (i) and (c) a jump singularity satisfying (ii).

Definition 1. Let $Z = (\mathfrak{X}, \Sigma, \Phi)$ be a hybrid system and $(p, \bar{p}) \in \Sigma_i$ a regular point. Let $X_p^+, X_p^- \in \mathfrak{X}$ be the two components of Z defined at p . Let also $\bar{p} = \varphi_i(p)$ and $X_{\bar{p}}^+, X_{\bar{p}}^-$ be the components of Z

defined at \bar{p} . We say that the pair (p, \bar{p}) is a jump crossing point of Z in φ_i if there is a neighborhood $N \subset \Sigma_i$ of p such that $\varphi|_N$ is a diffeomorphism and

$$(4) \quad X_p^+ h_i(p) X_{\bar{p}}^- h_i(\bar{p}) > 0.$$

Moreover, we say that (p, \bar{p}) is a jump singularity if $X_p^+(p) \neq 0$, $X_{\bar{p}}^-(\bar{p}) \neq 0$ and if at least one of the following statements hold.

- (i) $X_p^+ h_i(p) X_{\bar{p}}^- h_i(\bar{p}) = 0$.
- (ii) For every neighborhood $N \subset \Sigma_i$ of p , $\varphi|_N$ is not a diffeomorphism.

Remark 1. In the definition 1, in the inequality (4) of jump crossing point, we are implicitly assuming that p arrives at the switching manifold Σ_i through the flow of X_p^+ , while \bar{p} leaves it through the flow of $X_{\bar{p}}^-$. If the opposite happens, then we replace (4) by $X_p^- h_i(p) X_{\bar{p}}^+ h_i(\bar{p}) > 0$. A similar observation holds for the definition of jump singularity.

For simplicity, throughout the paper giving a jump crossing point or jump singularity (p, \bar{p}) , we always assume that p arrives at the switching manifold Σ_i through the flow of X_p^+ , while \bar{p} leaves it through the flow of $X_{\bar{p}}^-$.

Definition 2. Consider a point $q \in \Sigma$, X one of the components of Z defined at q and let $X^k h_i(q) = \langle X(q), \nabla X^{k-1} h_i(q) \rangle$, $k \geq 2$. We say that X has m -order contact with Σ at q , $m \geq 1$, if m is the first positive integer such that $X^m h_i(q) \neq 0$. If $X^k h_i(q) = 0$ for every $k \in \mathbb{N}$, then we say that q is a flat point of X .

Definition 3 (Definition of Polycycle). Let $Z = (\mathfrak{X}, \Sigma, \Phi)$ be a hybrid system. A graphic of Z is a compact, non-empty invariant subset composed by singularities $(p_1, \bar{p}_1), \dots, (p_n, \bar{p}_n)$, $(p_{n+1}, \bar{p}_{n+1}) = (p_1, \bar{p}_1)$ (not necessarily distinct), with each (p_i, \bar{p}_i) being either a jump singularity of Z or a singularity of some component of Z (in this case, $p_i = \bar{p}_i$); and distinct regular orbits L_1, \dots, L_n such that \bar{p}_{i+1} and p_i are the α and ω -limits of L_i .

A polycycle is a graphic with a well defined first return map $\pi: \ell \rightarrow \ell$. A polycycle is hyperbolic if it satisfies the following statements.

- (a) Except perhaps by \bar{p}_{i+1} and p_i , each orbit L_i intersects Σ at most in a finite number of points, with each of them being a jump crossing point.
- (b) Each singularity (p_i, \bar{p}_i) satisfies exactly one of the following conditions:
 - (i) $p_i = \bar{p}_i$ is a hyperbolic saddle and $p_i \notin \Sigma$.
 - (ii) (p_i, \bar{p}_i) is a jump singularity and p_i (resp. \bar{p}_i) is not a flat point of X_p^+ (resp. $X_{\bar{p}}^-$).

From now on, we let Γ^n denote a hyperbolic polycycle with n singularities $(p_1, \bar{p}_1), \dots, (p_n, \bar{p}_n)$ (not necessarily distinct) and n distinct regular orbits L_1, \dots, L_n such that L_i is an orbit from \bar{p}_{i+1} to p_i . See Figure 9.

Given a jump singularity (p, \bar{p}) of Γ^n , let $L_s, L_u \in \{L_1, \dots, L_n\}$ be the orbits of Γ^n such that p is the ω -limit of L_s and \bar{p} the α -limit of L_u , see Figure 10. The stable and unstable components of (p, \bar{p}) are the components $X_s, X_u \in \{X_1, \dots, X_M\}$ of Z defined over L_s and L_u respectively.

Definition 4. Given a jump singularity (p, \bar{p}) , let X_s and X_u be its stable and unstable components. We define the stable and unstable contact order of p as the contact order n_s and n_u of X_s and X_u with Σ at p and \bar{p} respectively. Moreover, if n_u and n_s are finite then we say that p is a non-flat jump singularity of Z .

It follows from [43] that the contact orders n_s and n_u of a tangential singularity play the same role as the eigenvalues $\nu < 0 < \lambda$ of a hyperbolic saddle. In particular, the fraction n_u/n_s play the same role as the hyperbolicity ratio (1). That is, n_u/n_s characterizes when a tangential singularity contracts or expands the flow around it. In case of hybrid systems, we must take the action of the jump φ into account, as it can also be contracting or expanding. We now address this.

Let $(p, \bar{p}) \in \Sigma_i$ be a jump singularity of Z and let $I, J \subset \Sigma_i$ be neighborhoods of p and \bar{p} respectively (we recall that Σ_i is an one-dimensional manifold). After taking charts if necessary, we can identify $I = (-\delta, \delta)$ and $J = (-\varepsilon, \varepsilon)$ with $\delta > 0$ and $\varepsilon > 0$ small enough in addition to $p = 0$ and $\bar{p} = 0$. Hence we can write the C^∞ -map $\varphi_i: I \rightarrow J$ as

$$\varphi_i(t) = \left(\sum_{k=1}^{\infty} a_k t^k \right) + R(t),$$

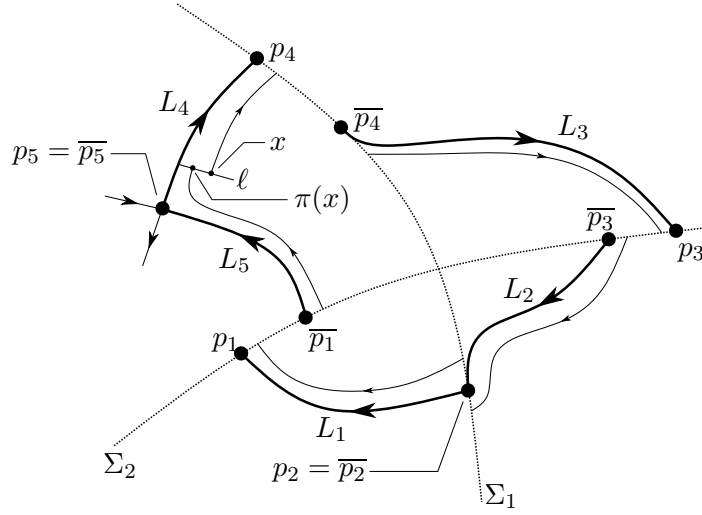

FIGURE 9. An example of a hyperbolic polycycle Γ^5 . Observe that although we have $\varphi_1(p_2) = p_2$, the map φ_1 reversed the orientation of the returning map at p_2 . In particular p_2 is a jump singularity but it is not a tangential singularity.

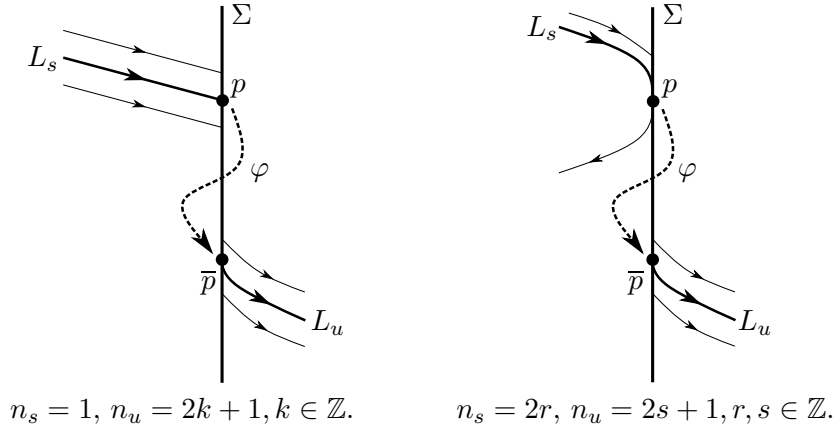

FIGURE 10. Illustration of L_s , L_u and their different types of contact orders.

with $a_k \in \mathbb{R}$ and $R: I \rightarrow J$ a flat C^∞ -function such that $R(0) = 0$. If $a_k \neq 0$ for some $k \in \mathbb{N}$, then we say that p is a jump singularity of *finite power order*. Moreover, in this case if $k_0 \in \mathbb{N}$ is the first integer such that $a_{k_0} \neq 0$ then we say that p has power of order k_0 or that k_0 is the power order of p . On the other hand if $a_k = 0$ for every $k \in \mathbb{N}$, then we say that p has *infinity power order*.

Definition 5. Let Γ^n be a hyperbolic polycycle. The hyperbolicity ratio $r_i \in \mathbb{R}_{>0} \cup \{\infty\}$ of p_i is defined as follows.

- (a) If p_i is a jump singularity of finite power order then $r_i = \frac{n_{i,u}}{n_{i,s}} k_i$, where $n_{i,s}$ and $n_{i,u}$ are the stable and unstable contact orders of p_i and k_i is the power order of p .
- (b) If p_i is a jump singularity of infinity power order, then $r_i = \infty$.
- (c) If p_i is a hyperbolic saddle, then $r_i = \frac{|\nu_i|}{\lambda_i}$, where $\nu_i < 0 < \lambda_i$ are the eigenvalues of the jacobian matrix of Z at p (recall that in this case $p \notin \Sigma$).

Moreover, the graphic number $r \in \mathbb{R}_{>0} \cup \{\infty\}$ of Γ^n is given by

$$r = \begin{cases} \prod_{i=1}^n r_i, & \text{if every jump singularity has finite power order,} \\ \infty, & \text{otherwise.} \end{cases}$$

Let Γ^n be a hyperbolic polycycle and $\pi: \ell \rightarrow \ell$ be its associated first return map, see Figure 9. Without loss of generality we can identify ℓ with the semi-open interval $I = \{x \in \mathbb{R}: 0 \leq x < \delta\}$, with $\delta > 0$ small enough such that the intersection of ℓ with Γ^n is given by $x = 0$. We say that Γ^n is *stable* (resp. *unstable*) if $\pi(x) < x$ (resp. $\pi(x) > x$) for every $0 < x < \delta$. Our main result is the following.

Theorem 1. *Let Z be a hybrid system with a hyperbolic polycycle Γ^n with graphic number r . Then Γ^n is stable if $r > 1$ and unstable if $r < 1$. In particular if Γ^n has a jump singularity with infinity power order, then Γ^n is stable.*

We observe that if we suppose that $\varphi_i = \text{Id}_{\Sigma_i}$ for every $i \in \{1, \dots, N\}$, then the hybrid system Z becomes a Filippov system. In this case our main result reduces to [43, Theorem 1], which deals with the stability of polycycles in Filippov systems. Moreover, if we also suppose that every singularity of Γ^n is of jump type (and consequently tangential) and $n_{i,s} = 1$ for every $i \in \{1, \dots, n\}$ (where $n_{i,s}$ is the stable contact order of p_i), then we have the so called *regular-tangential* Σ -polycycles studied by Andrade, Gomide and Novaes [2]. In this context the authors in [2, Propositions 1 and 3] proved that such polycycles are stable. We observe that this fact can also be obtained from our main result, by observing that $r_i > 1$ for every $i \in \{1, \dots, n\}$ and thus $r > 1$. Finally, we observe that if we suppose $\varphi_i = \text{Id}_{\Sigma_i}$ for every $i \in \{1, \dots, N\}$ and $X_j = X$ for every $j \in \{1, \dots, M\}$, then $Z = X$ becomes a planar smooth vector field. In this case Theorem 1 becomes the main result of Cherkas [10], which deals with the stability of generic polycycles in planar smooth vector fields, as described in Section 1.

3. PRELIMINARIES

3.1. Transition map near a hyperbolic saddle. Let X be a planar vector field of class C^∞ such that the origin \mathcal{O} is a hyperbolic saddle. After a C^∞ -change of variables, we can assume that the stable and unstable manifolds of \mathcal{O} are given by the axis Oy and Ox respectively in a sufficient small neighborhood of \mathcal{O} . Let

$$\sigma = \{(x, y_0) \in \mathbb{R}^2 : 0 < x < x_1\}, \quad \tau = \{(x_0, y) \in \mathbb{R}^2 : 0 < y < y_1\},$$

where $y_0 > 0$, $x_0 > 0$, $y_1 > 0$ and $x_1 > 0$ are small enough. The *Dulac map* $D: \sigma \rightarrow \tau$ is the map given by the flow of X . See Figure 11.

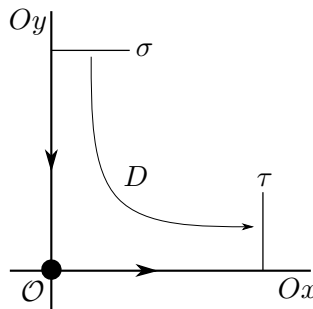

FIGURE 11. The Dulac map near a hyperbolic saddle.

Proposition 1 (Lemma 2.3, Section 2.2 of [44]). *Let X be a vector field of class C^∞ with a hyperbolic saddle at the origin \mathcal{O} with the associated eigenvalues $\nu < 0 < \lambda$. Suppose also that the stable and unstable manifold of p are given by the axis Oy and Ox respectively and let $D: \sigma \rightarrow \tau$ be the associated Dulac map. Then given $\varepsilon > 0$, there is $\delta > 0$ such that*

$$\delta^{1-\frac{|\nu|}{\lambda-\varepsilon}} x^{\frac{|\nu|}{\lambda-\varepsilon}} < D(x) < \delta^{1-\frac{|\nu|}{\lambda+\varepsilon}} x^{\frac{|\nu|}{\lambda+\varepsilon}}.$$

We observe that Proposition 1 is due to Sotomayor [44]. Since the original reference is not in English and, as far as we know there was no translation of it, the authors provided a translation of the original proof. See [43, Proposition 2]. For a complete characterization of the Dulac map we refer to the works of Marin and Villadelprat [28, 29, 31].

3.2. Transition map near a jump singularity. Let $Z = (\mathfrak{X}, \Sigma, \Phi)$ be a hybrid system with a hyperbolic polycycle Γ^n . Let $(p, \bar{p}) \in \Sigma_i$ be a non-flat jump singularity of Γ^n and X_s, X_u be the stable and unstable components of Z defined at p . Let also n_s and n_u be the stable and unstable contact orders of p . The aim of this section is to create a *transition map* that works near the jump singularity (p, \bar{p}) . To do this, first we assume that the map $\varphi_i: \Sigma_i \rightarrow \Sigma_i$ is such that there is a neighborhood $J \subset \Sigma_i$ of p with $\varphi_i: J \rightarrow \Sigma_i$ the identity map. In particular $\bar{p} = p$ is now a tangential singularity and in a neighborhood $W \subset \mathbb{R}^2$ of p , the hybrid system Z becomes a Filippov system. In this case let B be a small enough neighborhood of p and $\Psi: B \rightarrow \mathbb{R}^2$ be a C^∞ -change of coordinates such that

$\Psi(p) = 0$ and $\Psi(B \cap \Sigma) = Ox$. Let $l_s = \Psi(B \cap L_s)$, $l_u = \Psi(B \cap L_u)$ and τ_s, τ_u be two small enough cross sections of l_s and l_u respectively. Let also

$$\sigma = [0, \varepsilon) \times \{0\}, \quad \sigma = (-\varepsilon, 0] \times \{0\}, \quad \text{or } \sigma = \{0\} \times [0, \varepsilon),$$

depending on Γ^n . It follows from [2, Theorem 1] that Ψ can be chosen such that the transition maps $T^{s,u}: \sigma \rightarrow \tau_{s,u}$ given by the flow of $X_{s,u}$ in this new coordinate system are well defined and are written as

$$(5) \quad T^u(x) = k_u x^{n_u} + O(x^{n_u+1}), \quad T^s(x) = k_s x^{n_s} + O(x^{n_s+1}),$$

with $k_u \neq 0$ and $k_s \neq 0$. See Figure 12. We now work on the general case of a hybrid system Z .

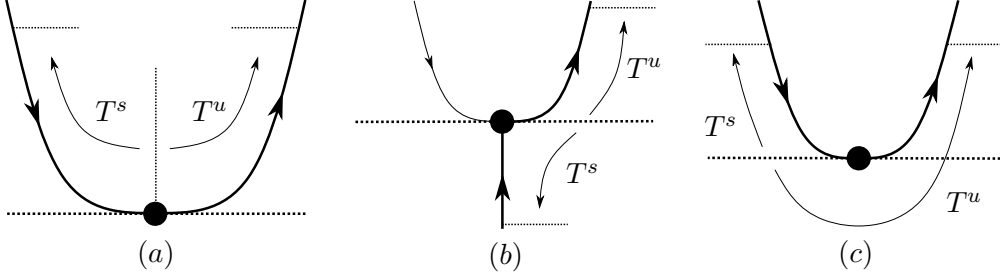

FIGURE 12. Illustration of the maps T^u and T^s .

Let $(p, \bar{p}) \in \Sigma_i$ be a jump of Γ^n and let X_s be the stable component of p defined over the connected component A_s . Let $W \subset \mathbb{R}^2$ be a small neighborhood of p and η be a unitary normal vector to Σ_i at p . Restricting W if necessary, we can assume that η is transversal to $\Sigma \cap W$. Let $A = W \setminus \overline{A_s}$ be the other connected component of $Z|_W$. On $W = A_s \cup \Sigma \cup A$ we construct the Filippov system Y given by

$$Y(x, y) = \begin{cases} X_s(x, y), & \text{if } (x, y) \in A_s, \\ \eta, & \text{if } (x, y) \in A. \end{cases}$$

Replacing η by $-\eta$ if necessary, we observe that Y has a unique and well defined regular orbit $L_u \subset A$ having p as α -limit. Hence it follows from [2, Theorem 1] that after a change of variables the transition maps T^s and T^u are well defined for Y and are given by (5). Since $Y|_{W \cap \overline{A_s}} = Z|_{W \cap \overline{A_s}}$, it follows that T^s provides a transition map T_p^s for Z near p . Similarly it follows that we can obtain a transition map $T_{\bar{p}}^u$ of Z near \bar{p} . See Figure 13.

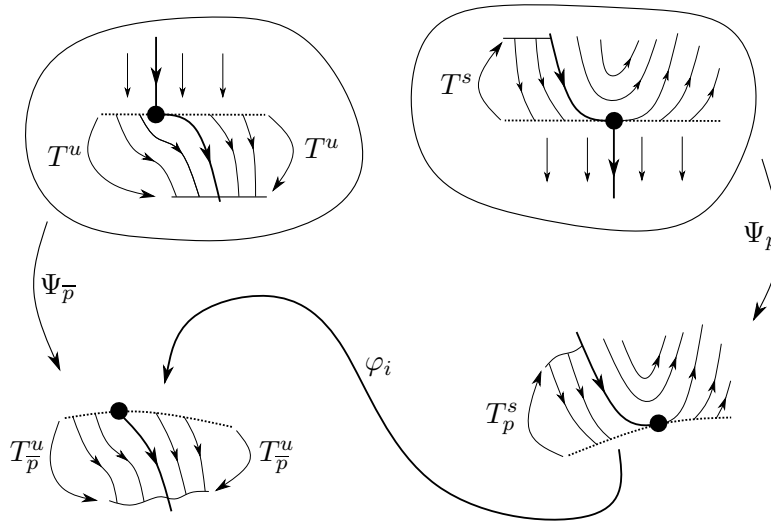

FIGURE 13. Illustration of the process to obtain the transition maps T_p^s and $T_{\bar{p}}^u$.

4. PROOF OF THE MAIN RESULT

We now proof our main result. For simplicity we assume that $Z = (\mathfrak{X}, \Sigma, \Phi)$ is such that Z has two components X_1, X_2 and $\Sigma = h^{-1}(0)$ has one component. We also suppose that $\Gamma^n = \Gamma^3$ is composed by a hyperbolic saddle p_3 and two jump singularities (p_2, \bar{p}_2) and (p_1, \bar{p}_1) , with $\bar{p}_1 = p_1$, see Figure 14. As we shall see, the proof of the general case follows similarly.

Proof of Theorem 1. Let $B_3, B_2, B_{\bar{2}}$ and B_1 be small enough neighborhoods of p_3, p_2, \bar{p}_2 and p_1 respectively and let $\Psi_3: B_3 \rightarrow \mathbb{R}^2$ be the change of variables given by Section 3.1. Let X_s, X_u be the stable and unstable components of p_2 defined over the connected components $A_s, A_u \subset \mathbb{R}^2 \setminus \Sigma$. Let $\Psi_2: B_2 \cap \bar{A}_s \rightarrow \mathbb{R}^2$ and $\Psi_{\bar{2}}: B_2 \cap \bar{A}_u \rightarrow \mathbb{R}^2$ be the change of variables given in Section 3.2. Similarly let $\Psi_1: W_1 \subset B_1 \rightarrow \mathbb{R}^2$ and $\Psi_{\bar{1}}: W_{\bar{1}} \subset B_1 \rightarrow \mathbb{R}^2$ be the change of variables associated to p_1 and \bar{p}_1 respectively. See Figure 14.

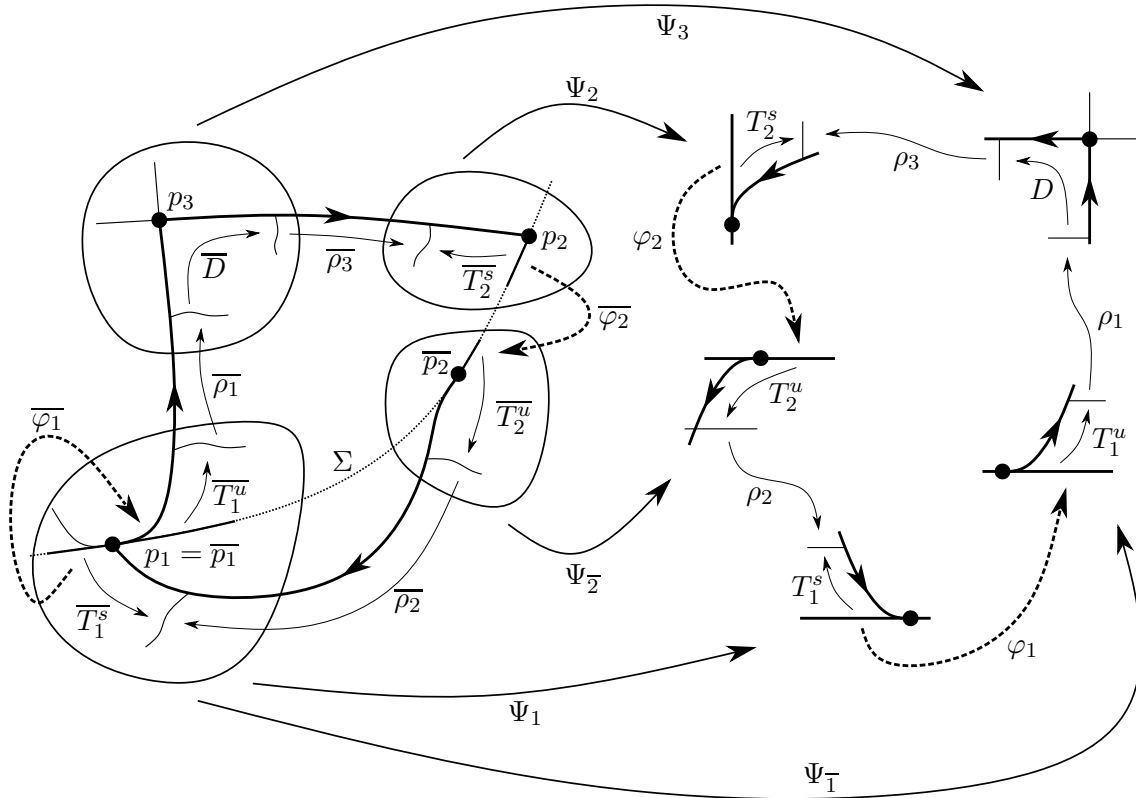

FIGURE 14. Illustration of the maps used in the proof of Theorem 1.

Let $T_i^{s,u}: \sigma_i^{s,u} \rightarrow \tau_i^{s,u}$, $i \in \{1, 2\}$ and $D: \sigma_3 \rightarrow \tau_3$ be the transition maps and the Dulac map given by Section 3.2 and 3.1 respectively. Let

$$\bar{\sigma}_i^s = \Psi_i^{-1}(\sigma_i^s), \quad \bar{\sigma}_i^u = \Psi_{\bar{i}}^{-1}(\sigma_i^u), \quad \bar{\sigma}_3 = \Psi_3^{-1}(\sigma_3), \quad \bar{\tau}_3 = \Psi_3^{-1}(\tau_3), \quad i \in \{1, 2\}$$

and define $\bar{T}_i^{s,u}: \bar{\sigma}_i^{s,u} \rightarrow \bar{\tau}_i^{s,u}$, $i \in \{1, 2\}$ and $\bar{D}: \bar{\sigma}_3 \rightarrow \bar{\tau}_3$ by

$$\bar{T}_i^s = \Psi_i^{-1} \circ T_i^s \circ \Psi_i, \quad \bar{T}_i^u = \Psi_{\bar{i}}^{-1} \circ T_i^u \circ \Psi_{\bar{i}}, \quad \bar{D} = \Psi_3^{-1} \circ D \circ \Psi_3, \quad i \in \{1, 2\}.$$

See Figure 14. Let $\bar{\rho}_3: \bar{\tau} \rightarrow \bar{\tau}_2^s$, $\bar{\rho}_2: \bar{\tau}_2^u \rightarrow \bar{\tau}_1^u$ and $\bar{\rho}_1: \bar{\tau}_1^s \rightarrow \bar{\sigma}_3$ be given by the flow of X_1 and X_2 . Let also $\rho_3: \tau \rightarrow \tau_2^s$, $\rho_2: \tau_2^u \rightarrow \tau_1^s$ and $\rho_1: \tau_1^u \rightarrow \sigma_3$ be given by

$$\rho_3 = \Psi_2 \circ \bar{\rho}_3 \circ \Psi_3^{-1}, \quad \rho_2 = \Psi_1 \circ \bar{\rho}_2 \circ \Psi_{\bar{2}}^{-1}, \quad \rho_1 = \Psi_3 \circ \bar{\rho}_1 \circ \Psi_{\bar{1}}^{-1}.$$

See Figure 14. Let $\bar{\varphi}_i: \bar{\sigma}_i^s \rightarrow \bar{\sigma}_i^u$, $i \in \{1, 2\}$, be given by the restriction of $\bar{\varphi}: \Sigma \rightarrow \Sigma$. Finally let $\varphi_i: \sigma_i^s \rightarrow \sigma_i^u$, $i \in \{1, 2\}$ be given by

$$\varphi_i = \Psi_{\bar{i}} \circ \bar{\varphi}_i \circ \Psi_i^{-1}.$$

See Figure 14. Observe that we can identify each transversal section above (i.e. $\sigma_i^{s,u}$, $\tau_i^{s,u}$ and so on) with the interval $I = \{x \in \mathbb{R}: 0 \leq x < \delta\}$, such that in these coordinates the intersection of the

transversal section with the polycycle is given by $x = 0$. Hence each one of the functions above (i.e. $T_i^{s,u}$, $\overline{T_i^{s,u}}$, ρ_i , $\overline{\rho_i}$, etc) can be seen as a function $f: I \rightarrow I$ such that $f(0) = 0$ and $f(x) \rightarrow 0$ as $x \rightarrow 0$. Moreover, since each of these functions is given by the flow of a smooth vector field in a particular neighborhood, we can also assume that f is strictly increasing. Therefore, from now on in this proof we assume this. Let $\nu < 0 < \lambda$ be the eigenvalues associated with the hyperbolic saddle p_3 . Given $\varepsilon > 0$ let $r_{3,\varepsilon} = \frac{|\nu|}{\lambda + \varepsilon}$. It follows from Proposition 1 that for every $\varepsilon > 0$ small there is $C(\varepsilon) > 0$ such that

$$(6) \quad D(x) < C(\varepsilon)x^{r_{3,\varepsilon}}.$$

Let $n_{i,s}$ and $n_{i,u}$, $i \in \{1, 2\}$ be the stable and unstable contact orders of p_1 and p_2 respectively. It follows from Section 3.2 that

$$(7) \quad T_i^s(x) = C_{i,s}x^{n_{i,s}} + O(x^{n_{i,s}+1}), \quad T_i^u(x) = C_{i,u}x^{n_{i,u}} + O(x^{n_{i,u}+1})$$

with $C_{i,s} \neq 0$ and $C_{i,u} \neq 0$, $i \in \{1, 2\}$. Suppose first that both p_1 and p_2 have finite power order and let $k_i \in \mathbb{N}$ be the power order of p_i , $i \in \{1, 2\}$, that is, $k_i \in \mathbb{N}$ is such that

$$(8) \quad \overline{\varphi}_i(x) = \left(\sum_{k=k_i}^{\infty} a_k x^k \right) + R_i(x),$$

where $a_{k_i} \neq 0$ and R_i is a flat C^∞ -function such that $R_i(0) = 0$, $i \in \{1, 2\}$. Finally since Ψ_i , $\Psi_{\overline{j}}$ and $\overline{\rho}_i$, $i \in \{1, 2, 3\}$, $j \in \{1, 2\}$, are diffeomorphisms, we observe that

$$(9) \quad \rho_i(x) = c_i x + O(x^2),$$

with $c_i \neq 0$, $i \in \{1, 2, 3\}$. We recall that the *hyperbolicity ratio* of p_1 , p_2 , and p_3 and the *graphic number* of Γ^3 are given by

$$r_1 = \frac{n_{1,u}}{n_{1,s}} k_1, \quad r_2 = \frac{n_{2,u}}{n_{2,s}} k_2, \quad r_3 = \frac{|\nu|}{\lambda}, \quad r = r_1 r_2 r_3.$$

Moreover, observe that $r_{3,\varepsilon} \rightarrow r_3$ as $\varepsilon \rightarrow 0$. Hence if we let $\pi: \sigma_3 \rightarrow \sigma_3$ be given by

$$(10) \quad \pi = \rho_1 \circ T_1^u \circ \varphi_1 \circ (T_1^s)^{-1} \circ \rho_2 \circ T_2^u \circ \varphi_2 \circ (T_2^s)^{-1} \circ \rho_3 \circ D,$$

then it follows from (6), (7), (8) and (9) that for $\varepsilon > 0$ small enough we have

$$(11) \quad \begin{aligned} \pi(x) &= \rho_1 \circ T_1^u \circ \varphi_1 \circ (T_1^s)^{-1} \circ \rho_2 \circ T_2^u \circ \varphi_2 \circ (T_2^s)^{-1} \circ \rho_3 \circ D(x) \\ &< \rho_1 \circ T_1^u \circ \varphi_1 \circ (T_1^s)^{-1} \circ \rho_2 \circ T_2^u \circ \varphi_2 \circ (T_2^s)^{-1} \circ \rho_3 (C(\varepsilon)x^{r_{3,\varepsilon}}) \\ &= \rho_1 \circ T_1^u \circ \varphi_1 \circ (T_1^s)^{-1} \circ \rho_2 \circ T_2^u \circ \varphi_2 \circ (T_2^s)^{-1} (C_1(\varepsilon)x^{r_{3,\varepsilon}} + \dots) \\ &= \rho_1 \circ T_1^u \circ \varphi_1 \circ (T_1^s)^{-1} \circ \rho_2 \circ T_2^u \circ \varphi_2 (C_2(\varepsilon)x^{\frac{1}{n_{2,s}}r_{3,\varepsilon}} + \dots) \\ &= \rho_1 \circ T_1^u \circ \varphi_1 \circ (T_1^s)^{-1} \circ \rho_2 \circ T_2^u (C_3(\varepsilon)x^{\frac{1}{n_{2,s}}k_2 r_{3,\varepsilon}} + \dots) \\ &= \rho_1 \circ T_1^u \circ \varphi_1 \circ (T_1^s)^{-1} \circ \rho_2 (C_4(\varepsilon)x^{r_2 r_{3,\varepsilon}} + \dots) \\ &\quad \vdots \\ &= K(\varepsilon)x^{r_1 r_2 r_{3,\varepsilon}} + O(x^{r_1 r_2 r_{3,\varepsilon} + 1}). \end{aligned}$$

Hence if we let $r(\varepsilon) = r_1 r_2 r_{3,\varepsilon}$, then we conclude that

$$0 \leq \pi(x) < K(\varepsilon)x^{r(\varepsilon)} + O(x^{r(\varepsilon)+1}),$$

with $r(\varepsilon) \rightarrow r$ as $\varepsilon \rightarrow 0$. Therefore if $r > 1$, then there is $\varepsilon_0 > 0$ small enough such that $r(\varepsilon_0) > 1$. Hence

$$(12) \quad \frac{\pi(x)}{x} < K(\varepsilon_0)x^{r(\varepsilon_0)-1} + O(x^{r(\varepsilon_0)}).$$

Since $r(\varepsilon_0) - 1 > 0$, we have $x^{r(\varepsilon_0)-1} \rightarrow 0$ as $x \rightarrow 0^+$ and thus from (12) it follows $\pi(x)/x < 1$ for $x > 0$ small enough. Which in turn implies that

$$(13) \quad \pi(x) < x,$$

for $x > 0$ small enough. We now use property (13) of the map (10), which takes place in the normal forms of the singularities of Γ^3 , to study the ‘real’ first return map $\bar{\pi}: \bar{\sigma}_3 \rightarrow \bar{\sigma}_3$ given by

$$(14) \quad \bar{\pi} = \bar{\rho}_1 \circ \bar{T}_1^u \circ \bar{\varphi}_1 \circ (\bar{T}_1^s)^{-1} \circ \bar{\rho}_2 \circ \bar{T}_2^u \circ \bar{\varphi}_2 \circ (\bar{T}_2^s)^{-1} \circ \bar{\rho}_3 \circ \bar{D},$$

which actually takes place on the polycycle Γ^3 , see Figure 14. It follows from (10), (14) and from the definitions of the maps $T_i^{s,u}$, $\bar{T}_i^{s,u}$, ρ_i , $\bar{\rho}_i$, D , \bar{D} , etc that $\bar{\pi} = \Psi_3^{-1} \circ \pi \circ \Psi_3$. Therefore, if $\bar{x} \in \bar{\sigma}_3$ with $\bar{x} > 0$ is small enough (i.e. if \bar{x} is sufficiently near the polycycle), then $\Phi_3(\bar{x}) = x \in \sigma_3$, $x > 0$ is small enough and thus from (13) we have that

$$\bar{\pi}(\bar{x}) = \Psi_3^{-1} \circ \pi \circ \Psi_3(\bar{x}) < \Psi_3^{-1} \circ \Psi_3(\bar{x}) = \bar{x}.$$

So, we arrive in $\bar{\pi}(\bar{x}) < \bar{x}$ for $\bar{x} > 0$ small enough. Hence the polycycle is stable. The case $r < 1$ follows similarly. We need only to replace (6) by

$$C(\varepsilon)x^{s_3, \varepsilon} < D(x),$$

where $s_{3, \varepsilon} = \frac{|\nu|}{\lambda - \varepsilon}$ (see Proposition 1) and thus we obtain

$$\pi(x) > K(\varepsilon_0)x^{s(\varepsilon_0)} + O(x^{s(\varepsilon_0)+1}),$$

for some fixed $\varepsilon_0 > 0$ small enough. Hence

$$(15) \quad \frac{\pi(x)}{x} > K(\varepsilon_0)x^{s(\varepsilon_0)-1} + O(x^{s(\varepsilon_0)}).$$

Since $s(\varepsilon) > 0$ and $s(\varepsilon) - 1 < 0$, it follows from (15) that $\pi(x) > x$ for $x > 0$ small enough and thus the polycycle is unstable. We now work with the case that some jump singularity has an infinity power order. Without loss of generality suppose that p_1 has infinity order. It follows from (8) that $\bar{\varphi}_1(x) = R_1(x)$, where R_1 is a flat function such that $R_1(0) = 0$. Therefore, it follows that for every $k \in \mathbb{N}$ we have

$$(16) \quad \bar{\varphi}_1(x) < x^k,$$

provided $x > 0$ is small enough. Replacing (16) at (11) for a sufficiently large $k \in \mathbb{N}$, we obtain that $\pi(x) < x$ and thus the polycycle is stable. This finishes the proof. \square

Remark 2. *It follows from the proof of Theorem 1 that the result also holds for other frameworks of hybrid systems, such as the Impulsive Discontinuous Dynamical Systems (see Samoilenko and Perestyuk [42, Section 1.4]) and the Impact Hybrid Systems (see di Bernardo [5, Section 2.2.4]).*

5. EXAMPLE AND APPLICATIONS

Based on the Example 1 of the bouncing ball model, we now present an example of model in which we can apply our main result.

Example 2. *Consider the motion of a ball on a table with concave surface. Suppose that the surface of the table is given by the graph of a smooth function $f: [-1, 1] \rightarrow \mathbb{R}$ such that $x = 0$ is the only zero of $f'(x)$. Suppose also that at $x = -1$ and $x = 1$ (i.e. the boundaries of the table) we have two walls preventing the ball to roll off the table. See Figure 15. Let $x \in [-1, 1]$ denote the position of the ball and $v \in \mathbb{R}$ be its initial velocity, where $v > 0$ (resp. $v < 0$) means that the ball is moving to the right-hand side (resp. left-hand side) of the table. If the ball is under the acceleration of constant gravity $g > 0$, then the state of the ball if governed by the system of differential equations,*

$$(17) \quad \dot{x} = v, \quad \dot{v} = g \cos \theta(x),$$

where $\theta: [-1, 1] \rightarrow \mathbb{R}$ is the angle between the vertical axis and the tangent line of the table at the ball, in the counterclockwise direction. See Figure 15. For $x \in (-1, 1)$ and $v \in \mathbb{R}$, The Jacobian matrix of (17) is given by

$$(18) \quad J(x, v) = \begin{pmatrix} 0 & 1 \\ -g \sin \theta(x) \theta'(x) & 0 \end{pmatrix}.$$

Knowing that $f'(x)$ is the slope between the tangent line and the horizontal axis, it is not hard to see that

$$(19) \quad \theta(x) = \frac{\pi}{2} + \arctan f'(x).$$

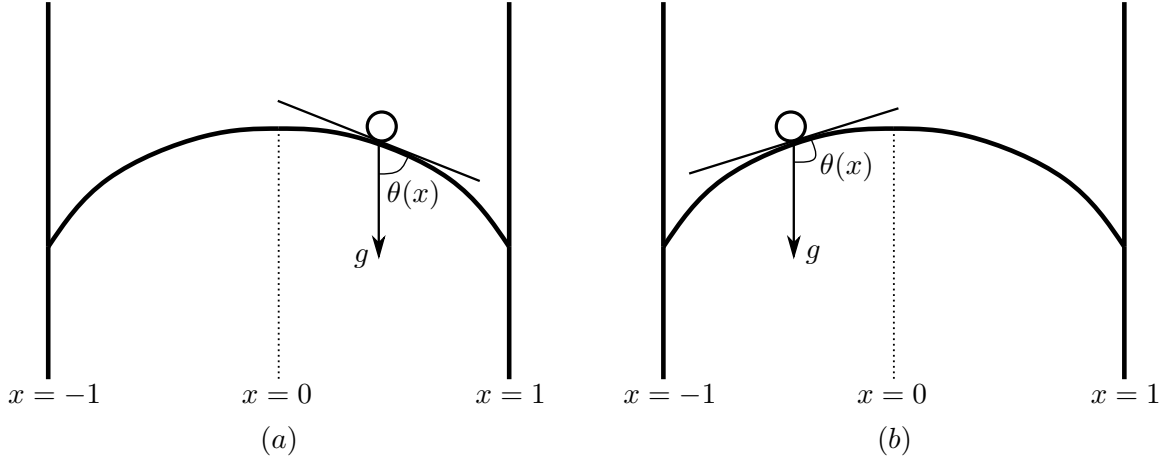

FIGURE 15. Illustration of the model, with (a) $x > 0$ and (b) $x < 0$. Observe that $\theta(x) < \pi/2$ if $x > 0$ and $\theta(x) > \pi/2$ if $x < 0$.

Hence, it follows from (17), (18), (19) and $f'(0) = 0$ that the origin is the unique singularity and its Jacobian matrix is given by,

$$(20) \quad J(0,0) = \begin{pmatrix} 0 & 1 \\ -gf''(0) & 0 \end{pmatrix}.$$

Since f is concave, it follows that $f''(0) < 0$ and thus we have $\det J(0,0) = gf''(0) < 0$. That is, the origin is a hyperbolic saddle. See Figure 16(a). Observe that system (17) is reversible in relation

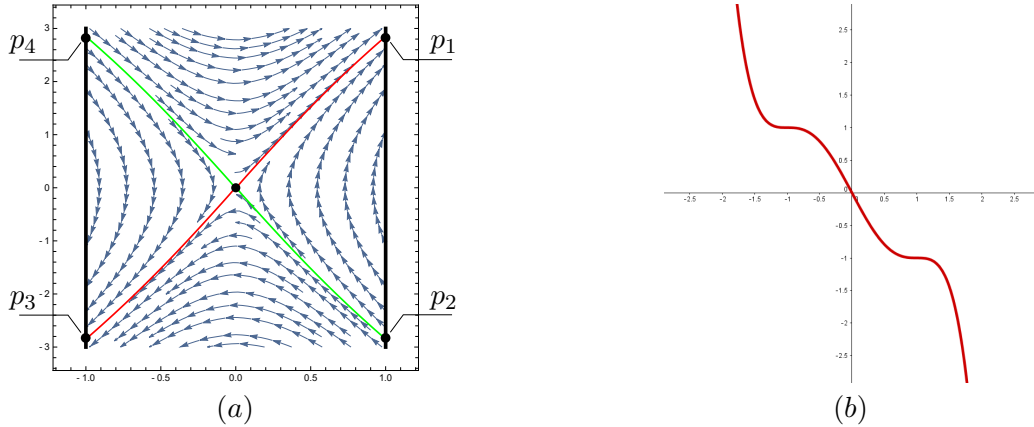

FIGURE 16. Illustration of (a) the phase portrait of system (17) with $g = 9.8$ and $f(x) = -\frac{1}{2}x^2$ and (b) the map φ .

to the lines $x = 0$ and $v = 0$. Hence, the stable and unstable manifolds of the origin intersects the lines $x = -1$ and $x = 1$ symmetrically in the points $p_1 = (1, v_0)$, $p_2 = (1, -v_0)$, $p_3 = (-1, -v_0)$ and $p_4 = (-1, v_0)$, for some $v_0 > 0$. See Figure 16(a). Rescaling the variable v if necessary, we can assume $v_0 = 1$.

We can now suppose that both walls act like a pinball machine and thus when the ball hits the walls, it is tossed back to the table. More precisely we let the map $\varphi: \mathbb{R} \rightarrow \mathbb{R}$ be given by

$$(21) \quad \varphi(v) = -\frac{15}{8}v + \frac{5}{4}v^3 - \frac{3}{8}v^5,$$

represents the gain of energy of the ball when hitting each of the walls, see Figure 16(b). Observe that $\varphi(1) = -1$ and $\varphi(-1) = 1$ and thus φ sends p_1 to p_2 and p_3 to p_4 . In particular our hybrid system has a compound polycycle given by a figure in an eight shape. See Figure 17. It follows from (20) that the hyperbolicity ratio of the origin is given by $r_0 = 1$. From (21) it is not hard to see that $\varphi'(\pm 1) = \varphi''(\pm 1) = 0$ and $\varphi'''(\pm 1) \neq 0$. Hence, the hyperbolicity ratio of the jump singularities (p_1, p_2) and (p_3, p_4) are given by $r_L = 3$ and $r_R = 3$, respectively.

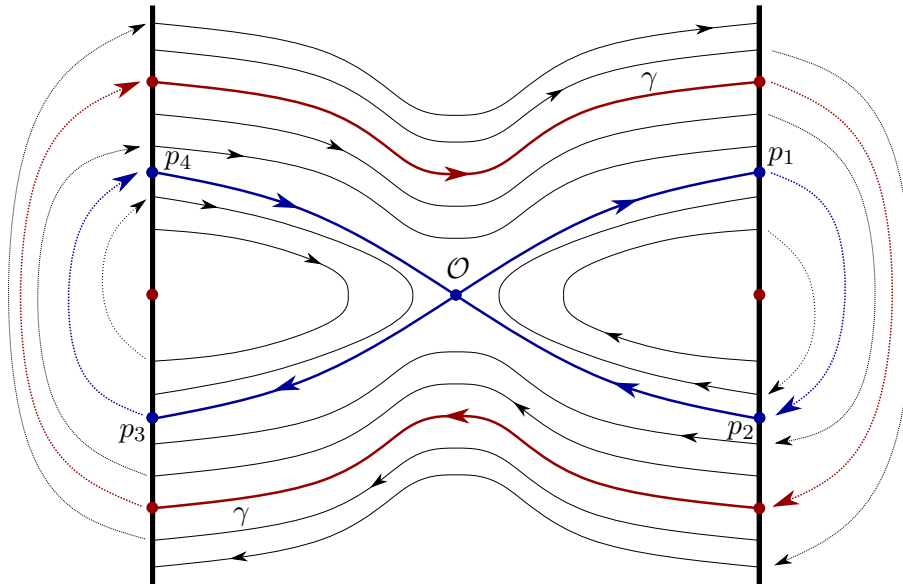

FIGURE 17. Illustration of the hybrid system given by (17) and (21). Blue means stable and red means unstable. Color available on the online version.

Therefore, it follows from Theorem 1 that the polycycles

$$\Gamma_L = \{\mathcal{O}, (p_3, p_4)\}, \quad \Gamma_R = \{\mathcal{O}, (p_1, p_2)\}, \quad \Gamma = \{\mathcal{O}, (p_1, p_2), \mathcal{O}, (p_3, p_4)\},$$

are stable. From (21) it is not hard to see that the orbits hitting the wall with velocity $|v| > 0$ big enough spirals to the infinity, i.e., after a certain threshold the “pinball” walls feed one another and the balls keep going between left and right while the velocity increases. Hence if we consider a first return map $\pi: \ell \rightarrow \ell$, with $\ell = \{0\} \times \mathbb{R}_{v>0}$, then it follows from the Intermediate Value Theorem that we have at least one periodic orbit γ . See Figure 17.

ACKNOWLEDGMENTS

We thank to the reviewers their comments and suggestions which help us to improve the presentation of this paper. The authors are partially supported by São Paulo Research Foundation (FAPESP), grants 2019/10269-3, 2021/01799-9 and 2022/14353-1, and by Coordination of Superior Level Staff Improvement (CAPES-Brazil), grant 88887.475751/2020-00.

REFERENCES

- [1] M. AKHMET, *Nonlinear hybrid continuous/discrete-time models*, Atlantis Stud. Math. Eng. Sci. 8, Atlantis Press, Paris, 2011. xiv+216 pp.
- [2] K. ANDRADE, O. GOMIDE AND D. NOVAES, *Bifurcation diagrams of global connections in Filippov systems*, Nonlinear Anal. Hybrid Syst. 50(2023), Paper No. 101397, 26 pp.
- [3] K. ANDRADE, M. R. JEFFREY, R. M. MARTINS AND M. A. TEIXEIRA, *Homoclinic Boundary-Saddle Bifurcations in Planar Nonsmooth Vector Fields*, Internat. J. Bifur. Chaos Appl. Sci. Engrg.32(2022), no.4, Paper No. 2230009, 27 pp.
- [4] I. BELYKH, R. KUSKE, M. PORFIRI AND D. J. W. SIMPSON, *Beyond the Bristol book: advances and perspectives in non-smooth dynamics and applications*, Chaos33(2023), no.1, Paper No. 010402, 15 pp.
- [5] M. DI BERNARDO, C. J. BUDD, A. R. CHAMPNEYS AND P. KOWALCZYK, *Piecewise-smooth Dynamical Systems: Theory and Applications*, Appl. Math. Sci., 163 Springer-Verlag London, Ltd., London, 2008. xxii+481 pp.
- [6] C. BUZZI, T. CARVALHO AND R. EUZÉBIO, *On Poincaré-Bendixson theorem and non-trivial minimal sets in planar nonsmooth vector fields*, Publ. Mat.62(2018), no.1, 113–131.
- [7] C. BUZZI, T. CARVALHO AND M. TEIXEIRA, *On three-parameter families of filippov systems - the fold-saddle singularity*, Internat. J. Bifur. Chaos Appl. Sci. Engrg.22(2012), no.12, 1250291, 18 pp.
- [8] C. BUZZI, A. GASULL AND P. SANTANA, *On the cyclicity of hyperbolic polycycles*, Preprint, arXiv:2407.20721 (2024).
- [9] M. BRANICKY, *Introduction to Hybrid Systems*, Handbook of Networked and Embedded Control Systems (2005), p. 91-116.
- [10] L. CHERKAS, *The stability of singular cycles*, Differential'nye Uravnenija (1968), 1012–1017.
- [11] A. DUKOV, *Multiplicities of limit cycles appearing after perturbations of hyperbolic polycycles*, Mat. Sb.214(2023), no.2, 90–111; translation in Sb. Math.214(2023), no.2, 226–245.
- [12] H. DULAC, *Sur les cycles limites*, Bull. Soc. Math. France51(1923), 45–188.

- [13] A. FILIPPOV, *Differential equations with discontinuous righthand sides*, Translated from the Russian Math. Appl. (Soviet Ser.), 18 Kluwer Academic Publishers Group, Dordrecht, 1988. x+304 pp.
- [14] A. GASULL, V. MAÑOSA AND F. MAÑOSAS, *Stability of certain planar unbounded polycycles*, J. Math. Anal. Appl. 269(2002), no.1, 332–351.
- [15] M. HAN, S. HU AND X. LIU, *On the stability of double homoclinic and heteroclinic cycles*, Nonlinear Anal. 53(2003), no.5, 701–713.
- [16] M. HAN, Y. WU AND P. BI, *Bifurcation of limit cycles near polycycles with n vertices*, Chaos Solitons Fractals 22(2004), no.2, 383–394.
- [17] M. HAN, X. ZHOU, *On stability discrimination of limit cycles for piecewise smooth systems*, Acta Math. Sin. (Engl. Ser.) 40(2024), no.7, 1785–1803.
- [18] M. HAN AND H. ZHU, *The loop quantities and bifurcations of homoclinic loops*, J. Differential Equations 234(2007), no.2, 339–359.
- [19] A. JACQUEMARD, F. KHECHICHINE-MOURTADA AND A. MOURTADA, *Algorithmes formels appliqués à l'étude de la cyclicité d'un polycycle algébrique générique à quatre sommets hyperboliques*, Nonlinearity 10(1997), no.1, 19–53.
- [20] Z. LI AND X. LIU, *Impact limit cycles in the planar piecewise linear hybrid systems*, Commun. Nonlinear Sci. Numer. Simul. 119(2023), Paper No. 107074, 16 pp.
- [21] S. LI, W. MA, W. ZHANG AND Y. HAO, *Melnikov Method for a Class of Planar Hybrid Piecewise-Smooth Systems*, Internat. J. Bifur. Chaos Appl. Sci. Eng. 26(2016), no.2, 1650030, 12 pp.
Wei, Zhouchao; Zhang, Wei; Kapitaniak, Tomasz
- [22] Y. LI, Z. WEI, W. ZHANG AND T. KAPITANIAK, *Melnikov-type method for chaos in a class of hybrid piecewise-smooth systems with impact and noise excitation under unilateral rigid constraint*, Appl. Math. Model. 122(2023), 506–523.
- [23] Y. LI, Z. WEI, W. ZHANG AND M. YI, *Melnikov-type method for a class of hybrid piecewise-smooth systems with impulsive effect and noise excitation: Homoclinic orbits*, Chaos 32, No. 7, Article ID 073119, 16 p. (2022).
- [24] S. LIU AND M. HAN, *Limit cycle bifurcations near double homoclinic and double heteroclinic loops in piecewise smooth systems*, Chaos Solitons Fractals 175(2023), Paper No. 113970, 11 pp.
- [25] S. LIU AND M. HAN, *Homoclinic and heteroclinic bifurcations in piecewise smooth systems via stability-changing method*, Comput. Appl. Math. 43(2024), no.5, Paper No. 274, 24 pp.
- [26] J. LLIBRE AND P. SANTANA, *Limit cycles and chaos in planar hybrid systems*, Commun. Nonlinear Sci. Numer. Simul. 140(2025), Paper No. 108382.
- [27] J. LLIBRE AND M. TEIXEIRA, *Piecewise linear differential systems with only centers can create limit cycles?*, Nonlinear Dynam. 91(2018), no.1, 249–255.
- [28] D. MARIN AND J. VILADELPRAT, *Asymptotic expansion of the Dulac map and time for unfoldings of hyperbolic saddles: Local setting*, J. Differential Equations 269(2020), no.10, 8425–8467.
- [29] D. MARIN AND J. VILADELPRAT, *Asymptotic expansion of the Dulac map and time for unfoldings of hyperbolic saddles: General setting*, J. Differential Equations 275(2021), 684–732.
- [30] D. MARIN AND J. VILADELPRAT, *On the cyclicity of Kolmogorov polycycles*, Electron. J. Qual. Theory Differ. Equ. (2022), Paper No. 35, 31 pp.
- [31] D. MARIN AND J. VILADELPRAT, *Asymptotic expansion of the Dulac map and time for unfoldings of hyperbolic saddles: Coefficient properties*, J. Differential Equations 404(2024), 43–107.
- [32] A. MOURTADA, *Cyclicité finie des polycycles hyperboliques de champs de vecteurs du plan mise sous forme normale*, Bifurcations of planar vector fields (Luminy, 1989), 272–314. Lecture Notes in Math., 1455
- [33] A. MOURTADA, *Degenerate and Non-trivial Hyperbolic Polycycles with Two Vertices*, J. Differential Equations 113(1994), no.1, 68–83.
- [34] A. MOURTADA, *Bifurcation de cycles limites au voisinage de polycycles hyperboliques et génériques à trois sommets*, Ann. Fac. Sci. Toulouse Math. (6) 3(1994), no.2, 259–292.
- [35] D. NOVAES AND G. RONDON, *Smoothing of nonsmooth differential systems near regular-tangential singularities and boundary limit cycles*, Nonlinearity 34(2021), no.6, 4202–4263.
- [36] D. NOVAES AND G. RONDON, *On limit cycles in regularized Filippov systems bifurcating from homoclinic-like connections to regular-tangential singularities*, Phys. D 442(2022), Paper No. 133526, 15 pp.
- [37] D. NOVAES, M. TEIXEIRA AND I. ZELI, *The generic unfolding of a codimension-two connection to a two-fold singularity of planar Filippov systems*, Nonlinearity 31(2018), no.5, 2083–2104.
- [38] L. PERKO, *Differential equations and dynamical systems*, Third edition Texts Appl. Math. 7, Springer-Verlag, New York, 2001. xiv+553 pp.
- [39] R. ROUSSARIE, *Bifurcations of Planar Vector Fields and Hilbert's Sixteenth Problem*, Mod. Birkhäuser Class. Birkhäuser/Springer, Basel, 1998. xviii+204 pp.
- [40] A. SCHAFT AND H. SCHUMACHER, *An Introduction to Hybrid Dynamical Systems*, Lect. Notes Control Inf. Sci., 251 Springer-Verlag London, Ltd., London, 2000. xiv+174 pp.
- [41] L. SHENG, M. HAN, Y. TIAN, *On the Number of Limit Cycles Bifurcating from a Compound Polycycle*, Internat. J. Bifur. Chaos Appl. Sci. Engng. 30(2020), no.7, 2050099, 16 pp.
- [42] A. M. SAMOILENKO AND N. A. PERESTYUK, *Impulsive differential equations*, World Sci. Ser. Nonlinear Sci. Ser. A Monogr. Treatises 14, 1995. x+462 pp.
- [43] P. SANTANA, *Stability and Cyclicity of Polycycles in Non-smooth Planar Vector Fields*, Qual. Theory Dyn. Syst. 22(2023), no.4, Paper No. 142, 33 pp.
- [44] J. SOTOMAYOR, *Curvas Definidas por Equações Diferenciais no Plano*, Rio de Janeiro: Instituto de Matemática Pura e Aplicada, 1981.

- [45] Z. WEI, Y. LI, I. MOROZ AND W. ZHANG, *Melnikov-type method for a class of planar hybrid piecewise-smooth systems with impulsive effect and noise excitation: Heteroclinic orbits*, Chaos 32(2022), no.10, Paper No. 103127, 16 pp.

¹ IBILCE-UNESP, CEP 15054-000, S. J. RIO PRETO, SÃO PAULO, BRAZIL
Email address: paulo.santana@unesp.br; l.serantola@unesp.br