

Effectful Semantics in 2-Dimensional Categories: Premonoidal and Freyd Bicategories

Hugo Paquet

LIPN, Université Sorbonne Paris Nord
Paris, France

paquet@lipn.univ-paris13.fr

Philip Saville

University of Oxford
Oxford, UK

philip.saville@cs.ox.ac.uk

Premonoidal categories and Freyd categories provide an encompassing framework for the semantics of call-by-value programming languages. Premonoidal categories are a weakening of monoidal categories in which the interchange law for the tensor product may not hold, modelling the fact that effectful programs cannot generally be re-ordered. A Freyd category is a pair of categories with the same objects: a premonoidal category of general programs, and a monoidal category of ‘effect-free’ programs which do admit re-ordering.

Certain recent innovations in semantics, however, have produced models which are not categories but bicategories. Here we develop the theory to capture such examples by introducing premonoidal and Freyd structure in a bicategorical setting. The second dimension introduces new subtleties, so we verify our definitions with several examples and a correspondence theorem—between Freyd bicategories and certain actions of monoidal bicategories—which parallels the categorical framework.

1 Introduction

A fundamental aspect of call-by-value functional programming languages is the distinction between *values* and *computations*. While values are ‘pure’ program fragments that can be passed around safely, computations may interact with their environment in the form of *effects* (such as raising exceptions, interacting with state, or behaving probabilistically), and must therefore be manipulated with care.

Values and computations obey different algebraic properties, and in particular only computations are sensitive to the evaluation order. For instance `print "a"; print "b"` is not equivalent to `print "b"; print "a"`. This is reflected in the denotational semantics of call-by-value languages, which consists of a pair of categories: a monoidal category of values, and a *premonoidal* category of computations. These are related by an identity-on-objects functor coercing values into effect-free computations, and the resulting structure is called a *Freyd category* ([38, 26]).

In this paper we generalize these notions from categories to bicategories. The resulting theory includes models of programming languages in which the morphisms are themselves objects with structure—spans, strategies, parameter spaces, profunctors, open systems, *etc.*—for which the notion of composition uses a universal construction, such as a pullback or a pushout. In these models, the 2-cells play a central role in characterizing the composition operation for morphisms, and additionally provide refined semantic information (see *e.g.* [17, 8, 48, 34, 22]).

1.1 Bicategorical models

A bicategory is a 2-dimensional category in which the associativity and unit laws for the composition of morphisms are replaced by invertible 2-cells satisfying coherence axioms [2]. Bicategories have recently found prominence as models of computational processes: see *e.g.* [31, 6, 12, 1]. We illustrate this with

two simple examples: spans of sets, and graded monads. For reasons of space we have omitted definitions of the basic notions in bicategory theory, such as pseudofunctors, pseudonatural transformations, and modifications. For a textbook account, see *e.g.* [2].

Bicategories of spans. The bicategory $\mathbf{Span}(\mathbf{Set})$ has objects sets and 1-cells $A \rightsquigarrow B$ spans of functions $A \leftarrow S \rightarrow B$. We can compose pairs of morphisms $A \leftarrow S \rightarrow B$ and $B \leftarrow R \rightarrow C$ using a pullback in the category of sets, as on the left below:

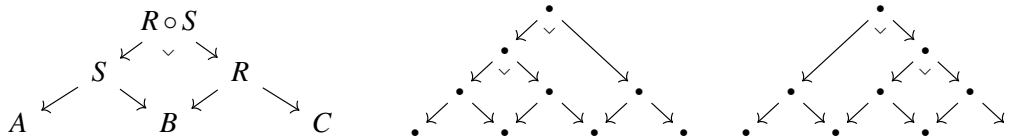

This composition correctly captures a notion of ‘plugging together’ spans, but is only associative in a weak sense, since the two ways of taking pullbacks (on the right above) are not generally equal. But, by the universal property of pullbacks, they are canonically isomorphic as spans.

Kleisli bicategories for graded monads. For another example we consider monads graded by monoidal categories. Formally, a graded monad on a category \mathbb{C} consists of a monoidal category (\mathbb{E}, \bullet, I) of *grades* and a lax monoidal functor $T : \mathbb{E} \rightarrow [\mathbb{C}, \mathbb{C}]$ (see *e.g.* [43, 30, 21]). In particular, this gives a functor $T_e : \mathbb{C} \rightarrow \mathbb{C}$ for every $e \in \mathbb{E}$, and natural transformations $\mu_{e,e'} : T_{e'} \circ T_e \Rightarrow T_{e \bullet e'}$ and $\eta : \text{id} \Rightarrow T_I$ corresponding to a multiplication and unit.

Previous Kleisli-like constructions for graded monads have used presheaf-enriched categories (*e.g.* [10, 28]), but there is also a natural bicategorical construction. The objects are those of \mathbb{C} and 1-cells $A \rightsquigarrow B$ consist of a grade e and a map $f : A \rightarrow T_e B$ in \mathbb{C} . The 2-cells $(e, f) \Rightarrow (e', f')$ are re-gradings: maps $\gamma : e \rightarrow e'$ in \mathbb{E} such that $T_\gamma(B) \circ f = f'$. The composition and identities use the multiplication and unit, as for a Kleisli category. But, unless \mathbb{E} is strict monoidal, this operation is only weakly associative and unital.

A concrete instance of this is the **coPara** construction on a monoidal category \mathbb{C} ([9, 5]), equivalently defined as the Kleisli bicategory for the monad graded by \mathbb{C} itself and given by $T_C(A) = A \otimes C$.

The broader context for this work is the recent occurrence of bicategories in the semantics of programming languages. Bicategories of profunctors are now prominent in the analysis of linear logic and the λ -calculus ([7, 11, 22]), and game semantics employs a variety of span-like constructions that compose weakly ([31, 3]). These models have also influenced the development of 2-dimensional type theories ([8, 34]). This paper supports these developments from the perspective of call-by-value languages. (The connection to linear logic explains our insistence on monoidal rather than cartesian Freyd bicategories.)

1.2 Monoidal bicategories

A monoidal bicategory is a bicategory equipped with a unit object and a tensor product which is only weakly associative and unital. In the categorical setting ‘weakly’ typically means ‘up to isomorphism’; in bicategory theory it typically means ‘up to *equivalence*’.

Definition 1. An equivalence between objects A and B in a bicategory \mathcal{B} is a pair of 1-cells $f : A \rightarrow B$ and $f^\bullet : B \rightarrow A$ together with invertible 1-cells $u : \text{ld}_A \Rightarrow f^\bullet \circ f$ and $c : f \circ f^\bullet \Rightarrow \text{ld}_B$. This is an adjoint equivalence if the witnessing 2-cells u and c satisfy the usual triangle laws for an adjunction (see *e.g.* [24]).

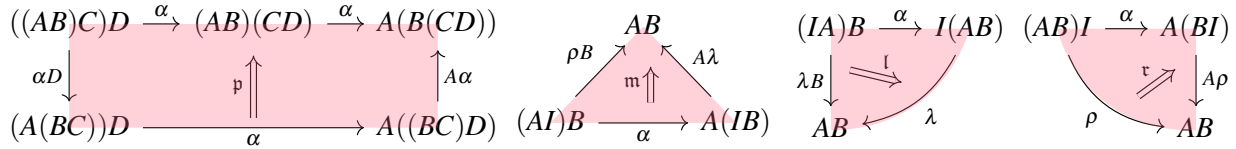

Figure 1: The structural modifications of a monoidal bicategory

It is common in bicategory theory for definitions to ask for adjoint equivalences: these are easier to work with and no stronger than asking for just equivalences (see *e.g.* [24, Proposition 1.5.7]).

The bicategorical version of a natural isomorphism is a *pseudonatural (adjoint) equivalence*: a pseudonatural transformation in which each 1-cell component has the structure of an (adjoint) equivalence.

Definition 2 (*e.g.* [45]). A monoidal bicategory is a bicategory \mathcal{B} equipped with a pseudofunctor $\otimes : \mathcal{B} \times \mathcal{B} \rightarrow \mathcal{B}$ and an object $I \in \mathcal{B}$, together with:

- pseudonatural adjoint equivalences α, λ and ρ with components $\alpha_{A,B,C} : (A \otimes B) \otimes C \rightarrow A \otimes (B \otimes C)$ (the associator), $\lambda_A : I \otimes A \rightarrow A$, and $\rho_A : A \otimes I \rightarrow A$ (the unitors); and
- invertible modifications p, l, m and τ with components as in Figure 1, subject to coherence axioms.

Monoidal bicategories have a technical algebraic definition but nonetheless arise naturally. For example, the cartesian product on the category **Set** induces a monoidal structure on the bicategory $\mathbf{Span}(\mathbf{Set})$. Many other examples appear in a similar fashion: see [49].

Coherence theorems. A careful reader might observe that the diagrams in Figure 1 are not, strictly speaking, well-typed: for example, the anti-clockwise route around the diagram for p could denote $(A\alpha \circ \alpha) \circ \alpha D$ or $A\alpha \circ (\alpha \circ \alpha D)$. This is justified by a suitable *coherence* theorem.

Typically, coherence theorems show that any two parallel 2-cells built out of the structural data are equal. Appropriate coherence theorems apply to bicategories [27], pseudofunctors [14], and (symmetric) monoidal bicategories ([13, 14, 15]). These results justify writing simply \cong for composites of structural data in commutative diagrams of 2-cells, in much the same way as one does for monoidal categories.

As is common in the field, we rely heavily on the coherence of bicategories and pseudofunctors when writing pasting diagrams of 2-cells. We omit all compositors and unitors for pseudofunctors, and ignore the weakness of 1-cell composition. Thus, even though our diagrams do not strictly type-check, coherence guarantees the resulting 2-cell is the same no matter how one fills in the structural details. For example, for a pseudofunctor T on a monoidal bicategory we may write Tl as a 2-cell of type $T(\lambda B) \Rightarrow T\lambda \circ T\alpha$. For a detailed justification see *e.g.* [14, Remark 4.5] or [40, §2.2].

1.3 Premonoidal categories and Freyd categories

Premonoidal categories generalize monoidal categories in that the tensor product \otimes is only functorial in each argument separately [37]. The lack of a monoidal “interchange law” reflects the fact that one cannot generally re-order the statements of an effectful program, even if the data flow permits it. As a consequence, one can directly model effectful programs in a premonoidal category, in the sense that a typed program $(\Gamma \vdash M : A)$ is modelled directly as an arrow $\Gamma \rightarrow A$ and the result of substituting M into another effectful program $(\Delta, x : A \vdash N : B)$ is modelled by the composite $\Delta \otimes \Gamma \xrightarrow{\Delta \otimes M} \Delta \otimes A \xrightarrow{N} B$. Thus, the composition of morphisms in a premonoidal category should be understood as encoding control flow. This is illustrated in Figure 2 using the graphical calculus for premonoidal categories ([20, 39]), where the dashed red line indicates control flow. This direct interpretation contrasts with monadic approaches ([32, 33]), which rely on a monad whose structure may not be reflected in the syntax.

We can axiomatize the morphisms for which interchange does hold. Let \mathbb{D} be a category equipped with functors $A \times (-) : \mathbb{D} \rightarrow \mathbb{D}$ and $(-) \times B : \mathbb{D} \rightarrow \mathbb{D}$ for every $A, B \in \mathbb{D}$, such that $A \times B = A \times B$. We write $A \otimes B$, or just AB , for their joint value, and $(\mathbb{D}, \times, \otimes)$ is called a *binoidal category*. A map $f : A \rightarrow A'$ in \mathbb{D} is *central* if the two diagrams

$$\begin{array}{ccc}
 AB & \xrightarrow{A \times g} & AB' \\
 f \times B \downarrow & & \downarrow f \times B' \\
 A'B & \xrightarrow{A' \times g} & A'B' \\
 & & \downarrow A' \times g \\
 & & A'B'
 \end{array}
 \qquad
 \begin{array}{ccc}
 BA & \xrightarrow{g \times A} & B'A \\
 B \times f \downarrow & & \downarrow B' \times f \\
 BA' & \xrightarrow{g \times A'} & B'A'
 \end{array}
 \quad (1)$$

commute for every $g : B \rightarrow B'$. Semantically, f corresponds to a computation which may be run at any point without changing the observable result.

A premonoidal category is a binoidal category $(\mathbb{D}, \times, \otimes)$ with central structural isomorphisms α, λ and ρ similar to those in a monoidal category. Unlike with monoidal categories, however, the associator α cannot be a natural transformation in all arguments simultaneously, because \otimes is not a functor on \mathbb{D} . Instead, we must ask for naturality in each argument separately, so the following three diagrams commute:

$$\begin{array}{ccc}
 (AB)C & \xrightarrow{(f \times B) \times C} & (A'B)C \\
 \alpha \downarrow & & \downarrow \alpha \\
 A(BC) & \xrightarrow{f \times (BC)} & A'(BC)
 \end{array}
 \qquad
 \begin{array}{ccc}
 (AB)C & \xrightarrow{(A \times g) \times C} & (AB')C \\
 \alpha \downarrow & & \downarrow \alpha \\
 A(BC) & \xrightarrow{A \times (g \times C)} & A(B'C)
 \end{array}
 \qquad
 \begin{array}{ccc}
 (AB)C & \xrightarrow{(AB) \times h} & (AB)C' \\
 \alpha \downarrow & & \downarrow \alpha \\
 A(BC') & \xrightarrow{A \times (B \times h)} & A(BC')
 \end{array}
 \quad (2)$$

Definition 3 ([37]). A premonoidal category is a binoidal category $(\mathbb{D}, \times, \otimes)$ equipped with a unit object I and central isomorphisms $\rho_A : AI \rightarrow A$, $\lambda_A : IA \rightarrow A$ and $\alpha_{A,B,C} : (AB)C \rightarrow A(BC)$ for every $A, B, C \in \mathbb{D}$, natural in each argument separately and satisfying the axioms for a monoidal category.

One important contribution of this paper is to bicategorify the notion of central morphism. We will see that as we move from categories to bicategories centrality evolves from property to structure (Definition 5).

Freyd categories. When modelling call-by-value languages in premonoidal categories, it is natural to think of the values as effect-free computations. Semantically, this is captured by Freyd categories [38], which are premonoidal categories together with a choice of effect-free maps.

Precisely, a Freyd category consists of a monoidal category \mathbb{V} (often *cartesian* monoidal), a premonoidal category \mathbb{C} , and an identity-on-objects functor $J : \mathbb{V} \rightarrow \mathbb{C}$ that strictly preserves the tensor product and structural morphisms, and such that every morphism $J(f)$ is central in \mathbb{C} .

Although every premonoidal category \mathbb{D} canonically induces a Freyd category $\mathcal{Z}(\mathbb{D}) \hookrightarrow \mathbb{D}$, where $\mathcal{Z}(\mathbb{D})$ is the subcategory of central maps (called the *centre*), there are several reasons to consider Freyd categories directly. First, it does not always make sense to regard all central maps as values: for instance, in a language with commutative effects (*e.g.* probability), *all* computations are central. Second, functors between binoidal categories do not in general preserve central maps, whereas morphisms of Freyd categories include a functor between the categories of values specifying how values are sent to values.

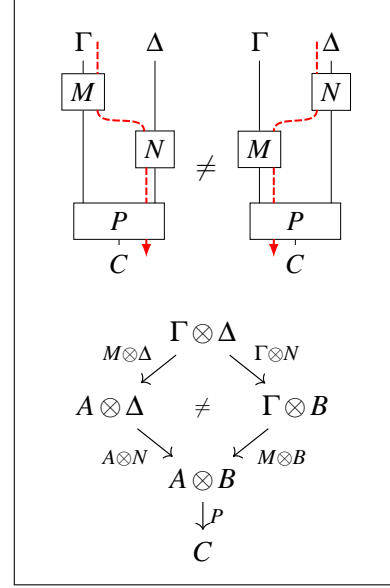

Figure 2: Failure of interchange in a premonoidal category.

Relationship to monad models. Freyd categories encompass the strong monad semantics of call-by-value proposed by Moggi ([32, 33]). Indeed, if (\mathbb{C}, \otimes, I) is symmetric monoidal, then any strength for a monad (T, μ, η) on \mathbb{C} induces a premonoidal structure on the Kleisli category \mathbb{C}_T , and $\eta \circ (-) : \mathbb{C} \rightarrow \mathbb{C}_T$ becomes a Freyd category. Conversely, a Freyd category corresponds to a monad whenever J has a right adjoint [37]. This adjoint is necessary if the programming language has higher-order functions, but some ‘first-order’ Freyd categories are not known to arise from a monad (e.g. [47, 36, 44]).

1.4 Contributions and outline

The central aim of this paper is to introduce definitions of premonoidal bicategories (Definition 6) and Freyd bicategories (Definition 16). Premonoidal structure relies on an adequate notion of centrality for 1-cells and 2-cells in a bicategory (Definition 5). Freyd bicategories then require a coherent assignment of centrality data, which leads to subtle compatibility issues, outlined in Section 2 and Section 3.

As ever with bicategorical definitions (see e.g. [40, §2.1]), the main difficulty is in ensuring the right axioms on the 2-cells. We therefore give further justification for our definitions. On the one hand, we show that our definitions are not too strict: they capture natural examples, presented in Section 2.1 and Section 3.1. On the other hand, we show that our definitions are not too weak: the well-known correspondence between Freyd categories and actions [25] lifts to our setting (Section 4). We note that our definition of action is extracted from standard higher-categorical constructions, and so our work connects to an already-existing and well-understood body of theory.

The definition of premonoidal bicategory presented here is based on that in the ArXiv preprint [35]. For reasons of space, we sketch only the proof of the main theorem Theorem 23 here. For more proofs, see the longer version of this paper, available on the authors’ webpages.

2 Premonoidal bicategories

Just as in the categorical setting (e.g. [37]), our starting point is *binoidal* structure.

Definition 4. A binoidal bicategory $(\mathcal{B}, \rtimes, \ltimes)$ is a bicategory \mathcal{B} with pseudofunctors $A \rtimes (-)$ and $(-) \ltimes B$ for every $A, B \in \mathcal{B}$, such that $A \rtimes B = A \ltimes B$. We write $A \otimes B$, or just AB , for the joint value on objects.

As is standard when moving from categories to bicategories, the category-theoretic property of centrality becomes extra structure in a binoidal bicategory. For the definition, we observe that the diagrams defining centrality (1) amount to requiring that f induces two natural transformations:

$$\begin{aligned} \text{lc}^f : A \rtimes (-) &\Rightarrow A' \rtimes (-) & , & & \text{lc}_B^f := (A \rtimes B = A \ltimes B \xrightarrow{f \times B} A' \ltimes B = A' \rtimes B) \\ \text{rc}^f : (-) \ltimes A &\Rightarrow (-) \ltimes A' & , & & \text{rc}_B^f := (B \ltimes A = B \rtimes A \xrightarrow{B \rtimes f} B \rtimes A' = B \ltimes A') \end{aligned} \quad (3)$$

This lifts naturally to the bicategorical setting, and gives an immediate notion of centrality for 2-cells.

Definition 5. Let $(\mathcal{B}, \rtimes, \ltimes)$ be a binoidal bicategory. A central 1-cell is a 1-cell $f : A \rightarrow A'$ equipped with invertible 2-cells as on the right for every $g : B \rightarrow B'$, such that the 1-cells in (3) are the components of pseudonatural transformations $\text{lc}^f : A \rtimes (-) \Rightarrow A' \rtimes (-)$ and $\text{rc}^f : (-) \ltimes A \Rightarrow (-) \ltimes A'$. A central 2-cell σ between central 1-cells $(f, \text{lc}^f, \text{rc}^f)$ and $(f', \text{lc}^{f'}, \text{rc}^{f'})$ is a 2-cell $\sigma : f \Rightarrow f'$ such that the 2-cells $\sigma \times B$ and $B \times \sigma$ (for $B \in \mathcal{B}$) define modifications $\text{lc}^f \Rightarrow \text{lc}^{f'}$ and $\text{rc}^f \Rightarrow \text{rc}^{f'}$, respectively.

$$\begin{array}{ccccc} AB & \xrightarrow{A \times g} & AB' & & \\ f \times B \downarrow & \text{lc}_g^f & \downarrow f \times B' & & \\ A'B & \xrightarrow{A' \times g} & A'B' & & \\ & & & & \\ BA & \xrightarrow{g \times A} & B'A & & \\ B \times f \downarrow & \text{rc}_g^f & \downarrow B' \times f & & \\ BA' & \xrightarrow{g \times A'} & B'A' & & \end{array}$$

Every monoidal bicategory $(\mathcal{B}, \otimes, I)$ has a canonical binoidal structure, with \times and \rtimes directly induced from the monoidal structure by fixing one argument. Every 1-cell f in \mathcal{B} is canonically central, with lc_g^f given by the interchange isomorphism induced by the pseudofunctor structure of \otimes , and rc_g^f by $(lc_f^g)^{-1}$:

$$lc_g^f := ((f \otimes B') \circ (A \otimes g)) \xrightarrow{\cong} (f \otimes g) \xrightarrow{\cong} (A' \otimes g) \circ (f \otimes B). \quad (4)$$

By the functoriality of \otimes , every 2-cell is central with respect to this structure.

We will define premonoidal bicategories as binoidal bicategories with central structural equivalences. As in Definition 3, the associator α for the tensor product can only be pseudonatural in each argument separately, because \otimes is not a functor of two arguments. We therefore need a family of equivalences $\alpha_{A,B,C} : (A \otimes B) \otimes C \rightarrow A \otimes (B \otimes C)$ together with invertible 2-cells $\bar{\alpha}_{f,B,C}, \bar{\alpha}_{A,g,C}$ and $\bar{\alpha}_{A,B,h}$ filling the three squares in (5), so that we get three families of pseudonatural transformations:

$$\begin{aligned} (\alpha_{-,B,C}, \bar{\alpha}_{-,B,C}) &: (- \times B) \times C \Rightarrow (-) \times (B \otimes C) \\ (\alpha_{A,-,C}, \bar{\alpha}_{A,-,C}) &: (A \times -) \times C \Rightarrow A \times (- \times C) \\ (\alpha_{A,B,-}, \bar{\alpha}_{A,B,-}) &: (A \otimes B) \times (-) \Rightarrow A \times (B \times -) \end{aligned} \quad (5)$$

A premonoidal bicategory also involves structural modifications corresponding to those of Figure 1. Here the 2-dimensional structure introduces new subtleties. For example, one side of modification l in Figure 1 uses the pseudonatural transformation with components $\lambda_A \otimes B : (IA)B \rightarrow AB$. For $g : B \rightarrow B'$, the 2-cell witnessing pseudonaturality of this transformation is the canonical isomorphism that interchanges λ_A and g . This 2-cell does not exist in a premonoidal bicategory, so instead we must use the centrality witness $lc_g^{\lambda_A}$ for λ_A . Thus, we define l to be a family of 2-cells $l_{A,B} : (\lambda_A \times B) \Rightarrow \lambda_{A \otimes B} \circ \alpha_{I,A,B}$, pictured on the left below, inducing modifications in $\text{Hom}(\mathcal{B}, \mathcal{B})$ of both types on the right below:

$$\begin{array}{ccc} (IA)B \xrightarrow{\lambda \times B} AB & (I \times -) \times B \xrightarrow{\lambda \times B} (- \times B) & (IA) \times (-) \xrightarrow{lc^\lambda} (A \times -) \\ \alpha_{I,A,B} \searrow \quad l_{A,B} \nearrow \quad \lambda_{A \otimes B} & \alpha_{I,-,B} \searrow \quad l_{-,B} \nearrow \quad \lambda_{- \times B} & \alpha_{I,A,-} \searrow \quad l_{A,-} \nearrow \quad \lambda_{A \times -} \\ I(AB) & I \times (- \times B) & I \times (A \times -) \end{array}$$

Notice that the middle diagram appears exactly as in the definition of a monoidal bicategory; no adjustments are necessary because each transformation is pseudonatural in the open argument without any assumptions of centrality.

Modulo the subtleties just outlined, our main definition is a natural extension of the categorical one. We abuse notation by saying “ f is central” to mean f comes with chosen lc^f and rc^f making (f, lc^f, rc^f) a central 1-cell and saying “the pseudonatural transformation η is central” to mean each 1-cell component η_A is central.

Definition 6. A premonoidal bicategory is a binoidal bicategory $(\mathcal{B}, \rtimes, \times)$ equipped with a unit object $I \in \mathcal{B}$, together with the following data:

1. For every $A \in \mathcal{B}$, central pseudonatural adjoint equivalences $\lambda_A : I \rtimes A \rightarrow A$ and $\rho_A : A \times I \rightarrow A$;
2. For every $A, B, C \in \mathcal{B}$, an adjoint equivalence $\alpha_{A,B,C} : (A \otimes B) \otimes C \rightarrow A \otimes (B \otimes C)$ with 2-cells as in (5) inducing central pseudonatural equivalences in each component separately;
3. For each $A, B, C, D \in \mathcal{B}$, invertible central 2-cells $\mathfrak{p}_{A,B,C,D}, \mathfrak{m}_{A,B}, l_{A,B}$ and $\mathfrak{r}_{A,B}$, forming modifications in each argument as in Figure 3 or, if not shown there, as in a monoidal bicategory.

This data is subject to the same equations between 2-cells as in a monoidal bicategory.

$$\begin{array}{ccc}
\begin{array}{ccc}
& \alpha_{-B,C,D} & \\
& \nearrow & \\
(-B)(CD) & & \\
& \searrow & \\
& \alpha_{-B,CD} & \\
\end{array} & & \begin{array}{ccc}
& \alpha_{AB,C,-} & \\
& \nearrow & \\
(AB)(C-) & & \\
& \searrow & \\
& \alpha_{A,B,C-} & \\
\end{array} \\
\begin{array}{ccc}
\alpha_{-B,C,D} \downarrow & \uparrow \mathfrak{p}_{-B,C,D} & \\
((-B)C)D & & (-)(B(CD)) \\
\alpha_{-B,BC,D} \downarrow & & \uparrow \mathfrak{r}c^\alpha \\
(-)(BC)D & \xrightarrow{\alpha_{-B,C,D}} & (-)((BC)D)
\end{array} & & \begin{array}{ccc}
\mathfrak{l}c^\alpha \downarrow & \uparrow \mathfrak{p}_{A,B,C,-} & \\
((AB)C)(-) & & A(B(C-)) \\
\alpha_{A,BC,-} \downarrow & & \uparrow A\alpha_{B,C,-} \\
(A(BC))(-) & \xrightarrow{\alpha_{A,BC,-}} & A((BC)(-))
\end{array} \\
\begin{array}{ccc}
\rho_B \nearrow & \mathfrak{m}_{-B} \uparrow & \mathfrak{r}c^\lambda \nwarrow \\
(-)B & & \\
\alpha_{-I,B} \downarrow & & \\
(-I)B & \xrightarrow{\alpha_{-I,B}} & (-)(IB)
\end{array} & & \begin{array}{ccc}
\mathfrak{l}c^\rho \nearrow & \mathfrak{m}_{A,-} \uparrow & A\lambda \nwarrow \\
A(-) & & \\
\alpha_{A,I,-} \downarrow & & \\
(AI)(-) & \xrightarrow{\alpha_{A,I,-}} & A(I-)
\end{array} & & \begin{array}{ccc}
\alpha_{I,A,-} \nearrow & \alpha_{-B,I} \nearrow & \\
(IA)(-) & \xrightarrow{\alpha_{I,A,-}} & I(A-) & (-)I & \xrightarrow{\alpha_{-B,I}} & (-)(BI) \\
\mathfrak{l}c^\lambda \downarrow \Rightarrow & \mathfrak{l}_{A,-} & & \mathfrak{r}_{-B} \searrow & & \downarrow \mathfrak{r}c^\rho \\
A(-) & \xleftarrow{\lambda} & & & \xrightarrow{\rho_{-B}} & AB
\end{array}
\end{array}$$

Figure 3: Modification axioms for the structural 2-cells of a premonoidal bicategory, where they differ from those of a monoidal bicategory. (To save space we suppress \bowtie and \bowtie : these can be inferred.)

Note that we cannot ask for the 2-cell components of the structural transformations to be central: for example, $\bar{\rho}_f$ has type $\rho_{A'} \circ (f \bowtie I) \Rightarrow f \circ \rho_A$, but f may not be a central map. Also note that, although we have changed the conditions for $\mathfrak{p}, \mathfrak{m}, \mathfrak{l}$ and \mathfrak{r} to be modifications, their type as 2-cells has not changed, and thus the equations for a monoidal bicategory are still well-typed.

Just as every premonoidal category has a centre, so does every premonoidal bicategory.

Definition 7. For a premonoidal category $(\mathcal{B}, \bowtie, \bowtie, I)$, denote by $\mathcal{Z}(\mathcal{B})$ the bicategory with the same objects, whose 1-cells and 2-cells are the central 1-cells and central 2-cells in \mathcal{B} . Composition is defined using composition in $\text{Hom}(\mathcal{B}, \mathcal{B})$, and the identity on A is Id_A with the identity transformations.

The pseudofunctors $A \bowtie (-)$ and $(-) \bowtie B$ lift to the centre. Because $A \bowtie (-)$ is a pseudofunctor, then for any central 1-cell $(f, \mathfrak{l}c^f, \mathfrak{r}c^f)$ we already have pseudonatural transformations $A \bowtie \mathfrak{l}c^f$ and $A \bowtie \mathfrak{r}c^f$ in \mathcal{B} . To disambiguate between these transformations and the action of $A \bowtie (-)$ on central 1-cells, we denote the latter by $A \bowtie (f, \mathfrak{l}c^f, \mathfrak{r}c^f) := (A \bowtie f, \mathfrak{l}c^{A \bowtie f}, \mathfrak{r}c^{A \bowtie f})$, and likewise for $(-) \bowtie B$.

Proposition 8. Let $(\mathcal{B}, \bowtie, \bowtie, I)$ be a premonoidal bicategory. For every $A, B \in \mathcal{B}$ the operations $A \bowtie (-)$ and $(-) \bowtie B$ induce pseudofunctors on $\mathcal{Z}(\mathcal{B})$.

Proof sketch. We only sketch the action of $X \bowtie (-)$ and $(-) \bowtie X$ on a central 1-cell $(f, \mathfrak{l}c^f, \mathfrak{r}c^f) : A \rightarrow A'$. For $g : B \rightarrow B'$, the 2-cell $\mathfrak{l}c_g^{X \bowtie f}$ is uniquely determined by the equation

$$\begin{array}{ccc}
\begin{array}{ccc}
(Xf)B & \xrightarrow{\alpha} & (XA')g \\
\downarrow & & \downarrow \\
(XA)g & \xrightarrow{\mathfrak{l}c_g^{X \bowtie f}} & (XA')g \\
\downarrow & & \downarrow \\
(Xf)B' & \xrightarrow{\alpha} & X(A'g) \\
\downarrow & & \downarrow \\
(XA)g & \xrightarrow{\alpha} & X(A'g)
\end{array} & = & \begin{array}{ccc}
(Xf)B & \xrightarrow{\alpha} & (XA')g \\
\downarrow & & \downarrow \\
(XA)g & \xrightarrow{\bar{\alpha}} & X(A'g) \\
\downarrow & & \downarrow \\
(Xf)B' & \xrightarrow{\alpha} & X(A'g) \\
\downarrow & & \downarrow \\
(XA)g & \xrightarrow{\alpha} & X(A'g)
\end{array}
\end{array} \quad (6)$$

in which, for clarity, we have omitted object names and left implicit the functors \bowtie, \bowtie , which can be inferred. This is a valid definition for $\mathfrak{l}c_g^{X \bowtie f}$ because α is an equivalence, and all 2-cells involved are invertible. We similarly construct 2-cells $\mathfrak{l}c_g^{f \bowtie X}, \mathfrak{r}c_g^{X \bowtie f}, \mathfrak{r}c_g^{f \bowtie X}$. The rest of the proof consists of routine verifications. \square

2.1 Examples of premonoidal bicategories

State-passing style. Power & Robinson motivate their definition of premonoidal categories by considering an uncurried version of the State monad [37]: for a symmetric monoidal category (\mathbb{C}, \otimes, I) and an object $S \in \mathbb{C}$ modelling a set of states, one can model a program from A to B interacting with the state as a morphism $S \otimes A \rightarrow S \otimes B$. The same applies bicategorically.

Lemma 9 (c.f. [37], [26, Example A.1]). *Let $(\mathcal{B}, \otimes, I)$ be a symmetric monoidal bicategory (e.g. [45]) and $S \in \mathcal{B}$. Define a bicategory \mathcal{K} with the same objects as \mathcal{B} , hom-categories $\mathcal{K}(A, B) := \mathcal{B}(S \otimes A, S \otimes B)$, and composition and identities as in \mathcal{B} . Then \mathcal{K} admits a canonical premonoidal structure.*

For the binoidal structure, one whisks with the canonical pseudonatural equivalences:

$$\begin{aligned} f \times B &:= (S(AB) \xrightarrow{\cong} (SA)B \xrightarrow{f \otimes B} (SA')B \xrightarrow{\cong} S(A'B)) \\ A \times g &:= (S(AB) \xrightarrow{\cong} A(SB) \xrightarrow{A \otimes g} A(SB') \xrightarrow{\cong} S(AB')) \end{aligned} \quad (7)$$

The structural transformations are then given by composing the structural transformations in \mathcal{B} with the naturality 2-cells for the equivalences in (7).

Bistrong graded monads. It is well-known that if a monad T on a monoidal category (\mathbb{C}, \otimes, I) is *bistrong*, meaning that it is equipped with a left strength $t_{A,B} : A \otimes TB \rightarrow T(A \otimes B)$ and a right strength $s_{A,B} : T(A) \otimes B \rightarrow T(A \otimes B)$, and these strengths are compatible in the sense that the two canonical maps $(A \otimes T(B)) \otimes C \rightarrow T(A \otimes (B \otimes C))$ are equal, then \mathbb{C}_T is premonoidal (see e.g. [29]). (This definition is obscured in the symmetric setting, because if \mathbb{C} is symmetric every strong monad is canonically bistrong.) A similar fact applies to the Kleisli bicategory \mathcal{K}_T for a graded monad defined in Section 1.1. To state this we need to define bistrong graded monads: we make a small adjustment to Katsumata’s definition of strong graded monads [21, Definition 2.5]. An endofunctor $T : \mathbb{C} \rightarrow \mathbb{C}$ equipped with two strengths t and s which are compatible in the sense above is called *bistrong* (see e.g. [29]).

Definition 10. *A bistrong graded monad on a monoidal category (\mathbb{C}, \otimes, I) consists of a monoidal category (\mathbb{E}, \bullet, I) of grades and a lax monoidal functor $T : \mathbb{E} \rightarrow [\mathbb{C}, \mathbb{C}]_{\text{bistrong}}$, where $[\mathbb{C}, \mathbb{C}]_{\text{bistrong}}$ is the category of bistrong endofunctors and natural transformations that commute with both strengths (see e.g. [29]).*

Thus, a bistrong graded monad is a graded monad equipped with natural transformations $t_{A,B}^e : A \otimes T_e(B) \rightarrow T_e(A \otimes B)$ and $s_{A,B}^e : T_e(A) \otimes B \rightarrow T_e(A \otimes B)$ for every grade e , compatible with the graded monad structure and with maps between grades. One then obtains strict pseudofunctors $A \times (-), (-) \times B : \mathcal{K}_T \rightarrow \mathcal{K}_T$ for every $A, B \in \mathcal{K}_T$, defined similarly to the premonoidal structure on a Kleisli category:

$$A \times g = (AB \xrightarrow{A \otimes g} AT_e(B') \xrightarrow{t^e} T_e(AB')) \quad , \quad f \times B = (AB \xrightarrow{f \otimes B} T_e(A')B \xrightarrow{s^e} T_e(A'B)).$$

Moreover, every $f \in \mathbb{C}(A, A')$ determines a ‘pure’ 1-cell in \mathcal{K}_T , as $\tilde{f} := (A \xrightarrow{f} A' \xrightarrow{\eta_{A'}} T_1 A')$. This 1-cell canonically determines a central 1-cell, with $lc_{\tilde{f}}$ and $rc_{\tilde{f}}$ given by the canonical isomorphism in \mathbb{C} ; in particular, $lc_{\tilde{f}} = (rc_{\tilde{f}}^g)^{-1}$ for every $g \in \mathbb{C}(B, B')$. The structural transformations are then all of the form $\tilde{\sigma}$ for σ a structural transformation in \mathbb{E} , and the structural modifications are all canonical isomorphisms of the form $I^{\otimes i} \xrightarrow{\cong} I^{\otimes j}$ for $i, j \in \mathbb{N}$. Summarizing, we have the following.

Proposition 11. *Let (T, μ, η) be a bistrong graded monad on (\mathbb{C}, \otimes, I) with grades (\mathbb{E}, \bullet, I) . Then the bicategory \mathcal{K}_T has a canonical choice of premonoidal structure.*

Unnatural transformations. For any category \mathbb{C} the category $[\mathbb{C}, \mathbb{C}]_u$ of functors and *unnatural* transformations (i.e. families of maps $\sigma_C : FC \rightarrow GC$ with no further conditions) is strictly premonoidal. This is almost by definition, because Power & Robinson define a strict premonoidal category to be a monoid with respect to the funny tensor product \otimes on the category **Cat** [37]. A version holds bicategorically.

Lemma 12 (c.f. [37]). *For any bicategory \mathcal{B} , let $[\mathcal{B}, \mathcal{B}]_u$ denote the bicategory with objects pseudofunctors $F : \mathcal{B} \rightarrow \mathcal{B}$, 1-cells $F \rightarrow G$ families of maps $\{\sigma_B : FB \rightarrow GB \mid B \in \mathcal{B}\}$, and 2-cells $\sigma \Rightarrow \tau$ families of 2-cells $\{m_B : \sigma_B \Rightarrow \tau_B \mid B \in \mathcal{B}\}$. Then $[\mathcal{B}, \mathcal{B}]_u$ admits a premonoidal structure given by composition.*

3 Freyd bicategories

We build up to our definition of Freyd bicategories in stages. Although the bicategories of values and computations have the same objects and their structures are tightly connected, bicategories offer a range of levels of strictness, so we must make careful choices.

We begin with a useful technical notion for relating two pseudofunctors which agree on objects:

Definition 13 ([23]). *For pseudofunctors $F, G : \mathcal{B} \rightarrow \mathcal{C}$ which agree on objects, an icon $\theta : F \rightarrow G$ is an oplax natural transformation whose 1-cell components are all identity. More explicitly, θ is a family of 2-cells $\theta_f : F(f) \rightarrow G(f)$ indexed by 1-cells of \mathcal{B} , subject to naturality, identity and composition laws.*

Using this, we define a notion of strict morphism between binoidal bicategories.

Definition 14. *Let $(\mathcal{V}, \bowtie, \ltimes)$ and $(\mathcal{B}, \bowtie, \ltimes)$ be binoidal bicategories. A 0-strict binoidal pseudofunctor is a pseudofunctor $J : \mathcal{V} \rightarrow \mathcal{B}$ together with families of invertible icons θ^A and ζ^A (for $A \in \mathcal{B}$) as on the right; their existence implicitly requires that $J(A \otimes B) = JA \otimes JB$.*

$$\begin{array}{ccccc}
 \mathcal{V} & \xrightarrow{(-) \times A} & \mathcal{V} & \xleftarrow{A \times (-)} & \mathcal{V} \\
 \downarrow J & \cong \zeta^A & \downarrow J & \cong \theta^A & \downarrow J \\
 \mathcal{B} & \xrightarrow{(-) \times JA} & \mathcal{B} & \xleftarrow{JA \times (-)} & \mathcal{B}
 \end{array}$$

It is crucial that we take preservation up to icons, and not up to identity. In the context of Lemma 9, for instance, we get a 0-strict binoidal pseudofunctor $S \otimes (-) : \mathcal{B} \rightarrow \mathcal{K}$ with icons θ and ζ constructed using the pseudonaturality of the equivalences in (7). However, these icons do strictly commute with the premonoidal structure of \mathcal{K} by the coherence of symmetric monoidal bicategories [15]. This suggests the following; for simplicity we focus on the case where J is identity-on-objects.

Definition 15. *Let $(\mathcal{V}, \bowtie, \ltimes, I)$ and $(\mathcal{B}, \bowtie, \ltimes, I)$ be premonoidal bicategories with the same objects and unit I . An identity-on-objects, 0-strict premonoidal pseudofunctor $\mathcal{V} \rightarrow \mathcal{B}$ is a 0-strict binoidal pseudofunctor (J, θ, ζ) such that J is identity-on-objects and the following axioms hold:*

1. J strictly preserves the components of the structural transformations: for each $A, B, C \in \mathcal{B}$ we have $J\alpha_{A,B,C} = \alpha_{A,B,C}$, $J\lambda_A = \lambda_A$, and $J\rho_A = \rho_A$;
2. J preserves structural 2-cells up to the icons θ and ζ , according to the axioms in Figure 4.

A Freyd bicategory is an identity-on-objects 0-strict premonoidal pseudofunctor from a monoidal bicategory of values to a premonoidal bicategory of computations, together with a choice of centrality witnesses for every value. This choice must be functorial, coherent, and compatible with the interchange law whenever two values are being interchanged. We formalize this in terms of a strict factorization through the centre $\mathcal{Z}(\mathcal{B})$, as is done for Freyd categories [26]. (Unlike for Freyd categories, this factorization is additional structure and not a property of the premonoidal pseudofunctor.)

Definition 16. A Freyd bicategory \mathcal{F} consists of a monoidal bicategory $(\mathcal{V}, \otimes, I)$, a premonoidal bicategory, $(\mathcal{B}, \rtimes, \ltimes, I)$, an identity-on-objects, 0-strict premonoidal pseudofunctor $J : \mathcal{V} \rightarrow \mathcal{B}$, and a binoidal pseudofunctor $J_{\mathcal{Z}}$ factoring J through the centre of \mathcal{B} , as pictured below,

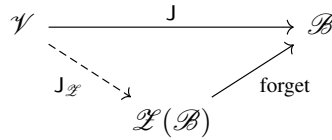

such that the following axioms hold, where we write (Jf, lc^{Jf}, rc^{Jf}) for $J_{\mathcal{Z}}(f)$:

1. The chosen centrality witnesses for the structural 1-cells agree with those in the premonoidal structure of \mathcal{B} .
2. For each value $f : A \rightarrow A'$, the chosen lc^{Jf} satisfies the following compatibility law for every $g \in \mathcal{B}(B, B')$ and $X \in \mathcal{B}$. (This complements the constructions of Proposition 8.)

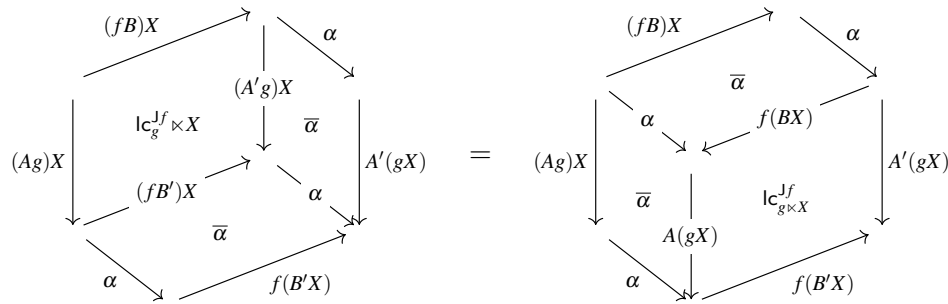

3. For values $x : X \rightarrow X'$ and $y : Y \rightarrow Y'$, lc^{Jx} and rc^{Jy} are determined by the interchange law in \mathcal{V} (4):

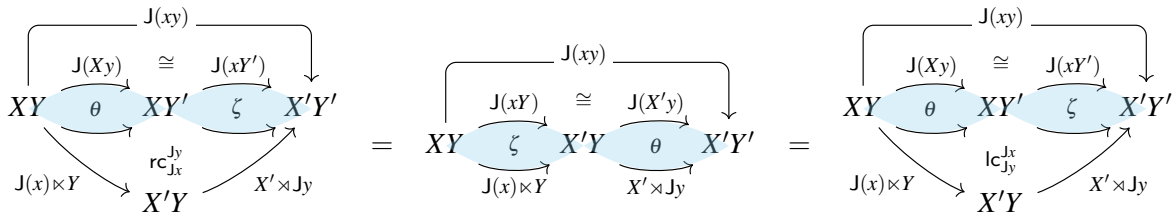

3.1 Examples of Freyd bicategories

Two of the examples of premonoidal bicategories from Section 2.1 naturally yield Freyd bicategories. First, in the context of Lemma 9, we have a pseudofunctor $S \otimes (-) : \mathcal{B} \rightarrow \mathcal{K}$ and icons θ and ζ constructed using the equivalences defining the binoidal structure (recall (7)). Moreover, coherence for symmetric monoidal bicategories [15] gives a unique choice of 2-cell for each $lc_g^{S \otimes f}$ and $rc_g^{S \otimes f}$, so $S \otimes (-)$ factors through the centre, yielding the following.

Lemma 17. Let $(\mathcal{B}, \otimes, I)$ be a symmetric monoidal bicategory and let \mathcal{K} be the premonoidal bicategory defined in Lemma 9. Then the pseudofunctor $S \otimes (-)$ defines a Freyd bicategory $\mathcal{B} \rightarrow \mathcal{K}$.

Similarly, for a bistrong graded monad T , we can think of morphisms in the base monoidal category \mathbb{C} as parameterized maps with trivial parameter space, to construct a Freyd bicategory. The identity-on-objects pseudofunctor has action on morphisms determined by $J(f) := \tilde{f} = \eta \circ f$. The structural icons θ and ζ are the identity, and J factors strictly through the centre because every f has a canonical choice of centrality data.

Proposition 18. *Let (T, η, μ) be a bistrong graded monad on (\mathbb{C}, \otimes, I) with grades (\mathbb{E}, \bullet, I) . Then, writing $d\mathbb{C}$ for the monoidal category \mathbb{C} viewed as a locally-discrete monoidal 2-category, there exists a canonical choice of pseudofunctor J making $J : d\mathbb{C} \rightarrow \mathcal{K}_T$ a Freyd bicategory.*

Finally, recall the unnatural transformations discussed in Section 2.1: although one could expect the inclusion $\iota : [\mathcal{B}, \mathcal{B}] \hookrightarrow [\mathcal{B}, \mathcal{B}]_u$ to be a Freyd bicategory, this is not true even in the categorical setting: it is not the case that every natural transformation is central, so ι does not factor through the centre.

4 Freyd bicategories and actions

Freyd categories may equivalently be defined as certain actions of monoidal categories (e.g. [25]). In this section we show that this is also possible in the two-dimensional setting.

We first define actions of monoidal bicategories. As observed in [19], a left action on a category is equivalently a bicategory with two objects and certain hom-categories taken to be trivial. We therefore define a left action on a bicategory so it is equivalently a *tricategory* (see [13]) with two objects and certain hom-bicategories taken to be trivial. It follows from the coherence of tricategories ([13, 14]) that every diagram of 2-cells constructed using the structural data of an action must commute.

Definition 19. *A left action of a monoidal bicategory $(\mathcal{V}, \otimes, I)$ on a bicategory \mathcal{B} consists of a pseudofunctor $\triangleright : \mathcal{V} \times \mathcal{B} \rightarrow \mathcal{B}$, together with the following data:*

- Pseudonatural adjoint equivalences $\tilde{\lambda}_A : I \triangleright A \rightarrow A$ and $\tilde{\alpha}_{X,Y,C} : (X \otimes Y) \triangleright C \rightarrow X \triangleright (Y \triangleright C)$;
- Invertible modifications as shown below, satisfying the same coherence axioms as $\mathfrak{p}, \mathfrak{m}$, and \mathfrak{l} in a monoidal bicategory (e.g. [45]):

$$\begin{array}{ccc}
 ((XY)Z) \triangleright D \xrightarrow{\tilde{\alpha}} (XY) \triangleright (Z \triangleright D) \xrightarrow{\tilde{\alpha}} X \triangleright (Y \triangleright (Z \triangleright D)) & & (IY) \triangleright C \xrightarrow{\tilde{\alpha}} I \triangleright (Y \triangleright C) \\
 \alpha \triangleright D \downarrow & \begin{array}{c} \tilde{\mathfrak{p}} \uparrow \\ \tilde{\alpha} \end{array} & \uparrow X \triangleright \tilde{\alpha} \\
 (X(YZ)) \triangleright D \xrightarrow{\tilde{\alpha}} X \triangleright ((YZ) \triangleright D) & & (XI) \triangleright C \xrightarrow{\tilde{\alpha}} X \triangleright (I \triangleright C) \\
 & & \begin{array}{c} \rho \triangleright C \uparrow \\ \tilde{\mathfrak{m}} \uparrow \\ \tilde{\alpha} \end{array} \\
 & & \begin{array}{c} X \triangleright C \\ \tilde{\lambda} \end{array} \\
 & & \begin{array}{c} \lambda \triangleright C \downarrow \\ Y \triangleright C \end{array} \\
 & & \tilde{\mathfrak{l}}
 \end{array}$$

A right action $\triangleleft : \mathcal{B} \times \mathcal{V} \rightarrow \mathcal{B}$ can be defined analogously, with a right unitor $\tilde{\rho}_A : A \triangleleft I \rightarrow A$, an associator $\tilde{\alpha}_{A,X,Y} : (A \triangleleft X) \triangleleft Y \rightarrow A \triangleleft (X \otimes Y)$, and 2-dimensional structural data.

Every monoidal bicategory \mathcal{V} has canonical left and right actions on itself given by the monoidal data. As we will see, a Freyd bicategory $J : \mathcal{V} \rightarrow \mathcal{B}$ corresponds to a pair of actions $\triangleright : \mathcal{V} \times \mathcal{B} \rightarrow \mathcal{B}$ and $\triangleleft : \mathcal{B} \times \mathcal{V} \rightarrow \mathcal{B}$ that extend the canonical actions: this mirrors the categorical situation. To that end, we consider a category $\mathcal{V}\text{-act}_{0s}$ of actions of \mathcal{V} and identity-on-objects pseudofunctors that preserve the action strictly on objects, but weakly on morphisms. (This is a very special case of a more canonical notion of map between actions.)

Definition 20. *Let \mathcal{V} be a monoidal bicategory and let $(\mathcal{B}, \triangleright)$ and $(\mathcal{B}', \triangleright')$ be left actions of \mathcal{V} . A 0-strict morphism of actions from $(\mathcal{B}, \triangleright)$ to $(\mathcal{B}', \triangleright')$ is an identity-on-objects functor $J : \mathcal{B} \rightarrow \mathcal{B}'$ satisfying $\tilde{\lambda}_A^\triangleright = J(\tilde{\lambda}_A^{\triangleright'})$ and $\tilde{\alpha}_{A,B,C}^\triangleright = J(\tilde{\alpha}_{A,B,C}^{\triangleright'})$ for every $A, B, C \in \mathcal{B}$, equipped with an icon as on the right, which relates the structural data for the actions according to the axioms below:*

$$\begin{array}{ccc}
 \mathcal{V} \times \mathcal{B} & \xrightarrow{\triangleright} & \mathcal{V} \\
 \mathcal{V} \times J \downarrow & \nearrow \theta & \downarrow J \\
 \mathcal{V} \times \mathcal{B}' & \xrightarrow{\triangleright'} & \mathcal{B}'
 \end{array}$$

$$\begin{array}{c}
 \begin{array}{ccc}
 I \triangleright Jb & \begin{array}{ccc} IB & \xrightarrow{J\tilde{\lambda}^\triangleright} & B \\ \theta \downarrow & \downarrow J(\tilde{\lambda}^\triangleright)_b & \downarrow Jb \\ IB' & \xrightarrow{J\tilde{\lambda}^\triangleright} & B' \end{array} & = & \begin{array}{ccc} IB & \xrightarrow{\tilde{\lambda}^\triangleright} & B \\ I \triangleright Jb \downarrow & \downarrow (\tilde{\lambda}^\triangleright)_{Jb} & \downarrow Jb \\ IB' & \xrightarrow{\tilde{\lambda}^\triangleright} & B' \end{array}
 \end{array} \\
 \\
 \begin{array}{ccc}
 (f \otimes g) \triangleright Jc & \begin{array}{ccc} (AB)C & \xrightarrow{J\tilde{\alpha}^\triangleright} & A(BC) \\ \theta \downarrow & \downarrow J(\tilde{\alpha}^\triangleright)_{f,g,Jc} & \downarrow J(f \triangleright (g \triangleright c)) \\ (A'B')C' & \xrightarrow{J\tilde{\alpha}^\triangleright} & A'(B'C') \end{array} & = & \begin{array}{ccc} (AB)C & \xrightarrow{\tilde{\alpha}^\triangleright} & A(BC) \\ \downarrow (\tilde{\alpha}^\triangleright)_{f,g,Jc} & \downarrow (f \triangleright \theta) \downarrow \theta & \downarrow \\ (A'B')C' & \xrightarrow{\tilde{\alpha}^\triangleright} & A'(B'C') \end{array}
 \end{array} \\
 \\
 \begin{array}{ccc}
 \begin{array}{ccc} (IA)B & \xrightarrow{J\tilde{\alpha}^\triangleright} & I(AB) \\ \lambda \triangleright B \downarrow & \downarrow J\tilde{p}^\triangleright & \downarrow J\tilde{\lambda}^\triangleright \\ \theta & \downarrow & \downarrow \\ AB & & AB \end{array} & = & \begin{array}{ccc} (IA)B & \xrightarrow{\tilde{\alpha}^\triangleright} & I(AB) \\ \lambda \triangleright B \downarrow & \downarrow \tilde{p}^\triangleright & \downarrow \tilde{\lambda}^\triangleright \\ \theta & \downarrow & \downarrow \\ AB & & AB \end{array} \\
 \\
 \begin{array}{ccc} (AI)B & \xrightarrow{J\tilde{\alpha}^\triangleright} & A(IB) \\ \rho \triangleright B \downarrow & \downarrow J(\tilde{m}^\triangleright) & \downarrow J(A \triangleright \tilde{\lambda}^\triangleright) \\ \theta & \downarrow & \downarrow \\ AB & & AB \end{array} & = & \begin{array}{ccc} (AI)B & \xrightarrow{\tilde{\alpha}^\triangleright} & A(IB) \\ \rho \triangleright B \downarrow & \downarrow \tilde{m}^\triangleright & \downarrow \theta \\ \theta & \downarrow & \downarrow \\ AB & & AB \end{array}
 \end{array} \\
 \\
 \begin{array}{ccc}
 \begin{array}{ccc} \alpha \triangleright D & \begin{array}{ccc} ((AB)C)D & \xrightarrow{J\tilde{\alpha}^\triangleright} & (AB)(CD) \\ \theta \downarrow & \downarrow J\tilde{p}^\triangleright & \downarrow J\tilde{\alpha}^\triangleright \\ (A(BC))D & & (A(B(CD))) \\ J\tilde{\alpha}^\triangleright \downarrow & \downarrow \theta & \downarrow A \triangleright \tilde{\alpha}^\triangleright \\ A((BC)D) & & A(B(CD)) \end{array} \\
 \end{array} \\
 \parallel \\
 \begin{array}{ccc} \alpha \triangleright D & \begin{array}{ccc} ((AB)C)D & \xrightarrow{\tilde{\alpha}^\triangleright} & (AB)(CD) \\ \tilde{\alpha}^\triangleright \downarrow & \downarrow \tilde{p}^\triangleright & \downarrow \tilde{\alpha}^\triangleright \\ (A(BC))D & & (A(B(CD))) \\ \tilde{\alpha}^\triangleright \downarrow & \downarrow \theta & \downarrow A \triangleright \tilde{\alpha}^\triangleright \\ A((BC)D) & & A(B(CD)) \end{array} \\
 \end{array}
 \end{array}
 \end{array}$$

A key example is the following:

Definition 21. For a monoidal bicategory $(\mathcal{V}, \otimes, I)$, a left extension of the canonical action of \mathcal{V} on itself is a \mathcal{V} -action $(\mathcal{B}, \triangleright)$, together with a 0-strict morphism $(J, \theta) : (\mathcal{V}, \otimes) \rightarrow (\mathcal{B}, \triangleright)$ such that θ is invertible. (We say this is an extension along J .)

We define a right extension analogously; this involves a right action $\triangleleft : \mathcal{B} \times \mathcal{V} \rightarrow \mathcal{B}$ and an invertible icon with components $\zeta_{f,g} : f \triangleleft Jg \Rightarrow J(f \otimes g)$. The rest of this section is devoted to showing Freyd bicategories may be equivalently presented as pairs of extensions, which we call *Freyd actions*.

Definition 22. A Freyd action consists of an identity-on-objects pseudofunctor $J : \mathcal{V} \rightarrow \mathcal{B}$ from a monoidal bicategory $(\mathcal{V}, \otimes, I)$ to a bicategory \mathcal{B} , together with:

1. A left extension (\triangleright, θ) and right extension (\triangleleft, ζ) along J of the canonical actions of \mathcal{V} on itself;
2. A pseudonatural adjoint equivalence κ with 1-cell components $\kappa_{X,B,Z} = J(\alpha_{X,B,Z}) : (X \triangleright B) \triangleleft Z \rightarrow X \triangleright (B \triangleleft Z)$, subject to the equation below and additional axioms given in Appendix A:

$$\begin{array}{ccc}
 \begin{array}{ccc} (XY)Z & \xrightarrow{\kappa} & X(YZ) \\ (f \triangleright Jg) \triangleleft h \downarrow & \downarrow \bar{\kappa}_{f,Jg,h} & \downarrow J(f \otimes (g \otimes h)) \\ (X'Y')Z' & \xrightarrow{\kappa} & X'(Y'Z') \end{array} & = & \begin{array}{ccc} (XY)Z & \xrightarrow{J(\alpha)} & X(YZ) \\ (f \triangleright Jg) \triangleleft h \downarrow & \downarrow \theta \triangleleft \zeta & \downarrow J(\bar{\alpha}_{f,g,h}) \\ (X'Y')Z' & \xrightarrow{J(\alpha)} & X'(Y'Z') \end{array}
 \end{array}$$

We construct an equivalence of categories between Freyd actions and Freyd bicategories, over a fixed identity-on-objects pseudofunctor $J : \mathcal{V} \rightarrow \mathcal{B}$. (The corresponding categorical result is a bijection, but we must work modulo the structural isomorphisms, and hence lose the strictness.)

On one side, the category $\mathbf{FreydAct}(J)$ has objects Freyd actions $(\triangleright, \theta, \triangleleft, \zeta, \kappa)$ with underlying pseudofunctor J . Morphisms $((\triangleright, \theta), (\triangleleft, \zeta), \kappa) \rightarrow ((\triangleright', \theta'), (\triangleleft', \zeta'), \kappa')$ are pairs of icons $\vartheta : \triangleright \Rightarrow \triangleright'$ and

$$\begin{array}{ccc}
I \times Jg \left(\begin{array}{ccc} IB & \xrightarrow{J\lambda} & B \\ \theta \downarrow & J\bar{\lambda}_g \downarrow & \downarrow Jg \\ IB' & \xrightarrow{J\lambda} & B' \end{array} \right) = I \times Jg \downarrow \left(\begin{array}{ccc} IB & \xrightarrow{\lambda} & B \\ \bar{\lambda}_{Jg} \downarrow & & \downarrow Jg \\ IB' & \xrightarrow{\lambda} & B' \end{array} \right) & & Jf \times I \left(\begin{array}{ccc} AI & \xrightarrow{J\rho} & A \\ \theta \downarrow & J\bar{\rho}_f \downarrow & \downarrow Jf \\ A'I & \xrightarrow{J\rho} & A' \end{array} \right) = Jf \times I \downarrow \left(\begin{array}{ccc} AI & \xrightarrow{\rho} & A \\ \bar{\rho}_{Jf} \downarrow & & \downarrow Jf \\ A'I & \xrightarrow{\rho} & A' \end{array} \right) \\
\left(\begin{array}{ccc} (AB)C & \xrightarrow{J\alpha} & A(BC) \\ \zeta \times C \downarrow \zeta & J\bar{\alpha}_{f,B,C} \downarrow & \downarrow \bar{\alpha}_{f,B,C} \downarrow \zeta \\ (A'B)C & \xrightarrow{J\alpha} & A'(BC) \end{array} \right) = \left(\begin{array}{ccc} (AB)C & \xrightarrow{\alpha} & A(BC) \\ \zeta \downarrow & J(f(BC)) & \downarrow \zeta \\ (A'B)C & \xrightarrow{\alpha} & A'(BC) \end{array} \right) & & \left(\begin{array}{ccc} (AB)C & \xrightarrow{J\alpha} & A(BC) \\ \theta \times C \downarrow \zeta & J\bar{\alpha}_{A,g,C} \downarrow & \downarrow \bar{\alpha}_{A,g,C} \downarrow \theta \\ (AB')C & \xrightarrow{J\alpha} & A(B'C) \end{array} \right) = \left(\begin{array}{ccc} (AB)C & \xrightarrow{\alpha} & A(BC) \\ \theta \downarrow & J(A(gC)) & \downarrow \theta \\ (AB')C & \xrightarrow{\alpha} & A(B'C) \end{array} \right) \\
AB \times Jh \left(\begin{array}{ccc} (AB)C & \xrightarrow{J\alpha} & A(BC) \\ \theta \downarrow & J\bar{\alpha}_{A,B,h} \downarrow & \downarrow \bar{\alpha}_{A,B,h} \downarrow \theta \\ (AB)C' & \xrightarrow{J\alpha} & A(BC') \end{array} \right) = \left(\begin{array}{ccc} (AB)C & \xrightarrow{\alpha} & A(BC) \\ \theta \downarrow & J(A(Bh)) & \downarrow \theta \\ (AB)C' & \xrightarrow{\alpha} & A(BC') \end{array} \right)
\end{array}$$

(a) Compatibility rules for structural transformations

$$\begin{array}{ccc}
\left(\begin{array}{ccc} (IA)B & \xrightarrow{J\alpha} & I(AB) \\ \zeta \downarrow & J\lambda \downarrow & \downarrow J\lambda \\ \lambda \times B & \xrightarrow{J\lambda} & AB \end{array} \right) = \left(\begin{array}{ccc} (IA)B & \xrightarrow{\alpha} & I(AB) \\ \lambda \times B & \xrightarrow{\lambda} & AB \end{array} \right) & & \left(\begin{array}{ccc} \alpha \times D & \zeta \downarrow & ((AB)C)D \\ J\alpha \downarrow & J\rho \downarrow & \downarrow J\alpha \\ (A(BC))D & \xrightarrow{J\alpha} & (AB)(CD) \\ A \times \alpha & \theta \downarrow & \downarrow \theta \\ A((BC)D) & \xrightarrow{J\alpha} & A(B(CD)) \end{array} \right) \\
\left(\begin{array}{ccc} (AB)I & \xrightarrow{J\alpha} & A(BI) \\ J\rho \downarrow & J\tau \downarrow & \downarrow J\tau \\ AB & \xrightarrow{A \times \rho} & A \times \rho \end{array} \right) = \left(\begin{array}{ccc} (AB)I & \xrightarrow{\alpha} & A(BI) \\ \rho \downarrow & \tau \downarrow & \downarrow \tau \\ AB & \xrightarrow{A \times \rho} & A \times \rho \end{array} \right) & & \parallel \\
\left(\begin{array}{ccc} (AI)B & \xrightarrow{J\alpha} & A(IB) \\ \zeta \downarrow & J(\rho B) \downarrow & \downarrow J(\rho B) \\ \rho \times B & \xrightarrow{J(\rho B)} & AB \end{array} \right) = \left(\begin{array}{ccc} (AI)B & \xrightarrow{\alpha} & A(IB) \\ \rho \times B & \xrightarrow{\rho \times B} & AB \end{array} \right) & & \left(\begin{array}{ccc} \alpha \times D & \zeta \downarrow & ((AB)C)D \\ \alpha \downarrow & p \downarrow & \downarrow p \\ (A(BC))D & \xrightarrow{\alpha} & (AB)(CD) \\ A \times \alpha & \theta \downarrow & \downarrow \theta \\ A((BC)D) & \xrightarrow{\alpha} & A(B(CD)) \end{array} \right)
\end{array}$$

(b) Compatibility rules for structural modifications

Figure 4: Compatibility laws for Definition 15

$\chi : \triangleleft \Rightarrow \triangleleft'$ fitting in the diagram in $\mathcal{V}\text{-act}_{0s}$ as on the left below, such that κ is preserved as on the right:

$$\begin{array}{ccc}
\left(\begin{array}{ccc} (\mathcal{B}, \triangleright) & \xleftarrow{(J, \theta)} & (\mathcal{V}, \otimes) \\ \downarrow (id_{\mathcal{B}}, \vartheta) & \searrow (J, \theta') & \downarrow (id_{\mathcal{B}}, \chi) \\ (\mathcal{B}, \triangleright') & & (\mathcal{B}', \triangleleft') \end{array} \right) \xrightarrow{(J, \zeta')} & & \left(\begin{array}{ccc} (AB)C & \xrightarrow{\kappa'} & A(BC) \\ \vartheta \triangleleft h \downarrow \chi & \bar{\kappa}'_{f,b,h} \downarrow & \downarrow f \triangleright' (b \triangleleft h) \\ (A'B')C' & \xrightarrow{\kappa'} & A'(B'C') \end{array} \right) = \left(\begin{array}{ccc} (AB)C & \xrightarrow{\kappa} & A(BC) \\ f \triangleright b \triangleleft h \downarrow & \bar{\kappa}_{f,b,h} \downarrow & \downarrow f \triangleright \chi \downarrow \vartheta \\ (A'B')C' & \xrightarrow{\kappa} & A'(B'C') \end{array} \right)
\end{array}$$

On the other side, the category $\mathbf{FreydBicat}(J)$ has objects Freyd bicategories whose underlying pseudofunctor is J ; these are determined by a premonoidal structure on \mathcal{B} and families of icons $\theta = \{\theta^A \mid A \in \mathcal{B}\}$ and $\{\zeta^A \mid A \in \mathcal{B}\}$ making the pseudofunctor J premonoidal. Morphisms $(\times, \times, \theta, \zeta) \rightarrow (\times', \times', \theta', \zeta')$ are families of icons $\vartheta^A : (A \times -) \Rightarrow (A \times' -)$ and $\chi^A : (- \times A) \Rightarrow (- \times' A)$ making

the identity pseudofunctor $\mathcal{B} \rightarrow \mathcal{B}$ premonoidal and such that $(J, \theta', \zeta') \circ (\text{id}_{\mathcal{B}}, \vartheta, \chi) = (J, \theta, \zeta)$ as premonoidal pseudofunctors.

Our correspondence theorem is then as follows.

Theorem 23. *For any monoidal bicategory $(\mathcal{V}, \otimes, I)$, bicategory \mathcal{B} , and identity-on-objects pseudofunctor $J: \mathcal{V} \rightarrow \mathcal{B}$, the categories $\mathbf{FreydAct}(J)$ and $\mathbf{FreydBicat}(J)$ are equivalent.*

5 Conclusions

Summary. We have introduced bicategorical versions of premonoidal categories (Definition 6) and Freyd categories (Definition 16). Along the way we have observed subtleties that arise only in the 2-dimensional setting, and discussed simple canonical examples. Finally, we have connected our theory to the existing literature by showing our definition is equivalent to certain actions in the expected way.

This paper develops abstract categorical notions, but these are intended to be immediately practical. Specifically, the literature contains no satisfying account of call-by-value languages in bicategories of games ([31, 3]), spans [6], or profunctors [7], and this work offers a technical basis to fill that gap. Our next steps will be in this direction.

Perspectives. This work takes place in a broader line of research on bicategorical semantic structures, and there are several avenues to explore. We expect a tight connection between Freyd bicategories and recently-developed notions of strength for pseudomonads on monoidal bicategories ([46, 35, 42]). Freyd bicategories should also be related to a 2-dimensional notion of *arrows*, based on **Cat**-valued profunctors, yet to be developed ([16, 4]).

In particular, the Kleisli bicategory of a strong pseudomonad should be premonoidal, and the canonical functor from the base category should give a Freyd structure, and conversely, a *closed* Freyd bicategory should be equivalent to a strong pseudomonad together with Kleisli exponentials. From a syntactic perspective, we expect cartesian Freyd bicategories to have an internal language similar to fine-grained call-by-value λ -calculus [26], with the addition of *rewrites* between terms (*c.f.* [41, 17, 18, 8]).

In a more theoretical direction, although the centre of a premonoidal category is always a monoidal category, this does not happen in the bicategorical setting. Roughly speaking, for central f and g , the interchange of f and g is witnessed independently by 2-cells lc_g^f and $(\text{rc}_f^g)^{-1}$. This leads to ambiguity and it is not clear how to define the pseudofunctor \otimes ; indeed, it is not even clear that these 2-cells are themselves central. In this paper we have shown that the centre is a binoidal bicategory, and in further work we will give a more complete description of its structure, along with an alternative presentation of Freyd bicategories in terms of centrality witnesses.

Acknowledgements. HP was supported by a Royal Society University Research Fellowship and by a Paris Region Fellowship co-funded by the European Union (Marie Skłodowska-Curie grant agreement 945298). PS was supported by the Air Force Office of Scientific Research under award number FA9550-21-1-0038. Both authors thank D. McDermott, N. Arkor, and the Oxford PL group for useful discussions.

References

- [1] J. C. Baez, B. Fong & B. S. Pollard (2016): *A compositional framework for Markov processes*. *Journal of Mathematical Physics* 57(3), doi:10.1063/1.4941578.

- [2] J. Bénabou (1967): *Introduction to bicategories*. In: *Reports of the Midwest Category Seminar*, Springer Berlin Heidelberg, Berlin, Heidelberg, pp. 1–77, doi:10.1007/BFb0074299.
- [3] S. Castellan, P. Clairambault, S. Rideau & G. Winskel (2017): *Games and Strategies as Event Structures*. *Logical Methods in Computer Science* Volume 13, Issue 3, doi:10.23638/LMCS-13(3:35)2017.
- [4] Alexander S Corner (2016): *Day convolution for monoidal bicategories*. Ph.D. thesis, University of Sheffield.
- [5] G. S. H. Cruttwell, B. Gavranović, N. Ghani, P. Wilson & F. Zanasi (2022): *Categorical Foundations of Gradient-Based Learning*. In: *Programming Languages and Systems*, doi:10.1007/978-3-030-99336-8_1.
- [6] J. L. Fiadeiro & V. Schmitt (2007): *Structured Co-spans: An Algebra of Interaction Protocols*. In: *Algebra and Coalgebra in Computer Science*, pp. 194–208, doi:10.1007/978-3-540-73859-6_14.
- [7] M. Fiore, N. Gambino, M. Hyland & G. Winskel (2007): *The cartesian closed bicategory of generalised species of structures*. *Journal of the London Mathematical Society* 77(1), pp. 203–220, doi:10.1112/jlms/jdm096.
- [8] M. Fiore & P. Saville (2019): *A type theory for cartesian closed bicategories*. In: *34th Annual ACM/IEEE Symposium on Logic in Computer Science (LICS)*, doi:10.1109/LICS.2019.8785708.
- [9] B. Fong, D. Spivak & R. Tuyeras (2019): *Backprop as Functor: A compositional perspective on supervised learning*. In: *34th Annual ACM/IEEE Symposium on Logic in Computer Science (LICS)*, doi:10.1109/lics.2019.8785665.
- [10] M. Gaboardi, S. Katsumata, D. Orchard & T. Sato (2021): *Graded Hoare Logic and its Categorical Semantics*. In: *Programming Languages and Systems*, pp. 234–263, doi:10.1007/978-3-030-72019-3_9.
- [11] Z. Galal (2020): *A Profunctorial Scott Semantics*. In: *5th International Conference on Formal Structures for Computation and Deduction (FSCD 2020)*, doi:10.4230/LIPICS.FSCD.2020.16.
- [12] F. R. Genovese, J. Herold, F. Loregian & D. Palombi (2021): *A Categorical Semantics for Hierarchical Petri Nets*. *Electronic Proceedings in Theoretical Computer Science* 350, pp. 51–68, doi:10.4204/eptcs.350.4.
- [13] R. Gordon, A. J. Power & R. Street (1995): *Coherence for tricategories*. *Memoirs of the American Mathematical Society*, doi:10.1090/memo/0558.
- [14] N. Gurski (2013): *Coherence in Three-Dimensional Category Theory*. Cambridge University Press, doi:10.1017/CBO9781139542333.
- [15] N. Gurski & A. Osorno (2013): *Infinite loop spaces, and coherence for symmetric monoidal bicategories*. *Advances in Mathematics* 246, pp. 1 – 32, doi:10.1016/j.aim.2013.06.028.
- [16] C. Heunen & B. Jacobs (2006): *Arrows, like Monads, are Monoids*. In: *22nd Annual Conference on Mathematical Foundations of Programming Semantics (MFPS)*, doi:10.1016/j.entcs.2006.04.012.
- [17] B. P. Hilken (1996): *Towards a proof theory of rewriting: the simply typed 2λ -calculus*. *Theoretical Computer Science* 170(1), pp. 407–444, doi:10.1016/S0304-3975(96)80713-4.
- [18] T. Hirschowitz (2013): *Cartesian closed 2-categories and permutation equivalence in higher-order rewriting*. *Logical Methods in Computer Science* 9, pp. 1–22, doi:10.2168/LMCS-9(3:10)2013.
- [19] G. Janelidze & G. M. Kelly (2001): *A note on actions of a monoidal category*. *Theory and Applications of Categories* 9(4), pp. 61–91. Available at tac.mta.ca/tac/volumes/9/n4/n4.pdf.
- [20] A. Jeffrey (1997): *Premonoidal categories and a graphical view of programs*.
- [21] S. Katsumata (2014): *Parametric effect monads and semantics of effect systems*. In: *41st ACM SIGPLAN-SIGACT Symposium on Principles of Programming Languages (POPL)*, doi:10.1145/2535838.2535846.
- [22] A. Kerinec, G. Manzonetto & F. Olimpieri (2023): *Why Are Proofs Relevant in Proof-Relevant Models?* *Proceedings of the ACM on Programming Languages (POPL)*, doi:10.1145/3571201.
- [23] S. Lack (2008): *Icons*. *Applied Categorical Structures* 18(3), pp. 289–307, doi:10.1007/s10485-008-9136-5.
- [24] T. Leinster (2004): *Higher operads, higher categories*. *London Mathematical Society Lecture Note Series* 298, Cambridge University Press, doi:10.1017/CBO9780511525896.
- [25] P. B. Levy (2003): *Call-By-Push-Value: A Functional/Imperative Synthesis*. Springer Netherlands, doi:10.1007/978-94-007-0954-6.

- [26] P. B. Levy, J. Power & H. Thielecke (2003): *Modelling environments in call-by-value programming languages*. *Information and Computation* 185(2), pp. 182–210, doi:10.1016/s0890-5401(03)00088-9.
- [27] S. Mac Lane & R. Paré (1985): *Coherence for bicategories and indexed categories*. *Journal of Pure and Applied Algebra* 37, pp. 59 – 80, doi:10.1016/0022-4049(85)90087-8.
- [28] D. McDermott & T. Uustalu (2022): *Flexibly Graded Monads and Graded Algebras*. In: *Lecture Notes in Computer Science*, Springer International Publishing, pp. 102–128, doi:10.1007/978-3-031-16912-0_4.
- [29] D. McDermott & T. Uustalu (2022): *What Makes a Strong Monad?* *Electronic Proceedings in Theoretical Computer Science* 360, pp. 113–133, doi:10.4204/eptcs.360.6.
- [30] P.-A. Melliès (2012): *Parametric monads and enriched adjunctions*. Available at <https://www.irif.fr/~mellies/tensorial-logic/8-parametric-monads-and-enriched-adjunctions.pdf>.
- [31] P.-A. Melliès (2021): *Asynchronous Template Games and the Gray Tensor Product of 2-Categories*. In: *36th Annual ACM/IEEE Symposium on Logic in Computer Science (LICS)*, doi:10.1109/lics52264.2021.9470758.
- [32] E. Moggi (1989): *Computational lambda-calculus and monads*. In: *Proceedings, Fourth Annual Symposium on Logic in Computer Science*, IEEE Comput. Soc. Press, doi:10.1109/lics.1989.39155.
- [33] E. Moggi (1991): *Notions of computation and monads*. *Information and Computation* 93(1), pp. 55–92, doi:10.1016/0890-5401(91)90052-4.
- [34] F. Olimpieri (2021): *Intersection Type Distributors*. In: *36th Annual ACM/IEEE Symposium on Logic in Computer Science (LICS)*, doi:10.1109/lics52264.2021.9470617.
- [35] H. Paquet & P. Saville (2023): *Strong pseudomonads and premonoidal bicategories*. arXiv:2304.11014.
- [36] J. Power (2002): *Premonoidal categories as categories with algebraic structure*. *Theoretical Computer Science* 278(1-2), pp. 303–321, doi:10.1016/s0304-3975(00)00340-6.
- [37] J. Power & E. Robinson (1997): *Premonoidal categories and notions of computation*. *Mathematical Structures in Computer Science* 7(5), pp. 453–468, doi:10.1017/s0960129597002375.
- [38] J. Power & H. Thielecke (1997): *Environments, continuation semantics and indexed categories*. In: *Lecture Notes in Computer Science*, Springer Berlin Heidelberg, pp. 391–414, doi:10.1007/bfb0014560.
- [39] M. Román (2022): *Promonads and String Diagrams for Effectful Categories*. CoRR abs/2205.07664, doi:10.48550/arXiv.2205.07664. arXiv:2205.07664.
- [40] C. J. Schommer-Pries (2009): *The Classification of Two-Dimensional Extended Topological Field Theories*. Ph.D. thesis, University of California. Available at <https://arxiv.org/pdf/1112.1000.pdf>.
- [41] R. A. G. Seely (1987): *Modelling Computations: A 2-Categorical Framework*. In: *2nd Annual IEEE Symp. on Logic in Computer Science (LICS)*.
- [42] A. Slattery (2023): *Pseudocommutativity and Lax Idempotency for Relative Pseudomonads*. arXiv:2304.14788.
- [43] A. L. Smirnov (2008): *Graded monads and rings of polynomials*. *Journal of Mathematical Sciences* 151(3), pp. 3032–3051, doi:10.1007/s10958-008-9013-7.
- [44] S. Staton (2017): *Commutative Semantics for Probabilistic Programming*. In: *Programming Languages and Systems*, Springer Berlin Heidelberg, pp. 855–879, doi:10.1007/978-3-662-54434-1_32.
- [45] M. Stay (2016): *Compact Closed Bicategories*. *Theories and Applications of Categories* 31(26), pp. 755–798. Available at <http://www.tac.mta.ca/tac/volumes/31/26/31-26.pdf>.
- [46] M. Tanaka (2005): *Pseudo-Distributive Laws and a Unified Framework for Variable Binding*. Ph.D. thesis, University of Edinburgh. Available at <https://www.lfcs.inf.ed.ac.uk/reports/04/ECS-LFCS-04-438/ECS-LFCS-04-438.pdf>.
- [47] H. Thielecke (1997): *Continuation Semantics and Self-adjointness*. *Electronic Notes in Theoretical Computer Science* 6, pp. 348–364, doi:10.1016/s1571-0661(05)80149-5.
- [48] T. Tsukada, K. Asada & C.-H. L. Ong (2018): *Species, Profunctors and Taylor Expansion Weighted by SMCC*. In: *33rd Annual ACM/IEEE Symposium on Logic in Computer Science (LICS)*, doi:10.1145/3209108.3209157.

[49] L. Wester Hansen & M. Shulman (2019): *Constructing symmetric monoidal bicategories functorially*. arXiv:1910.09240.

A Missing coherence axioms for Definition 22

We complete the list of coherence equations for Definition 22. In the diagrams that follow, we consider $b : B \rightarrow B'$ and $c : C \rightarrow C'$ in \mathcal{B} and, for $f : A \rightarrow A'$ and $g : B \rightarrow B'$ in \mathcal{V} , we write v for the composite $Jf \triangleleft g \xrightarrow{\zeta} J(f \otimes g) \xrightarrow{\theta} f \triangleright Jg$. In Theorem 23, κ represents the pseudonaturality of the associator α in its middle argument, and these axioms enforce the appropriate modification conditions (c.f. Figure 3).

The figure displays six commutative diagrams arranged in a 3x2 grid, illustrating coherence axioms for Definition 22. Each diagram shows a complex network of nodes and arrows representing objects and morphisms in a bicategory. The nodes are arranged in a roughly triangular or rectangular pattern. The arrows are labeled with various symbols: λ , α , κ , v , ρ , τ , p , q , and their overlined or tilded versions. The diagrams are connected by an equals sign, indicating that the two sides of the equation represent the same morphism. The top row shows diagrams involving λ and α . The middle row shows diagrams involving α and κ . The bottom row shows diagrams involving α and κ . The diagrams are shaded in light blue and light red to highlight different parts of the coherence.

B Proofs for Section 4

B.1 From Freyd action to Freyd bicategory

Fix a Freyd action $(\triangleright, \theta, \triangleleft, \zeta, \kappa)$ over $J : \mathcal{V} \rightarrow \mathcal{B}$. We construct a Freyd bicategory with the same underlying pseudofunctor. For the unit of the premonoidal structure we take the unit I for \mathcal{V} . Next define $A \times (-) := A \triangleright (-)$ and $(-) \times B := (-) \triangleleft B$. The icons θ and ζ for the Freyd action then determine the required icons component-wise:

$$A \times J(-) = A \triangleright (-) \xrightarrow{\theta_{A,-}} J(A \otimes -) \quad , \quad J(-) \times B = J(-) \triangleleft B \xrightarrow{\zeta_{-,B}} J(- \otimes B).$$

The left- and right unitors are given by $\tilde{\lambda}^\triangleright : IA \rightarrow A$ and $\tilde{\lambda}^\triangleleft : AI \rightarrow A$ respectively, and the associator by $J(\alpha)$ with 2-cell components given by the witnessing 2-cells for $\tilde{\alpha}^\triangleright$, κ , and $\tilde{\alpha}^\triangleleft$. The compatibility laws of a Freyd action immediately give the compatibility laws of a Freyd bicategory. Similarly, the structural modifications are wholly determined by the definition of a Freyd bicategory: for example, the pentagonator p in \mathcal{B} is $J(p)$ composed with θ and ζ as in Definition 16. The axioms of a premonoidal bicategory are then checked using the compatibility laws and the corresponding axioms in \mathcal{V} .

It remains to show that the 2-cell components of θ and ζ are central and that J factors through the centre. The former is a short direct calculation. For the latter, for $f : X \rightarrow X'$ in \mathcal{V} and $a : A \rightarrow A'$ in \mathcal{B} we define lc_a^f using θ, ζ and the interchange laws for the pseudofunctors underlying the actions as in the diagram to the right; rc_a^f is similar. We write v for the composite $Jf \triangleleft g \xrightarrow{\zeta} J(f \otimes g) \xrightarrow{\theta} f \triangleright Jg$.

Thus, we define $J'(f) := (f, lc^{Jf}, rc^{Jf})$. For any 2-cell $\sigma : f \Rightarrow f'$ in \mathcal{V} , we get that $J(\sigma)$ is natural by naturality of all the data defining lc^{Jf} and rc^{Jf} . Finally, one shows that the unit and compositor for J are central using the identity and composition laws of the icons θ and ζ .

$$lc_a^{Jf} := \begin{array}{ccc} & J(f) \triangleleft A & \\ & \xrightarrow{v} & \\ XA & \xrightarrow{f \triangleright A} & X'A \\ \downarrow X \triangleright a & \cong & \downarrow X' \triangleright a \\ & f \triangleright A' & \\ XA' & \xrightarrow{v} & X'A' \\ & J(f) \triangleleft A' & \end{array}$$

In summary, we have the following:

Proposition 24. *Every Freyd action with underlying pseudofunctor $J : \mathcal{V} \rightarrow \mathcal{B}$ determines a Freyd bicategory with the same underlying pseudofunctor.*

B.2 From Freyd bicategory to Freyd action

Let $\mathcal{F} = (\mathcal{V} \xrightarrow{J} \mathcal{B})$ be a Freyd bicategory. First we shall show how to construct a left action $\triangleright : \mathcal{V} \times \mathcal{B} \rightarrow \mathcal{B}$; the right action is constructed similarly. Thereafter we shall show how to construct the rest of the data for a Freyd action.

From Freyd bicategory to a left action. We get a left action $\triangleright : \mathcal{V} \times \mathcal{B} \rightarrow \mathcal{B}$ as follows. On objects, we set $X \triangleright B := X \otimes B$. The action on 1-cells is $f \triangleright b := (XB \xrightarrow{J(f) \times B} X'B \xrightarrow{X' \times b} X'B')$ with the evident action on 2-cells. The unitor is constructed from the unitors for the premonoidal structure, but the compositor relies on centrality. We define $\phi_{x,b}$ as on the right, where we write just \cong for the compositors.

$$\begin{array}{ccccc} XB & & & & \\ & \searrow^{J(f') \times B} & & & \\ & \cong & & & \\ X'B & \xrightarrow{J(f') \times B} & X''B & & \\ X' \times b \downarrow & & lc_b^{Jf'} \downarrow & & X'' \times (b'b) \\ X'B' & \xrightarrow{J(f') \times B'} & X''B' & \xrightarrow{X'' \times b} & X''B'' \end{array}$$

Next note that $X \triangleright b = (X \times b) \circ (JId_X \times B)$ so the unitor also gives a canonical structural isomorphism $(X \triangleright b) \cong (X \times b)$ yielding an icon $(X \triangleright -) \Rightarrow (X \times -)$. So we may define the unitor to be the composite $\tilde{\lambda} := (I \triangleright -) \xrightarrow{\cong} (I \times -) \xrightarrow{\lambda} id$. For the associator, we take the 1-cell components to be as for the premonoidal structure in \mathcal{B} , so that $\tilde{\alpha}_{X,Y,C} := \alpha_{X,Y,C}$, and define the 2-cell components using θ, ζ , and the associator for the premonoidal structure:

$$\tilde{\alpha}_{f,g,c} := \begin{array}{ccccc} (XY)C & \xrightarrow{J(f \otimes g) \times C} & (X'Y')C & \xrightarrow{(X'Y') \times a} & (X'Y')C' \\ \downarrow \alpha & \searrow^{\zeta C} & \cong & \nearrow^{\theta C} & \downarrow \alpha \\ & (J(f)Y)C & (X'Y)C & \xrightarrow{(XJ(g))C} & \\ & \downarrow \bar{\alpha}_{Jf,Y,C} & \downarrow \bar{\alpha}_{X',Jg,C} & & \\ X(YC) & \xrightarrow{J(f) \times (YC)} & X'(YC) & \xrightarrow{X' \times (J(g) \times C)} & X'(Y'C) & \xrightarrow{X' \times (Y' \times a)} & X'(Y'C') \end{array}$$

The compatibility laws on $\widetilde{\lambda}$ and $\widetilde{\alpha}$ hold by the corresponding compatibility laws of a Freyd bicategory. Turning now to the structural modifications, because the structural transformations agree with those of \mathcal{B} on 1-cells, we take the corresponding modifications for the premonoidal structure. Showing these are indeed modifications relies on the condition that $lc_{Jg}^{Jf} = (rc_{Jf}^{Jg})^{-1}$. Consider the case of \widetilde{m} . As 2-cells, $\widetilde{m}_{A,B} = m_{A,B}$ but \widetilde{m} is required to be a modification in two arguments, while the axioms of a premonoidal bicategory make $m_{A,B}$ a modification in each argument separately: in one argument, using rc^λ , and in the other argument using lc^ρ . Unpacking the equations for showing \widetilde{m} is a modification at maps $a : A \rightarrow A'$ and $x : X \rightarrow X'$, we get an instance of lc_λ^{Ja} arising from the compositor for \triangleright . To apply the modification law for m , therefore, we first need to pass through the equality $lc_\lambda^{Ja} = lc_{J\lambda}^{Ja} = (rc_{J\lambda}^{J\lambda})^{-1}$.

The axioms of an action hold immediately from the axioms of a premonoidal bicategory. The proof for the right action case is analogous, except one sets $a \triangleleft g := (AY \xrightarrow{a \times Y} A'Y \xrightarrow{A' \times Jg} A'Y')$ and defines the compositor using right centrality. In summary, therefore, we have the following.

Proposition 25. *Every Freyd bicategory $(\mathcal{V} \xrightarrow{J} \mathcal{B})$ determines a left action $\triangleright : \mathcal{V} \times \mathcal{B} \rightarrow \mathcal{B}$ and a right action $\triangleleft : \mathcal{B} \times \mathcal{V} \rightarrow \mathcal{V}$.*

From Freyd bicategory to Freyd action. It remains to show the actions just constructed extend the canonical action of \mathcal{V} on itself, and show they are compatible. First we define icons θ' and ζ' by noting that $f \triangleright J(g) = (X' \times J(g)) \circ (J(f) \times Y) = J(f) \triangleleft g$ so that we can set $\theta'_{f,g}$ and $\zeta'_{f,g}$ both to be the composite diagram on the right. In particular, $\theta'_{f,Y}$ and $\zeta'_{X,g}$ are just θ_f and ζ_g , respectively, composed with structural isomorphisms.

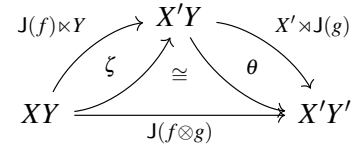

Now we define κ . On 1-cells we take just α , but on 2-cells we take a definition similar to the proof of naturality in the 1-dimensional case: for $f : X \rightarrow X'$ and $h : Z \rightarrow Z'$ in \mathcal{V} and $b : B \rightarrow B'$ in \mathcal{B} we take:

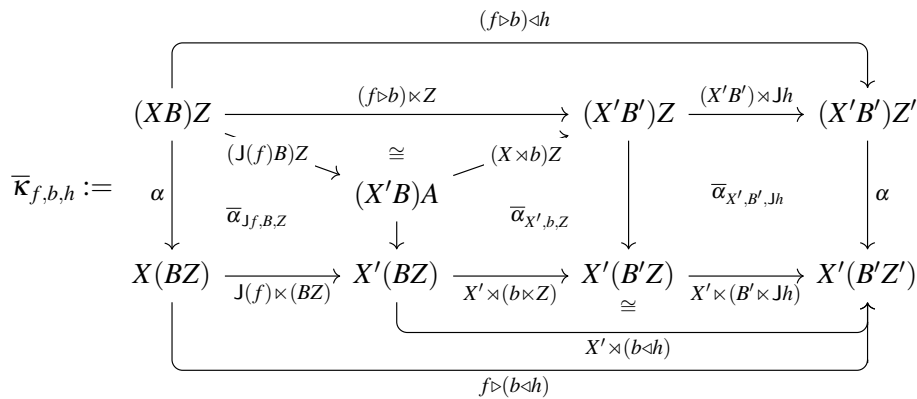

The rest of the equations to check for the Freyd action are proven by applying the various compatibility laws to massage the statement into the corresponding axiom given by the definition of a Freyd bicategory. This completes the proof of the following.

Proposition 26. *Every Freyd bicategory $(\mathcal{V} \xrightarrow{J} \mathcal{B})$ determines a Freyd action with the same underlying pseudofunctor.*

B.3 The correspondence theorem

Theorem 23. For any monoidal bicategory $(\mathcal{V}, \otimes, I)$, bicategory \mathcal{B} , and identity-on-objects pseudofunctor $J : \mathcal{V} \rightarrow \mathcal{B}$, the categories $\mathbf{FreydAct}(J)$ and $\mathbf{FreydBicat}(J)$ are equivalent.

Proof. We define functors $F : \mathbf{FreydAct} \rightleftarrows \mathbf{FreydBicat} : G$ given on objects by the constructions in Proposition 24 and Proposition 26 respectively. So suppose (ϑ, χ) is a map in $\mathbf{FreydAct}$. Then $F(\vartheta, \chi) := (F\vartheta, F\chi)$ is defined by taking

$$(F\vartheta)_f^A := ((A \rtimes f) = (\text{Id}_A \triangleright f) \xrightarrow{\vartheta_{\text{Id}_A, f}} (\text{Id}_A \triangleright' f) = (A \rtimes' f))$$

$$(F\chi)_f^A := ((f \rtimes A) = (f \triangleleft \text{Id}_A) \xrightarrow{\chi_{f, \text{Id}_A}} (f \triangleleft' \text{Id}_A) = (f \rtimes A))$$

Conversely, given a map (ϑ, χ) in $\mathbf{FreydBicat}$ we define $G(\vartheta, \chi) := (G\vartheta, G\chi)$ to be

$$(G\vartheta)_{f,b} := \begin{array}{ccc} & f \triangleright b & \\ \begin{array}{c} \boxed{ \begin{array}{ccc} \begin{array}{c} \text{J}f \rtimes B \\ \downarrow \chi_{\text{J}f}^B \\ \text{J}f \rtimes' B \end{array} & \xrightarrow{\cong} & \begin{array}{c} X' \rtimes b \\ \downarrow \vartheta_b^{X'} \\ X' \rtimes' b \end{array} \\ \text{X}B & \xrightarrow{\quad} & \text{X}'B' \\ \text{X}'B & \xrightarrow{\quad} & \text{X}'B' \end{array} \end{array} \\ & f \triangleright' b & \end{array}, \quad (G\chi)_{a,g} := \begin{array}{ccc} & a \triangleleft g & \\ \begin{array}{c} \boxed{ \begin{array}{ccc} \begin{array}{c} a \rtimes X \\ \downarrow \chi_a^X \\ a \rtimes' X \end{array} & \xrightarrow{\cong} & \begin{array}{c} A' \rtimes \text{J}g \\ \downarrow \vartheta_{\text{J}g}^{A'} \\ A' \rtimes' \text{J}g \end{array} \\ \text{A}X & \xrightarrow{\quad} & \text{A}'X' \\ \text{A}'X & \xrightarrow{\quad} & \text{A}'X' \end{array} \end{array} \\ & a \triangleleft' g & \end{array}$$

One shows both F and G are well-defined by a long calculation using the compatibility properties on one side to show the required compatibility condition on the other side.

We now show that $GF \cong \text{id}$ and $FG \cong \text{id}$. Given an action $\mathcal{A} := (\triangleright, \theta, \triangleleft, \zeta, \kappa)$, the composite $GF(\mathcal{A})$ has left action \triangleright' given by $f \triangleright' b = (\text{Id}_{X'} \triangleright b) \circ (\text{J}f \triangleleft \text{Id}_B)$ and right action \triangleleft' given by $a \triangleleft' g = (\text{Id}_{A'} \triangleright \text{J}g) \circ (a \triangleleft \text{Id}_Y)$ so we get an obvious choice of icons $\triangleright' \Rightarrow \triangleright$ and $\triangleleft' \Rightarrow \triangleleft$ given by

$$\begin{array}{ccc} \begin{array}{ccc} \begin{array}{c} \text{J}f \triangleleft \text{Id}_B \\ \zeta \\ \text{X}B \end{array} & \xrightarrow{\quad} & \begin{array}{c} \text{X}'B \\ \text{J}f \triangleleft B \\ \theta \end{array} \\ \text{X}B & \xrightarrow{\quad} & \text{X}'B \\ \text{X}'B & \xrightarrow{\quad} & \text{X}'B' \\ \text{X}'B & \xrightarrow{\quad} & \text{X}'B' \end{array} & \xrightarrow{\quad} & \begin{array}{ccc} \begin{array}{c} \text{Id}_{X'} \triangleright b \\ \theta \\ \text{X}'B' \end{array} \\ \text{X}'B' & \xrightarrow{\quad} & \text{X}'B' \\ \text{X}'B' & \xrightarrow{\quad} & \text{X}'B' \end{array} \\ & & \cong \\ & & \text{X}'B' \end{array} \quad \begin{array}{ccc} \begin{array}{ccc} \begin{array}{c} \text{Id}_{A'} \triangleright \text{J}g \\ \theta \\ \text{A}Y \end{array} & \xrightarrow{\quad} & \begin{array}{c} \text{A}'Y \\ \text{Id}_{A'} \triangleright \text{J}g \\ \zeta \end{array} \\ \text{A}Y & \xrightarrow{\quad} & \text{A}'Y \\ \text{A}'Y & \xrightarrow{\quad} & \text{A}'Y' \\ \text{A}'Y & \xrightarrow{\quad} & \text{A}'Y' \end{array} & \xrightarrow{\quad} & \begin{array}{ccc} \begin{array}{c} \text{Id}_{A'} \triangleright g \\ \theta \\ \text{A}'Y' \end{array} \\ \text{A}'Y' & \xrightarrow{\quad} & \text{A}'Y' \\ \text{A}'Y' & \xrightarrow{\quad} & \text{A}'Y' \end{array} \\ & & \cong \\ & & \text{A}'Y' \end{array} \\ & & \text{A}'Y' \end{array}$$

These commute with all the data because θ and ζ do, and forms a natural isomorphism $GF(\mathcal{A}) \cong \mathcal{A}$ because morphisms in $\mathbf{FreydAct}$ commute with the icons of the actions.

Finally, to show that $FG \cong \text{id}$ consider a Freyd bicategory $\mathcal{F} := (\rtimes, \theta, \rtimes, \zeta)$. Then $FG(\mathcal{F})$ has $a \rtimes' B := (X' \rtimes \text{J} \text{Id}_B) \circ (a \rtimes B)$ and $A \rtimes' b := (A \rtimes b) \circ (\text{J} \text{Id}_A \rtimes B)$ so we have evident structural isomorphisms $(a \rtimes' B) \cong (a \rtimes B)$ and $(A \rtimes' b) \cong (A \rtimes b)$. These commute with all the data and define a natural isomorphism $FG(\mathcal{F}) \cong \mathcal{F}$ by straightforward applications of coherence. \square