

A First Look at 5G Core Deployments on Public Cloud: Performance Evaluation of Control and User Planes

Tolga O. Atalay¹, Dragoslav Stojadinovic², Alireza Famili¹, Angelos Stavrou^{1,2}, and Haining Wang¹

¹Department of Electrical and Computer Engineering, Virginia Tech, USA

²Kryptowire Labs, Arlington, VA, USA

Abstract

The Fifth Generation (5G) mobile core network is designed as a set of Virtual Network Functions (VNFs) hosted on Commercial-Off-the-Shelf (COTS) hardware. This creates a growing demand for general-purpose compute resources as 5G deployments continue to expand. Given their elastic infrastructure, cloud services such as Amazon Web Services (AWS) are attractive platforms to address this need. Therefore, it is crucial to understand the control and user plane Quality of Service (QoS) performance associated with deploying the 5G core on top of a public cloud. To account for both software and communication costs, we build a 5G testbed using open-source components spanning multiple locations within AWS. We present an operational breakdown of the performance overhead for various 5G use cases using different core deployment strategies. Our results indicate that moving specific VNFs into edge regions reduces the latency overhead for key 5G operations. Furthermore, we instantiated multiple user plane connections between availability zones and edge regions with different traffic loads. We observed that the deterioration of connection quality varies depending on traffic loads and is use case specific. Ultimately, our findings provide new insights for Mobile Virtual Network Operators (MVNOs) for optimal placements of their 5G core functions.

1 Introduction

The deployment of next-generation mobile networks is gaining momentum. Compared with legacy Long Term Evolution (LTE), the Fifth Generation (5G) networks have been designed to accommodate a wide range of industry verticals with different Quality of Service (QoS) demands. Thus, the delivery of services in 5G takes place over logically isolated segments called “network slices.” For the flexible deployment of network slices, 5G leverages Network Functions Virtualization (NFV) as a building block for its core network [31, 42].

The adoption of NFV for facilitating 5G deployments creates an increasing demand for computing infrastructure

that can scale efficiently. To fill this vacuum, cloud service providers such as Amazon Web Services (AWS), Google Cloud Platform (GCP), and Microsoft Azure have been starting to tailor Infrastructure-as-a-Service (IaaS) offerings for Mobile Virtual Network Operators (MVNOs). Proof-of-concept trials are being conducted by Swisscom and Ericsson to deploy the 5G core on top of AWS [18]. Furthermore, Deutsche Telekom [41] and Telefonica [40] have entered into partnerships with AWS and Azure to explore a cloud-based 5G core network. Given these developments, the objective of this paper is to understand the latency overhead and throughput bottlenecks associated with 5G deployments on the AWS public cloud. We conduct a series of experiments with alternative edge location options in seven countries, across eight AWS regions.

AWS edge locations denoted as Local Zones (LZs) [14] and Wavelength Zones (WZs) [13] are well-suited for hosting Ultra Reliable Low Latency (URLLC) applications to enhance user plane QoS. In addition to user applications, they can be leveraged for deploying 5G core Virtual Network Functions (VNFs) to minimize the control plane latency to the Radio Access Network (RAN). On the one hand, user plane latency and throughput are essential for providing a good Quality of Experience (QoE). On the other hand, control plane latency is crucial in maintaining reliability for Mission Critical Services (MCSs) such as healthcare, energy, and robotics [17].

The significance of prioritizing among these operational planes is illustrated in Figure 1a. Two network slices are depicted over a tentative 5G core deployment in a hybrid Availability Zone (AZ) [16], LZ, and WZ layout. For the Mission Critical slice 1, it is more important to manage the network slice setup and transfer times [3] of the clients to maintain high reliability. Therefore, slice 1 is stretched out over an LZ-AZ connection, where the LZ-AZ latency is lower than the WZ-AZ alternative. On the other hand, for better QoS in latency-sensitive applications such as enhanced Mobile Broadband (eMBB) and URLLC cases, the data session VNFs are deployed closer to the 5G edge in WZs. Therefore, slice 2 is deployed over a WZ-AZ connection.

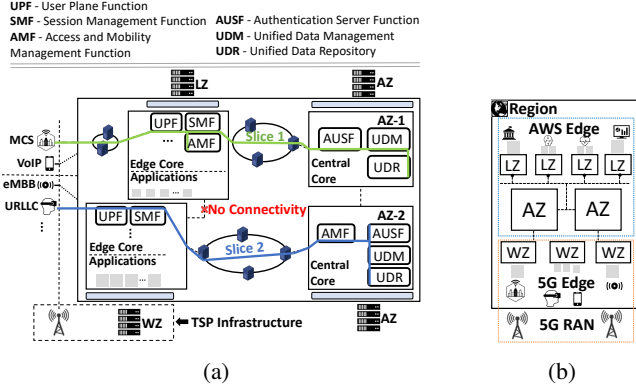

Figure 1: (a) Breakdown of an AWS parent region with different infrastructure zones; (b) QoS-sensitive 5G deployment on top of AWS across AZs, LZs, and WZs

The advent of moving 5G deployments into a public cloud raises performance concerns at both the control and user planes. Mission critical applications with dense signaling require low latency in control plane handling [3]. On the other hand, applications such as Augmented- and Virtual- Reality (AR/VR) require low latency in the user plane.

To the best of our knowledge, this work is the first to shed light on large-scale 5G deployments over a public cloud at a global scale. We quantify the control plane latency overhead of critical 5G tasks and user plane bottlenecks in hybrid AZ, LZ, and WZ deployments across multiple locations within AWS. Leveraging our testbed, operators can make informed decisions regarding their 5G deployments to determine favorable placements of control and user plane entities for different use cases. Our contributions are summarized below.

- For finer-grained control over experimentation, we use the open-source OpenAirInterface [29] (OAI) 5G core and the gNBSIM [35] RAN. This allows us to manage 5G deployments without relying on any proprietary solution. We create multiple self-managed Kubernetes clusters on top of AWS Elastic Compute Cloud (EC2) instances spanning multiple zones. These clusters are used to instantiate mass end-to-end connections between emulated users and Data Network Nodes (DNNs) that we control. To perform analysis on a global scale, we conduct experiments in eight different parent regions for 18 different edge zones.
- We conduct a measurement campaign to understand the bottlenecks within the AWS edge computing networks. This includes daily benchmarks on latency, throughput, and packet loss. Our measurements can be used as a reference point for future studies examining changes in the AWS edge computing architecture.
- To evaluate the 5G control plane, we build a state-of-the-art instrumentation environment using Jaeger [23] and OpenTelemetry [30]. Integrated into this ecosystem, our custom

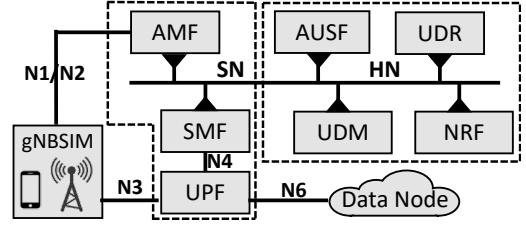

Figure 2: OAI 5G core deployment

monitoring Side-car Proxy (SCP) sits adjacent to each VNF, collecting telemetry data. Through this pipeline, we are able to trace the HTTP transactions between individual Representational State Transfer (REST) APIs of the 5G core. In our evaluations, we derive and experiment with multiple control plane strategies pertaining to real-life use cases (e.g., MCS, URLLC). Each strategy is associated with a placement pattern, where VNFs are shuffled between an edge zone and an AZ. Comparing the overhead of different strategies, we provide insight into what the control plane latency implications are for cloud-based 5G deployments.

- To understand user plane bottlenecks in different regions, traffic loads of real-life 5G use cases are recorded. Then, end-to-end user connections are created across edge zones and AZs. The captured downlink and uplink traffic is replayed through the 5G user plane to create traffic on top of AWS. Through these experiments, we measure the bandwidth bottlenecks between edge zones and AZs. Our goal is to provide operators with guidance regarding 5G user plane entity placement in the cloud.

2 Background

2.1 5G Core Overview

The 5G core VNFs communicate with one another using standardized Representational State Transfer (REST) APIs named according to the Common API Framework (CAPIF) [1] described by the 3rd Generation Partnership Project (3GPP).

The logical architecture of our deployment is presented in Figure 2. The VNFs are divided into the Home Network (HN) and Serving Network (SN) components. As a critical entity of the 5G core, the Access and Mobility Management Function (AMF) typically resides in the SN, acting as the communication highway among the remaining VNFs, the RAN, and the User Equipment (UE). AMF receives authentication credentials from the Authentication Server Function (AUSF) in the HN. Along with the Unified Data Management (UDM) and Unified Data Repository (UDR), AUSF takes part in the 5G Authentication and Key Agreement (AKA) [6]. In the SN, the Session Management Function (SMF) and the User Plane Function (UPF) are respectively the control and user plane anchors for the UE data session. The UPF tunnels the user traffic

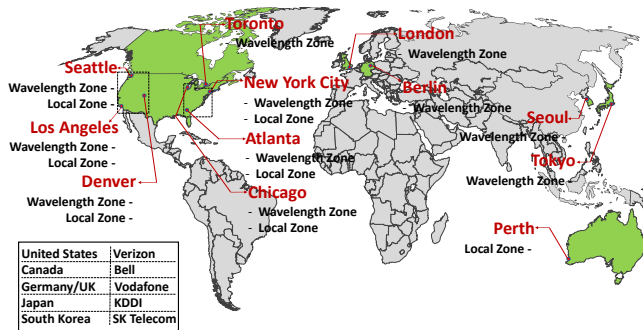

Figure 3: The Local and Wavelength zones used across the world for experimentation

toward a Data Network Node (DNN) container, which represents the application servers in real life. The initial discovery and communication between these VNFs are facilitated by the Network Functions Repository Function (NRF) acting as a metadata database. Last but not least, connecting to this network is the gNBSIM entity, which sends both gNB and UE signals to the core from the same sandbox encapsulation.

2.2 AWS Local and Wavelength Zones

AWS infrastructure is divided into geographical segments denoted as parent regions. As illustrated in Figure 1b, each region consists of multiple AZs and, for chosen regions, finer-grained LZs [14]. While an AZ is a generic deployment zone that exists for reliability through redundancy, LZs exist to enable low-latency applications at the edge of the AWS network. In addition to AZs and LZs, AWS has introduced the WZ [13]. The WZs deliver an integrated cloud environment capable of supporting URLLC 5G applications by providing AWS features at the 5G network edge. Compared to LZs, this is achieved by deploying specific applications directly on top of the Telecommunication Service Provider (TSP) infrastructure, in close proximity to the 5G RAN. However, due to this displacement, AZ-WZ connections are subject to a higher latency than their AZ-LZ counterparts.

3 Measurement Methodology

In this section, we first present the global locations selected for experimentation. Next, the instrumentation pipeline for HTTP transaction tracing is introduced. Subsequently, we delve into the VNF placement strategies related to actual Slice Service Types (SSTs) [2] employed in control plane assessments. Following that, the user plane measurement methodology is described using the selected traffic patterns. Finally, we present our experimentation environment within AWS.

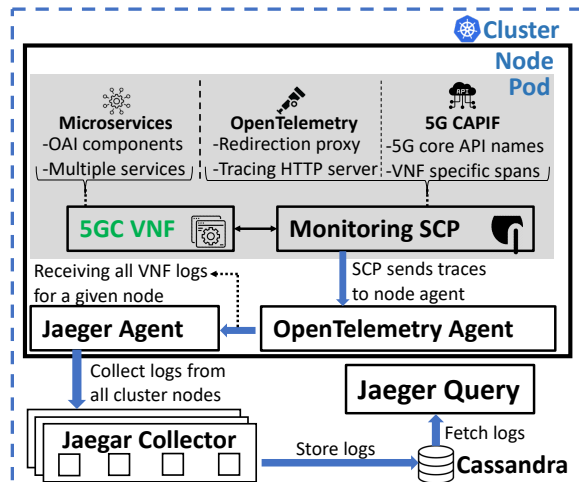

Figure 4: Overview of the monitoring framework for 5G core transaction tracing

3.1 Global Locations

To represent a wide range of regions, we have selected edge zones corresponding to different locations within the AWS infrastructure. The specific cities and their WZ/LZ support are illustrated in Figure 3.

To compare LZ and WZ edge locations within a single city, we selected six cities from the United States: three from the US-East (Northern Virginia) region and three from the US-West (Oregon) region. The remaining locations offer only one of the two edge zone variants, making it difficult to conduct a comparison. Nevertheless, we still evaluate the individual edge performance of LZ/WZ deployments across different locations in Perth, Tokyo, Seoul, London, and Berlin.

3.2 Monitoring Framework

An instrumentation pipeline is constructed using Jaeger [23] and OpenTelemetry [30] as illustrated in Figure 4. Each building block is shown within its respective deployment hierarchy in the Kubernetes experimentation environment, which can occur at a pod-, node- or cluster-level.

To avoid modifications to the source code of the 5G core VNFs for gathering telemetry information, we design a custom Side Car Proxy (SCP) [28] using OpenTelemetry for intercepting and redirecting the HTTP messages between the 5G pods. This is denoted as indirect communication and has been standardized by 3GPP in Release 16 as a viable VNF-to-VNF interaction method [2].

The SCP functions as a two-way redirection proxy that forwards messages to and from the 5G application residing in the same pod. When a message enters the pod network sandbox, it is processed at the OpenTelemetry HTTP server within the SCP. As the HTTP request is forwarded to its destination, a span is created for the given transaction based on

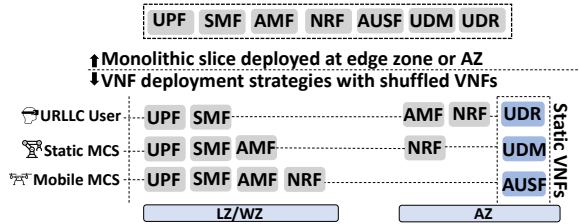

Figure 5: 5G core VNF deployment strategies on AWS infrastructure for different use cases

the 5G CAPIF path in the URL. This allows us to distinguish between individual 5G core control plane messages and identify sender/receiver VNFs. Once the spans are created, the SCP sends them to the node-level OpenTelemetry agent (see Appendix A for details on message interception).

The OpenTelemetry agent functions as the initial consolidation point for the gathered logs. After receiving telemetry from individual SCPs, it forwards the information to the respective Jaeger agent deployed alongside it. A central Jaeger collector receives logs from all the Jaeger agents in the cluster and stores them in a Cassandra database as JSON files. Finally, the Jaeger query is used to fetch them from the database. Both OpenTelemetry and Jaeger agents are deployed as Daemonsets within the Kubernetes cluster, and communications with them take place over Kubernetes DNS.

3.3 VNF Deployment Strategies

We employ three hybrid placement strategies, as illustrated in Figure 5, wherein the VNFs are positioned either at the network edge or an AZ. Additionally, a monolithic network slice is used as a benchmark, where all the VNFs are grouped together in the same physical location. Since computational resources are scarcer and more expensive in edge zones, control plane VNFs are placed there only when use cases require low latency between specific control plane interactions.

For the first strategy, we consider the generic **URLLC** SST for the user plane, where only the data session VNFs (i.e., the UPF and the SMF) have been placed in edge zones. The primary goal for this deployment is to maintain high QoS in the user plane for use cases such as AR/VR and gaming. Since any added control plane latency will not deteriorate the QoE of users, the remaining VNFs are instantiated in AZs rather than edge zones.

The second strategy is where the AMF is moved into the edge alongside the UPF and SMF. This network slice configuration is suited for **static MCSs** where the clients are not moving, but there is high connection density. Specific use cases include mIoT in smart warehouses, hospitals, and government buildings. By moving the AMF to the edge zone, the session setup interaction with the SMF is minimized.

The final strategy is for **mobile MCSs** such as drones, ve-

Table 1: Traffic loads in user plane experiments

SST	Use Case	Application
eMBB	Streaming	Netflix
	Video browse	Tiktok
URLLC	Gaming	Fortnite
eMBB + URLLC	VR	Horizon Venues
VoIP	Video call	Zoom

hicular to everything (V2X) communication users, and other high mobility clients. For these devices, it is reasonable to expect a high volume of network slice transfer traffic as the target moves across different physical locations. To accommodate this behavior, new network slices might need to be instantiated to host these incoming users. Alternatively, VNFs from existing slices may need to be discovered [4] to establish the connection of the user to the new slice. To facilitate these operations with minimal overhead, the NRF is moved into the edge along with the UPF, SMF, and AMF.

3.4 User Traffic Generation

For user data, we use the pre-recorded traffic of different use cases listed in Table 1. Netflix and Tiktok are considered for the eMBB SST. For re-creating a gaming session, we record the traffic during Fortnite gameplay to represent URLLC. As a more hybrid SST example, with both eMBB and URLLC requirements, VR traffic pattern from an Oculus Quest 2 is captured during a Horizon Venues session. Finally, for Voice over IP (VoIP), a Zoom session with video is recorded. The traffic patterns of each use case are shown in Appendix D.

3.5 Experimentation Environment

For a High Availability (HA) Kubernetes cluster, the full experimental setup is depicted in Figure 6, spanning multiple EC2 instances in a hybrid cloud deployment. Three control nodes are deployed in the AZ along with six workers. Another six workers are placed in edge zones. Jaeger and OpenTelemetry agents are running on every worker, deployed as

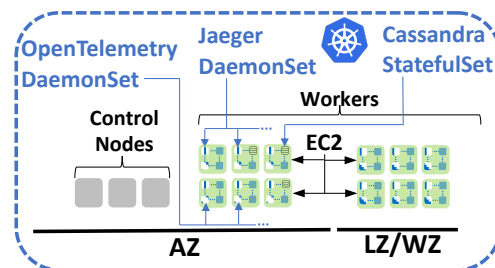

Figure 6: Complete experimentation Kubernetes cluster deployed on top of AWS with all entities illustrated

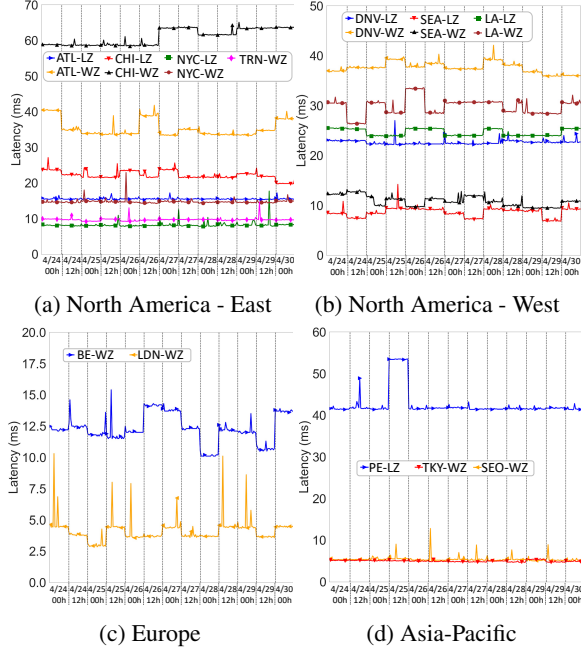

Figure 7: Latency measured over a week with 12-hour intervals between edge zones and the relevant AZ. Measurement recordings are started at the reported times according to Eastern Standard Time. (April 24-30th 2023)

DaemonSets. Finally, Cassandra is deployed as a StatefulSet for synchronization and scalability. In Appendix G, we detail the deployment process and outline key issues for anybody seeking to construct such a testbed.

4 Control Plane Results

Notable research studies have focused on increasing the reliability of cellular control plane operations [7,8]. Thus, to assess the eligibility of 5G deployments in the cloud, our first set of evaluations revolves around the operational latency induced in the control plane. In this section, we first perform extensive latency benchmarks across AZs for each edge zone. Next, we present the results that highlight the operational overhead for the chosen deployment strategies in Section 3.3.

4.1 AWS Latency Benchmarks

In order to achieve fidelity in our control plane experiments, we start by performing latency benchmarks between AZs and edge zones. To make a fair comparison across locations, we determine if selecting one AZ over another will significantly affect the connection. Our measurements (see Appendix B) show that the difference in latency to different AZs from a given edge zone is less than 1 ms. Since such latency is negligible, we use the first AZ (i.e., AZ-a) in each region during our experiments throughout the rest of the measurements.

Table 2: P50, P90, and P99 values for the weekly latency (ms) measurements conducted between AZs and edge zones

City	Zone	P50	P90	P99
Atlanta	LZ	15.5	15.7	16.7
	WZ	34.1	39.1	40.6
New York City	LZ	8.05	8.36	10.5
	WZ	14.6	14.9	16.3
Chicago	LZ	21.8	23.7	24.69
	WZ	61.6	63.7	63.9
Denver	LZ	22.5	23.0	24.4
	WZ	37.6	39.2	39.6
Seattle	LZ	8.92	9.35	10.2
	WZ	10.8	12.3	12.8
Los Angeles	LZ	24.1	25.4	25.5
	WZ	30.5	31.1	33.5
Toronto	WZ	9.67	9.84	10.5
London	WZ	3.87	4.49	8.25
Berlin	WZ	12.2	13.81	14.3
Tokyo	WZ	5.29	5.57	8.87
Seoul	WZ	4.97	5.27	5.48
Perth	LZ	41.6	42.5	53.5

While connections between edge zones and AZs do display consistent behaviors across different AZs, measurements in Internet-based studies are still prone to fluctuations. Thus, we attempt to ensure that our control plane evaluations are not significantly affected by any time-related inconsistencies. To that end, we measure the latency from each edge location to its respective AZ over a week with 12-hour intervals. Thirty iterations of “ping” with 100 samples each are averaged for the reported value. The fluctuations during the week of April 24th to April 30th, 2023 are shown in Figure 7, while the P50, P90, and P99 latency values are given in Table 2. Based on the p-values, the highest volatility is observed for the London-WZ while the remainder of the zones have relatively stable latency readings. Thus, during our 5G core HTTP transaction trace in Section 4.2, we gather ten measurements per trace which are averaged (see Appendix H). The latency fluctuations for each HTTP transaction are less than 5ms.

For four zones, the difference between the minimum and maximum latency throughout the week exceeds 5ms. In the US, only the Atlanta, Chicago, and Los Angeles WZs display such behavior. On the other hand, the LZ alternatives in the same cities have stable latency readings with a sub-2ms difference for the entire week. This goes to show that the connection between the AWS-TSP infrastructure is more prone to fluctuations than the AZ-LZ link. Another discrepancy can be seen at the noon measurement of April 25th for the Perth LZ. This is primarily due to an anomaly as this zone has a sub 1ms difference across the remainder of the intervals.

Table 3: Categorization of 5G core HTTP messages into groups based on operational significance

Category	Interaction
5G-AKA	AMF → AUSF - UE authentication
	AMF → UE - mutual authentication
	AMF → AUSF - auth. confirmation
Session Setup	AMF → NRF - SMF discovery request
	AMF → SMF - Context creation request
	SMF → AMF - N1-N2 context creation
	AMF → UE - Session resource setup
NRF Register	AMF, SMF, UPF → NRF - registration
	NRF → AMF, SMF, UPF - update

4.2 5G Measurement Results

For the first set of evaluations given in Figure 8, we analyze the total latency overhead of different 5G core deployment strategies illustrated in Figure 5. Total latency is the summation of the processing times seen at the CAPIF endpoints of individual VNFs. To simplify the comparison, we do not include the latency introduced as a result of the communication between the static VNFs in Figure 5. These are the 5G-AKA message exchanges taking place between the AUSF, UDM, and UDR. Since these will be the same across all the strategies, their contribution to the total latency is omitted. However, we still take into account the HTTP transactions between the AMF and the AUSF during 5G-AKA. This allows us to capture the resultant effect on the authentication process when the AMF is moved to the edge zones for the Static and Mobile MCS control plane strategies.

Omitting the 5G-AKA interactions between the HN VNFs, total latency in Figure 8 is obtained by adding up the delay in all the remaining message exchanges. Each message has been categorized into one of three groups in Table 3 depending on which operation they are tied to. The operations include: 5G-AKA messages taking place between the AMF and AUSF; session setup messages among the NRF, AMF, and SMF; NRF registration and update messages (detailed message flows can be found in Appendix C).

Comparing LZs and WZs in the same US cities. To analyze the performance of the North America edge locations, it is important to consider the relative geographical distances between AZs and edge zones. In Tokyo, Seoul, and London, the AZ is located within the same city as the edge zone. For the majority of US cities, this is not the case. In terms of the performance of the Atlanta and Chicago WZs, which are tied to the Northern Virginia AZ, the total overhead is relatively higher as expected. Still, for MCSs, it is unnecessary to host the 5G core VNFs on WZs because the user plane latency to the RAN will not be a primary concern. Instead, operators can opt to use the LZs in the same cities to significantly reduce the latency of critical control plane operations. Especially in

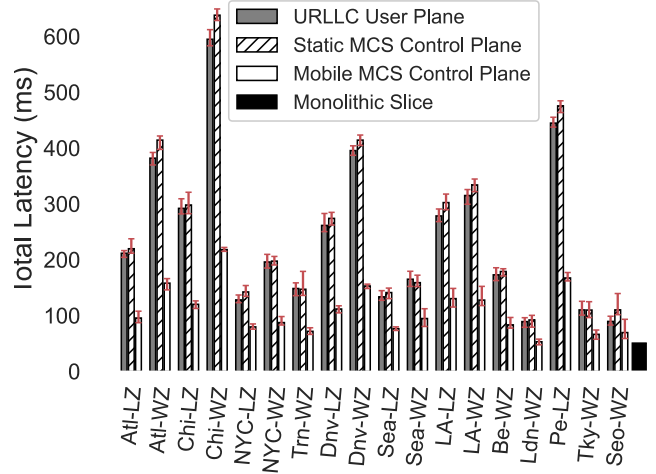

Figure 8: Total latency comparison for the different strategies across edge locations

the US-East edge locations, choosing to use an LZ rather than a WZ for MCS network slices can achieve comparable performance to EU-based edge zones. The same pattern, however, cannot be observed in the US-West edge locations. For Seattle and Los Angeles, we observe that both LZ and WZ options yield similar results. This grants operators greater flexibility in deploying network slices using the public cloud.

Deceptive Increase in Total Latency Moving from URLLC to Static MCS Strategy. As the AMF is moved into an edge zone, Figure 8 indicates that the total end-to-end session setup latency of a user slightly increases. This paints an incomplete picture because it does not specify the source of the latency for each strategy. While examining the total latency overhead provides a direct comparison across edge locations, it cannot reveal the source of the latency for each strategy. To better understand how different strategies in Figure 5 could impact operational latency, we present the operational breakdown in Figure 9. These results dissect the total latency of each strategy for edge zones according to the categorization in Table 3. This makes it possible to demonstrate how specific strategies are able to lower the latency of certain operations while increasing it for others. There are three arguments to be drawn from Figure 9.

(I) Increased delay in 5G AKA and reduced delay in session setup. The 5G AKA service chain experiences an increase in delay when switching from the URLLC user plane slice to the MCS slice. When the AMF is moved to an edge zone, the SN - HN messages between the AMF and the AUSF are subjected to higher latency. However, this does not pose a significant issue for MCS users, because 5G-AKA is a procedure that takes place during the initial registration and connection management procedure [6]. While there could be other secondary authentication operations (e.g., network slice specific authentication and authorization [5]), these can be conducted using secondary authentication servers inde-

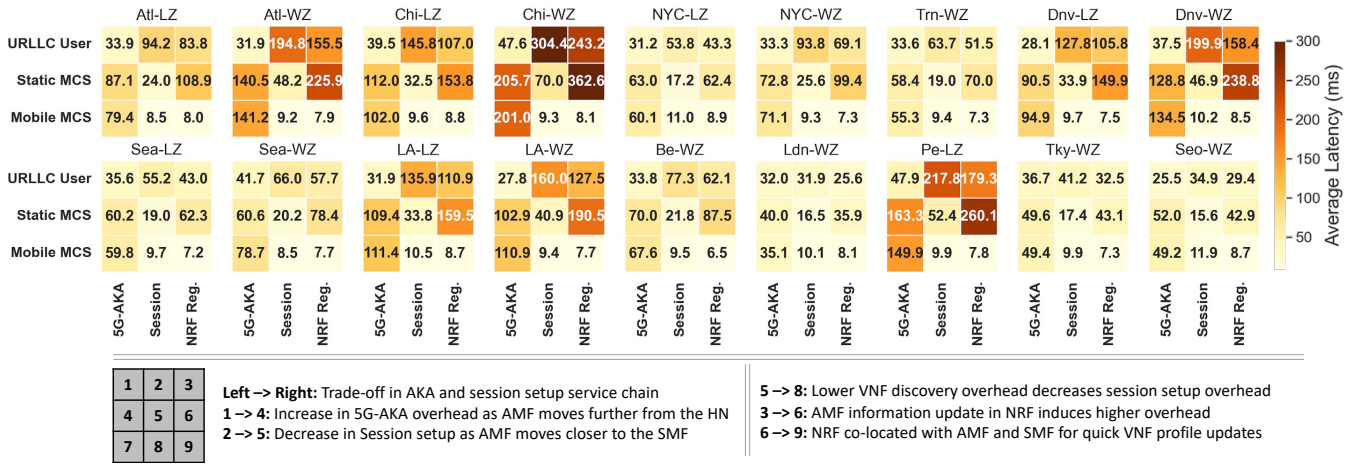

Figure 9: Operational overhead breakdown of 5G core interactions for different VNF placement strategies for all evaluated edge locations. Complete HTTP transaction measurements are given in Appendix H

pendent from the HN VNFs. On the other hand, moving the AMF next to the SMF into the edge zones also leads to a considerable drop in session setup latency. During network slice construction, both the AMF and SMF need to send a discovery request to the NRF to discover a suitable SMF and UPF [4], respectively. This leads to two HTTP transactions between the edge zone and the AZ for the Static MCS slice. However, for the users of this slice, such a discovery procedure only causes a one-time delay. A potential consumer of this type of slice can be a mIoT client. Such a client may require additional packet data unit (PDU) sessions on multiple slices to accommodate the high data volume. To that end, it can establish multiple PDU sessions on single or multiple network slices. The VNF discovery will only be prompted initially during the construction of these slices. Afterward, for an additional session setup, only the AMF-SMF interaction will take place, which has lower latency. Therefore, the static MCS use case can be well accommodated through the designated VNF placement as shown in Figure 5.

(II) Convenience of the Mobile MCS network slice. Moving the NRF into the edge zone lowers the total delay of both the session setup and registration. For clients with high mobility, this is an important advantage, as a network slice transfer can be required to properly accommodate them in case of mission criticality [32, 34]. When network slice transfer takes place, the components of the existing network slice need to communicate with the VNFs of the target slice, or a new slice needs to be constructed. Either way, the VNF discovery operation as well as fetching up-to-date metadata from the NRF becomes a time-sensitive operation. Given the sub-15ms session setup and sub-10ms NRF interaction overhead, these tasks can be achieved with reduced latency through the Mobile MCS strategy.

(III) How to make a choice between LZ and WZ? The objective of an MVNO is to deliver the optimal QoS while

managing operational overhead. Given that computational costs are higher in edge zones, MVNOs will aim to minimize the number of VNFs they relocate to the edge (see Appendix F). The operational breakdown provides a thorough comparison between WZs and LZs for cities that have both. As expected, being hosted on TSP infrastructures may have lower latency to the RAN, but it has a negative impact on the backhaul. This is especially apparent in Atlanta, Chicago, and Denver, where the latency overhead of LZs is significantly lower than that of WZs. If operators seek to prioritize the control plane latency for MCSs, they should opt for LZs rather than WZs. For Seattle, Los Angeles, and New York City edge zones, the difference between WZs and LZs remains comparatively less significant. This provides operators with higher flexibility when deploying network slices at these locations.

5 User Plane Results

5.1 AWS Throughput Benchmarks

Benchmarks are conducted over a one-week period with 12-hour intervals. We use iperf3 [22] with a single stream to evaluate TCP throughput and measure packet loss over a 1 Gbps UDP connection. The iperf3 client runs for 100 samples with 20 iterations, which are then averaged for each zone. The results are shown in Figures 10, 11.

The bi-daily averages are given in Figure 12. While with sufficient measurements the daily averages indeed reflect consistent patterns both for TCP throughputs and UDP packet losses, the variations are more apparently observed from the Cumulative Distribution Functions (CDFs) in Figures 10 and 11. Since these fluctuations are non-negligible, our measurement approach for 5G user plane evaluation, as described in Figure 13, spans over an 8-hour time period for each use case. This allows us to account for the time-related fluctua-

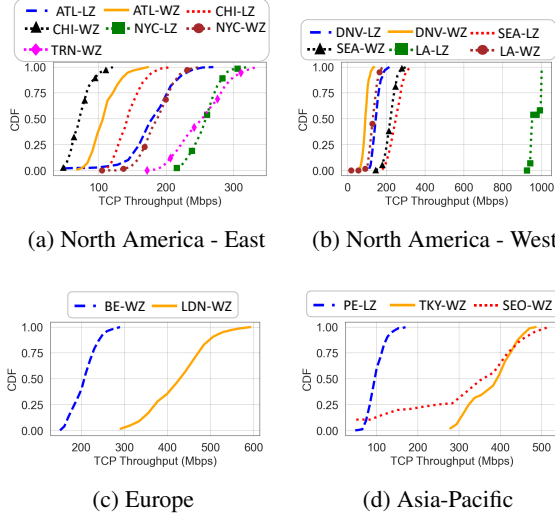

Figure 10: CDF of weekly TCP throughput measurements between AZs and edge zones for April 24-30th 2023. (Raw measurements are given in Appendix E)

tions in both TCP and UDP connections and obtain a reliable average.

WZ-LZ throughput-packet loss discrepancy. Examining the results of the packet loss benchmarks shown in Figure 12b, we notice a discrepancy in comparison with Figure 12a. The measurements in Atlanta, Chicago, and New York City have conflicting TCP throughput and UDP packet loss rate results. While throughput over TCP is higher in LZs than in WZs of these cities, packet loss rates at WZs are lower than those at LZs. TCP has built-in congestion control with retransmission to recover from packet losses and throttle the throughput. By contrast, UDP is a connectionless protocol without loss recovery mechanisms. Thus, this behavior is a clear irregularity since given the same queue, a higher packet loss rate should ultimately lead to a more throttled TCP throughput as a result of congestion control.

We corresponded with AWS to understand the underlying infrastructure and explain this behavior. The higher TCP throughput in the connection between an AZ and an LZ is due to the fact that AWS uses higher bandwidth links between AZs and LZs compared to WZs. However, this does not necessarily result in lower latency or packet loss rate. On the other hand, WZs are specifically optimized for low-latency connections to the 5G access networks, which require high reliability. To achieve this, AWS uses specialized hardware and software in WZs to prioritize UDP traffic and reduce packet losses. Therefore, if reliable connections are critical for an application, connecting to a WZ is the better option. However, if users require high bandwidth and can tolerate packet loss, connecting to a LZ provides higher TCP throughput.

MVNOs should consider these factors when selecting an edge zone for a particular application or workload. Since

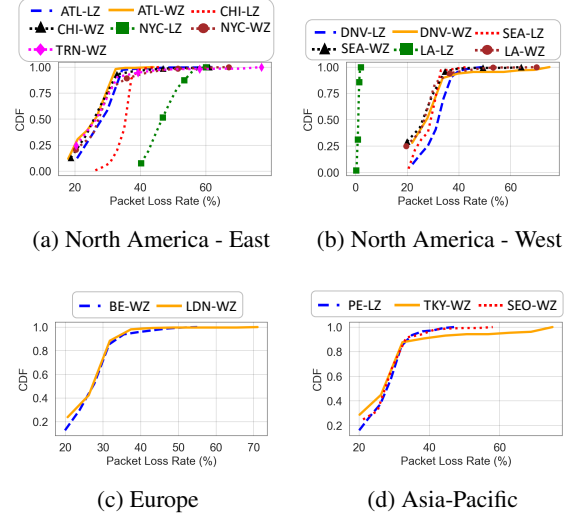

Figure 11: CDF of weekly UDP Packet Loss Rate measurements between AZs and edge zones for April 24-30th 2023. (Raw measurements are given in Appendix E)

the details of network paths or hardware are not public, it is not possible to make a definitive claim regarding this issue. Additional infrastructure customizations are itemized below that may lead to the resultant behaviors.

- **Different network paths.** A variety of techniques, such as multiple redundant paths, load balancing, and intelligent routing are employed in AWS network paths. Depending on the network conditions and load on the infrastructure, different routes may be used for TCP and UDP packets to optimize network performance.
- **QoS policies.** The network path to LZs prioritizes TCP traffic over UDP, while the opposite is true for WZs. This explains the higher TCP throughput in LZs, while also justifying a higher relative packet loss rate in LZs than WZs.
- **Edge hardware.** The TSP hardware in the WZs handles UDP traffic more efficiently than AWS LZ hardware. For example, the hardware in the New York City LZ may have lower processing power, smaller buffers, or slower interfaces than the hardware in the New York City WZ. These limitations could result in dropped UDP packets, even if the traffic rate is below link capacity.

5.2 5G Measurement Results

For stress testing the AZ-LZ/WZ connection with 5G traffic, the UPF is placed at the network edge while the DNN container is located in the AZ. The UPF routes the user traffic from the DNN to the gNBSIM in the edge zone. Our measurement methodology is illustrated in Figure 13. We instantiate up to 8 network slices with each slice running 10 pairs of

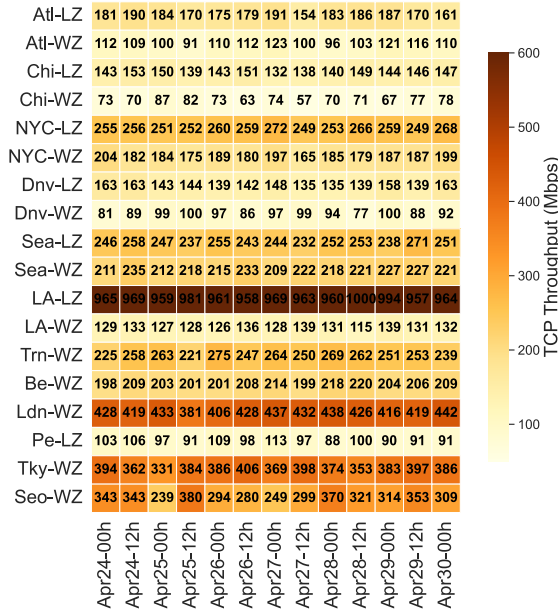

(a) TCP throughput

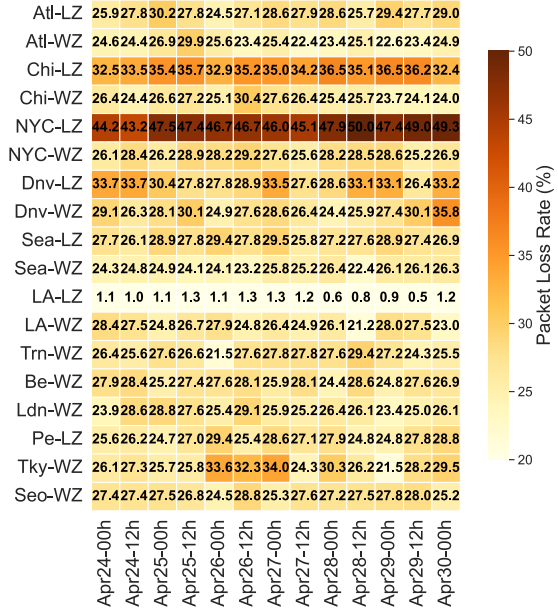

(b) UDP packet loss over 1 Gbps bandwidth

Figure 12: Throughput measured over a week with 12-hour intervals between edge zones and AZs. Measurement recordings are started at the reported times according to Eastern Standard Time. (This figure represents the bi-daily averages. Raw throughput measurements are given in Appendix E.)

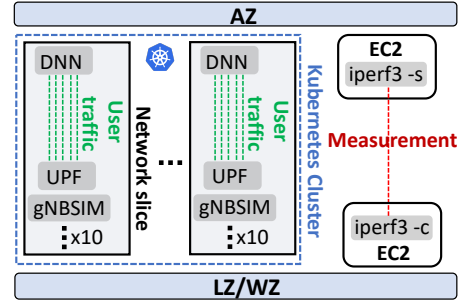

Figure 13: Measurement methodology for user plane experiments across edge zones and AZs

gNBSIM-DNN connections. Each pair represents a single-user session. This requires instantiating 10 pairs of gNBSIMs and DNNs per slice with a single UPF. We gather results for 40, 80 users, with 4, 8 network slices.

To understand how each traffic pattern affects the connection, we run the same experiment separately for each use case in Table 1. While scaling the user plane in this manner, we avoid overloading a single UPF. Thus, not limited by processing bottlenecks that exist in software, we can test the AZ-LZ/WZ link capacity. As a result, the focus is on measuring the deterioration of the 5G user plane connection due to the consumption of the AZ-LZ/WZ bandwidth.

To understand the impact of user plane traffic, a pair of reference EC2 instances are booted in each zone, independent from the Kubernetes cluster nodes. We start an iperf3 client between these reference nodes and run the client for 100 samples with 20 iterations. Then, we observe the behavior of the AZ-LZ/WZ connection.

5.2.1 TCP Throughput Measurements.

The first set of results in Figure 14 demonstrate how different traffic patterns affect the TCP throughput across zones. For the edge zones in US-East and US-West regions, the deterioration experienced by LZs and WZs is consistent across all the use cases. Compared with the weekly average bandwidth measurements, the instantiation of the first four network slices has a negligible impact on the edge zone connection for the LZs. Going from four to eight slices, however, the decrease in throughput becomes more apparent for the WZ connections. For the majority of the EU and Asia-Pacific regions, the throughput fluctuations are very high. Especially in London, Tokyo, and Seoul, it is harder to observe a specific pattern because the native throughput capacity is higher.

To understand how each traffic pattern affects the connection, we analyze the results for cities where the deterioration is most noticeable. These are primarily the US zones and the Berlin WZ. The lowest TCP throughputs are reported when the Netflix and Zoom traffic patterns are active, followed by the Oculus VR traffic. For URLLC slices, such as Oculus and Fortnite traffic, the UPF is better hosted on WZs. However, hosting application servers in edge zones is more expensive,

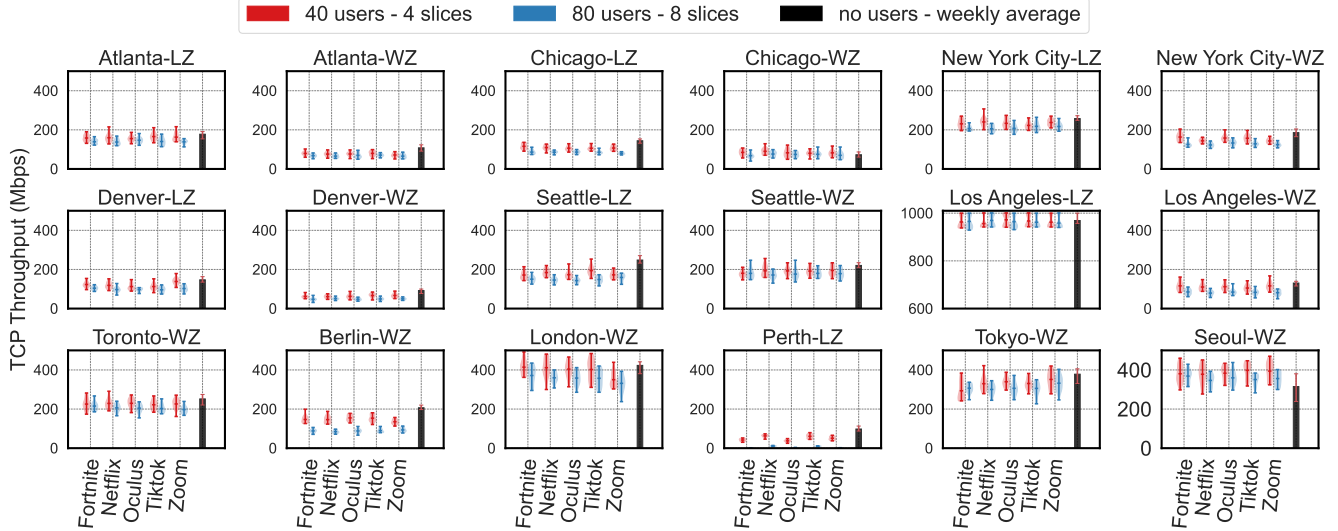

Figure 14: TCP Throughput measured between an edge zone and AZ host with 5G user plane traffic.

due to the scarcity of computing resources. Thus, for chosen zones that do not suffer significant latency penalties (e.g., Seoul, Tokyo, and London), it is acceptable for the application servers of these use cases to be placed in the AZ. Furthermore, for use cases such as Netflix and Tiktok that are not ultra-latency sensitive, the servers can similarly be placed in AZs. It is crucial that both service providers and MVNOs are aware of the traffic load on AZ-LZ/WZ connections when committing to a placement model.

5.2.2 UDP Packet Loss Rate Measurements.

In certain use cases, TCP is favored for its reliable data delivery, while in other scenarios, user data is transmitted over UDP. Through our traffic analysis, we can see that the data in Zoom and VR gaming use UDP. The results in Figure 15 illustrate how UDP packet loss rate over a 1 Gbps connection changes as more 5G users are instantiated. Currently, only the Los Angeles LZ has packet loss rate below 2% over a 1Gbps connection. To keep the comparison fair, we use the same network bandwidth while evaluating other regions.

In contrast to the TCP measurements, there are more outliers in the UDP evaluations. Nevertheless, we still observe noticeable patterns. In the US region LZs, the difference between the weekly benchmark results and the case with four active slices is lower for LZs than WZs. This is most apparent by checking the results of New York City and Denver. Even though the average packet loss rate remains lower in WZs than LZs, the deterioration in the WZs is higher than LZs with an increasing number of data sessions.

In our benchmarks (Section 5.1), we mentioned the correspondence with AWS to confirm that WZs (with the notable exception of the Los Angeles LZ) are specialized for handling UDP traffic. When stress testing with traffic, we observe that for Denver and Atlanta, the WZs in fact do not outperform

the LZs in the same city. This indicates that, while WZs are designed for handling UDP traffic, the AZ-WZ connection traversing AWS-TSP infrastructure is not yet fully stable when subjected to high traffic loads. Thus, for selective edge regions, the user plane can be shared between the LZs and WZs for better performance.

The takeaway from the measurements in Figure 15 is the consistent increase in packet loss rate for the US regions compared to the relative stability of London, Tokyo, and Seoul. This goes to show that the bottlenecks are more apparent in the US due to the physical distance between AZs and edge zones. With the ever-expanding 5G deployments, this will eventually create a backhaul bottleneck that needs to be addressed if the AWS public cloud is to become a valid candidate for hosting the 5G user plane in US regions. Overall, our measurements shown in Figures 14 and 15 provide valuable insights into the network performance of multiple edge locations when subjected to different traffic loads.

6 Discussion

This section discusses the limitations of our study as well as the recommendations for improving the AWS infrastructure.

6.1 Inter-WZ Handover

Our analysis regarding Mobile MCS clients assumes that the VNFs of the current and target slice are situated in the same edge zone. This is necessary for evaluation purposes, but ultimately it is a counter-intuitive assumption. A case study is depicted in Figure 16 that presents a scenario with multiple WZs and a drone traversing through their coverage jurisdiction. In such a scenario, the VNFs of the target slice are located in WZ-3 along the movement path of the drone.

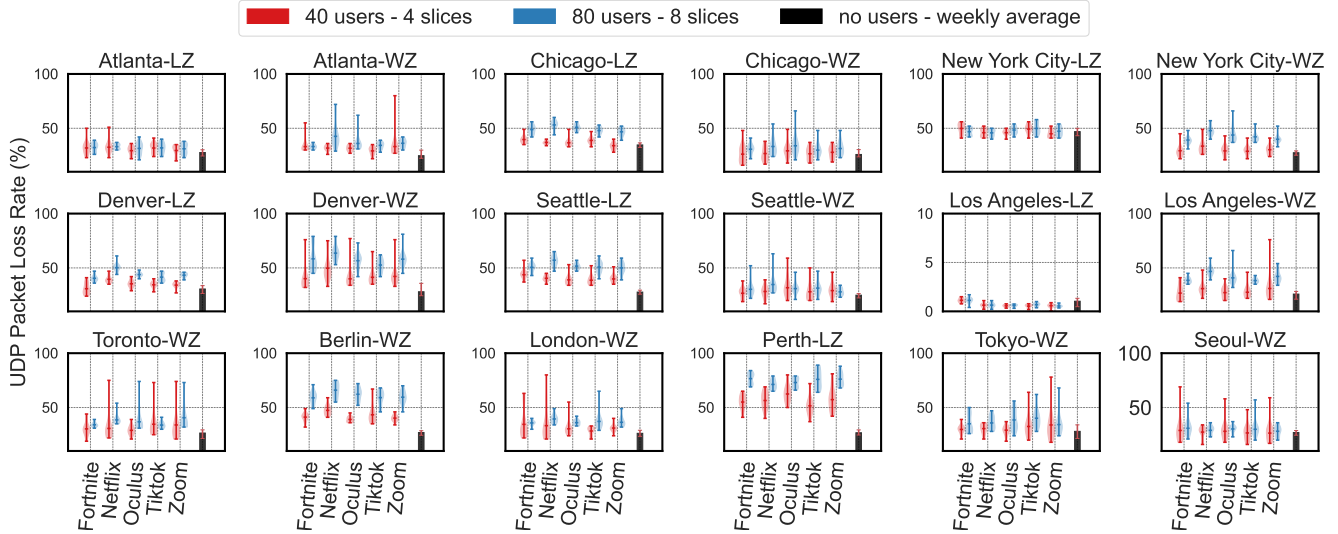

Figure 15: UDP Packet loss rate over a 1 Gbps connection between LZs/WZs and AZs with 5G user plane traffic.

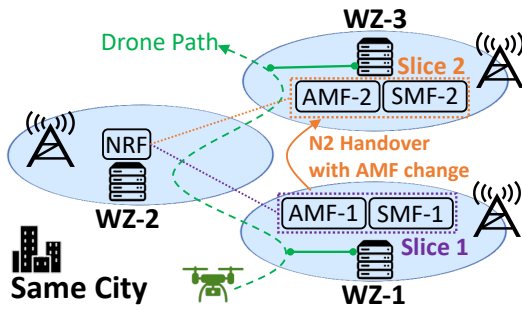

Figure 16: N2 handover scenario with AMF change illustrated in the case of multiple WZs existing in a single city

Therefore, the N2 handover process with AMF change takes place between slice 1 in WZ-1 and slice 2 in WZ-3, where the VNFs of both slices are registered with the NRF in WZ-2.

The existing infrastructure provisions, such as the distribution and density of edge zones, are insufficient to assess this scenario because the required setups are not in place. In the future, every Central Unit (CU) of a 5G gNB in a heterogeneous network might be paired with COTS hardware [39], which can host the VNFs of Mobile MCS slices. Under this assumption, what becomes significant is the delay between these individual locations. While we currently cannot understand the implications of this setup, our results in Figure 9 serve to demonstrate the feasibility of using WZs and LZs with AZs to host Mobile MCS slices by moving the NRF and AMF into the edge. A discussion point is provided in Section 6.2 that further elaborates on how establishing inter-LZ-WZ connectivity can improve QoS for hybrid use cases.

6.2 LZ-WZ Inter-Connectivity

We have confirmed through experimental attempts and correspondence with the AWS technical team that currently no direct connectivity exists between LZs and WZs. Thus, for any deployment, only one of the edge zone variants can be used at the same time. AWS should consider establishing this connectivity to unlock different deployment options for operators. For instance, a hybrid deployment can be constructed with edge, distributed, and central cloud domains, represented by WZ, LZ, and AZ, respectively. In such an ecosystem, both VNFs and application servers can be distributed to inter-connected WZs and LZs, depending on operational and user-plane requirements. Ultimately, the deployments will have higher flexibility in addressing different use cases.

A specific case study is illustrated in Figure 17, where for a live stream and drone communications, standalone WZ and LZ connectivity is sufficient. However, for enhancing the support to a hybrid drone live stream use case, establishing connectivity between WZs and LZs will promote high user plane throughput by placing UPF and SMF within WZs while also maintaining low control plane latency with AMF and NRF placed in LZs. Ultimately, the user plane (i.e., UPF) remains in close proximity to the 5G RAN and the edge control plane VNFs (i.e., AMF and NRF) have lower latency to the 5G core HN (i.e., AUSF, UDM, and UDR) than the case where they would have been placed in WZs.

6.3 WZ-LZ Connectivity to the RAN

To fully compare WZs and LZs, their connections to the available RANs need to be evaluated. While this is beyond the scope of our study, it is desirable to assess how WZs are superior to LZs for latency-sensitive user plane traffic. Without understanding the end-to-end latency between a real-life user

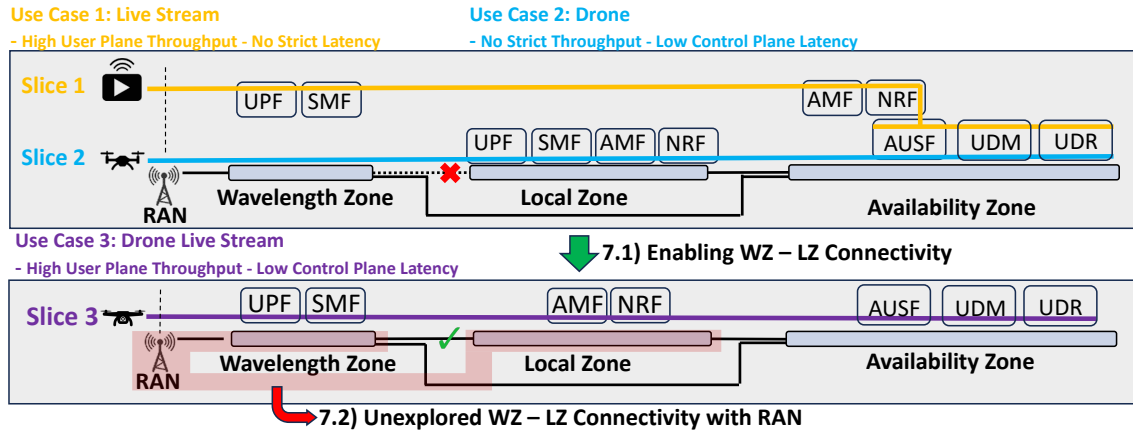

Figure 17: Summarizing the discussions and limitations. **Suggestion:** Enabling Interconnectivity between WZ and LZ. **Limitation:** Unexplored measurement domain between RANs and edge zones for respective operators in each country.

and the application server, it will be challenging to fully unveil the limitations of 5G deployments over AWS.

7 Related Work

In [9], the authors proposed a network slice-as-a-service [20] delivery framework for different use cases. They evaluated network slice deployments in a local testbed and calculated cost projections for deployment in a cloud based on the computing consumption of 5G components. A similar scaling study is conducted in [10], where slices are deployed in different topologies pertaining to different use cases. The computing resource consumption of individual VNFs is stress-tested in response to the number of UEs being serviced. However, both evaluations take place over a single physical node with multiple VMs, isolated from the Internet.

A commercial measurement study is conducted in [26], where a machine learning model is proposed to predict the performance of millimeter-wave (mmWave) 5G deployments. However, at the time of the study, 5G deployments were reliant on the LTE core. While the study provides insight into the workings of a mmWave commercial 5G deployment, its focus is on RAN measurements rather than core.

With the focus on the 5G core, [8] seeks to improve the control plane reliability. An edge-based 5G core deployment design is presented with fault tolerance. While the study identifies key issues related to mobility management, the experiments take place over co-located hardware, isolated from the Internet, and thus they are not exposed to real-life conditions.

A recent study focuses on high mobility use cases amongst 5G and LTE [33]. An in-depth analysis provides coverage of how high mobility affects various 5G procedures. While the authors provide very important findings on how 5G deals with mobility, they do not dig into the intricacies of cloud-based 5G core networks. Rather, their study is focused on measuring the performance of existing 5G networks instead of analyzing

what cloud-based 5G networks could be like.

Other research studies have delved into the analysis of more specific user ecosystems. In [24], the roaming of IoT devices connected to mobile networks is investigated. A data-driven approach for troubleshooting the user-plane performance degradation is presented in [37]. Surveys have been conducted over the past years for qualitatively investigating the challenges of deploying 5G networks in clouds [19, 21]. However, to the best of our knowledge, this paper is the first to present a global analysis of 5G core control and user plane bottlenecks using real public cloud deployments.

Last but not least, Microsoft has launched the Azure Private 5G core [25], their advent towards enabling enterprises to build and operate private 5G networks. Azure provides their own set of 5G core VNFs to be used by MVNOs for creating on-premises or cloud-based deployments. For businesses without in-house 5G experts, this solution provides easy access to a 5G stack.

8 Conclusion

The 5G network deployments have been expanding at a rapid pace. With their extensive computing infrastructure, AWS has partnered with chosen operators to build an integrated cloud environment for 5G. To explore this ecosystem, we built a large scale 5G testbed spanning multiple edge LZs and WZs across different AWS regions. In our campaign, we have demystified the operational control plane latency implications of hosting different 5G core VNFs in alternative edge locations. Furthermore, we instantiated 5G user plane traffic loads across zones to stress test the AZ-LZ/WZ connections. This helped us identify bottlenecks for US-based regions while showing the superiority of the connection for the chosen EU and Asia-Pacific zones. Leveraging our findings, operators around the world can glance into the existing limitations of using edge zones for specific use cases.

References

- [1] 3GPP. Common API Framework for 3GPP Northbound APIs; Stage 2. TS 23.222 V18.0.0 , 3rd Generation Partnership Project (3GPP), December 2022.
- [2] 3GPP. System architecture for the 5G System (5GS); Stage 2. TR 23.501 V18.0.0 , 3rd Generation Partnership Project (3GPP), December 2022.
- [3] 3GPP. Mission Critical Services Common Requirements (MCCoRe); Stage 1. TS 22.280 V19.1.0 , 3rd Generation Partnership Project (3GPP), March 2023.
- [4] 3GPP. Network Function Repository Services; Stage 3. TS 29.510 V18.2.0 , 3rd Generation Partnership Project (3GPP), March 2023.
- [5] 3GPP. Network Slice-Specific and SNPN Authentication and Authorization services; Stage 3. TS 29.526 V18.1.0 , 3rd Generation Partnership Project (3GPP), March 2023.
- [6] 3GPP. Security architecture and procedures for 5G system. TS 33.501 V18.1.0 , 3rd Generation Partnership Project (3GPP), March 2023.
- [7] Mukhtiar Ahmad, Syed Usman Jafri, Azam Ikram, Wasiq Noor Ahmad Qasmi, Muhammad Ali Nawazish, Zartash Afzal Uzmi, and Zafar Ayyub Qazi. A Low Latency and Consistent Cellular Control Plane. In *Proceedings of the ACM ACM Special Interest Group on Data Communication (SIGCOMM)*, pages 648–661, 2020.
- [8] Mukhtiar Ahmad, Muhammad Ali Nawazish, Muhammad Taimoor Tariq, Muhammad Basit Iqbal Awan, Muhammad Taqi Raza, and Zafar Ayyub Qazi. Enabling Emerging Edge Applications Through a 5G Control Plane Intervention. In *ACM Proceedings of the 18th International Conference on Emerging Networking Experiments and Technologies (CoNEXT)*, pages 386–400, 2022.
- [9] Tolga O Atalay, Dragoslav Stojadinovic, Alireza Famili, Angelos Stavrou, and Haining Wang. Network-Slice-as-a-Service Deployment Cost Assessment in an End-to-End 5G Testbed. In *GLOBECOM 2022 IEEE Global Communications Conference*, pages 2056–2061. IEEE, 2022.
- [10] Tolga O Atalay, Dragoslav Stojadinovic, Angelos Stavrou, and Haining Wang. Scaling Network Slices with a 5G Testbed: A Resource Consumption Study. In *2022 IEEE Wireless Communications and Networking Conference (WCNC)*, pages 2649–2654. IEEE, 2022.
- [11] AWS. 5g Edge Computing Infrastructure – AWS Wavelength FAQ – Amazon Web Services. <https://aws.amazon.com/wavelength/faqs/>, 2023. (Accessed on 08/13/2023).
- [12] AWS. Architecture Guidelines and Decisions - General SAP Guides. <https://docs.aws.amazon.com/sap/latest/general/arch-guide-architecture-guidelines-and-decisions.html>, 2023. (Accessed on 07/02/2023).
- [13] AWS. AWS Wavelength Zone Locations. <https://aws.amazon.com/wavelength/locations/>, 2023. (Accessed on 08/29/2023).
- [14] AWS. Deployment AWS Local Zones–Amazon Web Services. <https://aws.amazon.com/about-aws/global-infrastructure/localzones/>, 2023. (Accessed on 08/29/2023).
- [15] AWS. Managed Kubernetes Service – Amazon EKS – Amazon Web Services. <https://aws.amazon.com/eks/>, 2023. (Accessed on 08/13/2023).
- [16] AWS. Regions and Zones - Amazon Elastic Compute Cloud, September 2023. [Accessed on 09/16/2023].
- [17] Davide Borsatti, Chiara Grasselli, Chiara Contoli, Luigia Micciullo, Luca Spinacci, Marina Settembre, Walter Cerro, and Franco Callegati. Mission Critical Communications Support with 5G and Network Slicing. *IEEE Transactions on Network and Service Management*, 2022.
- [18] Ericsson. Swisscom, Ericsson, AWS Collaborate on 5g Core for Hybrid Cloud. <https://www.ericsson.com/en/news/2023/3/swisscom-ericsson-and-aws-collaborate-on-5g-core-for-hybrid-cloud>, Mar 2023. (Accessed on 08/08/2023).
- [19] Ali Esmaeily and Katina Kravetska. Small-Scale 5G Testbeds for Network Slicing Deployment: A Systematic Review. *Wireless Communications and Mobile Computing*, 2021, 2021.
- [20] GSMA. Official Document NG 116-Generic Network Slice Template v6.0, 2021.
- [21] Akhil Gupta and Rakesh Kumar Jha. A Survey of 5G Network: Architecture and Emerging Technologies. *IEEE access*, 3:1206–1232, 2015.
- [22] iperf. The ultimate speed test tool for TCP, UDP and SCTP. <https://iperf.fr/iperf-download.php>, 2023. (Accessed on 08/18/2023).
- [23] Jaeger. Jaeger Open Source, End-to-End Distributed Tracing. <https://www.jaegertracing.io/>, 2023. (Accessed on 08/29/2023).

- [24] Andra Lutu, Byungjin Jun, Alessandro Finamore, Fabián E Bustamante, and Diego Perino. Where Things Roam: Uncovering Cellular IoT/M2M Connectivity. In *Proceedings of the ACM Internet Measurement Conference (IMC)*, pages 147–161, 2020.
- [25] Microsoft. Azure Private 5G Core – Manage 5G Networks - Microsoft Azure. <https://azure.microsoft.com/en-us/products/private-5g-core>, 2023. (Accessed on 07/29/2023).
- [26] Arvind Narayanan, Eman Ramadan, Rishabh Mehta, Xinyue Hu, Qingxu Liu, Rostand AK Fezeu, Udhaya Kumar Dayalan, Saurabh Verma, Peiqi Ji, Tao Li, et al. Lumos5G: Mapping and Predicting Commercial mmWave 5G Throughput. In *ACM Proceedings of the Internet Measurement Conference (IMC)*, pages 176–193, 2020.
- [27] K8s Network Plumbing. k8snetworkplumbingwg/multus-cni: A CNI meta-plugin for multi-homed pods in kubernetes. <https://github.com/k8snetworkplumbingwg/multus-cni>, 2023. (Accessed on 08/21/2023).
- [28] NGINX. What is a sidecar? - nginx. <https://www.nginx.com/resources/glossary/sidecar/>. (Accessed on 09/03/2023).
- [29] OpenAirInterface. 5g radio access network gnb and nrue. <https://gitlab.eurecom.fr/oai/openairinterface5g>, 2023. (Accessed on 07/22/2023).
- [30] OpenTelemetry. High-quality, Ubiquitous, and Portable Telemetry to Enable Effective Observability. <https://opentelemetry.io/>, 2023. (Accessed on 08/29/2023).
- [31] Jose Ordonez-Lucena, Pablo Ameigeiras, Diego Lopez, Juan J Ramos-Munoz, Javier Lorca, and Jesus Folgueira. Network Slicing for 5G with SDN/NFV: Concepts, Architectures, and Challenges. *IEEE Communications Magazine*, 55(5):80–87, 2017.
- [32] Antonino Orsino, Aleksandr Ometov, Gabor Fodor, Dmitri Moltchanov, Leonardo Militano, Sergey Andreev, Osman NC Yilmaz, Tuomas Tirronen, Johan Torsner, Giuseppe Araniti, et al. Effects of Heterogeneous Mobility on D2D-and Drone-assisted Mission-critical MTC in 5G. *IEEE Communications Magazine*, 55(2):79–87, 2017.
- [33] Yueyang Pan, Ruihan Li, and Chenren Xu. The First 5G-LTE Comparative Study in Extreme Mobility. *Proceedings of the ACM on Measurement and Analysis of Computing Systems (SIGMETRICS)*, 6(1):1–22, 2022.
- [34] Vitaly Petrov, Maria A Lema, Margarita Gapeyenko, Konstantinos Antonakoglou, Dmitri Moltchanov, Fragkiskos Sardis, Andrey Samuylov, Sergey Andreev, Yevgeni Koucheryavy, and Mischa Dohler. Achieving End-to-end Reliability of Mission-Critical Traffic in Softwarized 5G Networks. *IEEE Journal on Selected Areas in Communications*, 36(3):485–501, 2018.
- [35] Rohan. Gnbsim - gitlab. <https://gitlab.eurecom.fr/kharade/gnbsim>, 2023. (Accessed on 07/22/2023).
- [36] AWS Samples. EKS Automated IP Management for Multus Pods. <https://github.com/aws-samples/eks-automated-ipmgmt-multus-pods>, 2022. (Accessed on 08/21/2023).
- [37] Xiaofeng Shi, Matthew Osinski, Chen Qian, and Jia Wang. Towards Automatic Troubleshooting for User-level Performance Degradation in Cellular Services. In *ACM Proceedings of the 28th Annual International Conference on Mobile Computing And Networking (MobiCom)*, pages 716–728, 2022.
- [38] Suse. RKE - ranchers kubernetes engine. <https://www.rancher.com/products/rke>, 2023. (Accessed on 08/13/2023).
- [39] Tarik Taleb, Konstantinos Samdanis, Badr Mada, Hannu Flinck, Sunny Dutta, and Dario Sabella. On Multi-access Edge Computing: A Survey of the Emerging 5G Network Edge Cloud Architecture and Orchestration. *IEEE Communications Surveys & Tutorials*, 19(3):1657–1681, 2017.
- [40] Telefonica. Telefónica - microsoft azure multicloud b2b. <https://www.telefonica.com/en/communication-room/telefonica-includes-microsoft-azure-in-its-multicloud-offering-to-the-b2b-market/>, Oct 2022. (Accessed on 09/09/2023).
- [41] Deutsche Telekom. Deutsche Telekom teams up with AWS for 5G campus network offerings - deutsche telekom. <https://www.telekom.com/en/media/media-information/archive/new-aws-portals-for-5g-campus-networks-1033264>, Apr 2023. (Accessed on 09/09/2023).
- [42] Faqir Zarrar Yousaf, Michael Bredel, Sibylle Schaller, and Fabian Schneider. NFV and SDN—Key Technology Enablers for 5G Networks. *IEEE Journal on Selected Areas in Communications*, 35(11):2468–2478, 2017.

A Message Interception Flow

To clarify the message interception process in our monitoring pipeline, Figure 18 depicts a sample message flow for a single HTTP transaction taking place between AMF and SMF.

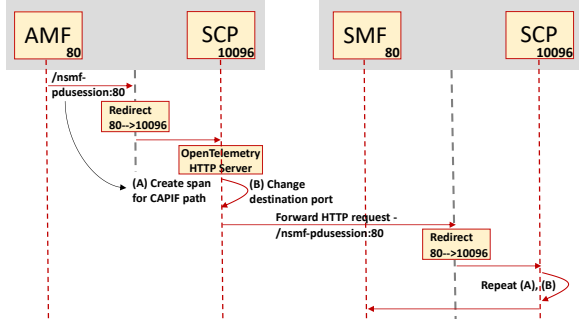

Figure 18: Sample API call from AMF to SMF illustrating monitoring SCP interception

The gray outline corresponds to individual pod deployments within the Kubernetes cluster. The IPTABLES of all the pods have been modified to perform port forwarding on all messages originating from the user identifier (UID) of the 5G core VNFs. Therefore, every outgoing and incoming message to the VNFs is redirected through the monitoring SCP.

In this example, AMF is making an API call to SMF with the CAPIF path `/nsmf-pdusession` on port 80. The pod network sandbox redirects this HTTP request to the localhost on port 10096, where the monitoring SCP is running an OpenTelemetry HTTP server. Upon receiving the request, SCP extracts the CAPIF path from the URL and creates a span corresponding to the specific source and destination VNF (i.e., AMF and SMF, respectively). Finally, it changes the destination port on the outgoing message and forwards it to the pod of the target VNF. The same process is executed within the SMF pod upon the arrival of the HTTP message. Combining this interception and redirection with the instrumentation pipeline in Figure 4 allows us to perform distributed tracing on the HTTP transactions in the 5G core. Ultimately, we are able to monitor the end-to-end execution time of individual operations and group them together in concise logs.

B AZ - Edge Zone Measurements

For experimentation, we have multiple AZs in each parent region to choose from. This is mainly for redundancy purposes, where applications with high-reliability requirements can be deployed in multiple AZs. However, we are primarily interested in the connection characteristics between AZs and a given edge zone.

Since their exact location has not been disclosed by AWS, there is no way to select the optimal AZ for a given edge zone based on geographical proximity. However, according to AWS architecture guidelines [12], all these AZs are within 100 kilometer distance from each other. To fully understand the difference between opting for one AZ or another in the same region, we benchmark the latency between all AZs and edge zones in Figure 4. These benchmarks show that the

Table 4: Average latency between edge zones and all AZs in a given parent region. In some regions, the AZ designation skips a letter (e.g., Tokyo - a, c, d)

City	Zone	Avg. AZ Latency (ms)					
		a	b	c	d	e	f
NYC	LZ	8.36	8.23	7.94	8.07	8.60	7.98
	WZ	14.9	14.1	14.2	14.6	14.8	14.6
CHI	LZ	24.6	23.2	23.5	23.8	23.0	24.3
	WZ	58.6	59.0	58.7	58.6	59.5	58.4
ATL	LZ	15.8	16.2	16.1	15.4	16.5	15.8
	WZ	34.1	33.7	33.5	33.8	34.2	47.5
SEA	LZ	8.9	8.1	8.5	8.2	-	-
	WZ	9.3	9.6	9.4	11.8	-	-
LA	LZ	25.4	26.3	26.5	25.4	-	-
	WZ	26.5	27.8	28.0	26.2	-	-
DNV	LZ	23.0	23.1	22.3	22.1	-	-
	WZ	36.0	36.8	35.6	37.5	-	-
BE	WZ	12.0	12.4	11.2	-	-	-
LDN	WZ	4.6	4.3	4.9	-	-	-
TRN	WZ	9.7	10.2	-	10.8	-	-
SEO	WZ	5.3	4.4	5.9	5.3	-	-
TKY	WZ	5.3	-	6.8	6.3	-	-
PE	LZ	41.5	42.3	42.3	-	-	-

difference in latency to different AZs from a given edge zone is less than 1ms. Since such a latency is negligible, we use the first AZ (i.e., AZ-a) in each region for experimentation.

C OAI 5G Core Message Flow

The message flow in Figure 19 has been divided into three sub-blocks. These are the VNF registration block, 5G-AKA overview, and the Packet Data Unit (PDU) session setup.

In the VNF registration, the AMF, SMF, and the UPF send their metadata profiles to the NRF and receive a confirmation after the latter registers them in a local database. Afterwards, heartbeat updates are sent from the AMF, SMF, and UPF to the NRF to report any metadata alterations during run-time. In case of a modification, the NRF will respond with a status notification to each VNF.

In the 5G-AKA service chain, the AMF is responsible for handling the SN credentials, while the AUSF, UDM, and UDR are parts of the HN service chain. We have abstracted out some of the extreme details of this process and more detailed information can be found at [6].

Finally, in the PDU session setup, AMF, SMF, and UPF establish a user plane data connection for the UE. In this process, AMF and SMF need to respectively discover an SMF and UPF for network slice construction [4]. The discovery is facilitated by the NRF. After discovery, AMF and SMF set up a data connection through a series of HTTP transactions as shown in the *PDU Session Setup Overview* block in Figure 19.

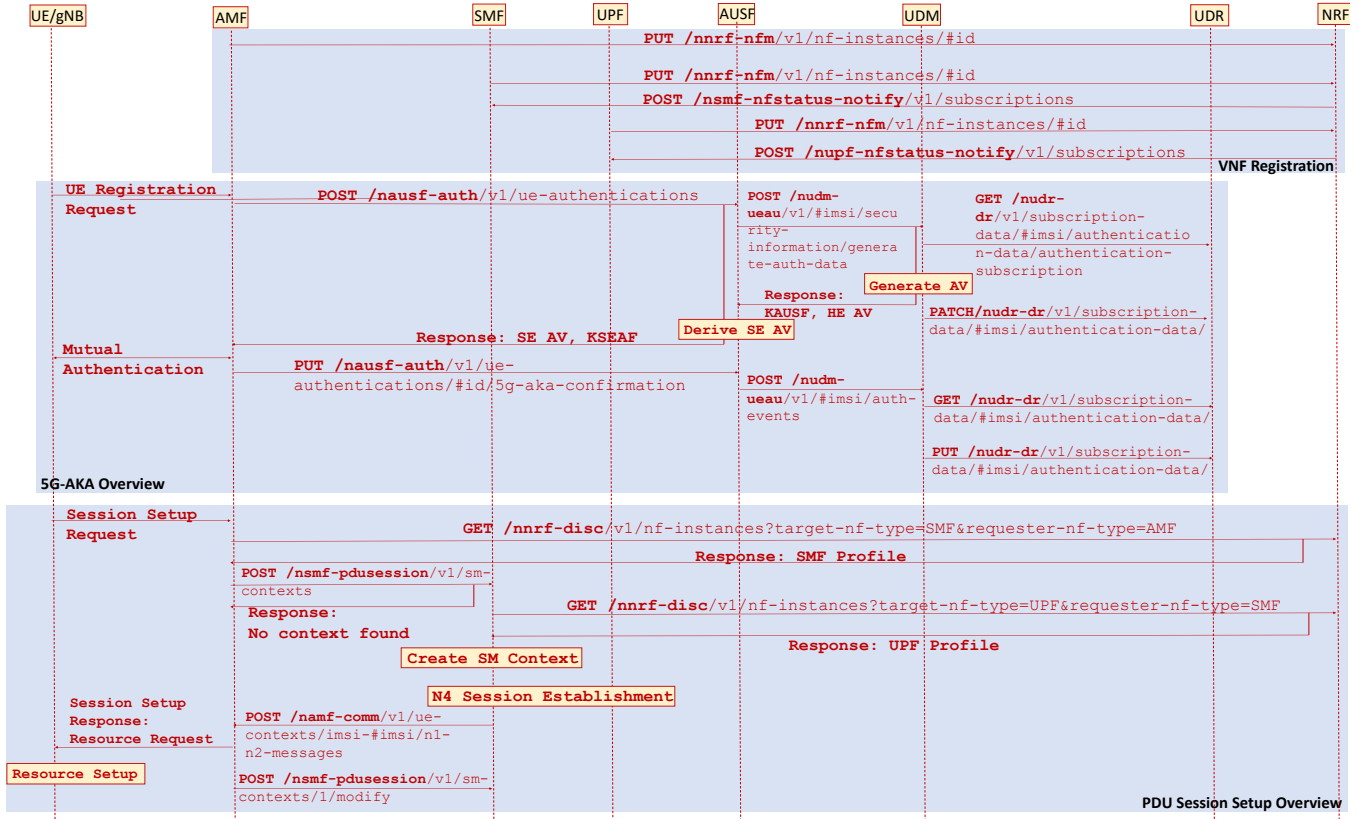

Figure 19: 5G core VNF message exchange for end-to-end session setup

D User Traffic Patterns

To capture the traffic patterns for the user plane experimentation, we start by connecting our devices that generate traffic to a Linksys WRT3200ACM programmable OpenWRT router. When a device connected to this router generates traffic, we capture the traffic pattern to be replayed later during the user plane experiments. For the Zoom video call and Netflix streaming use case, we use an iPhone 13 Pro. For the virtual reality case, we use an Oculus Quest 2.

E Raw Throughput Benchmarks

Our entire set of AWS edge zone benchmark measurements are given in Figures 21 and 22 for TCP throughput and UDP packet loss rate respectively. However, for the TCP and UDP benchmarks, each data point has been obtained using an iperf3 stream with 100 samples where the final average is reported. Due to the inherent volatile nature of the TCP and UDP connections between AZs and edge zones, this method yields a more reliable average.

While with sufficient measurements the average indeed reflects a consistent pattern both for TCP throughput and UDP packet loss, the variations are more apparently observed

in Figures 21, 22 from the weekly CDFs. This allows us to account for the time-related fluctuations in both TCP and UDP connections and obtain a reliable average.

F AWS Experimentation Cost

Conducting the experiments in this paper required instantiating over 200 EC2 instances distributed across multiple locations. Furthermore, to create 5G user plane traffic for our measurements in Section 5.2, large amounts of data was transferred between edge zones and the respective parent regions. The EC2 instance and data transfer costs for each edge zone are given in Table 5. We can see that the data transfer rates for all the North America and Europe regions are the same. For the Asia-Pacific, these rates increase significantly. The inbound data transfer is free for all zones in all regions.

We share the total cost of the experimentation process in Figure 23. It is important to note that for the chosen regions and locations, these numbers should not be interpreted as an indication of what actual deployment costs would look like. In other words, real life 5G deployments may have different costs. We simply report the total experimentation cost as it is shown in the AWS billing dashboard of the account that was used to conduct the experiments. Our goal is to provide any

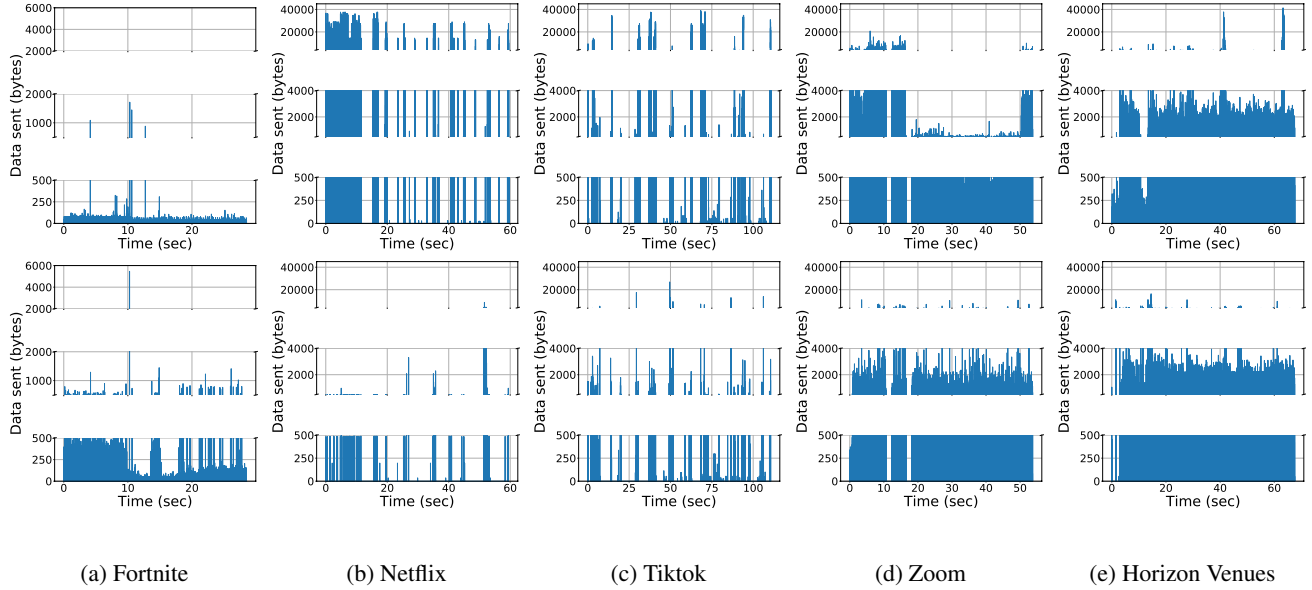

Figure 20: The downlink (top) and uplink (bottom) traffic patterns captured from different use cases for user plane experiments

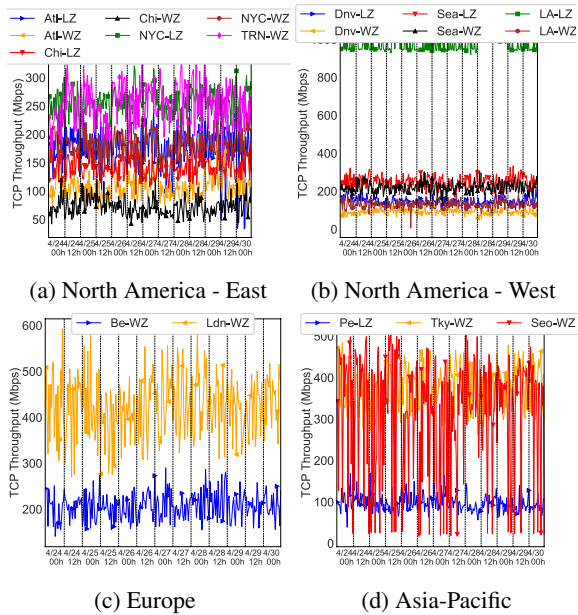

Figure 21: Raw measurements of weekly TCP throughput between AZs and edge zones. (April 24-30th 2023)

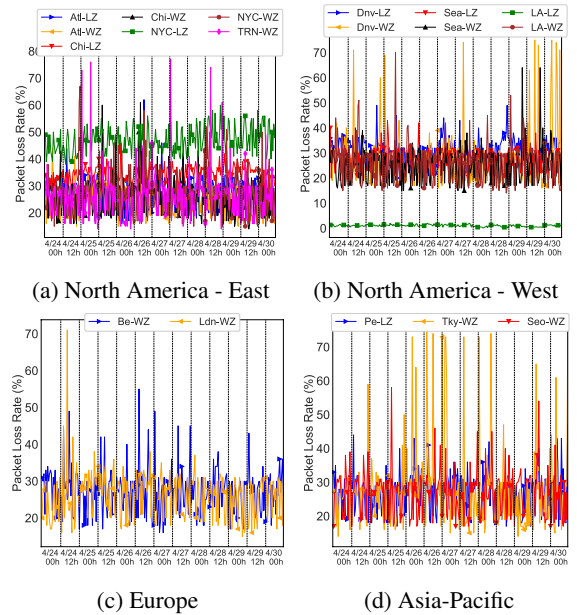

Figure 22: Raw measurements of weekly UDP packet loss between AZs and edge zones. (April 24-30th 2023)

interested parties with an idea regarding the cost of building and operating such a testbed.

For specific regions and locations, the experiments had to be repeated while addressing various bugs in the experimentation scripts and environment. The majority of the debugging process took place in the US-East (Northern Virginia) and the edge zones attached to it. Thus, we can see that the cost is much higher than other regions. In conclusion, we had to

repeat the experiments in certain regions due to various bugs. Figure 23 is presented here as a testament to the trial and error process we went through while gathering high fidelity results.

G AWS Cluster Deployment Details

Setup Selection: We use the Ranchers Kubernetes Engine (RKE) [38] to set up a self-managed production-grade Kuber-

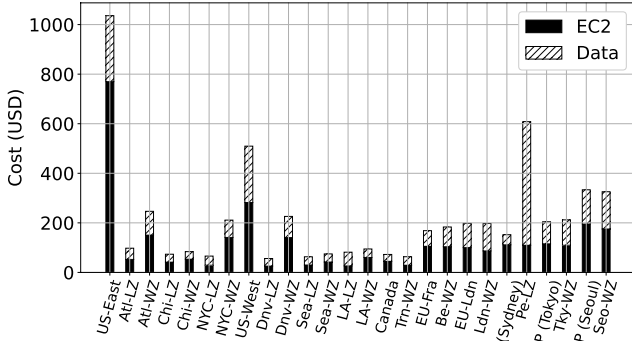

Figure 23: Total cost of the experiments in this paper broken down into EC2 and data transfer cost.

netes cluster on top of 15 EC2 instances. This allows us to have greater visibility into the container management infrastructure. We are able to manipulate worker node labels during setup to manage the location-specific VNF deployment during experimentation. In our flavor selection, we are limited to the t3.medium, t3.xlarge, and r5.2xlarge general-purpose compute nodes at WZs [11]. With only 2 vCPUs, t3.medium is not ideal for worker nodes and can lead to instability in the Kubernetes control plane. Therefore, we choose to use the more conservative t3.xlarge with 4 vCPUs, instead of the r5.2xlarge with 8 vCPUs. This enables us to spawn more EC2 instances within our regional vCPU quotas. The same flavor is used in AZs and LZs as well to preserve equality across the experiments.

EKS vs EC2: When setting up a Kubernetes cluster in a public cloud, users have the choice to either rely on an automation pipeline offered by the provider (e.g., AWS) or set up their own clusters from scratch. To that end, AWS offers the Elastic Kubernetes Service (EKS) [15] as a popular option for directly granting users access to a Kubernetes cluster by abstracting the setup process. While EKS is a robust solution, we were apprehensive about this usage, due to the lack of flexibility compared to self-managed clusters on top of EC2 instances. Especially for conducting host-to-host performance benchmarks, without having access to the VMs directly, we felt that our measurements could be restricted. Furthermore, being able to label nodes during cluster creation provided us with flexibility in deploying the 5G core VNFs in our chosen edge locations.

Secondary Network Interface: With our in-lab 5G testbed deployed on COTS hardware, the control plane communication among VNFs took place over secondary interfaces through Multus [27]. Multus is a Container Network Interface (CNI) plugin orchestrator, which allows for additional network interfaces to be attached to a pod. This is achieved through the creation of an additional Multus subnet, independent of the Kubernetes cluster Classless Inter-Domain Routing (CIDR) range. Moving to AWS, we noticed that none of the packets on this Multus subnet were being routed. This is because,

Table 5: EC2 instance and data transfer costs for all edge locations and AZs. The reported data transfer rate is for outbound traffic to the governing AZ of the edge location.

City	Zone	Cost (USD)	
		t3.xlarge (hourly)	Data (per GB)
Atlanta	AZ	0.1664	0.02
	LZ	0.208	0.02
	WZ	0.224	0.02
New York City	AZ	0.1664	0.02
	LZ	0.208	0.02
	WZ	0.224	0.02
Chicago	AZ	0.1664	0.02
	LZ	0.208	0.02
	WZ	0.224	0.02
Denver	AZ	0.1664	0.02
	LZ	0.208	0.02
	WZ	0.224	0.02
Seattle	AZ	0.1664	0.02
	LZ	0.208	0.02
	WZ	0.224	0.02
Los Angeles	AZ	0.1664	0.02
	LZ	0.208	0.02
	WZ	0.224	0.02
Toronto	AZ	0.1856	0.02
	WZ	0.2506	0.02
London	AZ	0.1888	0.02
	WZ	0.236	0.02
Berlin	AZ	0.192	0.02
	WZ	0.24	0.02
Tokyo	AZ	0.2176	0.09
	WZ	0.2938	0.09
Seoul	AZ	0.208	0.08
	WZ	0.26	0.08
Perth	AZ	0.2112	0.10
	LZ	0.2851	0.10

routing in AWS, takes place through routing table rules in the relevant Virtual Private Cloud (VPC). Without any prior configuration, the VPC cannot route packets between the private IP addresses of Kubernetes pods assigned to them using Multus. To deal with this issue, AWS has prepared an elaborate guide to support Multus pods on top of EKS [36]. While the guide is intended for an EKS cluster, we modified the automation scripts so that they functioned properly for the EC2 instances of our self-managed cluster. Essentially, the process involves three major steps: (1) creating a new secondary interface in the network stack of the guest-host; (2) running the Multus-pod and then attaching the Multus-IP of the pod to the new network interface created in step 1; and (3) updating the private IP address of the EC2 instance through AWS CLI to include the newly created interface. This way, the VPC can perform routing using the Multus-IPs. Unfortunately, for any operating system (OS) that is not Amazon Linux, the first step

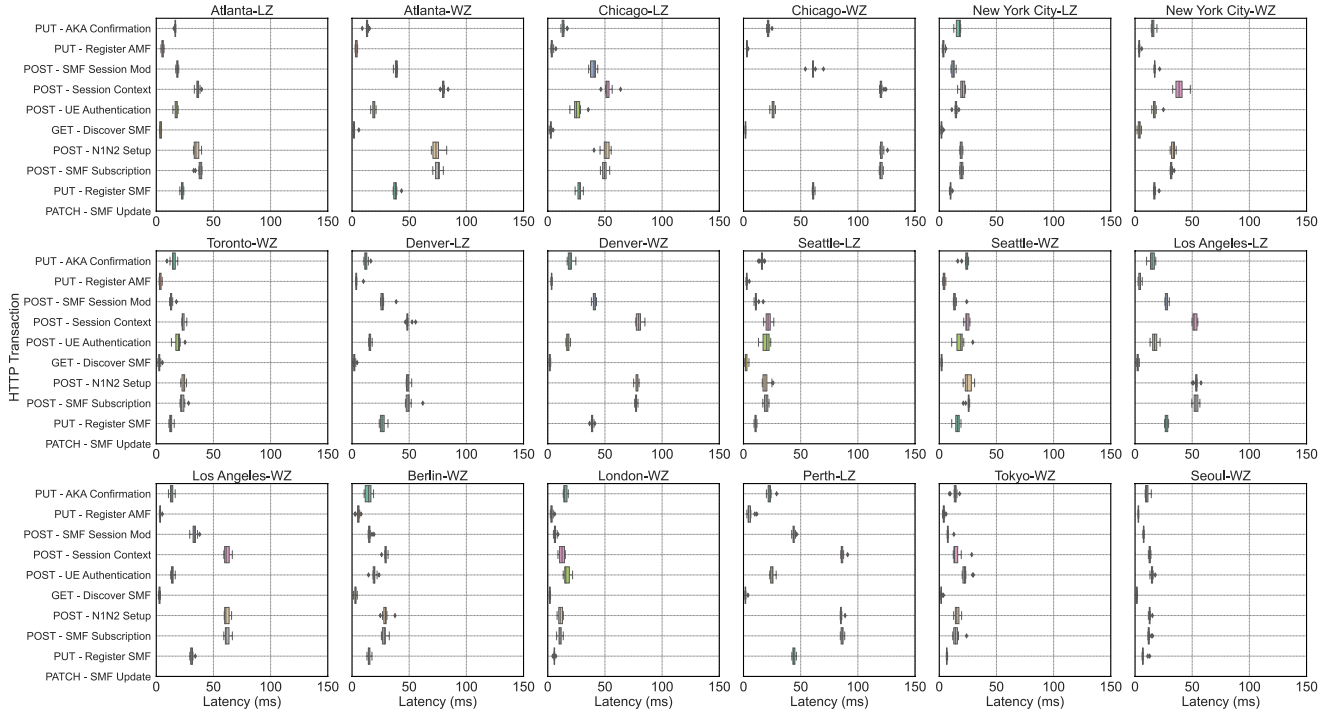

Figure 24: All HTTP transaction measurements for strategy 1 (URLLC User)

above cannot be automated through the provided guide [36]. The OS of our EC2 instances are Ubuntu 22.04. Thus, effectively applying the Multus solution devised by AWS required the creation and application of a new Netplan for the required secondary interface of each pod. After doing this, Multus routing was successful across EC2 instances. However, we quickly realized that while experimenting with network slicing, there would be hundreds of Multus-pods being deployed and this solution could create scalability issues down the line. Especially, since there would be a secondary interface for each pod, this implies that a single EC2 instance can have 100s of private IPs as the deployment scaled. Therefore, we had to configure our 5G testbed to utilize DNS-based resolutions among the 5G core VNFs using Kubernetes cluster services.

Wavelength Zone - No Internet : Currently, WZs do not have incoming Internet access. This means that no Docker image can be pulled onto them. To bypass this issue, we created an Amazon Machine Image (AMI) that contained all our required Docker images and started our EC2 instances in WZs using that AMI. This included the instrumentation environment images, Kubernetes cluster images (i.e., specifically RKE variants), and our custom OAI images. Since this AMI is bound to the AWS dashboard, we can easily share the AMI with other researchers if they attempt to re-create this testbed.

H HTTP Transaction Measurements

We provide the entire set of HTTP transaction measurements that lead to the averages presented in Figure 9. All the HTTP measurements are given in Figures 24, 25, 26 for the URLLC User, MCS Static and MCS Mobile strategies respectively. Our goal in providing these measurements is to show the variation in HTTP transaction latency values. Each transaction corresponds to ten traces. For the majority of the use cases, the latency fluctuations are less than 5ms. The highest relative deviation is observed in the London and Seattle-LZ measurements in Figures 24, 25 for the POST - UE Authentication HTTP message. For the London measurements, the error bars show higher variance but in a small interval. Since this specific HTTP message is associated with a compute-intensive process in the 5G-AKA service chain, this behavior is explained by the higher relative difference in software processing times within the VNFs. Looking at the 5G-AKA service chain in Figure 19, the POST - UE Authentication HTTP message triggers the sub-processes of the HN 5G-AKA VNFs (i.e., AUSF, UDM and UDR). After the HN VNFs process the request, the reply is sent to the AMF from the AUSF. Thus, the variation in the latency overhead of the POST - UE Authentication HTTP message stems from the HN 5G-AKA VNF processing.

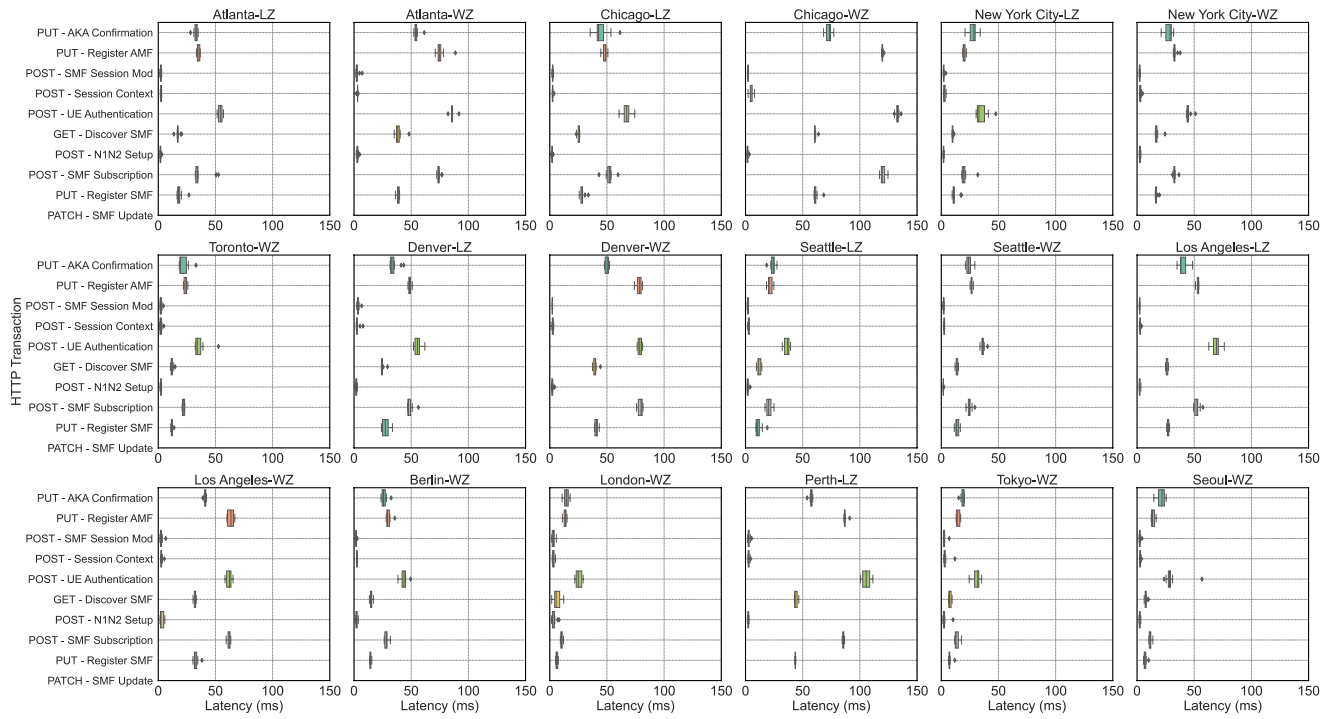

Figure 25: All HTTP transaction measurements for strategy 2 (MCS Static)

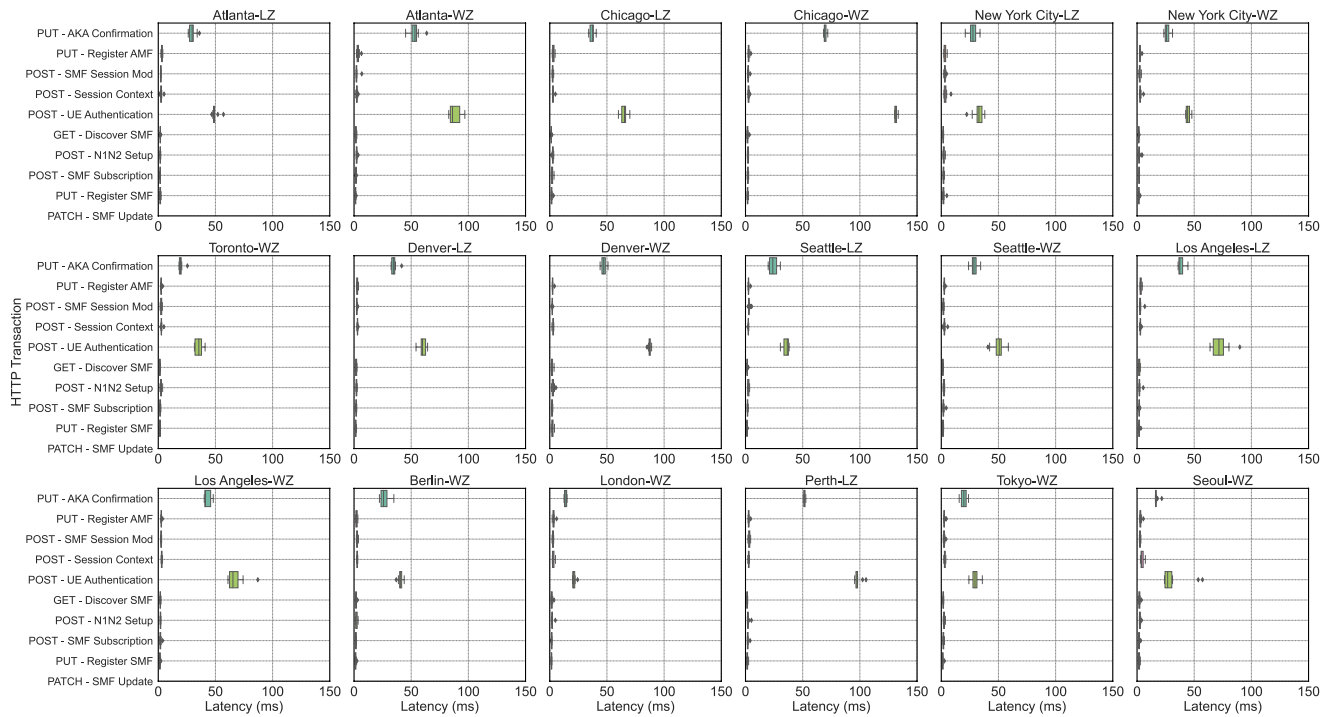

Figure 26: All HTTP transaction measurements for strategy 3 (MCS Mobile)