

On R -matrix formulation of qq -characters

Mehmet Batu Bayındırlı^{1,2*}, Dilan Nur Demirtaş^{1,3†}, Can Kozçaz^{1,4,5‡}, Yegor Zenkevich^{6§¶}

¹*Department of Physics, Boğaziçi University, Istanbul, Turkey*

²*School of Physics and Astronomy, University of Minnesota, Minneapolis, Minnesota 55455, USA*

³*Department of Physics, University of Arizona, Tucson, AZ 85721, USA*

⁴*Feza Gürsey Center for Physics and Mathematics, Boğaziçi University, Istanbul, Turkey*

⁵*Niels Bohr Institute, Copenhagen University, Blegdamsvej 17, Copenhagen, 2100, Denmark*

⁶*Departments of Mathematics, University of California, Berkeley, USA*

Abstract

We introduce an R -matrix formulation of qq -characters and corresponding Frenkel-Reshetikhin deformed W -algebras. The R -matrix featuring in the construction is of Ding-Iohara-Miki (DIM) algebra, while the type of the qq -character is determined by the network of Fock representations corresponding to a web of 5-branes geometrically engineering a quiver gauge theory. Our formulation gives a unified description of qq -characters of A_n type and their elliptic uplifts.

Contents

| | | |
|----------|-----------------------------------------------------------------------------------------------------------|-----------|
| 1 | Introduction | 2 |
| 1.1 | q -characters and quantum affine algebras | 3 |
| 1.2 | qq -characters and DIM algebra | 4 |
| 2 | DIM R-matrices as brane crossings | 6 |
| 3 | DIM coproduct and fundamental qq-characters from brane crossings | 8 |
| 4 | Normal ordering and commutation relations | 12 |
| 5 | Fundamental qq-characters from the operator formalism and refined topological strings | 14 |
| 5.1 | Fundamental qq -character of A_1 type | 14 |
| 5.1.1 | Operator formalism | 14 |
| 5.1.2 | Refined vertex computation | 15 |
| 5.2 | Fundamental qq -character of A_2 type | 21 |
| 5.2.1 | Operator formalism | 21 |
| 5.2.2 | Refined vertex computation | 21 |
| 6 | Multiple vertical brane insertions and higher qq-characters | 21 |
| 6.1 | Operator formalism | 22 |
| 6.2 | Refined vertex computation | 24 |
| 7 | Elliptic generalization of qq-characters | 25 |
| 7.1 | Operator formalism | 25 |
| 7.2 | Refined vertex computation | 29 |

*bayin004@umn.edu

†dilandemirtas@arizona.edu

‡can.kozcaz@boun.edu.tr

§yegor.zenkevich@gmail.com

¶On leave from ITMP MSU.

| | | |
|----------|-----------------------------------------------------------------|-----------|
| 8 | Conclusions | 30 |
| A | Basic facts about the DIM algebra | 31 |
| B | Conventions and identities | 34 |
| C | Algebraic engineering of the $U(2)$ theory | 35 |
| D | Elliptic deformation of vertex operators and DIM algebra | 38 |

1 Introduction

Quantum deformation is one of the central themes of modern “physical mathematics”. In particular, quantum deformations of Lie algebras [1, 2] were discovered in connection with lattice integrable models in statistical physics (see e.g. the classic book [3]), but soon found applications in many other areas such as knot theory [4], supersymmetric gauge theories [5], [6], and $2d$ conformal field theory (CFT) [7]–[9].

To capture the intricacies of the representation theory of quantum affine Lie algebras $U_q(\widehat{\mathfrak{g}})$ Knight [10] and Frenkel-Reshetikhin [11] have introduced the notion of q -characters which can be thought of as generalizations of conventional characters with more parameters. The principal ingredient in the construction of q -character is the R -matrix of $U_q(\widehat{\mathfrak{g}})$. The q -characters are partial traces of the R -matrix taken in finite-dimensional representations, so that algebraic properties of the R -matrix imply identities for the q -characters.

It also turned out that there is a *second* quantum deformation of q -characters involving parameter t , called qq -characters, natural from both geometric [12] and algebraic [11] points of view. The deformation turns the parameters in the character into non-commutative operators so that the characters themselves generate a nontrivial algebra — the (q, t) -deformed W -algebra, $W_{q,t}(\mathfrak{g})$.

It would be desirable to have an R -matrix construction of qq -characters similar to that of q -characters. Some attempts along these lines have been made in [13], but that paper dealt exclusively with a specific (and complicated) case of $\mathfrak{g} = \widehat{\mathfrak{gl}}_1$. In the current paper we propose a more general R -matrix formalism for qq -characters, which to our knowledge has not been suggested previously.

There are some parallels between our formalism and that for q -characters: we also use an R -matrix as a central tool. However, the details differ a lot. Firstly, we use one and the same “master” R -matrix to obtain all the qq -characters for the root systems $\mathfrak{g} = A_n$. The R -matrix is that of the Ding-Iohara-Miki (DIM) [14] or quantum toroidal algebra $\mathcal{A} = U_{q,t}(\widehat{\mathfrak{gl}}_1)$. In this sense both the root system \mathfrak{g} and the representation featuring in the qq -character are free parameters that can be varied in our approach without changing the underlying algebraic structure.

The second important difference between our formalism and [11] is that we don’t take a trace of our R -matrix, but instead a (partial) matrix element thereof. The states in the matrix element are what encodes the representation featuring in the qq -character.

The technical framework that we employ to derive the expressions for qq -characters is refined topological string. This allows us to interpret various algebraic expressions as refined amplitudes on certain toric Calabi-Yau (CY) three-folds. In fact the toric diagram of the three-fold can be viewed as a lattice statistical model [15] with crossings corresponding to DIM R -matrices [16].

Let us note that ours is not the first attempt to obtain qq -characters in the refined topological string framework. In [17] (see also [18]) qq -characters were identified with specific generators of the algebra \mathcal{A} inserted between combinations of refined topological vertices. However, the generators were not viewed as coming from an R -matrix. In [19] qq -characters were engineered by certain linear combinations of Lagrangian brane insertions, but no algebraic interpretation was given. In contrast, in the present paper we provide an explicit algorithm to draw a toric diagram whose refined partition function produces a given qq -character.

In the remaining part of the introduction we recall briefly the R -matrix construction of q -characters of quantum affine Lie algebras [11] (sec. 1.1), and then introduce the general idea of our approach to qq -characters and their connection with Type IIB 5-branes and refined topological strings (sec. 1.2). In this way we demonstrate both the similarities as well as differences between the two approaches before delving into full technical description.

The rest of the paper is organized as follows. In sec. 2 we introduce the DIM R -matrix which can be interpreted as a spectator brane insertion. In sec. 3 we show how the R -matrix formulas give rise to the coproduct of the generating current of the DIM algebra and match it with some previous works on the relation between DIM algebra and qq -characters. In sec. 4 we show how qq -characters are obtained from the R -matrix insertion using Wick's theorem. We apply our formalism to fundamental A_n type qq -characters in sec. 5 and to higher representations of A_n in sec. 6. In sec. 7 we consider the uplift of the formalism to elliptic A_n qq -characters. We present our conclusions in sec. 8.

1.1 q -characters and quantum affine algebras

q -characters are partial traces of an R -matrix. Let us be more precise. We consider finite-dimensional representations of quantum affine algebra $U_q(\widehat{\mathfrak{g}})$. They have trivial central charges. The universal R -matrix $\mathcal{R} \in U_q(\widehat{\mathfrak{g}}) \otimes U_q(\widehat{\mathfrak{g}})$ has the schematic form [20]

$$\mathcal{R} \sim \mathcal{R}_+ \mathcal{R}_0 \mathcal{R}_-, \quad (1)$$

where the parts \mathcal{R}_\pm will be irrelevant for us. The ‘‘diagonal’’ part \mathcal{R}_0 has the form¹

$$\mathcal{R}_0 = \exp \left[\sum_{n \geq 1} \sum_{i \in I} h_{i,n} \otimes \tilde{h}_{i,-n} \right], \quad (2)$$

where the index $i \in I$ runs over the set of simple roots of \mathfrak{g} and $h_{i,n}$ and $\tilde{h}_{i,-n}$ are certain special bases in the commutative subalgebra $U_q(\widehat{\mathfrak{h}}) \subset U_q(\widehat{\mathfrak{g}})$. The q -character of a representation V has the schematic form (we gloss over some technical details such as prefactors)

$$\chi_q(V) \sim P(\mathrm{tr}_V \otimes 1) \mathcal{R} \sim (\mathrm{tr}_V \otimes 1) \mathcal{R}_0, \quad (3)$$

where P is a certain projection operator whose job is effectively to eliminate \mathcal{R}_\pm factors. The untraced generators $h_{i,n}$ commute and can be viewed as parameters of the q -character.

A more compact way to pack the parameters is to introduce their generating functions $Y_{i,a}$ (where $a \in \mathbb{C}^\times$), which look like

$$Y_{i,a} \sim \exp \left(\sum_{n \geq 1} a^n \tilde{h}_{n,i} \right). \quad (4)$$

Since $h_{i,n}$ form a commuting set of operators, they can be simultaneously diagonalized and one can study their joint eigenspectra. The theorem proven in [11] is that in finite-dimensional representations of $U_q(\widehat{\mathfrak{g}})$ the eigenvalues have the form

$$h_{i,n}|v\rangle \sim \left[\sum_{r=1}^{k_i} a_{i,r}^n - \sum_{s=1}^{l_i} b_{i,s}^n \right] |v\rangle, \quad (5)$$

where $a_{i,r}$, $b_{i,s}$ are complex numbers and k_i , l_i are finite integers. Moreover, for the highest weight vector there are no $b_{i,s}$'s, i.e. $l_i = 0$.

Plugging Eq. (5) into Eq. (3) and comparing with Eq. (4) we find that the q -character is a Laurent polynomial in $Y_{i,a}$, and that the highest weight of a finite-dimensional representation corresponds to a monomial with only positive powers of $Y_{i,a}$:

$$\chi_q(V) = \sum_{|v\rangle \in V} c_v \prod_{i,r} Y_{i_r, a_r} \prod_{j,s} Y_{j_s, b_s}^{-1} = \prod_{i,r} Y_{i_r, a_r} + \dots \quad (6)$$

¹In order to eliminate cumbersome coefficients in the formulas we use the normalization of the generators which differs from the more standard one from [11].

Properties of the R -matrix guarantee that q -characters are additive and multiplicative. The definition (3) of the character can be drawn as a picture:

$$\chi_q(V) = \begin{array}{c} V \\ \text{---} \mathcal{R}_0 \text{---} \\ \text{---} \end{array} \quad (7)$$

In Eq. (7) the square on the intersection of the blue and black lines represents the R -matrix of $U_q(\widehat{\mathfrak{g}})$, the blue line is the representation V over which one takes a trace, and the horizontal black line is the space in which the commuting $Y_{i,a}$ operators act.

1.2 qq -characters and DIM algebra

In qq -characters the $Y_{a,i}$ operators are no longer commuting. Instead they become vertex operators acting on (a tensor power of) the Fock space, the Hilbert space of a free boson.

To engineer a qq -character we start with the universal R -matrix of the DIM algebra and evaluate it in the tensor product of the vertical and horizontal Fock spaces, which we denote by $\mathcal{F}_{q,t^{-1}}^{(0,1)}(w)$ and $\mathcal{F}_{q,t^{-1}}^{(1,0)}(u)$ respectively (see Appendix A for the definitions of the algebra and representations). The R -matrix turns out to be equal to the refined topological string amplitude on degenerate resolved conifold [16]:

$$\mathcal{R}|_{\mathcal{F}_{q,t^{-1}}^{(0,1)}(w) \otimes \mathcal{F}_{q,t^{-1}}^{(1,0)}(u)} = \begin{array}{c} \downarrow w \\ \sqrt{\frac{q}{t}}u \leftarrow \text{---} \text{---} u \\ \downarrow \sqrt{\frac{t}{q}}w \end{array} = \begin{array}{c} \mathcal{F}_{q,t^{-1}}^{(0,1)}(w) \\ \downarrow \\ \begin{array}{c} \swarrow \mathcal{F}_{q,t^{-1}}^{(1,0)}(u) \\ \leftarrow \mathcal{F}_{q,t^{-1}}^{(1,1)}(-uw) \\ \downarrow \mathcal{F}_{q,t^{-1}}^{(0,1)}\left(\sqrt{\frac{t}{q}}w\right) \end{array} \end{array} \quad (8)$$

The lines in Eq. (8) have two different physical interpretations related by dualities in string theory.

1. The lines may be viewed as forming a toric diagram of a toric Calabi-Yau (CY) three-fold, on which refined topological strings propagate. For example the second picture in Eq. (8) represents the resolved conifold (the total space of the bundle $\mathcal{O}(-1) \oplus \mathcal{O}(-1) \rightarrow \mathbb{P}^1$). The Fock space associated with a leg of the diagram is the space of states of refined topological string wrapping the corresponding two-cycle inside the CY. Triple junctions in the picture are refined topological vertices [21]. The lines passing on top of each other without intersecting as in the first picture in Eq. (8) correspond to deformed conifold geometry. The second equality in Eq. (8) expresses the geometric transition between deformed and resolved conifold in refined topological string theory [22].
2. Alternatively, the lines may be thought of as (p, q) 5-branes in Type IIB string theory on a flat background². In this interpretation the Fock space on a leg of the diagram is the Hilbert spaces of BPS states bound to the corresponding 5-brane. The triple junctions in the picture are junctions of 5-branes. Two lines passing on top of each other without intersecting are simply branes lying in different two-dimensional planes. In gauge theories living on the worldvolumes of the branes this corresponds to passing to the Higgs branch.

We will use the terms lines and branes interchangeably henceforth.

Degenerate crossing Eq. (8) has special properties. Specifically, its matrix elements along the vertical

²The equivalence between these two interpretations is shown in [23].

Fock representation satisfy the following selection rule:

$$\boxed{
 \begin{array}{c}
 \downarrow |w, \lambda\rangle \\
 \sqrt{\frac{q}{t}} u \leftarrow \leftarrow u \\
 \downarrow |\sqrt{\frac{t}{q}} w, \mu\rangle
 \end{array}
 = 0 \text{ if } \mu \not\subseteq \lambda,
 } \tag{9}$$

where λ and μ are Young diagrams labelling the states in the Fock space.

To get the qq -characters of A_{n-1} type corresponding to the first fundamental representation $V_{\omega_1} \simeq \mathbb{C}^n$ we draw the toric diagram involving n horizontal lines and a vertical “spectator” brane crossing the horizontal lines. The external states on the vertical line are $|\square\rangle$ and $|\emptyset\rangle$. For example for $n = 3$:

$$\chi_{qq}^{A_2}(\mathbb{C}^3) =
 \begin{array}{c}
 \square \\
 \downarrow \\
 \leftarrow \leftarrow \leftarrow \\
 \downarrow \lambda \\
 \leftarrow \leftarrow \leftarrow \\
 \downarrow \mu \\
 \leftarrow \leftarrow \leftarrow \\
 \downarrow \emptyset
 \end{array}
 . \tag{10}$$

The external states are indicated above and below the vertical spectator brane. Every crossing in Eq. (10) is an R -matrix insertion and a sum over intermediate states λ and μ is assumed. According to the selection rule Eq. (9) there are only three possibilities for λ and μ , namely $(\lambda, \mu) = (\emptyset, \emptyset)$, (\square, \emptyset) , and (\square, \square) . As we will see in sec. 4 each of these possibilities produces a distinct combination of Y -operators acting in the tensor product of three horizontal Fock spaces. The resulting three terms reproduce the qq -character of the defining representation \mathbb{C}^3 of A_2 .

To get qq -characters corresponding to higher representations one needs to insert several spectator branes. We explain the procedure in detail in sec. 6.

Notice how our approach is similar in spirit (the main object is the R -matrix), but also markedly different from sec. 1.1:

1. The R -matrices belong to a larger algebra (DIM) with two quantum deformation parameters instead of one.
2. The same R -matrix is used to build the qq -characters of all A_n types³.
3. Instead of a trace one needs to take a matrix element of the R -matrix.
4. The representations of quantum affine Lie algebras are encoded in the external states living in the vertical Fock representations of DIM.

One could insert the spectator brane (10) into a given toric diagram to get an average of the corresponding qq -character. Some toric diagrams correspond to $5d \mathcal{N} = 1$ supersymmetric gauge theories, in which the qq -characters form a special class of observables called \mathcal{X} -observables as explained in [24]. For example, the diagram



$$\tag{11}$$

³We expect that all classical and affine series can in fact be treated in our framework.

corresponds to a pure $SU(2)$ gauge theory. Due to the properties of the R -matrix, the spectator brane can be inserted anywhere in the picture, for example

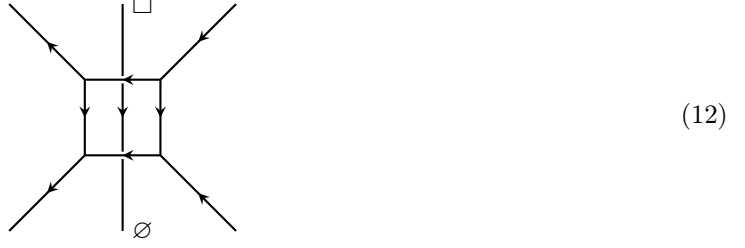

We will demonstrate the appearance of the \mathcal{X} -observables from pictures such as Eq. (12) in sec. 4.

2 DIM R -matrices as brane crossings

In this section we give a more technical description of DIM R -matrices and provide an explicit formula for the crossing operator introduced in Eq. (8). According to [16], the R -matrix for the tensor product of vertical and horizontal Fock spaces can be written as a composition of two intertwining operators, or refined topological vertices (see Appendix A for definitions of the Fock representations).

The formulas for the intertwiners were obtained in [25]. Up to prefactors they are given by the following vertex operators (see Eqs. (138), (139) in Appendix C for complete expressions):

$$\Psi^\lambda(x) = \begin{array}{c} \lambda \downarrow \mathcal{F}_{q,t^{-1}}^{(0,1)}(x) \\ \swarrow \mathcal{F}_{q,t^{-1}}^{(1,N+1)}(-ux) \quad \nwarrow \mathcal{F}_{q,t^{-1}}^{(1,N)}(u) \end{array} \sim : \exp \left[\sum_{n \neq 0} \frac{x^{-n}}{n} \left(\frac{1}{1-q^{-n}} - (1-t^n) \text{Ch}_\lambda(q^{-n}, t^{-n}) \right) a_n \right] :, \quad (13)$$

$$\Psi_\mu^*(y) = \begin{array}{c} \mathcal{F}_{q,t^{-1}}^{(1,N+1)}(u) \swarrow \\ \mathcal{F}_{q,t^{-1}}^{(1,N)}(-u/y) \leftarrow \quad \rightarrow \mathcal{F}_{q,t^{-1}}^{(0,1)}(y) \downarrow \mu \end{array} \sim : \exp \left[- \sum_{n \neq 0} \frac{y^{-n}}{n} \left(\frac{t}{q} \right)^{\frac{|n|}{2}} \left(\frac{1}{1-q^{-n}} - (1-t^n) \text{Ch}_\mu(q^{-n}, t^{-n}) \right) a_n \right] :, \quad (14)$$

where

$$\text{Ch}_\lambda(q, t) = \sum_{(i,j) \in \lambda} q^{j-1} t^{1-i}, \quad (15)$$

and the free boson modes a_n satisfy the (q, t) -deformed Heisenberg commutation relations:

$$[a_n, a_m] = n \frac{1 - q^{|n|}}{1 - t|n|} \delta_{n+m, 0}. \quad (16)$$

Combining the intertwiners Eqs. (13), (14) as drawn in Eq. (8) we get the (the matrix element of) the

R -matrix [26]:

$$\begin{aligned}
\mathcal{R}_\mu^\lambda(w, u, N) &\stackrel{\text{def}}{=} \Psi^\lambda(w) \Psi_\mu \left(\sqrt{\frac{t}{q}} w \right) = \mathcal{F}_{q, t^{-1}}^{(1, N)}(\sqrt{\frac{q}{t}} u) \begin{array}{c} \downarrow |w, \lambda\rangle \\ \leftarrow \text{---} \\ \downarrow \left| \sqrt{\frac{t}{q}} w, \mu \right\rangle \end{array} \mathcal{F}_{q, t^{-1}}^{(1, N)}(u) \\
&= (-w)^{-N|\lambda|} u^{|\lambda|} \left(-\sqrt{\frac{t}{q}} w \right)^{N|\mu|} \left(\frac{q}{u} \sqrt{\frac{t}{q}} \right)^{|\mu|} N_{\lambda\mu} \left(\frac{q}{t} \right) \frac{q^{n(\lambda^T) + n(\mu^T)}}{f_\lambda c_\lambda c_\mu} \left(\frac{f_\mu}{f_\lambda} \right)^N \\
&\quad \times \exp \left[- \sum_{n \geq 1} \frac{w^n (1 - (t/q)^n)}{n (1 - q^n)} a_{-n} \right] \times \\
&\quad \times \exp \left[- \sum_{n \neq 0} \frac{(1 - t^n)}{n} \left(\text{Ch}_\lambda(q^{-n}, t^{-n}) - \left(\frac{t}{q} \right)^{\frac{|n| - n}{2}} \text{Ch}_\mu(q^{-n}, t^{-n}) \right) w^{-n} a_n \right]: \quad (17)
\end{aligned}$$

where $N_{\lambda\mu}(x)$ is given by Eq. (131) and

$$n(\lambda^T) = \sum_{(i,j) \in \lambda} (j-1), \quad (18)$$

$$c_\lambda = \prod_{(i,j) \in \lambda} \left(1 - q^{\lambda_i - j} t^{\lambda_j^T - i + 1} \right), \quad (19)$$

$$f_\lambda = \prod_{(i,j) \in \lambda} \left(-q^{j - \frac{1}{2}} t^{\frac{1}{2} - i} \right) = (-1)^{|\lambda|} q^{\frac{\|\lambda\|^2}{2}} t^{-\frac{\|\lambda^T\|^2}{2}} = (-1)^{|\lambda|} q^{n(\lambda^T) + |\lambda|/2} t^{-n(\lambda) - |\lambda|/2}, \quad (20)$$

$$\|\lambda\|^2 = \sum_{i=1}^{l(\lambda)} \lambda_i^2 = \sum_{(i,j) \in \lambda} (2j-1) = 2n(\lambda^T) + |\lambda|. \quad (21)$$

Several remarks are in order:

1. Eq. (17) is a generalization of Eq. (8) in which the horizontal line ((1, 0) Fock representation in Eq. (8)) has a nontrivial slope (1, N), $N \in \mathbb{Z}$.
2. DIM algebra has an infinite number of inequivalent coproducts $\Delta^{(s)}$ labelled by an irrational slope s in the \mathbb{Z}^2 lattice. Each of the coproducts gives rise to its own set of intertwining operators and R -matrices. In all of the formulas in this paper the choice of DIM coproduct (also known as the preferred direction in refined topological strings) is understood to be vertical, $s = \infty$.
3. The exponent in the third line of Eq. (17) was obtained in [16] as the *vacuum* matrix element of the R -matrix. The rest of the formula is responsible for its generalization to arbitrary states on the vertical brane.
4. \mathcal{R}_μ^λ satisfies the selection rule (9) due to the vanishing of the Nekrasov factor $N_{\lambda\mu}(q/t)$ in the second line of Eq. (17).
5. The additional terms that appear in \mathcal{R}_μ^λ for nontrivial λ and μ have the form of a product of vertex operators sitting at points corresponding to boxes of λ and μ , respectively.
6. We will sometimes omit the u and N arguments in $\mathcal{R}_\mu^\lambda(w, u, N)$ when there is no possibility for confusion.

The operator \mathcal{R}_μ^λ looks complicated, however in our present study we will need to evaluate it only for λ, μ equal to \square or \emptyset . Due to the selection rule Eq. (9) there are three cases of this type:

1. $\lambda = \emptyset, \mu = \emptyset$:

$$\mathcal{R}_{\emptyset}^{\emptyset}(w, u, N) = \exp \left[- \sum_{n \geq 1} \frac{w^n (1 - (t/q)^n)}{n (1 - q^n)} a_{-n} \right] \quad (22)$$

It is important that the exponent in Eq. (22) contains only negative bosonic modes, so it acts trivially on the bra vacuum state $\langle \emptyset |$.

2. $\lambda = \square, \mu = \emptyset$:

$$\mathcal{R}_{\square}^{\emptyset}(w, u, N) = - \sqrt{\frac{t}{q}} \frac{1 - \frac{q}{t}}{1 - t} \mathcal{R}_{\emptyset}^{\emptyset}(w, u, N) x^+(w) |_{\mathcal{F}(1, N)(u)}, \quad (23)$$

where $x^+(w) |_{\mathcal{F}(1, N)(u)}$ is the generating current of the DIM algebra in the $(1, N)$ Fock representation given by Eq. (114) in Appendix A. Notice that the product $\mathcal{R}_{\emptyset}^{\emptyset}(w) x^+(w)$ is automatically normal ordered. We will use this fact when we compute correlators in sec. 4.

3. $\lambda = \square, \mu = \square$:

$$\mathcal{R}_{\square}^{\square}(w, u, N) = \frac{1 - q}{1 - t} \psi^- \left((t/q)^{\frac{1}{4}} w \right) |_{\mathcal{F}(1, N)(u)} \mathcal{R}_{\emptyset}^{\emptyset}(w, u, N), \quad (24)$$

where $\psi^-(w)$ is another generating current of the DIM algebra given by Eq. (117) in Appendix A. The product in Eq. (24) is also automatically normal ordered.

Having the basic ingredients — the crossings (22), (23) and (24) — we can proceed to combine them. Naturally, there are two ways:

1. One can stack crossings on top of each other, so that a single vertical line crosses a number of horizontal ones. This will produce the qq -characters of the first fundamental representation \mathbb{C}^n of A_{n-1} which we investigate in sec. 3.
2. The crossings can be joined along the horizontal legs. This will produce qq -characters of higher representations as described in sec. 6.

3 DIM coproduct and fundamental qq -characters from brane crossings

Consider a vertical spectator brane intersecting n horizontal ones as shown in Eq. (10) with external state $|\square\rangle$ on top and $\langle \emptyset |$ at the bottom. Every brane intersection gives rise to the R -matrix operator Eq. (17). We claim that such an intersection produces the qq -character of the defining representation \mathbb{C}^n of A_{n-1} algebra.

To simplify our presentation in this section we restrict ourselves to the case when the branes intersecting the vertical brane are strictly horizontal, i.e. correspond to Fock representations of type $(1, 0)$. However, the same arguments work for $(1, N)$ lines too. Let us follow the example of Eq. (10), where there are three horizontal lines and two diagrams on the intermediate edges λ and μ .

As we have mentioned in sec. 1.2, selection rules severely restrict the set of Young diagrams on the intermediate vertical edges. There are three possible pairs (λ, μ) contributing to the answer. Let us write down the operators corresponding to each of these pairs:

1. $(\lambda, \mu) = (\emptyset, \emptyset)$:

$$\begin{array}{c}
 w \downarrow \square \\
 \hline
 \leftarrow u_1 \\
 \sqrt{\frac{t}{q}} w \downarrow \emptyset \\
 \hline
 \leftarrow u_2 \\
 \frac{t}{q} w \downarrow \emptyset \\
 \hline
 \leftarrow u_3 \\
 \hline
 \left(\frac{t}{q} \right)^{3/2} w \downarrow \emptyset
 \end{array}
 =
 \mathcal{R}_{\square}^{\square}(w, u_1, 0) \otimes \mathcal{R}_{\emptyset}^{\emptyset} \left(\sqrt{\frac{t}{q}} w, u_2, 0 \right) \otimes \mathcal{R}_{\emptyset}^{\emptyset} \left(\frac{t}{q} w, u_1, 0 \right) \quad (25)$$

which can alternatively be expressed using Eq. (23) as

$$\begin{aligned}
& -\sqrt{\frac{t}{q}} \frac{1-\frac{q}{t}}{1-t} \mathcal{R}_{\emptyset}^{\emptyset}(w, u_1, 0) \otimes \mathcal{R}_{\emptyset}^{\emptyset} \left(\sqrt{\frac{t}{q}} w, u_2, 0 \right) \otimes \mathcal{R}_{\emptyset}^{\emptyset} \left(\frac{t}{q} w, u_1, 0 \right) (x^+(w)|_{\mathcal{F}(u_1)} \otimes 1 \otimes 1) = \\
& = \mathcal{T}_{\emptyset}^{\emptyset}(w) (x^+(w)|_{\mathcal{F}(u_1)} \otimes 1 \otimes 1) = u_1 \mathcal{T}_{\emptyset}^{\emptyset}(w) : \exp \left[- \sum_{n \neq 0} \frac{1-t^n}{n} w^{-n} a_n^{(1)} \right] :, \quad (26)
\end{aligned}$$

where $a_n^{(i)}$, $i = 1, 2, 3$ are three sets of bosonic operators acting on three horizontal lines and the operator $x^+(w)$ is defined in Eq. (114). The ‘‘empty crossing’’ part is given by

$$\mathcal{T}_{\emptyset}^{\emptyset}(w) = -\sqrt{\frac{t}{q}} \frac{1-\frac{q}{t}}{1-t} \exp \left[- \sum_{n \geq 1} \frac{w^n}{n} \frac{1-(t/q)^n}{1-q^n} \bar{a}_{-n} \right]. \quad (27)$$

where we have defined the ‘‘diagonal part’’ of the bosonic modes

$$\bar{a}_{-n} = a_{-n}^{(1)} + \left(\frac{t}{q} \right)^{\frac{n}{2}} a_{-n}^{(2)} + \left(\frac{t}{q} \right)^n a_{-n}^{(3)}. \quad (28)$$

Notice that $\mathcal{T}_{\emptyset}^{\emptyset}(w)$ has a natural algebraic meaning of its own: it corresponds to the crossing with a vertical spectator brane, but with empty external states on it. In that case the selection rule (9) dictates that the Young diagrams on the intermediate edges should all be empty. Therefore the operator $\mathcal{T}_{\emptyset}^{\emptyset}(w)$ factorizes into a product of operators each acting on its own horizontal brane (see sec. 4.3 of [16]).

2. $(\lambda, \mu) = (\square, \emptyset)$:

$$\begin{array}{c}
\begin{array}{c}
w \downarrow \square \\
\hline
\leftarrow u_1 \\
\sqrt{\frac{t}{q}} w \downarrow \square \\
\hline
\leftarrow u_2 \\
\frac{t}{q} w \downarrow \emptyset \\
\hline
\leftarrow u_3 \\
\hline
\left(\frac{t}{q} \right)^{3/2} w \downarrow \emptyset
\end{array}
= b_{\square}(q, t) \mathcal{R}_{\square}^{\square}(w, u_1, 0) \otimes \mathcal{R}_{\emptyset}^{\square} \left(\sqrt{\frac{t}{q}} w, u_2, 0 \right) \otimes \mathcal{R}_{\emptyset}^{\emptyset} \left(\frac{t}{q} w, u_1, 0 \right), \quad (29)
\end{array}$$

which can be similarly expressed in terms of the operator $\mathcal{T}_{\emptyset}^{\emptyset}(w)$ and another operator acting on the tensor product of three horizontal Fock spaces,

$$\begin{aligned}
\text{Eq. (29)} & = b_{\square}(q, t) \mathcal{T}_{\emptyset}^{\emptyset}(w) \left(\psi^- \left((t/q)^{\frac{1}{4}} w \right) \Big|_{\mathcal{F}^{(1,0)}(u_1)} \otimes x^+ \left(\sqrt{\frac{t}{q}} w \right) \Big|_{\mathcal{F}^{(1,0)}(u_2)} \otimes 1 \right) = \\
& = b_{\square}(q, t) u_2 \mathcal{T}_{\emptyset}^{\emptyset}(w) : \exp \left[\sum_{n \geq 1} \frac{1-t^{-n}}{n} \left(1 - \left(\frac{t}{q} \right)^n \right) w^n a_{-n}^{(1)} - \sum_{n \neq 0} \frac{1-t^n}{n} w^{-n} \left(\frac{q}{t} \right)^{\frac{n}{2}} a_n^{(2)} \right] :, \quad (30)
\end{aligned}$$

where

$$b_{\mu}(q, t) = \langle P_{\mu} | P_{\mu} \rangle^{-1} = \prod_{(i,j) \in \lambda} \frac{1 - q^{\lambda_i - j} t^{\lambda_j^T - i + 1}}{1 - q^{\lambda_i - j + 1} t^{\lambda_j^T - i}} = \frac{c_{\lambda}}{c'_{\lambda}} \quad (31)$$

is the inverse of the norm of Macdonald polynomial corresponding to the intermediate state on the vertical brane ($b_{\square} = \frac{1-t}{1-q}$) and $\psi^-(w)$ is defined in Eq. (117).

3. $(\lambda, \mu) = (\square, \square)$:

$$\begin{array}{c}
w \downarrow \square \\
\leftarrow u_1 \\
\sqrt{\frac{t}{q}} w \downarrow \square \\
\leftarrow u_2 \\
\frac{t}{q} w \downarrow \square \\
\leftarrow u_3 \\
\left(\frac{t}{q}\right)^{3/2} w \downarrow \emptyset
\end{array}
= b_{\square}(q, t)^2 \mathcal{R}_{\square}(w, u_1, 0) \otimes \mathcal{R}_{\square}\left(\sqrt{\frac{t}{q}} w, u_2, 0\right) \otimes \mathcal{R}_{\emptyset}\left(\frac{t}{q} w, u_1, 0\right), \quad (32)$$

which can be rewritten as

$$\begin{aligned}
& b_{\square}^2 \mathcal{T}_{\emptyset}^{\square}(w) \left(\psi^{-}\left((t/q)^{\frac{1}{4}} w\right) \Big|_{\mathcal{F}^{(1,0)}(u_1)} \otimes \psi^{-}\left((t/q)^{\frac{3}{4}} w\right) \Big|_{\mathcal{F}^{(1,0)}(u_2)} \otimes x^{+}\left(\frac{t}{q} w\right) \Big|_{\mathcal{F}^{(1,0)}(u_3)} \right) = \\
& = b_{\square}^2 u_3 \mathcal{T}_{\emptyset}^{\square}(w) : \exp \left[\sum_{n \geq 1} \frac{1-t^{-n}}{n} \left(1 - \left(\frac{t}{q}\right)^n\right) w^n \left(a_{-n}^{(1)} + \left(\frac{t}{q}\right)^{\frac{n}{2}} a_{-n}^{(2)} \right) - \sum_{n \neq 0} \frac{1-t^n}{n} w^{-n} \left(\frac{q}{t}\right)^n a_n^{(3)} \right] : . \quad (33)
\end{aligned}$$

Collecting the terms for each pair of intermediate diagrams (λ, μ) we get the following result for the crossing:

$$\begin{array}{c}
w \downarrow \square \\
\leftarrow u_1 \\
\sqrt{\frac{t}{q}} w \downarrow \lambda \\
\leftarrow u_2 \\
\frac{t}{q} w \downarrow \mu \\
\leftarrow u_3 \\
\left(\frac{t}{q}\right)^{3/2} w \downarrow \emptyset
\end{array}
= \mathcal{T}_{\emptyset}^{\square}(w) \left\{ x^{+}(w) \Big|_{\mathcal{F}(u_1)} \otimes 1 \otimes 1 + \right. \\
+ \psi^{-}\left((t/q)^{\frac{1}{4}} w\right) \Big|_{\mathcal{F}^{(1,0)}(u_1)} \otimes x^{+}\left(\sqrt{\frac{t}{q}} w\right) \Big|_{\mathcal{F}^{(1,0)}(u_2)} \otimes 1 + \\
\left. + \psi^{-}\left((t/q)^{\frac{1}{4}} w\right) \Big|_{\mathcal{F}^{(1,0)}(u_1)} \otimes \psi^{-}\left((t/q)^{\frac{3}{4}} w\right) \Big|_{\mathcal{F}^{(1,0)}(u_2)} \otimes x^{+}\left(\frac{t}{q} w\right) \Big|_{\mathcal{F}^{(1,0)}(u_3)} \right\} = \\
= \boxed{\mathcal{T}_{\emptyset}^{\square}(w) (\Delta \otimes 1) \Delta(x^{+}(w)) \Big|_{\mathcal{F}^{(1,0)}(u_1) \otimes \mathcal{F}^{(1,0)}(u_2) \otimes \mathcal{F}^{(1,0)}(u_3)}} \quad (34)$$

where in the last line we have used the formula for the coproduct of the generating current $x^{+}(w)$ which can be found in Eq. (107) in Appendix A.

At this point we would like to use some of the results of [17] summarized in Appendix A. It was shown there that the insertion of the current $x^{+}(w)$ of the algebra \mathcal{A} acting in the tensor product of m horizontal Fock representations $\mathcal{F}_{q,t^{-1}}^{(1,0)}(u_i)$ generates the fundamental qq -character of A_{m-1} type. In Eq. (34) we get almost the same result from the vertical brane insertion, but with an additional operator $\mathcal{T}_{\emptyset}^{\square}(w)$. This factor, however, will not affect most of the formulas that we get for the following reason. We will consider the insertion of the R -matrix/ qq -character into some ‘‘background’’ network of intertwining operators (refined topological vertices). As we will see in sec. 4 the extra operator $\mathcal{T}_{\emptyset}^{\square}(w)$ has very simple commutation relations with refined topological vertices placed elsewhere in the diagram. This will allow

us to effectively get rid of it in any given qq -character calculation by moving $\mathcal{T}_\emptyset^\emptyset(w)$ to the very left of the diagram, where it annihilates the bra vacuum state. Thus, we will dismiss the $\mathcal{T}_\emptyset^\emptyset(w)$ in most of the formulas.

To understand why the coproduct $(\Delta \otimes 1)\Delta(x^+(w))$ appears in Eq. (34) we have to recall the Khoroshkin-Tolstoy formula [20] for the universal \mathcal{R} -matrix. The formula has the form:

$$\mathcal{R} = P\mathcal{R}_0\mathcal{R}_1\mathcal{R}_2, \quad (35)$$

where P is the permutation operator exchanging the two factors in the tensor product. The other three factors are

$$\mathcal{R}_0 = e^{-c_1 \otimes d_1 - d_1 \otimes c_1 - c_2 \otimes d_2 - d_2 \otimes c_2}, \quad (36)$$

$$\mathcal{R}_1 = \exp \left[- \sum_{n \geq 1} \frac{\kappa_n}{n} e_{(0,n)} \otimes e_{(0,-n)} \right], \quad (37)$$

$$\mathcal{R}_2 = 1 + \kappa_1 \oint \frac{dz}{z} x^-(z) \otimes x^+(z) + \dots \quad (38)$$

Let us explain the notations in Eqs. (36)–(38) (see Appendix A for basic definitions related to the DIM algebra):

1. $e_{(n,m)}$ are generators of the DIM algebra,
2. c_1, c_2 are the two central charges of the algebra,
3. d_1, d_2 are the grading operators,
4. $\kappa_n = (1 - q^n)(1 - t^{-n})(1 - (t/q)^n)$,
5. $x^\pm(z) = \sum_{n \in \mathbb{Z}} e_{(\pm 1, n)} z^{\mp n}$ are DIM generating currents.
6. In Eq. (38) the terms replaced by the ellipsis involve DIM generators $e_{(n,m)}$ with $|n| \geq 2$. As we will see momentarily these terms will not contribute to the crossing operator (34) and therefore to the qq -character.

The universal R -matrix (35) satisfies the fundamental identity

$$(\Delta \otimes 1)\mathcal{R} = \mathcal{R}_{12}\mathcal{R}_{13}, \quad (39)$$

where Δ is the coproduct given by Eqs. (109)–(111) and \mathcal{R}_{12} (resp. \mathcal{R}_{13}) represents \mathcal{R} acting on the first two (res. first and third) factors in the triple tensor product.

It is the property in Eq. (39) that explains the appearance of the coproduct of $x^+(w)$ in Eq. (34). Indeed, consider \mathcal{R} acting in the tensor product of two representations: one is a vertical Fock space $\mathcal{F}_{q,t^{-1}}^{(0,1)}(w)$ and the other is itself a tensor product of three horizontal Fock spaces $\mathcal{F}_{q,t^{-1}}^{(1,0)}(u_1) \otimes \mathcal{F}_{q,t^{-1}}^{(1,0)}(u_2) \otimes \mathcal{F}_{q,t^{-1}}^{(1,0)}(u_3)$ (see Appendix A for the definitions of the relevant Fock representations). Due to the identity (39) the R -matrix acting on the tensor product is

$$\begin{aligned} (1 \otimes 1 \otimes \Delta)(1 \otimes \Delta)\mathcal{R}|_{\mathcal{F}^{(0,1)}(w) \otimes \mathcal{F}^{(1,0)}(u_1) \otimes \mathcal{F}^{(1,0)}(u_2) \otimes \mathcal{F}^{(1,0)}(u_3)} = \\ = \mathcal{R}|_{\mathcal{F}^{(0,1)}(w) \otimes \mathcal{F}^{(1,0)}(u_1)} \mathcal{R}|_{\mathcal{F}^{(0,1)}(\sqrt{t/q}w) \otimes \mathcal{F}^{(1,0)}(u_2)} \mathcal{R}|_{\mathcal{F}^{(0,1)}(t/qw) \otimes \mathcal{F}^{(1,0)}(u_3)}. \end{aligned} \quad (40)$$

Let us compute the matrix element of the two sides of Eq. (40) between the states $\langle \emptyset |$ and $|\square\rangle$ in the vertical Fock representation. The r.h.s. gives the diagram in Eq. (34) while the l.h.s. can be evaluated using the formulas (36)–(38):

$$\begin{aligned} \left(\dots \otimes \langle \emptyset, (t/q)^{3/4} w \right) (1 \otimes 1 \otimes \Delta)(1 \otimes \Delta)\mathcal{R}|_{\mathcal{F}^{(0,1)}(w) \otimes \mathcal{F}^{(1,0)}(u_1) \otimes \mathcal{F}^{(1,0)}(u_2) \otimes \mathcal{F}^{(1,0)}(u_3)} (|\square, w \rangle \otimes \dots) = \\ = \left(\dots \otimes \langle \emptyset, (t/q)^{3/4} w \right) (1 \otimes 1 \otimes \Delta)(1 \otimes \Delta)(P\mathcal{R}_0\mathcal{R}_1) \times \\ \times (1 \otimes 1 \otimes \Delta)(1 \otimes \Delta)\mathcal{R}_2(|\square, w \rangle \otimes \dots). \end{aligned} \quad (41)$$

Using explicit formulas (109)–(113) for the coproduct and the Fock representations from Appendix A we find that the second line of Eq. (41) is given by

$$\left(\dots \otimes \left\langle \emptyset, (t/q)^{3/4} w \right| \right) (1 \otimes 1 \otimes \Delta)(1 \otimes \Delta)(P\mathcal{R}_0\mathcal{R}_1) = \mathcal{T}_{\emptyset}^{\emptyset}(w) \left(\langle \emptyset, w | \otimes \dots \right). \quad (42)$$

Notice that the product $P\mathcal{R}_0\mathcal{R}_1$ acts diagonally on the state with empty Young diagram on the vertical line, but exchanges the two tensor factors (due to P operator) and shifts the spectral parameter of the representation from $w(t/q)^{3/4}$ to w (due to the \mathcal{R}_0 piece involving grading operators). What remains is to evaluate the third line of Eq. (41):

$$\begin{aligned} & (\langle \emptyset, w | \otimes \dots) \times (1 \otimes 1 \otimes \Delta)(1 \otimes \Delta)\mathcal{R}_2(|\square, w\rangle \otimes \dots) = \\ & = \kappa_1 \oint \frac{dz}{z} \langle \emptyset, w | x^-(z) |\square, w\rangle \otimes (1 \otimes \Delta)\Delta(x^+(z)) = -\frac{\kappa_1}{1-t} (1 \otimes \Delta)\Delta(x^+(w)), \end{aligned} \quad (43)$$

where we have used the explicit action of $x^-(z)$ in the vertical representation

$$x^-(z)|\square, w\rangle = -\frac{1}{1-t} \delta\left(\frac{w}{z}\right) |\emptyset, w\rangle \quad (44)$$

which follows from the definition (121). In the second line of Eq. (43) we have also used the fact that the identity term in the definition (38) of \mathcal{R}_2 does not contribute to the matrix element since it cannot turn $|\square\rangle$ into $|\emptyset\rangle$. A more nontrivial observation is that all the higher terms from Eq. (38) also don't contribute: they all subtract two or more boxes from the diagram $|\square\rangle$ so that it vanishes.

Collecting the terms from Eqs. (42) and (43) we find that

$$\begin{aligned} & \mathcal{R}|_{\mathcal{F}^{(0,1)}(w) \otimes \mathcal{F}^{(1,0)}(u_1)} \mathcal{R}|_{\mathcal{F}^{(0,1)}(\sqrt{t/qw}) \otimes \mathcal{F}^{(1,0)}(u_2)} \mathcal{R}|_{\mathcal{F}^{(0,1)}(t/qw) \otimes \mathcal{F}^{(1,0)}(u_3)} \sim \\ & \sim \mathcal{T}_{\emptyset}^{\emptyset}(w) (1 \otimes \Delta)\Delta(x^+(w)) \Big|_{\mathcal{F}^{(1,0)}(u_1) \otimes \mathcal{F}^{(1,0)}(u_2) \otimes \mathcal{F}^{(1,0)}(u_3)} \end{aligned} \quad (45)$$

This explains why we get the coproduct of the $x^+(w)$ current from the brane crossing (10) and ensures that the resulting operator is indeed the qq -character, or qW_m -algebra generator as shown in [17] (and recalled in Appendix A).

In the next section we will see that an insertion of the vertical brane (10) into a toric diagram corresponding to a gauge theory gives the Nekrasov formulas for the qq -characters.

4 Normal ordering and commutation relations

To connect with the works of Nekrasov on the gauge theory origin of qq -characters [24], we need to insert the qq -character operator into a toric diagram corresponding to a gauge theory. The resulting expressions will have the form of sums (averages) over Young diagrams, or instanton series with brane insertion producing an extra contribution to the measure.

Since the vertical brane insertion (10) is essentially a sum of several free field vertex operators, its contribution to a refined topological string partition function is easy to calculate using Wick's theorem. The expressions for the refined topological vertices in terms of free boson generators are written out in Eqs. (13), (14).

The normal ordering of $\mathcal{R}_{\mu}^{\lambda}(w)$ (Eq. (17)) with a product of n Ψ -type and m Ψ^* -type operators is given by:

1. $\lambda = \emptyset, \mu = \emptyset$:

$$\mathcal{R}_{\emptyset}^{\emptyset}(w) : \prod_{a=1}^n \Psi^{\lambda^{(a)}}(x_a) \prod_{b=1}^m \Psi_{\mu^{(b)}}^*(y_b) : = : \mathcal{R}_{\emptyset}^{\emptyset}(w) \prod_{a=1}^n \Psi^{\lambda^{(a)}}(x_a) \prod_{b=1}^m \Psi_{\mu^{(b)}}^*(y_b) : , \quad (46)$$

i.e. the normal ordering coefficient is trivial.

2. $\lambda = \square$, $\mu = \emptyset$:

$$\begin{aligned}
\mathcal{R}_{\emptyset}^{\square}(w) &: \prod_{a=1}^n \Psi^{\lambda^{(a)}}(x_a) \prod_{b=1}^m \Psi_{\mu^{(b)}}^*(y_b) : \\
&= \exp \left[\sum_{k \geq 1} \sum_{a=1}^n \frac{1}{k} \left(\frac{x_a}{w} \right)^k (1 - (1 - q^k)(1 - t^{-k}) \text{Ch}_{\lambda^{(a)}}(q^k, t^k)) \right. \\
&\quad \left. - \sum_{k \geq 1} \sum_{b=1}^m \frac{1}{k} \left(\sqrt{\frac{t}{q}} \frac{y_b}{w} \right)^k (1 - (1 - q^k)(1 - t^{-k}) \text{Ch}_{\mu^{(b)}}(q^k, t^k)) \right] : \mathcal{R}_{\emptyset}^{\square}(w) \prod_{a=1}^n \Psi^{\lambda^{(a)}}(x_a) \prod_{b=1}^m \Psi_{\mu^{(b)}}^*(y_b) : \\
&= \frac{Y_{\bar{\mu}}(\sqrt{\frac{q}{t}} w)}{Y_{\bar{\lambda}}(w)} : \mathcal{R}_{\emptyset}^{\square}(w) \prod_{a=1}^n \Psi^{\lambda^{(a)}}(x_a) \prod_{b=1}^m \Psi_{\mu^{(b)}}^*(y_b) : \tag{47}
\end{aligned}$$

with the so-called Y-functions defined as

$$\begin{aligned}
Y_{\bar{\lambda}}(w) &= \prod_{a=1}^n Y_{\lambda^{(a)}}(w) \stackrel{\text{def}}{=} \prod_{a=1}^n \left[\left(1 - \frac{x_a}{w} \right) \prod_{(i,j) \in \lambda^{(a)}} \frac{(1 - \frac{x_a}{w} q^j t^{1-i}) (1 - \frac{x_a}{w} q^{j-1} t^{-i})}{(1 - \frac{x_a}{w} q^j t^{-i}) (1 - \frac{x_a}{w} q^j t^{-i})} \right] = \\
&= \prod_{a=1}^n \frac{N_{\lambda^{(a)} \square}(v^2 \frac{x_a}{w})}{N_{\lambda^{(a)} \emptyset}(v^2 \frac{x_a}{w})} \tag{48}
\end{aligned}$$

where n (the number of Ψ or Ψ^* intertwiners on a given horizontal brane) corresponds to the rank of the gauge group $U(n)$ on a given node of the quiver theory and $N_{\lambda\mu}(x)$ is the Nekrasov factor given by Eq. (131). Y-functions (48) are natural observables in gauge theory [24].

3. $\lambda = \square$, $\mu = \square$:

$$\mathcal{R}_{\square}^{\square} : \prod_{a=1}^n \Psi^{\lambda^{(a)}}(x_a) \prod_{b=1}^m \Psi_{\mu^{(b)}}^*(y_b) := : \mathcal{R}_{\square}^{\square}(w) \prod_{a=1}^n \Psi^{\lambda^{(a)}}(x_a) \prod_{b=1}^m \Psi_{\mu^{(b)}}^*(y_b) : . \tag{49}$$

In this case again no normal ordering corrections are produced.

In Eqs. (46)–(48) the vertical brane insertion has been placed to the left of all the other vertices. However, we can also do a similar computation using Wick's theorem for the brane inserted at any other point in the “background” brane diagram. It would be more economical, however, to investigate directly the commutation relations of the vertical brane insertion of the form (10) with other vertical edges on a toric diagram.

The crucial observation [16] is that due to the properties of the R -matrix and the vertices, the vertical brane commutes with internal edges:

$$\tag{50}$$

This can also be verified by a direct computation which we perform in sec. 5.1.2.

Another consequence of the properties of the R -matrix is that the commutation of the vertical brane with external semi-infinite vertical legs of the diagram produce only an inessential prefactor which does not depend on the Young diagrams residing on the *internal* edges of the toric diagram.

In the next section we present the simplest example a qq -character computed using the operator formalism we have developed.

5 Fundamental qq -characters from the operator formalism and refined topological strings

In this section, we apply our operator formalism to explicitly calculate the qq -characters in different theories. We also do the same calculation in topological string theory using the formalism of refined vertex [21].

5.1 Fundamental qq -character of A_1 type

5.1.1 Operator formalism

The A_1 type qq -character can be obtained by inserting a vertical spectator brane into the brane diagram corresponding to the toric diagram of the local \mathbb{F}_0 or local \mathbb{F}_1 for gauge theory with Chern-Simons level 0 and 1, respectively. The calculation of the instanton partition function of the $U(2)$ theory using the intertwining operators are briefly sketched in Appendix C for both cases.

A_1 qq -character in pure gauge theory without the Chern-Simons term. Let us calculate the instanton partition function in the presence of the vertical brane with no Chern-Simons term. We can use the normal ordering identities (46), (47) and (49) to obtain the partition function with the spectator brane insertion:

$$\begin{aligned}
 & \propto \sum_{\vec{\lambda}} \left(\frac{t u_2 x_1}{q u_1 x_2} \right)^{|\vec{\lambda}|} z_{\text{vect}}(\vec{\lambda}, \vec{x}) \left(\underbrace{Y_{\vec{\lambda}} \left(\sqrt{\frac{q}{t}} w \right)}_{\mu=\emptyset} + \underbrace{\left(\frac{x_1^2 u_2}{w^2 u_1} \right) \frac{1}{Y_{\vec{\lambda}} \left(\sqrt{\frac{t}{q}} w \right)}}_{\mu=\square} \right) = \\
 & = \sum_{\vec{\lambda}} \mathfrak{q}^{|\vec{\lambda}|} z_{\text{vect}}(\vec{\lambda}, \vec{x}) \left(\underbrace{Y_{\vec{\lambda}} \left(\sqrt{\frac{q}{t}} w \right)}_{\mu=\emptyset} + \mathfrak{q} \underbrace{\left(\frac{q x_1 x_2}{t w^2} \right) \frac{1}{Y_{\vec{\lambda}} \left(\sqrt{\frac{t}{q}} w \right)}}_{\mu=\square} \right) = \\
 & = \left\langle Y \left(\sqrt{\frac{q}{t}} w \right) \right\rangle + \mathfrak{q} \left(\frac{q x_1 x_2}{t w^2} \right) \left\langle \frac{1}{Y \left(\sqrt{\frac{t}{q}} w \right)} \right\rangle = \chi_{qq}^{A_1} \left(\mathbb{C}^2 \mid \sqrt{\frac{q}{t}} w \right), \quad (51)
 \end{aligned}$$

where $\mathfrak{q} = \frac{t u_2 x_1}{q u_1 x_2}$ is the instanton counting parameter and

$$z_{\text{vect}}(\vec{\lambda}, \vec{x}) = \prod_{a,b=1}^2 \frac{1}{N_{\lambda^{(a)} \lambda^{(b)}} \left(\frac{x_a}{x_b} \right)} \quad (52)$$

is the vector multiplet contribution for $U(2)$ to the instanton partition function. In the last line of Eq. (51) the average is understood as the sum over pairs of Young diagrams with weight $z_{\text{vect}}(\vec{\lambda}, \vec{x})$. Eq. (51) exactly reproduces the fundamental qq -character of A_1 type [11] (see also [24], [30]).

A_1 qq -character in a theory with Chern-Simons level 1. Let us find the qq -character of the $5d$ gauge theory with the Chern-Simons term of level 1 using the operator formalism. The modification compared to Eq. (51) is minor: the contractions between the R -matrix and the intertwining operators are

the same, only the prefactors change. We obtain the following qq -character for Chern-Simons level 1:

$$= \left\langle \Upsilon \left(\sqrt{\frac{q}{t}} w \right) \right\rangle + \mathfrak{q} \left(\frac{qx_1x_2}{tw^3} \right) \left\langle \frac{1}{\Upsilon \left(\sqrt{\frac{t}{q}} w \right)} \right\rangle = \chi_{qq}^{A_1, \text{CS}=1} \left(\mathbb{C}^2 \left| \sqrt{\frac{q}{t}} w \right. \right). \quad (53)$$

A_1 qq -character in a theory with hypermultiplets. The algebraic formalism allows us to compute the qq -character with the matter hypermultiplets coupled to the gauge theory. As an example, we will compute the fundamental character of A_1 in the presence of four fundamental matter hypermultiplets. The contractions we have already computed are enough to evaluate the character:

$$= \left\langle \Upsilon \left(\sqrt{\frac{q}{t}} w \right) \right\rangle + \mathfrak{q} \left(\frac{qx_1x_2}{ty_1y_2} \right) P(w) \left\langle \frac{1}{\Upsilon \left(\sqrt{\frac{t}{q}} w \right)} \right\rangle = \chi_{qq}^{A_1, 4\text{fund}} \left(\mathbb{C}^2 \left| \sqrt{\frac{q}{t}} w \right. \right), \quad (54)$$

where $P(w)$ is a new factor accounting for the matter multiplets that depend on their masses encoded in the spectral parameters $z_{1,2}, y_{1,2}$,

$$P(w) = \left(1 - \frac{z_1}{w} \right) \left(1 - \frac{z_2}{w} \right) \left(1 - \frac{y_1}{w} \right) \left(1 - \frac{y_2}{w} \right). \quad (55)$$

The instanton counting parameter \mathfrak{q} is also slightly modified in the presence of matter fields,

$$\mathfrak{q} = \frac{tu_2x_1y_2}{qu_1x_2z_1}. \quad (56)$$

5.1.2 Refined vertex computation

In [25] the refined topological vertex has been shown to be equal to the matrix element of certain intertwining operator of the DIM algebra \mathcal{A} . This provided an algebraic approach to compute the topological string amplitudes on local toric Calabi-Yau threefolds. Using this relation, we want to show how the qq -characters can be geometrically engineered. To introduce our approach we will treat our first example, the qq -character of the fundamental representation of A_1 using $U(2)$ theory in five dimension, in some detail.

The qq -characters have been computed using the geometric transition before [19]. In that work the authors focused on geometries that initially engineer a higher rank gauge theory and studied open topological string amplitudes by taking certain limits of the appropriate Kähler classes corresponding to the geometric transition, thus obtaining a lower rank theory with an operator insertion. A different limit needed to be taken for each term in the qq -character, in other words, the character was a linear combination of amplitudes on different geometries. Although we study the open topological amplitudes

too, our approach is different in the sense that all terms of the qq -character are produced from a single geometry as one or more infinite sums over Young diagrams truncate to a finite number of terms. To the best of our knowledge, this type of truncation is used for the first time in the literature.

A_1 qq -character in pure gauge theory without the Chern-Simons term. For the qq -character of fundamental representation of $U(2)$ theory with Chern-Simons level 0, we start with the toric threefold that engineers $U(3)$ theory with two matter multiplets, one in the fundamental and the other in the anti-fundamental representation. Recalling the algebraic approach from sec. 5.1.1, this should be expected: inserting an extra D5 brane would correspond to an increase in the rank of the gauge theory and possibly new matter multiplets upon resolving singularities. In addition, having a non-trivial states along the additional brane translates into computing “open” amplitudes, depicted in Figure 2. We obtain the qq -character by imposing a “degeneration” condition in accordance with the definition of the R -matrix Eq. (8). We note that the external legs of the toric diagram engineering the $U(3)$ theory with two matter multiplets extend asymptotically in the same way as in the geometry which engineers the $U(2)$ gauge theory with Chern-Simons level 0 (local \mathbb{F}_0) depicted in Fig. 1 a). Fig. 1 b) shows the toric diagram after resolving the singularity.

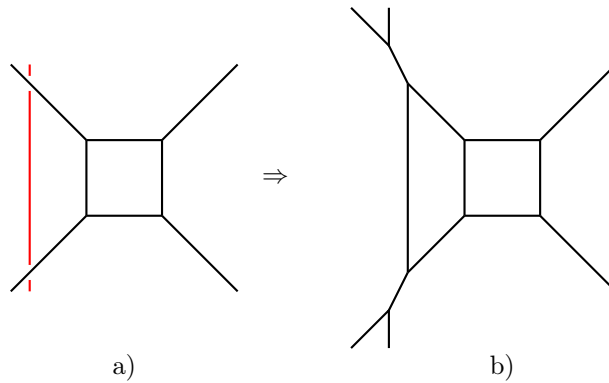

Figure 1: a) The toric diagram of \mathbb{F}_0 corresponding to pure $U(2)$ gauge theory with vertical spectator brane corresponding to the qq -character insertion shown in red. b) The crossings of the red brane are resolved into conifold geometries, which gives rise to the toric diagram for $U(3)$ gauge theory with one fundamental and one anti-fundamental hypermultiplet. The red brane crossing from a) is recovered for certain degenerate values of Kähler parameters.

The refined topological string partition function corresponding to Fig. 2 takes the following form after some slight modifications to match it identically to instanton counting,⁴

$$\begin{aligned}
Z_{\lambda\sigma} \sim & \sum_{\mu, \mu_1, \mu_2} \left(v^{-2} \Lambda Q_f^{-1} \right)^{|\mu_2| + |\mu_1|} \left(v^{-1} \Lambda Q^2 \right)^{|\mu|} f_\mu^{-3} \left[N_{\mu_1 \mu_1}(1) N_{\mu_2 \mu_2}(1) N_{\mu_2 \mu_1}(Q_f) N_{\mu_1 \mu_2}(Q_f^{-1}) \right]^{-1} \times \\
& \times \left[N_{\mu \mu}(1) N_{\mu_2 \mu}(Q_f Q) N_{\mu_2 \mu}(v^2 Q_f Q) N_{\mu_1 \mu}(Q) N_{\mu_1 \mu}(v^2 Q) \right]^{-1} N_{\mu_2 \lambda}(v Q_f Q Q_1) N_{\mu_1 \lambda}(v Q Q_1) \times \\
& \times N_{\mu \lambda}(v Q_1) N_{\mu_2 \sigma}(v Q_f Q Q_2) N_{\mu_1 \sigma}(v Q Q_2) N_{\mu \sigma}(v Q_2), \quad (57)
\end{aligned}$$

where f_μ is defined in Eq. (20), $N_{\lambda\mu}(x)$ is the Nekrasov factor Eq. (131) and

$$v = \sqrt{\frac{q}{t}}. \quad (58)$$

To obtain the qq -character we need to set the external representations to $\lambda = \square$ and $\sigma = \emptyset$ and pick special “degenerate” values for the Kähler parameters

$$Q_1 = v^{-1}, \quad Q_2 = v, \quad (59)$$

⁴We set the preferred direction to vertical in all the refined topological string computations throughout this paper.

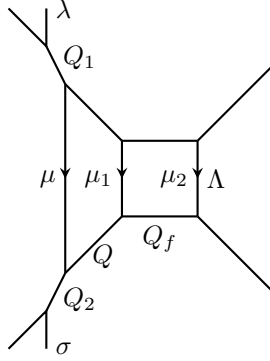

Figure 2: Toric diagram corresponding to the $U(3)$ gauge theory with two extra hypermultiplets from Fig. 1 b) with complexified Kähler parameters written over the corresponding compact two-cycles. There is a summation over the Young diagrams μ , μ_1 and μ_2 living on the internal edges, while the diagrams λ and σ on the external legs are parameters of the open topological string amplitude. The fundamental A_1 qq -character is obtained by setting $Q_1 = Q_2^{-1} = v^{-1}$ and $\lambda = \square$, $\sigma = \emptyset$.

which correspond to the geometric transtion from Fig. 1. The sum over Young diagrams μ truncates to a sum consisting of only two terms due to the identity

$$N_{\mu\square}(1) = 0, \quad \text{unless } \mu \in \{\emptyset, \square\}, \quad (60)$$

which we prove in Appendix B. Note that the qq -character of the fundamental representation of A_1 has indeed two terms, as we also argued in the algebraic approach in sec. 5.1.1. In what follows we show that the extra factors arising from the brane insertion give rise to the Y -operators. The remaining instanton sums are used to evaluate their expectation values.

- (i) Consider $\mu = \emptyset$. After some cancellations we end up with the following additional factors under the gauge theory instanton sum:

$$N_{\emptyset\square}(1) \frac{N_{\mu_1\square}(Q) N_{\mu_2\square}(Q_f Q)}{N_{\mu_1\emptyset}(Q) N_{\mu_2\emptyset}(Q_f Q)} = Y_{\mu_1}(vw) Y_{\mu_2}(vw), \quad (61)$$

where $Y_\mu(w)$ is defined in Eq. (48).

We need to make an identification between the physical parameters of the gauge theory and the geometric quantities, Kähler parameters, used in the vertex computation. Using the following identification,

$$Q_f = \frac{x_2}{x_1}, \quad \Lambda = \frac{u_2}{u_1}, \quad Q = \frac{vx_1}{w}, \quad (62)$$

it can be seen that the first term in the qq -character that we had found earlier is indeed reproduced (up to the $N_{\emptyset\square}(1)$, which as we will show now gives only an overall factor).

- (ii) The second and last term in the sum over μ is when $\mu = \square$. This time we get

$$(-1)v^2 (v^{-1}\Lambda Q^2) f_\square^{-3} N_{\emptyset\square}(1) \frac{N_{\mu_1\emptyset}(v^2 Q) N_{\mu_2\emptyset}(v^2 Q_f Q)}{N_{\mu_1\square}(v^2 Q) N_{\mu_2\square}(v^2 Q_f Q)} = \mathfrak{q} \left(\frac{qx_1 x_2}{tw^2} \right) \frac{1}{Y_{\mu_1}(v^{-1}w) Y_{\mu_2}(v^{-1}w)}, \quad (63)$$

which is identical to the second term in the qq -character we had found earlier. We would like to emphasize that this result is the “open” topological string amplitude of a single toric diagram, although we compute it in two steps: first the (two-term) sum over μ and then over μ_1, μ_2 .

We can alternatively choose a different degeneration scheme by setting $\lambda = \emptyset$ and $\sigma = \square$. The selection rule for μ then follows from another choice of the Kähler classes $Q_1 = v$ and $Q_2 = v^{-1}$. It can be shown that in that case the same qq -character is reproduced. One can argue more generally that the second degeneration scheme gives the qq -characters for *conjugate* representations, so for the fundamental representation of A_1 which is isomorphic to its conjugate the answer remains the same.

A_1 qq -character in pure gauge theory without the Chern-Simons term. Alternative spectator brane position. In sec. 4 we have noted that from general algebraic arguments it follows that the vertical spectator brane corresponding to the R -matrix commutes with internal edges of the toric diagram. Now we would like to demonstrate it by a direct computation in refined topological string theory. If we commute the vertical brane with the internal edges we end up with a different toric diagram depicted in Fig. 3. However, if we properly modify the identification between the algebraic and geometric variables after the commutation, we end up with the same qq -character.

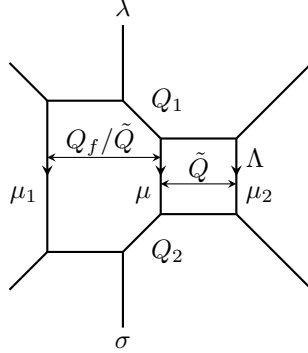

Figure 3: Another toric diagram corresponding to $U(3)$ gauge theory with two extra hypermultiplets obtained from Fig. 2 by commuting the vertical spectator brane with the internal edge carrying the Young diagram μ_1 . Notice the appearance of the new Kähler parameter \tilde{Q} .

The open topological string amplitude corresponding to Fig. 3 is again expressed in terms of three infinite sums over Young diagrams which corresponds to gluing two strip geometries together. This amplitude can be manipulated to take the form of the instanton counting of the $U(2)$ theory, with respect to which we will compute the expectation values of the Y -operators. Setting the Kähler parameters Q_1, Q_2 to the degenerate values (59) with the same choice of boundary conditions as before, $\lambda = \square$ and $\sigma = \emptyset$, we get

$$\begin{aligned}
Z_{\square\emptyset} \sim & \sum_{\vec{\mu}} (v^{-2}\Lambda Q_f^{-1})^{|\mu_2|+|\mu_1|} (v^{-1}\Lambda)^{|\mu|} f_{\mu}^{-1} \left[N_{\mu_1\mu_1}(1) N_{\mu_2\mu_2}(1) N_{\mu_2\mu_1}(Q_f) N_{\mu_1\mu_2}(Q_f^{-1}) \right]^{-1} \\
& \times \left[N_{\mu\mu}(1) N_{\mu_2\mu}(Q) N_{\mu_2\mu}(v^2Q) N_{\mu\mu_1}(Q_f Q^{-1}) N_{\mu\mu_1}(v^2Q_f Q^{-1}) \right]^{-1} N_{\mu_2\square}(Q) N_{\mu\square}(1) N_{\square\mu_1}(v^2Q_f Q^{-1}) \\
& \times N_{\mu_2\emptyset}(v^2Q) N_{\mu_2\emptyset}(v^2) N_{\emptyset\mu_1}(Q_f Q^{-1}), \quad (64)
\end{aligned}$$

which agrees with the qq -character (51) found earlier provided that we identify

$$\tilde{Q} = \frac{vx_2}{w} = QQ_f. \quad (65)$$

Let us note that we also get the same qq -character if we choose $\lambda = \emptyset$ and $\sigma = \square$ with $Q_1 = v, Q_2 = v^{-1}$.

A_1 qq -character in a theory with Chern-Simons level 1. We can compute the qq -character in the presence of a Chern-Simons term using the topological vertex as well. The toric diagram is depicted in Fig. 4. We start with the local \mathbb{F}_1 which engineers the $U(2)$ theory at Chern-Simons level 1 and insert a D5 brane as before.

The topological sting amplitude represented by Fig. 4 after taking $\lambda = \square, \sigma = \emptyset, Q_1 = v^{-1}$ and

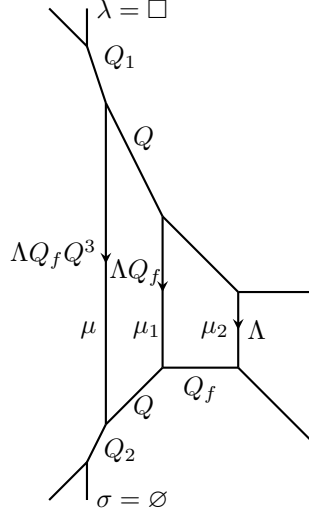

Figure 4: Resolution of crossings in Eq. (53) describing the vertical spectator brane insertion into the toric diagram of local \mathbb{F}_1 corresponding to $U(2)$ gauge theory with Chern-Simons level 1.

$Q_2 = v$ becomes:

$$\begin{aligned}
Z \sim \sum_{\vec{\mu}} (v^{-2}\Lambda Q_f^{-1})^{|\mu_2|} (v^{-2}\Lambda)^{|\mu_1|} (v^{-1}\Lambda Q_f Q^3)^{|\mu|} f_{\mu_1}^{-1} f_{\mu_2}^{-1} f_{\mu}^{-4} \times \\
\times \left[N_{\mu_1\mu_1}(1) N_{\mu_2\mu_2}(1) N_{\mu_2\mu_1}(Q_f) N_{\mu_1\mu_2}(Q_f^{-1}) \right]^{-1} \left[N_{\mu\mu}(1) N_{\mu_2\mu}(Q_f Q) N_{\mu_2\mu}(v^2 Q_f Q) N_{\mu_1\mu}(Q) N_{\mu_1\mu}(v^2 Q) \right]^{-1} \times \\
\times N_{\mu_2\Box}(Q_f Q) N_{\mu_1\Box}(Q) N_{\mu\Box}(1) N_{\mu_2\emptyset}(v^2 Q_f Q) N_{\mu_1\emptyset}(v^2 Q) N_{\mu\emptyset}(v^2). \quad (66)
\end{aligned}$$

We have almost the same map between the algebraic and geometric parameters as in the absence of the Chern-Simons term (cf. Eq. (62)):

$$Q_f = \frac{x_2}{x_1}, \quad \Lambda = -\frac{u_2}{u_1} x_2^{-1}, \quad Q = \frac{v x_1}{w}, \quad (67)$$

with the same instanton parameter $q = \frac{t}{q} \frac{u_2 x_1}{u_1 x_2}$. With the identification Eq. (67) the refined topological string amplitude (66) reproduces the character (53).

A_1 qq -character in a theory with Chern-Simons level 1. Alternative spectator brane position.

We argued in sec. 4 that the exact point at which the vertical brane (representing the R -matrix) is inserted into a toric diagram does not affect the form of the qq -character, but slightly modifies the identification between the Kähler parameters of the CY and the spectral parameters of the DIM representations. Let us demonstrate that the same is true for the case of nontrivial Chern-Simons level as well. The toric diagram corresponding to an alternative vertical brane insertion is depicted in Fig. 5.

The topological string amplitude is reduced to,

$$\begin{aligned}
Z_{\Box\emptyset} \sim \sum_{\vec{\mu}} (v^{-2}\Lambda Q_f^{-1})^{|\mu_2|} (v^{-2}\Lambda)^{|\mu_1|} (\Lambda Q)^{|\mu|} f_{\mu_1}^{-1} f_{\mu_2}^{-1} f_{\mu}^{-1} \left[N_{\mu_1\mu_1}(1) N_{\mu_2\mu_2}(1) N_{\mu_2\mu_1}(Q_f) N_{\mu_1\mu_2}(Q_f^{-1}) \right]^{-1} \times \\
\times \left[N_{\mu\mu}(1) N_{\mu_2\mu}(Q) N_{\mu_2\mu}(v^2 Q) N_{\mu\mu_1}(Q_f Q^{-1}) N_{\mu\mu_1}(v^2 Q_f Q^{-1}) \right]^{-1} N_{\mu_2\Box}(Q) N_{\mu\Box}(1) N_{\mu\Box}(v^2 Q_f Q^{-1}) \times \\
\times N_{\mu_2\emptyset}(v^2 Q) N_{\emptyset\mu}(1) N_{\emptyset\mu_1}(Q_f Q^{-1}), \quad (68)
\end{aligned}$$

when the boundary conditions are set to $\lambda = \Box$ and $\sigma = \emptyset$ with $Q_1 = Q_2 = v^{-1}$. With the alternative insertion of the vertical brane we obtain the same qq -character as in Eq. (65) if we identify

$$\tilde{Q} = \frac{v x_2}{w} = Q Q_f \quad (69)$$

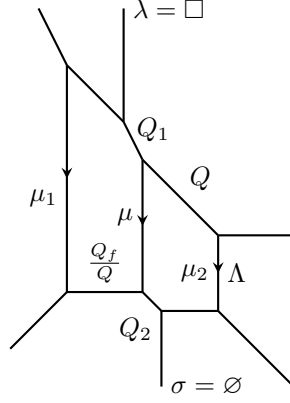

Figure 5: The toric diagram corresponding to an alternative point of insertion of the vertical spectator brane into the \mathbb{F}_1 geometry. The new Kähler parameter \tilde{Q} is related to Q by Eq. (69).

as in the case of vanishing Chern-Simons level.

The “opposite” degeneration scheme with $\lambda = \emptyset$, $\sigma = \square$ is also possible for the non-vanishing Chern-Simons level, and the two alternatives give rise to the same qq -character.

A_1 qq -character in a theory with hypermultiplets. As in the previous cases in this section, the qq -character with additional matter hypermultiplets can be obtained from refined topological strings. The corresponding toric diagram is shown in Fig. 6.

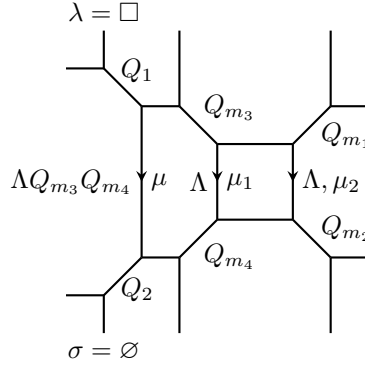

Figure 6: Resolution of the crossings of vertical brane inserted into the toric diagram corresponding to the $U(2)$ gauge theory with four fundamental hypermultiplets.

We set the boundary conditions as before, $\lambda = \square$ and $\sigma = \emptyset$ with $Q_1 = v^{-1}$ and $Q_2 = v$, so that the topological string partition functions reduces to

$$\begin{aligned}
Z_{\square\emptyset} \sim \sum_{\vec{\mu}} (v^{-2}\Lambda Q_{m_1} Q_{m_4})^{|\mu_1|+|\mu_2|} (v^{-1}\Lambda Q_{m_3} Q_{m_4})^{|\mu|} f_{\mu}^{-1} \left[N_{\mu_1\mu_1}(1) N_{\mu_2\mu_2}(1) N_{\mu_2\mu_1}(Q_f) N_{\mu_1\mu_2}(Q_f^{-1}) \right]^{-1} \times \\
\times N_{\mu_2\emptyset}(vQ_{m_1}^{-1}) N_{\mu_1\emptyset}(vQ_f^{-1}Q_{m_1}^{-1}) N_{\mu_2\emptyset}(vQ_f Q_{m_3}) N_{\mu_1\emptyset}(vQ_{m_3}) N_{\emptyset\mu_2}(vQ_{m_2}) N_{\emptyset\mu_1}(vQ_f Q_{m_2}) \times \\
\times N_{\emptyset\mu_2}(vQ_f^{-1}Q_{m_4}^{-1}) N_{\emptyset\mu_1}(vQ_{m_4}^{-1}) \left[N_{\mu\mu}(1) N_{\mu_1\mu}(Q) N_{\mu_1\mu}(v^2Q) N_{\mu_2\mu}(Q_f Q) N_{\mu_2\mu}(v^2Q_f Q) \right]^{-1} \times \\
\times N_{\emptyset\mu}(vQ_f Q Q_{m_1}) N_{\emptyset\mu}(vQ_f Q Q_{m_2}) N_{\emptyset\mu}(vQ Q_{m_3}^{-1}) N_{\emptyset\mu}(vQ Q_{m_4}^{-1}) N_{\mu_2\square}(Q_f Q) N_{\mu_1\square}(Q) N_{\mu\square}(1) \times \\
\times N_{\mu_2\emptyset}(v^2Q_f Q) N_{\mu_1\emptyset}(v^2Q) N_{\mu\emptyset}(v^2). \quad (70)
\end{aligned}$$

We obtain a match with the qq -character (54) by setting the map between the algebraic and geometric

parameters as follows

$$Q_f = \frac{x_2}{x_1}, \quad \Lambda = \frac{u_2}{u_1}, \quad Q_{m_1} = \frac{y_2}{x_2}, \quad Q_{m_2} = \frac{z_2}{x_2}, \quad Q_{m_3} = \frac{x_1}{y_1}, \quad Q_{m_4} = \frac{x_1}{z_1}. \quad (71)$$

5.2 Fundamental qq -character of A_2 type

5.2.1 Operator formalism

Our formalism also produces qq -characters for higher rank A -type root systems. The procedure is similar to the A_1 case described in sec. 5.1. We start with a network of DIM intertwiners corresponding to a quiver gauge theory of type A_n , insert the R -matrix into it and take its matrix element. We would like to demonstrate this approach on a simple example of A_2 . The network of intertwiners is depicted in Fig. 7.

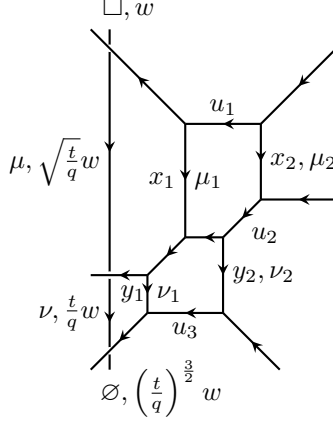

Figure 7: The network of intertwiners, reproducing to the fundamental A_2 qq -character.

Leaving out the details of the calculation, we give the answer for the matrix element of the network from Fig. 7 which indeed has the form of the A_2 qq -character:

$$\chi_{qq}^{A_2} \left(\mathbb{C}^3 \left| \sqrt{\frac{q}{t}} w \right. \right) = \left\langle Y_1 \left(\sqrt{\frac{q}{t}} w \right) \right\rangle + \left(\frac{u_2 x_1^2}{u_1 y_1 y_2 w} \right) \left\langle \frac{Y_2(w)}{Y_1 \left(\sqrt{\frac{t}{q}} w \right)} \right\rangle + \left(\sqrt{\frac{q}{t}} \frac{u_3 x_1 y_1}{u_1 w^2} \right) \left\langle \frac{1}{Y_2 \left(\frac{t}{q} w \right)} \right\rangle. \quad (72)$$

5.2.2 Refined vertex computation

The same A_2 qq -character as in sec. 5.2.1 can also be calculated following the refined topological vertex approach. The toric diagram with the R -matrix insertion is drawn in Fig. 8.

The degeneration needed to reproduce the qq -character occurs at $Q_1 = v^{-1}$ and $Q_2 = Q_3 = v$. The map between the Kähler parameters and the spectral parameters is given by

$$Q_f = \frac{x_2}{x_1}, \quad Q_m = \frac{x_2}{y_2}, \quad \tilde{Q} = \frac{x_1}{y_1}, \quad \Lambda_1 = -\frac{u_2}{u_1} x_2^{-1}, \quad \Lambda_2 = \frac{u_3}{u_2} y_2, \quad Q = \frac{v x_1}{w}. \quad (73)$$

6 Multiple vertical brane insertions and higher qq -characters

In this section we consider several vertical “spectator” branes (representing the R -matrices) inserted into the same network of intertwiners. We show that this gives rise to qq -characters of higher representations of A_m algebras. As in sec. 5 we first derive our results in the algebraic approach employing DIM intertwining operators and then give the parallel “geometric” computation using refined topological vertex formalism.

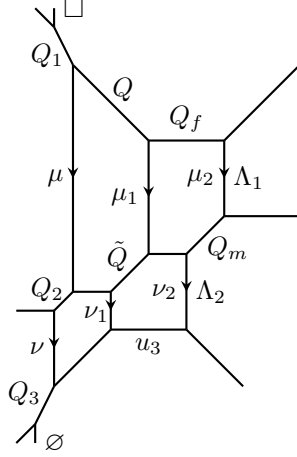

Figure 8: The toric diagram obtained from Fig. 7 by resolving all the crossings. This gives rise to a quiver $U(3) \times U(3)$ gauge theory.

6.1 Operator formalism

To understand how to combine several vertical branes together let us start with the simplest example with two vertical “spectator” branes intersecting two horizontal lines:

$$\begin{array}{c}
 \square \quad \square \\
 \downarrow w_1 \quad \downarrow w_2 \\
 \leftarrow \leftarrow \leftarrow u_1 \\
 \downarrow \lambda \quad \downarrow \mu \\
 \leftarrow \leftarrow \leftarrow u_2 \\
 \downarrow \quad \downarrow \\
 \emptyset \quad \emptyset
 \end{array}
 \sim
 \mathcal{T}_{\emptyset}^{\varnothing}(w_1)\Delta(x^+(w_1))\mathcal{T}_{\emptyset}^{\varnothing}(w_2)\Delta(x^+(w_2))\Big|_{\mathcal{F}_{q,t^{-1}}^{(1,0)}(u_1)\otimes\mathcal{F}_{q,t^{-1}}^{(1,0)}(u_2)}
 \quad (74)$$

where $\mathcal{T}_{\emptyset}^{\varnothing}(w)$ has been defined in Eq. (27) and $\Delta(x^+(w))$ is given by Eq. (109). Using the formulas Eqs. (114)–(119) for the horizontal Fock representation and the normal ordering identities from sec. 4 we find that

$$\mathcal{T}_{\emptyset}^{\varnothing}(w_1)\mathcal{T}_{\emptyset}^{\varnothing}(w_2) =: \mathcal{T}_{\emptyset}^{\varnothing}(w_1)\mathcal{T}_{\emptyset}^{\varnothing}(w_2) : \quad (75)$$

$$\Delta(x^+(w_1))\Big|_{\mathcal{F}_{q,t^{-1}}^{(1,0)}(u_1)\otimes\mathcal{F}_{q,t^{-1}}^{(1,0)}(u_2)}\mathcal{T}_{\emptyset}^{\varnothing}(w_2) = \frac{1 - \frac{t}{q} \frac{w_2}{w_1}}{1 - \frac{w_2}{w_1}} : \Delta(x^+(w_1))\Big|_{\mathcal{F}_{q,t^{-1}}^{(1,0)}(u_1)\otimes\mathcal{F}_{q,t^{-1}}^{(1,0)}(u_2)}\mathcal{T}_{\emptyset}^{\varnothing}(w_2) :, \quad (76)$$

$$\mathcal{T}_{\emptyset}^{\varnothing}(w_1)\Delta(x^+(w_2))\Big|_{\mathcal{F}_{q,t^{-1}}^{(1,0)}(u_1)\otimes\mathcal{F}_{q,t^{-1}}^{(1,0)}(u_2)} =: \mathcal{T}_{\emptyset}^{\varnothing}(w_1)\Delta(x^+(w_2))\Big|_{\mathcal{F}_{q,t^{-1}}^{(1,0)}(u_1)\otimes\mathcal{F}_{q,t^{-1}}^{(1,0)}(u_2)} : \cdot \quad (77)$$

$$\begin{aligned}
 & \Delta(x^+(w_1))\Big|_{\mathcal{F}_{q,t^{-1}}^{(1,0)}(u_1)\otimes\mathcal{F}_{q,t^{-1}}^{(1,0)}(u_2)}\Delta(x^+(w_2))\Big|_{\mathcal{F}_{q,t^{-1}}^{(1,0)}(u_1)\otimes\mathcal{F}_{q,t^{-1}}^{(1,0)}(u_2)} \sim \\
 & \sim : x^+(w_1)x^+(w_2) : \otimes 1 + \mathcal{S}\left(\frac{w_1}{w_2}\right) : x^+(w_1)\psi^{-}\left(\left(\frac{t}{q}\right)^{\frac{1}{4}}w_2\right) : \otimes x^+\left(\sqrt{\frac{t}{q}}w_2\right) + \\
 & + \mathcal{S}\left(\frac{w_2}{w_1}\right) : \psi^{-}\left(\left(\frac{t}{q}\right)^{\frac{1}{4}}w_1\right)x^+(w_2) : \otimes x^+\left(\sqrt{\frac{t}{q}}w_1\right) + \\
 & + : \psi^{-}\left(\left(\frac{t}{q}\right)^{\frac{1}{4}}w_1\right)\psi^{-}\left(\left(\frac{t}{q}\right)^{\frac{1}{4}}w_2\right) : \otimes : x^+\left(\sqrt{\frac{t}{q}}w_1\right)x^+\left(\sqrt{\frac{t}{q}}w_2\right) :, \quad (78)
 \end{aligned}$$

where the “structure function” $S(x)$ is defined as

$$S(x) \stackrel{\text{def}}{=} \frac{(1 - \frac{x}{t})(1 - qx)}{(1 - x)(1 - \frac{q}{t}x)}. \quad (79)$$

Inserting the resulting operator Eq. (74) into a toric diagram corresponding to a pure $SU(2)$ gauge theory gives

$$\begin{aligned} & \sim \underbrace{\left\langle Y_{\bar{\lambda}} \left(\sqrt{\frac{q}{t}} w_1 \right) Y_{\bar{\lambda}} \left(\sqrt{\frac{q}{t}} w_2 \right) \right\rangle}_{\nu=\emptyset, \mu=\emptyset} + \underbrace{q S \left(\frac{w_2}{w_1} \right) \left(\frac{q x_1 x_2}{t w_1^2} \right) \left\langle \frac{Y_{\bar{\lambda}} \left(\sqrt{\frac{q}{t}} w_2 \right)}{Y_{\bar{\lambda}} \left(\sqrt{\frac{t}{q}} w_1 \right)} \right\rangle}_{\nu=\square, \mu=\emptyset} + \\ & + \underbrace{q S \left(\frac{w_1}{w_2} \right) \left(\frac{q x_1 x_2}{t w_2^2} \right) \left\langle \frac{Y_{\bar{\lambda}} \left(\sqrt{\frac{q}{t}} w_1 \right)}{Y_{\bar{\lambda}} \left(\sqrt{\frac{t}{q}} w_2 \right)} \right\rangle}_{\nu=\emptyset, \mu=\square} + \underbrace{q^2 \left(\frac{q^2 x_1^2 x_2^2}{t^2 w_1^2 w_2^2} \right) \left\langle \frac{1}{Y_{\bar{\lambda}} \left(\sqrt{\frac{t}{q}} w_1 \right) Y_{\bar{\lambda}} \left(\sqrt{\frac{t}{q}} w_2 \right)} \right\rangle}_{\nu=\square, \mu=\square} = \\ & = \chi_{qq}^{A_1} \left(S^2 \mathbb{C}^2 \left| \sqrt{\frac{q}{t}} w_1, \sqrt{\frac{q}{t}} w_2 \right. \right), \quad (80) \end{aligned}$$

which exactly reproduces weight 2 qq -character of A_1 type corresponding to symmetric representation [30].

To get the qq -character corresponding to antisymmetric representation $\Lambda^2 \mathbb{C}^2$ of A_1 (which is trivial) we need to consider a degeneration of Eq. (80):

$$\chi_{qq}^{A_1} \left(\Lambda^2 \mathbb{C}^2 \left| \sqrt{\frac{q}{t}} w_1 \right. \right) \sim \lim_{w_2 \rightarrow \frac{t}{q} w_1} \chi_{qq}^{A_1} \left(S^2 \mathbb{C}^2 \left| \sqrt{\frac{q}{t}} w_1, \sqrt{\frac{q}{t}} w_2 \right. \right). \quad (81)$$

The value $\frac{w_2}{w_1} = \frac{t}{q}$ is a pole of the function $S(\frac{w_2}{w_1})$, therefore, to get a meaningful answer we have to multiply the character under the limit by something proportional to $(1 - \frac{q w_2}{t w_1})$. Only one term survives:

$$\lim_{w_2 \rightarrow \frac{t}{q} w_1} \left(1 - \frac{q w_2}{t w_1} \right) \chi_{qq}^{A_1} \left(S^2 \mathbb{C}^2 \left| \sqrt{\frac{q}{t}} w_1, \sqrt{\frac{q}{t}} w_2 \right. \right) \sim \underbrace{\left\langle \frac{Y_{\bar{\lambda}} \left(\sqrt{\frac{q}{t}} w_1 \right)}{Y_{\bar{\lambda}} \left(\sqrt{\frac{t}{q}} w_1 \right)} \right\rangle}_{\nu=\square, \mu=\emptyset} = 1, \quad (82)$$

which is indeed equal to the qq -character of the trivial representation $\Lambda^2 \mathbb{C}^2$ of A_1 .

The degeneration pattern of higher qq -characters Eq. (82) is in fact general. For example, one can get the qq -characters of all the fundamental representations $\Lambda^k \mathbb{C}^n$ of A_{n-1} by considering k vertical branes with coordinates w_i , $i = 1, \dots, k$ intersecting n horizontal lines in the toric diagram and sending

$$w_i = \left(\frac{t}{q} \right)^{i-1} w. \quad (83)$$

It is curious to notice which Young diagrams on the intermediate legs (the analogs of ν and μ in

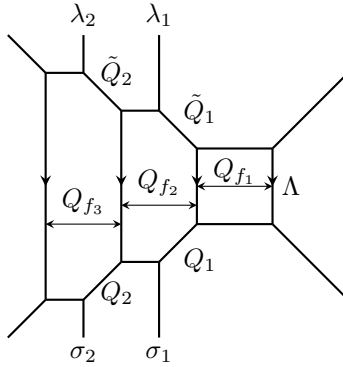

Figure 9: Toric diagram geometrically engineering a $U(4)$ gauge theory with two fundamental and two antifundamental hypermultiplets. After the degeneration of the Kähler parameters $Q_1, Q_2, \tilde{Q}_1, \tilde{Q}_2$ the open string amplitude reproduces the qq -character of the symmetric representation $S^2\mathbb{C}^2$ of A_1 .

where the “structure function” $S(x)$ is the same as in Eq. (79). In the calculation leading to Eq. (88) the following alternative formula for $S(x)$ through the Nekrasov factors Eq. (131) is useful:

$$S(x) = \frac{N_{\square\square}(x)}{N_{\square\emptyset}(x)N_{\emptyset\square}(x)}. \quad (89)$$

The instanton counting parameter in Eq. (88) is given by

$$\mathfrak{q} = v^2\Lambda Q_f^{-1}, \quad (90)$$

while the map between the Kähler parameters and the parameters of the representation is similar to (62).

We should compare our expression (88) with Eq. (4.18) of [18]. At first sight, they may look different, however, they turn out to be identical after combining the terms due to the normal ordering of the DIM operators with the rest of the expression.

7 Elliptic generalization of qq -characters

Our algebraic approach can be generalized to produce the $6d$ version of the qq -characters introduced in [17], [31]. This is achieved by taking the elliptic deformation of the DIM algebra and intertwining operators [36]. We review the basics of the procedure in Appendix D. The deformation is equivalent to the “partial compactification” of the toric CY giving rise to an elliptic fibration [32]. M-theory compactified on the fibration engineers the $6d$ gauge theory on $\mathbb{R}^4 \times T^2$, hence the notion of $6d$ qq -characters.

7.1 Operator formalism

The intertwining operators are vertex operators involving free bosonic modes a_n obeying the (q, t) -deformed Heisenberg algebra (16). In the elliptic deformation of the DIM algebra we introduce an extra parameter p into the commutation relations [36], [33]. It turns out that to survive the deformation, the horizontal Fock representation defined in Appendix A needs to be “doubled”, i.e. one needs to introduce the *second set* of independent Heisenberg generators b_n in addition to a_n . More details are provided in Appendix D.

Due to the doubling of the modes the elliptic deformation of each vertex operator becomes a product of two vertex operators: one expressed in terms of the old Heisenberg generators a_n and the other in

terms of the new ones b_n . The elliptic version of the intertwining operator (13) takes the form⁵,

$$\begin{aligned} \Phi^\lambda(x) = \begin{array}{c} \lambda \\ \downarrow \\ \swarrow \text{---} \text{---} \searrow \\ \downarrow \end{array} &\sim : \exp \left[\sum_{n \neq 0} \frac{1}{n} \frac{1}{1-p^{|n|}} \left(\frac{1}{1-q^{-n}} - (1-t^n) \text{Ch}_\lambda(q^{-n}, t^{-n}) \right) x^{-n} a_n \right] : \times \\ &\times : \exp \left[\sum_{n \neq 0} \frac{1}{n} \frac{p^{|n|}}{1-p^{|n|}} \left(\frac{1}{1-q^n} - (1-t^{-n}) \text{Ch}_\lambda(q^n, t^n) \right) x^n b_n \right] :, \end{aligned} \quad (91)$$

while its dual Eq. (14) becomes

$$\begin{aligned} \Phi_\mu^*(y) = \begin{array}{c} \leftarrow \text{---} \text{---} \rightarrow \\ \downarrow \\ \mu \end{array} &\sim : \exp \left[- \sum_{n \neq 0} \frac{1}{n} \frac{q^{-|n|/2} t^{|n|/2}}{1-p^{|n|}} \left(\frac{1}{1-q^{-n}} - (1-t^n) \text{Ch}_\mu(q^{-n}, t^{-n}) \right) y^{-n} a_n \right] : \times \\ &\times : \exp \left[- \sum_{n \neq 0} \frac{1}{n} \frac{p^{|n|}}{1-p^{|n|}} q^{|n|/2} t^{-|n|/2} \left(\frac{1}{1-q^n} - (1-t^{-n}) \text{Ch}_\mu(q^n, t^n) \right) y^n b_n \right] :, \end{aligned} \quad (92)$$

where we denote the ‘‘doubled’’ Fock representations by thick lines, $\text{Ch}_\lambda(q, t)$ is defined by Eq. (15) and we have skipped the prefactors which are the same as in the undeformed case (see Eqs. (138), (139)). The Heisenberg generators a_n and b_n satisfy the elliptically deformed commutation relations (149). One can check that the vertex operators (91), (92) are indeed the intertwining operators between the vertical and horizontal Fock representations of the elliptic DIM algebra as defined in Appendix D.

We can use the deformed intertwining operators (91), (92) to compute the elliptic deformation of the R -matrix (17) which we denote by \mathfrak{R} ,

$$\begin{aligned} \mathfrak{R}_\mu^\lambda(w, u, N) \stackrel{\text{def}}{=} \Phi^\lambda(w) \Phi_\mu \left(\sqrt{\frac{t}{q}} w \right) &= \begin{array}{c} |w, \lambda\rangle \\ \downarrow \\ \leftarrow \text{---} \text{---} \rightarrow \\ \downarrow \\ |\sqrt{\frac{t}{q}} w, \mu\rangle \end{array} = \\ &= (-w)^{-N|\lambda|} u^{|\lambda|} \left(-\sqrt{\frac{t}{q}} w \right)^{N|\mu|} \left(\frac{q}{u} \sqrt{\frac{t}{q}} \right)^{|\mu|} \left(\frac{f_\mu}{f_\lambda} \right)^N f_\lambda^{-1} q^{n(\lambda^T) + n(\mu^T)} \prod_{k=1}^{\infty} N_{\lambda\mu} \left(p^{k-1} \frac{q}{t} \right) N_{\mu\lambda} (p^k) \times \\ &\quad \times : \exp \left[- \sum_{n \geq 1} \frac{1}{n} \frac{1}{1-p^n} \frac{1 - (t/q)^n}{1-q^n} w^n a_{-n} \right] \times \\ &\quad \times \exp \left[- \sum_{n \neq 0} \frac{1}{n} \frac{1-t^n}{1-p^{|n|}} \left(\text{Ch}_\lambda(q^{-n}, t^{-n}) - \left(\frac{t}{q} \right)^{\frac{|n|-n}{2}} \text{Ch}_\mu(q^{-n}, t^{-n}) \right) w^{-n} a_n \right] : \times \\ &\quad \times : \exp \left[\sum_{n \geq 1} \frac{1}{n} \frac{p^n}{1-p^n} \frac{q^n (1 - (q/t)^n)}{1-q^n} w^{-n} b_{-n} \right] \times \\ &\quad \times \exp \left[- \sum_{n \neq 0} \frac{1}{n} \frac{p^{|n|} (1-t^{-n})}{1-p^{|n|}} \left(\text{Ch}_\lambda(q^n, t^n) - \left(\frac{q}{t} \right)^{\frac{|n|-n}{2}} \text{Ch}_\mu(q^n, t^n) \right) w^n b_n \right] :, \end{aligned} \quad (93)$$

where the Nekrasov factors $N_{\lambda\mu}(x)$ are given by Eq. (131), Ch_λ , $n(\lambda^T)$ and f_λ are defined by Eqs. (15), (18) and (20) respectively.

The selection rule for λ and μ in Eq. (93) is the same as in sec. 2: when $\lambda = \square$ the other representation μ can be either \emptyset or \square for \mathfrak{R}_μ^λ to be nonzero. The prefactor in the first line of Eq. (93) is slightly different

⁵We denote the elliptic intertwining operators by Φ and Φ^* to distinguish them from the undeformed ones, which we call Ψ , Ψ^* .

from that of the original R -matrix (17) — it is missing the $c_\lambda c_\mu$ factors. The reason behind this difference is our choice of basis in the vertical Fock representation. In the elliptic calculations in this section we use a more convenient (orthogonal) basis in which the norm is given by

$$\langle \lambda | \mu \rangle = \delta_{\mu\nu} (-1)^{|\lambda|} q^{|\lambda|^2/2 + |\lambda|/2} t^{|\lambda^\top|^2/2 - |\lambda|/2} \prod_{k=1}^{\infty} N_{\lambda\lambda}(p^{k-1}) N_{\lambda\lambda}(p^k v^2). \quad (94)$$

where $\|\lambda\|^2$ is defined by Eq. (21).

The norm (94) is proportional to the vector multiplet contribution to the Nekrasov partition function of the $6d$ $U(1)$ gauge theory. Moreover, for $p \rightarrow 0$ it reduces to the familiar integral form normalization of Macdonald polynomials J_λ ,

$$\langle \lambda | \mu \rangle \xrightarrow{p \rightarrow 0} \langle J_\lambda | J_\mu \rangle = \delta_{\mu\lambda} c_\mu c'_\mu, \quad \text{with} \quad c'_\mu = \prod_{(i,j) \in \mu} \left(1 - q^{\mu_i - j + 1} t^{\mu_j^\top - i} \right). \quad (95)$$

One can evaluate the Wick contractions of the R -matrix Eq. (93) with the intertwining operators (91), (92) and show that the only non-trivial contributions (apart from the possible prefactors) happens when $\lambda = \square$ and $\mu = \emptyset$. The contraction has the same form as in the undeformed case (Eq. (47)) but with modified Υ functions which we denote by \mathcal{Y} ,

$$\begin{aligned} \mathcal{Y}_{\overline{\lambda}}(w) &= \prod_{a=1}^n \mathcal{Y}_{\lambda^{(a)}}(w) \equiv \prod_{a=1}^n \prod_{k=1}^{\infty} \frac{N_{\lambda^{(a)}\square} \left(v^2 p^{k-1} \frac{x_a}{w} \right) N_{\square\lambda^{(a)}} \left(p^{k-1} \frac{w}{x_a} \right)}{N_{\lambda^{(a)}\emptyset} \left(v^2 p^{k-1} \frac{x_a}{w} \right) N_{\emptyset\lambda^{(a)}} \left(p^{k-1} \frac{w}{x_a} \right)} = \\ &= \prod_{a=1}^n \theta_p \left(\frac{x_a}{w} \right) \prod_{(i,j) \in \lambda^{(a)}} \frac{\theta_p \left(\frac{x_a}{w} q^{j-1} t^{-i} \right) \theta_p \left(\frac{x_a}{w} q^j t^{-i+1} \right)}{\theta_p \left(\frac{x_a}{w} q^j t^{-i} \right) \theta_p \left(\frac{x_a}{w} q^{j-1} t^{-i+1} \right)}. \quad (96) \end{aligned}$$

In the definition (96) we have used the Jacobi theta function $\theta_p(x)$ (Eq. (153)) instead of the more conventional one $\theta_1(x; p)$. The explicit expressions for the qq -characters are the same up to a multiplicative factor in front of them when written in terms of either of these functions.

Fundamental elliptic A_1 qq -character. We would like to compute the elliptic (or $6d$) qq -character of the fundamental representation for the A_1 group. In the $6d$ case to avoid anomaly we need to make sure that the theory is conformal. The simplest nonabelian gauge group is just $U(2)$, so to have vanishing beta function we need to add four matter hypermultiplets in fundamental representations. First, let us present the computation using the elliptic deformation of the intertwining operators given by Eqs. (91), (92). The network of intertwiners corresponding to the $6d$ theory is depicted in Fig. 7.1. Notice that the diagrams for the networks corresponding to the $5d$ and $6d$ theories are the same, only the intertwining operators Ψ, Ψ^* are replaced with their elliptic deformations Φ, Φ^* .

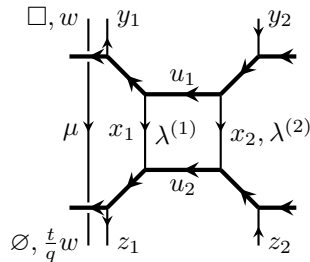

Figure 10: The vertical brane inserted into the network of intertwiners corresponding to the $6d$ $U(2)$ gauge theory with four hypermultiplets in fundamental representation. We denote the “doubled” Fock representations by thick lines.

Similarly to the trigonometric case, we can normal order all the operators (the R -matrices and triple

intertwiners) in the network and obtain the following qq -character:

$$\chi_{qq}^{A_1, \text{ell}} \left(\mathbb{C}^2 \left| \sqrt{\frac{q}{t}} w \right. \right) \sim \left\langle \mathcal{Y} \left(\sqrt{\frac{q}{t}} w \right) \right\rangle + q \mathcal{P}(w) \left(\frac{qx_1x_2}{tz_1y_1} \right) \left\langle \frac{1}{\mathcal{Y} \left(\sqrt{\frac{t}{q}} w \right)} \right\rangle. \quad (97)$$

Here, $\mathcal{P}(w)$ is the elliptic version of the factor $P(w)$ introduced in Eq. (55),

$$\mathcal{P}(w) = \prod_{a=1}^{N_f} \theta_p \left(\frac{y_a}{w} \right), \quad (98)$$

where y is the insertion point of the intertwining operators corresponding to the matter hypermultiplets. If the elliptic deformation parameter p is sent to zero, we obviously get back to the trigonometric result from sec. 5.1.1 [24], [17].

Higher elliptic A_1 qq -character. The elliptic version of our algebraic approach can be extended to multiple brane insertions as well. As an example we would like to insert two R -matrices into the diagram corresponding to the $6d$ $U(2)$ gauge theory. The DIM network is depicted in Fig. 11.

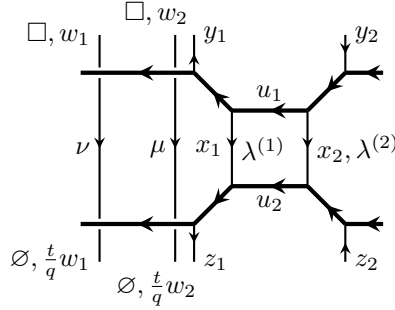

Figure 11: Two vertical branes inserted into the network of intertwiners corresponding to the $6d$ $U(2)$ gauge theory with four hypermultiplets in fundamental representation. Only $\mu = \square, \emptyset$ and $\nu = \square, \emptyset$ produce nontrivial contributions leading to four terms in the qq -character (99).

The network produces the elliptic qq -character corresponding to the first symmetric representation of A_1 :

$$\begin{aligned} \chi_{qq}^{A_1, \text{ell}} \left(S^2 \mathbb{C}^2 \left| \sqrt{\frac{q}{t}} w_1, \sqrt{\frac{q}{t}} w_2 \right. \right) &= \left\langle \mathcal{Y} \left(\sqrt{\frac{q}{t}} w_1 \right) \mathcal{Y} \left(\sqrt{\frac{q}{t}} w_2 \right) \right\rangle + \left(\frac{u_2 x_1^2}{u_1 y_1 z_1} \right) \mathcal{P}(w_2) \mathcal{S} \left(\frac{w_1}{w_2} \right) \left\langle \frac{\mathcal{Y} \left(\sqrt{\frac{q}{t}} w_1 \right)}{\mathcal{Y} \left(\sqrt{\frac{t}{q}} w_2 \right)} \right\rangle + \\ &+ \left(\frac{u_2 x_1^2}{u_1 y_1 z_1} \right) \mathcal{P}(w_1) \mathcal{S} \left(\frac{w_2}{w_1} \right) \left\langle \frac{\mathcal{Y} \left(\sqrt{\frac{q}{t}} w_2 \right)}{\mathcal{Y} \left(\sqrt{\frac{t}{q}} w_1 \right)} \right\rangle + \left(\frac{u_2 x_1^2}{u_1 y_1 z_1} \right)^2 \mathcal{P}(w_1) \mathcal{P}(w_2) \left\langle \frac{1}{\mathcal{Y} \left(\sqrt{\frac{t}{q}} w_1 \right) \mathcal{Y} \left(\sqrt{\frac{t}{q}} w_2 \right)} \right\rangle, \end{aligned} \quad (99)$$

where $\mathcal{P}(w)$ is given by Eq. (98) and we have defined the elliptic version $\mathcal{S}(w)$ of the structure function $S(w)$ (Eq. (79)),

$$\mathcal{S}(w) = \frac{\theta_p(qw) \theta_p(t^{-1}w)}{\theta_p(w) \theta_p(qt^{-1}w)}. \quad (100)$$

Note that we have defined the elliptic versions of all the functions featuring in the qq -characters using the Jacobi theta function $\theta_p(x)$ instead of $\theta_1(x; p)$. It is easy to check that the functional form of the qq -character would not have changed if we had defined them using θ_1 .

7.2 Refined vertex computation

Let us also comment on an alternative derivation of the elliptic qq -character (97). As shown in [32], [33], the elliptic deformation of a vacuum matrix element of a network of intertwiners can be achieved by taking the trace of the network instead. To this end we need to evaluate the matrix elements associated with external horizontal lines (Fock representations) in the diagram from Fig. 6 of the form $\langle P_\mu | \dots | P_\mu \rangle$, where “ \dots ” stand for a product of the intertwining operators Ψ and Ψ^* . We then perform the sum over all possible Young diagrams μ with the weight $p^{|\mu|}$. To get back the undeformed expression (54) one needs to take $p \rightarrow 0$ so that only the vacuum matrix element $\langle \emptyset | \dots | \emptyset \rangle$ contributes to the sum.

This approach is parallel to the refined topological vertex computation in which one studies the “compactified” toric diagram [40], i.e. the diagram drawn on a cylinder instead of a plane. To be able to glue the external lines in the toric diagram together one needs to ensure that their slopes match. This turns out to be equivalent to requiring that the corresponding gauge theory is superconformal (cf. the diagram which cannot be compactified, e.g. from Fig. 4). Let us demonstrate how it works in several examples.

Fundamental elliptic A_1 qq -character and $6d$ $U(2)$ gauge theory. We have pointed out before that the R -matrix commutes with the vertex operators, which manifests itself in different possible degeneration schemes of the toric diagrams leading to the same qq -character. In the following we would like to present two different toric diagrams that give rise to the fundamental elliptic A_1 qq -character. The first version is depicted in Fig. 12.

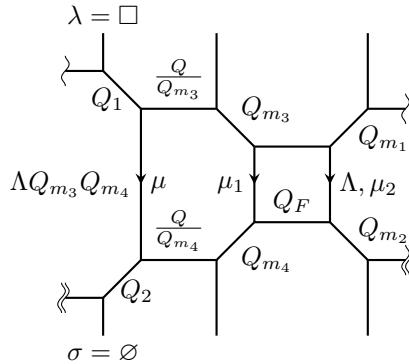

Figure 12: The compactified toric diagram corresponding to $6d$ $U(3)$ gauge theory with six fundamental hypermultiplets to make it superconformal. The wavy lines indicate that the corresponding points need to be identified. The partition function reproduces the elliptic qq -character in $6d$ $U(2)$ gauge theory provided one sets $Q_2 = Q_1^{-1} = v$.

After applying the degeneration condition $Q_1 = v^{-1}$, $Q_2 = v$ and fixing $\lambda = \square$, $\sigma = \emptyset$ one can show that the refined topological string partition function reproduces the elliptic qq -character (97) obtained in the algebraic approach. In the process one also fixes the identification between the Kähler parameters of the CY background and the spectral parameters of Fock representations of the algebra \mathcal{A} :

$$Q_f = \frac{x_2}{x_1}, \quad \Lambda = \frac{u_2}{u_1}, \quad Q_{m_1} = \frac{y_2}{x_2}, \quad Q_{m_2} = \frac{z_2}{x_2}, \quad Q_{m_3} = \frac{x_1}{y_1}, \quad Q_{m_4} = \frac{x_1}{z_1}, \quad (101)$$

and for the insertion point of the spectator brane one gets

$$Q = v \frac{x_1}{w}. \quad (102)$$

Fundamental elliptic A_1 qq -character and $6d$ $U(2)$ gauge theory. Alternative spectator brane position. The second type of degeneration of the $U(3)$ toric diagram leading to the elliptic A_1 qq -character is when the vertical spectator brane is placed in the compact four cycle, as depicted in Fig. 13. The topological string partition function is identical to the elliptic qq -character with the same dictionary

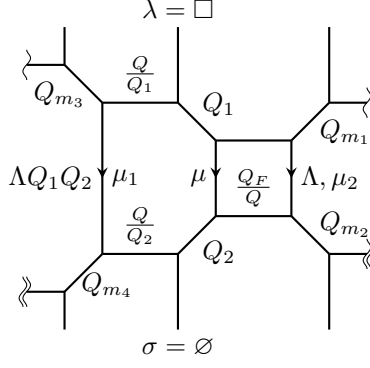

Figure 13: Alternative degeneration of the toric diagram of the $6d$ $U(3)$ gauge theory with six hypermultiplets, cf. Fig. 12. Degenerate values of the Kähler parameters reproducing the qq -character are $Q_2 = Q_1^{-1} = v$.

between spectral parameters and Kähler parameters as in Eq. (101) and the slightly different Kähler class used to parametrize the insertion of the extra brane,

$$Q = v^{-1} \frac{w}{x_1}. \quad (103)$$

Higher elliptic A_1 qq -character and $6d$ $U(2)$ gauge theory. Again, we can reproduce the qq -character (99) obtained in the algebraic approach from refined topological string. To this end we should compute the amplitude corresponding to the diagram depicted in Fig. 14.

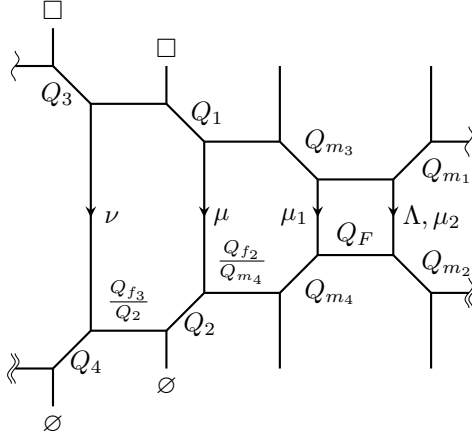

Figure 14: Toric diagram corresponding to the $6d$ $U(4)$ gauge theory with eight fundamental hypermultiplets. The wavy lines indicate that the corresponding points need to be identified. The degeneration which gives rise to qq -character happens when one sets $Q_1 = Q_3 = v^{-1}$, $Q_2 = Q_4 = v$.

Formula (99) is indeed reproduced provided we use the dictionary (101) between the parameters and identify the spectator brane insertions points with

$$Q_{f_2} = \frac{vx_1}{w_2}, \quad \text{and} \quad Q_{f_3} = \frac{w_2}{w_1}. \quad (104)$$

8 Conclusions

We have presented a new description of qq -characters using the R -matrix of the DIM algebra. Our approach is inspired by the correspondence between Type IIB branes and representations of the DIM

algebra [25], [16] in which the R -matrix is viewed as a spectator brane insertion. This allows for a compact uniform description of all qq -characters of the A_n series both for fundamental (defining) representation and higher representations. We also provide an uplift of the formalism to elliptic qq -characters.

Several further lines of investigation are apparent. In the present paper we have considered the insertions of the spectator brane with external states $|\square\rangle$ and $|\emptyset\rangle$ only. One can ask if other choices of external states also correspond to some qq -characters. The preliminary answer is affirmative, in particular we believe that the *exchange* of the two external states leads to the qq -character of the conjugate representation.

A more radical generalization would be to consider the spectator brane that is not a 5-brane, but a 7-brane. It is reasonable to conjecture that in this case the MacMahon R -matrix put forward in [34] should appear, giving rise to new qq -characters. There is a large class of DIM representations arising from degenerations of the MacMahon representation which includes the among others the Fock representation. The MacMahon R -matrix will allow one to study qq -characters corresponding to this class of DIM representations.

The uniform treatment of the A_n series of qq -characters resembles the uniform approach of [35] to quantum affine Lie algebras. In that case the integrals of motion for all $U_q(\widehat{A}_n)$ algebras are obtained uniformly in n by building the transfer-matrices from a more elementary higher-dimensional object, the Zamolodchikov tetrahedron operator. It would be interesting to investigate if the qq -characters can be viewed in the same way with certain tetrahedron operator replacing the DIM R -matrix.

From a gauge theory perspective it would be desirable to study the connection of our current approach with the work [38] where the qq -characters were interpreted as partition functions of a coupled $1d$ - $5d$ field theory system. The $1d$ degrees of freedom represent the Wilson line in a $5d$ gauge theory which looks similar to how the spectator brane producing the qq -character is coupled to the 5-brane system in our R -matrix formalism. This connection definitely merits further investigation.

Recently the algebraic approach to qq -characters using DIM algebra has been extended to gauge theories with gauge groups from the classical series B_n , C_n and D_n [39]. We believe that our R -matrix formalism can also be extended to these cases putting them in the unified framework with the A_n examples presented here. We plan to study such an extension in our next works.

Acknowledgments

YZ is grateful to CK and to Boğaziçi University where this work has been initiated. CK would like to thank the warm hospitality of Niels Bohr Institute where this work was finished. This work is partly supported by the joint grant RFBR 21-51-46010 and TÜBİTAK 220N106. CK's research is also supported by TÜBİTAK grants 120F184. Mehmet Batu Bayındırılı is supported by TÜBİTAK grant 220N106. This article is based upon work from COST Action 21109 CaLISTA, supported by COST (European Cooperation in Science and Technology).

A Basic facts about the DIM algebra

In this Appendix we give a short summary of the Ding-Iohara-Miki (DIM) algebra $U_{q,t}(\widehat{\mathfrak{gl}}_1)$. We will skip many technical details which can be found e.g. in [17], [27], [28].

Definition. The algebra $U_{q,t}(\widehat{\mathfrak{gl}}_1)$ can be viewed as the quantum deformation of the universal enveloping algebra of a Lie algebra $qW_{1+\infty}$ generated by the elements $e_{(n,m)}$ with $(n,m) \in \mathbb{Z}^2$ satisfying

$$[e_{(n,m)}, e_{(k,l)}] = \left(q^{\frac{nl-mk}{2}} - q^{-\frac{nl-mk}{2}} \right) e_{(n+k,m+l)} + (c_1 n + c_2 m) \delta_{n+k,0} \delta_{m+l,0}, \quad (105)$$

where $c_{1,2}$ are two central elements. The Lie algebra $qW_{1+\infty}$ is doubly graded with $e_{(n,m)}$ having grading (n,m) . We denote the grading operators by d_1 and d_2 respectively:

$$[d_1, e_{(n,m)}] = n e_{(n,m)}, \quad [d_2, e_{(n,m)}] = m e_{(n,m)}. \quad (106)$$

The automorphism group $SL(2, \mathbb{Z})$ acts on $qW_{1+\infty}$ so that the indices (n, m) of the generators $e_{(n,m)}$ and the central charges (c_1, c_2) transform in the fundamental two-dimensional representation and its conjugate respectively.

The quantum deformation $U_{q,t}(\widehat{\mathfrak{gl}}_1)$ of $qW_{1+\infty}$ is controlled by the parameter t/q . When t/q is equal to one, the Lie algebra relations (105) are reproduced. We will keep the notation $e_{(n,m)}$ for the elements of the quantum deformed universal enveloping algebra corresponding to the elements of the Lie algebra, though the relations between them will become nonlinear after the deformation. We will not write these complicated relations explicitly here (see e.g. [28]).

The double grading survives the quantum deformation, while the $SL(2, \mathbb{Z})$ action is uplifted to the action of its universal cover $\widetilde{SL}(2, \mathbb{Z}) = SL(2, \mathbb{Z}) \times \mathbb{Z}$. Another nontrivial property of the algebra $U_{q,t}(\widehat{\mathfrak{gl}}_1)$ is that the parameter q of $qW_{1+\infty}$, the deformation parameter t/q and their inverse product t^{-1} enter the commutation relations only as symmetric combinations.

The $\widetilde{SL}(2, \mathbb{Z})$ automorphism group and the symmetry under the permutation of the deformation parameters $(q, t^{-1}, t/q)$ imply that the set of representations of $U_{q,t}(\widehat{\mathfrak{gl}}_1)$ is organized into orbits of the $\widetilde{SL}(2, \mathbb{Z}) \times \mathfrak{S}_3$ group action.

Coproduct(s). The DIM algebra is a nontrivial Hopf algebra. To write out the coproduct it will be convenient to introduce the generating currents

$$x^\pm(z) = \sum_{n \in \mathbb{Z}} e_{(\pm 1, n)} z^{-n}, \quad (107)$$

$$\psi^\pm(z) = K^{\mp 1} \exp \left(- \sum_{n \geq 1} \frac{\kappa_n}{n} \gamma^{\mp \frac{n}{2}} e_{(0, \pm n)} z^{\mp n} \right), \quad (108)$$

where $\kappa_n = (1 - q^n)(1 - t^{-1})(1 - (t/q)^n)$, and $\gamma = (t/q)^{c_1/2}$ and $K = (t/q)^{c_2/2}$ are the central element of the DIM algebra corresponding to the central elements c_1 and c_2 of $qW_{1+\infty}$ respectively.

In terms of the currents (107), (108) the coproduct Δ can be written as

$$\Delta(x^+(z)) = x^+(z) \otimes 1 + \psi^- \left(\gamma^{\frac{1}{2}} z \right) \otimes x^+(\gamma z), \quad (109)$$

$$\Delta(x^-(z)) = x^-(z) \otimes \psi^+ \left(\gamma^{\frac{1}{2}} z \right) + 1 \otimes x^-(z), \quad (110)$$

$$\Delta(\psi^\pm(z)) = \psi^\pm \left(\gamma^{\pm \frac{1}{2}} z \right) \otimes \psi^\pm \left(\gamma^{\mp \frac{1}{2}} z \right), \quad (111)$$

$$\Delta(c_i) = c_i \otimes 1 + 1 \otimes c_i, \quad (112)$$

$$\Delta(d_i) = d_i \otimes 1 + 1 \otimes d_i. \quad (113)$$

where $\gamma_{(1)} = \gamma \otimes 1$, $\gamma_{(2)} = 1 \otimes \gamma$. In fact, the coproduct Δ is one of infinitely many non-equivalent coproducts on the DIM algebra. In the literature on refined topological strings the choice of coproduct is known as the choice preferred direction (the coproducts are parametrized by directions in the two-dimensional plane). For the sake of brevity we will not explore here the issue of multiple coproducts, but simply use Eqs. (109)–(111) throughout the whole paper.

Fock representations. There exist representations of $U_{q,t}(\widehat{\mathfrak{gl}}_1)$ on the Fock space $\mathcal{F}(u)$ of a free chiral boson with momentum $u \in \mathbb{C}^\times$ (also called spectral parameter). As we have mentioned above, the representations of the algebra are organized into $\widetilde{SL}(2, \mathbb{Z}) \times \mathfrak{S}_3$ orbits. The family of Fock representations corresponds to the product of the orbit of the vector $(1, 0)$ under $SL(2, \mathbb{Z})$ action⁶ and the orbit of a pair (q, t^{-1}) under permutations of $(q, t^{-1}, t/q)$. Hence, a Fock representation $\mathcal{F}_{q,t^{-1}}^{(r,s)}(u)$ is characterized by a pair of coprime integers (r, s) and a choice of two out of three deformation parameters.

The two examples of $\mathcal{F}_{q,t^{-1}}^{(1,N)}(u)$ ($N \in \mathbb{Z}$) and $\mathcal{F}_{q,t^{-1}}^{(0,1)}(u)$ will be particularly important for our investigation and we write them out explicitly. The two representations are of course related by the $\widetilde{SL}(2, \mathbb{Z})$

⁶The extra \mathbb{Z} part of the universal cover can be absorbed by the shift of the spectral parameter u and the rescaling of the generators.

action, so one may wonder why consider them separately. The reason for this is that we know the action of $U_{q,t}(\widehat{\mathfrak{gl}}_1)$ on Fock representations only in terms of the generating currents $x^\pm(z)$, $\psi^\pm(z)$ on which (unlike on $e_{(n,m)}$ for general (n,m)) the action of $\widetilde{SL}(2, \mathbb{Z})$ is not explicit.

1. $\mathcal{F}_{q,t^{-1}}^{(1,N)}(u)$ usually called the **horizontal Fock representation**. The states of the Fock representation, which we denote $|\lambda, u\rangle$, are labelled by Young diagrams λ . They are in one to one correspondence with monomials of the form $a_{-\lambda_1} \cdots a_{-\lambda_n} |\emptyset, u\rangle$, where a_n , $n \neq 0$ are the creation and annihilation operators satisfying the commutation relations (16) and $|\emptyset, u\rangle$ is the vacuum state annihilated by a_n with $n > 0$.

The action of the generating currents in this representation is [25]

$$x^+(z) = \frac{u (z\sqrt{\frac{q}{t}})^{-N}}{(1-q^{-1})(1-t)} \exp \left[\sum_{n \geq 1} \frac{z^n}{n} (1-t^{-n}) a_{-n} \right] \exp \left[- \sum_{n \geq 1} \frac{z^{-n}}{n} (1-t^n) a_n \right], \quad (114)$$

$$x^-(z) = \frac{u^{-1} (z\sqrt{\frac{q}{t}})^N}{(1-q)(1-t^{-1})} \exp \left[- \sum_{n \geq 1} \frac{z^n}{n} (1-t^{-n}) \left(\frac{t}{q}\right)^{\frac{n}{2}} a_{-n} \right] \exp \left[\sum_{n \geq 1} \frac{z^{-n}}{n} (1-t^n) \left(\frac{t}{q}\right)^{\frac{n}{2}} a_n \right], \quad (115)$$

$$\psi^+(z) = \left(\frac{t}{q}\right)^{-\frac{N}{2}} \exp \left[- \sum_{n \geq 1} \frac{z^{-n}}{n} (1-t^n) \left(1 - \left(\frac{t}{q}\right)^n\right) \left(\frac{q}{t}\right)^{\frac{n}{4}} a_n \right], \quad (116)$$

$$\psi^-(z) = \left(\frac{t}{q}\right)^{\frac{N}{2}} \exp \left[\sum_{n \geq 1} \frac{z^n}{n} (1-t^{-n}) \left(1 - \left(\frac{t}{q}\right)^n\right) \left(\frac{q}{t}\right)^{\frac{n}{4}} a_{-n} \right], \quad (117)$$

$$\gamma = \sqrt{\frac{t}{q}}, \quad (118)$$

$$K = \left(\frac{t}{q}\right)^{\frac{N}{2}}. \quad (119)$$

2. $\mathcal{F}_{q,t^{-1}}^{(0,1)}(u)$ also known as the **vertical Fock representation**. It is convenient write down the action of the generating currents in this representation in the basis of Macodnald polynomials [29], i.e. assume that $|\lambda, u\rangle = P_\lambda^{(q,t)}(a_{-n}) |\emptyset, u\rangle$:

$$x^+(z) |\lambda, u\rangle = \sum_{i=1}^{l(\lambda)+1} A_{\lambda,i}^+ \delta \left(\frac{z}{uq^{\lambda_i} t^{1-i}} \right) |\lambda + 1_i, u\rangle, \quad (120)$$

$$x^-(z) |\lambda, u\rangle = \sum_{i=1}^{l(\lambda)} A_{\lambda,i}^- \delta \left(\frac{z}{uq^{\lambda_i-1} t^{1-i}} \right) |\lambda - 1_i, u\rangle, \quad (121)$$

$$\psi^+(z) |\lambda, u\rangle = \sqrt{\frac{q}{t}} \exp \left[\sum_{n \geq 1} \frac{1}{n} \left(\frac{u}{z}\right)^n (1 - (t/q)^n - \kappa_n \text{Ch}_\lambda(q^n, t^{-n})) \right] |\lambda, u\rangle, \quad (122)$$

$$\psi^-(z) |\lambda, u\rangle = \sqrt{\frac{t}{q}} \exp \left[\sum_{n \geq 1} \frac{1}{n} \left(\frac{z}{u}\right)^n (1 - (q/t)^n + \kappa_n \text{Ch}_\lambda(q^{-n}, t^n)) \right] |\lambda, u\rangle, \quad (123)$$

where $\lambda \pm 1_i$ denotes the Young diagram with λ_i replaced by $\lambda_i \pm 1$, $\text{Ch}_\lambda(q, t)$ is defined in Eq. (15)

and

$$\kappa_n = (1 - q^n)(1 - t^{-n})(1 - (t/q)^n), \quad (124)$$

$$A_{\lambda,i}^+ = \frac{1}{1 - q^{-1}} \prod_{j=1}^i \psi(q^{\lambda_i - \lambda_j} t^{j-i}), \quad (125)$$

$$A_{\lambda,i}^- = -\frac{\sqrt{\frac{t}{q}}}{1 - q} \frac{1 - q^{\lambda_i}}{1 - \frac{t}{q} q^{\lambda_i}} \prod_{j=i+1}^{l(\lambda)} \frac{\psi(q^{\lambda_i - \lambda_j - 1} t^{j-i})}{\psi(q^{\lambda_i - 1} t^{j-i})}, \quad (126)$$

and

$$\psi(x) = \frac{(1 - tx)(1 - \frac{q}{t}x)}{(1 - x)(1 - qx)}. \quad (127)$$

qW_m -reduction and qq -characters. Using the coproduct (109)–(111) one defines the action of the DIM algebra $U_{q,t}(\widehat{\mathfrak{gl}}_1)$ on a tensor product of m horizontal Fock representations with different spectral parameters $\bigotimes_{i=1}^m \mathcal{F}_{q,t^{-1}}^{(1,0)}(u_i)$.

The generators of the DIM algebra in this representation can be expressed in terms of the currents of the smaller algebra: the qW_m -algebra and an extra Heisenberg algebra. qW_m -algebra is generated by currents of spins $s = 2, 3, \dots, m$, which schematically look as follows

$$W^{(s)}(z) \sim \sum_{1 \leq i_1 < i_2 < \dots < i_{s-1} \leq m} u_{i_1} u_{i_2} \dots u_{i_{s-1}} : \Lambda_{i_1}(z) \Lambda_{i_2} \left(\frac{q}{t} z \right) \dots \Lambda_{i_{s-1}} \left(\left(\frac{q}{t} \right)^{s-2} z \right) :, \quad (128)$$

where $\Lambda_i(z)$ are certain free field vertex operators acting on the tensor product of Fock representations. We denote the additional Heisenberg current by $W^{(1)}(z)$.

The currents $W^{(s)}(z)$ are in fact the qq -characters [11] of A_{m-1} type corresponding to fundamental representations $\Lambda^s \mathbb{C}^m$. In qq -character approach the vertex operators $\Lambda_i(z)$ are written in terms of the so-called Y -operators, certain elementary free boson exponents,

$$\Lambda_i(z) = : Y_i \left((t/q)^{\frac{i-1}{2}} z \right) Y_{i-1} \left((t/q)^{\frac{i}{2}} z \right)^{-1} :, \quad (129)$$

where one assumes that $Y_0(z) = Y_m(z) = 1$.

The action of the DIM current $x^+(z)$ on $\bigotimes_{i=1}^m \mathcal{F}_{q,t^{-1}}^{(1,0)}(u_i)$ can be expressed through the two lowest spin W -currents, the Heisenberg current $W^{(1)}(z)$ and q -deformed Virasoro stress-energy tensor $W^{(2)}(z)$. Schematically we have (see [17] for explicit formulas)

$$\begin{aligned} x^+(z) |_{\bigotimes_i \mathcal{F}(u_i)} &\sim W^{(1)}(z) W^{(2)}(z) = W^{(1)}(z) \sum_{i=1}^m u_i \Lambda_i(z) = \\ &= W^{(1)}(z) \sum_{i=1}^m u_i : Y_i \left((t/q)^{\frac{i-1}{2}} z \right) Y_{i-1} \left((t/q)^{\frac{i}{2}} z \right)^{-1} :. \end{aligned} \quad (130)$$

The Heisenberg current $W^{(1)}(z)$ commutes with other W -currents, and thus can be ignored in most formulas⁷.

B Conventions and identities

In this Appendix we summarize some conventions and identities used in the main text. The instanton counting partition function for (quiver) $U(N)$ gauge theories with hypermultiplets in (anti)fundamental,

⁷Notice, how this property of the current $W^{(1)}(z)$ is similar to that of the “empty crossing” $\mathcal{T}_{\emptyset}^{\emptyset}$ from sec. 3 given by Eq. (27). Indeed, $\mathcal{T}_{\emptyset}^{\emptyset}$ depends on the same “diagonal” combination of free bosons $\sum_{i=1}^m (t/q)^{|n|(i-1)/2} a_n^{(i)}$ as the Heisenberg current. However, it includes only the positive modes, whereas $W^{(1)}(z)$ is a standard free field exponent depending on both positive and negative modes.

bi-fundamental and adjoint representations can be obtained using standard Nekrasov formulas [41]. The partition function is expressed as a sum over N -tuples of Young diagrams for each node in the quiver while the summand is given by the products of factors corresponding to each multiplet, which are built from the following combinatorial factor $N_{\mu\nu}(Q)$:

$$\begin{aligned}
N_{\mu\nu}(Q) &= \prod_{(i,j) \in \mu} \left(1 - Q q^{\mu_i - j} t^{\nu_j^T - i + 1}\right) \prod_{(i,j) \in \nu} \left(1 - Q q^{-\nu_i + j - 1} t^{-\mu_j^T + i}\right) \\
&= \prod_{i,j=1}^{\infty} \frac{(1 - Q q^{\mu_i - j} t^{\nu_j^T - i + 1})}{(1 - Q q^{-j} t^{-i + 1})} \\
&= \prod_{i,j=1}^{\infty} \frac{(Q q^{\mu_i - \nu_j} t^{j - i + 1}; q)_{\infty}}{(Q q^{\mu_i - \nu_j} t^{j - i}; q)_{\infty}} \frac{(Q t^{j - i}; q)_{\infty}}{(Q t^{j - i + 1}; q)_{\infty}}.
\end{aligned} \tag{131}$$

There exist more representations of the factor $N_{\mu\nu}(Q)$, but we will only use these three. It is evident from the first expression in Eq. (131) that the factor is a polynomial. It also obeys some nice identities:

$$N_{\mu\nu}(Q) = (-v^{-1}Q)^{|\mu|+|\nu|} q^{\frac{\|\mu\|^2}{2} - \frac{\|\nu\|^2}{2}} t^{-\frac{\|\mu^t\|^2}{2} + \frac{\|\nu^t\|^2}{2}} N_{\mu\nu}(v^2 Q^{-1}), \tag{132}$$

where $|\mu|$ denotes the total number of boxes in the Young diagram μ , $\|\mu\|^2 = \sum_{i=1}^{l(\mu)} \mu_i^2$ with $l(\mu)$ is the number of non-empty rows of μ , and v is a shorthand for $q^{1/2} t^{-1/2}$.

In our calculations, we have used an alternative expression for the contributions of the Y -operators which follows from the identity

$$N_{\mu\Box}(v^2 Q) = (1 - Q) \frac{N_{\mu\emptyset}(t^{-1} Q) N_{\mu\emptyset}(q Q)}{N_{\mu\emptyset}(Q)}. \tag{133}$$

The identity (133) can be proven using the representation of the Nekrasov factor in terms of q -Pochhammer symbols from the third line of Eq. (131).

These factors (133) have convenient degeneration properties, and we make extensive use one of them:

$$N_{\mu\Box}(1) = 0, \quad \text{unless } \mu \in \{\emptyset, \Box\}. \tag{134}$$

Indeed, one can see that the boundary box in the first row, $(1, \mu_1) \in \mu$, produces a vanishing contribution to the product in $N_{\mu\Box}(1)$ unless $\mu = \Box$. Thus, to get a nonvanishing answer for $N_{\mu\Box}(1)$ the Young diagram μ should have the form $[1, 1, \dots, 1]$. Furthermore, a box with coordinates $(2, 1)$ if present also contributes a vanishing factor, so that the only nontrivial possibility for μ is either \Box or \emptyset . This property will allow us to truncate a sum over infinitely many Young diagrams μ to a finite sum with only two terms.

The following useful identity can be proven by summing a geometric progression:

$$(1 - q) \sum_{(i,j) \in \lambda} q^{j-1} t^{n-i+1} = \sum_{i=1}^n (1 - q^{\lambda_i}) t^{n+1-i}, \tag{135}$$

for any $n \geq l(\lambda)$, the length of the Young diagram λ . Eq. (135) implies that

$$\frac{1}{1 - q^{-n}} - (1 - t^n) \text{Ch}_{\lambda}(q^{-n}, t^{-n}) = -\frac{1 - t^n}{1 - q^n} t^{-n/2} q^n p_n(q^{-\lambda} t^{-\rho}), \tag{136}$$

where Ch_{λ} is defined in Eq. (15) and

$$p_n(q^{-\lambda} t^{-\rho}) = \sum_{i=1}^{\infty} q^{-n\lambda_i} t^{n(i-\frac{1}{2})}. \tag{137}$$

C Algebraic engineering of the $U(2)$ theory

In the main text we have introduced the algebraic approach to calculating qq -characters based on the intertwining operators of the DIM algebra \mathcal{A} . For the sake of completeness, we review in this section the

calculation of the instanton partition function of the pure $U(2)$ theory *without* spectator brane insertions using similar technique which may be called algebraic engineering. In [25], the refined topological vertices [21] were shown to be matrix elements of intertwining operators of the DIM algebra between triplets of Fock spaces each labelled by a pair of integers and a spectral parameter. From the Type IIB string view point, these integers are the (p, q) -charges of 5-branes corresponding to Fock representations, while in M-theory they encode the degeneration loci of a toric diagram. The definitions of the Fock representations of the algebra \mathcal{A} are collected in Appendix A.

In our calculations, we use the following intertwining operators between triplets of Fock representations:

$$\begin{aligned}
\Psi^\lambda(x) &= \begin{array}{c} \lambda \downarrow \mathcal{F}_{q,t^{-1}}^{(0,1)}(x) \\ \mathcal{F}_{q,t^{-1}}^{(1,N+1)}(-ux) \swarrow \quad \nwarrow \mathcal{F}_{q,t^{-1}}^{(1,N)}(u) \\ \end{array} = (-ux)^{|\lambda|} (-x)^{-(N+1)|\lambda|} f_\lambda^{-(N+1)} \frac{q^{n(\lambda^T)}}{c_\lambda} \times \\
&\times \exp \left[\sum_{n \neq 0} \frac{x^{-n}}{n} \left(\frac{1}{1-q^{-n}} - (1-t^n) \text{Ch}_\lambda(q^{-n}t^{-n}) \right) a_n \right] := \\
&= (-ux)^{|\lambda|} (-x)^{-(N+1)|\lambda|} f_\lambda^{-(N+1)} \frac{q^{n(\lambda^T)}}{c_\lambda} : \exp \left[- \sum_{n \neq 0} \frac{(q^{-1}t^{1/2}x)^{-n}}{n} \frac{1-t^n}{1-q^n} p_n(q^{-\lambda}t^{-\rho}) a_n \right] : \quad (138)
\end{aligned}$$

and its dual

$$\begin{aligned}
\Psi_\mu^*(y) &= \begin{array}{c} \mathcal{F}_{q,t^{-1}}^{(1,N+1)}(u) \swarrow \\ \mathcal{F}_{q,t^{-1}}^{(1,N)}(-u/y) \leftarrow \quad \rightarrow \\ \mu \downarrow \mathcal{F}_{q,t^{-1}}^{(0,1)}(y) \end{array} = (-q^{-1}uy^{-1})^{-|\mu|} (-y)^{N|\mu|} f_\mu^N \frac{q^{n(\mu^T)}}{c_\mu} \times \\
&\times \exp \left[- \sum_{n \neq 0} \frac{y^{-n}}{n} \left(\frac{t}{q} \right)^{\frac{|n|}{2}} \left(\frac{1}{1-q^{-n}} - (1-t^n) \text{Ch}_\mu(q^{-n}, t^{-n}) \right) a_n \right] := \\
&= (-q^{-1}uy^{-1})^{-|\mu|} (-y)^{N|\mu|} f_\mu^N \frac{q^{n(\mu^T)}}{c_\mu} : \exp \left[\sum_{n \neq 0} \frac{y^{-n}}{n} \frac{1-t^n}{1-q^n} q^{-|n|/2+n} t^{|n|/2-n/2} p_n(q^{-\mu}t^{-\rho}) a_n \right] : \quad (139)
\end{aligned}$$

where Ch_λ , $n(\lambda^T)$, c_λ and f_λ are defined by Eqs.(15), (18)–(20) respectively, and we have used the identity Eq. (136). Note that the $(0, 1)$ -type Fock space $\mathcal{F}_{q,t^{-1}}^{(0,1)}$, whose states are labelled by the diagrams λ and μ in Eqs. (138), (139), is associated with the so-called preferred direction of the refined topological vertex.

The network giving rise to the $U(2)$ gauge theory is depicted in Fig. 15. It consists of two intertwining operators Ψ and two dual intertwining operators Ψ^* .

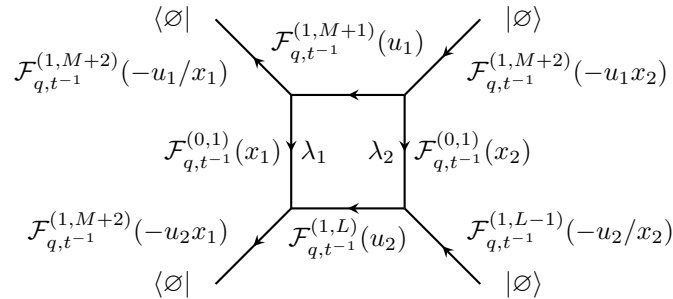

Figure 15: Network of intertwining operators corresponding to the toric CY geometrically engineers $5d$ $U(2)$ pure gauge theory. The sum over the intermediate states λ_1 , λ_2 is assumed.

There are two possible choices for the ‘‘Chern-Simons level’’ for the $5d$ $U(2)$ theory, which is reflected in the choices for the levels of the Fock representations in Fig. 15: $M = -1$ and $L = 0$ corresponds to vanishing Chern-Simons level, and $M = -2$ and $L = 0$ gives rise to level one, all other choices being either inconsistent or equivalent to one of those two.

Generically, the sums over Young diagrams living on the edges along the preferred directions (vertical in Fig. 15) cannot be performed in a closed form for toric geometries with compact four-cycles. Instead they correspond to the instanton sums in the gauge theory that the toric diagram engineers. The same is true in the algebraic approach as well and we will end up with the same instanton sums over Young diagrams. In this Appendix we consider a quiver with a single gauge node, hence a single set of vertical edges stretched between two horizontal branes each associated with a Fock space. On these Fock spaces act two sets of Heisenberg generators commuting with each other:

$$\left[a_n^{(1)}, a_m^{(1)} \right] = \left[a_n^{(2)}, a_m^{(2)} \right] = n \frac{1 - q^{|n|}}{1 - t^{|n|}} \delta_{n+m,0}, \quad (140)$$

$$\left[a_n^{(1)}, a_m^{(2)} \right] = 0, \quad \text{for any } (m, n) \in \mathbb{Z}^2, \quad (141)$$

where the superscripts label the horizontal lines. Two such lines are ‘‘glued’’ to each other along a vertical edge by inserting a complete basis of states in the vertical Fock representation, the basis of Macdonald polynomials,

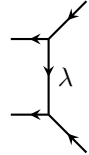

$$\begin{array}{c} \nearrow \\ \leftarrow \\ \downarrow \lambda \\ \leftarrow \\ \searrow \end{array} = \sum_{\lambda} b_{\lambda}(q, t) \Psi_{\lambda}^*(x) \otimes \Psi^{\lambda}(x), \quad (142)$$

where $b_{\lambda}(q, t)$ is defined in Eq. (31). The sums over λ_1, λ_2 living on the vertical edges in Fig. 15 will turn into instanton sums in the gauge theory partition function.

As depicted in Fig. 15 we keep the external states in the horizontal Fock spaces $\mathcal{F}^{(1,N)}$ empty, i.e. we calculate the vacuum-to-vacuum matrix elements of the form $\langle \emptyset | \otimes \langle \emptyset | \dots | \emptyset \rangle \otimes | \emptyset \rangle$. We can proceed in two different ways. We either insert complete sets of states between all the intertwining operators in the picture and calculate matrix elements of the individual operators before performing the sums over intermediate states explicitly, or we construct the screening charges by combining an intertwining operator Ψ with the dual one Ψ^* coupled through a vertical edge. We choose the second method and find that the partition function is given by the vacuum matrix element of the following two operators

$$Z = \sum_{\lambda_1, \lambda_2} \langle \emptyset | \otimes \langle \emptyset | : \prod_{i \geq 1} S(q^{-\frac{1}{2}} x_1 q^{\lambda_{1,i}} t^{\frac{1}{2}-i}) :: \prod_{j \geq 1} S(q^{-\frac{1}{2}} x_2 q^{\lambda_{2,j}} t^{\frac{1}{2}-j}) : | \emptyset \rangle \otimes | \emptyset \rangle, \quad (143)$$

where the screening charge is

$$S(x) = : \exp \left[\sum_{n \neq 0} \frac{1}{n} \frac{1 - t^n}{1 - q^n} (1 + q^n t^{-n}) x^{-n} \alpha_n \right] : \quad (144)$$

and α_n are deformed Heisenberg generators and can be expressed as a linear combination of $a_n^{(1)}, a_n^{(2)}$ generators,

$$\alpha_n \stackrel{\text{def}}{=} \frac{1}{1 + q^{|n|} t^{-|n|}} \left(a_n^{(1)} - q^{|n|/2} t^{-|n|/2} a_n^{(2)} \right). \quad (145)$$

Using the Wick’s theorem for the bosons (145) we get

$$\begin{aligned} & : \prod_{i \geq 1} S(q^{-1/2} x_1 q^{\lambda_{1,i}} t^{1/2-i}) :: \prod_{j \geq 1} S(q^{-1/2} x_2 q^{\lambda_{2,j}} t^{1/2-j}) : = N_{\lambda_2 \lambda_1}^{-1}(x_2/x_1) N_{\lambda_2 \lambda_1}^{-1}(v^2 x_2/x_1) \times \\ & \times : \prod_{i \geq 1} S(q^{-1/2} x_1 q^{\lambda_{1,i}} t^{1/2-i}) \prod_{j \geq 1} S(q^{-1/2} x_2 q^{\lambda_{2,j}} t^{1/2-j}) : . \quad (146) \end{aligned}$$

The normal ordered part in the right hand side of Eq. (146) gives a simple factor when evaluated between the vacuum states. After some straightforward manipulations, we get the following expression for general M and L :

$$Z = \sum_{\lambda_1, \lambda_2} \left(v^{-2} \frac{x_1 u_2}{x_2 u_1} (-x_1)^{M-L+1} \right)^{|\lambda_1|} \left(v^{-2} \frac{x_1 u_2}{x_2 u_1} (-x_2)^{M-L+1} \right)^{|\lambda_2|} f_{\lambda_1}^{M-L+1} f_{\lambda_2}^{M-L+1} \times \\ \times [N_{\lambda_1 \lambda_1}(1) N_{\lambda_2 \lambda_2}(1) N_{\lambda_1 \lambda_2}(x_1/x_2) N_{\lambda_2 \lambda_1}(x_2/x_1)]^{-1}, \quad (147)$$

which reproduces the instanton partition function for $U(2)$ gauge theory after certain identifications between the algebraic and gauge theoretic variables.

D Elliptic deformation of vertex operators and DIM algebra

Elliptic deformation of the DIM algebra as well as its free field representation were introduced in [36]. The deformation of the algebra is written in terms of the generating currents (107), (108) with rational factors in their commutation relations being replaced by Jacobi theta functions with elliptic modulus $p = e^{\pi i \tau}$. The coproduct is formally given by the same formulas (109)–(113) as in the undeformed case.

In this Appendix we briefly review the elliptic deformation prescription for free field vertex operators (see [33] for more details) which produces the elliptic version of the *horizontal* Fock representation of DIM algebra starting from the formulas of Appendix A. We also review the elliptic deformation of the *vertical* Fock representation introduced in [37].

Elliptic deformation of the horizontal Fock representation. Suppose a vertex operator $X(z)$ has the following generic mode expansion,

$$X(z) = \exp \left(\sum_{n>0} X_{-n}^- z^n a_{-n} \right) \exp \left(\sum_{n>0} X_n^+ z^{-n} a_n \right), \quad (148)$$

where a_n are the (q, t) -deformed Heisenberg generators satisfying the commutation relations (16). Notice that the generating currents of DIM algebra in the horizontal Fock representation (120)–(123) also have the form (148).

It turns out that to reproduce elliptically deformed DIM commutation relations it is not enough to deform the commutation relations (16) of the generators a_n . One also has to introduce another set of Heisenberg generators b_n which commute with the original generators and have slightly different commutation relations among themselves. The elliptically deformed commutation relations for the Heisenberg generators with elliptic parameter p are as follows:

$$[a_n, a_m] = n(1 - p^{|n|}) \frac{1 - q^{|n|}}{1 - t^{|n|}} \delta_{m+n, 0}, \quad [b_n, b_m] = n \frac{1 - p^{|n|}}{(qt^{-1}p)^{|n|}} \frac{1 - q^{|n|}}{1 - t^{|n|}} \delta_{m+n, 0} \\ [a_n, b_m] = 0. \quad (149)$$

The the elliptic version $X^{\text{ell}}(z)$ of the vertex operator (148) can be expressed as a product of two vertex operators in terms of both sets of Heisenberg generators,

$$X^{\text{ell}}(z) \stackrel{\text{def}}{=} X^{(a)}(z) X^{(b)}(z), \quad (150)$$

where

$$X^{(a)}(z) \stackrel{\text{def}}{=} \exp \left(\sum_{n>0} \frac{1}{1 - p^n} X_{-n}^- z^n a_{-n} \right) \exp \left(\sum_{n>0} \frac{1}{1 - p^n} X_n^+ z^{-n} a_n \right), \quad (151)$$

$$X^{(b)}(z) \stackrel{\text{def}}{=} \exp \left(- \sum_{n>0} \frac{p^n}{1 - p^n} X_n^- z^{-n} b_{-n} \right) \exp \left(- \sum_{n>0} \frac{p^n}{1 - p^n} X_{-n}^+ z^n b_n \right). \quad (152)$$

Applying the prescription (150)–(152) to DIM algebra generators in the horizontal Fock representation (114)–(117) we obtain the horizontal Fock representation of the elliptic DIM algebra.

Elliptic deformation of the vertical Fock representation. The vertical Fock representation (120)–(123) can be ellipticised without doubling the modes. The recipe for that is to write elliptic Jacobi theta function

$$\theta_p(x) = \prod_{k \geq 0} (1 - p^{k+1})(1 - p^k x) \left(1 - \frac{p^{k+1}}{x}\right) \quad (153)$$

in place of rational monomial $(1 - x)$ in all the coefficient functions:

$$x_{\text{ell}}^+(z)|\lambda, u\rangle = \sum_{i=1}^{l(\lambda)+1} A_{\lambda,i}^{+,\text{ell}} \delta\left(\frac{z}{uq^{\lambda_i}t^{1-i}}\right) |\lambda + 1_i, u\rangle, \quad (154)$$

$$x_{\text{ell}}^-(z)|\lambda, u\rangle = \sum_{i=1}^{l(\lambda)} A_{\lambda,i}^{-,\text{ell}} \delta\left(\frac{z}{uq^{\lambda_i-1}t^{1-i}}\right) |\lambda - 1_i, u\rangle, \quad (155)$$

$$\psi_{\text{ell}}^+(z)|\lambda, u\rangle = \sqrt{\frac{q}{t}} \exp \left[\sum_{n \neq 0} \frac{1}{n} \frac{1}{1-p^n} \left(\frac{u}{z}\right)^n (1 - (t/q)^n - \kappa_n \text{Ch}_\lambda(q^n, t^{-n})) \right] |\lambda, u\rangle, \quad (156)$$

$$\psi_{\text{ell}}^-(z)|\lambda, u\rangle = \sqrt{\frac{t}{q}} \exp \left[\sum_{n \neq 0} \frac{1}{n} \frac{1}{1-p^n} \left(\frac{z}{u}\right)^n (1 - (q/t)^n + \kappa_n \text{Ch}_\lambda(q^{-n}, t^n)) \right] |\lambda, u\rangle, \quad (157)$$

where

$$A_{\lambda,i}^+ = \frac{1}{\theta_p(q^{-1})} \prod_{j=1}^i \psi_{\text{ell}}(q^{\lambda_i - \lambda_j} t^{j-i}), \quad (158)$$

$$A_{\lambda,i}^- = -\frac{\sqrt{\frac{t}{q}} \theta_p(q^{\lambda_i})}{\theta_p(q) \theta_p\left(\frac{t}{q} q^{\lambda_i}\right)} \prod_{j=i+1}^{l(\lambda)} \frac{\psi_{\text{ell}}(q^{\lambda_i - \lambda_j - 1} t^{j-i})}{\psi_{\text{ell}}(q^{\lambda_i - 1} t^{j-i})}, \quad (159)$$

and

$$\psi_{\text{ell}}(x) = \frac{\theta_p(tx) \theta_p\left(\frac{q}{t}x\right)}{\theta_p(x) \theta_p(qx)}. \quad (160)$$

References

- [1] V. G. Drinfeld, Proc. ICM Berkeley (1986), 798–820.
- [2] M. Jimbo, Lett. Math. Phys. **10** (1985), 63–69.
- [3] R. J. Baxter, *Exactly solved models in statistical mechanics*, doi:10.1142/9789814415255_0002
- [4] E. Witten, Commun. Math. Phys. **121** (1989), 351–399 doi:10.1007/BF01217730
- [5] J. A. Minahan, J. Phys. A **39** (2006), 12657–12677 doi:10.1088/0305-4470/39/41/S02
- [6] N. A. Nekrasov and S. L. Shatashvili, Prog. Theor. Phys. Suppl. **177** (2009), 105–119 doi:10.1143/PTPS.177.105 [arXiv:0901.4748 [hep-th]].
- [7] V. V. Bazhanov, S. L. Lukyanov and A. B. Zamolodchikov, Commun. Math. Phys. **177** (1996), 381–398 doi:10.1007/BF02101898 [arXiv:hep-th/9412229 [hep-th]].
- [8] V. V. Bazhanov, S. L. Lukyanov and A. B. Zamolodchikov, Commun. Math. Phys. **190** (1997), 247–278 doi:10.1007/s002200050240 [arXiv:hep-th/9604044 [hep-th]].
- [9] V. V. Bazhanov, S. L. Lukyanov and A. B. Zamolodchikov, Commun. Math. Phys. **200** (1999), 297–324 doi:10.1007/s002200050531 [arXiv:hep-th/9805008 [hep-th]].
- [10] H. Knight, Journal of Algebra, **174** (1995) 1, 187–196, ISSN 0021-8693, <https://doi.org/10.1006/jabr.1995.1123>.

- [11] E. Frenkel and N. Reshetikhin, [arXiv:q-alg/9708006 [q-alg]]
E. Frenkel and N. Reshetikhin, [arXiv:math/9810055 [math.QA]].
- [12] H. Nakajima, *Physics and Combinatorics*, 196–219 (2001),
https://doi.org/10.1142/9789812810007_0009, [arXiv:math/0009231 [math.QA]]
H. Nakajima, [arXiv:math/0105173 [math.QA]]
H. Nakajima, [arXiv:math/0204184 [math.QA]]
- [13] H. Liu, *SIGMA* **18** (2022), 090, <https://doi.org/10.3842/SIGMA.2022.090> [arXiv:2203.07072 [math.QA]]
- [14] J. Ding, K. Iohara, *Lett. Math. Phys.* **41** (1997) 181–193, q-alg/9608002
K. Miki, *J. Math. Phys.* **48** (2007) 123520
- [15] H. Awata, H. Kanno, A. Mironov, A. Morozov, A. Morozov, Y. Ohkubo and Y. Zenkevich, *JHEP* **10** (2016), 047 doi:10.1007/JHEP10(2016)047 [arXiv:1608.05351 [hep-th]].
H. Awata, H. Kanno, A. Mironov, A. Morozov, A. Morozov, Y. Ohkubo and Y. Zenkevich, *Nucl. Phys. B* **918** (2017), 358–385 doi:10.1016/j.nuclphysb.2017.03.003 [arXiv:1611.07304 [hep-th]].
- [16] Y. Zenkevich, *JHEP* **12** (2021), 027 doi:10.1007/JHEP12(2021)027 [arXiv:2012.15563 [hep-th]].
- [17] A. Mironov, A. Morozov and Y. Zenkevich, *Phys. Lett. B* **762** (2016), 196–208 doi:10.1016/j.physletb.2016.09.033 [arXiv:1603.05467 [hep-th]].
- [18] J. E. Bourguine, M. Fukuda, K. Harada, Y. Matsuo and R. D. Zhu, *JHEP* **11** (2017), 034 doi:10.1007/JHEP11(2017)034 [arXiv:1703.10759 [hep-th]].
- [19] T. Kimura, H. Mori and Y. Sugimoto, *JHEP* **01** (2018), 025 doi:10.1007/JHEP01(2018)025 [arXiv:1705.03467 [hep-th]].
- [20] S. M. Khoroshkin, V. N. Tolstoy, V. N. Tolstoy, S. M. Khoroshkin, *Commun. Math. Phys.* **141**, 599–617 (1991). <https://doi.org/10.1007/BF02102819>
Functional Analysis and Its Applications **26**, 69–71 (1992). <https://doi.org/10.1007/BF01077085>
- [21] H. Awata and H. Kanno, *JHEP* **05** (2005), 039 doi:10.1088/1126-6708/2005/05/039 [arXiv:hep-th/0502061 [hep-th]].
A. Iqbal, C. Kozcaz and C. Vafa, *JHEP* **0910** (2009) 069 doi:10.1088/1126-6708/2009/10/069 [hep-th/0701156].
- [22] R. Gopakumar and C. Vafa, *Adv. Theor. Math. Phys.* **3**, 1415–1443 (1999) doi:10.4310/ATMP.1999.v3.n5.a5 [arXiv:hep-th/9811131 [hep-th]].
- [23] N. C. Leung and C. Vafa, *Adv. Theor. Math. Phys.* **2**, 91–118 (1998) doi:10.4310/ATMP.1998.v2.n1.a4 [arXiv:hep-th/9711013 [hep-th]].
- [24] N. Nekrasov, *JHEP* **1603** (2016) 181 doi:10.1007/JHEP03(2016)181 [arXiv:1512.05388 [hep-th]].
N. Nekrasov, *Adv. Theor. Math. Phys.* **21** (2017) 503 doi:10.4310/ATMP.2017.v21.n2.a4 [arXiv:1608.07272 [hep-th]].
N. Nekrasov, *Commun. Math. Phys.* **358** (2018) no.3, 863 doi:10.1007/s00220-017-3057-9 [arXiv:1701.00189 [hep-th]].
N. Nekrasov, arXiv:1711.11011 [hep-th], arXiv:1711.11582 [hep-th].
- [25] H. Awata, B. Feigin and J. Shiraishi, *JHEP* **03** (2012), 041 doi:10.1007/JHEP03(2012)041 [arXiv:1112.6074 [hep-th]].
- [26] Y. Zenkevich, [arXiv:2212.14808 [hep-th]].
- [27] Y. Zenkevich, *JHEP* **08** (2021), 149 doi:10.1007/JHEP08(2021)149 [arXiv:1812.11961 [hep-th]].
- [28] Y. Zenkevich, *JHEP* **03** (2023), 193 doi:10.1007/JHEP03(2023)193 [arXiv:2112.14687 [math.QA]].
- [29] I. G. Macdonald, *Symmetric functions and Hall polynomials*, Second Edition, Oxford University Press, 1995

- [30] T. Kimura and V. Pestun, arXiv:1512.08533 [hep-th].
T. Kimura and V. Pestun, arXiv:1705.04410 [hep-th].
- [31] T. Kimura and V. Pestun, arXiv:1608.04651 [hep-th].
- [32] F. Nieri, *Lett. Math. Phys.* **107** (2017) no.11, 2147-2187 doi:10.1007/s11005-017-0986-3 [arXiv:1511.00574 [hep-th]].
A. Iqbal, C. Kozçaz and S. T. Yau, [arXiv:1511.00458 [hep-th]].
- [33] M. Ghoneim, C. Kozçaz, K. Kurşun and Y. Zenkevich, *Nucl. Phys. B* **978** (2022), 115740 doi:10.1016/j.nuclphysb.2022.115740 [arXiv:2012.15352 [hep-th]].
- [34] H. Awata, H. Kanno, A. Mironov, A. Morozov, K. Suetake and Y. Zenkevich, *JHEP* **04** (2019), 097 doi:10.1007/JHEP04(2019)097 [arXiv:1810.07676 [hep-th]].
- [35] V. V. Bazhanov and S. M. Sergeev, *J. Phys. A* **39** (2006), 3295-3310 doi:10.1088/0305-4470/39/13/009 [arXiv:hep-th/0509181 [hep-th]].
- [36] Y. Saito, [arXiv:1301.4912 [math.QA]].
- [37] L. Wang, K. Wu, , J. Yang, Z. Yang, *Front. Math. China* **15**, 155–166 (2020).
<https://doi.org/10.1007/s11464-020-0815-3>
- [38] N. Haouzi and C. Kozçaz, *Commun. Math. Phys.* **393** (2022) no.2, 669-779 doi:10.1007/s00220-022-04375-0 [arXiv:1907.03838 [hep-th]].
- [39] S. Nawata, K. Zhang and R. D. Zhu, [arXiv:2302.00525 [hep-th]].
- [40] T. J. Hollowood, A. Iqbal and C. Vafa, *JHEP* **03** (2008), 069 doi:10.1088/1126-6708/2008/03/069 [arXiv:hep-th/0310272 [hep-th]].
- [41] N. A. Nekrasov, *Adv. Theor. Math. Phys.* **7** (2003) no.5, 831-864 doi:10.4310/ATMP.2003.v7.n5.a4 [arXiv:hep-th/0206161 [hep-th]].