

# Quantum GravitoElectromagnetic Dynamics

Yoshimasa Kurihara\*

*The High Energy Accelerator Organisation (KEK), Tsukuba, Ibaraki 305-0801, Japan*

August 11, 2023

## Abstract

We propose a renormalisable quantum theory of gravity (QGED) based on the standard BRST quantisation used to quantise the Yang–Mills theory. The BRST-invariant Lagrangian of the gravitationally interacting  $U(1)$ -gauge theory, including gauge fixing and ghost parts, is provided. From this Lagrangian, we extract a set of Feynman rules in the local inertial frame where gravity vanishes locally. Utilising Feynman rules of the QGED prepared here, we construct all renormalisation constants and show that the theory is perturbatively renormalisable in one-loop order. We replace infinite-valued bare objects in the bare Lagrangian with experimentally measured ones. In addition to standard QED parameters, we show that the gravitational coupling constant is measurable experimentally.

We also discuss a running effect of the gravitational coupling constant and the perturbative estimation of the Hawking radiation as examples of the perturbative QGED.

## Contents

<b>1</b>	<b>Introduction</b>	<b>2</b>
<b>2</b>	<b>Mathematical preliminaries</b>	<b>3</b>
2.1	Space-time manifold . . . . .	3
2.2	Principal bundles . . . . .	4
2.3	Connections and curvatures . . . . .	5
2.3.1	Standard definition . . . . .	5
2.3.2	Coupling constant . . . . .	6
2.4	Spinor-gauge bundle . . . . .	7
<b>3</b>	<b>QGED Lagrangian</b>	<b>8</b>
3.1	Bare Lagrangian . . . . .	8
3.2	BRST transformation . . . . .	9
3.2.1	Yang–Mills theory . . . . .	9
3.2.2	General relativity . . . . .	10
3.3	Ghost and gauge fixing Lagrangian . . . . .	12
3.3.1	Yang–Mills theory . . . . .	12
3.3.2	General relativity . . . . .	13
<b>4</b>	<b>QGED Feynman rules</b>	<b>15</b>
4.1	Green’s function of vierbein and spin-connection fields . . . . .	15
4.2	External field . . . . .	16
4.2.1	Electromagnetic part . . . . .	16
4.2.2	Gravitational part: . . . . .	17
4.3	Vertices . . . . .	20
4.4	Propagators . . . . .	21
4.5	Integration measure and S-matrix . . . . .	23

---

\*yoshimasa.kurihara@kek.jp

<b>5</b>	<b>Renormalisation of the QGED</b>	<b>23</b>
5.1	Power counting . . . . .	24
5.2	One-loop renormalisation . . . . .	25
5.2.1	Renormalisation constants . . . . .	25
5.2.2	Photon and spin-connection renormalisation . . . . .	25
5.2.3	Electron field and mass renormalisation . . . . .	28
5.2.4	Coupling constant renormalisation . . . . .	30
5.2.5	Determination of coupling constants and electron mass . . . . .	31
5.3	Gravitational running coupling and the Landau pole . . . . .	32
<b>6</b>	<b>Particle creation in the strong field</b>	<b>33</b>
6.1	Schwinger effect in the QED . . . . .	33
6.2	Hawking radiation in the QGED . . . . .	36
<b>7</b>	<b>Summary</b>	<b>37</b>
<b>A</b>	<b>Proof of nilpotent</b>	<b>39</b>
<b>B</b>	<b>Measurement of the gravitational coupling constant</b>	<b>41</b>

# 1 Introduction

For the microscopic aspect of Nature, the standard theory of particle physics based on quantum field theory has many experimental supports. On the other hand, general relativity is among the fundamental theories concerning the large space-time structure of the Universe, and many experiments have established its correctness. Thus, our understanding of Nature covers a wide range of lengthscales and timescales, from the Universe’s large-scale structure to the microscopic behaviour of subatomic particles. However, two fundamental theories are inconsistent; the former is quantum, and the latter is a classical theory. Owing to the uncertainty principle, the fundamental physical theory must be a quantum theory; thus, constructing a quantum theory of gravity is one of the fundamental goals of modern physics.

We understand the *quantum theory of gravity* as a theory that describes the behaviour of four-dimensional space-time (the metric tensor) in regions where the uncertainty principle is essential and a theory consistent with well-established general relativity at large space-time scales. Moreover, a theory that can provide experimentally measurable predictions is desirable. Immediately after the establishment of general relativity and quantum mechanics during the 1920s, the development of quantum gravity began in the 1930s. For a detailed history, see Refs.[1, 2] and references therein. It is commonly recognised that perturbative expansion of general relativity in four-dimensional space-time is not renormalisable. Although trials to construct a perturbatively renormalised theory of general relativity have failed, its non-existence has yet to be proven. The current author discussed the renormalisability of four-dimensional general relativity in[3, 4, 5]. On the other hand, the quantisation of the Yang–Mills theory in flat space-time is well established, and the theory is proven to be renormalisable in all orders of perturbation expansions. However, it is not proven in curved space-time and is not trivial. A primary objective of this report is to construct the renormalisable quantum gravity with the Yang–Mills theory simultaneously.

General relativity is a kind of gauge theory, which is at first developed in a pioneering work by Utiyama[6] (see also Ref.[7]). Common aspects between general relativity and the Yang–Mills theory may give a hint for renormalisable perturbation for general relativity. We summarise correspondences of mathematical properties between them in Table-1. Comparing two gauge theories, it is clear that the spin-connection (gauge potential) and vierbein field (section) are appropriate targets of quantisation[8]. Moreover, the gravitational coupling constant must be included in the Lagrangian, and it must be renormalised, even if it is unity valued after renormalisation, which is not considered in previous studies. Renormalizability of the Yang-Mills theory must be ensured, including gravitational fields  $\mathcal{E}$  and  $\omega$ . In the curved space-time, the Yang-Mills Lagrangian also has an interaction term of Dirac spinor  $\psi$ , spin-connection  $\omega$  and vierbein  $\mathcal{E}$ [9]. In this report, we develop quantum general relativity quantised with the U(1)-gauge theory, namely the “Quantum GravitoElectromagnetic Dynamics (QGED)”.

Table 1: Comparison between general relativity and the Yang–Mills theory at a classical level.

Property	General Relativity	Electromagnetism	dimension
structural group	$SO(1, 3)$	$Spin(1, 3) \oplus SU(N)$	
connection	spin-connection: $\omega_\mu^{ab}$	gauge potential: $\mathcal{A}^\mu$	$L^{-1}$
curvature	curvature: $R_{cd}^{ab}/\kappa_E \hbar$	field strength: $\mathcal{F}^{\mu\nu}$	$L^{-2}$
section	vierbein: $\mathcal{E}_a^\mu/\sqrt{\kappa_E \hbar}$	Dirac spinor: $\psi^{2/3}$	$L^{-1}$
coupling constant	$c_{gr}$	$e$	$1$

The QGED does not quantise space-time itself; thus, the space-time coordinates  $x^\mu$  are not the quantum operator but the classical continuous object[10, 11]. The subject for quantisation is the vierbein field (equivalently, the metric tensor  $g_{\mu\nu}^{(c)}(x)$ ), which is obtained as a solution of the Einstein equation. In classical general relativity, the geometrical metric tensor  $g_{\mu\nu}^{(g)}(x)$  is given by the solution of the classical Einstein equation, such as  $g_{\mu\nu}^{(c)}(x) = g_{\mu\nu}^{(g)}(x)$ , i.e., it is Einstein’s equivalence principle. This relation is not simply true at the quantum level, and the geometrical metric tensor is given as the expected value of the quantum metric tensor  $g_{\mu\nu}^{(g)}(x) = \langle g_{\mu\nu}^{(g)}(x) \rangle$ .

This report is organised as follows: After this introduction section, **section 2** provides mathematical preliminaries describing geometrical backgrounds of general relativity and the Yang–Mills theory based on Ref.[12]. We introduce a gravitational coupling constant in a covariant differential concerning a local  $SO(1, 3)$  group. Although this method is not standard in general relativity, it is commonly utilised in the Yang–Mills theory. **Section 3** introduces the classical (un-renormalised) QGED Lagrangian consisting of the pure and interaction Lagrangian for general relativity and the Yang–Mills theory. The interaction Lagrangian includes a gravitational interaction between a fermion and a gravitational gauge boson. In addition to that, we have to include a gauge fixing and ghost Lagrangian to quantise this system. In this section, we give all necessary Lagrangians and show their BRST invariance, ensuring the gauge theory’s quantisation. From the QGED Lagrangian given in **section 3**, **section 4** extracts Feynman rules for the perturbative calculation of amplitudes. Successively, **section 4** develops the renormalised QGED using Feynman rules given in **section 3**. We prepare all necessary renormalisation constants and show that all ultraviolet divergences are absorbed in a finite number of renormalisation constants at the one-loop level. Consequently, the renormalisation-group equation provides an energy scale dependence of the effective gravitational coupling (a running gravitational coupling). **Section 5** provides an application of the QGED, i.e., the Hawking radiation from the Schwarzschild black hole in contrast with the Schwinger effect of the QED. Finally, the summary section summarises the main results of this report and discusses essential aspects of the QGED. In addition, we provide two appendixes, a proof of nilpotent for all fields appearing in the Lagrangian in **Appendix A** and the possible method to measure the gravitational coupling constant in particle physics experiments by **Appendix B**.

We use the following physical units in this study: We set the speed of light and the vacuum permittivity to unity as  $c = 1$  and  $\epsilon_0 = 1$ . Einstein’s constant of gravitation,  $\kappa_E = G_N/8\pi$ , and reduced Planck-constant,  $\hbar = h/2\pi$ , are written explicitly, where  $G_N$  is the Newtonian constant of gravitation. We define the elementary charge,  $e$ , appearing in the Lagrangian as a dimensionless object, and the fine-structure constant is  $\alpha = e^2/4\pi$ . In these units, physical dimensions of fundamental constants are  $[\hbar G_N]_{\text{p.d.}} = L^2 = T^2$  and  $[\hbar/G_N]_{\text{p.d.}} = E^2 = M^2$ , where  $L$ ,  $T$ ,  $E$  and  $M$  are respectively length, time, energy and mass dimensions. Here,  $[\bullet]_{\text{p.d.}}$  gives a physical dimension of the quantity  $\bullet$ . Planck mass  $m_p$  and Planck length  $l_p$  are respectively defined as  $m_p := \sqrt{\hbar/G_N}$  and  $l_p := \sqrt{\hbar G_N}$ . We also introduce  $L_p = \sqrt{2\hbar\kappa_E}$ .

## 2 Mathematical preliminaries

### 2.1 Space-time manifold

We introduce a four-dimensional Riemannian manifold  $(\mathcal{M}, \mathbf{g})$ , where  $\mathcal{M}$  is a smooth and oriented four-dimensional manifold, and  $\mathbf{g}$  is a metric tensor with a negative signature in  $\mathcal{M}$ . We refer to  $\mathcal{M}$  as the global manifold. In an open neighbourhood  $U_{p \in \mathcal{M}} \subset \mathcal{M}$ , we introduce the standard coordinate  $x^\mu$ . Orthonormal

bases in  $T\mathcal{M}_p$  and  $T^*\mathcal{M}_p$  are denoted as  $\partial/\partial x^\mu$  and  $dx^\mu$ , respectively. Abbreviation  $\partial_\mu := \partial/\partial x^\mu$  is used throughout this report. Two trivial vector bundles  $T\mathcal{M} := \bigcup_p T\mathcal{M}_p$  and  $T^*\mathcal{M} := \bigcup_p T^*\mathcal{M}_p$  are referred to as a tangent and cotangent bundles in  $\mathcal{M}$ , respectively.

An inertial system, in which the Levi-Civita connection vanishes, exists locally at any point in  $\mathcal{M}$ . An inertial frame at point  $p \in \mathcal{M}$  is denoted as  $\mathcal{M}_p$ ; namely, a local inertial manifold at point  $p$ .  $\mathcal{M}_p$  has a  $SO(1,3)$  symmetry. A trivial bundle  $\mathcal{M} := \bigcup_{p \in \mathcal{M}} \mathcal{M}_p$  is referred to as the inertial bundle. Trivial bundles  $T\mathcal{M} := \bigcup_p T\mathcal{M}_p$  and  $T^*\mathcal{M} := \bigcup_p T^*\mathcal{M}_p$  also exist over  $\mathcal{M}$ . In an open neighbourhood  $U_{p \in \mathcal{M}} \subset \mathcal{M}$ , we introduce the standard coordinate  $\xi^a$ . Roman letter suffixes are used for components of the standard basis in  $T\mathcal{M}_p$  throughout this study; on the other hand, Greek letters are used for them in  $\mathcal{M}_p$ . This convention allows us to distinguish two abbreviated vectors, such as  $\partial_\mu \in V(T\mathcal{M})$  and  $\partial_a = \partial/\partial \xi^a \in V(T\mathcal{M})$ . The metric tensor in  $\mathcal{M}_p$  is  $\boldsymbol{\eta} = \text{diag}(1, -1, -1, -1)$ . The Levi-Civita tensor (complete anti-symmetric tensor)  $\epsilon$ , whose component is  $[\epsilon]_{0123} = \epsilon_{0123} = +1$ , and  $\boldsymbol{\eta}$  are constant tensors in  $\mathcal{M}$ .

We define the vierbein  $\mathcal{E}_\mu^a(x) \in C^\infty(\mathcal{M})$  as a map transferring a vector in  $T^*\mathcal{M}$  to that in  $T^*\mathcal{M}$  such that:

$$\mathcal{E}_\mu^a(x \in T^*\mathcal{M})dx^\mu \Big|_{p \in \mathcal{M}_p} = d\xi^a \Big|_{p \in \mathcal{M}_p} \in \Omega^1(T^*\mathcal{M}) \otimes \mathfrak{so}(1,3),$$

where  $\Omega^p(\bullet)$  is a space of  $p$ -form objects defined in bundle  $\bullet$ . The vierbein is a smooth and invertible function globally defined in  $\mathcal{M}$ . The standard bases in  $T^*\mathcal{M}$  is referred to as the vierbein one-form denoted as  $\mathbf{e}^a := \mathcal{E}_\mu^a dx^\mu$ . The vierbein inverse  $[\mathcal{E}^{-1}]_a^\mu = \mathcal{E}_a^\mu \in C^\infty(\mathcal{M})$ , which is also called the vierbein, is an inverse transformation such that

$$\mathcal{E}_\mu^a(x)\mathcal{E}_a^\nu(\xi(x)) = \delta_\mu^\nu \in T^*\mathcal{M}, \text{ and } \mathcal{E}_a^\mu(\xi)\mathcal{E}_\mu^b(x(\xi)) = \delta_a^b \in T^*\mathcal{M}.$$

Metric tensors in  $\mathcal{M}$  and  $\mathcal{M}$  are related to each other such that:  $\eta_{ab} = \mathcal{E}_a^\mu \mathcal{E}_b^\nu g_{\mu\nu}$ . The  $GL(4)$  invariant two-, three- and four-dimensional volume forms are, respectively, defined using vierbein forms as

$$\begin{aligned} \mathfrak{S}_{ab} &:= \frac{1}{2} \epsilon_{ab\circ\circ} \mathbf{e}^\circ \wedge \mathbf{e}^\circ, \\ \mathfrak{V}_a &:= \frac{1}{3!} \epsilon_{a\circ\circ\circ} \mathbf{e}^\circ \wedge \mathbf{e}^\circ \wedge \mathbf{e}^\circ, \\ \mathfrak{v} &:= \frac{1}{4!} \epsilon_{\circ\circ\circ\circ} \mathbf{e}^\circ \wedge \mathbf{e}^\circ \wedge \mathbf{e}^\circ \wedge \mathbf{e}^\circ = \det[\mathcal{E}] dx^0 \wedge dx^1 \wedge dx^2 \wedge dx^3, \end{aligned}$$

which give the standard orthonormal bases of two-, three- and four-forms.

## 2.2 Principal bundles

We introduce a spin structure into  $\mathcal{M}$  using a spinor group  $Spin(1,3)$ . A  $Spin(1,3)$  group doubly covers a  $SO(1,3)$  group such that  $Spin(1,3) \cong SO(1,3) \times_{\mathbb{Z}_2} U(1)$  under covering map  $\tau_{cov} : Spin(1,3) \rightarrow SO(1,3) \otimes \{\pm 1\}$ . The principal spinor bundle is a tuple of

$$(\mathcal{S}_{sp}, \pi_{sp}, \mathcal{M}, Spin(1,3)),$$

whose total space is Clifford module  $\mathcal{S}_{sp} = \mathcal{Cl}(1,3) \otimes \mathbb{C}$ , where  $\mathcal{Cl}$  is Clifford algebra. Projection map  $\pi_{sp}$  is provided owing to the covering map as

$$\pi_{sp} := \tau_{cov}/\{\pm 1\} : \mathcal{S}_{sp} \otimes \mathcal{M} \rightarrow \mathcal{M}/\{\pm 1\} : \psi|_p \mapsto p \in \mathcal{M},$$

where  $\psi \in \Gamma(\mathcal{M}, \mathcal{S}_{sp})$ . Here,  $\Gamma(\bullet, \star)$  is a section belonging object  $\star$  defined in manifold  $\bullet$ . An  $SO(1,3)$  group of the inertial bundle is lifted to  $Spin(1,3)$  owing to projection map  $\pi_{sp}$ ; thus, a spin structure is induced globally in  $\mathcal{M}$ . We assume the existence of a spin structure globally.

A principal gauge bundle is defined as a tuple such that:

$$\left( T^*\mathcal{M}^{\otimes N}, \pi_{SU}, \mathcal{M}, SU(N) \right), \text{ where } T^*\mathcal{M}^{\otimes N} := \overbrace{T^*\mathcal{M} \otimes \cdots \otimes T^*\mathcal{M}}^N.$$

A space of complex-valued scalar fields, namely the Higgs field  $\phi = (\phi^1, \phi^2, \dots, \phi^N)^T$ , is introduced as a section  $\phi \in \Phi = \Gamma(\mathcal{M}, \Omega^0(T^*\mathcal{M}^{\otimes N}) \otimes SU(N))$  belonging to the fundamental representation of the  $SU(N)$  symmetry.  $SU(N)$  group operator  $G_{SU}$  acts on the section as

$$[G_{SU}(\phi)]^I = [g_{SU}]_J^I \phi^J,$$

where  $g_{SU}$  is a unitary matrix with  $\det[g_{SU}] = 1$ . Lie algebra of  $SU(N)$  group is

$$[\tau_I, \tau_J] := i \sum_K f_{IJK} \tau_K,$$

where  $f_{\dots}$  is a structure constant of  $SU(N)$ , and  $\tau = (\tau_1, \tau_2, \dots, \tau_{N^2-1}) \in \mathfrak{su}(N)$ .

A spinor-gauge bundle is a Whitney sum of spinor and gauge bundles which is a tuple such as

$$(\mathcal{S}_{sp}^{\otimes N}, \pi_{sp} \oplus \pi_{SU}, \mathcal{M}, Spin(1,3) \otimes SU(N)) \text{ where } \mathcal{S}_{sp}^{\otimes N} := \overbrace{\mathcal{S}_{sp} \otimes \dots \otimes \mathcal{S}_{sp}}^N.$$

The total space of the gauge bundle is lifted to the spin manifold.

## 2.3 Connections and curvatures

This section introduces connections and curvatures in principal bundles given in previous section. In physics, a connection provides a gauge-boson field mediating a force between matter fields, and a curvature is named a field strength and provides, e.g., electromagnetic fields in the  $U(1)$  gauge theory. The Lagrangian consists of the covariant differential of matter and gauge fields, ensuring the gauge invariance of the theory. The covariant differential includes a *coupling constant* in physics, which provides relative strength among fundamental forces in Nature.

On the other hand, the standard treatment of the connection and the curvature in mathematics does not include a coupling constant in their definitions. We introduce the gravitational coupling constant to simultaneously discuss a gravitational force and other forces. We first provide the standard definitions of the connection and the curvature in general relativity; then, we introduce the gravitational coupling constant in our theory.

### 2.3.1 Standard definition

We introduce connection one-form  $\hat{\omega}$  in the spinor bundle, namely the spin-connection form. An object with a hat,  $\hat{\bullet}$ , represents one by the standard definition in this section. The  $SO(1,3)$ -covariant differential of the  $p$ -form object  $\mathbf{a}^{a_1 a_2 \dots a_p} \in \Omega^p(T^*\mathcal{M}) \otimes V^q(TM)$  is defined using the spin-connection form as

$$d_{\hat{\omega}} \mathbf{a}^{a_1 \dots a_p} := d\mathbf{a}^{a_1 \dots a_p} + \hat{\omega}^{a_1}_{\circ} \wedge \mathbf{a}^{\circ a_2 \dots a_p} + \hat{\omega}^{a_2}_{\circ} \wedge \mathbf{a}^{a_1 \circ \dots a_p} + \dots + \hat{\omega}^{a_p}_{\circ} \wedge \mathbf{a}^{a_1 \dots \circ}, \quad (1a)$$

The spin-connection form has a component representation as

$$\hat{\omega}^a_b = \hat{\omega}_{\mu}^a_b dx^{\mu}, \quad (1b)$$

concerning the standard bases. Dummy *Roman* indices are often abbreviated to a small circle  $\circ$  (and  $\star, \times, \dots$ ) when the dummy-index pair of the Einstein convention is obvious as above. When multiple circles appear in an expression, the pairing must be in a left-to-right order at the subscripts and superscripts. Raising and lowering indices are done using metric tensor  $\eta$  in  $\mathcal{M}$ . Two-form object

$$\hat{\mathfrak{T}}^a := d_{\hat{\omega}} \mathbf{e}^a = d\mathbf{e}^a + \hat{\omega}^a_{\circ} \wedge \mathbf{e}^{\circ} \in \Omega^2(T^*\mathcal{M}) \otimes V^1(TM) \quad (2a)$$

is referred to as a torsion form. We define a component of the torsion two-form using the standard bases as

$$(2a) =: \frac{1}{2} \hat{T}^a_{\mu\nu} dx^{\mu} \wedge dx^{\nu}. \quad (2b)$$

Local  $SO(1, 3)$  group action  $G_{SO} : T^*\mathcal{M} \rightarrow T^*\mathcal{M}$  is known as the Lorentz transformation. That for the vierbein form and the spin-connection form are

$$G_{SO} : \mathbf{e} \mapsto G_{SO}(\mathbf{e}) = \mathbf{e}' = \mathbf{\Lambda} \mathbf{e}, \quad (3a)$$

$$G_{SO} : \hat{\mathbf{w}} \mapsto G_{SO}(\hat{\mathbf{w}}) = \hat{\mathbf{w}}' = \mathbf{\Lambda} \hat{\mathbf{w}} \mathbf{\Lambda}^{-1} + \mathbf{\Lambda} d\mathbf{\Lambda}^{-1}. \quad (3b)$$

The section belongs to the fundamental representation, and the connection does to adjoint one. A space-time curvature (or simply curvature) is defined owing to the structure equation as

$$\hat{\mathfrak{R}}^{ab} := d\hat{\mathbf{w}}^{ab} + \hat{\mathbf{w}}^a \wedge \hat{\mathbf{w}}^{ob} \in \Omega^2(T^*\mathcal{M}) \otimes V^2(TM), \quad (4)$$

which is a two-form valued rank-2 tensor represented using the trivial basis as

$$\hat{\mathfrak{R}}^{ab} = \sum_{\mu < \nu} \hat{\mathcal{R}}^{ab}_{\mu\nu} dx^\mu \wedge dx^\nu = \frac{1}{2} \hat{\mathcal{R}}^{ab}_{\mu\nu} dx^\mu \wedge dx^\nu$$

Tensor coefficient  $\hat{R}^{ab}_{cd}$  is referred to as the Riemann-curvature tensor. Ricci-curvature tensor and scalar curvature are defined, respectively, owing to the Riemann-curvature tensor as

$$\hat{R}^{ab} := \hat{\mathcal{R}}^{\circ a}_{\mu\nu} \mathcal{E}_\circ^\mu \mathcal{E}_\star^\nu \eta^{\star b} \quad \text{and} \quad \hat{R} := \hat{\mathcal{R}}^{\circ\star}_{\mu\nu} \mathcal{E}_\circ^\mu \mathcal{E}_\star^\nu.$$

The first and second Bianchi identities are

$$d_{\hat{\mathbf{w}}} \hat{\mathfrak{T}}^a = d_{\hat{\mathbf{w}}}(d_{\hat{\mathbf{w}}} \mathbf{e}^a) = \eta_{\circ\circ} \hat{\mathfrak{R}}^{a\circ} \wedge \mathbf{e}^\circ \quad \text{and} \quad d_{\hat{\mathbf{w}}} \hat{\mathfrak{R}}^{ab} = 0. \quad (5)$$

### 2.3.2 Coupling constant

We re-define connection and curvature with the gravitational coupling constant  $c_{gr}$ . Objects without a hat represent one defined with the gravitational coupling constant corresponding to those with a hat. We re-define the covariant differential (1a) utilising the scaling

$$c_{gr} \mathbf{w}^{ab} := \hat{\mathbf{w}}^{ab} \implies c_{gr} \omega_\mu^{ab} = \hat{\omega}_\mu^{ab}, \quad (6)$$

which provides

$$d_{\mathbf{w}} \mathbf{a}^{a_1 \dots a_q} = d\mathbf{a}^{a_1 \dots a_q} + c_{gr} (\mathbf{w}^a \wedge \mathbf{a}^{\circ \dots a_p} + \dots). \quad (1a)'$$

Accordingly, the scaled torsion form owing to  $c_{gr}$  is

$$\mathfrak{T}^a = d_{\mathbf{w}} \mathbf{e}^a = d\mathbf{e}^a + c_{gr} \mathbf{w}^a \wedge \mathbf{e}^\circ. \quad (2a)'$$

The scaling also provides the scaled curvature as

$$\mathfrak{R}^{ab} := d\mathbf{w}^{ab} + c_{gr} \mathbf{w}^a \wedge \mathbf{w}^{ob}, \quad (4)'$$

with

$$c_{gr} \mathfrak{R}^{ab} = \hat{\mathfrak{R}}^{ab} \implies c_{gr} \mathcal{R}^{ab}_{\mu\nu} = \hat{\mathcal{R}}^{ab}_{\mu\nu}. \quad (7)$$

The Lorentz transformation for the scaled spin-connection scales as

$$(3b) \implies G_{SO} : \mathbf{w} \mapsto G_{SO}(\mathbf{w}) = \mathbf{w}' = \mathbf{\Lambda} \mathbf{w} \mathbf{\Lambda}^{-1} + c_{gr}^{-1} \mathbf{\Lambda} d\mathbf{\Lambda}^{-1}, \quad (3b)'$$

and the first Bianchi identity as

$$(5) \implies d_{\mathbf{w}} \mathfrak{T}^a = d_{\mathbf{w}}(d_{\mathbf{w}} \mathbf{e}^a) = c_{gr} \eta_{\circ\circ} \mathfrak{R}^{a\circ} \wedge \mathbf{e}^\circ. \quad (5)'$$

As seen in (4) and (4)', a simultaneous re-scaling of the connection and curvature eliminates the coupling constant in the system. When treating only the gravitational force, the gravitational coupling constant has no physical meaning. However, when considering the Yang–Mills theory gauge forces in curved space-time, coupling constants provide a relative strength among forces, including the gravitational one.

## 2.4 Spinor-gauge bundle

A connection in the gauge bundle  $\mathfrak{A}_{SU} := \mathfrak{A}_{SU}^I \tau_I \in \Omega^1(T^*\mathcal{M}) \otimes \mathfrak{su}(N)$  is an  $SU(N)$  Lie-algebra valued one-form object. We define covariant differential  $d_{SU \otimes SO}$  on  $p$ -form object  $\mathfrak{a} \in \Omega^p(T^*\mathcal{M})$  concerning  $SU(N)$  and  $SO(3,1)$  as

$$d_{SU \otimes SO} \mathfrak{a} := \mathbf{1}_{SU} d_{\mathfrak{w}} \mathfrak{a} - i c_{SU} [\mathfrak{A}_{SU}, \mathfrak{a}]_{\wedge},$$

where

$$[\mathfrak{A}_{SU}, \mathfrak{a}]_{\wedge} := \mathfrak{A}_{SU} \wedge \mathfrak{a} - (-1)^p \mathfrak{a} \wedge \mathfrak{A}_{SU},$$

and  $c_{SU}$  is a dimensionless coupling constant of the gauge interaction. Connection  $\mathfrak{A}_{SU}$  belongs to an adjoint representation of the gauge group as

$$G_{SU}(\mathfrak{A}_{SU}) = g_{SU}^{-1} \mathfrak{A}_{SU} g_{SU} + i c_{SU}^{-1} g_{SU}^{-1} d g_{SU},$$

which ensures  $SU(N)$  covariance of the covariant differential. At the same time,  $\mathfrak{A}_{SU}$  is a vector in  $T^*\mathcal{M}$ , which is  $SO(1,3)$ -transformed. Corresponding gauge curvature two-form  $\mathfrak{F}_{SU}$  is defined through a structure equation such that:

$$\mathfrak{F}_{SU} = \mathfrak{F}_{SU}^I \tau_I := d_{\mathfrak{w}} \mathfrak{A}_{SU} - i c_{SU} \mathfrak{A}_{SU} \wedge \mathfrak{A}_{SU} = \left( d \mathfrak{A}_{SU}^I + c_{gr} \mathfrak{w} \wedge \mathfrak{A}_{SU}^I + \frac{c_{SU}}{2} f^I_{JK} \mathfrak{A}_{SU}^J \wedge \mathfrak{A}_{SU}^K \right) \tau_I,$$

where  $f^I_{JK} = f_{IJK}$ . We utilise the scaled spin-connection; thus, the gravitational coupling constant is appearing in the Lagrangian, which provides the relative strength between gravitational and  $SU(N)$  gauge forces.

The gauge connection and gauge curvature are represented using the trivial bases in  $T^*\mathcal{M}$ , respectively, as

$$\mathfrak{A}_{SU} = \mathfrak{A}_{SU}^I \tau_I =: \mathcal{A}_a^I \mathbf{e}^a \tau_I, \quad \text{and} \quad \mathfrak{F}_{SU} = \mathfrak{F}_{SU}^I \tau_I =: \frac{1}{2} \mathcal{F}_{ab}^I \mathbf{e}^a \wedge \mathbf{e}^b \tau_I.$$

In this expression, tensor coefficients of the gauge curvature is provided using those of the gauge connection such that:

$$\mathcal{F}_{ab}^I = \partial_a \mathcal{A}_b^I - \partial_b \mathcal{A}_a^I + c_{SU} f^I_{JK} \mathcal{A}_a^J \mathcal{A}_b^K + \mathcal{A}_a^I \mathcal{T}_{ab}^{\circ},$$

where  $\mathcal{T}$  is a tensor coefficient of the torsion form defined as  $\mathfrak{T}^{\bullet} =: \mathcal{T}^{\bullet \circ \circ} \mathbf{e}^{\circ} \wedge \mathbf{e}^{\circ} / 2$ . When the space-time manifold is torsion-less, the gauge curvature has the same representation as it in the flat space-time.

The  $Spin(1,3)$  covariant differential acts on the spinor as [9, 13, 14]

$$d_{\mathfrak{w}} \psi := d\psi - i \frac{c_{gr}}{2} \eta_{\circ \circ} \eta_{**} \mathfrak{w}^{\circ \star} \frac{\sigma^{\circ \star}}{2} \psi,$$

where  $\sigma^{ab}/2 := i[\gamma^a, \gamma^b]/4$  is a generator of  $Spin(1,3)$ . We define the Dirac operator as

$$d_{\mathfrak{w}} : \Gamma(\mathcal{M}, \Omega^0(\mathcal{S}_{sp})) \rightarrow \Gamma(\mathcal{M}, \Omega^0(\mathcal{S}_{sp})).$$

More precisely, it is a transformation such that:

$$d_{\mathfrak{w}} \psi := \iota_{\gamma} d_{\mathfrak{w}} : \Gamma(\mathcal{M}, \Omega^0(\mathcal{S}_{sp})) \xrightarrow{d_{\mathfrak{w}}} \Gamma(\mathcal{M}, \Omega^1(\mathcal{S}_{sp})) \xrightarrow{\iota_{\gamma}} \Gamma(\mathcal{M}, \Omega^0(\mathcal{S}_{sp})),$$

which has an expression owing to the trivial basis as

$$d_{\mathfrak{w}}(\psi) = \left( \gamma^{\circ} \partial_{\circ} - i \frac{c_{gr}}{2} \gamma^{\circ} \mathcal{E}_{\circ}^{\mu} \omega_{\mu}^{**} \frac{\sigma^{**}}{2} \right) \psi,$$

where  $\iota_{\gamma}$  is a contraction with the Clifford algebra  $\gamma^a$ .

A connection and curvature of the spinor-gauge bundle are provided, respectively, as

$$\mathfrak{A}_{sg}^{ab} = \mathfrak{w}^{ab} \otimes \mathbf{1}_{SU} + [\mathbf{1}_{sp}]^{ab} \otimes \mathfrak{A}_{SU}, \quad \text{and} \quad \mathfrak{F}_{sg}^{ab} = \mathfrak{A}_{sp}^{ab} \otimes \mathbf{1}_{SU} + [\mathbf{1}_{sp}]^{ab} \otimes \mathfrak{F}_{SU},$$

We introduce the  $SU(N)$  symmetric  $N$  spinor as  $\psi = (\psi^1, \dots, \psi^N)^T$ . The Dirac operator on  $\psi \in \mathcal{S}_{sp}^{\otimes N}$  concerning the spinor-gauge bundle is provided as

$$\begin{aligned} d_{sg} : \Gamma(\mathcal{M}, \Omega^0(\mathcal{S}_{sp}^{\otimes N} \otimes SU(N))) &\rightarrow \Gamma(\mathcal{M}, \Omega^0(\mathcal{S}_{sp}^{\otimes N} \otimes SU(N))) \\ : \psi &\mapsto d_{sg} \psi := \left( \gamma^{\circ} \partial_{\circ} - i \frac{c_{gr}}{2} \gamma^{\circ} \mathcal{E}_{\circ}^{\mu} \omega_{\mu}^{**} \frac{\sigma^{**}}{2} - i c_{SU} \gamma^{\circ} \mathcal{A}_{\circ}^I \tau_I \right) \psi. \end{aligned}$$

### 3 QGED Lagrangian

#### 3.1 Bare Lagrangian

We introduce the Lagrangian four-form in the inertial manifold as  $\mathfrak{L}^{(\infty)} := \mathcal{L}^{(\infty)}(\xi \in \mathcal{M}) \mathbf{v} \in \Omega^4(T^*\mathcal{M})$ , where  $\mathcal{L}^{(\infty)}(\xi) \in \Omega^0(T^*\mathcal{M})$  is a Lagrangian density. Superscript “ $\infty$ ” indicates that a given object is unrenormalised, hereafter. We define the Lagrangian form as the null physical dimensional object; thus, the Lagrangian density has a  $L^{-4}$  dimension. A bear (un-renormalised) Lagrangian form of the QGED consists of seven parts as follows:

$$\mathcal{L}_{QGED}^{(\infty)} := \mathcal{L}_{GR}^{(\infty)} + \mathcal{L}_{GR;gfix}^{(\infty)} + \mathcal{L}_{GR;gh}^{(\infty)} + \mathcal{L}_{SU}^{(\infty)} + \mathcal{L}_{SU;gfix}^{(\infty)} + \mathcal{L}_{SU;gh}^{(\infty)} + \mathcal{L}_{MT}^{(\infty)},$$

where

- Gravitational part:
  - $\mathcal{L}_{GR}^{(\infty)}$ : a pure gravitational term,
  - $\mathcal{L}_{GR;gfix}^{(\infty)}$ : a  $Spin(1, 3)$  gauge fixing term,
  - $\mathcal{L}_{GR;gh}^{(\infty)}$ : a Fadeev–Poppov ghost term for the  $Spin(1, 3)$  gauge group,
- $SU(N)$  gauge part:
  - $\mathcal{L}_{SU}^{(\infty)}$ : an  $SU(N)$  gauge boson term,
  - $\mathcal{L}_{SU;gfix}^{(\infty)}$ : an  $SU(N)$  gauge fixing term,
  - $\mathcal{L}_{SU;gh}^{(\infty)}$ : a Fadeev–Poppov ghost term for for the  $SU(N)$  gauge group,
- Matter part:
  - $\mathcal{L}_{MT}^{(\infty)}$ : a matter (fermion) field term.

A pure gravitational part is provided by the Einstein–Hilbert gravitational Lagrangian such as

$$\mathfrak{L}_{GR}^{(\infty)} := \frac{1}{4\kappa_E \hbar} \epsilon_{\circ\circ\circ\circ} \hat{\mathfrak{R}}^{(\infty)\circ\circ} \wedge \mathbf{e}^{(\infty)\circ} \wedge \mathbf{e}^{(\infty)\circ}. \quad (8)$$

We define the Lagrangian using the non-scaled curvature. Component representations of the gravitational Lagrangian in  $T^*\mathcal{M}$  and  $T^*\mathcal{M}$  are, respectively,

$$\mathfrak{L}_{GR}^{(\infty)} = \frac{1}{4\kappa_E \hbar} \epsilon_{\circ\circ\circ\circ} \left( \hat{c}_{gr}^{(\infty)} \partial_\mu \omega_\nu^{(\infty)\circ\circ} + \hat{c}_{gr}^{(\infty)2} \omega_\mu^{(\infty)\circ} \star \omega_\nu^{(\infty)\circ\star\circ} \right) \mathcal{E}_\rho^{(\infty)\circ} \mathcal{E}_\sigma^{(\infty)\circ} dx^\mu \wedge dx^\nu \wedge dx^\rho \wedge dx^\sigma, \quad (9a)$$

$$= \frac{1}{4G_N \hbar} \epsilon_{\circ\circ\circ\circ} \left( \hat{c}_{gr}^{(\infty)} \partial_a \omega_b^{(\infty)\circ\circ} + \hat{c}_{gr}^{(\infty)2} \omega_a^{(\infty)\circ} \star \omega_b^{(\infty)\circ\star\circ} \right) \mathbf{e}^{(\infty)a} \wedge \mathbf{e}^{(\infty)b} \wedge \mathbf{e}^{(\infty)\circ} \wedge \mathbf{e}^{(\infty)\circ}. \quad (9b)$$

We note that

$$\begin{aligned} \frac{\partial \omega_b^{\circ\circ}(\xi)}{\partial \xi^a} \mathbf{e}^a \wedge \mathbf{e}^b &= \mathcal{E}_a^\mu(\xi) \left( \frac{\partial}{\partial x^\mu} \omega_\nu^{\circ\circ}(x) \mathcal{E}_b^\nu(\xi) \right) d\xi^a \wedge d\xi^b, \\ &= \left( \frac{\partial}{\partial x^\mu} \omega_\nu^{\circ\circ}(x) \right) \mathcal{E}_a^\mu(\xi) \mathcal{E}_b^\nu(\xi) d\xi^a \wedge d\xi^b, \\ &= \frac{\partial \omega_\nu^{\circ\circ}(x)}{\partial x^\mu} dx^\mu \wedge dx^\nu, \end{aligned}$$

and thus, the covariant differential gives the same expression both in  $T^*\mathcal{M}$  and  $T^*\mathcal{M}$  as shown in (9a) and (9b). Other Lagrangian forms are provided using the standard bases as:

$$\mathfrak{L}_{MT}^{(\infty)} := \bar{\psi}^{(\infty)} \left( i \gamma^\circ \partial_\circ - \frac{1}{\hbar} m^{(\infty)} - i \frac{\hat{c}_{gr}^{(\infty)}}{2} \gamma^\circ \mathcal{E}_\circ^\mu \omega_\mu^{(\infty)\circ\star\star} \frac{\sigma^{\star\star}}{2} + \hat{c}_{SU}^{(\infty)} \gamma^\circ \mathcal{A}_\circ^{(\infty)I} \tau_I \right) \psi^{(\infty)} \mathbf{v}, \quad (10)$$

$$\mathfrak{L}_{SU}^{(\infty)} := \frac{1}{4} \sum_{I=1}^N \mathcal{F}_{\circ\circ}^{(\infty)I} \mathcal{F}^{(\infty)I\circ\circ} \mathbf{v}. \quad (11)$$



Lagrangian densities are defined in  $T^*\mathcal{M}$ . We decompose the bare QGED Lagrangian into free and interaction parts according to the standard perturbative quantization method such as

$$\begin{cases} \mathcal{L}_{GR;free}^{(\infty)} & := c_{gr}^{(\infty)} \left( \partial_a \omega_b^{(\infty)ab} - \partial_b \omega_a^{(\infty)ab} \right) / L_p^2, \\ \mathcal{L}_{GR;int}^{(\infty)} & := c_{gr}^{(\infty)2} \eta_{\circ\circ} \left( \omega_a^{(\infty)a\circ} \omega_b^{(\infty)\circ b} - \omega_b^{(\infty)a\circ} \omega_a^{(\infty)\circ b} \right) / L_p^2, \end{cases} \quad (12a)$$

$$\begin{cases} \mathcal{L}_{MT;free}^{(\infty)} & := \bar{\psi}^{(\infty)} \left( i\gamma^\circ \partial_\circ - \frac{1}{\hbar} m_e^{(\infty)} \right) \psi^{(\infty)}, \\ \mathcal{L}_{MT;int}^{(\infty)} & := \bar{\psi}^{(\infty)} \left( -i c_{gr}^{(\infty)} \gamma^\circ \mathcal{E}_\circ^\mu \omega_\mu^{**} \sigma_{**} / 4 + c_{SU}^{(\infty)} \gamma^\circ \mathcal{A}_\circ^{(\infty)I} \tau_I \right) \psi^{(\infty)}, \end{cases} \quad (12b)$$

$$\begin{cases} \mathcal{L}_{SU;free}^{(\infty)} & := \sum_{I=1}^N \eta^{\circ\circ} \eta^{**} \left( \partial_\circ \mathcal{A}_\star^{(\infty)I} - \partial_\star \mathcal{A}_\circ^{(\infty)I} \right) \left( \partial_\circ \mathcal{A}_\star^{(\infty)I} - \partial_\star \mathcal{A}_\circ^{(\infty)I} \right) / 4, \\ \mathcal{L}_{SU;int}^{(\infty)} & := c_{SU}^{(\infty)} \sum_{I=1}^N \eta^{\circ\circ} \eta^{**} \left( \partial_\circ \mathcal{A}_\star^{(\infty)I} - \partial_\star \mathcal{A}_\circ^{(\infty)I} \right) \left( f_{JK}^I \mathcal{A}_\circ^{(\infty)J} \mathcal{A}_\star^{(\infty)K} \right) / 2 \\ & \quad + c_{SU}^{(\infty)2} \sum_{I=1}^N \eta^{\circ\circ} \eta^{**} \left( f_{JK}^I \mathcal{A}_\circ^{(\infty)J} \mathcal{A}_\star^{(\infty)K} \right) \left( f_{LM}^I \mathcal{A}_\circ^{(\infty)L} \mathcal{A}_\star^{(\infty)M} \right) / 4. \end{cases} \quad (12c)$$

where  $\psi^{(\infty)}$  is an  $N$ -spinors  $\psi^{(\infty)} := (\psi_i^{(\infty)}, \dots, \psi_N^{(\infty)})$ . Trivial  $\mathbf{1}_{SU}$  is omitted in formulae. Later after providing ghost Lagrangian, we decompose it into free and interaction parts, too. We note that the identity

$$\epsilon_{abcd} \mathbf{e}^a \wedge \mathbf{e}^b \wedge \mathbf{e}^c \wedge \mathbf{e}^d = 2 \left( \delta_{c'}^d \delta_{d'}^c - \delta_{d'}^c \delta_{c'}^d \right) \mathbf{v}$$

is utilised in (12a).

## 3.2 BRST transformation

The standard procedure of canonical quantization based on the BRST symmetry[15, 16] is well established. In this study, we utilise a quantization method proposed by Nakanishi[17], Kugo and Ojima[18, 19]. The Nakanishi–Kugo–Ojima method introduces the auxiliary field and the Fadeev–Popov ghost field and sets the BRST transformation on all fields that appear in theory. This section provides a set of the BRST transformations for the QGED.

The BRST transformations for un-renormalised fields are common to those for renormalised fields; thus, we omit suffix “ $\infty$ ” in the following.

### 3.2.1 Yang–Mills theory

In the standard quantum field theory textbooks, we can find the detailed procedure of quantising the Yang–Mills theory based on the BRST symmetry, e.g., Ref.[20, 21]. Even though that, this section summarises the BRST transformation for the Yang–Mills theory in the inertial manifold and provides a guide to constructing the BRST transformation of the gravitational fields.

We introduce classical auxiliary and Faddeev–Popov ghost/anti-ghost fields as follows:

- auxiliary field:  $B^I(\xi)$ ,
- ghost field:  $\chi^I(\xi)$ ,
- anti-ghost field:  $\bar{\chi}^I(\xi)$ ,

where suffix  $I$  concerns the  $SU(N)$  gauge group. Each number of auxiliary, ghost and anti-ghost fields is the same as that of the degree of freedom of the gauge group. For the  $SU(N)$  symmetry, it is  $N^2 - 1$ . The connection field (gauge boson) belongs to the adjoint representation of the gauge group; thus, the number of the above fields is the same as that of gauge bosons. The ghost/anti-ghost fields are the Grassmann number following an anti-commutable product. This study denotes the BRST transformation concerning the  $SU(N)$  gauge group as  $\delta_B^{SU}[\bullet]$ . The BRST transformations for classical fermion and  $SU(N)$  gauge fields are

$$\begin{aligned} \delta_B^{SU}[\psi] & := i c_{SU} \chi^I \tau_I \psi, \\ \delta_B^{SU}[\mathcal{A}_{SU}^I] & := d_{SU \otimes SO} \chi^I = \left( \partial_\circ \chi^I + c_{SU} f_{JK}^I \mathcal{A}_\circ^J \chi^K \right) \mathbf{e}^\circ. \end{aligned}$$

We note that  $d_{\text{to}}s(\xi) = ds(\xi)$  for a local scalar function  $s(\xi)$ . The BRST transformation on the Grassmann numbers  $X$  and  $Y$  fulfils the Leibniz rule such that

$$\delta_{\text{B}}^{\text{SU}}[XY] = \delta_{\text{B}}^{\text{SU}}[X]Y + \epsilon_X X \delta_{\text{B}}^{\text{SU}}[Y],$$

where the signature  $\epsilon_X = -1$  for  $X \in \{\chi^I, \bar{\chi}^I\}$ , and  $\epsilon_X = +1$  otherwise. We define the BRST transformations for auxiliary and ghost/anti-ghost fields as

$$\begin{aligned}\delta_{\text{B}}^{\text{SU}}[B^I] &:= 0, \\ \delta_{\text{B}}^{\text{SU}}[\chi^I] &:= -\frac{1}{2}c_{\text{SU}}f^I_{JK}\chi^J\chi^K, \\ \delta_{\text{B}}^{\text{SU}}[\bar{\chi}^I] &:= B^I.\end{aligned}$$

The BRST transformation for vierbein and spin-connection fields gives zero. Simple calculations show the BRST transformation is nilpotent for any fields.

### 3.2.2 General relativity

The current author has developed the canonical quantization of general relativity in the Heisenberg picture utilising the Nakanishi–Kugo–Ojima quantization method[22]. This section discusses the BRST transformation of gravitational fields in the interaction picture following the method in the preceding section.

We introduce the auxiliary field and Faddeev–Popov ghost/anti-ghost fields as follows:

- auxiliary field:  $\beta_{\mu}^a(x)$ ,
- ghost fields:  $\chi_b^a(\xi)$  and  $\chi^{\mu}(x)$ ,
- anti-ghost field:  $\bar{\chi}_{\mu}^a(x)$ .

Here, ghost fields are Grassmannian. Auxiliary field  $\beta_{\mu}^a(x)$  plays a role in fixing  $Spin(1, 3)$  gauge symmetry in the quantization of the spin-connection and is decoupled from the physical system after the gauge fixing. Ghost fields  $\chi_b^a(\xi)$  and  $\chi^{\mu}(x)$  were introduced to preserve the unitarity of the scattering amplitude, corresponding to the local Lorentz and global coordinate transformations, respectively. We assign a ghost number  $+1$  for  $\chi_b^a$  and  $-1$  for  $\bar{\chi}_{\mu}^a$ . An anti-ghost field corresponding to the global ghost is unnecessary since it is decoupled from the physical system in the inertial space.

In this study, we denote the BRST transformation for gravitational fields as  $\delta_{\text{B}}^{\text{GR}}[\bullet]$ , and require rules introduced by Nakanishi[23] as follows: The BRST transformation of the coordinate vector in  $\mathcal{M}$  should obey the general linear transformation as follows:

$$\delta_{\text{B}}^{\text{GR}}[x^{\mu}] = \chi^{\mu}. \quad (13)$$

In addition, we require the postulate given in [23], such as

$$\delta_{\text{B}}^{\text{GR}}[\partial_{\mu}X] = \partial_{\mu}\delta_{\text{B}}^{\text{GR}}[X] - (\partial_{\mu}\delta_{\text{B}}^{\text{GR}}[x^{\nu}])\partial_{\nu}X = \partial_{\mu}\delta_{\text{B}}^{\text{GR}}[X] - (\partial_{\mu}\chi^{\nu})\partial_{\nu}X, \quad (14)$$

where  $X$  is any field defined in  $T\mathcal{M}$ ; thus, the BRST transformation acts on a one-form object in  $T^*\mathcal{M}$  as

$$\delta_{\text{B}}^{\text{GR}}[dx^{\mu}] = (\partial_{\nu}\delta_{\text{B}}^{\text{GR}}[x^{\mu}])dx^{\nu} = d(\delta_{\text{B}}^{\text{GR}}[x^{\mu}]) = d\chi^{\mu}.$$

Consequently, the BRST transformation and external derivative are commute with each other, i.e.,

$$[\delta_{\text{B}}^{\text{GR}}, d]\bullet = \delta_{\text{B}}^{\text{GR}}[d\bullet] - d(\delta_{\text{B}}^{\text{GR}}[\bullet]) = 0,$$

We define the BRST transformations of auxiliary and ghost/anti-ghost fields by reference to those of the Yang–Mills theory as

$$\delta_{\text{B}}^{\text{GR}}[\beta_{\mu}^a] = \delta_{\text{B}}^{\text{GR}}[\chi^{\mu}] = 0, \quad (15a)$$

$$\delta_{\text{B}}^{\text{GR}}[\chi_b^a] = c_{\text{gr}}\chi^a \circ \chi^b, \quad (15b)$$

$$\delta_{\text{B}}^{\text{GR}}[\bar{\chi}_{\mu}^a] = L_{\text{p}}\beta_{\mu}^a. \quad (15c)$$

Here, we have set the BRST transformations to preserve the physical dimension of each field. The BRST transformation of the position vector given in (13) provides the global ghost field with a Length dimension. The auxiliary field has the same physical dimension as the spin-connection field; it is  $L^{-1}$  dimension. The ghost field must be a null dimension object owing to (15b). We also set anti-ghost fields as a null physical dimension; thus, we introduce the Planck length in (15c) to adjust a physical dimension.

The BRST transformation satisfies the following Leibniz rule:

$$\delta_{\text{B}}^{GR} [XY] = \delta_{\text{B}}^{GR} [X]Y + \epsilon_X X \delta_{\text{B}}^{GR} [Y], \quad (16)$$

where the signature  $\epsilon_X = -1$  for  $X \in \{\chi^\mu, \chi_a^b, \bar{\chi}_\mu^a\}$ , and  $\epsilon_X = +1$  otherwise. The BRST transformations of vierbein and spin-connection forms are defined as

$$\begin{aligned} \delta_{\text{B}}^{GR} [\mathbf{e}^a] &:= c_{gr} \chi_a^\circ \mathbf{e}^\circ, \\ \delta_{\text{B}}^{GR} [\mathbf{w}^{ab}] &:= d\chi^{ab} - c_{gr} (\mathbf{w}^a \circ \chi^{ob} + \mathbf{w}^b \circ \chi^{ao}), \end{aligned}$$

where  $\chi^{ab} := \chi_a^\circ \eta^{ob}$ . The local ghost field is anti-symmetric owing to the above definition. They induce the BRST transformations of vierbein and spin-connection fields as

$$\delta_{\text{B}}^{GR} [\mathcal{E}_\mu^a] = -\mathcal{E}_\nu^a \partial_\mu \chi^\nu + c_{gr} \chi_a^\circ \mathcal{E}_\mu^\circ, \quad (17a)$$

$$\delta_{\text{B}}^{GR} [\omega_\mu^{ab}] = \mathcal{E}_\mu^\circ \partial_\circ \chi^{ab} + (\partial_\mu \chi^\nu) \omega_\nu^{ab} - c_{gr} (\omega_\mu^a \circ \chi^{ob} + \omega_\mu^b \circ \chi^{ao}). \quad (17b)$$

The BRST transformation of the vierbein inverse is obtained after simple calculations as

$$\delta_{\text{B}}^{GR} [\mathcal{E}_a^\mu] = \mathcal{E}_a^\nu \partial_\nu \chi^\mu - c_{gr} \chi_a^\circ \mathcal{E}_\circ^\mu, \quad (17c)$$

where  $\delta_{\text{B}}^{GR} [\mathcal{E}_\mu^a \mathcal{E}_a^\nu] = \delta_{\text{B}}^{GR} [\delta_\mu^\nu] = 0$  is used.

We introduce one-form objects of auxiliary and ghost/anti-ghost fields as

$$\mathbf{b}^a := (L_p \beta_\mu^a - \bar{\chi}_\nu^a \partial_\mu \chi^\nu) dx^\mu, \quad (18a)$$

$$\mathbf{c}^a := \chi_a^\circ \mathbf{e}^\circ, \quad (18b)$$

$$\bar{\mathbf{c}}^a := \bar{\chi}_\mu^a dx^\mu = \bar{\chi}_\circ^a \mathbf{e}^\circ, \quad (18c)$$

where  $\bar{\chi}_b^a := \bar{\chi}_\mu^a \mathcal{E}_b^\mu$ . They have a physical dimension as  $[\mathbf{b}^a] = [\mathbf{c}^a] = [\bar{\mathbf{c}}^a] = L$ , and their BRST transformations are

$$\delta_{\text{B}}^{GR} [\mathbf{b}^a] = \delta_{\text{B}}^{GR} [\mathbf{c}^a] = 0 \quad \text{and} \quad \delta_{\text{B}}^{GR} [\bar{\mathbf{c}}^a] = \mathbf{b}^a.$$

Auxiliary form has representations in the inertial space as

$$(18a) = (L_p \beta_\circ^a - \bar{\chi}_\star^a \partial_\circ \chi^\star) \mathbf{e}^\circ \in T^*\mathcal{M}, \quad \text{where} \quad \beta_b^a := \beta_\mu^a \mathcal{E}_b^\mu, \quad \chi^a := \mathcal{E}_\mu^a \chi^\mu.$$

We represent the auxiliary form in  $T^*\mathcal{M}$  as  $\mathbf{b}^a = B_\circ^a \mathbf{e}^\circ$  using components defined as

$$B_b^a := (L_p \beta_b^a - \bar{\chi}_\circ^a \partial_b \chi^\circ).$$

Since we define the Lagrangian form in  $T^*\mathcal{M}$ , Romanised forms appear in the Lagrangian. We provide the BRST transformation of (14) and (17b) in the inertial space for future convenience:

$$\begin{aligned} \delta_{\text{B}}^{GR} [\partial_a X(\xi)] &= \partial_a (\delta_{\text{B}}^{GR} [X](\xi)) - c_{gr} \chi_a^\circ (\partial_\circ X(\xi)), \\ \delta_{\text{B}}^{GR} [\omega_c^{ab}] &= \partial_c \chi^{ab} - c_{gr} (\omega_c^a \circ \chi^{ob} + \omega_c^b \circ \chi^{ao} + \omega_\circ^{ab} \chi_c^\circ). \end{aligned}$$

We note that the BRST transformation on the object defined in the inertial space does not include the global ghost field, as shown above. Consequently, the global ghost field does not appear in the ghost Lagrangian defined in the inertial space.

Direct calculations show that the BRST transformations are nilpotent for all forms and fields. Consequently, the classical Lagrangian  $\mathcal{L}_{GR}$  is BRST-invariant. In this study, we simplified definitions of auxiliary and ghost/anti-ghost fields from those in Ref.[22]. Although calculations are almost identical to those in Ref.[22], we provide proof of nilpotency for all necessary forms in **Appendix A** for completeness.

### 3.3 Ghost and gauge fixing Lagrangian

This section introduces gauge fixing and ghost Lagrangians to the bare quantum Lagrangian according to the standard prescription: Prepare the necessary number of functions  $F[\mathcal{A}, B, \chi, \bar{\chi}]$ , which includes the same number of ghost and anti-ghost fields. Then, add a term

$$\mathcal{L}_{\bullet, \text{gfix}} + \mathcal{L}_{\bullet, \text{gh}} := \delta_{\mathbb{B}}^{\bullet}[\bar{\chi} F]$$

to the Lagrangian. As a result, the total Lagrangian is BRST-invariant, and after fixing all gauge degrees, the Lagrangian is still keeping the BRST symmetry. We omit suffix “ $\circ$ ” suffix for the bare fields in this section, too.

#### 3.3.1 Yang–Mills theory

For the  $SU(N)$  gauge part, we introduce the scalar field as

$$H^I := \eta^{\circ\circ} \partial_{\circ} \mathcal{A}_{\circ}^I + \frac{1}{2} \xi_A B^I,$$

which gives the gauge fixing and ghost Lagrangians, such that

$$\mathcal{L}_{SU, \text{gfix}} + \mathcal{L}_{SU, \text{gh}} := \sum_{I=1}^N \delta_{\mathbb{B}}^{SU}[\bar{\chi}^I H^I].$$

It is decomposed into

$$\mathcal{L}_{SU, \text{gfix}} := \sum_{I=1}^N \delta_{\mathbb{B}}^{SU}[\bar{\chi}^I] H^I = \sum_{I=1}^N \left( B^I \eta^{\circ\circ} \partial_{\circ} \mathcal{A}_{\circ}^I + \frac{\xi_A}{2} B^I B^I \right), \quad (19a)$$

$$\mathcal{L}_{SU, \text{gh}} := \sum_{I=1}^N \bar{\chi}^I \delta_{\mathbb{B}}^{SU}[H^I] = \bar{\chi}^I \eta^{\circ\circ} \partial_{\circ} (\partial_{\circ} \chi^I + c_{SU} f_{JK}^I \mathcal{A}_{\circ}^J \chi^K). \quad (19b)$$

We can write the gauge fixing Lagrangian as

$$(19a) = \sum_{I=1}^N \frac{1}{2\xi_A} \left\{ (C^I)^2 - (\eta^{\circ\circ} \partial_{\circ} \mathcal{A}_{\circ}^I)^2 \right\}, \quad (19c)$$

where

$$C^I := \eta^{\circ\circ} \partial_{\circ} \mathcal{A}_{\circ}^I + \xi_A B^I.$$

Therefore, scalar field  $C^I$  (and thus  $B^I$ , too) is decoupled from the other parts, and the standard gauge fixing term

$$\mathcal{L}_{SU, \text{gfix}} := -\frac{1}{2\xi_A} \sum_{I=1}^N (\eta^{\circ\circ} \partial_{\circ} \mathcal{A}_{\circ}^I)^2, \quad (20)$$

and interaction vertices among gauge bosons and ghosts remain in the Lagrangian. The gauge fixing condition provides one constraint on four components of  $\mathcal{A}^a$ . Together with an on-shell (mass-less) condition, two dynamical degrees (transverse polarization) remain on a  $SU(N)$  gauge boson.

Owing to definitions, we can confirm that the Lagrangian is BRST-invariant:

$$\delta_{\mathbb{B}}^{SU} [\mathcal{L}_{SU} + \mathcal{L}_{SU, \text{gfix}} + \mathcal{L}_{SU, \text{gh}} + \mathcal{L}_{MT}] = 0.$$

### 3.3.2 General relativity

This section provides gauge fixing and ghost Lagrangians for a gravity part according to the same prescription used for the Yang–Mills theory. We introduce a one-form object

$$\mathfrak{H}^a := \mathfrak{D}\mathfrak{v}^a + \frac{1}{2L_p^2} \xi_\omega \mathfrak{b}^a, \quad \text{with } \mathfrak{D}\mathfrak{v}^a := (\partial_\circ \omega_\star^{a\circ}) \mathfrak{e}^\star.$$

We note that  $\mathfrak{D}\mathfrak{v}^a$  has a length-inverse dimension and  $\mathfrak{b}^a$  has length dimension; thus,  $\mathfrak{H}^a$  has a length-inverse dimension. We define gauge fixing and ghost Lagrangians using this one-form object as

$$\mathfrak{L}_{GR;gfix} + \mathfrak{L}_{GR;gh} := \frac{1}{L_p^2} \delta_B^{GR} [\bar{\mathfrak{c}}^\circ \wedge \mathfrak{H}^\circ \wedge \mathfrak{S}_{\circ\circ}],$$

where the Planck length appears to adjust the Lagrangian forms to a null-dimension. Owing to the definition and nilpotent of each field, this is BRST invariant. We decompose it into the gauge fixing and ghost parts, such that:

$$L_p^2 \mathfrak{L}_{GR;gfix} := \delta_B^{GR} [\bar{\mathfrak{c}}^\circ] \wedge \mathfrak{H}^\circ \wedge \mathfrak{S}_{\circ\circ} = \mathfrak{b}^\circ \wedge \left( \mathfrak{D}\mathfrak{v}^\circ + \frac{1}{2L_p^2} \xi_\omega \mathfrak{b}^\circ \right) \wedge \mathfrak{S}_{\circ\circ}, \quad (21a)$$

$$L_p^2 \mathfrak{L}_{GR;gh} := -\bar{\mathfrak{c}}^\circ \wedge \delta_B^{GR} [\mathfrak{H}^\circ \wedge \mathfrak{S}_{\circ\circ}]. \quad (21b)$$

First, we look at the gauge fixing Lagrangian. We define a new one-form object

$$\mathfrak{C}^a := \mathfrak{D}\mathfrak{v}^a + \frac{\xi_\omega}{L_p^2} \mathfrak{b}^a$$

yielding

$$\mathfrak{L}_{GR;gfix} = \frac{(21a)}{L_p^2} = \frac{1}{2\xi_\omega} \left\{ \mathfrak{C}^\circ \wedge \mathfrak{C}^\circ \wedge \mathfrak{S}_{\circ\circ} - \left( (\partial_\circ \omega_\star^{\times\circ})^2 - (\partial_\circ \omega_\star^{\times\circ}) (\partial_\circ \omega_\star^{\times\circ}) \right) \mathfrak{v} \right\}. \quad (21c)$$

The first term of (21c) has representation in the global space like

$$\mathfrak{C}^\circ \wedge \mathfrak{C}^\circ \wedge \mathfrak{S}_{\circ\circ} = C_\star^\circ C_\star^\times (\delta_\circ^\star \delta_\times^\star - \delta_\circ^\star \delta_\times^\star) \mathfrak{v},$$

where  $\mathfrak{C}^a =: C_\circ^a \mathfrak{e}^\circ$ . Thus,  $\mathfrak{C}^a$  is isolated from the physical system.

The spin-connection  $\omega_c^{ab}$  has 24 components owing to anti-symmetry concerning superscripts. In addition, the torsion-less condition provides twelve constraints on the spin-connection field and implies a relation on the Riemann curvature such that:

$$R_{ab;cd} = R_{cd;ab}, \quad \text{where } R_{ab;cd} := R^{\circ\circ}_{cd} \eta_{\circ a} \eta_{\circ b}. \quad (22)$$

The Riemann curvature fulfilling (22) can be constructed using a half of the spin-connection fields of

$$\omega_{\hat{a}}^b := \omega_{\hat{a}}^{\hat{a}b}. \quad (23)$$

We do not apply the Einstein convention of repeated suffixes for those with a hat. There are twelve independent components in (23) owing to four constraints of  $\hat{a} \neq b$ . We set remnant twelve components to

$$\omega_a^{bc} = 0 \quad \text{for } a \neq b \wedge a \neq c, \quad (24)$$

without loss of generality. Therefore, we re-define the gauge fixing Lagrangian as

$$\mathfrak{L}_{GR;gfix} := -\frac{1}{2\xi_\omega} (\partial_\circ \omega_\star^{\times\circ})^2 \mathfrak{v}, \quad (25a)$$

which corresponds to set the covariant gauge fixing condition as

$$\partial_\circ \omega_{\hat{a}}^{\hat{a}\circ} = 0. \quad (25b)$$

Equation (25b) provides four constraints on  $\omega_a^b$ . In addition, there are six on-shell conditions; thus, two physical degrees of freedom remain in theory. The graviton is the quantized spin-connection field in our theory and is a massless spin-two particle. The little group concerning the graviton in four-dimensional space-time is  $SO(2)$ , which has two degrees of freedom and is consistent with the above discussion.

Next, we construct the ghost Lagrangian, which provides an interaction term among ghosts and physical fields. We require further simplification for the ghost/anti-ghost fields. The role of the Faddeev–Popov ghost is to preserve the Ward identity and to ensure the unitarity of gravitational scattering amplitudes. The quantum theory requires ghost fields as many as a dimension of the gauge group; that of the Lorentz group is six. However, all six components of the graviton are not independent, but it has only two independent components, as discussed above. Thus, we need a scalar field each for ghost and anti-ghost fields.

Owing to the BRST transformation of the spin-connection field, the local ghost is anti-symmetric concerning its two suffixes. We parameterize the local ghost field as

$$\eta_{a\circ}\chi^\circ_b(\xi) = \chi_{ab}(\xi) := \chi(\xi) c_a c_b, \quad (26a)$$

where  $c_a := (c_0, c_1, c_2, c_3)$  is a Grassmannian vector. On the other hand, we set the anti-ghost fields a symmetric tensor:

$$\bar{\chi}_b^a(\xi) = \bar{\chi}(\xi) \delta_b^a. \quad (26b)$$

Both  $\chi(\xi)$  and  $\bar{\chi}(\xi)$  are Grassmannian scalar fields. The auxiliary form also has the same degree of freedom and the same convention as that of the anti-ghost field, such that

$$B_b^a(\xi) = B(\xi) \delta_b^a. \quad (26c)$$

In the following calculations, we keep all components of the spin-connection field without requiring the torsion-less condition.

The ghost Lagrangian splits into two parts owing to the Leibniz rule of the BRST transformation, such that:

$$-(21b) = \bar{c}^\circ \wedge \delta_B^{GR} [\mathfrak{H}^\circ] \wedge \mathfrak{G}_{\circ\circ} + \bar{c}^\circ \wedge \mathfrak{H}^\circ \wedge \delta_B^{GR} [\mathfrak{G}_{\circ\circ}]. \quad (27)$$

Simple calculations provide the BRST transformation of the surface form and  $\mathfrak{H}^a$ , respectively, as

$$\begin{aligned} \delta_B^{GR} [\mathfrak{G}_{ab}] &= \frac{1}{2} \epsilon_{ab\circ\circ} \delta_B^{GR} [c^\circ \wedge c^\circ] = -c_{gr} \epsilon_{ab\circ\star} \chi c^\circ c_\times \mathbf{e}^\times \wedge \mathbf{e}^\star, \\ \delta_B^{GR} [\mathfrak{H}^a] &= \{ (\partial_\circ \partial_\times \chi) c^a c^\circ + c_{gr} (\omega_\times^a \partial_\circ \chi) c^\star c^\circ + (\partial_\circ \omega_\times^{\circ a} \chi) c^a c^\star + (\partial_\circ \omega_\star^{\circ a} \chi) c^\star c_\times \} \mathbf{e}^\times \end{aligned}$$

Thus, we obtain each term of (27) as

$$\bar{c}^\circ \wedge \mathfrak{H}^\circ \wedge \delta_B^{GR} [\mathfrak{G}_{\circ\circ}] = \bar{\chi} (\partial_\circ \omega_\star^{\times\circ}) \chi c^\star c_\times \mathbf{v} = 0,$$

and

$$\bar{c}^\circ \wedge \delta_B^{GR} [\mathfrak{H}^\circ] \wedge \mathfrak{G}_{\circ\circ} = 3 ((c^\circ \partial_\circ \bar{\chi}) (c^\star \partial_\star \chi) + c_{gr} \bar{\chi} \omega_\star^{\star\circ} (\partial_\times \chi) c^\circ c^\times) \mathbf{v}.$$

As a result, we obtain the ghost Lagrangian such that:

$$L_p^2 \mathfrak{L}_{GR;gh} = - ((c^\circ \partial_\circ \bar{\chi}) (c^\star \partial_\star \chi) + c_{gr} \bar{\chi} \omega_\star^{\star\circ} (\partial_\times \chi) c^\circ c^\times) \mathbf{v}, \quad (28)$$

after the re-scaling of scalar ghost/anti-ghost fields.

Although we keep all components of the spin-connection fields in the above calculations, the result includes only components appearing in (23); thus, our parameterizations of ghost field, (26b), is consistent with that of the connection fields. Consequently, the interaction terms consist of scalar ghost/anti-ghost fields and polarization vectors  $\omega_a^b$ .

The nilpotent of gravitational fields ensures the BRST invariance of the gravitational Lagrangian, such that:

$$\delta_B^{GR} [\mathfrak{L}_{GR} + \mathfrak{L}_{GR;fix} + \mathfrak{L}_{GR;gh}] = 0.$$

## 4 QGED Feynman rules

This section formulates Feynman rules concerning the QGED Lagrangian. Hereafter, we treat only  $U(1)$  gauge as a gauge group and one spinor field (electron field). Thus, the theory is electrodynamics, and the dimensionless coupling constant is an electric charge;  $c_{SU} = e$ . For curved space-time, a momentum space, in which Feynman rules are defined, is not trivial. In this study, we utilise the definition of the momentum space introduced in Ref.[24] and denote it by  $T^*\tilde{\mathcal{M}}$ . We follow a phase-convention of the Feynman rules in Ref.[25].

Feynman rules for bare fields are common to those for renormalised fields. Therefore, continuing from the previous section, this section also omits the suffix “ $\circ$ ”.

### 4.1 Green’s function of vierbein and spin-connection fields

This section provides Green’s function of vierbein and spin-connection fields in the configuration space. The Bianchi identity (4)’ has a tensor representation like

$$\partial_\circ \left( R^{a\circ} - \frac{1}{2} \eta^{a\circ} R \right) = \partial^\circ \mathcal{R}^{a\star}{}_{\circ\star} - \frac{1}{2} \partial^a \mathcal{R}^{\circ\star}{}_{\circ\star} = 0.$$

We use anti-symmetry of  $\mathcal{R}$  concerning both the subscripts and superscripts. Owing to the definition of the curvature, we obtain an equation for the classical spin-connection field as[24]

$$(\partial^\circ \partial_\circ \omega_\star^{a\star} - \partial^\circ \partial_\star \omega_\circ^{a\star} - \partial^a \partial_\star \omega_\circ^{\star\circ}) + c_{gr} \partial^\circ (\omega_\circ^{a\star} \omega_\star^{\times\star} - \omega_\star^{a\star} \omega_\circ^{\times\star} - \delta_\circ^a \omega_\star^{\star\star} \omega_\star^{\times\star}) \eta_{\times\times} = 0. \quad (29)$$

Using gauge fixing condition (25b) and free field condition  $c_{gr} = 0$  in (29), we obtain an equation of motion for the free spin-connection in the inertial space, such that:

$$(\partial^\circ \partial_\circ \omega_\star^{\star a})(\xi) = 0. \quad (30)$$

The fundamental solution of (30) provides Green’s function of the spin-connection as

$$G_\omega(\xi) := \frac{\omega_\star^{(\lambda) a}{}^b}{-(\xi^0)^2 + (\xi^1)^2 + (\xi^2)^2 + (\xi^3)^2 - i\delta},$$

where  $\omega_\star^{(\lambda) a}{}^b$  is polarization vectors of the spin-connection field. Infinitesimal constant  $\delta > 0$  is a parameter to determine the analyticity of Green’s function.

The torsion two-form has a tensor representation in  $T^*\mathcal{M}$  and  $T^*\mathcal{M}$  such that:

$$\mathfrak{T}^a =: \frac{1}{2} \mathcal{T}^a{}_{\circ\circ} \epsilon^\circ \wedge \epsilon^\circ = \frac{1}{2} \mathcal{T}^a{}_{\circ\circ} \mathcal{E}_\mu^\circ \mathcal{E}_\nu^\circ dx^\mu \wedge dx^\nu.$$

The torsion-less equation, which is obtained as the Euler–Lagrange equations owing to Lagrangian (8), is

$$\mathcal{T}^a{}_{bc} = \mathcal{E}_\mu^a (\partial_c \mathcal{E}_b^\mu - \partial_b \mathcal{E}_c^\mu) + c_{gr} (\omega_b^a{}_c - \omega_c^a{}_b) = 0. \quad (31)$$

Divergence concerning the superscript of the torsion form,  $\partial_\circ \mathcal{T}^a{}_{bc}$ , and gauge fixing condition (25a) provides constraints such as[24]

$$\partial_\mu \mathcal{E}_a^\mu = 0, \quad (32)$$

which is consistent with the de Donder gauge condition:  $\partial_\mu (\sqrt{-g} g^{\mu\nu}) = 0$ . On the other hand, divergence concerning the subscript of the torsion-less equation provides an equation of motion for a free vierbein field in the global space-time manifold such as

$$T\mathcal{M} \ni g^{\mu\nu} \partial_\mu \partial_\nu \mathcal{E}_\rho^a(x) = 0. \quad (33)$$

The fundamental solution of equation (33) is

$$G_{\mathcal{E}}^a(x) := \frac{\mathcal{E}_\mu^{(a)}}{-(x^0)^2 + (x^1)^2 + (x^2)^2 + (x^3)^2 - i\delta} \quad (34)$$

where  $\mathcal{E}_\mu^{(a)}$  is polarization vectors of the vierbein field. Polarization vectors are components of a spin-one vector defined in  $T^*\mathcal{M}$  such that

$$\mathbf{e}^{(a)} := \mathcal{E}_\mu^{(a)}(x)dx^\mu,$$

where  $a = 1, 2$  shows two independent polarization vectors. We interpret that the subscript represents a vector component concerning the global space-time manifold, and the superscript points to an inner degree of freedom corresponding to two polarization vectors. When we interpret a vierbein field  $\mathcal{E}_\mu^a$  as a component of the global vector defined in  $T^*\mathcal{M}$  concerning the subscript  $\mu$ , a local  $SO(1, 3)$  symmetry is an internal degree of freedom concerning the superscripts  $a$ , which is interpreted as a polarization degree of a vierbein field. We can construct a spin-two polarization vector of the metric tensor using the coupling of angular momenta[24].

## 4.2 External field

The QGED Lagrangian consists of four external physical fields: vierbein field, spin-connection field, photon, and electron. In addition to that, the QGED has ghost/anti-ghost fields. Among them, photons and electrons are defined purely in the inertial space. The spin-connection and local ghost/anti-ghost fields are also objects defined in the inertial space after the Romanisation of the subscript. The spin-connection field propagates in the inertial bundle as a wave according to equation (30). On the other hand, the vierbein field  $\mathcal{E}_\mu^a(x \in \mathcal{M})$  is an object essentially defined in the global space-time and propagating in it according to the wave equation (33). The role of the vierbein is twofold in the QGED: one is a dynamic field propagating in global space-time, and the other is a transformation function converting a Greek index into a Roman index. An electron and a photon do not couple to the vierbein field directly through the interaction Lagrangian. Therefore, this study treats the vierbein field as a transformation function between the global and inertial space and does not discuss an external vierbein field in curved space-time in this study.

### 4.2.1 Electromagnetic part

**spinor:** According to the standard perturbation method, we introduce electron and positron wave functions as follows: Spinor fields of electron and positron,  $u(p, s)$  and  $v(p, s)$ , are positive and negative frequency parts of the plane-wave solution of the Dirac equation with momentum  $p_a = (p_0, \vec{p}) \in V^1(T^*\mathcal{M})$  and spin  $s$  as follows:

$$\hbar^{3/2}\psi(\xi) =: \frac{1}{(2\pi\hbar)^3} \int \frac{d^3\vec{p}}{\sqrt{2E_p}} \sum_{s=1,2} \left( a_e(p, s)u(p, s)e^{-i\xi\cdot p/\hbar} + b_e^\dagger(p, s)v(p, s)e^{+i\xi\cdot p/\hbar} \right), \quad (35)$$

where  $E_p := \sqrt{\vec{p}\cdot\vec{p} + m^2}$  is an on-shell energy, and  $a_e(p, s)$  and  $b_e^\dagger(p, s)$  are an electron's creation and annihilation operators, respectively. The canonical commutation relation of the creation/annihilation operators is

$$\{a_e(\vec{p}, s), a_e^\dagger(\vec{p}', s')\} = \{b_e(\vec{p}, s), b_e^\dagger(\vec{p}', s')\} = \hbar^3 \delta(\vec{p} - \vec{p}')\delta_{ss'}, \quad (36)$$

and otherwise zero. Electron's creation and annihilation operators have  $L^{3/2}$  dimension owing to the commutation relation (36); thus, spinors  $u(p, s)$  and  $v(p, s)$  have a physical dimension of  $E^{1/2}$ . Spinors are normalized as

$$\bar{u}(p, s)\gamma_0 u(p, s') = 2E_p \delta_{ss'}, \quad \text{and} \quad \bar{v}(p, s)\gamma_0 v(p, s') = 2E_p \delta_{ss'}.$$

The polarization sums of an electron and a positron are

$$\sum_s u(p, s)\bar{u}(p, s) = \not{p} + m, \quad \text{and} \quad \sum_s v(p, s)\bar{v}(p, s) = \not{p} - m. \quad (37)$$



**photon:** The Fourier transformation of transversely polarised  $U(1)$  gauge field  $\mathcal{A}_a^T(\xi)$  provides a polarization vector of a physical photon, such that:

$$\hbar^{-1/2} \mathcal{A}_a^T(\xi) =: \frac{1}{(2\pi\hbar)^3} \int \frac{d^3\vec{k}}{\sqrt{2k_0}} \sum_{\lambda=1,2} \epsilon_a^{(\lambda)} \left( a_\gamma(k, \lambda) e^{-i\xi \cdot k/\hbar} + a_\gamma^\dagger(k, \lambda) e^{+i\xi \cdot k/\hbar} \right),$$

where  $k_0$  is an on-shell energy such that  $k_0^2 - \vec{k} \cdot \vec{k} = 0$ , and  $a_\gamma(k, \lambda)$  and  $a_\gamma^\dagger(k, \lambda)$  are, respectively, creation and annihilation operator of a photon with momentum  $k$  and polarization  $\lambda$ . Creation and annihilation operators has  $L^{3/2}$  physical dimension owing to the canonical quantization conditions, e.g.,

$$\left[ a_\gamma(\vec{k}, \lambda), a_\gamma^\dagger(\vec{k}', \lambda') \right] = \hbar^3 \delta^3(\vec{k} - \vec{k}') \delta_{\lambda'\lambda}. \quad (38)$$

Consequently, polarization vector  $\epsilon_a^{(\lambda)}$  has null physical dimension. A photon polarization vector is normalized as

$$\sum_{\lambda=1,2} \epsilon_a^{(\lambda)}(k) \epsilon_b^{(\lambda)}(k) = -\eta_{ab} + (1 - \xi_A) \frac{k_a k_b}{\eta_{\circ\circ} k^\circ k^\circ}, \quad (39)$$

in the covariant gauge (20).

#### 4.2.2 Gravitational part:

**vierbein:** We consider an asymptotic state of the vierbein field in the asymptotically flat space-time with  $g_{\mu\nu} = \text{diag}(1, -1, -1, -1)$ . The Fourier transformation of the vierbein field of the fundamental solution (34) provides a polarization vector in the momentum space, such that:

$$(\hbar)^{-1} \mathcal{E}_\mu^a(x) =: \frac{1}{(2\pi\hbar)^4} \int d^4p \tilde{\mathcal{E}}_\mu^{(\lambda)} \left( a_\mathcal{E}(p, \lambda) e^{-ix \cdot p/\hbar} + a_\mathcal{E}^\dagger(p, \lambda) e^{+ix \cdot p/\hbar} \right) \Big|_{\lambda=a}. \quad (40)$$

We note that the vacuum concerning the vierbein field is not a flat metric in general, and the Fourier transformation and the momentum space in the curved space-time is not trivial[24]. The vierbein fields appear in the integral kernel of the Fourier transformation as

$$x \cdot p := g_{\mu\nu}(x) x^\mu p^\nu = \eta_{\circ\circ} \mathcal{E}_\mu^\circ(x) \mathcal{E}_\nu^\circ(x) x^\mu p^\nu,$$

and thus, the integration (40) is not well-defined in the curved space-time. We consider the Fourier transformation only in the asymptotic frame assumed to be flat.

The equation of motion of the free vierbein field in the flat space-time shown in (33) is the same as that of a photon; thus, the Fock space of a free (asymptotic) vierbein operator is the same as that of a photon. The canonical quantization condition requires an equal-time commutation relation on creation and annihilation operators of the physical vierbein fields, such as[10]

$$\left[ a_\mathcal{E}(p, \lambda), a_\mathcal{E}^\dagger(p', \lambda') \right] = \hbar^4 \delta(p_0 - p'_0) \delta^3(\vec{p} - \vec{p}') \delta_{\lambda'\lambda}. \quad (41)$$

Consequently, annihilation and creation operators of the vierbein field have the length squared dimension, and a polarization vector in the momentum space has a null physical dimension.

We introduce four polarization vectors of the asymptotic vierbein field propagating along, e.g., the  $x^1$ -axis, such as

$$\tilde{\mathcal{E}}_\mu^{(\lambda)} := \frac{1}{\sqrt{2}} \begin{cases} (1, i, 0, 0), & (\lambda = 0), \\ (i, 1, 0, 0), & (\lambda = 1), \\ (0, 0, 1, 1), & (\lambda = 2), \\ (0, 0, 1, -1), & (\lambda = 3). \end{cases}$$

with a circular polarization. The vierbein field is constructed from polarization vectors, such as

$$\mathcal{E}_\mu^a := \tilde{\mathcal{E}}_\mu^{(\lambda=a)},$$

which provides a flat metric tensor

$$g_{\mu\nu} = \eta_{\circ\circ} \mathcal{E}_\mu^\circ \mathcal{E}_\nu^\circ = \text{diag}(1, -1, -1, -1).$$

This relation implies the normalisation of the polarization vector as

$$\sum_{\lambda, \lambda'} \eta_{\lambda' \lambda} \tilde{\mathcal{E}}_\mu^{(\lambda)}(p) \tilde{\mathcal{E}}_\nu^{(\lambda')}(p) = g_{\mu\nu}. \quad (42)$$

Each vierbein polarization vector represents the spin-one state, and a symmetric product (42) concerning two Lorentz indexes constructs a spin-two state of the quantised metric tensor.

Two polarization vectors,

$$\mathbf{p}^{(\lambda=+)} := \tilde{\mathcal{E}}_\mu^{(2)} dp^\mu = \frac{1}{\sqrt{2}} (dp^2 + dp^3) \quad \text{and} \quad \mathbf{p}^{(\lambda=\times)} := \tilde{\mathcal{E}}_\mu^{(3)} dk^\mu = \frac{1}{\sqrt{2}} (dp^2 - dp^3),$$

have a dynamic degree and are physically observable in the quantum field theory, similar to the polarization vector of the transversely polarised photon in the QED. We use representations  $\lambda = 2 =: +$  and  $\lambda = 3 =: \times$  according to the standard convention. Polarization vectors

$$\tilde{\mathcal{E}}_\mu^{(s)} := \frac{1}{\sqrt{2}} \left( \tilde{\mathcal{E}}_\mu^{(0)} - i \tilde{\mathcal{E}}_\mu^{(1)} \right), \quad \text{and} \quad \tilde{\mathcal{E}}_\mu^{(l)} := \frac{1}{\sqrt{2}i} \left( \tilde{\mathcal{E}}_\mu^{(0)} + i \tilde{\mathcal{E}}_\mu^{(1)} \right),$$

correspond to a scalar vierbein and a longitudinally polarised vierbein, respectively. polarization vectors satisfy the covariant gauge condition for the on-shell momentum  $\tilde{p}_\mu = (\tilde{p}, 0, 0, \tilde{p})$  as

$$g^{\mu\nu} \tilde{p}_\mu \tilde{\mathcal{E}}_\nu^{(\lambda)} = 0$$

for  $\lambda = +, \times, s$ .

**spin-connection:** The Fourier transformation of the spin-connection field provides a polarization vector in the momentum space, such that:

$$\hbar^{-1/2} \omega_{\dot{a}}^{(\lambda) b}(\xi) =: \frac{1}{(2\pi\hbar)^3} \int \frac{d^3 \vec{p}}{\sqrt{2}p_0} \sum_{\lambda=1,2} \tilde{\omega}^{(\lambda) b}(\vec{p}) \left( a_\omega(p, \lambda) e^{-i\xi \cdot p/\hbar} + a_\omega^\dagger(p, \lambda) e^{+i\xi \cdot p/\hbar} \right).$$

In contrast to the Vierbein field defined on the global manifold, the spin connection field is defined on the local inertial manifold after Romanising the subscripts. Its Fourier transform is, therefore, well-defined in inertial space. The equation of motion for the free spin-connection field  $\omega_{\circ}^{\circ a}$  shown in (30) is the same as that of a photon; thus, the Fock space of a free vierbein operator is the same as that of a photon, too. We set a canonical quantisation condition of an equal-time commutation relation on creation and annihilation operators of physical spin-connection fields as

$$[a_\omega(p, \lambda), a_\omega^\dagger(p', \lambda')] \Big|_{p_0=p'_0} = \hbar^3 \delta^3(\vec{p} - \vec{p}') \delta_{\lambda'\lambda}.$$

Consequently, a polarisation vector of the spin-connection field in the momentum space has null physical dimension.

We can construct polarization vectors of the spin-two field for the spin-connection in the momentum space. For a spin-connection momentum  $p_a := (p_0, p \sin \vartheta \cos \varphi, p \sin \vartheta \sin \varphi, p \cos \vartheta)$ , we introduce three linearly polarised vectors, such that:

$$\begin{aligned} \tilde{\varepsilon}_a^{(\lambda=1)} &:= (0, \cos \vartheta \cos \varphi, \cos \vartheta \sin \varphi, -\sin \vartheta), \\ \tilde{\varepsilon}_a^{(\lambda=2)} &:= (0, -\sin \varphi, \cos \varphi, 0), \\ \tilde{\varepsilon}_a^{(\lambda=3)} &:= \frac{1}{\sqrt{p_0^2 - p^2}} (p, p_0 \sin \vartheta \cos \varphi, p_0 \sin \vartheta \sin \varphi, p_0 \cos \vartheta). \end{aligned}$$

The polarizations  $\lambda = 1, 2$  are the transverse components of the physical spin-connection, and  $\lambda = 3$  corresponds longitudinal one appearing in the virtual state in the propagator. The circularly polarised vectors are constructed using them as

$$\tilde{\varepsilon}_a^{(+)} := \frac{1}{\sqrt{2}} \left( \tilde{\varepsilon}_1^{(1)} + i\tilde{\varepsilon}_a^{(2)} \right), \quad (43a)$$

$$\tilde{\varepsilon}_a^{(-)} := \frac{1}{\sqrt{2}} \left( \tilde{\varepsilon}_1^{(1)} - i\tilde{\varepsilon}_a^{(2)} \right), \quad (43b)$$

$$\tilde{\varepsilon}_a^{(l)} := \tilde{\varepsilon}_1^{(3)}. \quad (43c)$$

They satisfy the covariant gauge fixing conditions of  $\eta^{\circ\circ} p_\circ \tilde{\varepsilon}_\circ^{(\lambda)} = 0$ .

We can construct polarization vectors of the spin-connection fields owing to spin-one polarization vectors (43a)~(43c) as

$$\tilde{\omega}_{\dot{a}\dot{b}}^{(0)} := \tilde{\varepsilon}_a^{(+)} \tilde{\varepsilon}_b^{(-)} - \tilde{\varepsilon}_a^{(-)} \tilde{\varepsilon}_b^{(+)}, \quad (44a)$$

$$\tilde{\omega}_{\dot{a}\dot{b}}^{(+1)} := \tilde{\varepsilon}_a^{(+)} \tilde{\varepsilon}_b^{(l)} - \tilde{\varepsilon}_a^{(l)} \tilde{\varepsilon}_b^{(+)}, \quad (44b)$$

$$\tilde{\omega}_{\dot{a}\dot{b}}^{(-1)} := \tilde{\varepsilon}_a^{(-)} \tilde{\varepsilon}_b^{(l)} - \tilde{\varepsilon}_a^{(l)} \tilde{\varepsilon}_b^{(-)}, \quad (44c)$$

where a value of  $\dot{a}$  equals to that of  $a$ . Here, we utilise a convention

$$\tilde{\omega}_{\dot{a}\dot{b}}^{(\lambda)} := \tilde{\omega}_{\dot{a}}^{(\lambda) \hat{a}\circ} \eta_{\circ b} |_{\hat{a} \rightarrow \dot{a}} \quad \text{and} \quad \tilde{\omega}_{\dot{a}\dot{b}}^{(\lambda)} := \tilde{\omega}_{\dot{b}}^{(\lambda) \circ \hat{b}} \eta_{\circ a} |_{\hat{b} \rightarrow \dot{b}}$$

to distinguish two different polarization vectors concerning two subscripts. They are anti-symmetric concerning two suffixes and satisfy the covariant gauge condition as

$$\tilde{\omega}_{\dot{a}\dot{b}}^{(\lambda)} = -\tilde{\omega}_{\dot{b}\dot{a}}^{(\lambda)} \quad \text{and} \quad \eta^{\circ\circ} p_\circ \tilde{\omega}_{\dot{a}\circ}^{(\lambda)} = 0.$$

Polarization vectors  $\tilde{\omega}_{\dot{a}\dot{b}}^{(+1)}$ ,  $\tilde{\omega}_{\dot{a}\dot{b}}^{(0)}$  and  $\tilde{\omega}_{\dot{a}\dot{b}}^{(-1)}$  provide the spin-two polarization tensors with a helicity state  $-1, 0$  and  $+1$ .

Polarization vectors (44a)~(44c) provide the polarization sum such that

$$\begin{aligned} \sum_{\lambda=-1,0,1} \tilde{\omega}_{\dot{a}\dot{b}}^{(\lambda)} \tilde{\omega}_{\dot{c}\dot{d}}^{(\lambda)} &= \left( \eta_{ac} + (1 - \xi_\omega) \frac{p_a p_c}{\eta^{\circ\circ} p_\circ p_\circ} \right) \left( \eta_{bd} + (1 - \xi_\omega) \frac{p_b p_d}{\eta^{\circ\circ} p_\circ p_\circ} \right) \\ &\quad - \left( \eta_{ad} + (1 - \xi_\omega) \frac{p_a p_d}{\eta^{\circ\circ} p_\circ p_\circ} \right) \left( \eta_{bc} + (1 - \xi_\omega) \frac{p_b p_c}{\eta^{\circ\circ} p_\circ p_\circ} \right) \end{aligned} \quad (45)$$

in the covariant gauge fixing (25a) with the unitary gauge ( $\xi_\omega = 0$ ).

**ghosts:** Although a ghost field for the  $U(1)$  gauge does not appear in scattering processes, that for gravity is indispensable in the QGED. We define generalised four-momenta concerning ghost/anti-ghost fields as

$$\pi_\chi^a := \frac{\delta \mathcal{L}_{GR;gh}}{\delta (\partial_a \chi)} = -\eta^{a\circ} \partial_\circ \bar{\chi} \quad \text{and} \quad \pi_{\bar{\chi}}^a := \frac{\delta \mathcal{L}_{GR;gh}}{\delta (\partial_a \bar{\chi})} = \eta^{a\circ} \partial_\circ \chi - c_{gr} \omega_\star^{a\star} \chi,$$

owing to ghost Lagrangian (28). The Fourier transformation of ghost/anti-ghost fields provides those in the momentum space, such that:

$$(\kappa_E \hbar)^{-1} \chi(\xi) =: \frac{1}{(2\pi \hbar)^4} \int d^4 p \tilde{\chi}(p) \left( a_\chi(p) e^{-i\xi \cdot p/\hbar} + a_\chi^\dagger(p) e^{+i\xi \cdot p/\hbar} \right) \quad \text{and} \quad (\chi \rightarrow \bar{\chi}, \tilde{\chi} \rightarrow \tilde{\bar{\chi}}). \quad (46)$$

The equation of motion for ghost/anti-ghost fields are the Klein–Gordon equation; thus, the Fock space of a free ghost/anti-ghost operators is the same as that of the standard scalar field. Commutation relations for creation and annihilation operators of ghost/anti-ghost fields are

$$\{a_\chi(p), a_\chi^\dagger(p')\} = \{a_{\bar{\chi}}(p), a_{\bar{\chi}}^\dagger(p')\} = \hbar^4 \delta(p_0 - p'_0) \delta^3(\vec{p} - \vec{p}').$$

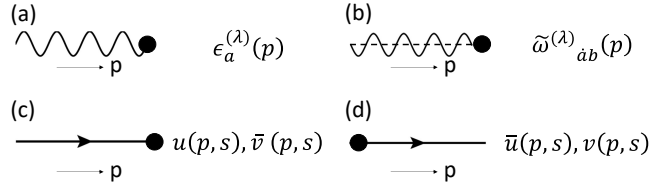

Figure 1: Figures provide pictorial representations of the external QEDG fields. A solid circle shows the interaction vertex. We take the momentum of the external field in the incoming direction.

Consequently, ghost/anti-ghost fields in the momentum space have a null physical dimension. We normalised ghost/anti-ghost fields in the momentum space such that

$$\tilde{\chi}(p)^2 = \bar{\chi}(p)^2 = 1. \quad (47)$$

Fields appearing in the QGED and their physical dimensions are summarised in Table 2.

### 4.3 Vertices

In our convention, we define the Feynman rule for the interaction vertex owing to the Fourier transform of the Lagrangian without any extra phase (imaginary unit). The vertex rule provides a multiplicable factor after truncated wave functions and creation/annihilation operators. We provide a gravitational interaction vertex of an electron as

$$\tilde{V}_{\omega\psi} := -i \frac{c_{gr}}{2} \gamma^\circ \mathcal{E}_\circ^\mu \tilde{\omega}_\mu^{**} \frac{\sigma^{**}}{2} = \frac{c_{gr}}{4} \gamma^\circ \tilde{\omega}_\circ^{**} \gamma_\star \gamma_\star, \quad (48a)$$

$$= \frac{c_{gr}}{2} \eta^{\circ\circ} \sum_{a=0}^3 (\gamma^a \gamma_\circ \gamma_a) \tilde{\omega}_{\dot{a}\circ} = c_{gr} \frac{D-2}{2} \eta^{\circ\circ} \gamma_\circ \tilde{\omega}_{\dot{\Sigma}_\circ}. \quad (48b)$$

where  $\tilde{\omega}_{\dot{\Sigma}_b} := \sum_a \tilde{\omega}_{ab}$  and  $D = 4 - 2\varepsilon_{UV}$  is a space-time dimension. After summing up one tensor component,  $\tilde{\omega}_{\dot{\Sigma}_b}$  is a Lorentz vector. The spin-connection form is the one-form object in  $T^*\mathcal{M}$  and the rank-two tensor in  $\mathcal{TM}$ . Using the component representation of the coordinate-free object  $\mathfrak{w}$  such that:

$$\mathfrak{w} := \frac{1}{2} \mathfrak{w}^{ab} (\partial_a \times \partial_b) = \frac{1}{2} \omega_c^{ab} \mathbf{e}^c (\partial_a \times \partial_b),$$

we can write the definition of  $\tilde{\omega}_{\dot{\Sigma}_b}$  in the configuration space as  $\omega_{\dot{\Sigma}^b} := \omega_a^{ab}$ , where “ $\times$ ” is the anti-symmetric product of two vectors in  $\mathcal{TM}$ . Therefore,  $\omega_a^{ab}$  is the Lorentz vector in  $\mathcal{TM}$ , and  $\eta^{\circ\circ} \gamma_\circ \tilde{\omega}_{\dot{\Sigma}_\circ}$  is the Lorentz invariant.

The gravitational Lagrangian density in (12a) provides the interaction vertex among vierbein and spin-connection fields as

$$\tilde{V}_{\omega\mathcal{E}} = -\frac{c_{gr}^2}{2} \eta_{\circ\circ} (\delta_c^a \delta_d^b - \delta_c^b \delta_d^a) \omega_a^{c\circ} \omega_b^{d\circ}, \quad (49)$$

Table 2: Fields in the QGED and its physical dimension in the Lagrangian and Feynman rules.

Field		configurations space	dim.	momentum space	dim.
electron	(section)	$\psi(\xi)$	$L^{-3/2}$	$u(p, s)$	$E^{1/2}$
vierbein		$\mathcal{E}_\mu^a(x)$	1	$\tilde{\mathcal{E}}_\mu^{(\lambda)}(p)$	1
photon	(connection)	$\mathcal{A}_a(\xi)$	$L^{-1}$	$\epsilon_a^{(\lambda)}(p)$	1
spin-connection		$\omega_c^{ab}(\xi)$	$L^{-1}$	$\tilde{\omega}^{(\lambda)a}(p)$	1
ghost/anti-ghost		$\chi(\xi)/\bar{\chi}(\xi)$	1	$\tilde{\chi}(p)/\bar{\chi}(p)$	1

where the factor  $L_p^{-2}$  is omitted since an overall factor of the Lagrangian does not contribute to the Feynman rules. This vertex term is defined in the inertial space. Vierbein functions are factored out and give determinant  $\det[\mathcal{E}]$ , which is absorbed in a part of the volume form. After the Fourier transformation, the second term of (49) is

$$\eta_{\circ\circ} \delta_c^b \delta_d^a \tilde{\omega}_a^\dagger \tilde{\omega}_b^{\circ\circ} = \sum_{\dot{a}} \tilde{\omega}_{\dot{a}\circ}^\dagger \tilde{\omega}_{\dot{a}\circ}^{\circ\circ},$$

which provides a summation of the normalization constant of the connection field; thus, it does not contribute to scattering amplitudes.

We apply a further modification to the Lagrangian using the torsion-less condition. Given the vierbein field, we can algebraically solve the torsion-less equation (31) easily using our choice of independent spin-connection components (24).

$$\begin{aligned} (31) &\implies c_{gr} (\omega_b^a{}_c - \omega_c^a{}_b) = -\mathcal{E}_\mu^a (\partial_c \mathcal{E}_b^\mu - \partial_b \mathcal{E}_c^\mu), \\ &\implies \sum_{a=c} c_{gr} (\omega_b^a{}_c - \omega_c^a{}_b) = -\sum_{a=c} \mathcal{E}_\mu^a (\partial_c \mathcal{E}_b^\mu - \partial_b \mathcal{E}_c^\mu), \\ &\implies c_{gr} \omega_{\dot{\Sigma}}^\circ \eta_{\circ a} = \mathcal{E}_\mu^\circ \partial_a \mathcal{E}_\circ^\mu. \end{aligned}$$

Thus, we obtain after the Fourier transformation that

$$(49) \implies \frac{c_{gr}}{2} \tilde{\omega}_{\dot{\Sigma}}^\circ \left( \tilde{\mathcal{E}}_\mu^\star \partial_\circ \tilde{\mathcal{E}}_\star^\mu \right).$$

Therefore, we obtain two vertex terms using polarization vectors (44a)~(44c) in the momentum space, such that:

$$\tilde{V}_{\omega\mathcal{E}} = c_{gr} \tilde{\omega}_{\dot{\Sigma}}^\circ (\mathcal{E}_\mu^\star \partial_\circ \mathcal{E}_\star^\mu) = -c_{gr} \tilde{\omega}_{\dot{\Sigma}}^\circ (\mathcal{E}_\star^\mu \partial_\circ \mathcal{E}_\mu^\star),$$

for (spin-connection)-(vierbein) vertex owing to the interaction Lagrangian (12a).

The Feynman rule for (spin-connection)-(ghost) vertex is obtained from (28) as

$$\tilde{V}_{\tilde{\chi}\omega\chi} = c_{gr} (\partial_\circ \tilde{\chi}) \tilde{\omega}_{\dot{\Sigma}}^\circ \tilde{\chi}$$

for the ghost vertex owing to the Lagrangian (28). We are performing perturbative expansion of the gravitational Lagrangian, treating the interaction Lagrangian as the small perturbation concerning the kinetic term (free Lagrangian). Therefore, an overall factor commonly appearing on the gravitational Lagrangian does not contribute to the perturbative expansion. Consequently, the vertex rule has no factor  $(\kappa_E \hbar)^{-1}$ .

The electromagnetic interaction vertex is the same as the QED; thus, we obtain the QGED interaction vertices shown in Figure 2 as follows:

$$\bullet \text{ (photon)-(electron)}^2 \quad \text{(Figure 2-(a))}: \quad e \gamma^a \quad (50a)$$

$$\bullet \text{ (spin-connection)-(electron)}^2 \quad \text{(Figure 2-(b))}: \quad (1 - \varepsilon_{UV}) c_{gr} \gamma_a \quad (50b)$$

$$\bullet \text{ (spin-connection)-(vierbein)}^2 \quad \text{(Figure 2-(c))}: \quad c_{gr} p_b^\mathcal{E} \quad (50c)$$

$$\bullet \text{ (spin-connection)-(ghost)}^2 \quad \text{(Figure 2-(d))}: \quad c_{gr} p_b^\chi \quad (50d)$$

where  $p_b^\mathcal{E}$  and  $p_b^\chi$  are incoming momenta of the vierbein and ghost fields, respectively.

## 4.4 Propagators

A quantum propagator is the vacuum-to-vacuum transition amplitude of the time-ordered product of quantum fields consisting of a sum of creation and annihilation operators, such that:

$$D_F(\xi - \eta) := i \langle 0 | T \phi(\xi) \phi(\eta) | 0 \rangle, \quad (51)$$

where  $\phi(\xi)$  shows a general quantum field at  $\xi \in T^*\mathcal{M}$ . Additional degrees of freedom, e.g., a Lorentz index of vector bosons or a spinor index of electrons, are omitted here. A suffix “ $F$ ” of  $D_F$  stands for

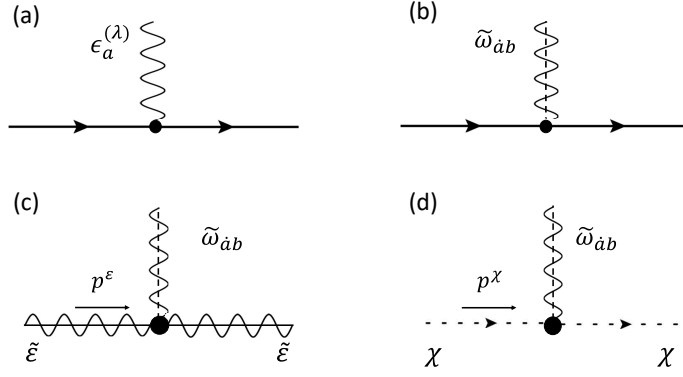

Figure 2: Figures provide pictorial representations of the QEDG vertices for (a) electron-photon vertex, (b) electron-spin-connection vertex, (c) spin-connection-vierbein vertex, and (c) ghost-spin-connection vertex. Vertex Feynman rules are given in (50a)~(50d).

the *Feynman propagator* and is omitted hereafter. The Feynman propagator naturally appears in some extended Riemannian metric (the  $\theta$ -metric[24]). The classical counterpart of a quantum propagator is Green's function for the equation of motion for the free gauge field, which is a wave equation; thus, their Fock space of creation and annihilation operators is the same as that of the QED gauge field.

The Fourier transformation of (51) provides a quantum propagator in the momentum space such that:

$$D^\phi(p) = \frac{i}{(2\pi\hbar)^2} \int_{T^*\mathcal{M}} \mathbf{v} e^{-ip \cdot \xi/\hbar} \langle 0 | T^* \phi(\xi) \phi(0) | 0 \rangle = \frac{\sum_\lambda \tilde{\phi}^{(\lambda)}(p) \tilde{\phi}^{(\lambda)}(p)}{-\eta_{\circ\circ} p^\circ p^\circ - i\delta}, \quad (52)$$

where  $p$  is a momentum of the field and  $\tilde{\phi}^{(\lambda)}(p)$  is a wave function in the momentum space with polarization  $\lambda$ . A contraction of vectors in  $p \in T^*\tilde{\mathcal{M}}$  and  $\xi \in T^*\mathcal{M}$  is  $p \cdot \xi := \eta^{\circ\circ} p_\circ \xi_\circ$ .

We obtain propagators for QGED fields owing to (52) as follows:

- Photon propagator:

$$D_{ab}^{\mathcal{A}}(p) = \frac{\sum_\lambda \epsilon_a^{(\lambda)}(p) \epsilon_b^{(\lambda)}(p)}{-\eta_{\circ\circ} p^\circ p^\circ - i\delta} \quad (53a)$$

- Electron propagator:

$$S_\psi(p) = \frac{\sum_s u(p, s) \bar{u}(p, s)}{-\eta_{\circ\circ} p^\circ p^\circ + m^2 - i\delta} \quad (53b)$$

- Vierbein propagator:

$$D_{\mu\nu}^{\mathcal{E}}(p) = \frac{\sum_\lambda \tilde{\mathcal{E}}_\mu^{(\lambda)}(p) \tilde{\mathcal{E}}_\nu^{(\lambda)}(p)}{-\eta_{\circ\circ} p^\circ p^\circ - i\delta} \quad (53c)$$

- Spin-connection propagator:

$$D_{\dot{a}b;\dot{c}d}^\omega(p) = \frac{\sum_\lambda \tilde{\omega}_{\dot{a}b}^{(\lambda)} \tilde{\omega}_{\dot{c}d}^{(\lambda)}}{-\eta_{\circ\circ} p^\circ p^\circ - i\delta} \quad (53d)$$

- Ghost propagator:

$$D_\chi(p) = \frac{\tilde{\chi}(p)^2}{-\eta_{\circ\circ} p^\circ p^\circ - i\delta} \quad (53e)$$

Polarization summations for the QGED fields are given in (37), (39), (42), (45) and (47). The vierbein propagator (53c) is defined in the momentum space corresponding to the (flat) asymptotic space-time.

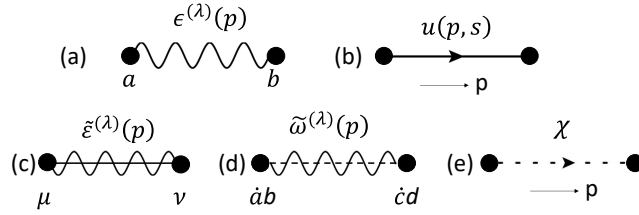

Figure 3: Figures provide pictorial representations of the QEDG propagators. A solid circle shows the interaction vertex. Equation numbers show the propagator function and field normalisation of the corresponding field.

## 4.5 Integration measure and S-matrix

An integration measure for each loop momentum  $l_j$  and outgoing external momentum  $k_j$  are, respectively, taken to be

$$\prod_j (-1)^{\sigma_j} (\mu_R^2)^{\epsilon_{UV}} \frac{d^D l_j}{i(2\pi)^D} \quad \text{and} \quad \prod_j \frac{d^3 k_j}{(2\pi)^3} \frac{1}{2k_j^0}, \quad (54)$$

where  $k_j^0$  is the zeroth component of the  $j$ 'th outgoing momentum  $k_j$ . In the dimensional regularisation method, we need to put an arbitrary parameter with energy dimension,  $\mu_R$ , to adjust the physical dimension of the loop contribution. We set  $\sigma_j = 1$ , if a  $j$ 'th loop particle is an electron or a ghost; otherwise,  $\sigma_j = 0$ . An imaginary unit in the loop integration is eliminated owing to the analytic continuation (the Wick rotation) concerning the zeroth component  $dl_j^0$ .

The  $S$ -matrix is defined owing to the interaction Lagrangian as

$$S := T^* \exp \left[ i \int d^4 \xi \mathcal{L}_{int}(\xi) \right],$$

and its perturbative expansion is

$$S = 1 + \sum_{N=1}^{\infty} \frac{i^N}{N!} \int d^4 \xi_1 \cdots \int d^4 \xi_N T^* [\mathcal{L}_{int}(\xi_1) \cdots \mathcal{L}_{int}(\xi_N)].$$

The scattering matrix, namely  $T$ -matrix, is defined owing to the  $S$ -matrix as

$$S = 1 + iT. \quad (55)$$

Matrix elements  $S_{fi} := \langle f | S | i \rangle$  is expressed as

$$S_{fi} = \delta_{fi} + i(2\pi)^4 \delta(p_f - p_i) \sum_{pol} |T_{fi}|^2,$$

where  $|i\rangle$  and  $|f\rangle$  are, respectively, initial and final states, and  $p_i$  and  $p_f$  are their total momentum. Our convention of Feynman rules, including the gravitational bosons, gives a factor of the scattering matrix in total, such as

$$i^N = i \times i^{N+L-1} \times i^{-L},$$

where the second factor is absorbed into the propagators and the last factor into loop integrals; thus, the first  $i$  gives a correct factor of  $iT$ .

## 5 Renormalisation of the QGED

This section demonstrates a renormalisation of the QGED at a one-loop order owing to the Feynman rules provided in previous section. In following calculations, We exploit the Feynman gauge for both photon and spin-connection fields, such that  $\xi_A = \xi_\omega = 1$ .

Table 3: The number of ingredients of the Feynman diagrams.

	Type	the number in diagrams
External lines	electron	$E_\psi$
	photon	$E_\gamma$
	vierbein	$E_\mathcal{E}$
	spin-connection	$E_\omega$
Internal lines	electron	$I_\psi$
	photon	$I_\gamma$
	vierbein	$I_\mathcal{E}$
	spin-connection	$I_\omega$
	ghost/anti-ghost	$I_\chi$
Vertex	(electron) <sup>2</sup> -(photon)	$V_\gamma$
	(electron) <sup>2</sup> -(spin-connection)	$V_\omega$
	(vierbein) <sup>2</sup> -(spin-connection) <sup>*)</sup>	$V_\mathcal{E}$
	(ghost)-(anti-ghost)-(spin-connection) <sup>*)</sup>	$V_\chi$
Loops		$L$

\*) derivative coupling

## 5.1 Power counting

Before starting the one-loop renormalisation of the QGED, we apply the power counting on the QGED to confirm its divergence degree. For details of the power counting, see, e.g. Ref.[26]. For each vertex in the interaction Lagrangian, we can judge an ultraviolet divergence degree using

$$\rho = D - \frac{D-1}{2}N_f - \frac{D-2}{2}N_b - N_\delta,$$

where  $N_f$ ,  $N_b$  and  $N_\delta$  are the numbers of electrons, bosons and derivative couplings in the vertex, respectively. When the degree exceeds zero, it induces an ultraviolet divergence, and the theory is unrenormalisable. On the other hand, when the degree is equal to zero, it induces a logarithmic divergence, and the theory is possibly renormalisable. The degrees of vertices in Figure 2 in four-dimensional space-time are

$$\rho_a = \rho_b = 4 - \frac{3}{2} \times 2 - 1 - 0 = 0, \quad \rho_c = \rho_d = 4 - \frac{3}{2} \times 0 - 3 - 1 = 0;$$

thus, the QGED may be renormalisable.

We can assign the superficial degree of divergence  $d$  for any Feynman diagrams. When some Feynman diagrams have  $d \geq 0$ , these diagrams give ultraviolet-divergent integrals. We denote the number of loops, external/internal fields and vertices as shown in Table 3. In the four-dimensional space-time, the superficial degree of divergence is provided as

$$d = DL - 2I_\gamma - 2I_\omega - 2I_\chi - 2I_\mathcal{E} - I_\psi + V_\mathcal{E} + V_\chi. \quad (56)$$

We can express the superficial degree of divergence only by the number of external particles using identities such as

$$\begin{aligned} V_\omega + V_\psi &= I_\psi + \frac{1}{2}E_\psi, \\ V_\psi &= 2I_\gamma + E_\gamma, \\ V_\mathcal{E} &= I_\mathcal{E} + \frac{1}{2}E_\mathcal{E}, \\ V_\chi &= I_\chi, \\ E_\omega + 2I_\omega &= V_\mathcal{E} + V_\omega + V_\chi, \\ L - 1 &= I_\gamma + I_\psi + I_\mathcal{E} + I_\omega + I_\chi - V_\mathcal{E} - V_\chi - V_\omega - V_\psi. \end{aligned}$$



Consequently, we obtain the superficial degree of divergence in four-dimensional space-time, such that:

$$d = 4 - E_\gamma - E_\mathcal{E} - E_\omega - \frac{3}{2}E_\psi.$$

Therefore, ultraviolet-divergent diagrams have external particles as

$$E_\gamma + E_\mathcal{E} + E_\omega + \frac{3}{2}E_\psi < 4;$$

thus, the finite number of diagrams gives an ultraviolet divergent, which can be eliminated by the finite number of counter terms.

## 5.2 One-loop renormalisation

This section provides renormalisation constants and counter terms of the QGED at a one-loop level. Although the QED's renormalisation procedure is established and known well, we repeat it as a guide for the renormalisation of a gravitational part. We exploit the on-shell renormalisation conditions such that

1. the pole position of propagators should locate at physical mass,
2. residues of propagators at the pole should be unity,

and the charge renormalisation utilised in Refs.[25, 27, 28]. This report refers to charge renormalisation as the coupling constant renormalisation. Owing to the second condition of the on-shell condition, we can omit self-energy correction diagrams on the external line.

Throughout this study, we exploit dimensional regularisation to regulate the ultraviolet divergence and put fictitious masses into massless bosons to treat infrared divergence.

### 5.2.1 Renormlisation constants

For a QED part, renormalisation constants  $Y_{\mathcal{A}}$ ,  $Z_\psi$ ,  $Z_{\mathcal{A}3}$  and  $\delta m_{e\mathcal{A}}$  are introduced to the Lagrangian. In the QGED, additional renormalisation constants,  $Y_\omega$ ,  $Z_{\omega3}$ ,  $Z_{\mathcal{E}3}$  and  $\delta m_{e\omega}$  appears. Bare objects in the Lagrangian are replaced as

$$\begin{aligned} \psi^{(\infty)} &= Z_{\psi\mathcal{A}}^{1/2} Z_{\psi\omega}^{1/2} \psi, \\ \mathcal{A}_a^{(\infty)} &= Z_{\mathcal{A}}^{1/2} \mathcal{A}_a, \quad \omega_c^{(\infty)ab} = Z_\omega^{1/2} \omega_c^{ab}, \quad \mathcal{E}_\mu^{(\infty)a} = Z_{\mathcal{E}}^{1/2} \mathcal{E}_\mu^a \\ e^{(\infty)} &= Y_{\mathcal{A}} e, \quad c_{gr}^{(\infty)} = Y_\omega c_{gr}, \\ m_e^{(\infty)} &= m_e + (\delta m_e^{\mathcal{A}} + \delta m_e^\omega). \end{aligned}$$

In addition to that, there are several mixed corrections at  $\mathcal{O}(ec_{gr})$ . Then, we add the counter-term Lagrangian to the renormalised one.

### 5.2.2 Photon and spin-connection renormalisation

First, we provide a gauge boson renormalisation in the QGED. Vacuum polarisation diagrams in the QGED are depicted in Figures 4 and 5; the former shows the electron-loop diagrams, and the latter shows boson-loop diagrams. We calculate vacuum polarization at  $\mathcal{O}(e^2)$ ,  $\mathcal{O}(c_{gr}^2)$  and  $\mathcal{O}(ec_{gr})$ .

Owing to the Lorentz invariance of the photon wave function, the vacuum polarization diagram of a photon shown in Figure 4-(a) can be expressed as

$$\text{Figure 4-(a)} =: \Pi_{ab}^{(\gamma e \gamma)}(q^2) = \left( \eta_{ab} - \frac{q_a q_b}{q^2} \right) a_{\gamma e \gamma}(q^2) + \frac{q_a q_b}{q^2} b_{\gamma e \gamma}(q^2) \quad (57a)$$

in general, where  $q_a$  is a photon momentum. After standard calculations, we obtain the results as

$$a_{\gamma e \gamma}(q^2) = -\frac{\alpha}{4\pi} \frac{4}{3} q^2 \left( C_{UV} - \log \frac{m_e^2}{\mu_R^2} \right), \quad (57b)$$

$$b_{\gamma e \gamma}(q^2) = 0, \quad (57c)$$

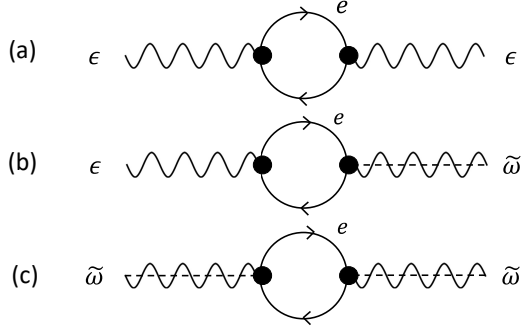

Figure 4: Photon and spin-connection vacuum-polarization diagrams with an electron loop.

where  $C_{UV} := 1/\varepsilon_{UV} - \gamma_E + \log 4\pi$  and  $\alpha := e^2/4\pi$ . The vacuum polarisation fulfils a current conservation such as

$$\eta^{\circ\circ} q_\circ \Pi_{a^\circ}^{(\gamma e \gamma)}(q^2) = 0.$$

We obtain the renormalisation constant for a photon wave function as

$$Z_{\omega}^{-1/2} = 1 - \frac{1}{2} \frac{\partial}{\partial q^2} a_{\gamma e \gamma}(q^2) \Big|_{q^2=0} = 1 - \frac{1}{2} \frac{\alpha}{4\pi} \frac{4}{3} \left( C_{UV} - \log \frac{m_e^2}{\mu_R^2} \right). \quad (58)$$

Vertex Feynman rules for a (photon)-(electron) and a (spin-connection)-(electron) are the same as each other except the coupling constant, as shown in (50a) and (50b); thus, vacuum polarisations, including the spin-connection fields, are easily provided from that for a photon as follows:

$$\text{Figure 4-(b)} =: \Pi_{ab}^{(\gamma e \omega)}(q^2) = \left( \eta_{ab} - \frac{q_a q_b}{q^2} \right) a_{\gamma e \omega}(q^2) + \frac{q_a q_b}{q^2} b_{\gamma e \omega}(q^2),$$

$$\text{Figure 4-(c)} =: \Pi_{ab}^{(\omega e \omega)}(q^2) = \left( \eta_{ab} - \frac{q_a q_b}{q^2} \right) a_{\omega e \omega}(q^2) + \frac{q_a q_b}{q^2} b_{\omega e \omega}(q^2),$$

where

$$a_{\gamma e \omega}(q^2) = -\frac{(\alpha \alpha_{gr})^{1/2}}{4\pi} \frac{4}{3} q^2 \left( C_{UV} - 1 - \log \frac{m_e^2}{\mu_R^2} \right),$$

$$a_{\omega e \omega}(q^2) = -\frac{\alpha_{gr}}{4\pi} \frac{4}{3} q^2 \left( C_{UV} - 2 - \log \frac{m_e^2}{\mu_R^2} \right),$$

$$b_{\gamma e \omega}(q^2) = b_{\omega e \omega}(q^2) = 0,$$

where  $\alpha_{gr} := c_{gr}^2/4\pi$ . Again, they fulfil the current conservation by themselves.

The spin-connection has two other vacuum polarisation diagrams; a vierbein loop shown in Figure 5-(a) and a ghost loop shown in Figure 5-(b). The calculations of both diagrams are very similar owing to their derivative couplings. A difference comes from scalar or vector propagators in loops. The Feynman rules provide the results as

$$\begin{aligned} \text{Figure 5-(a)} =: \Pi_{ab}^{(\omega \mathcal{E} \omega)}(q^2) &= \frac{1}{2} c_{gr}^2 (\mu_R^2)^{\varepsilon_{UV}} \int \frac{d^D k}{i(2\pi)^D} \frac{\eta^{\circ\circ} k_\circ (k_\circ + q_\circ)}{k^2 (k - q)^2} \eta_{ab}, \\ &= \left( \eta_{ab} - \frac{q_a q_b}{q^2} \right) a_{\omega \mathcal{E} \omega}(q^2) + \frac{q_a q_b}{q^2} b_{\omega \mathcal{E} \omega}(q^2), \end{aligned}$$

$$\begin{aligned} \text{Figure 5-(b)} =: \Pi_{ab}^{(\omega \chi \omega)}(q^2) &= -c_{gr}^2 (\mu_R^2)^{\varepsilon_{UV}} \int \frac{d^D k}{i(2\pi)^D} \frac{k_a (k_b + q_b)}{k^2 (k - q)^2}, \\ &= \left( \eta_{ab} - \frac{q_a q_b}{q^2} \right) a_{\omega \chi \omega}(q^2) + \frac{q_a q_b}{q^2} b_{\omega \chi \omega}(q^2). \end{aligned}$$

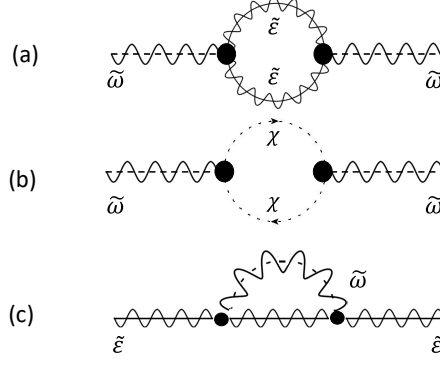

Figure 5: spin-connection and vierbein vacuum-polarization diagrams with a boson loop.

A factor of one-half in the vierbein loop is due to the symmetric factor of two identical particles in the loop.

$$a_{\omega\varepsilon\omega}(q^2) = 0, \quad a_{\omega\chi\omega}(q^2) = -\frac{\alpha_{gr}}{4\pi} q^2 \frac{1}{6} \left( C_{UV} + \frac{5}{3} - \log \frac{-q^2}{\mu_R^2} \right),$$

$$b_{\omega\varepsilon\omega}(q^2) = -b_{\omega\chi\omega}(q^2) = -\frac{\alpha_{gr}}{4\pi} q^2 \frac{1}{4} \left( C_{UV} + 2 - \log \frac{-q^2}{\mu_R^2} \right) \implies b_{\omega\varepsilon\omega}(q^2) + b_{\omega\chi\omega}(q^2) = 0.$$

Thus, the vacuum polarisation of boson loops fulfils current conservation after summing up two contributions, even though each of them does *NOT*.

At last in the section, we provide a vacuum polarization of a vierbein field depicted in Figure 5-(c). After calculations following the Feynman rules, we obtain that

$$\begin{aligned} \text{Figure 5-(c)} =: \Pi_{ab}^{(\varepsilon\omega\varepsilon)}(q^2) &= c_{gr}^2 (\mu_R^2)^{\varepsilon_{UV}} \int \frac{d^D k}{i(2\pi)^D} \frac{\eta^{\circ\circ} q_\circ (k_\circ + q_\circ) \eta_{ab} - q_a (q_b + k_b)}{k^2 (k - q)^2}, \\ &= \left( \eta_{ab} - \frac{q_a q_b}{q^2} \right) a_{\varepsilon\omega\varepsilon}(q^2) + \frac{q_a q_b}{q^2} b_{\varepsilon\omega\varepsilon}(q^2), \end{aligned}$$

where

$$a_{\varepsilon\omega\varepsilon}(q^2) = -\frac{\alpha_{gr}}{4\pi} q^2 \left( \frac{1}{2} C_{UV} + 1 - \frac{1}{2} \log \frac{-q^2}{\mu_R^2} \right),$$

$$b_{\varepsilon\omega\varepsilon}(q^2) = 0,$$

which fulfils the current conservation by itself.

We introduce total  $N_f$  fermions, in which  $N_{cf}$  fermions are electromagnetically charged, in the QGED

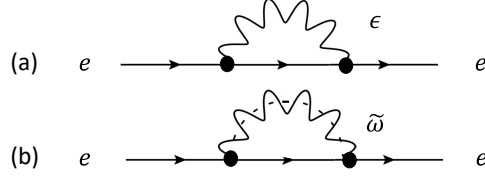

Figure 6: Electron self-energy diagrams

and summarise the renormalisation constant for bosonic fields:

$$\begin{aligned}
Z_{\mathcal{A}}^{1/2} &= 1 - \frac{1}{2} \frac{\partial}{\partial q^2} \sum_{i=1}^{N_{cf}} a_{\gamma e \gamma}(m_i; q^2) \Big|_{q^2=0}, \\
&= 1 - \frac{1}{2} \frac{\alpha}{4\pi} \frac{4}{3} \left( C_{UV} - \sum_{i=1}^{N_{cf}} \log \frac{m_i^2}{\mu_R^2} \right), \tag{59a}
\end{aligned}$$

$$\begin{aligned}
Z_{\omega}^{1/2} &= 1 - \frac{1}{2} \frac{\partial}{\partial q^2} \left( \sum_{i=1}^{N_f} a_{\omega e \omega}(q^2; m_i) + a_{\omega \chi \omega}(q^2) + a_{\omega \mathcal{E} \omega}(q^2) \right) \Big|_{q^2=-\mu_{IR}^2}, \\
&= 1 - \frac{1}{2} \frac{\alpha_{gr}}{4\pi} \frac{1}{12} \left( (1 - 8N_f) C_{UV} - \frac{1}{3} + 24N_f + 8 \sum_{i=1}^{N_f} \log \frac{m_i^2}{\mu_R^2} - \log \frac{\mu_{IR}^2}{\mu_R^2} \right), \tag{59b}
\end{aligned}$$

$$\begin{aligned}
Z_{\mathcal{A}\omega}^{1/2} &= 1 - \frac{1}{2} \frac{\partial}{\partial q^2} \sum_{i=1}^{N_{cf}} a_{\gamma e \omega}(m_i; q^2) \Big|_{q^2=0}, \\
&= 1 - \frac{1}{2} \frac{(\alpha \alpha_{gr})^{1/2}}{4\pi} \frac{4}{3} \left( N_{cf} (C_{UV} - 1) - \sum_{i=1}^{N_{cf}} \log \frac{m_i^2}{\mu_R^2} \right), \tag{59c}
\end{aligned}$$

$$\begin{aligned}
Z_{\mathcal{E}}^{1/2} &= 1 - \frac{1}{2} \frac{\partial}{\partial q^2} a_{\mathcal{E} \omega \mathcal{E}}(q^2) \Big|_{q^2=-\mu_{IR}^2}, \\
&= 1 - \frac{1}{2} \frac{\alpha_{gr}}{4\pi} \left( \frac{1}{2} C_{UV} - \frac{1}{2} \log \frac{\mu_{IR}^2}{\mu_R^2} \right), \tag{59d}
\end{aligned}$$

where  $m_i$  is a mass of  $i$ 'th fermion appearing in the QGED and  $\mu_{IR}$  is an artificial energy scale to regularise an infrared divergence, which is eliminated by adding real spin-connection radiation diagrams. We align fermions such that the first  $N_{cf}$  charged fermions are followed by  $(N_f - N_{cf})$  neutral ones.

### 5.2.3 Electron field and mass renormalisation

Electron self-energy diagrams in Figure 6 provide electron field and mass renormalisation constants. A QED part obtained from Figure 6-(a) with electron momentum  $p_a$  is

$$\text{Figure 6-(a)} =: \Sigma_{\mathcal{A}}^1(\not{p}) = \Sigma_{\mathcal{A}}^1(p^2) \mathbf{1} + \Sigma_{\mathcal{A}}^\gamma(p^2) \not{p},$$

with

$$\begin{aligned}
\Sigma_{\mathcal{A}}^1(p^2) &= -\frac{\alpha}{4\pi} 4m_e \left( C_{UV} - \frac{1}{2} + -F_0(m_e^2, \lambda^2, p^2) \right) \rightarrow \Sigma_{\mathcal{A}}^1(m_e^2) = -\frac{\alpha}{4\pi} 4m_e \left( C_{UV} + \frac{3}{2} - \log \frac{m_e^2}{\mu_R^2} \right), \\
\Sigma_{\mathcal{A}}^\gamma(p^2) &= \frac{\alpha}{4\pi} (C_{UV} - 1 - 2F_1(m_e^2, \lambda^2, p^2)) \rightarrow \Sigma_{\mathcal{A}}^\gamma(m_e^2) = \frac{\alpha}{4\pi} \left( C_{UV} + 2 - \log \frac{m_e^2}{\mu_R^2} \right),
\end{aligned}$$

where  $\not{p} := \eta^{\circ\circ} \gamma_c p_c$  and  $\mathbf{1}$  is a unit spinor. We put a fictitious photon mass  $\lambda$  to regularise an infrared divergence. The above functions have no infrared divergence at  $p^2 = m_e^2$ ; thus, the fictitious photon mass

is set to zero in the rightmost expressions. The Feynman parameter integration of the two-point function  $F_n$  is defined as

$$F_n(\mu_1, \mu_2, \mu_3) := \int dx x^n \log(\mu_1(1-x) + \mu_2 x - \mu_3 x(1-x)).$$

Owing to these results, we can obtain a derivative of these functions as

$$\begin{aligned} \partial \Sigma_{\mathcal{A}}^1(m_e^2) &:= \left. \frac{\partial}{\partial \not{p}} \Sigma_{\mathcal{A}}^1(p^2) \right|_{p^2=m_e^2} = \frac{\alpha}{4\pi} \frac{1}{m_e} \left( 8 + 4 \log \frac{\lambda^2}{m_e^2} \right), \\ \partial \Sigma_{\mathcal{A}}^\gamma(m_e^2) &:= \left. \frac{\partial}{\partial \not{p}} \Sigma_{\mathcal{A}}^\gamma(p^2) \right|_{p^2=m_e^2} = -\frac{\alpha}{4\pi} \frac{1}{m_e^2} \left( 6 + 2 \log \frac{\lambda^2}{m_e^2} \right). \end{aligned}$$

The fictitious photon mass will be eliminated from scattering amplitudes by adding real-photon radiation diagrams. The QED renormalisation constants of the electron field and mass are obtained using the above functions, such that

$$\begin{aligned} Z_{\psi_{\mathcal{A}}}^{1/2} &= 1 - \frac{1}{2} (\Sigma_{\mathcal{A}}^\gamma(m_e^2) + m_e (m_e \partial \Sigma_{\mathcal{A}}^\gamma(m_e^2) + \partial \Sigma_{\mathcal{A}}^1(m_e^2))), \\ &= 1 - \frac{1}{2} \frac{\alpha}{4\pi} \left( C_{UV} + 4 - \log \frac{m_e^2}{\mu_R^2} + 2 \log \frac{\lambda^2}{m_e^2} \right) \end{aligned} \quad (60a)$$

and

$$\begin{aligned} \delta m_e^{\mathcal{A}} &= m_e \Sigma_{\mathcal{A}}^\gamma(m_e^2) + \Sigma_{\mathcal{A}}^1(m_e^2), \\ &= -\frac{\alpha}{4\pi} m_e \left( 3C_{UV} + 4 - 3 \log \frac{m_e^2}{\mu_R^2} \right). \end{aligned} \quad (60b)$$

Similarly, we obtain the electron self-energy in the QGED as

$$\begin{aligned} \text{Figure 6-(b)} &=: \Sigma_\omega(\not{p}), \\ &= (1 - \varepsilon_{UV})^2 c_{gr}^2 (\mu_R^2)^{\varepsilon_{UV}} \int \frac{d^D k}{i(2\pi)^D} \frac{\gamma_\circ(\not{p} + \not{k}) \gamma_\circ}{k^2(k-q)^2} (\eta^{\circ\circ} \eta^{**} - \eta^{*\circ} \eta^{*\circ}) \eta_{**}, \\ &= \Sigma_\omega^1(p^2) \mathbf{1} + \Sigma_\omega^\gamma(p^2) \not{p}. \end{aligned}$$

After similar calculations with the QED one, we obtain that

$$\begin{aligned} \Sigma_\omega^1(p^2) &= -\frac{\alpha_{gr}}{4\pi} 12m_e \left( C_{UV} - \frac{19}{6} - F_0(m_e^2, \lambda_\omega^2, p^2) \right) \rightarrow \Sigma_\omega^1(m_e^2) = -\frac{\alpha}{4\pi} 12m_e \left( C_{UV} - \frac{7}{6} - \log \frac{m_e^2}{\mu_R^2} \right), \\ \Sigma_\omega^\gamma(p^2) &= \frac{\alpha_{gr}}{4\pi} 3 \left( C_{UV} - \frac{11}{3} - 2F_1(m_e^2, \lambda_\omega^2, p^2) \right) \rightarrow \Sigma_\omega^\gamma(m_e^2) = \frac{\alpha_{gr}}{4\pi} 3 \left( C_{UV} - \frac{2}{3} - \log \frac{m_e^2}{\mu_R^2} \right), \end{aligned}$$

and

$$\begin{aligned} \partial \Sigma_\omega^1(m_e^2) &:= \left. \frac{\partial}{\partial \not{p}} \Sigma_\omega^1(p^2) \right|_{p^2=m_e^2} = \frac{\alpha_{gr}}{4\pi} \frac{1}{m_e} \left( 24 + 12 \log \frac{\lambda_\omega^2}{m_e^2} \right), \\ \partial \Sigma_\omega^\gamma(m_e^2) &:= \left. \frac{\partial}{\partial \not{p}} \Sigma_\omega^\gamma(p^2) \right|_{p^2=m_e^2} = \frac{\alpha_{gr}}{4\pi} \frac{1}{m_e^2} \left( -18 - 6 \log \frac{\lambda_\omega^2}{m_e^2} \right) \end{aligned}$$

where  $\lambda_\omega$  is the fictitious spin-connection mass. Consequently, electron field and mass renormalisation constants, respectively, are provided as follows:

$$\begin{aligned} Z_{\psi_\omega}^{1/2} &= 1 - \frac{1}{2} (\Sigma_\omega^\gamma(m_e^2) + m_e (m_e \partial \Sigma_\omega^\gamma(m_e^2) + \partial \Sigma_\omega^1(m_e^2))), \\ &= 1 - \frac{1}{2} \frac{\alpha_{gr}}{4\pi} 3 \left( C_{UV} + \frac{4}{3} - \log \frac{m_e^2}{\mu_R^2} + 2 \log \frac{\lambda_\omega^2}{m_e^2} \right) \end{aligned} \quad (61a)$$

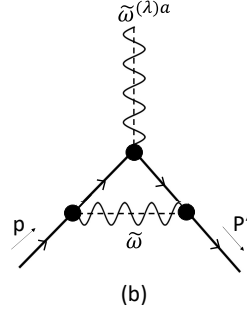
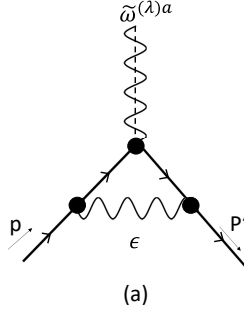
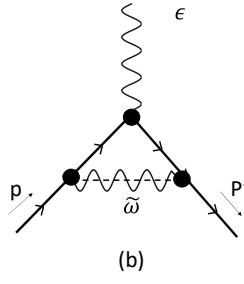
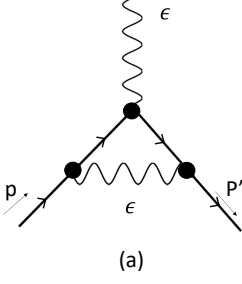

Figure 7: Vertex correction diagrams for the electron-photon vertex

Figure 8: Vertex correction diagrams for the electron-spin-connection vertex

and

$$\begin{aligned} \delta m_e^\omega &= m_e \Sigma_\omega^\gamma(m_e^2) + \Sigma_\omega^1(m_e^2), \\ &= -\frac{\alpha_{gr}}{4\pi} 9 \left( C_{UV} - \frac{4}{3} - \log \frac{m_e^2}{\mu_R^2} \right) \end{aligned} \quad (61b)$$

#### 5.2.4 Coupling constant renormalisation

Coupling constant renormalisation constants are provided using vertex diagrams in Figures 7 and 8 as

$$\text{Figure 7-(a)} =: Z_{\mathcal{A}\mathcal{A}}^V \rightarrow Y_{\mathcal{A}\mathcal{A}} = Z_{\mathcal{A}\mathcal{A}}^V Z_{\psi\mathcal{A}}^{-1} Z_{\mathcal{A}}^{-1/2},$$

$$\text{Figure 7-(b)} =: Z_{\mathcal{A}\omega}^V \rightarrow Y_{\mathcal{A}\omega} = Z_{\mathcal{A}\omega}^V Z_{\psi\omega}^{-1} Z_{\mathcal{A}\omega}^{-1/2},$$

$$\text{Figure 8-(a)} =: Z_{\omega\mathcal{A}}^V \rightarrow Y_{\omega\mathcal{A}} = Z_{\omega\mathcal{A}}^V Z_{\psi\mathcal{A}}^{-1} Z_{\mathcal{A}\omega}^{-1/2},$$

$$\text{Figure 8-(b)} =: Z_{\omega\omega}^V \rightarrow Y_{\omega\omega} = Z_{\omega\omega}^V Z_{\psi\omega}^{-1} Z_{\omega}^{-1/2}.$$

To complete the one-loop renormalisation of the QGED, vertex renormalisation constants are needed. However, current conservation induces the Ward–Takahashi identity[29, 30], such that

$$Z_{\mathcal{A}\mathcal{A}}^V = Z_{\psi\mathcal{A}}, \quad (62a)$$

$$Z_{\mathcal{A}\omega}^V = Z_{\psi\omega}, \quad Z_{\omega\mathcal{A}}^V = (1 - \varepsilon_{UV}) Z_{\psi\mathcal{A}}, \quad (62b)$$

$$Z_{\omega\omega}^V = (1 - \varepsilon_{UV}) Z_{\psi\omega}, \quad (62c)$$

in the QGED; thus, we immediately obtain the coupling renormalisation as

$$Y_{\mathcal{A}\mathcal{A}} = 1 + \frac{\alpha}{4\pi} \frac{2}{3} \left( C_{UV} - \sum_{i=1}^{N_f} \log \frac{m_i^2}{\mu_R^2} \right), \quad (63a)$$

$$Y_{\mathcal{A}\omega} = 1 + \frac{(\alpha\alpha_{gr})^{1/2}}{4\pi} \frac{8}{3} \left( C_{UV} - \frac{1}{4} - \log \frac{m_e^2}{\mu_R^2} + 3 \log \frac{\lambda^2}{m_e^2} \right), \quad (63b)$$

$$Y_{\omega\mathcal{A}} = 1 - \frac{(\alpha\alpha_{gr})^{1/2}}{4\pi} \frac{4}{3} \left( C_{UV} - \frac{5}{4} - \log \frac{m_e^2}{\mu_R^2} + 3 \log \frac{\lambda^2}{m_e^2} \right), \quad (63c)$$

$$Y_{\omega\omega} = 1 + \frac{\alpha_{gr}}{4\pi} \frac{1}{12} \left( (8N_f - 1) C_{UV} - 24N_f + \frac{1}{3} - 8 \sum_{i=1}^{N_f} \log \frac{m_i^2}{\mu_R^2} + \log \frac{\mu_{IR}^2}{\mu_R^2} \right). \quad (63d)$$

**Tadpole renormalisation:** At last, we note that the QGED has no fundamental scalar particle; thus, the tadpole diagram does not appear in the physical processes.

### 5.2.5 Determination of coupling constants and electron mass

We provide all renormalisation constants appearing in one-loop diagrams in the QGED and summarise them in Table 4. All divergent loop corrections are encapsulated in three physical parameters in the bare Lagrangian,  $e^{(\infty)}$ ,  $c_{gr}^{(\infty)}$  and  $m_e^{(\infty)}$ . When we replace them with measured values, we can numerically evaluate probabilities to observe gravioelectromagnetic phenomena. This section discusses how to measure such parameters experimentally.

**Electron charge and mass:** First, we determine the electromagnetic parameters of electric charge and electron mass. As discussed in **section 2.3.2**, a coupling constant can be absorbed in definitions of a connection and a curvature when we look at single gauge interaction. For the pure Yang–Mills theory given by the Lagrangian (12c), coupling constant  $c_{SU}$  can be set to unity. We can fix the coupling constant through the interaction Lagrangian (12b) as a relative value between the coupling constant and an electron mass.

Formally, an electron charge (equivalently, the fine structure constant) is fixed due to a free electron’s forward-scattering of photons, i.e., the Thomson scattering. A ratio of the fine structure constant and an electron mass appears in the Thomson scattering cross section at  $\theta = 0$ , such that

$$\frac{d\sigma_{\text{Th}}}{d\cos\theta} = \pi\hbar\frac{\alpha^2}{m_e^2} (1 + \cos^2\theta) \xrightarrow{\theta \rightarrow 0} 2\pi\hbar\frac{\alpha^2}{m_e^2}.$$

In reality, the fine structure constant is provided by measuring the Lamb shift of atomic spectra. An essential relation to determining the electromagnetic parameters is

$$\alpha^2 = \frac{R_\infty}{c} \times \frac{m_A}{m_e} \times \frac{h}{m_A},$$

where  $R_\infty$  is the Rydberg constant and  $m_A$  is an atomic mass used in the experiment. The Rydberg constant appears in an atom’s electromagnetic spectra and has been measured using the optical frequency of the 2S-12D transitions in hydrogen and deuterium[31]. This measurement does not depend on a measured value of an electron mass. A mass ratio between electron and ionized atomic masses is provided by a ratio of the cyclotron frequency of electron and ionized atom as

$$\frac{m_A}{m_e} = \frac{2}{g} \frac{q}{e} \frac{\nu_A}{\nu_e},$$

where  $g$  is a spin  $g$ -factor (the Landé  $g$ -factor) of an electron,  $q$  is a charge of an ion, and  $\nu_A$  ( $\nu_e$ ) is an ion (electron) cyclotron frequency, respectively. The most precise measured value of  $m_A/m_e$  to date is provided in Ref.[32]. This relative atomic mass is dimensionless observable and independent from the precise value of an electric charge. A rubidium atomic mass has been measured using the combination of Bloch oscillations with a Ramsey-Bordé interferometer[33], which measures the inertial mass of the atom. Consequently, the electron inertial mass is provided through the measured value of the relative electron mass.

**Gravitational coupling constant:** Next, we consider how we can fix the gravitational coupling constant experimentally. All masses discussed so far in this section are the inertial mass appearing in the classical equation of motion and the interaction Lagrangian. On the other hand, when we treat  $\tilde{V}_{\omega\psi}$  defined by (48a), we may fix the gravitational coupling constant with respect to the gravitational mass of the fermion since the Born approximation of the electron scattering with  $\tilde{V}_{\omega\psi}$  provides the amplitude as

$$i\tau = \langle f | i\tilde{V}_{\omega\psi} | i \rangle \simeq -i(2m_e) \boldsymbol{\xi}'^\dagger \tilde{V}_{\omega\psi} \boldsymbol{\xi},$$

where  $\boldsymbol{\xi}$  is a two-component spinor. The normalisation of the external electron field (37) provides the mass in the above amplitude, which must be the gravitational mass. The weak equivalent principle insists that a gravitational mass and an inertial mass are equivalent. In the macroscopic scale, it is confirmed experimentally that both gravitational and inertial masses of a proton are equivalent (proportional) to each other. On a microscopic scale, we can rephrase the equivalent principle as “*the pole mass of an electron*”

in the quantum field theory is equivalent to the gravitational mass in general relativity". Experimental results, e.g., the proton pole mass equals to its gravitational mass, support the microscopic equivalent principle.

We cannot measure the gravitational mass and a coupling constant simply using Newton's law of universal gravity since we formulate a perturbative approach in the inertial system, where gravity is eliminated locally. Consider an experiment measuring the gravitational coupling constant using the Earth's gravity, other than Newton's law of universal gravity. We propose to utilise the *gravitomagnetic effect*[34, 35]. The spin-connection couples to the electron through a tensor coupling; thus, the gravitational field directly interacts with an electron spin. This effect is measurable using existing[36] and future[37] experimental apparatus. In reality, it gives a possible resolution of the muon  $g_\mu - 2$  anomaly and  $c_{gr}$  is consistent with unity[38]. We discuss the measurement of  $c_{gr}$  in detail in **Appendix B**.

### 5.3 Gravitational running coupling and the Landau pole

This section discusses an energy scale dependence of an effective gravitational coupling using a gravitational beta function owing to the renormalisation group equation. In the perturbative quantum field theory, this effect, known as the running coupling constant, provides a stronger coupling at a higher energy scale than lower energy for the QED and vice versa for the QCD. Consequently, an effective coupling may diverge at some specific energy, namely the *Landau pole*. The Landau pole is the energy where the perturbative calculations of the quantum field theory brake down, which does not mean a brake down of the theory itself. E.g., the non-perturbative QCD, such as the lattice QCD, still works below the QCD scale parameter  $\Lambda_{\text{QCD}} \simeq 200\text{MeV}$ . We apply the running coupling to the QGED to discuss the effective gravitational coupling and the applicability of the perturbative QGED for higher energies.

The  $\beta$ -function of the QGED governs the renormalised gravitational coupling  $\alpha_{gr}(\mu_R)$  with respect to the renormalisation scale  $\mu_R$  through the renormalisation group equation (see, e.g., Ref.[39]) such as

$$\mu_R^2 \frac{\partial}{\partial \mu_R^2} \alpha_{gr}(\mu_R^2) = \beta_{gr}(\alpha_{gr}; \mu_R^2).$$

The renormalised gravitational coupling  $\alpha_{gr}(\mu_R)$  at a one-loop order is provided using the renormalisation constant  $Y_{\omega\omega}$  in (63d) as

$$\frac{\alpha_{gr}(\mu_R^2)}{4\pi} = 2\delta Y_{\omega\omega}, \quad \text{where } \delta Y_{\omega\omega} := Y_{\omega\omega} - 1,$$

yielding

$$\beta_{gr}(\alpha_{gr}; \mu_R^2) = -b_{gr}(\mu_R^2) \alpha_{gr}^2(\mu_R^2), \quad \text{with } b_{gr}(\mu_R^2) := -\frac{8N_f(\mu_R^2) - 1}{24\pi}.$$

Consequently, we obtain a solution with the boundary condition  $\alpha_{gr}(\Lambda_{gr}^2) = \alpha_{gr}^0$  as

$$\alpha_{gr}(\mu_R^2) = \frac{\alpha_{gr}^0}{1 + \alpha_{gr}^0 b_{gr} \log(\mu_R^2/\Lambda_{gr}^2)}.$$

We set an energy dependent number of fermions as  $N_f(\mu_R^2)$  since only fermions heavier than the energy transfer contribute to the  $\beta$ -function. When we replace  $b_{gr}(\mu_R^2)$  to

$$b_{\text{QED}}(\mu_R^2) = -\sum_{i=1}^{N_{ef}(\mu_R^2)} \frac{Q_i^2}{3\pi},$$

we can obtain the QED running coupling  $\alpha_{\text{QED}}(\mu_R^2)$  owing to fermions with the electric charge  $Q_i$ .

As we discussed in **section 5.2.5** and **appendix B**, we renormalise electromagnetic and gravitational coupling constants at  $\Lambda_{\text{QED}} = 2m_e$  and  $\Lambda_{gr} = \bar{q}_\oplus \times m_\mu$ , such that:

$$\alpha_{\text{QED}}^0 = \frac{1}{137.036} = 0.00729735 \dots \quad \text{and} \quad \alpha_{gr}^0 = \frac{c_{gr}^2}{4\pi} \Big|_{c_{gr}=1} = 0.0795775 \dots,$$



Table 4: Table of renormalisation constants

renormalisation constants		order of coupling(s)	equation number
Fird renomalisation	$Z_{\mathcal{A}}^{1/2}$	$\mathcal{O}(e^2)$	(58)
	$Z_{\omega}^{1/2}$	$\mathcal{O}(c_{gr}^2)$	(59b)
	$Z_{\mathcal{A}\omega}^{1/2}$	$\mathcal{O}(e c_{gr})$	(59c)
	$Z_{\mathcal{E}}^{1/2}$	$\mathcal{O}(c_{gr}^2)$	(59d)
	$Z_{\psi\mathcal{A}}^{1/2}$	$\mathcal{O}(c_{gr}^2)$	(60a)
	$Z_{\psi\omega}^{1/2}$	$\mathcal{O}(c_{gr}^2)$	(61a)
Mass renomalisation	$\delta m_e^{\mathcal{A}}$	$\mathcal{O}(e^2)$	(60b)
	$\delta m_e^{\omega}$	$\mathcal{O}(c_{gr}^2)$	(61b)
Vertex renomalisation	$Z_{\mathcal{A}\mathcal{A}}^V$	$\mathcal{O}(e^2)$	(62a)
	$Z_{\mathcal{A}\omega}^V$	$\mathcal{O}(e c_{gr})$	(62b)
	$Z_{\omega\mathcal{A}}^V$	$\mathcal{O}(e c_{gr})$	(62b)
	$Z_{\omega\omega}^V$	$\mathcal{O}(c_{gr}^2)$	(62c)
Coupling constant renomalisation	$Y_{\mathcal{A}\mathcal{A}}$	$\mathcal{O}(e^2)$	(63a)
	$Y_{\mathcal{A}\omega}$	$\mathcal{O}(e c_{gr})$	(63b)
	$Y_{\omega\mathcal{A}}$	$\mathcal{O}(e c_{gr})$	(63c)
	$Y_{\omega\omega}$	$\mathcal{O}(c_{gr}^2)$	(63d)

respectively. An energy dependence of gravitational and electromagnetic effective couplings with the threshold effect is shown in Figure 9. For the gravitational coupling, the running effect concerning only an electron is also shown in the figure. For the QED, an electron is the lightest charged particle; thus, the coupling stays constant below  $\Lambda_{\text{QED}}$  and, above that, increases according to an increase in the energy scale. On the other hand, light neutral fermions, i.e. neutrinos, the vierbein boson and ghosts, also contribute to the gravitational  $\beta$ -function. Consequently, the effective coupling decreases from the renormalisation energy scale to the threshold of neutrino pair creation and then increases according to the energy. The number of particles contributing to the gravitational  $\beta$ -function is larger than those for the electromagnetic one; thus, the gravitational coupling runs faster than the electromagnetic one. In reality, the renormalisation group equation for the gravitational interaction with all standard model particles has the Landau pole around 10 MeV, and the perturbative QGED calculation loses its validity above this energy, even though the perturbative QED is extendable over the Planck energy. As mentioned above, it does not mean a brake down of the QGED itself. In the perturbative QGED, the Planck energy plays no significant role. Although the Landau pole is at a relatively low energy region, we still have many applications of the perturbative QGED. When we treat only one species of fermions, the Landau pole of the QGED is above the Planck energy.

## 6 Particle creation in the strong field

This section treats particle production due to the strong electromagnetic field or the strong gravitational field as an application of the perturbative QGED. The former is referred to as the Schwinger effect, and the latter is nothing other than the Hawking radiation[40].

### 6.1 Schwinger effect in the QED

The Schwinger effect, or the Sauter–Schwinger effect, is a phenomenon that the strong electric field creates a pair of charged particles[41, 42, 43], e.g., an electron-positron pair. A strong electric field separates the created pair from each other, preventing the pair annihilating back into the vacuum. The Schwinger effect is not confirmed experimentally to date. The effective action of the Schwinger effect,  $S_{\text{QED}}$ , is provided

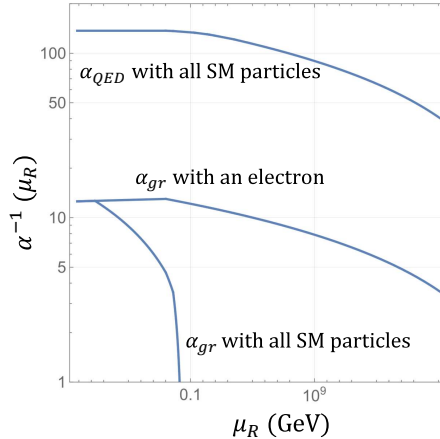

Figure 9: The figure shows effective electric and gravitational coupling constant inverse as a function of the renormalisation scale. The effective couplings owing to single fermion species and owing to all standard model particles are shown for the gravitational one.

as[42, 44]

$$S_{\text{QED}} = \frac{\mathcal{F}_e^2}{(2\pi)^3} \sum_{n=1}^{\infty} \frac{1}{n^2} \exp\left(-n\pi \frac{\tilde{m}_e^2}{\mathcal{F}_e}\right),$$

with

$$\mathcal{F}_e := \frac{eE}{\hbar} \quad \text{and} \quad \tilde{m}_e = \frac{m_e}{\hbar},$$

where  $E$  is a electric field strength and  $\mathcal{F}_e$  is an electric force on an electron. We note on the physical dimension that  $[\mathcal{F}_e]_{\text{p.d.}} = L^{-2}$  and  $[\tilde{m}_e]_{\text{p.d.}} = L^{-1}$  in our units, thus the argument of exponential has a null physical dimension, and the action shall be dimensionless after four-dimensional spatial integrate.

Consider the Schwinger effect owing to the Coulomb-type electric field. The critical electric-field strength to the electron-positron pair creation owing to the Schwinger effect is  $V_c = 1 \times 10^{18}$  V/m[43], yielding the critical radius ( $r_c$ ) and the critical energy ( $\mathcal{E}_c$ ) of the Coulomb potential as

$$V_c = \frac{1}{4\pi\epsilon_0} \frac{e}{r_c^2} \implies r_c \simeq 37.9 \text{ fm} \implies \mathcal{E}_c = \frac{\hbar}{r_c} \simeq 5.19 \text{ MeV},$$

where critical radius is larger than the proton charge radius. We note that the critical radius is smaller than the atomic scale and larger than the nucleus scale. Elementary charged particles cannot occur the Schwinger effect due to the energy-momentum conservation. However, this simple estimation suggests that the Schwinger effect may occur around a charged composite particle if the composite system can supply enough energy to create an electron-positron pair.

The infinite sum of vacuum-to-vacuum transition diagrams gives the effective action of the Schwinger effect in the QED[43]. We re-calculate the vacuum-decay rate of the Coulomb electric field at a one-loop order to compare with the Hawking radiation owing to the QGED. We write the vacuum-to-vacuum transition amplitude in the QED as

$$\langle 0_{\text{out}} | 0_{\text{in}} \rangle = e^{iS_{\text{eff}}}, \quad \text{yielding} \quad P_{\text{v.d.}} := |\langle 0_{\text{out}} | 0_{\text{in}} \rangle|^2 = e^{-2\text{Im}[S_{\text{eff}}]},$$

where  $P_{\text{v.d.}}$  is the vacuum decay probability. The effective action of the vacuum-to-vacuum transition, denoted as  $S_{\text{eff}}$ , is related to the vacuum polarization (57a)~(57c) such that[45]

$$\Pi_{ab}^{(\gamma e \gamma)}(q_i^2) \delta q_i^2 = \frac{\delta^2 S_{\text{eff}}(\mathcal{A})}{\delta \mathcal{A}^a \delta \mathcal{A}^b},$$

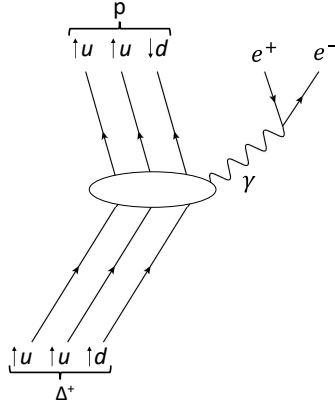

Figure 10: The figure depicts a schematic view of the  $\Delta^+ \rightarrow p e^+ e^-$  decay. A photon interacts with the hadronic current rather than the individual quarks. A spin flip can occur in any one of three valence quarks.

which has a solution

$$S_{\text{eff}}(\mathcal{A}) = \left( \mathcal{A}^\circ \Pi_{\circ\circ}^{(\gamma e\gamma)} \mathcal{A}^\circ \right) (q_i^2) \delta q_i^2, \quad (64)$$

where  $\delta q_i^2$  is the possible energy spectrum due to the Schwinger effect. We consider the Coulomb electric field that provides the electric potential in the momentum space as

$$\mathcal{A}^a = \left( \frac{1}{\tilde{q}^2}, 0, 0, 0 \right), \quad (65)$$

where  $\tilde{q} := |\vec{q}|$  is a virtual photon three-momentum. We exploit an ansatz for the virtual photon four-vector such that  $\eta_{\circ\circ} q^\circ q^\circ = q^2 = \tilde{q}^2$ , yielding

$$q^a = \left( \sqrt{2} \tilde{q}, 0, 0, \tilde{q} \right).$$

Consequently, we obtain the effective action as

$$\begin{aligned} -2 \text{Im}[S_{\text{eff}}(\mathcal{A})] &= -2 \times (4\pi) \sum_i \text{Im} \left[ \left( \mathcal{A}^\circ \Pi_{\circ\circ}^{(\gamma e\gamma)} \mathcal{A}^\circ \right) (q_i^2) \right] \delta q_i^2, \\ &\simeq -2 \times (4\pi) \int_{4m_e^2}^{E_{\text{Max}}^2} \text{Im} \left[ \left( \mathcal{A}^\circ \Pi_{\circ\circ}^{(\gamma e\gamma)} \mathcal{A}^\circ \right) (q^2) \right] dq^2, \\ &= - \int_{2m_e}^{E_{\text{Max}}} \Pi_{\gamma^* \rightarrow e^+ e^-}(\tilde{q}) d\tilde{q}, \end{aligned}$$

with

$$\Pi_{\gamma^* \rightarrow e^+ e^-}(\tilde{q}) := 4\pi\alpha \frac{\sqrt{\tilde{q}^2 - 4m_e^2} (\tilde{q}^2 + 2m_e^2)}{\tilde{q}^4}.$$

We consider the effect on the electromagnetic decay of the  $\Delta^+$  baryon in Figure 10. The critical radius is larger than proton and  $\Delta^+$  baryon charge radii; thus, the Schwinger effect may occur due to the Coulomb electric field induced by a total charge of the  $\Delta^+$  baryon rather than individual quarks. We estimate the

effective action with the  $\Delta^+ \rightarrow p e^+ e^-$  decay parameters as

$$\begin{aligned}
& -2\text{Im}[S_{\text{eff}}(\Delta^+ \rightarrow p e^+ e^-)] \\
&= \int_{2m_e}^{E_{\text{Max}}} \Pi_{\gamma^* \rightarrow e^+ e^-}(\tilde{q}) d\tilde{q}, \\
&= \frac{16\pi\alpha}{3} \left\{ \frac{\sqrt{E_{\text{Max}}^2 - 4m_e^2} (5E_{\text{Max}}^2 + 4m_e^2)}{6E_{\text{Max}}^3} + \log \left( \frac{2m_e}{E_{\text{Max}} + \sqrt{E_{\text{Max}}^2 - 4m_e^2}} \right) \right\}, \\
&\simeq 6.75 \times 10^{-1},
\end{aligned}$$

where  $E_{\text{Max}} := m_\Delta - m_p - 2m_e$ .

A Feynman diagrammatic derivation of the  $\Delta^+$  decay is as follows: The decay amplitude of the  $\Delta^+ \rightarrow p e^+ e^-$  decay is

$$\mathcal{M}(\Delta^+ \rightarrow p e^+ e^-) = J_{\Delta^+ \rightarrow p + \gamma^*}(q_{\gamma^*}^2) \frac{1}{q_{\gamma^*}^2} J_{\gamma^* \rightarrow e^+ e^-}(q_{\gamma^*}^2) dq_{\gamma^*}^2,$$

where  $J_{\Delta^+ \rightarrow p + \gamma^*}(q_{\gamma^*}^2)$  and  $J_{\gamma^* \rightarrow e^+ e^-}(q_{\gamma^*}^2)$  are hadronic and electromagnetic currents such that

$$J_{\Delta^+ \rightarrow p + \gamma^*} := e\bar{\psi}_p \Gamma_\mu \psi_\Delta \epsilon_{\gamma^*}^\mu, \quad \text{and} \quad J_{\gamma^* \rightarrow e^+ e^-} := e\bar{\psi}_e \gamma_\mu \psi_e \epsilon_{\gamma^*}^\mu,$$

respectively, where,  $\bar{\psi}_p \Gamma_\mu \psi_\Delta$  is the hadron current including an electric form-factor. They have physical dimension of  $[J]_{\text{p.d.}} = E$ . We obtain the decay width using the optical theorem and the decoupling approximation such that

$$\begin{aligned}
\Gamma(\Delta^+ \rightarrow p e^+ e^-) &= \frac{1}{2m_\Delta} \int |\mathcal{M}(\Delta^+ \rightarrow p e^+ e^-)|^2 d\Omega, \\
&\simeq \frac{1}{2m_\Delta} |J_{\Delta^+ \rightarrow p + \gamma^*} dq_{\gamma^*}^2|^2 2\text{Im}[S_{\text{eff}}(\gamma^* \rightarrow e^+ e^-)], \tag{66}
\end{aligned}$$

where  $d\Omega$  is a phase space integration of the three body decay.  $q_{\gamma^*}^{-2}$  is absorbed by  $\mathcal{A}^2$  (see (65)) in  $S_{\text{eff}}$ . For the hadronic part, we do not have any detailed information. We treat the hadronic current as a source of particle pair creation owing to the strong electric field; thus, we replace it simply with the critical energy of the Schwinger effect of the Coulomb electric field, such that:

$$|J_{\Delta^+ \rightarrow p + \gamma^*} dq_{\gamma^*}^2|^2 \simeq \mathcal{E}_c^2,$$

due to the typical energy scale of the  $e^+ e^-$  pair creation; thus, we obtain

$$(66) \simeq \frac{1}{2m_\Delta} \mathcal{E}_c^2 \text{Im}[S_{\text{eff}}(\gamma^* \rightarrow e^+ e^-)] \simeq 7.39 \times 10^{-3} \text{ MeV},$$

In reality, a partial width of this decay branch is measured as[46]

$$\Gamma^{\text{exp}}(\Delta^+ \rightarrow p e^+ e^-) = (4.91 \pm 0.82) \times 10^{-3} \text{ MeV}.$$

Consequently, we obtain a numerical value consistent with the experimental measurement. We can interpret the electromagnetic  $\Delta^+$  decay as the Schwinger effect due to the Coulomb-type electric field.

## 6.2 Hawking radiation in the QGED

The Schwinger effect is a phenomenon that a strong static electric field creates pairs of charged particles that are then separated by the same strong electric field against the attraction between them. On the other hand, when a strong gravitational field produces a pair of charged particles, both particles are attracted by the gravitational and electric fields, after which the pair annihilates back into the vacuum. Fortunately, exceptional circumstances can exist on the event horizon of a black hole. The black hole's strong gravitational field produces a pair of charged particles close enough to its event horizon that one

of the particles in the pair falls into the hole, allowing the rest to reach the asymptotic observer without annihilation. This phenomenon is known as the *Hawking radiation*. We estimate the thermodynamical temperature of the Hawking radiation from the Schwarzschild black hole utilising the same method used for the Schwinger effect.

Start from the effective action (64) for the spin-connection vacuum polarization, which is

$$S_{\text{eff}}(\omega) = \left( \tilde{\omega}^\circ \Pi_{\circ\circ}^{(\omega e \omega)} \tilde{\omega}^\circ \right) (q_i^2) \delta q_i^2,$$

where  $\Pi_{ab}^{(\omega e \omega)}(q^2)$  is given in **section 5.2.2** and  $\tilde{\omega}^a$  is a polarization vector of the spin-connection in the momentum space, which for the Schwarzschild metric in the frame fixed on a hole are given in (B.2a) and (B.2b). In this section, we set the spin-connection and the momentum vector as

$$\begin{aligned} \tilde{\omega}_a^S(\tilde{q})|_{\text{lab}} &= (\tilde{\omega}_E^S(\tilde{q})|_{\text{lab}}, \tilde{\omega}_x^S(\tilde{q})|_{\text{lab}}, 0, 0), \\ q^a &= (\sqrt{2}\tilde{q}, \tilde{q} \sin \theta \cos \phi, \tilde{q} \sin \theta \sin \phi, \tilde{q} \cos \theta), \end{aligned}$$

where the laboratory frame is defined as in **Appendix B** concerning the hole instead of the Earth. The Hawking radiation is possible only at the event horizon, thus, the momentum must be

$$\tilde{q}^S = \frac{\hbar}{R_\bullet^S} \quad \text{with} \quad R_\bullet^S = \frac{\kappa_E M_\bullet}{\hbar},$$

where  $R_\bullet^S$  is the Schwarzschild radius and  $M_\bullet$  is a hole mass. Consequently, the effective action is

$$-2 \text{Im}[S_{\text{eff}}(\omega)] = -2 \int_{-1}^1 d \cos \theta \int_0^{2\pi} d\phi \, 2\tilde{q} \text{Im} \left[ \omega^\circ \Pi_{\circ\circ}^{(\omega e \omega)} \omega^\circ \right] \Big|_{\tilde{q}=\tilde{q}^S} \delta \tilde{q},$$

with

$$\text{Im} \left[ \omega^\circ \Pi_{\circ\circ}^{(\omega e \omega)} \omega^\circ \right] = \alpha_{gr} \frac{\sqrt{q^2 - 4m_e^2} (q^2 + 2m_e^2)}{3(q^2)^{1/2}} \left( \tilde{\omega}_\circ^S(\tilde{q})|_{\text{lab}} \left( \eta_{\circ\circ} - \frac{q_\circ q_\circ}{q^2} \right) \tilde{\omega}_\circ^S(\tilde{q})|_{\text{lab}} \right).$$

After the integration with an approximation  $m_e = 0$ , we interpret the result thermodynamically as

$$- \text{Im}[S_{\text{eff}}(\omega)] = -\beta_\bullet \delta \tilde{q},$$

yielding

$$\begin{aligned} \beta_\bullet^{-1} &= c_{gr}^{-1} \frac{9\pi}{4 + 3\pi^2} T_\bullet^{\text{Hawking}}, \\ &\simeq c_{gr}^{-1} (8.41 \times 10^{-1}) T_\bullet^{\text{Hawking}} \quad \text{with} \quad T_\bullet^{\text{Hawking}} := \frac{\hbar}{\kappa_E M_\bullet}, \end{aligned}$$

where  $T_\bullet^{\text{Hawking}}$  is the Hawking temperature of the Schwarzschild black hole. As we expected, the QGED provides the hole temperature proportional to the hole mass inverse. When we set  $c_{gr} = 1$  after the coupling constant renormalisation, we obtain the correction factor  $9\pi/(4 + 3\pi^2)$  owing to the QGED.

## 7 Summary

This report proposed a renormalisable quantum theory of gravity (QGED) based on the standard method used to quantise the Yang–Mills theory. In our theory, objects quantised are spin-connection (gauge boson) and vierbein (section) fields defined in the local inertial manifold, together with the electromagnetic field (gauge boson) and electron (section) fields of the  $U(1)$  gauge theory. In classical general relativity, the solution of the Einstein equation provides the metric tensor, which determines the structure of space-time as a (pseudo-)Riemannian manifold. In the QGED, an expected value of quantised vierbein fields provides

the metric tensor, instead of a solution of the classical equation of motion. The space-time manifold itself is not a quantisation target; thus, it is a smooth manifold even after quantisation. To be brief, we quantise not the space-time but the ruler to measure it. The author has discussed a space whose metric tensor is provided as the expected value of a stochastic process in Ref.[47].

To quantise both general relativity and the Yang–Mills theory simultaneously, the current author has reformulated both theories as the geometrical theory on an equal footing in the previous study[12]. Moreover, the author has been applying the BRST quantisation non-perturbatively for pure gravity in the Heisenberg picture to them[22]. This report took them further and provided a perturbative extension of quantum gravity. Although the quantisation method utilised for general relativity in this report is faithful to the standard BRST quantisation of the Yang–Mills theory, it is not standard compared with traditional methods of quantum general relativity in some aspects; we identify a spin-connection as a gauge boson instead of the metric tensor and utilise the covariant differential including a gravitational coupling constant. The unconventional gravitational coupling constant provides several benefits to the theory:

1. We can quantise general relativity completely parallel to the Yang–Mills theory.
2. The bare gravitational coupling constant can absorb the ultraviolet divergence of a scattering vertex.
3. Free gravitational fields with vanishing coupling constant provide a linearised Einstein equation, which is also parallel to the Yang–Mills theory.

The old quantum theoretical consideration provides the evidence of the spin-connection to be the gauge boson [8], and a gravitational coupling constant is natural to be there to quantise the gauge theory[22]. Then we proved all fields are nilpotent and the Lagrangian is BRST invariant, which ensured the renormalisation with ghosts is anomaly free. Moreover, after defining the physical states of gravitation appropriately[22], it ensures the unitarity of the physical amplitude.

We extracted a set of Feynman rules based on the QGED Lagrangian with gauge fixing and ghost parts. Propagators in the momentum space for the curved space-time are not trivial because the Fourier transformation kernel includes the metric tensor. This report defined all Feynman rules in the local inertial frame in which the gravity is eliminated locally; thus, the transformation kernel has a flat metric, and the Fourier transformation is well-defined[24]. Utilising Feynman rules of the QGED prepared here, we provided all renormalisation constants and showed that the theory is perturbatively renormalisable at a one-loop level. In the renormalisation theory, we must replace infinite-valued bare objects with experimentally measured ones. We showed that the gravitational coupling constant is measurable experimentally[38].

Above all, the existence of the gravitational coupling constant allows us to discuss the running effect of gravitational coupling. The Einstein (Newtonian) gravitational constant is a fundamental constant of Nature and does not change depending on the energy scale we are looking at. On the other hand, the effective coupling may depend on the energy scale of observables through the renormalisation group equation. Since a boson loop provides an opposite sign of a fermion loop, a boson loop decreases the effective coupling according to an increased energy scale when the fermion loop is vice versa. In the QED, only charged fermions contribute to the beta function and provide an increasing effective coupling according to the increase in the energy scale. In general, the number of fermions contributing to the gravitational  $\beta$ -function is larger than those for the electromagnetic one; thus, the gravitational coupling runs faster than the electromagnetic one. Moreover,  $\alpha_{gr}$  is larger than  $\alpha$  at the energy scale  $\mu_R \simeq m_e$ ; thus, two effective couplings are never coincide at any energy scale.

The gravitational Landau pole of the QGED with one fermion species is above the Planck energy, and it, with all standard model particles, is at around 10 MeV. Although the perturbative QGED calculation loses its validity above the Landau pole, it does not mean a brake-down of the QGED itself. For the QCD, even though the perturbative QCD fails under the  $\Lambda_{QCD}$ , non-perturbative treatment works appropriately, i.e., the lattice QCD. One of the primary candidates of non-perturbative quantum theories of gravity is a loop quantum gravity (see, e.g., Refs.[48, 49]). Although the loop quantum gravity has common aspects with the lattice QCD, one of the main differences is that the former does not assume the existence of a smooth manifold as a background. In contrast, the latter takes the continuum limit of the lattice space to simulate a smooth space-time. The loop quantum gravity keeps a size parameter finite, which protects the theory from UV divergence. On the other hand, the lattice QCD provides finite results at the short-distance limit since the QCD is asymptotic free and non-perturbative QCD is well-defined at

zero distance. The lattice approximation of the QGED, if any, is different from both theories. For a lattice approximation of the QGED, we have to take a short-distance limit to obtain realistic physical quantities since the QGED theory is constructed based on the smooth manifold. However, the QGED is not an asymptotic-free theory; thus, it may have a divergence. We need yet another formulation of the non-perturbative quantum theory than utilising the discrete space-time.

This report also provided a perturbative estimation of the Hawking radiation using the QGED, with reference to the Schwinger effect of the QED. The Hawking radiation and the Schwinger effect are the particle-pair creation owing to the strong static fields; the former is due to the gravitational field, and the latter is due to the electric field. The Schwinger effect owing to the electric force has yet to be observed experimentally since the critical field strength is enormous. On the other hand, a quark pair creation owing to the strong force is an indispensable part of the hadronisation models in jet simulation programs, e.g., PYTHIA[50] and HERWIG[51]. These hadronisation models can describe a jet structure quite well; thus, the Schwinger effect owing to the QCD has experimental support. We provided a possible interpretation of the  $\Delta^+ \rightarrow pe^+e^-$  decay owing to the Schwinger effect. In contrast with the electric force, which has attractive and repulsive forces, the gravitational force is attractive only. Consequently, though a strong electric field separates a created charged particle pair, they re-combine immediately for the gravitational field case. One possible loophole in this problem is using the black hole's event horizon, i.e., Hawking radiation. The perturbative QGED shows that the hole temperature is proportional to the hole mass for the Schwarzschild black hole.

Ultimately, we emphasise that the proposed perturbative QGED is an experimentally testable theory, e.g., future high-precision measurements of a muon anomalous magnetic moment. Other applications, such as the state of arts measurements of the atomic energy spectrum, the Rydberg constant and others, are also possible testbench of the QGED. A quest for the non-perturbative approach of the QGED is also an essential direction of future study.

## Acknowledgements

I would like to thank Dr Y. Sugiyama, Prof. J. Fujimoto and Prof. T. Ueda for their continuous encouragement and fruitful discussions.

## Appendix:

### A Proof of nilpotent

This section summarizes proof of nilpotent for the gravitational BRST transformation..

#### Coordinate vector

The coordinate vectors are fundamental vectors on  $T\mathcal{M}$ , which is nilpotent as

$$\delta_B^{GR} [\delta_B^{GR} [x^\mu]] = \delta_B^{GR} [\chi^\mu] = 0.$$

#### Ghost field

Ghost  $\chi^\mu$  is trivially nilpotent. For  $\chi_b^a := \eta_{b\circ} \chi^{a\circ}$ , we obtain

$$\delta_B^{GR} [\delta_B^{GR} [\chi_b^a]] = \delta_B^{GR} [\chi_c^a \chi_b^c] = \chi_{c_2}^a \chi_{c_1}^{c_2} \chi_b^{c_1} - \chi_{c_1}^a \chi_{c_2}^{c_1} \chi_b^{c_2} = 0,$$

due to anticommutativity of the ghost field. A tensor  $\partial_\mu \chi^\nu$  is also nilpotent as

$$\delta_B^{GR} [\delta_B^{GR} [\partial_\mu \chi^\nu]] = -\delta_B^{GR} [\partial_\mu \chi^\rho \partial_\rho \chi^\nu] = -\partial_\mu \chi^{\rho_1} \partial_{\rho_1} \chi^{\rho_2} \partial_{\rho_2} \chi^\nu + \partial_\mu \chi^{\rho_1} \partial_{\rho_1} \chi^{\rho_2} \partial_{\rho_2} \chi^\nu = 0.$$

#### Vierbein form

$$\delta_B^{GR} [\delta_B^{GR} [e^a]] = -c_{gr} \delta_B^{GR} [e^b \chi_b^a] = c_{gr}^2 \left( \mathbf{e}^{b_1} \chi_{b_1}^{b_2} \chi_{b_2}^a + \mathbf{e}^{b_2} \chi_{b_1}^a \chi_{b_1}^{b_2} \right) = 0.$$

### Spin form

$$\begin{aligned}\delta_B^{GR} [\delta_B^{GR} [\mathfrak{w}^{ab}]] &= \delta_B^{GR} [d\chi^{ab} - c_{gr} (\mathfrak{w}^a \circ \chi^{ob} + \mathfrak{w}^b \circ \chi^{ao})], \\ &= c_{gr} d(\chi^a \circ \chi^{ob}) - c_{gr} \{ (d\chi^a \circ) \chi^{ob} + (d\chi^b \circ) \chi^{ao} - c_{gr} \mathfrak{w}^\circ_\star (\chi^{a\star} \chi^b_\circ + \chi^{b\star} \chi^a_\star) \}, \\ &= 0.\end{aligned}$$

### Surface form

Applying the BRST-transformation on it again, one can get

$$\begin{aligned}\delta_B^{GR} [\delta_B^{GR} [\mathfrak{S}_{ab}]] &= c_{gr} \epsilon_{abc_1c_2} \delta_B^{GR} [\chi_{c_3}^{c_1} \mathfrak{e}^{c_3} \wedge \mathfrak{e}^{c_2}], \\ &= c_{gr}^2 \epsilon_{abc_1c_2} \left\{ \chi_{c_4}^{c_1} \chi_{c_3}^{c_4} \mathfrak{e}^{c_3} \wedge \mathfrak{e}^{c_2} - \chi_{c_3}^{c_1} \chi_{c_4}^{c_3} \mathfrak{e}^{c_4} \wedge \mathfrak{e}^{c_2} - \chi_{c_3}^{c_1} \chi_{c_4}^{c_2} \mathfrak{e}^{c_3} \wedge \mathfrak{e}^{c_4} \right\}, \\ &= 0,\end{aligned}$$

because first term is the same as the second term and the third term is symmetric with  $c_1$  and  $c_2$  exchange.

### Volume form

The volume form is global scalar and their BRST transformation is expected to vanish, which can be confirmed as

$$\delta_B^{GR} [\mathfrak{v}] = \frac{1}{4!} \epsilon_{\circ\circ\circ\circ} \delta_B^{GR} [\mathfrak{e}^\circ \wedge \mathfrak{e}^\circ \wedge \mathfrak{e}^\circ \wedge \mathfrak{e}^\circ] = \frac{1}{3!} \epsilon_{a_1\circ\circ\circ} \delta_B^{GR} [\chi_{a_2}^{a_1} \mathfrak{e}^{a_2} \wedge \mathfrak{e}^\circ \wedge \mathfrak{e}^\circ \wedge \mathfrak{e}^\circ] = 0,$$

due to  $\mathfrak{e}^\circ \wedge \mathfrak{e}^\circ \wedge \mathfrak{e}^\circ \wedge \mathfrak{e}^\circ \propto \epsilon^{\circ\circ\circ\circ}$  and  $\chi_{a_2}^{a_1} = 0$  when  $a_1 = a_2$ .

### ghost forms

The BRST transformation of  $\mathfrak{c}^a$  is given by

$$\begin{aligned}\delta_B^{GR} [\mathfrak{c}^a] &= \delta_B^{GR} [\chi^a_b \mathcal{E}_\mu^b dx^\mu], \\ &= \chi^a_{b_1} \chi_{b_2}^{b_1} \mathcal{E}_\mu^{b_2} dx^\mu - \chi^a_{b_1} \mathcal{E}_\mu^{b_2} \chi_{b_1}^{b_2} dx^\mu + \chi^a_b (\partial_\mu \chi^\nu) \mathcal{E}_\nu^b dx^\mu - \chi^a_b \mathcal{E}_\mu^b dx^\mu = 0,\end{aligned}$$

### Other forms

Nilpotent of other forms are trivial and the proof is omitted here.

### Gravitational Lagrangian

The quantum Lagrangian must be the BRST-null. Gauge-fixing and Fadeef–Popov Lagrangians are constructed to satisfy the BRST-null condition in section 6-2. Nilpotent of only the gravitational Lagrangian is given here. The BRST transformation of the gravitational Lagrangian is provided as

$$\delta_B^{GR} [\mathcal{L}_G] = \frac{1}{2} \delta_B^{GR} \left[ (d\mathfrak{w}^{\circ\circ} + c_{gr} \mathfrak{w}^\circ_\star \wedge \mathfrak{w}^{\star\circ}) \wedge \mathfrak{S}_{\circ\circ} - \frac{\Lambda}{3!} \mathfrak{v} \right].$$

The BRST transformation for the volume form is vanished by itself. For the derivative term,

$$\begin{aligned}\delta_B^{GR} [d\mathfrak{w}^{\circ\circ} \wedge \mathfrak{S}_{\circ\circ}] &= \epsilon_{abc_2c_3} \chi_{c_1}^b d\mathfrak{w}^{ac_1} \wedge \mathfrak{e}^{c_2} \wedge \mathfrak{e}^{c_3} + \epsilon_{abc_2c_3} \mathfrak{w}^{ac_1} \wedge d\chi_{c_1}^b \wedge \mathfrak{e}^{c_2} \wedge \mathfrak{e}^{c_3} \\ &\quad + \epsilon_{abc_1c_2} \chi_{c_3}^{c_1} d\mathfrak{w}^{ab} \wedge \mathfrak{e}^{c_3} \wedge \mathfrak{e}^{c_2} \\ &= 2 \mathfrak{w}^{ac_1} \wedge d\chi_{c_1}^b \wedge \mathfrak{S}_{ab},\end{aligned}$$

where first- and third-terms are cancelled each other. Remnant term is transformed as

$$\begin{aligned}\delta_B^{GR} [\mathfrak{w}^\circ_\star \wedge \mathfrak{w}^{\star\circ} \wedge \mathfrak{S}_{\circ\circ}] &= \epsilon_{abc_2c_3} \chi_{c_4}^{c_2} \mathfrak{w}^{ac_1} \wedge \mathfrak{w}_{c_1}^b \wedge \mathfrak{e}^{c_4} \wedge \mathfrak{e}^{c_3} + \epsilon_{abc_3c_4} \chi_{c_1}^{c_2} \mathfrak{w}^{ac_1} \wedge \mathfrak{w}_{c_2}^b \wedge \mathfrak{e}^{c_3} \wedge \mathfrak{e}^{c_4} \\ &\quad + \epsilon_{abc_3c_4} \chi_{c_2}^b \mathfrak{w}^{ac_1} \wedge \mathfrak{w}_{c_1}^{c_2} \wedge \mathfrak{e}^{c_3} \wedge \mathfrak{e}^{c_4} - 2c_{gr}^{-1} \mathfrak{w}^{ac_1} \wedge d\chi_{c_1}^b \wedge \mathfrak{S}_{ab}, \\ &= -2c_{gr}^{-1} \mathfrak{w}^{ac_1} \wedge d\chi_{c_1}^b \wedge \mathfrak{S}_{ab}.\end{aligned}$$



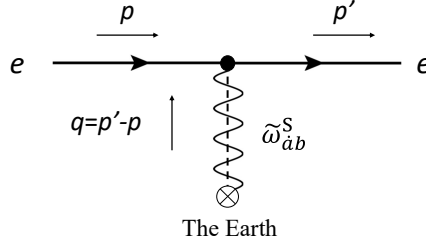

Figure 11: The figure depicts a Feynman diagram of a gravitational interaction of an electron with the Earth's gravity.

In the r.h.s of the first line, the second term is zero as itself, and first- and third-terms are cancelled each other. Therefore one can confirmed  $\delta_B^{GR}[\mathcal{L}_G] = 0$  after summing up all terms.

If we use a following remake, we can give simpler proofs for above forms.

**Remark**

If both of two fields,  $\alpha$  and  $\beta$ , are nilpotent,  $\alpha\beta$  is also nilpotent.

*Proof:*

If a field  $X$  is nilpotent, signatures of the Leibniz rule satisfy  $\epsilon_X = -\epsilon_{\delta X}$  due to  $\delta_B^{GR}[\delta_B^{GR}[X]] = 0$  and (16), where  $\epsilon_X$  ( $\epsilon_{\delta X}$ ) is a signature of  $X$  ( $\delta_B^{GR}[X]$ ), respectively. Therefore

$$\delta_B^{GR}[\delta_B^{GR}[\alpha\beta]] = \epsilon_\alpha \delta_B^{GR}[\alpha] \delta_B^{GR}[\beta] + \epsilon_{\delta\alpha} \delta_B^{GR}[\alpha] \delta_B^{GR}[\beta] = 0.$$

## B Measurement of the gravitational coupling constant

We consider an electron scattering with the Earth's gravity in Figure 11 to measure the gravitational coupling constant.

Morishima, Futamase and Shimizu[52] proposed a possible resolution to the muon  $g_\mu - 2$  anomaly owing to the static gravitational potential of the Earth using the post-Newtonian approximation. Visser[53] immediately criticised their proposal as contradicting Einstein's equivalence principle and pointed out also that they missed counting the effect of the Sun's and the Galaxy's static potential, which are much stronger than the Earth's. However, a frame fixed on the Earth is the inertial system concerning the Sun's and the Galaxy's gravity. Due to Einstein's equivalence principle, the static gravitational potential does not contribute to any local observable obtained in the inertial system. On the other hand, experimental apparatus on the Earth is not in an inertial system but in an accelerating system concerning the Earth's gravity. A finite effect on the muon anomalous coupling owing to the Earth's gravity is measurable[38].

**Schwarzschild spin-connection:** The Schwarzschild solution provides a gravitational field induced by the Earth. We first calculate a classical spin-connection of the Schwarzschild solution in the inertial space. We set the Earth at rest in the global manifold and the origin of the standard basis at the Earth's centre, as shown in Figure 12. We denote the standard basis in the global manifold as  $dx^\mu = (dt, dr, d\theta, d\phi)$  in the polar coordinate. We equate the configuration space to the inertial space and utilise the polar coordinate of  $d\xi^a = (d\tau, d\rho, d\vartheta, d\varphi)$  as the local standard basis. The local inertial manifold located at the Earth's surface at time  $t = \tau = 0$ . It has a standard basis whose spatial axes are parallel to the global ones. At first, we set the origin of the local standard basis at the Earth's centre. After the Fourier transformation, we set the origin of the momentum coordinate at the Earth's surface. (See Figure 12.) The Schwarzschild spin-connection in the global manifold is given as[9]

$$\begin{aligned} \omega_t^{S\ tr} = -\omega_t^{S\ rt} &= -\frac{R_\oplus^S}{2r^2}, & \omega_\theta^{S\ r\theta} = -\omega_\vartheta^{S\ \theta r} &= f_S(r), \\ \omega_\phi^{S\ r\phi} = -\omega_\phi^{S\ \phi r} &= f_S(\rho) \sin \theta, & \omega_\phi^{S\ \theta\phi} = -\omega_\phi^{S\ \phi\theta} &= \cos \theta, \end{aligned}$$

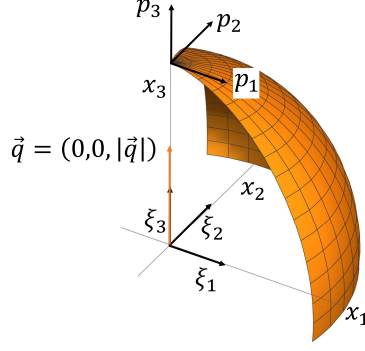

Figure 12: The standard coordinate frames in the local manifold. A sphere shows the Earth's surface.

otherwise zero, where

$$f_S(\rho) := \sqrt{1 - \frac{R_\oplus^S}{\rho}}, \quad R_\oplus^S := 2G_N M_\oplus,$$

and  $M_\oplus$  and  $R_\oplus^S$  are a mass and the Schwarzschild radius of the Earth, respectively. The spin-connection in the inertial space is provided using  $\omega_c^{S ab}(\xi) = \omega_\mu^{S ab}(x(\xi))\mathcal{E}_c^{\mu}(x(\xi))$ , such that:

$$\begin{aligned} \omega_\tau^{S \tau\rho} &= -\omega_\tau^{S \rho\tau} = -\frac{R_\oplus^S}{2f_S(\rho)\rho^2}, & \omega_\vartheta^{S \rho\vartheta} &= -\omega_\vartheta^{S \vartheta\rho} = \frac{f_S(\rho)}{\rho}, \\ \omega_\varphi^{S \rho\varphi} &= -\omega_\varphi^{S \varphi\rho} = \frac{f_S(\rho)}{\rho}, & \omega_\varphi^{S \vartheta\varphi} &= -\omega_\varphi^{S \varphi\vartheta} = \frac{\cos\vartheta}{\rho \sin\vartheta}, \end{aligned}$$

Hereafter, the superscript ‘‘S’’ on  $\omega^S$  is omitted for simplicity. After the three-dimensional spacial Fourier transformation, we obtain the Schwarzschild spin-connection in the momentum space as[24]

$$\tilde{\omega}_\tau^{\rho\tau}(\bar{q}) \simeq \frac{\pi}{2} R_\oplus^S{}^2 \left( \frac{\pi}{\bar{q}} - 2 \log \frac{\bar{q}}{2} - 2\gamma_E - 2i\pi + \mathcal{O}(\bar{q}) \right), \quad (\text{B.1a})$$

$$\tilde{\omega}_\vartheta^{\rho\vartheta}(\bar{q}) = \tilde{\omega}_\varphi^{\rho\varphi}(\bar{q}) \simeq \frac{\pi}{2} R_\oplus^S{}^2 \left( \frac{2}{\bar{q}^2} - \frac{\pi}{\bar{q}} + \log \frac{\bar{q}}{2} + \gamma_E - \frac{1}{2} - i\pi + \mathcal{O}(\bar{q}) \right), \quad (\text{B.1b})$$

and otherwise zero, where

$$\bar{q} := \frac{R_\oplus^S}{2\hbar} |\vec{q}|,$$

and  $q^a = (E, \vec{q})$  is a momentum of a spin-connection.

As shown in Figure 12, we set a local coordinate system such that the origin is at the Earth's centre, the test particle is on the  $\xi_3$ -axis, and its three-momentum  $\vec{p}$  lies in a  $\xi_1$ - $\xi_3$  plane. We refer to it as the laboratory frame. We set the  $\xi_1$ -axis to a beam momentum  $p_e$  in the laboratory frame for experiments using an electron beam<sup>1</sup>; thus, on-shell beam momenta are

$$p_{\text{lab}} = \left( E_e, p_e, 0, -\frac{q_e}{2} \right), \quad p'_{\text{lab}} = \left( E'_e, p_e, 0, \frac{q_e}{2} \right),$$

yielding  $p_{\text{lab}}^2 = p'_{\text{lab}}{}^2 = m_e^2$ ; and the spin-connection momentum is

$$q_{\text{lab}} = p'_{\text{lab}} - p_{\text{lab}} = (E'_e - E_e, 0, 0, q_e),$$

<sup>1</sup>Here, ‘‘electron’’ includes other leptons used in experiments, such as a muon.

where  $q_e$  is momentum transfer between an electron and the Earth through the spin-connection. After changing the polar coordinate to the Cartesian coordinate, we obtain the Schwarzschild spin-connection as

$$\tilde{\omega}^a(\bar{q}_{\text{lab}}) = \left( \tilde{\omega}_\tau^{\rho\tau}(\bar{q}_{\text{lab}}), \bar{q}_{\text{lab}} \tilde{\omega}_\vartheta^{\rho\vartheta}(\bar{q}_{\text{lab}}), 0, 0 \right),$$

with

$$\tilde{\omega}^0(\bar{q}_{\text{lab}}) = \frac{\pi}{2} \left( \frac{R_\oplus^{\text{S}}}{\hbar} \right)^2 \left( \frac{\pi}{\bar{q}_{\text{lab}}} - 2 \log \frac{\bar{q}_{\text{lab}}}{2} - 2\gamma_E + \mathcal{O}(\bar{q}_{\text{lab}}) \right), \quad (\text{B.2a})$$

$$\tilde{\omega}^1(\bar{q}_{\text{lab}}) = \frac{\pi}{2} \left( \frac{R_\oplus^{\text{S}}}{\hbar} \right)^2 \left( \frac{2}{\bar{q}_{\text{lab}}} + \bar{q}_{\text{lab}} \log \frac{\bar{q}_{\text{lab}}}{2} - \pi + \mathcal{O}(\bar{q}_{\text{lab}}) \right). \quad (\text{B.2b})$$

We set them to have an inverse energy-squared dimension, such as  $[\tilde{\omega}^0]_{\text{p.d.}} = [\tilde{\omega}^1]_{\text{p.d.}} = E^{-2}$ , which is the same as the spin-connection propagator. The Schwarzschild spin-connection has only an index type  $\tilde{\omega}_{\bullet}^{\rho\bullet}$  yielding a non-zero value, consistent with the observation in (23); thus, the spin-connection has a vector representation, even if it is a tensor object.

To estimate the gravitomagnetic effect quantitatively for the  $c_{gr}$  measurement, we utilise the Breit frame in which we have  $p_{\text{Br}} + p'_{\text{Br}} = (2m_e, 0, 0, 0)$  with neglecting  $\mathcal{O}(q_e/m_e)$ , such that:

$$\begin{aligned} p_{\text{Br}} &= \left( m_e - \frac{\sqrt{E_e^2 - m_e^2}}{2m_2} q_e, \frac{E_e^2 - m_e^2}{2E_e m_e} q_e, 0, -\frac{q_e}{2} \right), \\ p'_{\text{Br}} &= \left( m_e + \frac{\sqrt{E_e^2 - m_e^2}}{2m_2} q_e, -\frac{E_e^2 - m_e^2}{2E_e m_e} q_e, 0, \frac{q_e}{2} \right), \\ q_{\text{Br}} &= p'_{\text{Br}} - p_{\text{Br}}. \end{aligned}$$

We ignore effects due to the centrifugal and Coriolis forces in following calculations. In the Breit frame, the spin-connection of the Schwarzschild solution in the momentum space is

$$\tilde{\omega}^0(\bar{q}_{\text{Br}}) = \gamma_e \tilde{\omega}^0(\bar{q}_{\text{lab}}) - \gamma_e \beta_e \tilde{\omega}^1(\bar{q}_{\text{lab}}), \quad \tilde{\omega}^1(\bar{q}_{\text{Br}}) = \gamma_e \tilde{\omega}^1(\bar{q}_{\text{lab}}) - \gamma_e \beta_e \tilde{\omega}^0(\bar{q}_{\text{lab}})$$

after the Lorentz boost, where  $\beta_e = p_e/E_e$  and  $\gamma_e = E_e/m_e$ . In the following, we discuss the scattering amplitude in the Breit frame and omit the subscript ‘‘Br’’ for simplicity.

**Scattering amplitude:** We formulate the scattering amplitude by applying the Feynman rule (50b) with setting  $\varepsilon_{UV} = 0$  to Figure 11, such that:

$$i\tau_{\oplus}^{\text{S}} := \text{Figure 11} = c_{gr} \tilde{\omega}^\circ(\bar{q}) \bar{u}(p') \gamma^\circ u(p), \quad (\text{B.3a})$$

yielding

$$\begin{aligned} (\text{B.3a}) &= c_{gr} \tilde{\omega}^\circ(\bar{q}) \bar{u}(p') \left( \frac{p^\circ + p'^\circ}{2m_e} + \frac{i\sigma^{\circ\star} (p - p')^\star \eta_{\star\star}}{2m_e} \right) u(p), \\ &= c_{gr} \bar{u}(p') \left( \tilde{\omega}^0(\bar{q}) + iq^3 \frac{\tilde{\omega}^0(\bar{q})\sigma^{03} - \tilde{\omega}^1(\bar{q})\sigma^{13}}{2m_e} \right) u(p). \end{aligned} \quad (\text{B.3b})$$

using the Gordon identity. We exploit the Chiral representation for the gamma matrices and obtain a nonrelativistic Dirac spinor as

$$u(p) = \begin{pmatrix} \sqrt{\eta_{\circ\circ} p^\circ \sigma^\circ} \xi \\ \sqrt{\eta_{\circ\circ} p^\circ \bar{\sigma}^\circ} \xi \end{pmatrix},$$

where  $\xi$  is a two-component spinor,

$$\sigma^a := (I_2, \sigma^1, \sigma^2, \sigma^3), \quad \bar{\sigma}^a := (I_2, -\sigma^1, -\sigma^2, -\sigma^3),$$

and  $I_2$  is a  $(2 \times 2)$  unit-matrix. We expand  $u(p^a)$  concerning  $q_e/m_e$  up to  $\mathcal{O}(q_e^2/m_e^2)$ , since  $\tilde{\omega}^\bullet$  has a  $\mathcal{O}(q_e^{-1})$  term. Two-component spinor  $\boldsymbol{\xi}$  is normalised as  $\sum_\lambda \boldsymbol{\xi}^\lambda \cdot \boldsymbol{\xi}^{\lambda\dagger} = \mathbf{1}$  owing to (35).

Consider the physical interpretation of tensor coupling terms of the amplitude. The first term of (B.3b) up to  $\mathcal{O}(q_e^2/m_e^2)$  is

$$\tilde{\omega}^0(\bar{q}) \bar{u}(p') u(p) \simeq \tilde{\omega}^0(\bar{q}) \left( 2 + \frac{3q_e^2}{4m_e^2} \right) m_e \boldsymbol{\xi}'^\dagger \boldsymbol{\xi},$$

which does not couple to the electron spin; thus, we ignore it. The second term can be written as

$$iq_e \bar{u}(p') \frac{\tilde{\omega}^0(\bar{q}) \sigma^{03} - \tilde{\omega}^1(\bar{q}) \sigma^{13}}{2m_e} u(p) \simeq i\tilde{\omega}^x(\bar{q}) \left( 2 + \frac{q_e^2}{m_e^2} \right) \boldsymbol{\xi}'^\dagger \frac{\sigma^2}{2} \boldsymbol{\xi}, \quad (\text{B.4})$$

yielding high energy limit  $\gamma_e \rightarrow \infty$  as

$$(\text{B.4}) \simeq -\pi(4 - \pi) \left( \boldsymbol{\xi}'^\dagger \frac{\sigma^2}{2} \boldsymbol{\xi} \right) \gamma_e^2 \beta_e \frac{R_\oplus^S}{2\hbar}. \quad (\text{B.5})$$

Electron current (B.5) consists of dimensional part  $[R_\oplus^S/(2\hbar)]_{\text{p.d.}} = E^{-1}$  and a dimensionless factor. The dimensional part can be interpreted as a static gravitomagnetic field owing to the Earth as

$$B_{gr} := -\frac{R_\oplus^S}{2\hbar} = -\frac{G_N M_\oplus}{\hbar}.$$

Lorentz factor  $\gamma_e^2 \beta_e$  comes from the Lorentz boost from the laboratory frame to the Breit frame. Thus, we obtain a high energy limit of the amplitude as

$$i\tau_\oplus^S \Rightarrow -i(2m_e) c_{gr} \left[ -\frac{1}{2m_e} \boldsymbol{\xi}'^\dagger \frac{\sigma^2}{2} \boldsymbol{\xi} \right] f_{\text{h.e.l.}} B_{gr} + \mathcal{O}\left(\frac{q^2}{m_e^2}\right) \quad (\text{B.6})$$

with

$$f_{\text{h.e.l.}} := \pi(4 - \pi) \gamma_e^2 \beta_e,$$

where  $f_{\text{h.e.l.}}$  is a factor under a high energy limit, and we estimate its realistic value later, owing to the existing experiment.

**Gravitomagnetic-moment:** We define a gravitomagnetic-moment vector of an electron as

$$\vec{\mu}_{gr} := \frac{c_{gr}}{m_e} g_{gr} \vec{s} \quad \text{with} \quad \vec{s} = \boldsymbol{\xi}'^\dagger \frac{\vec{\sigma}}{2} \boldsymbol{\xi},$$

where  $\vec{s}$  is a spin angular-momentum vector and  $g_{gr}$  is a *gravitomagnetic g-factor*. We put constants  $c_{gr}$  and  $g_{gr}$  in the definition by analogy of the magnetic moment of an electron. The Hamiltonian of an electron in a gravitational field  $\vec{B}_{gr}$  is

$$V_{gr}(r) = -\vec{\mu}_{gr} \cdot \vec{B}_{gr} = -\frac{c_{gr}}{m_e} g_{gr} \vec{s} \cdot \vec{B}_{gr}. \quad (\text{B.7})$$

We note similarities between electromagnetic and gravitomagnetic interactions of an electron. An electromagnetic field is not a Lorentz vector but a component of an electromagnetic tensor. However, we can treat an electromagnetic field as a three-dimensional vector. Similarly, a gravitational field is not a vector but a tensor field in general relativity. However, we can treat it as a vector field obtained using the *gravitational vector potential* such as  $\omega^a := \omega_\circ^{\circ a}$ . In an electromagnetic field, a parallel spin electron to an electromagnetic field has a smaller potential energy than that of an anti-parallel one. Therefore, a small perturbation makes an electron spin-flip from the anti-parallel to parallel by emitting a photon with gap energy of two states. Similarly, an up-spin electron concerning the Earth's gravitational field has smaller potential energy than the down-spin one owing to the potential (B.7). Thus, a small perturbation (a small

energy transfer from the Earth) may rotate an electron spin to an upper direction in a coordinate frame fixed on the Earth's surface.

Amplitude  $\tau_{\oplus}^S$  provides the Born approximation of the scattering of an electron with the potential due to the Earth's gravity:

$$i\tau_{\text{Born}} = -i(2m_e)\boldsymbol{\xi}'^\dagger \tilde{V}(\bar{q})\boldsymbol{\xi} \xrightarrow{\text{Figure 11}} i\tau_{\oplus}^S = -i(2m_e)\boldsymbol{\xi}'^\dagger \tilde{V}_{gr}(\bar{q})\boldsymbol{\xi}.$$

By comparing (B.6) with (B.7), we obtain that

$$\tilde{V}_{gr}(0) = -\frac{c_{gr}}{m_e}g_{gr}s^y B_{gr} \quad \text{with } g_{gr} = 2,$$

in the Breit frame.

A coefficient of an angular momentum operator  $s^y = \boldsymbol{\xi}'^\dagger(\sigma^2/2)\boldsymbol{\xi}$  gives a rotation angle of an electron spin; thus, the amplitude (B.6) generates a counter-clockwise spin rotation around a  $y$ -axis such that an initial horizontal (along a  $x$ -axis) spin vector to a  $z$ -axis (upward). The gravitational force  $B_{gr}$  induce an orbital motion with the orbital angular frequency  $\omega_O^2 = |B_{gr}|$ . On the other hand, an angular frequency of a spin rotation  $\omega_S$  is provided using a relation between a rotation energy of an angular momentum and an angular frequency, such that:

$$\frac{1}{2}|\vec{\mu}_{gr}|\omega_S^2 = c_{gr}g_{gr}|B_{gr}| \rightarrow \omega_S = \pm\omega_O.$$

In a clockwise orbital motion of an electron, it provides a  $2\pi$  counter-clockwise spin rotation to a spin in the inertial system during one cycle. On the other hand, the electron spin point in the same direction during orbital motion in the global system, which is fixed on the Earth. The spin rotation in the inertial system is spurious due to the observation of the rotational coordinate system. The first-order approximation under the weak gravitational field provides  $g_{gr} = 2$  to induce no spin precession. This first-order result is consistent with a classical spin precession of a gyroscope in the weak Schwarzschild gravitational field owing to the Earth[54]. It is known that the higher order correction induces a geodesic precession[54].

For the finite momentum transfer case with  $\bar{q} \neq 0$ , the second term in (B.3b) proportional to  $\boldsymbol{\xi}'^\dagger(\sigma^2/2)\boldsymbol{\xi}$  provides a gravitomagnetic interaction of the Earth's gravity to an electron spin, which gives a gravitomagnetic moment slightly differ from  $g_{gr} = 2$  owing to the gravitomagnetic effect. More precisely, this term generates a counterclockwise spin rotation around a  $y$ -axis such that an initial horizontal (along a  $x$ -axis) spin vector to a negative  $z$ -axis (upward). We define the anomalous gravitomagnetic moment as

$$a_{gr} := \frac{g_{gr} - 2}{2} = \frac{1}{2}(g_{gr}(\bar{q}) - g_{gr}(0)), \quad \text{with } g_{gr}(\bar{q}) := -\left(\frac{c_{gr}}{m_e}s^y B_{gr}\right)^{-1} \tilde{V}_{gr}(\bar{q}). \quad (\text{B.8})$$

The anomalous magnetic-moment measurements may include an effect of the above contribution.

**Experimental measurements:** In the electron anomalous magnetic-moment measurements[55, 56], an electron has a small Lorentz factor  $\gamma_e$  and  $\gamma_e\beta_e$ . Moreover, these experiments utilise free-falling electrons with  $\bar{q} \simeq 0$ . Thus, the spin precession owing to the gravitomagnetic effect is negligible compared with the magnetic one.

On the other hand, the BNL-FNAL type  $g_\mu - 2$  measurement used the *magic momentum*[57, 36] of  $p = 4.094\text{GeV}$  corresponding to Lorentz factors  $\gamma = 29.4$  and  $\beta = 0.999421$  to eliminate the spin precession due to the focusing electric field; thus, we can expect a sizable precession owing to the gravitomagnetic moment with the Earth's gravity. The electrostatic quadrupole (ESQ) covers 13/30 of the muon storage ring[58]. Muons in the storage ring are kept horizontally due to the electric field of ESQ on average. Therefore, we estimate each muon receives a momentum transfer of  $\bar{q}_{\oplus} \simeq G_N M_{\oplus}/r_{\oplus} \simeq 6.95 \times 10^{-10}$  on average, which induces the spin precession owing to (B.8), such that:

$$a_{gr}/c_{gr} = 257\,858 \times 10^{-11}.$$

On the other hand, the muon anomalous magnetic moment is estimated theoretically[59] as

$$a_{SM} := \frac{g_{SM} - 2}{2} = 116\,591\,810 \times 10^{-11}.$$

A total precession effect is estimated as

$$a_T^2 := a_{SM}^2 + (c_{gr} a_{gr})^2 + 2c_{gr} a_{SM} a_{gr} \cos \theta_a,$$

where  $\theta_a$  is a angle between two precession axes. The precession owing to the anomalous gravitomagnetic moment is around the  $y$ -axis and that owing to the anomalous magnetic moment is around the  $z$ -axis in the lab-frame. Consequently,  $\theta_a = \pi/2$  and the gravitomagnetic contribution to the anomalous magnetic moment is

$$\delta a_{gr} := (a_T - a_{SM})|_{c_{gr}=1} = 2.8 \times 10^{-9}.$$

The measured muon anomalous magnetic moment is reported[36] as

$$a_{Exp} = 116\,592\,061 \times 10^{-11},$$

yielding

$$\delta a := a_{Exp} - a_{SM} = (2.51 \pm 0.41 \pm 0.43) \times 10^{-9},$$

which suggests the gravitational coupling constant is consistent with unity.

## References

- [1] Rovelli, C.: Notes for a brief history of quantum gravity. In: Recent Developments in Theoretical and Experimental General Relativity, Gravitation and Relativistic Field Theories. Proceedings, 9th Marcel Grossmann Meeting, MG'9, Rome, Italy, July 2-8, 2000. Pts. A-C, pp. 742–768 (2000). gr-qc/0006061
- [2] Carlip, S., Chiou, D.-W., Ni, W.-T., Woodard, R.: Quantum gravity: A brief history of ideas and some prospects. *International Journal of Modern Physics D* **24**(11), 1530028 (2015). doi:10.1142/S0218271815300281
- [3] Berends, F.A., Gastmans, R.: On the high-energy behaviour of Born cross sections in quantum gravity. *Nuclear Physics B* **88**(1), 99–108 (1975). doi:10.1016/0550-3213(75)90528-3
- [4] Goroff, M.H., Sagnotti, A.: Quantum gravity at two loops. *Physics Letters B* **160**, 81–86 (1985). doi:10.1016/0370-2693(85)91470-4
- [5] Goroff, M.H., Sagnotti, A.: The ultraviolet behavior of Einstein gravity. *Nuclear Physics B* **266**(3), 709–736 (1986). doi:10.1016/0550-3213(86)90193-8
- [6] Utiyama, R.: Invariant theoretical interpretation of interaction. *Phys. Rev.* **101**, 1597–1607 (1956). doi:10.1103/PhysRev.101.1597
- [7] Blagojević, M., Hehl, F.W.: *Gauge Theories of Gravitation: A Reader with Commentaries. Classification of Gauge Theories of Gravity.* Imperial College Press, London, UK (2013)
- [8] Kurihara, Y.: Symplectic structure for general relativity and Einstein–Brillouin–Keller quantization. *Classical and Quantum Gravity* **37**(23), 235003 (2020). doi:10.1088/1361-6382/abbc44
- [9] Frè, P.G.: *Gravity, a Geometrical Course vol. 1: Development of the Theory and Basic Physical Applications.* Springer, Dordrecht, UK (2013). doi:10.1007/978-94-007-5361-7

- [10] Nakanishi, N., Ojima, I.: Covariant Operator Formalism of Gauge Theories and Quantum Gravity. Lecture Notes in Physics Series. World Scientific Publishing Co. Pte. Ltd., Singapore (1990). See also references there in.
- [11] Nakanishi, N.: Quantum gravity and general relativity. *Soryusiron Kenkyu* **1**, 1–8 (2009). *In Japanese*.
- [12] Kurihara, Y.: Topological indices of general relativity and Yang-Mills theory in four-dimensional space-time (2022). doi:10.48550/arXiv.2205.06953
- [13] Moore, J.D.: Lectures on Seiberg-Witten Invariants. Lecture notes in mathematics Berlin: Mathematical biosciences subseries, vol. 1629. Springer, Berlin, Germany (1996). doi:10.1007/BFb0092948
- [14] Nakajima, S.: Application of covariant analytic mechanics with differential forms to gravity with Dirac field. *Electron. J. Theor. Phys.* **13**, 95 (2016). 1510.09048
- [15] Becchi, C., Rouet, A., Stora, R.: Renormalization of the Abelian Higgs-Kibble Model. *Commun. Math. Phys.* **42**, 127–162 (1975). doi:10.1007/BF01614158
- [16] Tyutin, I.V.: Gauge Invariance in Field Theory and Statistical Physics in Operator Formalism (1975). arXiv:0812.0580[hep-th]
- [17] Nakanishi, N.: Covariant Quantization of the Electromagnetic Field in the Landau Gauge. *Progress of Theoretical Physics* **35**(6), 1111–1116 (1966). doi:10.1143/PTP.35.1111
- [18] Kugo, T., Ojima, I.: Local covariant operator formalism of non-abelian gauge theories and quark confinement problem. *Progress of Theoretical Physics Supplement* **66**, 1–130 (1979)
- [19] Kugo, T., Ojima, I.: Manifestly covariant canonical formulation of yang-mills theories physical state subsidiary conditions and physical s-matrix unitarity. *Physics Letters B* **73**(4), 459–462 (1978)
- [20] Peskin, M.E., Schroeder, D.V.: An Introduction To Quantum Field Theory. *Frontiers in Physics*. Avalon Publishing, New York, US (1995)
- [21] Weinberg, S.: The Quantum Theory of Fields: Volume 2, Modern Applications. Cambridge University Press, Cambridge, UK (1996)
- [22] Kurihara, Y.: Nakanishi–Kugo–Ojima quantization of general relativity in Heisenberg picture. *Eur. Phys. J. Plus* **136**(4), 462 (2021). doi:10.1140/epjp/s13360-021-01463f-3
- [23] Nakanishi, N.: A New Way of Describing the Lie Algebras Encountered in Quantum Field Theory. *Progress of Theoretical Physics* **60**(1), 284–294 (1978). doi:10.1143/PTP.60.284
- [24] Kurihara, Y.: Green’s function in general relativity (2022). doi:10.21203/rs.3.rs-2339141/v1. *Research Square*
- [25] Aoki, K.-i., Hioki, Z., Kawabe, R., Konuma, M., Muta, T.: Electroweak Theory: Framework of On-Shell Renormalization and Study of Higher-Order Effects. *Progress of Theoretical Physics Supplement* **73**, 1–226 (1982). doi:10.1143/PTPS.73.1
- [26] Kaku, M.: Quantum Field Theory: A Modern Introduction. Oxford University Press, Now York, USA (1993)
- [27] Fujimoto, J., Igarashi, M., Nakazawa, N., Shimizu, Y., Tobimatsu, K.: Radiative Corrections to  $e^+e^-$  Reactions in Electroweak Theory. *Progress of Theoretical Physics Supplement* **100**, 1–379 (1990). doi:10.1143/PTPS.100.1. <https://academic.oup.com/ptps/article-pdf/doi/10.1143/PTPS.100.1/5232235/100-1.pdf>
- [28] Bélanger, G. and Boudjema, F. and Fujimoto, J. and Ishikawa, T. and Kaneko, T. and Kato, K. and Shimizu, Y.: Automatic calculations in high energy physics and grace at one-loop. *Physics Reports* **430**(3), 117–209 (2006). doi:10.1016/j.physrep.2006.02.001

- [29] Ward, J.C.: An identity in quantum electrodynamics. *Phys. Rev.* **78**, 182–182 (1950). doi:10.1103/PhysRev.78.182
- [30] Takahashi, Y.: On the generalized Ward identity. II *Nuovo Cimento* **6**(2), 371–375 (1957). doi:10.1007/BF02832514
- [31] Schwob, C., Jozefowski, L., de Beauvoir, B., Hilico, L., Nez, F., Julien, L., Biraben, F., Acep, O., Zondy, J.-J., Clairon, A.: Optical Frequency Measurement of the  $2S - 12D$  Transitions in Hydrogen and Deuterium: Rydberg Constant and Lamb Shift Determinations. *Phys. Rev. Lett.* **82**, 4960–4963 (1999). doi:10.1103/PhysRevLett.82.4960
- [32] Sturm, S., Köhler, F., Zatorski, J., Wagner, A., Harman, Z., Werth, G., Quint, W., Keitel, C.H., Blaum, K.: High-precision measurement of the atomic mass of the electron. *Nature* **506**(7489), 467–470 (2014). doi:10.1038/nature13026
- [33] Malo, de Mirandes, E., Cladé, P., Guellati-Khélifa, S., Schwob, C., Nez, F., Julien, L., Biraben, F.: Combination of Bloch Oscillations with a Ramsey-Bordé Interferometer: New Determination of the Fine Structure Constant. *Physical Review Letters* **101**(23) (2008). doi:10.1103/physrevlett.101.230801
- [34] de Felice, F., Bini, D.: *Classical Measurements in Curved Space-Times*. Cambridge Monographs on Mathematical Physics. Cambridge University Press, Cambridge, UK (2010)
- [35] Pfister, H., King, M.: *Inertia and Gravitation: The Fundamental Nature and Structure of Space-Time*. Lecture Notes in Physics. Springer, March, Germany (2015)
- [36] Abi, B., *et al.*: Measurement of the Positive Muon Anomalous Magnetic Moment to 0.46 ppm. *Phys. Rev. Lett.* **126**(14), 141801 (2021). doi:10.1103/PhysRevLett.126.141801
- [37] Abe, M., *et al.*: A new approach for measuring the muon anomalous magnetic moment and electric dipole moment. *PTEP* **2019**(5), 053–02 (2019). doi:10.1093/ptep/ptz030
- [38] Kurihara, Y.: Gravitational Effect on Fundamental Physical Observables (2022). doi:10.21203/rs.3.rs-2403616/v1. Research Square
- [39] Ellis, R.K., Stirling, W.J., Webber, B.R.: *QCD and Collider Physics*. Cambridge Monographs on Particle Physics, Nuclear Physics and Cosmology. Cambridge University Press, Cambridge, UK (2003)
- [40] Hawking, S.W.: Black hole explosions? *Nature* **248**(5443), 30–31 (1974). doi:10.1038/248030a0
- [41] Sauter, F.: Über das Verhalten eines Elektrons im homogenen elektrischen Feld nach der relativistischen Theorie Diracs. *Z. Phys.* **69**, 742–764 (1931). doi:10.1007/BF01339461
- [42] Heisenberg, W., Euler, H.: Consequences of Dirac’s theory of positrons. *Z. Phys.* **98**(11-12), 714–732 (1936). doi:10.1007/BF01343663. physics/0605038
- [43] Schwinger, J.: On gauge invariance and vacuum polarization. *Phys. Rev.* **82**, 664–679 (1951). doi:10.1103/PhysRev.82.664
- [44] Medina, L., Ogilvie, M.C.: Schwinger Pair Production at Finite Temperature. *Phys. Rev. D* **95**(5), 056006 (2017). doi:10.1103/PhysRevD.95.056006. 1511.09459
- [45] Dunne, G.V.: New Strong-Field QED Effects at ELI: Nonperturbative Vacuum Pair Production. *Eur. Phys. J. D* **55**, 327–340 (2009). doi:10.1140/epjd/e2009-00022-0. 0812.3163
- [46] Workman, R.L., *et al.*: Review of Particle Physics. *PTEP* **2022**(8), 083–01 (2022). doi:10.1093/ptep/ptac097
- [47] Kurihara, Y.: Stochastic metric space and quantum mechanics. *Journal of Physics Communications* **2**(3), 035025 (2018). doi:10.1088/2399-6528/aaa851



- [48] Rovelli, C., Vidotto, F.: Covariant Loop Quantum Gravity: An Elementary Introduction to Quantum Gravity and Spinfoam Theory. Cambridge University Press, Cambridge, UK (2014). doi:10.1017/CBO9781107706910
- [49] Ashtekar, A., Bianchi, E.: A short review of loop quantum gravity. Rept. Prog. Phys. **84**(4), 042001 (2021). doi:10.1088/1361-6633/abed91. 2104.04394
- [50] Sjöstrand, T. and Ask, S. and Christiansen, J. R. and Corke, R. and Desai, N. and Ilten, P. and Mrenna, S. and Prestel, S. and Rasmussen, C. O. and Skands, P. Z.: An introduction to PYTHIA 8.2. Comput. Phys. Commun. **191**, 159–177 (2015). doi:10.1016/j.cpc.2015.01.024. 1410.3012
- [51] Bahr, M., *et al.*: Herwig++ Physics and Manual. Eur. Phys. J. C **58**, 639–707 (2008). doi:10.1140/epjc/s10052-008-0798-9. 0803.0883
- [52] Morishima, T., Futamase, T., Shimizu, H.M.: The general relativistic effects on the magnetic moment in earth's gravity. PTEP **2018**(6), 603–07 (2018). doi:10.1093/ptep/pty066
- [53] Visser, M.: Post-Newtonian particle physics in curved spacetime (2018). 1802.00651
- [54] Hoyle, P.: Relativistic Astrophysics and Cosmology: A Primer. Astronomy and Astrophysics Library. Springer, Dordrecht, Netherlands (2007)
- [55] Hanneke, D., Fogwell, S., Gabrielse, G.: New measurement of the electron magnetic moment and the fine structure constant. Phys. Rev. Lett. **100**, 120801 (2008). doi:10.1103/PhysRevLett.100.120801
- [56] Fan, X., Myers, T.G., Sukra, B.A.D., Gabrielse, G.: Measurement of the Electron Magnetic Moment (2022). 2209.13084
- [57] Bennett, G.W., *et al.*: Final Report of the Muon E821 Anomalous Magnetic Moment Measurement at BNL. Phys. Rev. D **73**, 072003 (2006). doi:10.1103/PhysRevD.73.072003
- [58] Grange, J., *et al.*: Muon (g-2) Technical Design Report (2015). 1501.06858
- [59] Aoyama, T., *et al.*: The anomalous magnetic moment of the muon in the Standard Model. Phys. Rept. **887**, 1–166 (2020). doi:10.1016/j.physrep.2020.07.006. 2006.04822