

# Simple and high-precision Hamiltonian simulation by compensating Trotter error with linear combination of unitary operations

Pei Zeng,<sup>1,\*</sup> Jinzhao Sun,<sup>2,3,†</sup> Liang Jiang,<sup>1,‡</sup> and Qi Zhao<sup>4,§</sup>

<sup>1</sup>*Pritzker School of Molecular Engineering, The University of Chicago, Illinois 60637, USA*

<sup>2</sup>*QOLS, Blackett Laboratory, Imperial College London, London SW7 2AZ, United Kingdom*

<sup>3</sup>*Quantum Advantage Research, Beijing 100080, China*

<sup>4</sup>*QICI Quantum Information and Computation Initiative, Department of Computer Science, The University of Hong Kong, Pokfulam Road, Hong Kong*

(Dated: December 12, 2022)

Trotter and linear-combination-of-unitary (LCU) are two popular Hamiltonian simulation methods. We propose Hamiltonian simulation algorithms using LCU to compensate Trotter error, which enjoy both of their advantages. By adding few gates after the  $K$ th-order Trotter, we realize a better time scaling than  $2K$ th-order Trotter. Our first algorithm exponentially improves the accuracy scaling of the  $K$ th-order Trotter formula. In the second algorithm, we consider the detailed structure of Hamiltonians and construct LCU for Trotter errors with commutator scaling. Consequently, for lattice Hamiltonians, the algorithm enjoys almost linear system-size dependence and quadratically improves the accuracy of the  $K$ th-order Trotter.

**Introduction.** Hamiltonian simulation, i.e., to simulate the real-time evolution  $U(t) = e^{-iHt}$  of a physical Hamiltonian  $H = \sum_l H_l$ , is considered to be a natural and powerful application of quantum computing [1]. It can also be used as an important subroutine in many other quantum algorithms like ground-state preparation [2, 3], optimization problems [4, 5], quantum linear solvers [6]. To pursue real-world applications of Hamiltonian simulation with near-term quantum devices, we need to design feasible algorithms with small space complexity (i.e., qubit number) and time complexity (i.e., circuit depth and gate number).

One of the most natural Hamiltonian simulation methods is based on Trotter formulas [7–14], which approximate the real-time evolution of  $H = \sum_{l=1}^L H_l$  by the product of the simple evolution of its summands  $e^{-iH_l t}$ . Besides its prominent advantage of simple realization without ancillas, Trotter methods are recently rigorously shown to enjoy commutator scaling [13, 14], i.e., the Trotter error is only related to the nested commutators of the Hamiltonian summands  $\{H_l\}$ . This is very helpful for the Hamiltonians with strong locality constraints. Hereafter, we refer to the error analysis utilizing the detailed structure of Hamiltonians as commutator scaling analysis. For example, when we consider  $n$ -qubit lattice Hamiltonians, the gate cost of high-order Trotter methods is almost linear to the system size  $n$ , which is nearly optimal [13]. The major drawback of the Trotter methods is its polynomial gate cost to the inversed accuracy  $1/\varepsilon$ ,  $\text{Poly}(1/\varepsilon)$ . In many applications where high-precision simulation is demanded to obtain practical advantages over the existing classical algorithms [15], the gate cost of Trotter methods is large.

In recent years, we have seen the developments of “post-Trotter” algorithms with exponentially improved accuracy dependence [16–19]. Due to the smart choice of the expansion formulas (i.e., Taylor series [17] or Jacobi-Anger expansion [19]), these post-Trotter methods are able to catch the dominant terms in the time evolution operator  $U(t)$  with polynomially increasing gate resources, leading to a logarithmic gate-number dependence on the accuracy requirement  $1/\varepsilon$ . Unlike Trotter methods, these advanced algorithms are not able to utilize the specific structure of Hamiltonians due to the lack of commutator-based error form. Consequently, for instance, for  $n$ -qubit lattice Hamiltonians, their gate complexities are  $\mathcal{O}(n^2)$ , which is worse than those in Trotter algorithms  $\mathcal{O}(n^{1+o(1)})$ . Furthermore, these post-Trotter algorithms require the implementation of linear-combination-of-unitary (LCU) formulas [20] or block encoding of Hamiltonians [18] which often costs many ancillary qubits and multi-controlled Toffoli gates. This is still experimentally challenging in a near-term or early fault-tolerant quantum computer [21]. To reduce the hardware requirement of compiling the LCU formulas, recent studies focus on a random-sampling implementation of a LCU formula [20, 22–24], where the elementary unitaries are sampled to realize the LCU formula statistically. Similar ideas have also been studied in the ground-state algorithms [25–27].

Here, we develop the theory of composite algorithms that combine the inherent advantages of Trotter and LCU methods — easy implementation, high precision, and commutator scaling — by performing the Trotter method and then compensating the Trotter error with the LCU methods. We provide versatile realizations of this composite algorithm based on either random-sampling [22–24] or coherent implementation [16, 17] of LCU formulas. Based on the methods to construct the LCU formulas, we propose two types of composite algorithms with unique advantages in different scenarios. Our first algorithm is generic for the  $L$ -sparse Hamil-

\* peizeng@uchicago.edu

† jinzhaosun@imperial.ac.uk

‡ liangjiang@uchicago.edu

§ zhaoqi@cs.hku.hk

tonian  $H = \sum_{l=1}^L H_l$  with  $\lambda = \sum_l \|H_l\|$ . With the random-sampling implementation, we prove that by appending few gates after the  $K$ th-order Trotter formula with only one ancillary qubit, one can achieve a gate cost of  $\mathcal{O}((\lambda t)^{1+1/(2K+1)}(L + \log(1/\varepsilon)))$ , which improves the time scaling from  $1 + 1/K$  to  $1 + 1/(2K + 1)$  and exponentially improves the accuracy scaling of the  $K$ th-order Trotter formula compared to the  $K$ th-order Trotter. In the second algorithm, we consider the locality structure of Hamiltonians and take advantage of the nest-commutator forms of Trotter errors [13, 14] in the LCU formula construction. As a result, our algorithm enjoys almost linear system-size dependence, and achieves a better time and accuracy dependence than  $2K$ th-order Trotter only with  $K$ th-order Trotter's gate complexity.

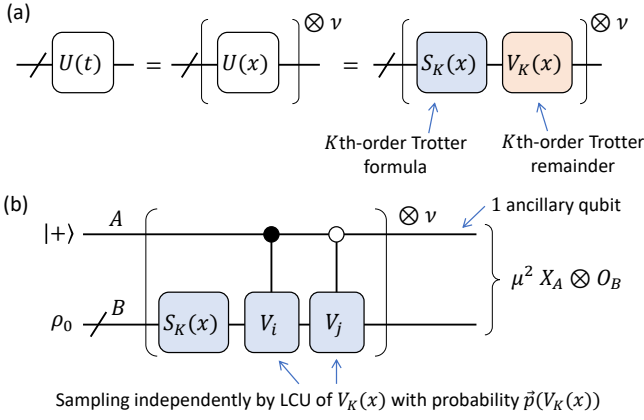

FIG. 1. (a) In the  $K$ th-order Trotter-LCU algorithm, we first implement  $K$ th-order Trotter formula, then compensate the remainder using LCU methods. (b) Random-sampling implementation of the LCU formula. We sample the elementary unitaries  $V_i$  and  $V_j$  independently based on the LCU formula of  $V_K(x)$  in Eq. (1) and implement the controlled  $V_i$  and  $V_j$  gate. Then the Trotter remainder  $V_K(x)$  can be compensated in a Hadamard-test type circuit.

**Trotter-LCU algorithms.** The algorithm is based on a series connection of Trotter and LCU algorithms, shown in Fig. 1. We call the composite algorithm with the  $K$ th-order Trotter and LCU formula the  $K$ th-order Trotter-LCU method. For consistency, we call the algorithm with no Trotter formula the 0th-order Trotter-LCU method. In our algorithms, we decompose the time evolution  $U(t) = e^{-iHt}$  to  $\nu$  segments, each with a small evolution time  $x = t/\nu$ . In each segment, we first perform the  $K$ th-order Trotter formula  $S_K(x)$  ( $K = 0, 1, 2k$ ,  $k \in \mathbb{N}_+$ ). For consistency, we denote the 0th-order Trotter formula as  $S_0(x) = I$ . Then, we compensate the multiplicative Trotter remainder  $V_K(x) := U(x)S_K(x)^\dagger$  by implementing the LCU formula of  $V_K(x)$ . A  $(\mu, \varepsilon)$ -LCU formula of an operator  $V$  is defined by a set of unitaries  $\{V_i\}$  and related probability distribution  $\tilde{p}(V) = \{p_i\}_i$

with

$$\tilde{V} = \mu \sum_{i=0}^{\Gamma-1} p_i V_i, \quad (1)$$

such that the spectral norm distance  $\|V - \tilde{V}\| \leq \varepsilon$ . We denote  $\mu := \|\tilde{V}\|_1$  as the 1-norm of this LCU formula.

We consider two ways to implement the LCU formula. In the random-sampling implementation [22–24], we sample the elementary unitaries  $\{V_i\}$  based on the corresponding probability  $\{p_i\}$  and embed the realization of the LCU formula into a Hadamard test [28]. In the coherent implementation [16, 17], we introduce  $m = \lceil \log_2 \Gamma \rceil$  ancillary qubits to realize the superposition of different  $\{V_i\}$ . Our major focus is on the random-sampling implementation shown in Fig. 1(b), where we can estimate the properties of the target state  $\rho = U(t)\rho_0 U(t)^\dagger$  with only one ancillary qubit. Given a  $(\mu, \varepsilon)$ -LCU formula in Eq. (1), we can estimate an arbitrary observable value  $O$  on  $\rho$  based on the formula,

$$\text{Tr}(O\rho) \approx \mu^2 \sum_{i,j} p_i p_j \text{Tr}(O V_i \rho_0 V_j^\dagger). \quad (2)$$

While the estimation of  $\text{Tr}(O V_i \rho_0 V_j^\dagger)$  can be implemented using Hadamard-test type circuits [28], we only need to sample  $V_i$  and  $V_j$  based on the LCU formula in Eq. (1) to estimate  $\text{Tr}(O\rho)$  with  $\varepsilon$  accuracy using  $\mathcal{O}(\mu^4/\varepsilon^2)$  sampling resource, which owns an extra  $\mu^4$  overhead compared to the normal Hamiltonian simulation algorithms [24]. To make the algorithm efficient, we need to set  $\mu$  to be a constant.

To construct the LCU formulas, we can directly apply the Taylor-series expansion [17] on  $V_K(x)$ . We start our discussion from 0th-order case, where no Trotter formula is performed. The 0th-order remainder  $V_0(x) := U(x)$  can be expanded as

$$\begin{aligned} V_0(x) &= e^{-ixH} = \sum_{s=0}^{\infty} F_{0,s}(x) = \sum_{s=0}^{\infty} \frac{(-ix)^s}{s!} H^s, \\ &= e^{\lambda x} \sum_{s=0}^{\infty} \text{Poi}(s; \lambda x) \sum_{l_1, \dots, l_s} p_{l_1} \dots p_{l_s} P_{l_1} \dots P_{l_s}. \end{aligned} \quad (3)$$

Here,  $\text{Poi}(s; a) := e^{-a} a^s / s!$  is the Poisson distribution.  $F_{0,s}(x)$  denotes the  $s$ -order expansion term. Eq. (3) is a LCU formula of  $V_0(x)$  with 1-norm  $\mu_x = e^{\lambda x}$ . The 1-norm of the overall evolution  $U(t) = U(x)^\nu$  is then  $\mu = e^{\lambda t}$ , which, unfortunately, grows exponentially with respect to  $t$ .

To reduce the 1-norm  $\mu_x$  in each segment, we consider introducing the Trotter formula. For example, if we apply 1st-order Trotter formula  $S_1(x) = \prod_{l=1}^L e^{-ixH_l}$  in each segment, the 1st-order remainder  $V_1(x) := U(x)S_1(x)^\dagger$

can be expanded as

$$\begin{aligned} V_1(x) &= e^{-ixH} \prod_{l=L}^1 e^{ixH_l} = \sum_{s=0}^{\infty} F_{1,s}(x) \\ &= \sum_{r;r_1,r_2,\dots,r_L} \frac{(-ix)^r}{r!} H^r \prod_{l=L}^1 \frac{(ix)^{r_l}}{r_l!} H^{r_l}, \end{aligned} \quad (4)$$

where  $\{r_1, \dots, r_L\}$  denotes  $L$  expansion variables related to the Trotter formula and  $s := r + \sum_{l=1}^L r_l$ .  $F_{1,s}$  denotes the  $s$ -order expansion term of  $V_1(x)$ . The 1-norm of  $V_1(x)$  in Eq. (4) is  $e^{2\lambda x}$ , which seems to be even larger than the 0th-order case. However, since  $V_1(x)$  denotes the (multiplicative) Trotter error, we have  $F_{1,1}(x) = 0$ . Using this condition, we can rewrite  $F_{1,1}$  as

$$V_1(x) = I + \sum_{s=2}^{\infty} F_{1,s}(x). \quad (5)$$

From the Taylor-series expansion, we can bound the 1-norm of the new LCU formula in Eq. (5) by  $\mu_x = e^{2\lambda x} - (2\lambda x) \leq e^{(2\lambda x)^2}$ . In this way, we reduce  $\mu_x$  from  $1 + \mathcal{O}(\lambda x)$  to  $1 + \mathcal{O}((\lambda x)^2)$ . The 1-norm of the overall time evolution becomes  $\mu = \mu_x^\nu \leq \exp((2\lambda t)^2/\nu)$ . If we choose the segment number  $\nu = \mathcal{O}((\lambda t)^2)$ ,  $\mu$  will be a constant.

We can further reduce the 1-norm  $\mu_x$  of  $V_1(x)$  by taking advantage of the structure of Trotter errors. In Appendix G, we show how to expand the 2nd- and 3rd-order terms of  $V_1(x)$  as a summation of nested commutators,

$$\begin{aligned} F_{1,s}(x) &= \frac{x^s}{s!} C_{s-1} = \frac{(-ix)^s}{s!} \left( \mathcal{A}_{com}^{(s-1)}(H_L, \dots, H_1; H) \right. \\ &\quad \left. - \sum_{l=1}^L \mathcal{A}_{com}^{(s-1)}(H_L, \dots, H_{l+1}; H_l) \right), \quad s = 2, 3, \end{aligned} \quad (6)$$

where  $\mathcal{A}_{com}^{(s)}(A_L, \dots, A_1; B)$  is defined to be

$$\sum_{m_1+\dots+m_L=s} \binom{s}{m_1, \dots, m_L} \text{ad}_{A_L}^{m_L} \dots \text{ad}_{A_1}^{m_1} B. \quad (7)$$

We also use the adjoint notation  $\text{ad}_{A_L} \dots \text{ad}_{A_1} B := [A_L, \dots [A_1, B] \dots]$ .

It is easy to check that  $F_{1,s}(x)$  ( $s = 2$  or  $3$ ) in Eq. (6) is anti-Hermitian which can be written as,

$$F_{1,s}(x) = \frac{i \|C_{s-1}\|_1}{s!} x^s \sum_{\gamma} \text{Pr}(\gamma) P_{\gamma}, \quad (8)$$

where  $\{P_{\gamma}\}$  are Pauli operators with real coefficient  $\pm 1$ . As a result, we can further suppress  $\mu_x$  by pairing the terms in  $F_{1,s}(x)$  with  $F_{1,0} = I$  using Euler's formula  $I + iyP = \sqrt{1 + y^2} e^{i\theta P}$  with  $\theta = \tan^{-1}(y)$ . When  $y = x^s$ , the paired formula as a summation of Pauli rotation unitaries owns the 1-norm of  $\mu_x = 1 + \mathcal{O}(x^{2s})$ , whose  $x$ -dependence is doubled.

Similarly, for the  $K$ th-order Trotter error  $V_K(x)$  ( $K = 2k, k \in \mathbb{N}_+$ ), we have  $F_{K,1} = \dots = F_{K,K} = 0$  [8, 14]. Moreover, we can expand  $F_{K,K+1}, F_{K,K+2}, \dots, F_{K,2K+1}$  by

the summation of nested commutators which are anti-Hermitian. We call the term with  $s = K + 1$  to  $2K + 1$  the leading-order terms. The algorithm utilizing  $K$ th-order Trotter formula and the paired idea in the LCU construction is called the  $K$ th-order paired Taylor-series compensation (PTSc) algorithm. We provide the detailed algorithm description and gate-complexity analysis in Appendix F.

**Theorem 1** (Informal, see Theorem 1 in Appendix F) In a  $K$ th-order Paired Taylor-series compensation algorithm ( $K = 0, 1$  or  $2k, k \in \mathbb{N}_+$ ), the gate complexity in a single-round is  $\mathcal{O}\left((\lambda t)^{1+\frac{1}{2K+1}} (\kappa_K L + \frac{\log(1/\varepsilon)}{\log \log(1/\varepsilon)})\right)$ , where  $\lambda = \sum_l \|H_l\|$ ,  $\kappa_K = K$  when  $K = 0$  or  $1$ ,  $\kappa_K = 2 \cdot 5^{K/2-1}$  otherwise.

From Theorem 1 we can see that, if we set  $K = 0$ , i.e., do not use the Trotter formula, the PTSc algorithm is also valid by pairing  $F_{0,1}$  with  $I$ . In this case, the gate complexity is independent of the sparsity  $L$  while quadratically dependent on  $t$ , similar to the algorithm in Ref. [23]. On the other hand, if we use  $K$ th-order Trotter formula, the PTSc algorithm is  $L$ -dependent and has an almost linear  $t$  dependence. In both cases, the PTSc algorithms enjoy a high simulation accuracy  $\varepsilon$ . We expect the 0th-order algorithm to be especially useful for the quantum chemistry Hamiltonian with large  $L$ , while higher-order algorithms to be useful for a generic  $L$ -sparse Hamiltonian with a long simulation time  $t$ .

The PTSc algorithms above are generic and applicable to any Hamiltonian. When we consider the detailed structure of Hamiltonians, we could make the compensation algorithms more efficient by taking advantage of the nested-commutator form like  $\mathcal{A}_{com}^{(s-1)}(H_L, \dots, H_1; H)$  in Eq. (6). For some physical Hamiltonians with locality constraints, the number of nonzero nested commutators in Eq. (6) can be significantly reduced.

We propose the  $K$ th-order nested-commutator compensation (NCc) algorithm that utilizes the detailed nested-commutator forms of Trotter error terms from  $K + 1$  to  $2K + 1$  order. A key difference between NCc and PTSc algorithms is that in PTSc algorithms, we compensate the Trotter error  $V_K(x)$  up to arbitrary order; while in NCc algorithms, we only compensate  $V_K(x)$  from  $(K + 1)$ th order to  $(2K + 1)$ th order, which shrinks the error from  $\mathcal{O}(x^{K+1})$  to  $\mathcal{O}(x^{2K+2})$  in one slice with the sampling cost  $\mu = 1 + \mathcal{O}(\frac{\|C_K\|_1}{K+1} x^{2K+2})$ . The gate complexity estimation is then converted to the calculation of  $\|C_K\|_1$ . For instance, if we consider the  $n$ -qubit lattice Hamiltonian models  $H = \sum_{j=0}^{n-1} H_{j,j+1}$  where the summand  $H_{j,j+1}$  acts on the  $j$ th and  $(j+1)$ th qubits, then we can prove that  $\|C_K\|_1 = \mathcal{O}(n)$ . This helps to reduce the system-size dependence of NCc algorithms. More details are provided in Appendix G.

**Theorem 2** (Informal, see Theorem 2 in Appendix G) In a  $K$ th-order nested-commutator compensation (NCc) algorithm ( $K = 1$  or  $2k$ ) with  $n$ -qubit lattice Hamiltonians, the gate complexity in a single round is  $\mathcal{O}(n^{1+\frac{2}{2K+1}} t^{1+\frac{1}{2K+1}} \varepsilon^{-\frac{1}{2K+1}})$ .

Compared to the performance of  $K$ th-order Trotter algorithm  $\mathcal{O}((nt)^{1+1/K}\varepsilon^{-1/K})$  [13], we achieve  $t$ - and  $\varepsilon$ -dependence better than  $2K$ th-order Trotter using only  $K$ th-order Trotter formula with simple compensation gates. In Theorem 2, we only present the gate complexity result for the lattice Hamiltonian due to its simplicity. In Appendix G, we also study the performance of NCc algorithms under a generic Hamiltonian by expanding the Trotter error to operators  $C_s$  with different order  $s$ . Combining with the former calculation of nested commutators for different Hamiltonian models [14], we can easily extend the analysis to many typical Hamiltonian models.

In Table I, we compare the properties of 0th-order PTSc,  $K$ th-order PTSc, and  $K$ th-order NCc algorithms with the random-sampling implementation of LCU and compare the results to former algorithms. The PTSc gate counts are able to achieve logarithmic accuracy dependence  $\log(1/\varepsilon)$  while the NCc gate counts are able to achieve a better system-size dependence. Both types of Trotter-LCU algorithms can be realized with random-sampling implementation using only one ancillary qubit.

Algorithm	Hardness	Accuracy	Size scaling
$K$ th-order Trotter [8]	Easy	$\mathcal{O}(\varepsilon^{-1/K})$	$\mathcal{O}(n^{1+o(1)})$
Post-Trotter [17, 18]	Hard	$\mathcal{O}(\log(1/\varepsilon))$	$\mathcal{O}(n^2)$
0th-order PTSc	Easy	$\mathcal{O}(\log(1/\varepsilon))$	$\mathcal{O}(n^2)$
$K$ th-order PTSc	Easy	$\mathcal{O}(\log(1/\varepsilon))$	$\mathcal{O}(n^{2+o(1)})$
$K$ th-order NCc	Easy	$\mathcal{O}(\varepsilon^{-1/(2K+1)})$	$\mathcal{O}(n^{1+o(1)})$

TABLE I. Compare Trotter-LCU methods with former algorithms. Here,  $\log(x) := \log(x)/\log \log(x)$ . The (implementation) hardness refers to whether one needs to implement multi-controlled gates with plenty of ancillary qubits. The algorithms with commutator scaling can use advanced analysis to reduce the gate complexity of  $n$ -qubit lattice Hamiltonians from  $\mathcal{O}(n^2)$  to  $\mathcal{O}(n)$ . More details of the comparisons and gate complexities can be found in Appendix C.

**Numerical results.** We estimate the gate cost of Trotter-LCU algorithms and compare it with the state-of-the-art Trotter algorithm, i.e., 4th-order Trotter [9, 12, 14]. We compile their quantum circuits to CNOT gates, single-qubit Clifford gates, and single-qubit  $Z$ -axis rotation gates  $R_z(\theta) = e^{i\theta Z}$ . Since the non-Clifford  $Z$ -axis rotation gates  $R_z(\theta)$  are the most resource-consuming part on a fault-tolerant quantum computer, here we mainly compare the  $R_z(\theta)$  gate number in the main text. The CNOT gate number comparison results are similar, shown in Appendix L. In the first comparison, we consider the simulation of generic Hamiltonians without the usage of commutator information, for which we choose the 2-local Hamiltonian,  $H = \sum_{i,j} X_i X_j + \sum_i Z_i$ . Fig. 2(a,b) show the gate counts for the 4th-order Trotter formula and the PTSc Trotter-LCU algorithms with different orders with an increasing time  $t$  and increasing system size  $n$ , respectively. The gate counting method for 4th-order Trotter with random permutation is based

on the analytical bounds in Ref. [12].

From Fig. 2(a,b), we can clearly see the advantage of composition of Trotter and LCU formulas: if we do not use LCU and merely apply Trotter formulas, the gate resource of 4th-order Trotter suffers from a large overhead that is 2 orders of magnitudes larger than the PTSc algorithms. Moreover, if we increase  $\varepsilon$  from  $10^{-3}$  to  $10^{-5}$ , we can see a clear increase of the gate resources for the Trotter algorithm. For the PTSc algorithms, however, the gate number is almost not affected by  $\varepsilon$  since they enjoy a logarithmic  $\varepsilon$ -dependence.

On the other hand, if we do not use Trotter formula, the 0th-order PTSc algorithm owns a quadratically worse  $t$ -dependence ( $\mathcal{O}(t^2)$ ) than the 4th-order Trotter ( $\mathcal{O}(t^{1.25})$ ), 2nd-order PTSc ( $\mathcal{O}(t^{1.2})$ ) and 4th-order PTSc ( $\mathcal{O}(t^{1.11})$ ) algorithms in Fig. 2(a). For a short-time evolution  $t = n$ , the system-size dependence of 2nd- or 4th-order PTSc in Fig. 2(b) outperforms 0th-order PTSc algorithm. In the case when long-time Hamiltonian simulation is required, for example,  $t$  should be set to  $10^3$  for the phase estimation [11], the advantage of 2nd or 4th-order PTSc to 0th-order PTSc will be more obvious. The composition of Trotter and LCU formulas enables 2nd or 4th-order PTSc to enjoy good  $t$ - and  $\varepsilon$ -dependence and small gate-resource overhead simultaneously.

Next, we compare the gate count when simulating the lattice models, where the commutator analysis will help remarkably reduce the gate count. We consider the Heisenberg Hamiltonian  $H = \sum_i \vec{\sigma}_i \vec{\sigma}_{i+1} + \sum_i Z_i$ , where  $\vec{\sigma}_i := (X_i, Y_i, Z_i)$  is the vector of Pauli operators on the  $i$ th qubit, using the nested commutator bounds. In Fig. 2(c), we choose  $n = t = 12$  and 50 and show the gate number with respect to the accuracy requirement  $\varepsilon$ . The 4th-order Trotter error analysis is based on the nested commutator bound (Proposition M.1 in Ref. [14]), which is currently the tightest Trotter error analysis. The performance of our 2nd-order NCc algorithm is based on the analytical bound in Appendix H. We mainly present results for the 2nd-order NCc algorithm due to its simplicity and leave precise higher-order NCc gate count analysis for future study.

From Fig. 2(c), we can see that, while enjoying near-optimal system-size scaling similar to the 4th-order Trotter algorithm which is currently the best one for lattice Hamiltonians [13, 14], the 2nd-order NCc algorithm shows better accuracy dependence than 4th-order Trotter algorithm. Especially, using the same gate number as the 4th-order Trotter, we are able to achieve a 3 to 4 orders of magnitudes higher accuracy  $\varepsilon$ .

**Summary and outlook.** We develop a unified framework for the Trotter-LCU algorithms with a series connection of Trotter and LCU algorithms. In fact, both Trotter and LCU algorithms can be regarded as special cases in the framework. This provides a possible composition method between different Hamiltonian simulation algorithms [29]. Recently, Cho et al. [30] consider similar idea to compensate the Trotter error using randomized unitary operators. There are still many possible vari-

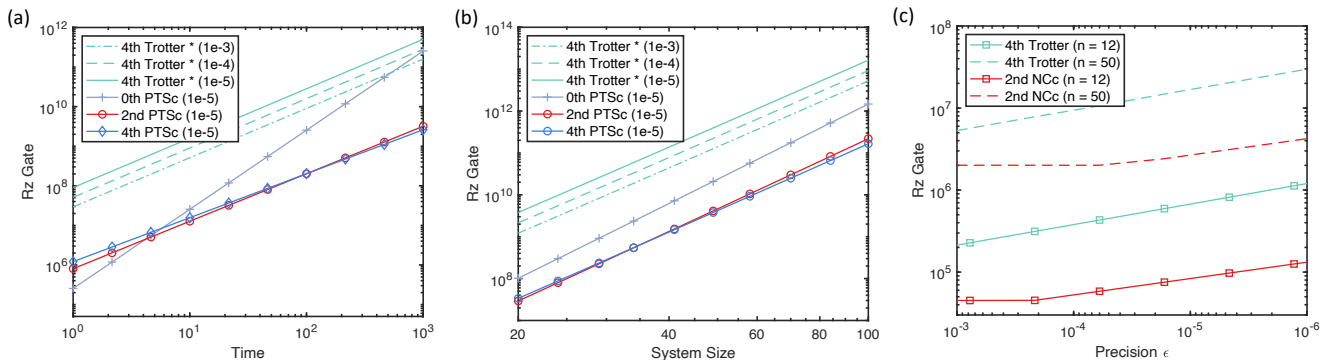

FIG. 2. Non-Clifford  $R_z(\theta)$  gate number estimation for simulating real-time dynamics with Trotter and Trotter-LCU algorithms. (a) and (b) show the  $R_z(\theta)$  gate counts when simulating the Hamiltonian  $H = \sum_{i,j} X_i X_j + \sum_i Z_i$ . (a) shows the  $R_z(\theta)$  gate count with an increasing time and fixed system-size  $n = 20$ . (b) shows the  $R_z(\theta)$  gate count with an increasing system size with the time  $t = n$ . We list the performance of 0th, 2nd, and 4th-order PTSc algorithms with  $\mu = 2$ . The 4th-order Trotter analytical bound is from Ref. [12]. (c) The  $R_z(\theta)$  gate count for the nearest-interaction Heisenberg model using the nested commutator bound with  $n = 12$  and  $n = 50$ . The 4th-order Trotter commutator bound is from Ref. [14].

ants to be explored. For example, we may replace the deterministic Trotter algorithms with the ones with random permutation [12]. We may also consider the usage of quantum signal processing to compensate the Trotter errors. Using anti-commutative cancellation [31], we can further reduce the compensation terms. Furthermore, we may consider using LCU to compensate both Trotter and physical errors to pursue a robust Hamiltonian simulation.

## ACKNOWLEDGMENTS

We thank Xiaoming Zhang, Xiao Yuan, Min-Hsiu Hsieh, Yuan Su, Kaiwen Gui, Ming Yuan, Senrui

Chen and Ying Li for helpful discussion and suggestions. P. Z. and L. J. acknowledge support from the ARO MURI (W911NF-21-1-0325), AFOSR MURI (FA9550-19-1-0399, FA9550-21-1-0209), AFRL (FA8649-21-P-0781), DoE Q-NEXT, NSF (OMA-1936118, ERC-1941583, OMA-2137642), NTT Research, and the Packard Foundation (2020-71479). Q. Z. acknowledges the support from HKU Seed Fund for New Staff.

- 
- [1] R. P. Feynman et al., Int. j. Theor. phys **21** (1982), URL <http://dx.doi.org/10.1007/BF02650179>.
- [2] D. S. Abrams and S. Lloyd, Phys. Rev. Lett. **83**, 5162 (1999), URL <https://link.aps.org/doi/10.1103/PhysRevLett.83.5162>.
- [3] A. Aspuru-Guzik, A. D. Dutoi, P. J. Love, and M. Head-Gordon, Science **309**, 1704 (2005), <https://www.science.org/doi/pdf/10.1126/science.1113479>, URL <https://www.science.org/doi/abs/10.1126/science.1113479>.
- [4] E. Farhi, J. Goldstone, and S. Gutmann, *A quantum approximate optimization algorithm* (2014), URL <https://arxiv.org/abs/1411.4028>.
- [5] L. Zhou, S.-T. Wang, S. Choi, H. Pichler, and M. D. Lukin, Phys. Rev. X **10**, 021067 (2020), URL <https://link.aps.org/doi/10.1103/PhysRevX.10.021067>.
- [6] A. W. Harrow, A. Hassidim, and S. Lloyd, Phys. Rev. Lett. **103**, 150502 (2009), URL <https://link.aps.org/doi/10.1103/PhysRevLett.103.150502>.
- [7] S. Lloyd, Science **273**, 1073 (1996), <https://www.science.org/doi/pdf/10.1126/science.273.5278.1073>, URL <https://www.science.org/doi/abs/10.1126/science.273.5278.1073>.
- [8] M. Suzuki, Physics Letters A **146**, 319 (1990), ISSN 0375-9601, URL <https://www.sciencedirect.com/science/article/pii/037596019090962N>.
- [9] M. Suzuki, Journal of Mathematical Physics **32**, 400 (1991), URL <https://aip.scitation.org/doi/10.1063/1.529425>.
- [10] D. W. Berry, G. Ahokas, R. Cleve, and B. C. Sanders, Communications in Mathematical Physics **270**, 359 (2007), URL <https://doi.org/10.1007/s00220-006-0150-x>.
- [11] E. Campbell, Phys. Rev. Lett. **123**, 070503 (2019), URL <https://link.aps.org/doi/10.1103/PhysRevLett.123.070503>.
- [12] A. M. Childs, A. Ostrander, and Y. Su, Quantum **3**, 182 (2019), ISSN 2521-327X, URL <https://doi.org/10.22331/q-2019-09-02-182>.
- [13] A. M. Childs and Y. Su, Phys. Rev. Lett. **123**, 050503 (2019), URL <https://link.aps.org/doi/10.1103/PhysRevLett.123.050503>.

- [14] A. M. Childs, Y. Su, M. C. Tran, N. Wiebe, and S. Zhu, *Phys. Rev. X* **11**, 011020 (2021), URL <https://link.aps.org/doi/10.1103/PhysRevX.11.011020>.
- [15] M. Reiher, N. Wiebe, K. M. Svore, D. Wecker, and M. Troyer, *Proceedings of the National Academy of Sciences* **114**, 7555 (2017), <https://www.pnas.org/doi/pdf/10.1073/pnas.1619152114>, URL <https://www.pnas.org/doi/abs/10.1073/pnas.1619152114>.
- [16] D. W. Berry, A. M. Childs, R. Cleve, R. Kothari, and R. D. Somma, in *Proceedings of the forty-sixth annual ACM symposium on Theory of computing* (ACM, 2014), URL <https://doi.org/10.1145/2F2591796.2591854>.
- [17] D. W. Berry, A. M. Childs, R. Cleve, R. Kothari, and R. D. Somma, *Phys. Rev. Lett.* **114**, 090502 (2015), URL <https://link.aps.org/doi/10.1103/PhysRevLett.114.090502>.
- [18] G. H. Low and I. L. Chuang, *Quantum* **3**, 163 (2019), ISSN 2521-327X, URL <https://doi.org/10.22331/q-2019-07-12-163>.
- [19] G. H. Low and I. L. Chuang, *Phys. Rev. Lett.* **118**, 010501 (2017), URL <https://link.aps.org/doi/10.1103/PhysRevLett.118.010501>.
- [20] A. M. Childs and N. Wiebe, *Quantum Information and Computation* **12** (2012), ISSN 1533-7146, URL <http://dx.doi.org/10.26421/QIC12.11-12>.
- [21] L. Lin and Y. Tong, *Heisenberg-limited ground state energy estimation for early fault-tolerant quantum computers* (2021), 2102.11340, URL <https://arxiv.org/abs/2102.11340>.
- [22] Y. Yang, B.-N. Lu, and Y. Li, *PRX Quantum* **2**, 040361 (2021), URL <https://link.aps.org/doi/10.1103/PRXQuantum.2.040361>.
- [23] K. Wan, M. Berta, and E. T. Campbell, *Phys. Rev. Lett.* **129**, 030503 (2022), URL <https://link.aps.org/doi/10.1103/PhysRevLett.129.030503>.
- [24] P. K. Faehrmann, M. Steudtner, R. Kueng, M. Kieferova, and J. Eisert, *Randomizing multi-product formulas for improved hamiltonian simulation* (2021), URL <https://arxiv.org/abs/2101.07808>.
- [25] L. Lin and Y. Tong, *Quantum* **4**, 372 (2020), ISSN 2521-327X, URL <https://doi.org/10.22331/q-2020-12-14-372>.
- [26] P. Zeng, J. Sun, and X. Yuan, *Universal quantum algorithmic cooling on a quantum computer* (2021), URL <https://arxiv.org/abs/2109.15304>.
- [27] R. Zhang, G. Wang, and P. Johnson, *Quantum* **6**, 761 (2022), ISSN 2521-327X, URL <https://doi.org/10.22331/q-2022-07-11-761>.
- [28] A. Y. Kitaev, *Quantum measurements and the abelian stabilizer problem* (1995), URL <https://arxiv.org/abs/quant-ph/9511026>.
- [29] M. Hagan and N. Wiebe, *Composite quantum simulations* (2022), URL <https://arxiv.org/abs/2206.06409>.
- [30] C. H. Cho, D. W. Berry, and M.-H. Hsieh, *Doubling the order of approximation via the randomized product formula* (2022), URL <https://arxiv.org/abs/2210.11281>.
- [31] Q. Zhao and X. Yuan, *Quantum* **5**, 534 (2021), ISSN 2521-327X, URL <https://doi.org/10.22331/q-2021-08-31-534>.
- [32] A. M. Childs, D. Maslov, Y. Nam, N. J. Ross, and Y. Su, *Proceedings of the National Academy of Sciences* **115**, 9456 (2018), URL <https://www.pnas.org/content/115/38/9456>.
- [33] G. H. Low, V. Kliuchnikov, and N. Wiebe, *Well-conditioned multiproduct hamiltonian simulation* (2019), URL <https://arxiv.org/abs/1907.11679>.
- [34] P. Zeng, Q. Zhao, J. Sun, S. Chen, and L. Jiang, *Indirect shadow estimation for hamiltonian simulation* (2022), in preparation.
- [35] S. Aaronson and D. Gottesman, *Phys. Rev. A* **70**, 052328 (2004), URL <https://link.aps.org/doi/10.1103/PhysRevA.70.052328>.
- [36] N. Schuch, M. M. Wolf, K. G. H. Vollbrecht, and J. I. Cirac, *New Journal of Physics* **10**, 033032 (2008), URL <https://doi.org/10.1088/1367-2630/10/3/033032>.
- [37] A. W. Knap, *Basic real analysis* (Springer Science & Business Media, 2005), URL <https://doi.org/http://dx.doi.org/10.3792/euclid/9781429799997>.
- [38] C. Canonne, *A short note on poisson tail bounds* (2016), URL <http://www.cs.columbia.edu/~ccanonne/files/misc/2017-poissonconcentration.pdf>.
- [39] A. Hoorfar and M. Hassani, *J. Inequal. Pure and Appl. Math* **9**, 5 (2008), URL <https://www.emis.de/journals/JIPAM/article983.html?sid=983>.
- [40] R. Babbush, C. Gidney, D. W. Berry, N. Wiebe, J. McClean, A. Paler, A. Fowler, and H. Neven, *Phys. Rev. X* **8**, 041015 (2018), URL <https://link.aps.org/doi/10.1103/PhysRevX.8.041015>.
- [41] J. Sun, X. Yuan, M. Kim, V. Vlatko, and P. Zeng, *High-precision eigenenergy estimation and eigenstate property estimation: a framework and resource estimation* (2022), in preparation.
- [42] A. Bocharov, M. Roetteler, and K. M. Svore, *Phys. Rev. Lett.* **114**, 080502 (2015), URL <https://link.aps.org/doi/10.1103/PhysRevLett.114.080502>.

## CONTENTS

Acknowledgments	5
References	5
A. Outline	8
B. Related works	8
C. Summary of results	9
D. Preliminaries	10
1. Trotter formulas	11
2. Linear combination of unitaries	12
3. Construct LCU formulas for Trotter remainders	18
E. Trotter-LCU formula with direct Taylor-series compensation	21
1. Zeroth-order case	22
2. First-order case	24
3. Second- and higher-order case	27
F. Trotter-LCU formula with paired Taylor-series compensation	30
1. Zeroth-order case	30
2. First-order case	33
3. Second- and higher-order case	37
G. Trotter-LCU formula with nested-commutator compensation	42
1. Derivation of the nested-commutator compensation formula	43
2. First-order case (lattice Hamiltonians)	48
3. Second- and higher-order case (lattice Hamiltonians)	52
4. General Hamiltonians	55
H. Tighter nested-commutator analysis for second-order Trotter-LCU algorithm	57
1. Bound the 1-norm of recurrence function	57
2. Estimating the gate counts	60
I. Explicit nested-commutator compensation for higher-order Trotter remainders	60
1. Derivation of LCU formula with nested-commutator form	61
2. Norm bounds for LCU formula	63
J. Explicit nested-commutator compensation for generic Hamiltonians	67
1. Derivation of LCU formula in nested-commutator form	67
2. Norm bounds for LCU formula	68
K. Some useful formulas in the proof	71
L. Additional numerical results	73
1. Generic L-sparse Hamiltonians	73
2. Lattice Hamiltonians	74

## Appendix A: Outline

We give a synopsis of the appendix here. In Appendix B, we review the related historical works of the Trotter, LCU and composite algorithms. In Appendix C, we summarize the gate complexity of different Trotter-LCU algorithms and compare it with former algorithms.

In Appendix D, we introduce the background knowledges related to the Trotter and LCU formulas. We review their definition and their gate complexity. With these information, in Appendix D3 we introduce three methods to construct LCU formulas for the Trotter remainders: the direct Taylor-series compensation (DTSc), paired Taylor-series compensation (PTSc), and nested-commutator compensation (NCc).

In Appendix E, F, and G, we introduce the DTSc, PTSc, and NCc Trotter-LCU methods in detail. We derive the explicit LCU formulas, propose detailed random-sampling procedures and analyze the performance of the LCU formulas. We will first analyze the LCU formula construction for the zeroth-order and first-order Trotter remainders and then generalize it to general  $K$ th-order case. Proofs of Theorem 1 and 2 are provided in Appendix F3 and Appendix G3, respectively. As the complementarity of Appendix G, Appendix H, I, and J provides more details related to the NCc methods.

Finally, in Appendix K we provide some useful formulas in the proof. In Appendix L, we provide more numerical results, including the gate cost comparison with the quantum signal processing (QSP) algorithm.

## Appendix B: Related works

Here, we summarize the related historical works of the Trotter, LCU algorithms, and their composite ones.

*Trotter formulas.* There has been a long history for the study of Trotter-type formulas. We refer the readers to Sec. IB in Ref. [14] for the history of Trotter formulas. The Trotter-type formulas are first analyzed in the study of Lie group in 19th century. In 1990, Suzuki extends the Trotter formulas to the high-order case and finds their application in the path-integral formulation of quantum mechanics [8, 9]. In 1996, Lloyd considers the usage of first-order Trotter formula in Hamiltonian simulation [7]. In 2007, Berry et. al. provide a detailed error analysis [10] for the Trotter formulas. After that, in 2018, Childs et. al. tighten the Trotter error analysis using the using the commutator information in the Hamiltonian [32] and derived the nested commutator forms in the following analysis [13, 14]. To improve the Hamiltonian sparsity dependence, Campbell proposes the qDRIFT algorithm which randomly sample the summands to realize the product formulas [11].

*Linear-combination-of-unitary.* In 2012, Childs and Wiebe clarify the idea of linear-combination-of-unitary in Hamiltonian simulation [20]. They design LCU formulas based on the summation of different Trotter formulas and consider a non-deterministic realization. The authors adopt multi-product formulas  $M_{R,2k}(t)$  with  $R$  times of different  $2k$ th-order Trotter formulas and carefully design the linear combination coefficients to cancel out the low-order time-dependent terms  $t^q$  with  $q < 2R + 1$  in the additive errors. In 2019, Low et al. improves the multi-product formula construction by reducing the 1-norm of the LCU of  $K$ th-order formula from  $e^{\Omega(K)}$  to  $\mathcal{O}(\log K)$  [33]. They also discuss the commutator scaling of the multi-product formula. Besides the multi-product formula construction, in 2015, Berry et. al. introduce new LCU formula based on Taylor-series expansion [17]. By introducing the oblivious amplitude amplification [16], they make the LCU-based simulation algorithm nearly-deterministic and prove the gate complexity to be logarithmic to inverse accuracy  $1/\epsilon$ . On the other hand, there have been discussion about realizing LCU formula based on random sampling. In 2021, Wan et al. consider the realization of Taylor-series expansion of  $U(t)$  based on random sampling [23]. Combined with the random-sampling version of phase estimation algorithm by Lin and Tong [21], they propose a randomized phase-estimation algorithm whose gate number in each sample is independent of  $L$ . At the same time, Faehrmann et al. propose new multi-product LCU formulas [24] following Ref. [20] and show that the simulation error can be exponentially suppressed by increasing the number of Trotter components  $R$  in the LCU formula. They consider a realization of multi-product LCU formula based on random sampling.

*Composite Hamiltonian simulation.* There have been discussion about combining different Hamiltonian simulation algorithms. In 2021, Yang et al. propose Hamiltonian simulation algorithms by randomly sampling the terms in Taylor-series expansion of the remainder in the Trotter formulas [22]. They mainly work on the asymptotic performance without considering the effect of finite gate number. We generalize the discussion and systematically study different Trotter-LCU algorithms and provide rigorous gate complexity analysis. In 2022, Hegam and Wiebe propose a composite Hamiltonian simulation method by combining deterministic Trotter formulas with qDRIFT methods [29]. They also discuss the composite algorithms between different types of Hamiltonian simulation algorithm, such as Trotter and LCU. We remark that, the concept of ‘‘composition’’ there is different from our discussion — They consider to perform different types of Hamiltonian simulation algorithms for different disjoint physical subspaces.



### Appendix C: Summary of results

In this work, we discuss various types of Trotter-LCU methods. We consider three methods to construct the LCU formulas: direct Taylor-series compensation (DTSc) (Sec. E), paired Taylor-series compensation (PTSc) (Sec. F), and nested-commutator compensation (NCc) (Sec. G). We consider two ways to implement the LCU formula for the compensation of Trotter remainders. In the random-sampling implementation [23, 24], we sample the elementary unitaries  $\{V_i\}$  based on the corresponding probability  $\{p_i\}$  and embed the realization of the LCU formula into a Hadamard test [28]. In the coherent implementation [16, 17], we introduce  $m = \lceil \log_2 \Gamma \rceil$  ancillary qubits to realize the superposition of different  $\{V_i\}$ . Our major focus is on the random-sampling implementation, where we can estimate the properties of the target state  $U(t)|\psi_0\rangle$  with only one ancillary qubit.

We summarize the gate complexities of the algorithms with random-sampling implementation in Table II, while the ones for the coherent implementation in Table III.

TABLE II. Summary of the random-sampling Trotter-LCU Hamiltonian simulation protocols and corresponding gate complexities. Here,  $\tilde{\log}(x) := \log(x)/\log \log(x)$ . The direct Taylor-series (DTS), paired Taylor-series (PTS), and nested-commutator (NC) are discussed in Sec. E, F, and G, respectively. Since the result of NC compensation relies on the specific Hamiltonian structure, here we main provide results for the lattice Hamiltonians.

Trotter order	Direct Taylor-series compensation	Paired Taylor-series compensation	Nested-commutator compensation
0th-order	N/A	$\mathcal{O}((\lambda t)^2 \tilde{\log}(1/\varepsilon))$	N/A
1st-order	$\mathcal{O}((\lambda t)^2 (L + \tilde{\log}(1/\varepsilon)))$	$\mathcal{O}((\lambda t)^{1+\frac{1}{3}} (L + \tilde{\log}(1/\varepsilon)))$	$\mathcal{O}(n^{1+\frac{2}{3}} t^{1+\frac{1}{3}} \varepsilon^{-\frac{1}{3}})$
2kth-order	$\mathcal{O}((\lambda t)^{1+\frac{1}{2k}} (L + \tilde{\log}(1/\varepsilon)))$	$\mathcal{O}((\lambda t)^{1+\frac{1}{4k+1}} (L + \tilde{\log}(1/\varepsilon)))$	$\mathcal{O}(n^{1+\frac{2}{4k+1}} t^{1+\frac{1}{4k+1}} \varepsilon^{-\frac{1}{4k+1}})$

TABLE III. Summary of the coherent Trotter-LCU Hamiltonian simulation protocols and corresponding gate complexities. Here,  $\tilde{\log}(x) := \log(x)/\log \log(x)$ . Since the result of NC compensation relies on the specific Hamiltonian structure, here we main provide results for the lattice Hamiltonians.

Trotter order	Direct Taylor-series compensation	Paired Taylor-series compensation	Nested-commutator compensation
0th-order	$\mathcal{O}((\lambda t)L\tilde{\log}(1/\varepsilon))$ [17]	$\mathcal{O}((\lambda t)L\tilde{\log}(1/\varepsilon))$	N/A
1st-order	$\mathcal{O}((\lambda t)L\tilde{\log}(1/\varepsilon))$	$\mathcal{O}((\lambda t)L\tilde{\log}(1/\varepsilon))$	$\mathcal{O}(n^{1+\frac{2}{3}} t^{1+\frac{1}{3}} \varepsilon^{-\frac{1}{3}})$
2kth-order	$\mathcal{O}((\lambda t)L\tilde{\log}(1/\varepsilon))$	$\mathcal{O}((\lambda t)L\tilde{\log}(1/\varepsilon))$	$\mathcal{O}(n^{1+\frac{2}{4k+1}} t^{1+\frac{1}{4k+1}} \varepsilon^{-\frac{1}{4k+1}})$

In Table IV, we compare the Trotter-LCU algorithms with the current advanced algorithms. We mainly consider 0th-order PTSc,  $K$ th-order PTSc,  $K$ th-order NCc algorithms with random sampling implementation of LCU and the  $K$ th-order NCc algorithm with coherent implementation of LCU. The 0th-order PTSc algorithm is independent of the number of terms  $L$  in Hamiltonians, which is especially useful for many quantum chemistry problem with many terms; the  $K$ th-order PTSc algorithm owns the best time dependence of  $\mathcal{O}(t^{1+\frac{1}{2K+1}})$  over all random-sampling based algorithms, which is suitable for a long-time high-precision simulation; the  $K$ th-order NCc algorithm owns almost linear  $n$  and  $t$  dependence for the lattice models.

TABLE IV. Compare Trotter-LCU methods with former algorithms. The implementation hardness refers to whether one needs to implement multi-controlled gates with plenty of ancillary qubits. The algorithms with commutator scaling can use advanced analysis to reduce the gate complexity of  $n$ -qubit lattice Hamiltonians from  $\mathcal{O}(n^2)$  to  $\mathcal{O}(n)$ .

Algorithm	Implementation hardness	Simulation accuracy	Commutator scaling	Time dependence
$K$ th-order Trotter [8]	Easy	Low, $\mathcal{O}(\varepsilon^{-1/K})$	Yes, $\mathcal{O}(n^{1+1/K})$	$\mathcal{O}(t^{1+1/K})$
Post-Trotter (LCU, QSP) [17, 18]	Hard	High, $\mathcal{O}(\log(1/\varepsilon))$	No, $\mathcal{O}(n^2)$	$\mathcal{O}(t)$
0th-order PTSc (random)	Easy	High, $\mathcal{O}(\tilde{\log}(1/\varepsilon))$	No, $\mathcal{O}(n^2)$ ( $L$ independent)	$\mathcal{O}(t^2)$
$K$ th-order PTSc (random)	Easy	High, $\mathcal{O}(\tilde{\log}(1/\varepsilon))$	No, $\mathcal{O}(n^{2+\frac{1}{2K+1}})$	$\mathcal{O}(t^{1+\frac{1}{2K+1}})$
$K$ th-order NCc (random)	Easy	Medium, $\mathcal{O}(\varepsilon^{-1/(2K+1)})$	Yes, $\mathcal{O}(n^{1+\frac{2}{2K+1}})$	$\mathcal{O}(t^{1+\frac{1}{2K+1}})$
$K$ th-order NCc (coherent)	Hard	Medium, $\mathcal{O}(\varepsilon^{-1/(2K+1)})$	Yes, $\mathcal{O}(n^{1+\frac{2}{2K+1}})$	$\mathcal{O}(t^{1+\frac{1}{2K+1}})$

### Appendix D: Preliminaries

In this work, we focus on the construction of  $U(t) := e^{-iHt}$  of a Hamiltonian  $H$  on  $n$  qubits. An  $n$ -qubit Hamiltonian  $H$  is a Hermitian operator which can be written as

$$H = \sum_{l=1}^L H_l = \sum_{l=1}^L \alpha_l P_l = \lambda \sum_{l=1}^L p_l P_l, \quad (\text{D1})$$

where  $\{P_l\}_l$  are different  $n$ -qubit Pauli operators. We set all the coefficients  $\{\alpha_l\}_l$  to be positive and absorb the signs into Pauli operators  $\{P_l\}_l$ . For simplicity, we also assume that  $t > 0$  in the following discussion. If  $t < 0$ , we will absorb the signs into the Pauli operators, which will not affect the analysis.

In what follows, we will denote the properties related to the summands of Hamiltonians  $\{H_l\}_{l=1}^L$  to be vectors,

$$\begin{aligned} \vec{\alpha} &:= [\alpha, \alpha_2, \dots, \alpha_L], \\ \vec{p} &:= [p_1, p_2, \dots, p_L], \\ \vec{H} &:= [H_1, H_2, \dots, H_L], \\ \vec{P} &:= [P_1, P_2, \dots, P_L]. \end{aligned} \quad (\text{D2})$$

In Eq. (D1),  $\lambda = |\vec{\alpha}| = \sum_{l=1}^L \alpha_l$  is the  $l_1$ -norm of the coefficient vector  $\vec{\alpha}$ . Then  $\vec{p}$  will be a probability distribution.

In all the Hamiltonian simulation algorithms discussed in this work, we divide the real-time evolution  $U(t)$  into  $\nu$  segments,

$$U(t) = e^{-iHt} = (U(x))^\nu = (e^{-iHx})^\nu, \quad (\text{D3})$$

where  $x := t/\nu$ . In this way, we focus on the construction of  $U(x)$ , which is usually simpler. Since we assume that  $t > 0$ ,  $x$  will also be positive. This will not affect the generality of our results as it can be easily extended to the case with  $t < 0$ .

Here, we introduce several notation to simplify the summation or multiplication of similar terms. For a group of index  $\{a_1, a_2, \dots, a_m\}$  of the same type with length  $m$ , we denote it as  $a_{1:m}$ . The summation of the indices is

$$\sum a_{1:m} := \sum_{i=1}^m a_i. \quad (\text{D4})$$

Moreover, for the multiplication of the quantities  $O_{a_1} O_{a_2} \dots O_{a_m}$  with the same type of indices, we denote it as  $O_{a_{1:m}}^{(m)}$ , i.e.,

$$\begin{aligned} O_{a_{1:m}}^{(m)} &:= \prod_{i=1}^m O_{a_i}, \\ \sum_{a_{1:m}} O_{a_{1:m}}^{(m)} &:= \sum_{a_1, a_2, \dots, a_m} O_{a_{1:m}}^{(m)}. \end{aligned} \quad (\text{D5})$$

When  $\{O_i\}_i$  is a group of operators, the value of  $O_{a_{1:m}}^{(m)}$  may be unequal to  $O_{a_{m:1}}^{(m)}$  with the inverse multiplication direction.

Especially, for the indices  $l$  related to the Hamiltonian sparsity, i.e.,  $l$  is enumerated from 1 to  $L$ , we adopt the vector notations mentioned in Eq. (D2). Moreover, when multiple  $l$ -related vectors occur in the same summation or product formula, we will treat them as index-wise operation, i.e.,

$$\begin{aligned} \sum f(\vec{\alpha}, \vec{r}) &= \sum_{l=1}^L f(\alpha_l, r_l), \\ \prod \leftarrow f(\vec{\alpha}, \vec{r}) &= \prod_{l=1}^L f(\alpha_l, r_l). \end{aligned} \quad (\text{D6})$$

When the output of the function  $f(\vec{\alpha}, \vec{r})$  is a number, we will omit the arrow in the product as the product direction becomes insignificant.

### 1. Trotter formulas

The most natural way to approximate  $U(x)$  is to apply the Lie-Trotter-Suzuki formulas [8, 9], also called product formulas. Hereafter, we refer to them as Trotter formulas. The first-order Trotter formula is

$$S_1(x) = \prod_{l=1}^L e^{-ixH_l} = e^{-ixH_L} \dots e^{-ixH_2} e^{-ixH_1} =: \overleftarrow{\prod}_{l=1}^L e^{-ix\vec{H}}. \quad (\text{D7})$$

Here,  $\vec{H}$  is defined in Eq. (D2). In Eq. (D7), we simplify the notation of the sequential products from  $l = 1$  to  $L$  with the same form, using the arrow to denote the ascending direction of the dummy index  $l$ . On the other hand, the Hermitian conjugation of  $S_1(x)$  is,

$$S_1(x)^\dagger = \prod_{l=L}^1 e^{ixH_l} = e^{ixH_1} e^{ixH_2} \dots e^{ixH_L} =: \overrightarrow{\prod}_{l=L}^1 e^{ix\vec{H}}. \quad (\text{D8})$$

The second-order Trotter formula is

$$\begin{aligned} S_2(x) &= D_2(-x)^\dagger D_2(x) = S_1\left(-\frac{x}{2}\right)^\dagger S_1\left(\frac{x}{2}\right) \\ &= \overrightarrow{\prod}_{l=L} e^{-i\frac{1}{2}x\vec{H}} \overleftarrow{\prod}_{l=1} e^{-i\frac{1}{2}x\vec{H}}, \end{aligned} \quad (\text{D9})$$

where  $D_2(x) := S_1(\frac{x}{2})$ . From Eq. (D9) we have  $S_2(-x)^\dagger = S_2(x)$ .

The general  $2k$ th-order Trotter formula is

$$\begin{aligned} S_{2k}(x) &= D_{2k}(-x)^\dagger D_{2k}(x) \\ &= [S_{2k-2}(u_k x)]^2 S_{2k-2}((1-4u_k)x) [S_{2k-2}(u_k x)]^2, \end{aligned} \quad (\text{D10})$$

with  $u_k := 1/(4 - 4^{1/(2k-1)})$  for  $k \geq 1$ . The operator  $D_{2k}(x)$  is defined recursively,

$$D_{2k}(x) := D_{2k-2}((1-4u_k)x) S_{2k-2}(u_k x)^2. \quad (\text{D11})$$

By induction from Eq. (D10) and Eq. (D11) we can show that  $S_{2k}(-x)^\dagger = S_{2k}(x)$ . The operator  $D_{2k}(x)$  will take the following form,

$$D_{2k}(x) = \overleftarrow{\prod}_{l=1} e^{-iv_\kappa x \vec{H}} \overrightarrow{\prod}_{l=1} e^{-iv_{\kappa-1} x \vec{H}} \dots \overrightarrow{\prod}_{l=2} e^{-iv_2 x \vec{H}} \overleftarrow{\prod}_{l=1} e^{-iv_1 x \vec{H}}, \quad (\text{D12})$$

where  $\kappa = 5^{k-1}$ ,  $\{v_i\}_{i=1}^\kappa$  are positive numbers indicating the segment length, which are determined by Eq. (D10) and Eq. (D11) and satisfy  $\sum_{i=1}^\kappa v_i = \frac{1}{2}$ .

In what follows, we also denote the zeroth-order Trotter formula to be

$$S_0(x) = I, \quad (\text{D13})$$

for consistency. We denote the multiplicative remainder of the Trotter formulas as

$$\begin{aligned} V_0(x) &= U(x), \\ V_1(x) &= U(x) S_1(x)^\dagger, \\ V_{2k}(x) &= U(x) S_{2k}(x)^\dagger. \end{aligned} \quad (\text{D14})$$

In Ref. [8], Suzuki proves the following order condition for the Trotter formulas,

$$S_K(x) = U(x) + \mathcal{O}(x^{K+1}) = e^{-iHx + \mathcal{O}(x^{K+1})}, \quad (\text{D15})$$

for  $K = 1$  or even positive  $K$ . As a result, the remainder  $V_K(x)$  will only contain the terms of  $x^q$  with  $q \geq K + 1$ . We will use the following order condition of Trotter formulas in the later discussion.

**Lemma 1** (Order condition of Trotter formulas, Thm 4 in [14]). *Let  $H$  be an Hermitian operator and  $U(x) := e^{-iHx}$  to be the time-evolution operator with  $x \in \mathbb{R}$ . For the Trotter formula  $S_K(x)$  defined in Eq. Eq. (D7) and Eq. (D10), where  $K = 1$  or positive even number, we have*

1. Additive error:  $A_K(x) := S_K(x) - U(x) = \mathcal{O}(x^{K+1})$ ,
2. Multiplicative error:  $M_K(x) := U(x)S_K(x)^\dagger - I = \mathcal{O}(x^{K+1})$ ,
3. For the exponentiated error  $E_K(x)$  such that  $S_K(x) = \mathcal{T} \exp(\int_0^x d\tau (-iH + E_K(\tau)))$ , we have  $E_K(x) = \mathcal{O}(x^K)$ .

## 2. Linear combination of unitaries

Instead of decomposing  $U(x)$  as a product of elementary unitaries, another way is to decompose  $U(x)$  to a summation of elementary unitaries. We now provide a formal definition of a LCU formula.

**Definition 1** ([20]). A  $(\mu, \varepsilon)$ -linear-combination-of-unitary (LCU) formula of an operator  $V$  is defined to be

$$\tilde{V} = \sum_{i=0}^{\Gamma-1} c_i V_i = \mu \sum_{i=0}^{\Gamma-1} \text{Pr}(i) V_i, \quad (\text{D16})$$

such that the spectral norm distance  $\|V - \tilde{V}\| \leq \varepsilon$ . Here,  $\mu > 0$  is the  $l_1$ -norm of the coefficient vector,  $\text{Pr}(i)$  is a probability distribution over different unitaries  $U_i$ , and  $\{U_i\}_{i=0}^{\Gamma-1}$  is a group of unitaries. Here, we assume  $c_i > 0$  for all  $i$  and absorb the phase into the unitaries  $V_i$ . We call  $\mu$  the 1-norm of this  $(\mu, \varepsilon)$ -LCU formula. Moreover, we define the 1-norm  $\|V\|_1$  of an operator  $V$  to be its smallest 1-norm over all possible  $(\mu, 0)$ -LCU formulas for  $V$ .

Following the 1-norm definition in Definition 1, we know that  $\|U\|_1 = 1$  for any given unitary  $U$ . Also, it is easy to verify that this 1-norm definition satisfies the following properties,

$$\begin{aligned} \|V\|_1 &\geq 0, \\ \|V\|_1 &= 0 \Leftrightarrow V = 0, \\ \|\alpha V\|_1 &= |\alpha| \|V\|_1, \\ \|V + W\|_1 &\leq \|V\|_1 + \|W\|_1, \\ \|VW\|_1 &\leq \|V\|_1 \|W\|_1, \end{aligned} \quad (\text{D17})$$

for all operators  $V$  and  $W$ . Therefore,  $\|V\|_1$  in Definition 1 is indeed a well-defined matrix norm.

In this work, we will discuss two ways to implement the LCU formula, shown in Fig. 3. The first way is to use it in a random-sampling style. In this case, we are not able to implement the target unitary  $U$  deterministically. Instead, we focus on estimating the observable values  $\text{Tr}(U\rho U^\dagger O)$ . The second way is to implement it coherently. In this case, we can implement  $U$  and prepare the target state.

We now introduce these two LCU implementation methods in detail. The usage of random-sampling implementation is introduced in Fig. 4 in detail. We first prepare the  $|+\rangle = \frac{1}{\sqrt{2}}(|0\rangle + |1\rangle)$  state on the ancillary qubit  $A$ , using it to perform controlled operations

$$\begin{aligned} &|0\rangle_A \langle 0| \otimes I_B + |1\rangle_B \langle 1| \otimes (U_i)_B, \\ &|0\rangle_A \langle 0| \otimes (U_j)_B + |1\rangle_B \langle 1| \otimes I_B, \end{aligned} \quad (\text{D18})$$

where  $B$  is the target system,  $U_i$  and  $U_j$  are independently sampled based on the LCU formula in Definition 1. If we want to estimate  $\text{Tr}(U\rho U^\dagger O)$  for a given observable  $O$ , then we directly measure  $\mu^2 X_A \otimes O_B$  whose expectation value is  $\text{Tr}(\tilde{U}\rho\tilde{U}^\dagger O)$  [24]. If we want to learn many observables efficiently, we can adopt the shadow estimation circuit [34] where a random unitary  $V \in \mathbb{G}$  is performed, followed by a computational basis measurement.  $\mathbb{G}$  is a tomographic-complete unitary set. Based on the measurement values  $a, \vec{z}$  and the unitary information  $V$ , we can generate a matrix-valued estimator  $\hat{\sigma}$  for the target state  $\sigma = U\rho U^\dagger$ ,

$$\hat{\sigma} = \mu^2 (-1)^a \mathcal{M}^{-1}(V^\dagger |\vec{z}\rangle \langle \vec{z}| V). \quad (\text{D19})$$

Here,  $\mathcal{M}$  is an invertible linear map determined by  $\mathbb{G}$ ,

$$\mathcal{M}(O) = \mathbb{E}_{V \in \mathbb{G}} \sum_{\vec{z} \in \mathbb{Z}_2^n} \langle \vec{z}| V O V^\dagger |\vec{z}\rangle V^\dagger |\vec{z}\rangle \langle \vec{z}| V. \quad (\text{D20})$$

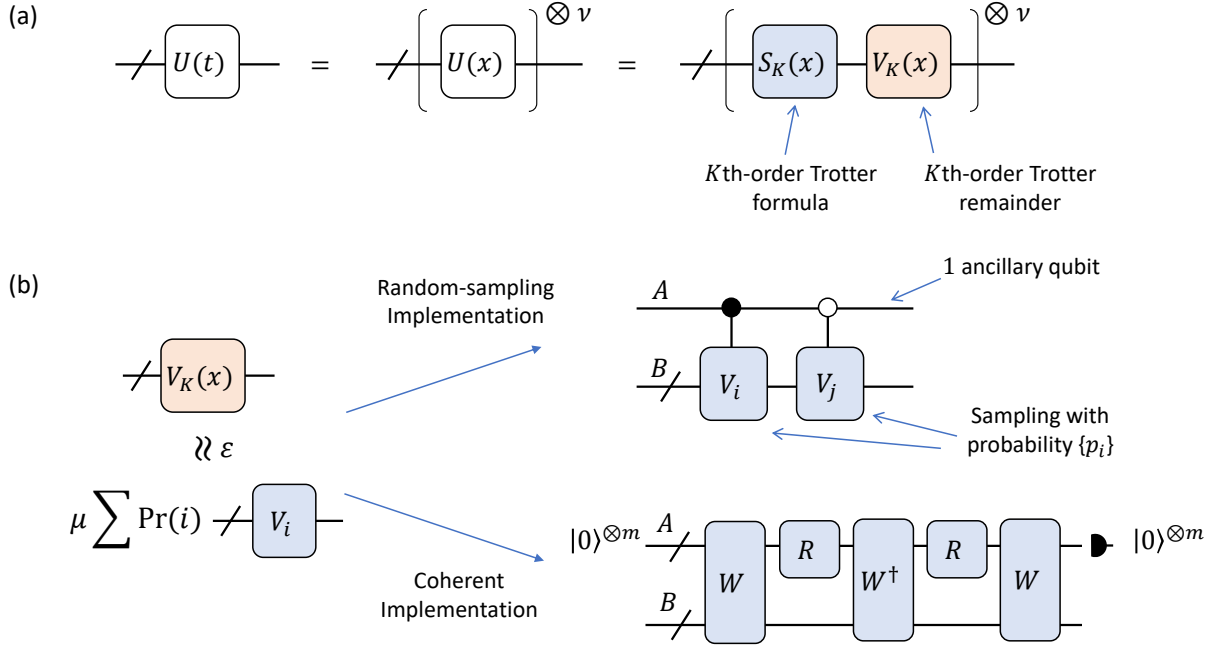

FIG. 3. Schematic diagram for the Trotter-LCU algorithms. (a) We first split the real-time evolution  $U(t)$  to  $\nu$  segments, each with evolution time  $x = t/\nu$ . For each segment, we first implement  $K$ th-order Trotter formula ( $K = 0, 1, 2k, k \in \mathbb{N}_+$ ). Then, we compensate the Trotter remainder  $V_K(x)$  using LCU formula. (b) For a  $(\mu, \varepsilon)$ -LCU formula, we consider two different implementations. For the random-sampling implementation, we implement the controlled- $V_i$  gate where  $V_i$  is sampled based on the probability distribution  $p_i$ . For the coherent implementation, we use three LCU implementation gates  $W$  (or  $W^\dagger$ ) defined in Eq. (D37) and two reflection gates  $R$  defined in Eq. (D40). We need  $m := \lceil \log_2 \Gamma \rceil$  qubits, where  $\Gamma$  is the number of elementary unitaries in the LCU formula.

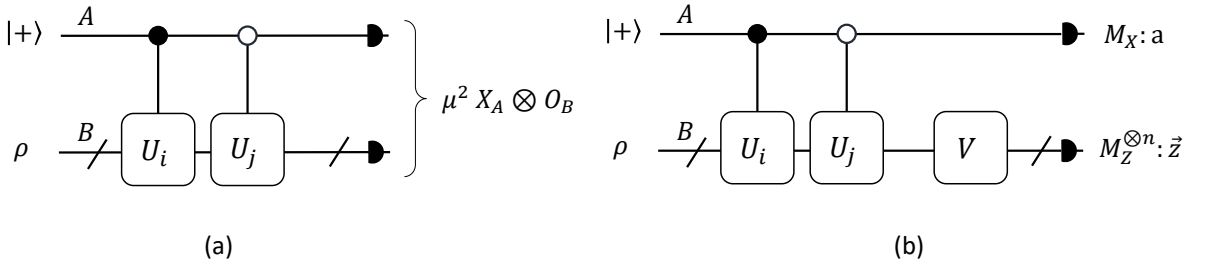

FIG. 4. Random-sampling implementation of Hamiltonian simulation based on  $(\mu, \varepsilon)$ -LCU formula in Definition 1.  $B$  is the original system and  $A$  is an extra ancillary qubit.  $U_i$  and  $U_j$  are independently sampled based on the random sampling LCU formula. (a) Estimation circuit for the expectation value  $\text{Tr}[U\rho U^\dagger O]$  of the given observable  $O$  [24]. (b) Circuit to generate the matrix estimator for the target state  $\sigma = U\rho U^\dagger$ , which can be used to learn many observables efficiently [34].  $V$  is a random unitary chosen from a preset tomographically-complete set  $\mathbb{G}$ . The estimator for  $\sigma$  is  $\hat{\sigma} = \mu^2 (-1)^a \mathcal{M}^{-1}(V^\dagger |\vec{z}\rangle \langle \vec{z}| V)$ .

Using the circuit in Fig. 4(b), we can learn the information in the target state  $\sigma$  with extra sample cost of  $\mu^2$ . As long as  $\mu$  is a constant with respect to  $t$  and  $\varepsilon$ , the sample complexity of the Hamiltonian simulation based on random sampling will be the same as the case when we prepare the target state  $\sigma$  by implementing  $U(t)$  on  $\rho$ . One can refer to Ref. [34] for more details.

For simplicity, we will focus on the estimation of a single observable  $O$  in this work. Once we have a  $(\mu, \varepsilon)$ -LCU formula, we can estimate  $\text{Tr}(U\rho U^\dagger O)$  with the following performance guarantee.

**Proposition 1** (Performance of the random-sampling LCU implementation (c.f., Theorem 2 in [24])). *For a target unitary  $U$  and its  $(\mu, \varepsilon)$ -LCU formula defined in Definition 1, if we estimate the value  $\langle O \rangle_U := \text{Tr}(U\rho U^\dagger O)$  with an initial state  $\rho$  and observable  $O$  using the circuit in Fig. 4(a) for  $N$  times, then the distance between the mean*

estimator value  $\hat{O}$  and the true value  $\langle O \rangle_U$  is bounded by

$$|\hat{O} - \langle O \rangle_U| \leq \|O\|(3\varepsilon + \varepsilon_n), \quad (\text{D21})$$

with successful probability  $1 - \delta$ . Here,  $N = 2\mu^4 \ln(2/\delta)/\varepsilon_n^2$ ,  $\|O\|$  is the spectral norm of  $O$ .

*Proof.* We first study the estimation bias, i.e., the distance between the expectation value  $\bar{O}$  and the target value  $\langle O \rangle_U$ . For a specific choice of  $U_i$  and  $U_j$  in Fig. 4(a), the expectation value of the observable  $\mu^2 \langle X_A \otimes O_B \rangle$  is

$$\bar{O}_{i,j} = \frac{\mu^2}{2} \left( \text{Tr}(U_i \rho U_j^\dagger O) + \text{Tr}(U_j \rho U_i^\dagger O) \right). \quad (\text{D22})$$

If we randomly sample  $U_i$  and  $U_j$  independently in Fig. 4(a), then based on the LCU formula in Eq. (D16), the expectation value is then

$$\bar{O} := \mathbb{E}_{i,j} \bar{O}_{i,j} = \text{Tr}(\tilde{U} \rho \tilde{U}^\dagger O). \quad (\text{D23})$$

We can bound the distance between  $\bar{O}$  and  $\langle O \rangle_U$  by

$$\begin{aligned} |\bar{O} - \langle O \rangle_U| &= |\text{Tr}(\tilde{U} \rho \tilde{U}^\dagger O) - \text{Tr}(U \rho U^\dagger O)| \\ &\leq |\text{Tr}(\tilde{U} \rho \tilde{U}^\dagger O) - \text{Tr}(\tilde{U} \rho U^\dagger O)| + |\text{Tr}(\tilde{U} \rho U^\dagger O) - \text{Tr}(U \rho U^\dagger O)| \\ &= |\text{Tr}[O \tilde{U} \rho (\tilde{U} - U)^\dagger]| + |\text{Tr}[(\tilde{U} - U) \rho U^\dagger O]| \\ &\leq (1 + \varepsilon) \varepsilon \|O\| + \varepsilon \|O\| \\ &\leq 3\varepsilon \|O\|. \end{aligned} \quad (\text{D24})$$

In the forth line, we use the fact that  $\|\rho\| \leq 1$ ,  $\|U\| \leq 1$ , and  $\|\tilde{U}\| \leq \|U\| + \|U - \tilde{U}\| \leq 1 + \varepsilon$ .

Now, we study the statistical error caused by finite  $N$ . The measured value  $\hat{O}_i$  of the observable  $\mu^2 X \otimes O$  is in the range of  $[-\mu^2 \|O\|, \mu^2 \|O\|]$ . Using the Hoeffding bound in Lemma 6, we have the following probability tail bound for the mean estimator  $\hat{O} := \frac{1}{N} \sum_{i=1}^N \hat{O}_i$ ,

$$\Pr\left(|\hat{O} - \bar{O}| \geq \varepsilon_n \|O\|\right) \leq 2 \exp\left(-\frac{2N\varepsilon_n^2}{4\mu^4}\right). \quad (\text{D25})$$

Combining Eq. (D24) and Eq. (D25) and setting  $N := 2\mu^4 \ln(2/\delta)/\varepsilon_n^2$ , we have

$$|\hat{O} - \langle O \rangle_U| \leq |\bar{O} - \langle O \rangle_U| + |\hat{O} - \bar{O}| = \|O\|(3\varepsilon + \varepsilon_n), \quad (\text{D26})$$

with successful probability  $1 - \delta$ . □

From Proposition 1 we can see that, the 1-norm  $\mu$  of the LCU formula affects the sample complexity while the accuracy factor  $\varepsilon$  introduce extra bias in the observable estimation.

In the later discussion, we will come up with the product of LCU formulas. We will use following proposition.

**Proposition 2** (Product of LCU formulas). *Suppose we have a  $(\mu, \varepsilon)$ -LCU formula  $\tilde{U}$  for a unitary  $U$ , i.e.,*

$$\tilde{U} = \mu \sum_i \Pr(i) U_i, \quad (\text{D27})$$

with  $\|U - \tilde{U}\| \leq \varepsilon$ .

Then the product formula

$$\tilde{U}^\nu = \mu^\nu \sum_{i_1, i_2, \dots, i_\nu} \Pr(i_1) \Pr(i_2) \dots \Pr(i_\nu) U_{i_1} U_{i_2} \dots U_{i_\nu}, \quad \nu \in \mathbb{N}, \quad (\text{D28})$$

is a  $(\mu', \varepsilon')$ -LCU formula for  $U^\nu$  with

$$\begin{aligned} \mu' &= \mu^\nu, \\ \varepsilon' &\leq \nu \mu' \varepsilon. \end{aligned} \quad (\text{D29})$$

*Proof.* The 1-norm is obvious. We now bound the distance  $\varepsilon'$  between  $\tilde{U}^\nu$  and  $U^\nu$ .

$$\begin{aligned}
\|U^\nu - \tilde{U}^\nu\| &= \left\| \sum_{k=1}^{\nu} U^{k-1} (U - \tilde{U}) \tilde{U}^{\nu-k} \right\| \\
&\leq \sum_{k=1}^{\nu} \|U^{k-1}\| \|U - \tilde{U}\| \|\tilde{U}^{\nu-k}\| \\
&\leq \nu \|U - \tilde{U}\| \sum_{k=1}^{\nu} \max\{\|U\|, \|\tilde{U}\|\}^{\nu-1} \\
&\leq \nu \varepsilon \mu^{\nu-1} \\
&\leq \nu \mu' \varepsilon.
\end{aligned} \tag{D30}$$

□

Finally, we remark that, when there are deterministic components in the LCU formula, we can then simplify the random-sampling implementation by removing the controlled operation on the deterministic components. Suppose we have the following LCU formula for an operator  $V$ ,

$$\tilde{V} = \mu \sum_{i_1, i_2, \dots, i_\nu} \Pr(i_1, i_2, \dots, i_\nu) V_{i_\nu} W_\nu \dots V_{i_2} W_2 V_{i_1} W_1, \tag{D31}$$

such that  $\|V - \tilde{V}\| \leq \varepsilon$ , where  $W_1, W_2, \dots, W_\nu$  are some fixed unitaries. Then according to Definition 1, Eq. (D31) is a  $(\mu, \varepsilon)$ -LCU formula of  $V$  with the elementary unitaries to be  $V_{\vec{i}} = V_{i_\nu} W_\nu \dots V_{i_2} W_2 V_{i_1} W_1$  for  $\vec{i} = \{i_1, i_2, \dots, i_\nu\}$ . Instead of naively apply the Hadamard test circuit in Fig. 4(a), where we need to apply the controlled version of  $V_{\vec{i}}$  twice, we can improve the circuit implementation shown in Fig. 5(c). The composite unitary realized by the circuit in Fig. 5(c) is

$$\begin{aligned}
&\prod_{a=1}^{\nu} (|0\rangle_A \langle 0| \otimes (V_{j_a})_B + |1\rangle_A \langle 1| \otimes I_B) (|0\rangle_A \langle 0| \otimes I_B + |1\rangle_A \langle 1| \otimes (V_{i_a})_B) (I_A \otimes (W_a)_B) \\
&= \prod_{a=1}^{\nu} (|0\rangle_A \langle 0| \otimes (V_{j_a} W_a)_B + |1\rangle_A \langle 1| \otimes (V_{i_a} W_a)_B) \\
&= |0\rangle_A \langle 0| \otimes (V_{j_\nu} W_\nu \dots V_{j_1} W_1)_B + |1\rangle_A \langle 1| \otimes (V_{i_\nu} W_\nu \dots V_{i_1} W_1)_B,
\end{aligned} \tag{D32}$$

which is the same as the unitary realized in Fig. 5(b). As a result, these two implementation are equivalent. The performance guarantee in Proposition 1 also holds for the improved implementation.

The gate complexity of the random-sampling implementation of the Trotter-LCU algorithm is determined by the segment number  $\nu$ , Trotter order  $K$  and the gate complexity of each elementary gate in the LCU formula. As shown in Fig. 3, to construct controlled- $U(t)$ , we split it to  $\nu$  segments. In each segment, we need to implement  $K$ th-order Trotter circuits and LCU circuits. The gate complexity of each elementary gate in the LCU circuit is determined by the truncation order  $s_c$  of the Taylor-series compensation. Therefore, the gate complexity of the overall algorithm using  $K$ th Trotter formula ( $K = 0, 1, 2k$ ) is given by

$$N_K^{(RS)} = \mathcal{O}(\nu(\kappa_K L + s_c)) \tag{D33}$$

where

$$\kappa_K = \begin{cases} 0, & K = 0, \\ 1, & K = 1, \\ 2 \cdot 5^{K/2-1}, & K = 2k, k \in \mathbb{N}_+. \end{cases} \tag{D34}$$

The second way to implement LCU formula is to use it coherently. To this end, we need to introduce an ancillary system  $A$  with the dimension  $\Gamma$  which costs  $\lceil \log_2 \Gamma \rceil$  qubits. For the LCU lemma defined in Eq. (D16), we define the amplitude-encoding unitary  $U_{AE}$  (also called the state-preparation unitary) to be,

$$U_{AE} |0\rangle_A := \sum_{i=0}^{\Gamma-1} \sqrt{\Pr(i)} |i\rangle, \tag{D35}$$

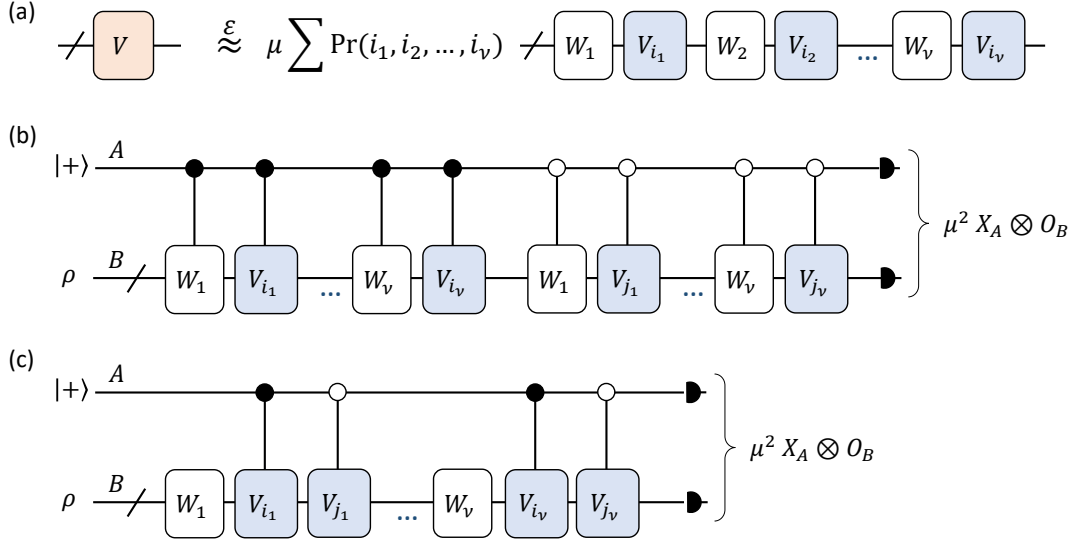

FIG. 5. Improve the random-sampling implementation of Hamiltonian simulation based on  $(\mu, \varepsilon)$ -LCU formula in Eq. (D31). (a) The LCU formula of  $V$  in Eq. (D31) with deterministic components. (b) The naive application of Hadamard test using the circuit in Fig. 4(a). Here, we need to apply the controlled version of the whole elementary  $V_i := V_{i_2}W_2V_{i_1}W_1$  twice. (c) The improved application of Hadamard test. We remove the control on the deterministic unitaries and apply them only once.

and the select gate to be

$$\text{Sel}(\tilde{V}) := \sum_{i=0}^{\Gamma-1} |i\rangle \langle i| \otimes V_i. \quad (\text{D36})$$

Then, the following controlled-gate  $W_{AB}$  acting on ancillary  $A$  and system  $B$  defines a way to realize LCU coherently when we prepare  $|0\rangle$  on  $A$  and measure it on computational basis to get  $|0\rangle$ ,

$$W := (U_{AE}^\dagger \otimes I) \text{Sel}(\tilde{V}) (U_{AE} \otimes I). \quad (\text{D37})$$

More precisely, if we set the initial state on  $B$  to be  $|\psi\rangle$ , then we have

$$W |0\rangle_A |\psi\rangle_B = \frac{1}{\mu} |0\rangle_A (\tilde{V} |\psi\rangle)_B + \sqrt{1 - \frac{1}{\mu^2}} |\Phi_\perp\rangle_{AB}, \quad (\text{D38})$$

where  $|\Phi_\perp\rangle_{AB}$  is a state whose ancillary state is supported in the subspace orthogonal to  $|0\rangle$ .

If we perform computation-basis measurement directly on  $A$ , the successful probability to obtain  $\tilde{V} |\psi\rangle$  is  $\frac{1}{\mu^2}$ . To boost the successful probability to nearly deterministic, we can introduce the amplitude amplification techniques [16]. To this end, we consider the following isometry

$$\mathcal{V} := -WRW^\dagger RW (|0\rangle \otimes I)_{AB}. \quad (\text{D39})$$

Here,  $R$  is a reflection over  $|0\rangle$  on the system  $A$ ,

$$R = I - 2|0\rangle_A \langle 0|. \quad (\text{D40})$$

In what follows, we set  $\mu = 2$  for simplicity. If  $\tilde{V}$  is a unitary, then we have  $(\langle 0| \otimes I) \mathcal{V} = \tilde{V}$ . For a general  $\tilde{V}$ , we can verify that

$$(\langle 0| \otimes I) \mathcal{V} = \frac{3}{\mu} \tilde{V} - \frac{4}{\mu^3} \tilde{V} \tilde{V}^\dagger \tilde{V} = \frac{3}{2} \tilde{V} - \frac{1}{2} \tilde{V} \tilde{V}^\dagger \tilde{V}. \quad (\text{D41})$$

It can be proven that [32], when  $\varepsilon$  is small, the distance between the resulting operator  $\frac{3}{2} \tilde{V} - \frac{1}{2} \tilde{V} \tilde{V}^\dagger \tilde{V}$  will be closed to the ideal unitary  $V$ ,

$$\left\| \frac{3}{2} \tilde{V} - \frac{1}{2} \tilde{V} \tilde{V}^\dagger \tilde{V} - V \right\| \leq \frac{\varepsilon^2 + 3\varepsilon + 4}{2} \varepsilon. \quad (\text{D42})$$



Also, when  $\varepsilon$  is small, then the successful probability to project the ancilla to  $|0\rangle$  is high and the resulting operator will be closed to  $V$ . We will use the following performance bound.

**Lemma 2** (Performance of coherent LCU implementation [32]). *For a target unitary  $U$  and its  $(2, \varepsilon)$ -LCU formula defined in Definition 1, if we implement the LCU based on the isometry  $\mathcal{V}$  defined in Eq. (D39), then if we measure the ancillary system  $A$  on the computational basis and obtain  $|0\rangle_A$ , then the distance between implemented operation and the target unitary  $U$  is bounded by*

$$\|((\langle 0| \otimes I)\mathcal{V} - U)\| \leq \xi. \quad (\text{D43})$$

The successful probability to obtain  $|0\rangle_A$  is larger than  $(1 - \xi)^2$ . Here,

$$\xi := \frac{\varepsilon^2 + 3\varepsilon + 4}{2}\varepsilon. \quad (\text{D44})$$

In practice, it is not always possible to get a LCU formula for a given  $U$  with  $\mu = 2$ . When we have a LCU formula with  $\mu < 2$ , we can always introduce an extra ancillary qubit  $A'$  and apply a rotation

$$R(\mu) |0\rangle = \frac{\mu}{2} |0\rangle + \sqrt{1 - \frac{\mu^2}{4}} |1\rangle. \quad (\text{D45})$$

Together with the unitary operator  $W$  on  $A$  and  $B$ , the composite operation have the effect

$$\begin{aligned} & R(\mu)_{A'} \otimes W_{AB} |00\rangle_{AA'} |\psi\rangle_B \\ &= \frac{1}{2} |00\rangle_{A'A} \tilde{V} |\psi\rangle_B + \frac{\sqrt{3}}{2} |\Phi'\rangle_{A'AB}. \end{aligned} \quad (\text{D46})$$

As a result, we can treat  $R(\mu)_{A'} \otimes W_{AB}$  as the new  $W$  operator to apply the amplitude amplification using the same method introduced above.

When  $\mu > 2$  for a LCU formula, we can split the target unitary  $U$  to several segments to reduce  $\mu$ . For example, for the time evolution  $U(t)$ , we can split it to  $\nu$  segments  $U(x)^\nu$  so that  $\mu \leq 2$  for each segment. In this case, suppose we implement  $(\mu, \varepsilon)$ -LCU formula for each segment, the overall accuracy is  $\nu\xi$  and the successful probability is  $(1 - \nu\xi)^2$  where  $\xi$  is defined in Eq. (D44). This can be proven by simply modifying Lemma 2 and utilize triangle inequalities.

**Corollary 1** (Coherent LCU implementation with segments, Theorem G. 5 in [32]). *Suppose we have a  $(\mu, \varepsilon)$ -LCU formula  $\tilde{U}$  for a unitary  $U$  with  $\mu \leq 2$ . Suppose we want to implement  $U^\nu$  where  $\nu$  is a positive integer. If we implement the LCU of  $U$  based on the isometry  $\mathcal{V}$  defined in Eq. (D39) for  $\nu$  times, then*

$$\|(((\langle 0| \otimes I)\mathcal{V})^\nu - U^\nu)\| \leq \nu\xi. \quad (\text{D47})$$

The successful probability to obtain  $|0\rangle_A$  for all segments is larger than  $(1 - \nu\xi)^2$ . Here,  $\xi$  is defined in Eq. (D44).

The gate complexity of the coherent implementation of the Trotter-LCU algorithm is determined by the segment number  $\nu$ , the Trotter order  $K$ , the number of elementary unitaries  $\Gamma$  and the gate complexity of each elementary unitary in the LCU formula. The value  $\Gamma$  is related to the specific compensation method we use, which is usually proportional to  $L$  and the truncation order  $s_c$ . The gate complexity is

$$N_K^{(C)} = \mathcal{O}(\nu(\kappa_K L + \Gamma)), \quad (\text{D48})$$

Although we split the evolution  $U(t)$  into  $\nu$  segments in both random-sampling and coherent implementation, they follow different analysis procedures. We summarize and compare their analysis procedure in Fig. 6. In the random-sampling implementation, we first obtain an overall  $(\mu_{tot}, \varepsilon_{tot})$ -LCU formula for the whole time evolution  $U(t)$  based on Proposition 2, then analyze the performance based on Proposition 1 and optimize the value of  $\nu$ . As a comparison, in the coherent implementation, we first find proper  $x$  value so that we can construct a LCU formula with  $\mu = 2$ . After that, we calculate the segment number  $\nu = t/x$  and analyze the performance directly based on Corollary 1. Even starting with the same LCU formula for a given segment, the different analysis will yield different performance for these two implementation methods.

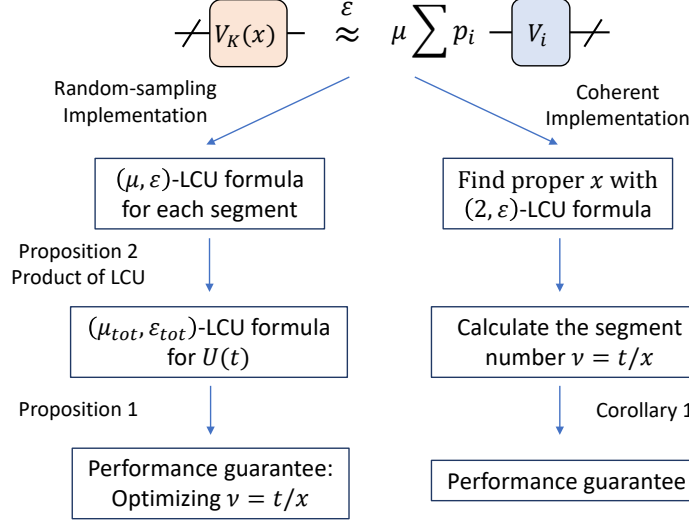

FIG. 6. Comparison of the performance analysis based on random-sampling and coherent implementation.

### 3. Construct LCU formulas for Trotter remainders

The construction of LCU formulas for the Trotter remainder  $V_K(x)$  is at the core of the implementation and performance of the Trotter-LCU algorithms. We need to consider the following requirements for the LCU formulas,

1. The LCU formula should be able to achieve a high accuracy (i.e., a small  $\varepsilon$ ) with few terms.
2. For the random-sampling implementation, the 1-norm  $\mu$  of the LCU formula should be as small as possible.
3. For the coherent implementation, the number of elementary unitaries  $\Gamma$  in the LCU formula should be as small as possible.

In this section, we summarize the major idea of three different methods to construct LCU formulas for  $V_K(x)$ , illustrated in Fig. 7. We mainly consider different realizations of Taylor-series compensation [17]. This promises us to achieve a high simulation accuracy  $\varepsilon$  with few terms.

For simplicity, let us now assume that the Hamiltonian can be written as  $H = H_1 + H_2$ , where  $H_1$  and  $H_2$  are two Hermitian operators with known  $(\mu_1, 0)$ - and  $(\mu_2, 0)$ -LCU decomposition with Pauli operators, respectively,

$$\begin{aligned} H_1 &= \mu_1 U_1 := \mu_1 \sum_i q_1^{(i)} P_1^{(i)}, \\ H_2 &= \mu_2 U_2 := \mu_2 \sum_i q_2^{(i)} P_2^{(i)}, \end{aligned} \tag{D49}$$

where  $\{q_1^{(i)}\}_i$  and  $\{q_2^{(i)}\}_i$  are two probability distributions;  $\{P_1^{(i)}\}_i$  and  $\{P_2^{(i)}\}_i$  are two groups of Pauli operators. We denote  $\lambda := \mu_1 + \mu_2$ . Therefore,

$$H = \lambda(p_1 U_1 + p_2 U_2) = \lambda \sum_{l=1,2} p_l \sum_i q_l^{(i)} P_l^{(i)}, \tag{D50}$$

which is a  $(\lambda, 0)$ -LCU formula of  $H$ . Here,  $p_l := \mu_l/\lambda$ .

For the time being, we also assume that  $e^{ixH_1}$  and  $e^{ixH_2}$  can be easily implemented for any  $x \in \mathbb{R}$ . We are going to implement the time-evolution operator

$$U(x) = e^{-ixH} = e^{-ix(H_1+H_2)}. \tag{D51}$$

We now summarized the main idea of the three methods to construct LCU formulas based on Taylor-series compensation. We will take the lowest nontrivial Trotter order in each case as simple examples.

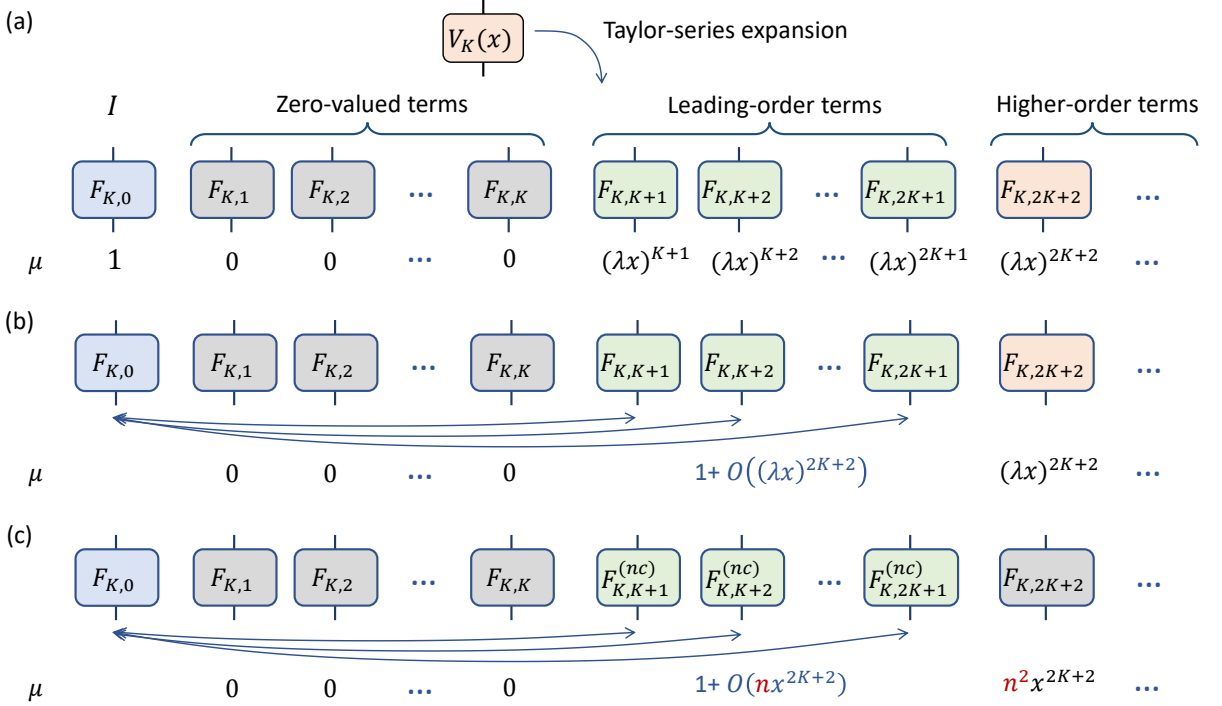

FIG. 7. Ideas behind three different methods used for LCU formula construction of  $V_K(x)$ . ( $K = 1$  or  $2k$ ,  $k \in \mathbb{N}_+$ .) (a) In the direct Taylor-series compensation, we expand all the exponential terms in  $V_K(x)$  independently using Taylor-series expansion. We remove the 1st- to  $K$ th-order expansion terms based on the order condition of the Trotter formula to reduce the 1-norm to the order  $\mathcal{O}(1 + (\lambda x)^{K+1})$ . (b) In the paired Taylor-series compensation, we use the fact that the leading-order expansion terms  $F_{K,K+1}$  to  $F_{K,2K+1}$  are all anti-Hermitian. Therefore, we pair the 0th-order term with leading order terms using Euler's formula to construct the Pauli rotation unitaries. This can further suppress the 1-norm of LCU formula to  $\mathcal{O}(1 + (\lambda x)^{2K+2})$ . (c) In the nested-commutator compensation, we expand the Trotter error with the nested-commutator form. In this way, we reduce the number of elementary unitaries in the LCU formula. For the lattice model, the number of unitaries terms in the leading order will be linear to  $n$ .

1. Direct Taylor-series compensation (Sec. E). Since  $V_K(x)$  is a product of exponential terms, we can expand all the exponential terms in  $V_K(x)$  independently by Taylor-series compensation. We then expand the polynomials and classify the terms  $F_{K,s}(x)$  based on the power of  $x$ . Afterwards, we consider the order condition of Trotter formulas in Lemma 1 to eliminate the first  $K$  non-identity terms in  $V_K(x)$  with respect to the power of  $x$ . This will provide a LCU formula of  $V_K(x)$ .

We take the first-order Trotter remainder as an example. The 1st-order Trotter formula and its remainder are

$$\begin{aligned} S_1(x) &= e^{-ixH_2} e^{-ixH_1}, \\ V_1(x) &= U(x) V_1^\dagger(x) = e^{-ix(H_1+H_2)} e^{ixH_1} e^{ixH_2}. \end{aligned} \quad (\text{D52})$$

Now, we expand all the exponential terms independently in  $V_1(x)$  by Taylor series,

$$\begin{aligned} V_1(x) &= \sum_{r=0}^{\infty} \frac{(-ix)^r}{r!} (H_1 + H_2)^r \sum_{r_1=0}^{\infty} \frac{(ix)^{r_1}}{r_1!} H_1^{r_1} \sum_{r_2=0}^{\infty} \frac{(ix)^{r_2}}{r_2!} H_2^{r_2} \\ &= e^{2\lambda x} \sum_{r:r_1,r_2} \text{Poi}(r, r_1, r_2; \lambda x, \mu_1 x, \mu_2 x) (-i)^{r-r_1-r_2} \left( \sum_{l=1,2} p_l U_l \right)^r U_1^{r_1} U_2^{r_2}, \end{aligned} \quad (\text{D53})$$

which is a LCU formula with the 1-norm  $e^{2\lambda x}$ . Here,  $\text{Poi}(r; x) := e^{-x} \frac{x^r}{r!}$  is the Poisson distribution. We also denote the multiplication of Poisson distribution as,

$$\text{Poi}(r_1, r_2, \dots, r_l; x_1, x_2, \dots, x_l) := \text{Poi}(r_1; x_1) \text{Poi}(r_2; x_2) \dots \text{Poi}(r_l; x_l). \quad (\text{D54})$$

We now expand  $V_1(x)$  and classify all the terms based on power of  $x$ ,

$$V_1(x) = \sum_{s=0}^{\infty} F_{1,s}(x), \quad (D55)$$

$$F_{1,s}(x) = \sum_{\substack{r,r_1,r_2 \\ r+r_1+r_2=s}} \frac{(-ix)^r (ix)^{r_1} (ix)^{r_2}}{r!r_1!r_2!} (H_1 + H_2)^r H_1^{r_1} H_2^{r_2}.$$

The formula of  $F_{1,s}(x)$  in Eq. (D55) is a LCU formula with 1-norm  $\frac{(2\lambda x)^s}{s!}$ .

To suppress the 1-norm of  $V_2(x)$  in Eq. (D53), we are going to utilize the order condition of the Trotter formula in Lemma 1. We then have

$$F_{1,1}(x) = 0. \quad (D56)$$

The final LCU formula under direct Taylor-series compensation is then,

$$V_1(x) = I + \sum_{s=2}^{\infty} F_{1,s}(x), \quad (D57)$$

whose 1-norm is upper bounded by  $e^{(2\lambda x)^2}$ , as proven in Proposition 4.

The higher-order direct Taylor-series compensation follows the same logic. The difference is that, we are able to eliminate more terms based on the order condition of the Trotter formula. For a general  $K$ th-order Trotter remainder, from Lemma 1 we have

$$F_{K,1}(x) = \dots = F_{K,K}(x). \quad (D58)$$

This will help to further suppress the 1-norm of the LCU formula.

2. Paired Taylor-series compensation (Sec. F). If we carefully check the Taylor-series expansion formula for  $V_1(x)$  in Eq. (D57), we notice that  $F_{1,2}(x)$  and  $F_{1,3}(x)$  are both anti-Hermitian. This is clear from the exponential form of  $V_1(x)$ ,

$$V_1(x) = \exp(i(E_{1,2}x^2 + E_{1,3}x^3 + E_{1,4}x^4 + \dots)), \quad (D59)$$

where  $\{E_{1,s}\}$  are some Hermitian operators which can be obtained by applying the Baker-Campbell-Hausdorff (BCH) formula on the definition of  $V_1(x)$  in Eq. (D52). The first order term  $E_{1,1}$  vanishes due to the order condition in Lemma 4. We have

$$F_{1,2}(x) = ix^2 E_{1,2} = ix^2 \lambda_{1,2} \sum_j p_{1,2}^{(j)} P_{1,2}^{(j)},$$

$$F_{1,3}(x) = ix^3 E_{1,3} = ix^3 \lambda_{1,3} \sum_j p_{1,3}^{(j)} P_{1,3}^{(j)}, \quad (D60)$$

by the Taylor-series expansion on Eq. (D59). Since  $E_{1,2}$  and  $E_{1,3}$  are Hermitian operators, we can naturally expand them by the Hermitian Pauli operators  $\{P_{1,2}^{(j)}\}$  and  $\{P_{1,3}^{(j)}\}$  with real coefficients. Here, we put all the minus signs in the expansion into the Pauli operators.

The major idea of the paired Taylor-series compensation is to take the advantage of the following Euler's formula for Pauli operator  $P$  to further reduce the 1-norm of the LCU formula. For a Pauli matrix  $P$  and  $y \in \mathbb{R}$ ,

$$I + iyP = \sqrt{1 + y^2} e^{i\theta(y)P}, \quad (D61)$$

where  $\theta(y) := \tan^{-1}(y)$ . We can see that, the 1-norm of the formula decrease from  $1 + y$  to  $\sqrt{1 + y^2} \leq 1 + \frac{1}{2}y^2$ , whose  $y$ -order has been doubled.

If we apply Eq. (D61) to the 0th-order term  $I$  and the 2nd-order term  $F_{1,2}(x)$  in Eq. (D60) as an example, we have

$$I + F_{1,2}(x) = \lambda_{1,2} \sum_j p_{1,2}^j (I + ix^2 P_{1,2}^{(j)})$$

$$= \lambda_{1,2} \sqrt{1 + x^2} \sum_j p_{1,2}^j \exp\left(i\theta(x^2) P_{1,2}^{(j)}\right). \quad (D62)$$

After the expansion-order pairing, we can see that the 1-norm becomes  $1 + \mathcal{O}(x^4)$  whose  $x$ -order has been doubled.

In practice, however, it is hard to calculate the explicit form of  $F_{1,2}$  and  $F_{1,3}$  with the Hermitian Pauli operator expansions in general. Fortunately, in Sec. F we show that one can use the LCU formulas of  $F_{1,2}$  and  $F_{1,3}$  with the direct expansion form in Eq. (D55). By introducing some redundant anti-Hermitian operators, we are able to implement the LCU in the random-sampling way with a very simple sampling scheme. We remark that, since the anti-Hermitian operators cannot be directly paired with  $I$ , we intentionally multiply them by an imaginary phase  $i$ . Since the summation of all the anti-Hermitian operators in  $F_{1,2}$  and  $F_{1,3}$  in Eq. (D55) are zeros due to the equivalence of Eq. (D55) and Eq. (D60), the additional phase  $i$  on the anti-Hermitian terms will not affect the correctness of the LCU formula. For the higher-order Trotter with  $K \geq 2$ , we can perform the similar operation to suppress the 1-norm of the LCU formula to  $e^{(e+c_k)(2\lambda x)^{4k+2}}$ , where  $c_k < 0.3$  is a small constant number defined in Eq. (F66).

3. Nested-commutator compensation (Sec. G). In the two methods above, we try to construct the power-series expansion of  $V_K(x)$  by first performing Taylor-series expansion on each exponential term in it and then classify the terms by the power of  $x$ . This is direct and simple, but not optimal, since many terms in this expansion can be cancelled out to further reduce the norm.

One way to further reduce the 1-norm of  $V_2(x)$  is to express the  $s$ th-order term  $F_{2,s}(x)$  using the nested-commutators [13, 14] in the following form,

$$\text{ad}_{H_2}^{m_\kappa} \text{ad}_{H_1}^{n_\kappa} \dots \text{ad}_{H_2}^{m_2} \text{ad}_{H_1}^{n_2} \text{ad}_{H_2}^{m_1} \text{ad}_{H_1}^{n_1} (H_1 + H_2), \quad (\text{D63})$$

where  $\sum_{j=1}^{\kappa} (m_j + n_j) = s$ . For two operators  $P$  and  $Q$ , the adjoint operator  $\text{ad}_P Q$  is defined as

$$\text{ad}_P Q := [P, Q] = PQ - QP. \quad (\text{D64})$$

We also define

$$e^{\text{ad}_P} Q := \sum_{s=0}^{\infty} \frac{1}{s!} \text{ad}_P^s Q = e^P Q e^{-P}. \quad (\text{D65})$$

The last equality is a standard Lie-Algebraic identity.

Here, we take the 1st-order Trotter remainder as an example. From Eq. (D55) we know that the second-order expansion term of  $V_1(x)$  is

$$\begin{aligned} F_{1,2}(x) &:= \sum_{\substack{r, r_1, r_2 \\ r+r_1+r_2=2}} \frac{(-ix)^r (ix)^{r_1} (ix)^{r_2}}{r! r_1! r_2!} (H_1 + H_2)^r H_1^{r_1} H_2^{r_2} \\ &= \frac{(2\lambda x)^2}{2} \sum_{\substack{r, r_1, r_2 \\ r+r_1+r_2=2}} \text{Pr}(r, r_1, r_2) (-i)^{2r-2} \left( \sum_{l=1,2} p_l U_l \right)^r U_1^{r_1} U_2^{r_2}. \end{aligned} \quad (\text{D66})$$

Using Eq. (D66) directly, we obtain a LCU formula of  $F_{1,2}(x)$  with the 1-norm  $(2\lambda x)^2/2$ . However, Eq. (D66) can be reduced to

$$F_{1,2}(x) = -\frac{x^2}{2} [H_1, H_2] = -\frac{x^2}{2} \text{ad}_{H_1} H_2. \quad (\text{D67})$$

In this case, if there are many commuted terms in  $H_1$  and  $H_2$ , the 1-norm of  $F_{1,2}(x)$  can be further suppressed.

In Sec. G, we derive the explicit formulas of  $F_{K,s}$  ( $s = K + 1, \dots, 2K$ ) with the nested commutator form. We show that, for the lattice model Hamiltonian, this will enable the Trotter-LCU algorithms with an almost-linear system size dependence.

### Appendix E: Trotter-LCU formula with direct Taylor-series compensation

We start from the simplest LCU construction method based on direct Taylor-series compensation. We are going to consider the Hamiltonian  $H$  with Pauli decomposition in Eq. (D1),  $H = \sum_{l=1}^L \alpha_l P_l$ . The ideas behind the direct Taylor-series compensation method are

1. Taylor-series expansion on all the exponential terms in  $V_K(x)$  separately.
2. Expanding and recombining the exponential terms based on the power of  $x$ .
3. Eliminate the first  $K$  nonzero  $x$ -order terms based on the order condition in Lemma 1.

### 1. Zeroth-order case

For the zeroth-order case,  $S_0(x) = I$ . The Trotter remainder  $V_0(x)$  is just the real-time evolution itself,

$$V_0(x) = U(x) = e^{-ixH}. \quad (\text{E1})$$

We then expand the remainder by Taylor series,

$$\begin{aligned} V_0(x) &= \sum_{s=0}^{\infty} \frac{(-i\lambda x)^s}{s!} \sum_{l_1, \dots, l_s} p_{l_1} p_{l_2} \dots p_{l_s} P_{l_1} P_{l_2} \dots P_{l_s} \\ &= \sum_{s=0}^{\infty} F_{0,s}(x), \end{aligned} \quad (\text{E2})$$

where

$$F_{0,s}(x) = \frac{(-i\lambda x)^s}{s!} \sum_{l_1, \dots, l_s} p_{l_1} p_{l_2} \dots p_{l_s} P_{l_1} P_{l_2} \dots P_{l_s}. \quad (\text{E3})$$

In practice, to limit the number of gates in  $V_{0,s}$  as well as avoiding sampling over infinitely many integers, we set a truncation integer  $s_c \geq 1$  to the expansion order  $s$ . After this truncation, the approximate LCU formula of  $V_0(x)$  is

$$\tilde{V}_0(x) = \tilde{U}_0(x) = \sum_{s=0}^{s_c} F_{0,s}(x). \quad (\text{E4})$$

The 1-norms of  $F_{0,s}(x)$  and  $\tilde{V}_0(x)$  in Eq. (E3) and Eq. (E4) are

$$\begin{aligned} \|F_{0,s}(x)\|_1 &= \frac{(\lambda x)^s}{s!}, \\ \mu_0(x) &:= \|\tilde{V}_0(x)\|_1 = \sum_{s=0}^{s_c} \|F_{0,s}(x)\|_1 \leq e^{\lambda x} \end{aligned} \quad (\text{E5})$$

We can write  $F_{0,s}(x)$  and  $\tilde{V}_0(x)$  in the normalized form,

$$\begin{aligned} F_{0,s}(x) &= \|F_{0,s}(x)\|_1 V_{0,s}, \\ V_{0,s} &:= (-i)^s \sum_{l_1, \dots, l_s} p_{l_1} p_{l_2} \dots p_{l_s} P_{l_1} P_{l_2} \dots P_{l_s}, \\ \tilde{V}_0(x) &= \mu_0(x) \sum_{s=0}^{s_c} \text{Pr}_0(s) V_{0,s}, \\ \text{Pr}_0(s) &:= \frac{\|F_{0,s}(x)\|_1}{\mu_0(x)}, s = 0, 1, \dots, s_c. \end{aligned} \quad (\text{E6})$$

We have the following proposition to characterize the LCU formula in Eq. (E4).

**Proposition 3** (0th-order Trotter-LCU formula by direct Taylor-series compensation). *For  $x \geq 0$  and  $s_c \geq 1$ ,  $\tilde{V}_0(x)$  in Eq. (E4) is a  $(\mu_0(x), \varepsilon_0(x))$ -LCU formula of  $V_0(x) = U(x)$  with*

$$\begin{aligned} \mu_0(x) &\leq e^{\lambda x}, \\ \varepsilon_0(x) &\leq \left( \frac{e\lambda x}{s_c + 1} \right)^{s_c + 1}. \end{aligned} \quad (\text{E7})$$

*Proof.* Since the 1-norm of  $\tilde{V}_0(x)$  in Eq. (E4) is the same as  $V_{0,s}$  in Eq. (E6), we naturally have  $\mu_0(x) = e^{\lambda x}$ .

For the distance bound, we have

$$\begin{aligned} \|\tilde{V}_0(x) - V_0(x)\| &\leq \sum_{s>s_c} \|F_{0,s}(x)\| \\ &\leq \sum_{s>s_c} \frac{(\lambda x)^s}{s!} \|V_{0,s}(x)\| \\ &\leq \sum_{s>s_c} \frac{(\lambda x)^s}{s!} \\ &\leq \left(\frac{e\lambda x}{s_c+1}\right)^{s_c+1}. \end{aligned} \tag{E8}$$

In the second inequality, we use the fact that

$$\|V_{0,s}\| \leq \sum_{l_1, l_2, \dots, l_s} p_{l_1} p_{l_2} \dots p_{l_s} \|(-i)^s P_{l_1} P_{l_2} \dots P_{l_s}\| \leq 1. \tag{E9}$$

In the fourth line of Eq. (E8), we apply Corollary 2 in Appendix K.  $\square$

Now, we consider the Trotter-LCU formula  $\tilde{U}_0(x)$  in Eq. (E4) for both random-sampling and coherent usages.

For the random-sampling implementation, the overall LCU formula for  $U(t)$  is to repeat  $\tilde{V}_0(x) = \tilde{U}_0(x)$  for  $\nu$  times,  $\tilde{U}_{0,tot}(t) = \tilde{U}_0(x)^\nu$ . Using Proposition 2 and 3, we conclude that  $\tilde{U}_{0,tot}(t)$  is a  $(\mu_{0,tot}(t), \varepsilon_{0,tot}(t))$ -LCU formula of  $U(t)$  with

$$\begin{aligned} \mu_{0,tot}(t) &= \mu_0(x)^\nu \leq e^{\lambda t}, \\ \varepsilon_{0,tot}(t) &\leq \nu \mu_{0,tot}(t) \varepsilon_0(x) \leq \nu e^{\lambda t} \left(\frac{e\lambda x}{s_c+1}\right)^{s_c+1}. \end{aligned} \tag{E10}$$

In this case, the 1-norm will exponentially increasing no matter what segment number  $\nu$  we choice. Consequently, the 0th-order Trotter-LCU formula with direct Taylor-series compensation is not suitable for the random-sampling usage.

The inefficiency of 0th-order random-sampling implement can also be understood from another perspective of classical simulation. Note that, all the gates in the 0th-order algorithm are Clifford gates — to implement controlled- $\tilde{U}_0(x)$ , we only need to perform many controlled-Pauli gates. Based on the Gottesman-Knill's theorem [35], we know that this circuit can be easily simulated by classical computers. On the other hand, it is widely believed that the real-time evolution of a generic Hamiltonian is exponentially hard to simulate on a classical computer [36]. As a result, this will let to the exponentially increasing sampling complexity to the evolution time  $t$ .

For the coherent implementation, to apply Corollary 1, we need to set

$$\mu_0(x) = 2 \Leftrightarrow x = \frac{\ln 2}{\lambda}. \tag{E11}$$

Therefore, the number of segments  $\nu$  is then

$$\nu = \frac{t}{x} = \frac{\lambda t}{\ln 2} = \mathcal{O}(\lambda t). \tag{E12}$$

To determine the truncation order  $s_c$  based on the overall simulation accuracy  $\varepsilon$ , we only need to make sure that the accuracy for each segment is  $\xi := \varepsilon/\nu$ . Then we can solve  $s_c$  based on the following constraints

$$\begin{aligned} \epsilon_0 &:= \left(\frac{e \ln 2}{s_c+1}\right)^{s_c+1}, \\ \frac{\epsilon_0^2 + 2\epsilon_0 + 4}{2} \epsilon_0 &\leq \frac{\varepsilon}{\nu}. \end{aligned} \tag{E13}$$

When  $\epsilon_0$  is small enough such that  $\epsilon_0(\epsilon_0 + 2) \leq 2$ , it suffices to have

$$\begin{aligned} 3\nu\epsilon_0 &= 3\nu \left(\frac{e \ln 2}{s_c+1}\right)^{s_c+1} \leq \varepsilon \\ \Rightarrow s_c &\geq \left\lceil \frac{\ln(\frac{\varepsilon}{3\nu})}{W_0\left(\frac{1}{\varepsilon \ln 2} \ln(\frac{\varepsilon}{3\nu})\right)} - 1 \right\rceil. \end{aligned} \tag{E14}$$

Here, the second line is derived based on Lemma 8.  $W_0(y)$  is the principle branch of the Lambert-W function. From Lemma 9 we know that  $W_0(y) = \mathcal{O}(\log(y))$ . As a result,  $s_c = \mathcal{O}(\log(1/\varepsilon)/\log \log(1/\varepsilon))$ .

## 2. First-order case

Now, we study the direct Taylor-series compensation of the remainders of Trotter formulas. We will take 1st-order case as an example. The Trotter remainder  $V_1(x)$  is

$$V_1(x) = U(x)S_1(x)^\dagger. \quad (\text{E15})$$

From Eq. (E2) and Eq. (D8) we have

$$\begin{aligned} U(x) &= \sum_{r=0}^{\infty} \frac{(\lambda x)^r}{r!} \sum_{l_1, \dots, l_r} p_{l_1} p_{l_2} \dots p_{l_r} (-i)^r P_{l_1} P_{l_2} \dots P_{l_r} \\ &= e^{\lambda x} \sum_{r=0}^{\infty} \text{Poi}(r; \lambda x) \sum_{l_{1:r}} p_{l_{1:r}}^{(r)} (-i)^r P_{l_{1:r}}^{(r)} \\ S_1(x)^\dagger &= \prod_{\vec{r}} e^{i x \vec{H}} = e^{i x H_1} e^{i x H_2} \dots e^{i x H_L} \\ &= \left( \prod e^{\vec{\alpha} x} \right) \sum_{\vec{r}} \text{Poi}(\vec{r}; \vec{\alpha} x) \prod (i \vec{P})^{\vec{r}}. \end{aligned} \quad (\text{E16})$$

Here, we adopt the vector notations introduced in Sec. D to simplify the expressions. In Eq. (E16), we also extend the notation of Poisson distribution,

$$\text{Poi}(\vec{r}; \vec{\alpha} x) := \prod_{l=1}^L \text{Poi}(r_l; \alpha_l x). \quad (\text{E17})$$

Based on Eq. (E16), we then write the Taylor-series expansion of first-order remainder as follows,

$$\begin{aligned} V_1(x) &= U(x)S_1(x)^\dagger \\ &= \sum_{r; \vec{r}} \frac{(\lambda x)^r}{r!} \left( \prod \frac{(\vec{\alpha} x)^{\vec{r}}}{\vec{r}!} \right) \sum_{l_{1:r}} p_{l_{1:r}}^{(r)} (-i)^{r - \sum \vec{r}} P_{l_{1:r}}^{(r)} \prod \vec{P}^{\vec{r}}, \\ &= e^{2\lambda x} \sum_{r; \vec{r}} \text{Poi}(r, \vec{r}; \lambda x, \vec{\alpha} x) \sum_{l_{1:r}} p_{l_{1:r}}^{(r)} (-i)^{r - \sum \vec{r}} P_{l_{1:r}}^{(r)} \prod \vec{P}^{\vec{r}}, \end{aligned} \quad (\text{E18})$$

which is a LCU formula with 1-norm  $e^{2\lambda x}$ . Here,  $r$  and  $\vec{r}$  are two groups of independent variables.

Now, we use the order condition of the Trotter formula in Lemma 1 to eliminate some terms in Eq. (E18), so that the 1-norm is suppressed. To this end, we first rewrite Eq. (E18) by classifying the terms based on the power of  $x$ , which is determined by the value  $s = r + \sum \vec{r}$ .

$$V_1(x) = \sum_{s=0}^{\infty} F_{1,s}(x) = \sum_{s=0}^{\infty} \|F_{1,s}(x)\|_1 V_{1,s}. \quad (\text{E19})$$

Here,  $\|F_{1,s}(x)\|_1$  is the 1-norm of the  $s$ -order expansion formula  $F_{1,s}(x)$ .  $V_{1,s}$  denotes the normalized LCU formula for the  $s$ -order terms. We have

$$\begin{aligned} F_{1,s}(x) &:= \sum_{r + \sum \vec{r} = s} \frac{(\lambda x)^r}{r!} \left( \prod \frac{(\vec{\alpha} x)^{\vec{r}}}{\vec{r}!} \right) \sum_{l_{1:r}} p_{l_{1:r}}^{(r)} (-i)^{2r-s} P_{l_{1:r}}^{(r)} \prod \vec{P}^{\vec{r}}, \\ V_{1,s} &:= \sum_{r; \vec{r}} \text{Pr}(r, \vec{r} | s) \sum_{l_{1:r}} p_{l_{1:r}}^{(r)} (-i)^{2r-s} P_{l_{1:r}}^{(r)} \prod \vec{P}^{\vec{r}}. \end{aligned} \quad (\text{E20})$$



In the expression of  $V_1^{(s)}$ , we use  $r - \sum \vec{r} = r - (s - r) = 2r - s$ . The conditional probability  $\Pr(r, \vec{r}|s)$  indicates the probability to sample  $r$  and  $\vec{r}$  when their summation  $s$  is given,

$$\begin{aligned} \Pr(r, \vec{r}|s) &= \frac{\Pr\{\hat{r} = r, \hat{\vec{r}} = \vec{r} \cap (\hat{s} = s)\}}{\Pr\{\hat{s} = s\}} \\ &= \frac{s!}{r! \prod \vec{r}!} \left(\frac{1}{2}\right)^r \prod \left(\frac{\vec{p}}{2}\right)^{\vec{r}} \\ &= \text{Mul}(\{r, \vec{r}\}; \{\frac{1}{2}, \frac{\vec{p}}{2}\}; s), \end{aligned} \quad (\text{E21})$$

which is a multinomial distribution  $\text{Mul}(\cdot; \cdot; s)$  with  $s$  trials and  $(L+1)$ -outcomes. In each trial, the  $(L+1)$  outcomes  $\{r; r_1, r_2, \dots, r_L\}$  occur with the corresponding probability  $\{\frac{1}{2}, \frac{1}{2}p_1, \frac{1}{2}p_2, \dots, \frac{1}{2}p_L\}$ . Recall that  $\vec{p}$  is defined in Eq. (D2).

We first estimate the normalization cost  $\|F_{1,s}(x)\|_1$  for different  $s$  orders,

$$\begin{aligned} \|F_{1,s}(x)\|_1 &= \sum_{s; \vec{r}} \mathbb{1} \left[ r + \sum \vec{r} = s \right] \frac{(\lambda x)^r}{r!} \left( \prod \frac{(\vec{\alpha} x)^{\vec{r}}}{\vec{r}!} \right) \\ &= \frac{(\lambda x + \sum \vec{\alpha} x)^s}{s!} = \frac{(2\lambda x)^s}{s!} := \eta_s. \end{aligned} \quad (\text{E22})$$

In the second inequality, we use Corollary 4. We denote

$$\eta_s = \eta_s(2\lambda x) := \frac{(2\lambda x)^s}{s!}. \quad (\text{E23})$$

We will frequently use  $\eta_s$  in the following discussion.

From Eq. (E22) we can see that, similar to the expansion of  $V_0(x)$ , the 1-norm of the expansion terms with different orders of  $x$  in  $V_1(x)$  follow the Poisson distribution. This motivates us to eliminate the low-order terms such as  $F_{1,1}(x)$ . Based on Lemma 1, we have

$$F_1^{(1)}(x) = 0. \quad (\text{E24})$$

As a result, we can directly remove the term  $F_1^{(1)}(x)$  in Eq. (E19). The resulting formula is,

$$V_1(x) = I + \sum_{s=2}^{\infty} \eta_s V_{1,s}. \quad (\text{E25})$$

In practice, we introduce a truncation  $s_c \geq 1$  in the expansion order of  $x$ . The truncated formula is

$$\begin{aligned} \tilde{V}_1(x) &= I + \sum_{s=2}^{s_c} \eta_s V_{1,s} \\ &= \mu_1(x) \left( \text{Pr}_1(0)I + \sum_{s=2}^{s_c} \text{Pr}_1(s) V_{1,s} \right), \end{aligned} \quad (\text{E26})$$

where

$$\begin{aligned} \mu_1(x) &:= \eta_0 + \sum_{s=2}^{s_c} \eta_s \leq e^{2\lambda x} - (2\lambda x) \leq e^{(2\lambda x)^2}, \\ \text{Pr}_1(s) &:= \frac{\eta_s}{\mu_1(x)} = \frac{1}{\mu_1(x)} \frac{(2\lambda x)^s}{s!}, \quad s = 0; 2, 3, \dots, s_c. \\ V_{1,s} &= \sum_{r; \vec{r}} \Pr(r, \vec{r}|s) \sum_{l_{1:r}} p_{l_{1:r}}^{(r)} (-i)^{2r-s} P_{l_{1:r}}^{(r)} \prod \vec{P}^{\vec{r}}. \end{aligned} \quad (\text{E27})$$

Here, the conditional probability  $\Pr(r, \vec{r}|s) := \text{Mul}(\{r, \vec{r}\}; \{\frac{1}{2}, \frac{\vec{p}}{2}\}; s)$ .

Combined with the deterministic first-order Trotter formula, the overall LCU formula for  $U(x)$  is

$$\tilde{U}_1(x) = \tilde{V}_1(x) S_1(x). \quad (\text{E28})$$

We have the following proposition to characterize the LCU formula in Eq. (E26) and Eq. (E28).

**Proposition 4** (1st-order Trotter-LCU formula by direct Taylor-series compensation). *For  $x > 0$  and  $s_c \geq 1$ ,  $\tilde{V}_1(x)$  in Eq. (E26) is a  $(\mu_1(x), \varepsilon_1(x))$ -LCU formula of  $V_1(x)$  with*

$$\begin{aligned}\mu_1(x) &\leq e^{(2\lambda x)^2}, \\ \varepsilon_1(x) &\leq \left(\frac{2e\lambda x}{s_c + 1}\right)^{s_c+1}.\end{aligned}\tag{E29}$$

As a result,  $\tilde{U}_1(x)$  in Eq. (E28) is a  $(\mu_1(x), \varepsilon_1(x))$ -LCU formula of  $U(x)$ .

*Proof.* From  $e^x - x \leq e^{x^2}$  for  $x > 0$ , we know that

$$\mu_1(x) \leq e^{2\lambda x} - 2\lambda x \leq e^{(2\lambda x)^2}.\tag{E30}$$

For the distance bound, from Eq. (E25) and Eq. (E26) we have

$$\begin{aligned}\|V_1(x) - \tilde{V}_1(x)\| &\leq \sum_{s>s_c} \eta_s \|V_{1,s}\| \\ &= \sum_{s>s_c} \frac{(2\lambda x)^s}{s!} \\ &\leq \left(\frac{2e\lambda x}{s_c + 1}\right)^{s_c+1}\end{aligned}\tag{E31}$$

In the second line, we use the fact that  $\|V_{1,s}\| \leq 1$ . In the third line, we apply Corollary 2.  $\square$

Now, we consider the Trotter-LCU formula  $\tilde{U}_1(x)$  in Eq. (E28) for both random-sampling and coherent usages.

For the random-sampling implementation, the overall LCU formula for  $U(t)$  is to repeat  $\tilde{U}_1(x)$  for  $\nu$  times,  $\tilde{U}_{1,tot}(t) = \tilde{U}_1(x)^\nu$ . Using Proposition 2 and 4, we conclude that  $\tilde{U}_1(t)$  is a  $(\mu_{1,tot}(t), \varepsilon_{1,tot}(t))$ -LCU formula of  $U(t)$  with

$$\begin{aligned}\mu_{1,tot}(t) &= \mu_1(x)^\nu \leq e^{\frac{(2\lambda t)^2}{\nu}}, \\ \varepsilon_{1,tot}(t) &\leq \nu \mu_{1,tot}(t) \varepsilon_1(x) \leq \nu e^{\frac{(2\lambda t)^2}{\nu}} \left(\frac{2e\lambda x}{s_c + 1}\right)^{s_c+1}.\end{aligned}\tag{E32}$$

To realize a  $(\mu, \varepsilon)$ -LCU formula for  $U(t)$ , we only need to set the segment number  $\nu$  and the truncation order  $s_c$  to be

$$\begin{aligned}\nu &\geq \frac{(2\lambda t)^2}{\ln \mu}, \\ s_c &\geq \left\lceil \frac{\ln\left(\frac{\mu(2\lambda t)^2}{\ln(\mu\varepsilon)}\right)}{W_0\left(\frac{2\lambda t}{e \ln(\mu)} \ln\left(\frac{\mu(2\lambda t)^2}{\ln(\mu\varepsilon)}\right)\right)} - 1 \right\rceil,\end{aligned}\tag{E33}$$

To derive the bound for  $s_c$  in the second line, we use Lemma 8. Based on Eq. (D33), the gate complexity of the 1st-order Trotter-LCU algorithm is then

$$\mathcal{O}(\nu(L + s_c)) = \mathcal{O}\left((\lambda t)^2 \left(L + \frac{\log(1/\varepsilon)}{\log \log(1/\varepsilon)}\right)\right).\tag{E34}$$

From Eq. (E33) we can see that, since we eliminate the first-order term in  $V_1(x)$  based on the order condition in Lemma 1, we suppress the 1-norm. This enables us to consider an efficient random-sampling implementation of Trotter-LCU formula.

For the coherent implementation of 1st-order DTSc Trotter-LCU, to apply Corollary 1, we need to set

$$\mu_1(x) \leq 2 \Leftrightarrow x = \frac{\sqrt{\ln 2}}{2\lambda}.\tag{E35}$$

Therefore, the number of segments  $\nu$  is then

$$\nu = \frac{t}{x} = \frac{2\lambda t}{\sqrt{\ln 2}} = \mathcal{O}(\lambda t).\tag{E36}$$

As a result, the smaller value of  $\mu(x)$  for each segment is not helpful to reduce the number of segments  $\nu$  for the coherent implementation of LCU. The truncation order analysis for  $s_c$  is similar to the one in Sec. E1. We also have  $s_c = \mathcal{O}(\log(1/\varepsilon)/\log \log(1/\varepsilon))$ .

### 3. Second- and higher-order case

Following similar methods, we can obtain the LCU formulas for 2nd- and higher-order Trotter remainders. For example, the 2nd-order Trotter remainder  $V_2(x)$  is

$$\begin{aligned} V_2(x) &= U(x)S_2(x)^\dagger = U(x) \\ &= \sum_{r, \vec{r}, \vec{r}'} \frac{(\lambda x)^r}{r!} \prod \frac{\left(\frac{\vec{\alpha}x}{2}\right)^{\vec{r}}}{\vec{r}!} \prod \frac{\left(\frac{\vec{\alpha}x}{2}\right)^{\vec{r}'}}{\vec{r}'!} \sum_{l_{1:r}} p_{l_{1:r}}^{(r)} (-i)^{r-\sum(\vec{r}+\vec{r}')} P_{l_{1:r}}^{(r)} \overrightarrow{\prod} \vec{P}^{\vec{r}} \overleftarrow{\prod} \vec{P}^{\vec{r}'}. \end{aligned} \quad (\text{E37})$$

We then expand  $V_2(x)$  based on the power of  $x$ , given by  $s := r + \sum(\vec{r} + \vec{r}')$ ,

$$V_2(x) = \sum_{s=0}^{\infty} F_{2,s}(x) = \sum_{s=0}^{\infty} \|F_{2,s}(x)\|_1 V_{2,s}, \quad (\text{E38})$$

where  $\|F_{2,s}(x)\|_1$  is the 1-norm of the  $s$ -order expansion formula  $F_{2,s}(x)$ .  $V_{2,s}$  denotes the normalized LCU formula for the  $s$ -order terms. Similar to the derivations in Eq. (E21) and Eq. (E22), we have

$$\begin{aligned} \|F_{2,s}(x)\|_1 &= \sum_{\substack{r, \vec{r}, \vec{r}' \\ r+\sum(\vec{r}+\vec{r}')=s}} \frac{(\lambda x)^r}{r!} \prod \frac{\left(\frac{\vec{\alpha}x}{2}\right)^{\vec{r}}}{\vec{r}!} \prod \frac{\left(\frac{\vec{\alpha}x}{2}\right)^{\vec{r}'}}{\vec{r}'!} = \frac{(2\lambda x)^s}{s!} := \eta_s, \\ V_{2,s} &= \sum_{r, \vec{r}, \vec{r}'} \Pr(r, \vec{r}, \vec{r}' | s) \sum_{l_{1:r}} p_{l_{1:r}}^{(r)} (-i)^{2r-s} P_{l_{1:r}}^{(r)} \overrightarrow{\prod} \vec{P}^{\vec{r}} \overleftarrow{\prod} \vec{P}^{\vec{r}'}. \end{aligned} \quad (\text{E39})$$

Here, the conditional probability  $\Pr(r, \vec{r}, \vec{r}' | s)$  is the multinomial distribution  $\text{Mul}(\{r, \vec{r}, \vec{r}'\}; \{\frac{1}{2}, \frac{\vec{p}}{4}, \frac{\vec{p}}{4}\}; s)$  following similar derivation in Eq. (E21). In the expression of  $V_{2,s}$ , we use  $r - \sum(\vec{r} + \vec{r}') = r - (s - r) = 2r - s$ .

Based on Lemma 1 we know that

$$F_{2,1}(x) = F_{2,2}(x) = 0. \quad (\text{E40})$$

Therefore, we can reduce the expansion formula of  $V_2(x)$  to

$$V_2(x) = I + \sum_{s=3}^{\infty} \eta_s V_{2,s}. \quad (\text{E41})$$

In practice, we introduce a truncation  $s_c \geq 3$  in the expansion order. We remark that, if  $s_c < 3$ , we do not need to introduce the LCU formula to compensate the Trotter error. The truncated formula is

$$\begin{aligned} \tilde{V}_2(x) &= I + \sum_{s=3}^{s_c} \eta_s V_{2,s} \\ &= \mu_2(x) \left( \Pr_2(0)I + \sum_{s=3}^{s_c} \Pr_2(s) V_{2,s} \right), \end{aligned} \quad (\text{E42})$$

where

$$\begin{aligned} \mu_2(x) &:= \eta_0 + \sum_{s=3}^{s_c} \eta_s, \\ \Pr_2(s) &:= \frac{\eta_s}{\mu_2(x)} = \frac{1}{\mu_2(x)} \frac{(2\lambda x)^s}{s!}, \quad s = 0; 3, 4, \dots, s_c. \end{aligned} \quad (\text{E43})$$

Combined with the deterministic second-order Trotter formula, the overall LCU formula for  $U(x)$  is

$$\tilde{U}_2(x) = \tilde{V}_2(x)S_2(x). \quad (\text{E44})$$

The derivation of LCU formula for the  $2k$ th-order Trotter remainder  $V_{2k}(x)$  is similar to the second order case. From Eq. (D14), the remainder of the general  $2k$ th-order Trotter formula is,

$$V_{2k}(x) = U(x)S_{2k}(x)^\dagger = U(x)D_{2k}(x)^\dagger D_{2k}(-x), \quad (\text{E45})$$

which can be expanded as

$$V_{2k}(x) = \sum_{\substack{r; \vec{r}_1, \dots, \vec{r}_\kappa; \\ \vec{r}'_1, \dots, \vec{r}'_\kappa}} \frac{(\lambda x)^r}{r!} \prod \frac{(\vec{\alpha} \nu_1 x)^{\vec{r}_1}}{\vec{r}_1!} \dots \prod \frac{(\vec{\alpha} \nu_\kappa x)^{\vec{r}_\kappa}}{\vec{r}_\kappa!} \prod \frac{(\vec{\alpha} \nu_\kappa x)^{\vec{r}'_\kappa}}{\vec{r}'_\kappa!} \dots \prod \frac{(\vec{\alpha} \nu_1 x)^{\vec{r}'_1}}{\vec{r}'_1!} \quad (\text{E46})$$

$$\sum_{l_{1:r}} p_{l_{1:r}}^{(r)} (-i)^{r - \sum (\vec{r}_1 + \dots + \vec{r}_\kappa + \vec{r}'_1 + \dots + \vec{r}'_\kappa)} \left( P_{l_{1:r}}^{(r)} \right) \overset{\rightarrow}{\prod} \bar{P}^{\vec{r}_1} \overset{\leftarrow}{\prod} \bar{P}^{\vec{r}_2} \dots \overset{\rightarrow}{\prod} \bar{P}^{\vec{r}_\kappa} \overset{\leftarrow}{\prod} \bar{P}^{\vec{r}'_\kappa} \dots \overset{\rightarrow}{\prod} \bar{P}^{\vec{r}'_2} \overset{\leftarrow}{\prod} \bar{P}^{\vec{r}'_1}.$$

Here, we use  $\vec{r}_i = [r_{i,1}, r_{i,2}, \dots, r_{i,L}]$  to denote a vector with  $L$  elements. In what follows, we denote

$$\vec{r}_{1:\kappa} = \{\vec{r}_1, \vec{r}_2, \dots, \vec{r}_\kappa\}. \quad (\text{E47})$$

As a result, there are  $\kappa L$  summands  $r_{i,j}$  in  $\vec{r}_{1:\kappa}$ . Recall that  $\kappa = 5^{k-1}$ ,  $\{v_i\}_{i=1}^\kappa$  are positive numbers indicating the segment length, which are determined by Eq. (D10) and Eq. (D11) which satisfy  $\sum_{i=1}^\kappa v_i = \frac{1}{2}$ .

Expanding  $V_{2k}(x)$  based on the power of  $x$ , given by  $s := r + \sum (\vec{r}_{1:\kappa} + \vec{r}'_{1:\kappa})$ , we have

$$V_{2k}(x) = \sum_{s=0}^{\infty} F_{2k,s}(x) = \sum_{s=0}^{\infty} \|F_{2k,s}(x)\|_1 V_{2k,s},$$

$$\|F_{2k,s}(x)\|_1 = \sum_{r; \vec{r}_{1:\kappa}; \vec{r}'_{1:\kappa}} \frac{(\lambda x)^r}{r!} \prod \frac{(\vec{\alpha} \nu_1 x)^{\vec{r}_1}}{\vec{r}_1!} \dots \prod \frac{(\vec{\alpha} \nu_\kappa x)^{\vec{r}_\kappa}}{\vec{r}_\kappa!} \prod \frac{(\vec{\alpha} \nu_\kappa x)^{\vec{r}'_\kappa}}{\vec{r}'_\kappa!} \dots \prod \frac{(\vec{\alpha} \nu_1 x)^{\vec{r}'_1}}{\vec{r}'_1!} = \eta_s,$$

$$V_{2k,s} = \sum_{r, \vec{r}_{1:\kappa}, \vec{r}'_{1:\kappa}} \Pr(r, \vec{r}_{1:\kappa}, \vec{r}'_{1:\kappa} | s) \sum_{l_{1:r}} p_{l_{1:r}}^{(r)} (-i)^{2r-s} \left( P_{l_{1:r}}^{(r)} \right) \overset{\rightarrow}{\prod} \bar{P}^{\vec{r}_1} \overset{\leftarrow}{\prod} \bar{P}^{\vec{r}_2} \dots \overset{\rightarrow}{\prod} \bar{P}^{\vec{r}_\kappa} \overset{\leftarrow}{\prod} \bar{P}^{\vec{r}'_\kappa} \dots \overset{\rightarrow}{\prod} \bar{P}^{\vec{r}'_2} \overset{\leftarrow}{\prod} \bar{P}^{\vec{r}'_1}. \quad (\text{E48})$$

Where  $\Pr(r, \vec{r}_{1:\kappa}, \vec{r}'_{1:\kappa} | s) := \text{Mul}(\{r, \vec{r}_{1:\kappa}, \vec{r}'_{1:\kappa}\}; \{\frac{1}{2}, \nu_{1:\kappa} \frac{\vec{p}}{2}, \nu_{1:\kappa} \frac{\vec{p}}{2}\}; s)$ . In the expression of  $V_{2k,s}$ , we use  $r - \sum (\vec{r}_{1:\kappa} + \vec{r}'_{1:\kappa}) = r - (s - r) = 2r - s$ . We use the notation  $\nu_{1:k} \vec{p} = \{\nu_1 \vec{p}, \nu_2 \vec{p}, \dots, \nu_\kappa \vec{p}\}$ .

Based on Lemma 1 we know that

$$F_{2k}^{(1)}(x) = F_{2k}^{(2)}(x) = \dots = F_{2k}^{(2k)}(x) = 0. \quad (\text{E49})$$

Therefore, we can reduce the expansion formula of  $V_{2k}(x)$  to

$$V_{2k}(x) = I + \sum_{s=2k+1}^{\infty} \eta_s V_{2k,s}. \quad (\text{E50})$$

In practice, we introduce a truncation  $s_c \geq 2k + 1$  in the expansion order. The truncated formula is then

$$\begin{aligned} \tilde{V}_{2k}(x) &= I + \sum_{s=2k+1}^{s_c} \eta_s V_{2k,s} \\ &= \mu_{2k}(x) \left( \Pr_{2k}(s=0) I + \sum_{s=2k+1}^{s_c} \Pr_{2k}(s) V_{2k,s} \right). \end{aligned} \quad (\text{E51})$$

where

$$\begin{aligned} \mu_{2k}(x) &:= \eta_0 + \sum_{s=2k+1}^{s_c} \eta_s V_{2k,s} \leq e^{2\lambda x} - \sum_{s=1}^{2k} \frac{(2\lambda x)^s}{s!}, \\ \Pr_{2k}(s) &:= \frac{\eta_s}{\mu_{2k}(x)} = \frac{1}{\mu_{2k}(x)} \frac{(2\lambda x)^s}{s!}. \end{aligned} \quad (\text{E52})$$

Combined with the deterministic second-order Trotter formula, the overall LCU formula for  $U(x)$  is

$$\tilde{U}_{2k}(x) = \tilde{V}_{2k}(x) S_{2k}(x). \quad (\text{E53})$$

We have the following proposition to characterize the LCU formula for  $V_{2k}(x)$  and  $U_{2k}(x)$  in Eq. (E51) and Eq. (E53).

**Proposition 5** (*2kth-order Trotter-LCU formula by direct Taylor-series compensation*). For  $0 < x < (2k + 1)/(2\lambda)$  and  $s_c \geq 2k + 1$ ,  $\tilde{V}_{2k}(x)$  in Eq. (E51) is a  $(\mu_{2k}(x), \varepsilon_{2k}(x))$ -LCU formula of  $V_{2k}(x)$  with

$$\begin{aligned}\mu_{2k}(x) &\leq e^{e(2\lambda x)^{2k+1}}, \\ \varepsilon_{2k}(x) &\leq \left(\frac{2e\lambda x}{s_c + 1}\right)^{s_c+1}.\end{aligned}\tag{E54}$$

As a result,  $\tilde{U}_{2k}(x)$  in Eq. (E53) is a  $(\mu_{2k}(x), \varepsilon_{2k}(x))$ -LCU formula of  $U(x)$ .

*Proof.* Here, we focus on the case with  $k = 1$ , i.e., the second-order case. The proof for general  $k$  can be done in the same way.

From Eq. (E43) and Corollary 3, we know that

$$\mu_2(x) \leq e^{2\lambda x} - \sum_{s=1}^2 \frac{(2\lambda x)^s}{s!} \leq e^{e(2\lambda x)^3}.\tag{E55}$$

For the distance bound, from Eq. (E41) and Eq. (E42) we have

$$\begin{aligned}\|V_2(x) - \tilde{V}_2(x)\| &\leq \sum_{s>s_c} \eta_s \|V_{2,s}\| \\ &= \sum_{s>s_c} \frac{(2\lambda x)^s}{s!} \\ &\leq \left(\frac{2e\lambda x}{s_c + 1}\right)^{s_c+1}\end{aligned}\tag{E56}$$

In the second line, we use the fact that  $\|V_{2,s}\| \leq 1$ . In the forth line, we apply Corollary 2. □

Now, we consider the Trotter-LCU formula  $\tilde{U}_{2k}(x)$  in Eq. (E53) for both random-sampling and coherent usages.

For the random-sampling implementation, the overall LCU formula for  $U(t)$  is to repeat the sampling of  $\tilde{U}_{2k}(x)$  for  $\nu$  times,  $\tilde{U}_{2k,tot}(t) = \tilde{U}_{2k}(x)^\nu$ . Using Proposition 2 and 5, when  $0 < x < \frac{2k+1}{2\lambda}$  and  $s_c \geq 1$ , we conclude that  $\tilde{U}_{2k,tot}(t)$  is a  $(\mu_{2k,tot}(t), \varepsilon_{2k,tot}(t))$ -LCU formula of  $U(t)$  with

$$\begin{aligned}\mu_{2k,tot}(t) &= \mu_{2k}(x)^\nu \leq e^{e\frac{(2\lambda t)^{2k+1}}{\nu^{2k}}}, \\ \varepsilon_{2k,tot}(t) &\leq \nu \mu_{2k,tot}(t) \varepsilon_{2k}(x) \leq \nu e^{e\frac{(2\lambda t)^{2k+1}}{\nu^{2k}}} \left(\frac{2e\lambda x}{s_c + 1}\right)^{s_c+1}.\end{aligned}\tag{E57}$$

To realize a  $(\mu, \varepsilon)$ -LCU formula for  $U(t)$ , we only need to set the segment number  $\nu$  and the truncation order  $s_c$  to be

$$\begin{aligned}\nu &\geq \max\left\{\nu_{2k}(t), \frac{2\lambda t}{2k+1}\right\}, \\ s_c &\geq \max\left\{\left\lceil \frac{\ln\left(\frac{\mu}{\varepsilon}\nu_{2k}(t)\right)}{W_0\left(\frac{1}{2e\lambda t}\nu_{2k}(t)\ln\left(\frac{\mu}{\varepsilon}\nu_{2k}(t)\right)\right)} - 1 \right\rceil, 2k+1\right\},\end{aligned}\tag{E58}$$

where  $\nu_{2k}(t) := \left(\frac{2e\lambda t}{\ln \mu}\right)^{\frac{1}{2k}} 2\lambda t$ . To derive the bound for  $s_c$  in the second line, we use Lemma 8. Based on Eq. (D33), the gate complexity of the 2kth-order Trotter-LCU algorithm is then

$$\mathcal{O}(\nu(L + s_c)) = \mathcal{O}\left((\lambda t)^{1+\frac{1}{2k}}\left(L + \frac{\log(1/\varepsilon)}{\log \log(1/\varepsilon)}\right)\right).\tag{E59}$$

We illustrate the random-sampling implementation of the DTSc formula in Eq. (E28) and Eq. (E53) in Fig. 8. In Fig. 8(b), we mainly set  $K = 1$  as an example due to its simplicity. For the higher-order case, the only difference is that the sampling of  $\vec{r}$  and  $\vec{r}'$  need to be the variables  $\vec{r}_{1:\kappa}$  and  $\vec{r}'_{1:\kappa}$  on multiple stages. The sampling probability  $\Pr(r, \vec{r}_{1:\kappa}, \vec{r}'_{1:\kappa} | s) := \text{Mul}(\{r, \vec{r}_{1:\kappa}, \vec{r}'_{1:\kappa}\}; \{\frac{1}{2}, \nu_{1:\kappa} \frac{\vec{p}}{2}, \nu_{1:\kappa} \frac{\vec{p}}{2}\}; s)$  is given in Eq. (E48).

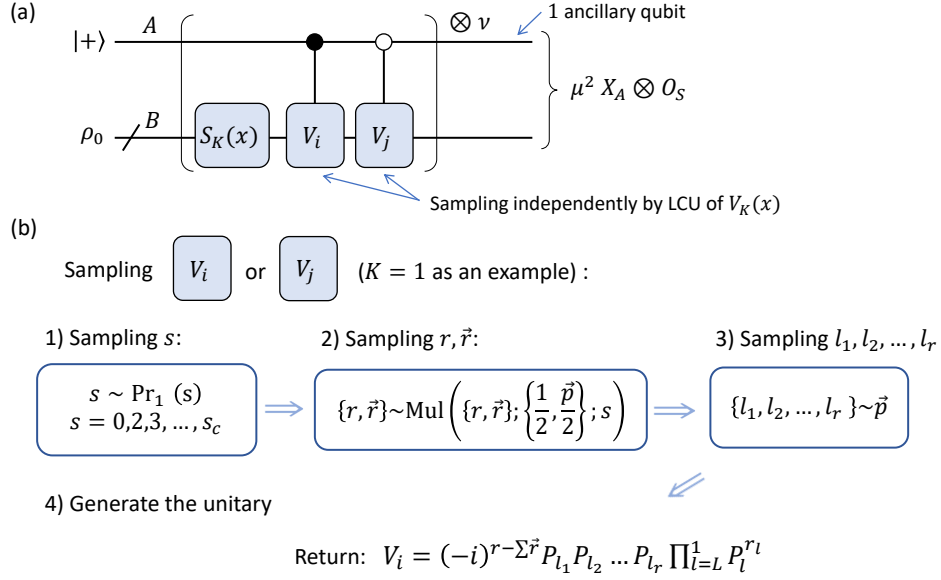

FIG. 8. (a) Circuit for the random-sampling implementation of the Trotter-LCU formula.  $V_i$  and  $V_j$  are two random unitaries sampled independently based on different LCU formula for  $V_K(x)$ . (b) The sampling procedure of  $V_i$  or  $V_j$  in the DTSc algorithm. We set  $K = 1$  as example.

For the coherent implementation of DTSc formula in Eq. (E53), to apply Corollary 1, we need to set

$$\mu_{2k}(x) \leq 2 \Leftrightarrow x = \frac{1}{2\lambda} \left( \frac{\ln 2}{e} \right)^{\frac{1}{2k+1}}. \quad (\text{E60})$$

Therefore, the number of segments  $\nu$  is then

$$\nu = \frac{t}{x} = 2\lambda t \left( \frac{e}{\ln 2} \right)^{\frac{1}{2k+1}} = \mathcal{O}(\lambda t). \quad (\text{E61})$$

Similar to the first-order case, the smaller value of  $\mu(x)$  for each segment is not helpful to reduce the number of segments  $\nu$  for the coherent implementation of LCU. The truncation order analysis for  $s_c$  is similar to the one in Sec. E1. We also have  $s_c = \mathcal{O}(\log(1/\varepsilon)/\log \log(1/\varepsilon))$ .

## Appendix F: Trotter-LCU formula with paired Taylor-series compensation

In this section, we discuss how to improve the Taylor-series compensation methods introduced in Sec. E to further suppress the 1-norm of the LCU formulas. This will remarkably improve the  $t$ -dependence of the algorithms based on random-sampling implementation. The main idea behind this improvement is to apply Euler's formula for Pauli operators to pair the Pauli operator with  $I$  to suppress the 1-norm.

We remark that, similar ‘‘paired’’ Taylor-series compensation idea is considered in Ref. [23] for the zeroth-order case. It is also proposed in Ref. [22] for the case with Trotter formulas. Our contributions here are: 1) we propose an explicit LCU formula with easy experimental implementation and simple sampling methods; 2) based on the explicit LCU formula, we provide rigorous performance guarantee and gate complexity analysis.

### 1. Zeroth-order case

We start from the zeroth-order case, where the Trotter remainder  $V_0(x) = U(x) = e^{-ixH}$ .

In Eq. (E2), we have expanded the  $V_0(x)$  based on Taylor series,

$$\begin{aligned} V_0(x) &= \sum_{s=0}^{\infty} F_{0,s}(x), \\ F_{0,s}(x) &= \frac{(-i\lambda x)^s}{s!} \sum_{l_{1:s}} p_{l_{1:s}}^{(s)} P_{l_{1:s}}^{(s)}. \end{aligned} \quad (\text{F1})$$

The 1-norm of  $V_0(x)$  is

$$\|V_0(x)\|_1 = \sum_{s=0}^{\infty} \|F_{0,s}(x)\|_1 = 1 + (\lambda x) + \frac{1}{2!}(\lambda x)^2 + \frac{1}{3!}(\lambda x)^3 + \dots = e^{\lambda x}. \quad (\text{F2})$$

In the discussion in Sec. E1, we have seen that the 1-norm  $e^{\lambda x}$  is too large for an efficient random-sampling implementation of the zeroth-order algorithm. When  $\lambda x$  is a small value, the major contribution to  $\|V_0(x)\|_1$  comes from the low-order terms of  $F_{0,s}(x)$ .

Note that the first-order term  $F_{0,1}(x)$  is anti-Hermitian. To suppress  $\|V_0(x)\|_1$ , we rewrite  $V_0(x)$  as follows,

$$\begin{aligned} V_0(x) &= \sum_{s=0}^{\infty} F_{0,s}(x) \\ &= I - i\lambda x \sum_{l=1}^L p_l P_l + \sum_{s=2}^{\infty} F_{0,s}(x) \\ &= \sum_{l=1}^L p_l (I - i\lambda x P_l) + \sum_{s=2}^{\infty} F_{0,s}(x). \end{aligned} \quad (\text{F3})$$

Then, we can apply Eq. (D61) on Eq. (F3) to convert the first-order term to Pauli rotation unitaries

$$V_0(x) = \sqrt{1 + (\lambda x)^2} \sum_{l=1}^L p_l e^{i\theta_0 P_l} + \sum_{s=2}^{\infty} F_{0,s}(x), \quad (\text{F4})$$

where  $\theta_0 := \tan^{-1}(-\lambda x)$ .

In practice, we introduce a truncation  $s_c \geq 2$  to the expansion order of  $x$ . After this truncation, the approximated LCU formula of  $V_0^{(p)}(x)$  is

$$\begin{aligned} \tilde{V}_0^{(p)}(x) &:= \tilde{U}_0^{(p)}(x) = \sqrt{1 + (\lambda x)^2} \sum_{l=1}^L p_l e^{i\theta_0 P_l} + \sum_{s=2}^{s_c} F_{0,s}(x) \\ &= \mu_0^{(p)}(x) \left( \text{Pr}_0^{(p)}(1) V_{0,1}^{(p)} + \sum_{s=2}^{s_c} \text{Pr}_0^{(p)}(s) V_{0,s}^{(p)} \right), \end{aligned} \quad (\text{F5})$$

where

$$\begin{aligned} \mu_0^{(p)}(x) &:= \sqrt{1 + (\lambda x)^2} + \sum_{s=2}^{s_c} \|F_{0,s}(x)\|_1 \\ &\leq \sqrt{1 + (\lambda x)^2} + (e^{\lambda x} - 1 - \lambda x), \\ \text{Pr}_0^{(p)}(s) &:= \frac{1}{\mu_0^{(p)}(x)} \begin{cases} \sqrt{1 + (\lambda x)^2}, & s = 1, \\ \|F_{0,s}(x)\|_1 = \frac{(\lambda x)^s}{s!}, & s = 2, 3, \dots, s_c, \end{cases} \\ V_{0,s}^{(p)} &:= \begin{cases} \sum_l p_l e^{i\theta_0 P_l}, & s = 1, \\ \sum_{l_{1:s}} p_{l_{1:s}}^{(s)} (-i)^s P_{l_{1:s}}^{(s)}, & s = 2, 3, \dots, s_c. \end{cases} \end{aligned} \quad (\text{F6})$$

After ‘‘pairing’’ the terms with  $s = 0$  and  $s = 1$ , we obtain Eq. (F5) which is a new LCU formula with the 1-norm  $\mu_0^{(p)}(x)$ .

We have the following proposition to characterize the LCU formula in Eq. (F5).

**Proposition 6** (0th-order Trotter-LCU formula by paired Taylor-series compensation). For  $x \geq 0$  and  $s_c \geq 2$ ,  $\tilde{V}_0^{(p)}(x)$  in Eq. (F5) is a  $(\mu_0^{(p)}(x), \varepsilon_0^{(p)}(x))$ -LCU formula of  $V_0(x) = U(x)$  with

$$\begin{aligned}\mu_0^{(p)}(x) &\leq e^{\frac{3}{2}(\lambda x)^2}, \\ \varepsilon_0^{(p)}(x) &\leq \left(\frac{e\lambda x}{s_c + 1}\right)^{s_c + 1}.\end{aligned}\tag{F7}$$

*Proof.* For the normalization factor, we have

$$\begin{aligned}\mu_0^{(p)}(x) &\leq \sqrt{1 + (\lambda x)^2} + (e^{\lambda x} - 1 - \lambda x) \\ &\leq 1 + \frac{1}{2}(\lambda x)^2 + (e^{\lambda x} - 1 - \lambda x) \\ &= e^{\lambda x} - \lambda x + \frac{1}{2}(\lambda x)^2 \\ &\leq e^{(\lambda x)^2} + \frac{1}{2}(\lambda x)^2 \\ &\leq e^{\frac{3}{2}(\lambda x)^2}.\end{aligned}\tag{F8}$$

The fourth inequality is due to  $e^x - x \leq e^{x^2}$  for  $x \in \mathbb{R}$ .

The proof of the distance bound  $\varepsilon_0^{(p)}(x)$  is the same as the one of  $\varepsilon_0(x)$  in Proposition 3.  $\square$

Now, we consider the Trotter-LCU formula  $\tilde{U}_0^{(p)}(x)$  in Eq. (F5) for both random-sampling and coherent usages.

For the random-sampling implementation, the overall LCU formula for  $U(t)$  is to repeat  $\tilde{U}_0^{(p)}(x)$  for  $\nu$  times,  $\tilde{U}_{0,tot}^{(p)}(t) = \tilde{U}_0^{(p)}(x)^\nu$ . Using Proposition 2 and 6, we conclude that  $\tilde{U}_{0,tot}^{(p)}(t)$  is a  $(\mu_{0,tot}^{(p)}(t), \varepsilon_{0,tot}^{(p)}(t))$ -LCU formula of  $U(t)$  with

$$\begin{aligned}\mu_{0,tot}^{(p)}(t) &= \mu_0^{(p)}(x)^\nu \leq e^{\frac{3}{2}\frac{(\lambda t)^2}{\nu}}, \\ \varepsilon_{0,tot}^{(p)}(t) &\leq \nu \mu_{0,tot}^{(p)}(t) \varepsilon_0^{(p)}(x) \leq \nu e^{\frac{3}{2}\frac{(\lambda t)^2}{\nu}} \left(\frac{e\lambda x}{s_c + 1}\right)^{s_c + 1}.\end{aligned}\tag{F9}$$

To realize a  $(\mu, \varepsilon)$ -LCU formula for  $U(t)$ , we only need to set the segment number  $\nu$  and the truncation order  $s_c$  to be

$$\begin{aligned}\nu &\geq \frac{3}{2} \frac{(\lambda t)^2}{\ln \mu}, \\ s_c &\geq \left\lceil \frac{\ln \left(\frac{3\mu(\lambda t)^2}{2 \ln(\mu)\varepsilon}\right)}{W_0 \left(\frac{3\lambda t}{2\varepsilon \ln(\mu)} \ln \left(\frac{3\mu(\lambda t)^2}{2 \ln(\mu)\varepsilon}\right)\right)} - 1 \right\rceil,\end{aligned}\tag{F10}$$

To derive the bound for  $s_c$  in the second line, we use Lemma 8. Based on Eq. (D33), the gate complexity of the 0th-order Trotter-LCU algorithm is then

$$\mathcal{O}(\nu s_c) = \mathcal{O}\left((\lambda t)^2 \frac{\log(1/\varepsilon)}{\log \log(1/\varepsilon)}\right).\tag{F11}$$

We remark that, comparing to other Trotter-LCU algorithms, this 0th-order random-sampling algorithm has a unique property that it is independent of the number of terms  $L$  in the Hamiltonian decomposition. This will make it especially useful in the quantum chemistry tasks [11, 23].

From Eq. (F10) we can see that, different from introducing Trotter formulas in Sec. E2, we can also eliminate the first-order term of  $x$  in the LCU formula by constructing Pauli rotation unitaries. This enable us to consider an efficient random-sampling implementation of Trotter-LCU formula.

For the coherent implementation, to apply Corollary 1, we need to set

$$\mu_0^{(p)}(x) \leq 2 \Leftrightarrow x = \frac{1}{\lambda} \sqrt{\frac{2}{3} \ln 2}.\tag{F12}$$



Therefore, the number of segments  $\nu$  is then

$$\nu = \frac{t}{x} = \frac{\sqrt{3}\lambda t}{\sqrt{2\ln 2}} = \mathcal{O}(\lambda t). \quad (\text{F13})$$

As a result, the smaller value of  $\mu(x)$  for each segment is not helpful to reduce the number of segments  $\nu$  for the coherent implementation of LCU. The truncation order analysis for  $s_c$  is similar to the one in Sec. E1. We also have  $s_c = \mathcal{O}(\log(1/\varepsilon)/\log\log(1/\varepsilon))$ .

We remark that, in Ref. [23], Wan et al. propose an alternative way to construct LCU based on the paired Taylor-series compensation. Instead of pairing the first two terms with  $s = 0$  and 1, they consider to pair all the expansion orders by grouping the  $s$ -th and  $(s + 1)$ -th expansion terms with even  $s$ ,

$$\begin{aligned} V_0(x) &= \sum_{s=0}^{\infty} F_{0,s}(x) = \sum_{s:\text{even}} \frac{(-ix)^s}{s!} H^s \left( I - i \frac{x}{s+1} H \right) \\ &= \sum_{s:\text{even}} \frac{(\lambda x)^s}{s!} (-iH)^s \sum_{\nu'} p_{\nu'} \left( I - i \frac{x}{s+1} P_{\nu'} \right). \end{aligned} \quad (\text{F14})$$

Applying Eq. (D61) to Eq. (F14), we have,

$$\begin{aligned} V_0(x) &= \sum_{s:\text{even}} \frac{(\lambda x)^s}{s!} (-iH)^s \sum_{\nu'} p_{\nu'} \left( I - i \frac{\lambda x}{s+1} P_{\nu'} \right) \\ &= \sum_{s:\text{even}} \frac{(\lambda x)^s}{s!} \sqrt{1 + \left( \frac{\lambda x}{s+1} \right)^2} \sum_{l_1, \dots, l_s; l'} p_{l_1} \dots p_{l_s} p_{l'} (-i)^s (P_{l_1} \dots P_{l_s} W_{s;l'}) \end{aligned} \quad (\text{F15})$$

where  $W_{s;l'} := e^{i\theta_s P_{l'}}$  is a Pauli rotation gate with the rotation angle  $\theta_s := \tan^{-1}(-\lambda x/(s+1))$ . In Ref. [23], the authors prove that the 1-norm of  $V_0(x)$  in Eq. (F15) satisfies

$$\|V_0(x)\|_1 \leq e^{(\lambda x)^2}, \quad (\text{F16})$$

which owns the same  $x$ -order as  $\mu_0^{(p)}(x)$  in Eq. (F9) but with an improved overhead. This full-order-pairing approach takes advantage of the simple structure of  $V_0(x)$ , since the  $(s+1)$ -order term  $F_{0,s+1}(x)$  differs from the neighboring term  $F_{0,s}(x)$  only by an operator of  $H$ . In what follows, we are going to consider the Trotter remainders  $V_K(x)$  which cannot be written as a single exponential term. To this end, we will mainly consider the ‘‘leading-order’’ pairing method [22], where the meaning of leading orders will be clarified soon.

## 2. First-order case

Now, we consider the 1st-order Trotter remainder  $V_1(x)$  in Eq. (E25). From Eq. (E25) and Eq. (E27) we can directly expand  $V_1(x)$  in the following form,

$$\begin{aligned} V_1(x) &= I + \sum_{s=2}^{\infty} F_{1,s}(x), \\ F_{1,s}(x) &= \sum_{r+\sum \vec{r}=s} \frac{(\lambda x)^r}{r!} \left( \prod \frac{(\vec{\alpha} x)^{\vec{r}}}{\vec{r}!} \right) \sum_{l_{1:r}} p_{l_{1:r}}^{(r)} (-i)^{2r-s} P_{l_{1:r}}^{(r)} \prod \vec{P}^{\vec{r}} \\ &= \eta_s \sum_{r, \vec{r}} \Pr(r, \vec{r}|s) \sum_{l_{1:r}} p_{l_{1:r}}^{(r)} (-i)^{2r-s} P_{l_{1:r}}^{(r)} \prod \vec{P}^{\vec{r}} = \eta_s V_{1,s}(x). \end{aligned} \quad (\text{F17})$$

Recall that  $\eta_s = (2\lambda x)^s/s!$ . Here, the  $s$ th-order expansion term  $F_{1,s}(x)$  is written as a summation of Pauli operators  $P_{l_{1:r}}^{(r)} \prod \vec{P}^{\vec{r}}$ . The conditional probability  $\Pr(r, \vec{r}|s)$  is the multinomial distribution  $\text{Mul}(r, \vec{r}; \{\frac{1}{2}, \frac{\vec{r}}{2}\}; s)$  defined in Eq. (E21).

For the convenience of later discussion, we simplify the notation of  $F_{1,s}(x)$  as follows,

$$F_{1,s}(x) = \eta_s \sum_{r, \gamma} \Pr(r, \gamma|s) P_1(r, \gamma), \quad (\text{F18})$$

where  $\gamma$  is used to denote all the expansion variables  $\{\vec{r}, l_{1:r}\}$  besides  $r$ .  $\Pr(r, \gamma|s)$  and  $P_1(r, \gamma)$  are then defined as

$$\begin{aligned} \Pr(r, \gamma|s) &:= \Pr(r, \vec{r}|s) p_{l_{1:r}}^{(r)}, \\ P_1(r, \gamma) &:= (-i)^{2r-s} P_{l_{1:r}}^{(r)} \prod_{\vec{r}} \vec{P}^{\vec{r}}. \end{aligned} \quad (\text{F19})$$

Note that, the multiplication of Pauli operators may generate imaginary global phase, making the operator anti-Hermitian. If we want to pair the expansion term  $F_{1,s}(x)$  with  $I$  using the Euler's formula in Eq. (D61), we have to make sure that the Pauli operators  $P_1(r, \gamma)$  with  $r + \vec{r} = s$  are all with imaginary coefficients  $i$  or  $-i$ . This, however, does not hold in general. One can classify the Pauli decomposition terms of  $F_{1,s}$  in Eq. (F17) into Hermitian and anti-Hermitian types,

$$F_{1,s}(x) = \eta_s \sum_{\{r, \gamma\} \in \text{Her}} \Pr(r, \gamma|s) P_{1,s}(r, \gamma) + i\eta_s \sum_{\{r, \gamma\} \in \text{anti-Her}} \Pr(r, \gamma|s) (-i) P_{1,s}(r, \gamma), \quad (\text{F20})$$

where  $\{r, \gamma\} \in \text{Her}$  and  $\{r, \gamma\} \in \text{anti-Her}$ , respectively, indicates the set of  $\{r, \gamma\}$  such that  $P_1(r, \gamma)$  is Hermitian and anti-Hermitian. When  $\{r, \gamma\} \in \text{Her}$ , the corresponding Pauli operator owns a real coefficient, which cannot be paired with  $I$  based on the Euler's formula.

On the other hand, we can write the exponential form of  $V_1(x)$  by applying the BCH formula on the definition of  $V_1(x)$  in Eq. (D14),

$$V_1(x) = \exp(i(E_{1,2}x^2 + E_{1,3}x^3 + E_{1,4}x^4 + \dots)), \quad (\text{F21})$$

where  $\{E_{1,s}\}$  are some Hermitian operators. The first order term  $E_{1,1}$  vanishes due to the order condition in Lemma 4. From Eq. (F21) we have

$$\begin{aligned} F_{1,2}(x) &= ix^2 E_{1,2}, \\ F_{1,3}(x) &= ix^3 E_{1,3} \end{aligned} \quad (\text{F22})$$

by the Taylor-series expansion on Eq. (F21).

Comparing Eq. (F17) and Eq. (F22), we can see that

$$\sum_{\{r, \gamma\} \in \text{Her}} \Pr(r, \gamma|s) P_{1,s}(r, \gamma), \quad s = 2, 3. \quad (\text{F23})$$

This is because  $F_{1,2}(x)$  and  $F_{1,3}(x)$  are anti-Hermitian from Eq. (F22).

From Eq. (F20) and Eq. (F23) we can modify the form of  $F_{1,s}(x)$  ( $s = 2$  or  $3$ ) as follows,

$$\begin{aligned} F_{1,s}(x) &= \eta_s \sum_{\{r, \gamma\} \in \text{Her}} \Pr(r, \gamma|s) P_{1,s}(r, \gamma) + i \sum_{\{r, \gamma\} \in \text{anti-Her}} \Pr(r, \gamma|s) (-i) P_{1,s}(r, \gamma), \\ &= i\eta_s \sum_{\{r, \gamma\} \in \text{Her}} \Pr(r, \gamma|s) P_{1,s}(r, \gamma) + i \sum_{\{r, \gamma\} \in \text{anti-Her}} \Pr(r, \gamma|s) (-i) P_{1,s}(r, \gamma), \\ &= i\eta_s \sum_{r, \gamma} \Pr(r, \gamma|s) (-i)^{\mathbb{1}_{[P_{1,s}(r, \gamma): \text{anti-Her}]}} P_{1,s}(r, \gamma). \end{aligned} \quad (\text{F24})$$

In Eq. (F24), we intentionally add an extra phase  $i$  on the terms with Hermitian Pauli operators, which has no effect on  $F_{1,s}(x)$  as they own zero summation value. In this way, all the Pauli expansion terms in  $F_{1,2}(x)$  and  $F_{1,3}(x)$  are with imaginary coefficient, which can be paired with  $I$  using the Euler's formula in Eq. (D61). We call the 2nd- and 3rd-order terms the leading orders. Why we still keep the Hermitian terms with zero summation value? The major reason is that we want to simplify the sampling procedure for the variables  $r, \vec{r}$  and  $l_1, \dots, l_r$  in the random-sampling implementation: when all the Hermitian terms are kept, the expansion variables  $r, \vec{r}$  and  $l_1, \dots, l_r$  can be sampled from  $\Pr(r, \gamma)$  defined in Eq. (F19). In this way, the variables  $\{r, \vec{r}\}$  follows a simple multinomial distribution  $\text{Mul}(r, \vec{r}; \{\frac{1}{2}, \frac{\vec{p}}{2}\}; s)$  defined in Eq. (E21) while  $\{l_1, l_2, \dots, l_r\}$  are sampled identically and independently from  $\vec{p}$ .

Now we are going to construct the LCU formula with the expansion-order pairing. Similar to Eq. (E19), we now

expand  $V_1(x)$  as

$$\begin{aligned}
V_1(x) &= I + \sum_{s=2}^3 F_{1,s}(x) + \sum_{s>3} F_{1,s}(x), \\
F_{1,s}(x) &= i\eta_s V'_{1,s} = i\eta_s \sum_{r,\gamma} \Pr(r,\gamma|s) (-i)^{\mathbb{1}[P_{1,s}(r,\gamma):\text{anti-Her}]} P_{1,s}(r,\gamma), \quad s = 2, 3 \\
F_{1,s}(x) &= \eta_s V_{1,s} = \eta_s \sum_{r,\gamma} \Pr(r,\gamma|s) (-i)^{2r-s} P_{1,s}(r,\gamma), \quad s \geq 4.
\end{aligned} \tag{F25}$$

As is introduced in Eq. (F24), we modify the phase of the Hermitian terms in  $F_{1,2}(x)$  and  $F_{1,3}(x)$  for the later usage of pairing. In this way, the operator

$$P'_{1,s}(r,\gamma) := (-i)^{\mathbb{1}[P_{1,s}(r,\gamma):\text{anti-Her}]} P_{1,s}(r,\gamma), \quad s = 2, 3 \tag{F26}$$

is always a Pauli operator with a real coefficient. The higher-order terms with  $s \geq 4$  is the same as the direct Taylor-series expansion in Eq. (E19) and Eq. (E20).

Now, we pair  $I$  with the Pauli operators in  $F_{1,2}(x)$  and  $F_{1,3}(x)$ ,

$$\begin{aligned}
V_1(x) &= I + i\eta_2 V'_{1,2} + i\eta_3 V'_{1,3} + \sum_{s=4}^{\infty} \eta_s V_{1,s} \\
&= \frac{\eta_2}{\eta_\Sigma} (I + \eta_\Sigma V'_{1,2}(x)) + \frac{\eta_3}{\eta_\Sigma} (I + \eta_\Sigma V'_{1,3}(x)) + \sum_{s=4}^{\infty} \eta_s V_{1,s} \\
&= \sqrt{1 + \eta_\Sigma^2} \left( \frac{\eta_2}{\eta_\Sigma} R_{1,2}(\eta_\Sigma) + \frac{\eta_3}{\eta_\Sigma} R_{1,3}(\eta_\Sigma) \right) + \sum_{s=4}^{\infty} \eta_s V_{1,s} =: V_1^{(p)}(x).
\end{aligned} \tag{F27}$$

Here,  $\eta_\Sigma := \eta_2 + \eta_3$ . In the third line, we apply the following pairing procedure,

$$\begin{aligned}
I + \eta_\Sigma V'_{1,s} &= I + i\eta_\Sigma \sum_{r,\gamma} \Pr(r,\gamma|s) P'_{1,s}(r,\gamma) \\
&= \sum_{r,\gamma} \Pr(r,\gamma|s) (I + \eta_\Sigma P'_{1,s}(r,\gamma)) \\
&= \sqrt{1 + \eta_\Sigma^2} \sum_{r,\gamma} \Pr(r,\gamma|s) \exp(i\theta(\eta_\Sigma) P'_{1,s}(r,\gamma)) \\
&=: \sqrt{1 + \eta_\Sigma^2} R_{1,s}(\eta_\Sigma), \quad s = 2, 3.
\end{aligned} \tag{F28}$$

In practice, we introduce a truncation  $s_c$  on the expansion formula in Eq. (F27). For the convenience of analysis, we set  $s_c > 3$ . The truncated LCU formula for  $V_1^{(p)}(x)$  is then

$$\begin{aligned}
\tilde{V}_1^{(p)}(x) &= \sqrt{1 + \eta_\Sigma^2} \left( \frac{\eta_2}{\eta_\Sigma} R_{1,2}(\eta_\Sigma) + \frac{\eta_3}{\eta_\Sigma} R_{1,3}(\eta_\Sigma) \right) + \sum_{s=4}^{s_c} \eta_s V_{1,s}, \\
&= \mu_1^{(p)}(x) \left( \sum_{s=2,3} \Pr_1^{(p)}(s) R_{1,s}(\eta_\Sigma) + \sum_{s=4}^{s_c} \Pr_1^{(p)}(s) V_{1,s} \right),
\end{aligned} \tag{F29}$$

where the 1-norm and probabilities are

$$\begin{aligned}
\mu_1^{(p)}(x) &= \sqrt{1 + \eta_\Sigma^2} + \sum_{s=4}^{s_c} \eta_s, \\
\Pr_1^{(p)}(s) &= \frac{1}{\mu_1^{(p)}(x)} \begin{cases} \sqrt{1 + \eta_\Sigma^2} \frac{\eta_s}{\eta_\Sigma}, & s = 2, 3, \\ \eta_s, & s = 4, 5, \dots, s_c. \end{cases}
\end{aligned} \tag{F30}$$

Combined with the deterministic first-order Trotter formula, the overall LCU formula for  $U(x)$  is

$$\tilde{U}_1^{(p)}(x) = \tilde{V}_1^{(p)}(x) S_1(x). \tag{F31}$$

Note that, the value of  $\tilde{V}_1^{(p)}(x)$  and  $\tilde{U}_1^{(p)}(x)$  in Eq. (F29) and Eq. (F31) are, respectively, the same as the truncated value of  $\tilde{V}_1(x)$  and  $\tilde{U}_1(x)$  in Eq. (E26) and Eq. (E28). The difference is that we choose a different way to construct the LCU formulas. The following proposition gives the performance characterization of  $\tilde{U}_1^{(p)}(x)$  in Eq. (F31) to approximate  $U(x)$ .

**Proposition 7** (1st-order Trotter-LCU formula by paired Taylor-series compensation). *For  $0 < x < 1/(2\lambda)$  and  $s_c \geq 3$ ,  $\tilde{V}_1(x)$  in Eq. (F29) is a  $(\mu_1^{(p)}(x), \varepsilon_1^{(p)}(x))$ -LCU formula of the first-order Trotter remainder  $V_1(x)$  with*

$$\begin{aligned}\mu_1^{(p)}(x) &\leq e^{(e+\frac{2}{9})(2\lambda x)^4}, \\ \varepsilon_1^{(p)}(x) &\leq \left(\frac{2e\lambda x}{s_c+1}\right)^{s_c+1}.\end{aligned}\tag{F32}$$

As a result,  $\tilde{U}_1(x)$  in Eq. (F31) is a  $(\mu_1^{(p)}(x), \varepsilon_1^{(p)}(x))$ -LCU formula of  $U(x)$ .

*Proof.* We first bound the normalization factor  $\mu_1^{(p)}(x)$ . When  $2\lambda x < 1$  we have

$$\begin{aligned}\mu_1^{(p)}(x) &\leq \sqrt{1 + (\eta_\Sigma)^2} + \sum_{s=4}^{\infty} \eta_s \\ &\leq 1 + \frac{1}{2}\eta_\Sigma^2 + \left(e^{2\lambda x} - \sum_{s=0}^3 \eta_s\right) \\ &= \frac{1}{2}(2\lambda x)^4 \left(\frac{1}{2!} + \frac{(2\lambda x)}{3!}\right)^2 + \left(e^{2\lambda x} - \sum_{s=1}^3 \eta_s\right) \\ &\leq \frac{1}{2}(2\lambda x)^4 \left(\frac{1}{2} + \frac{1}{6}\right)^2 + \left(e^{2\lambda x} - \sum_{s=1}^3 \eta_s\right) \\ &\leq \frac{2}{9}(2\lambda x)^4 + e^{e(2\lambda x)^4} \\ &\leq e^{(e+\frac{2}{9})(2\lambda x)^4}.\end{aligned}\tag{F33}$$

The distance bound can be derived in the same manner as the one in Proposition 5.  $\square$

Now, we analyze the performance of the Trotter-LCU formula  $\tilde{U}_1^{(p)}(x)$  in Eq. (F31) for both random-sampling and coherent usages.

For the random-sampling implementation, the overall LCU formula for  $U(t)$  is to repeat  $\tilde{U}_1(x)$  for  $\nu$  times,  $\tilde{U}_{1,tot}^{(p)}(t) = \left(\tilde{U}_1^{(p)}(x)\right)^\nu$ . Using Proposition 2 and 7, we conclude that  $\tilde{U}_{1,tot}(t)$  is a  $(\mu_{1,tot}^{(p)}(t), \varepsilon_{1,tot}^{(p)}(t))$ -LCU formula of  $U(t)$  with

$$\begin{aligned}\mu_{1,tot}^{(p)}(t) &= \mu_1^{(p)}(x)^\nu \leq e^{(e+\frac{2}{9})\frac{(2\lambda t)^4}{\nu^3}}, \\ \varepsilon_{1,tot}^{(p)}(t) &\leq \nu \mu_{1,tot}^{(p)}(t) \varepsilon_0(x) \leq \nu e^{(e+\frac{2}{9})\frac{(2\lambda t)^4}{\nu^3}} \left(\frac{2e\lambda x}{s_c+1}\right)^{s_c+1}.\end{aligned}\tag{F34}$$

To realize a  $(\mu, \varepsilon)$ -LCU formula for  $U(t)$ , we only need to set the segment number  $\nu$  and the truncation order  $s_c$  to be

$$\begin{aligned}\nu &\geq \max\{\nu_1(t), 2\lambda t\}, \\ s_c &\geq \max\left\{\left\lceil \frac{\ln\left(\frac{\mu}{\varepsilon}\nu_1(t)\right)}{W_0\left(\frac{1}{2e\lambda t}\nu_1(t)\ln\left(\frac{\mu}{\varepsilon}\nu_1(t)\right)\right)} \right\rceil, 3\right\},\end{aligned}\tag{F35}$$

Here,  $\nu_1(t) := \left(\frac{e+\frac{2}{9}}{\ln \mu}\right)^{\frac{1}{3}} (2\lambda t)^{\frac{4}{3}}$ . To derive the bound for  $s_c$  in the second line, we use Lemma 8. Based on Eq. (D33), the gate complexity of the 1st-order Trotter-LCU algorithm is then

$$\mathcal{O}(\nu s_c) = \mathcal{O}\left((\lambda t)^{1+\frac{1}{3}} \frac{\log(1/\varepsilon)}{\log \log(1/\varepsilon)}\right).\tag{F36}$$

For the coherent implementation of  $U_1(x)$ , to apply Corollary 1, we need to set

$$\mu_1^{(p)}(x) \leq 2 \Leftrightarrow x = \frac{1}{2\lambda} \sqrt{\frac{2}{3} \ln 2}. \quad (\text{F37})$$

Therefore, the number of segments  $\nu$  is then

$$\nu = \frac{t}{x} = \frac{\sqrt{3}\lambda t}{\sqrt{2 \ln 2}} = \mathcal{O}(\lambda t). \quad (\text{F38})$$

Similar to the direct Taylor-series expansion case, the smaller value of  $\mu(x)$  for each segment is not helpful to reduce the number of segments  $\nu$  for the coherent implementation of LCU. The truncation order analysis for  $s_c$  is similar to the one in Sec. E1. We also have  $s_c = \mathcal{O}(\log(1/\varepsilon)/\log \log(1/\varepsilon))$ .

### 3. Second- and higher-order case

In this section, we consider the  $2k$ th-order case. We will take the 2nd-order case as an example. From Eq. (E41) we know that the 2nd-order Trotter remainder can be expanded as

$$\begin{aligned} V_2(x) &= I + \sum_{s=3}^{\infty} F_{2,s}, \\ F_{2,s} &= \eta_s \sum_{r, \vec{r}, \vec{r}'} \Pr(r, \vec{r}, \vec{r}' | s) \sum_{l_{1:r}} p_{l_{1:r}}^{(r)} (-i)^{2r-s} P_{l_{1:r}}^{(r)} \prod_{\vec{r}} \overrightarrow{P}^{\vec{r}} \prod_{\vec{r}'} \overleftarrow{P}^{\vec{r}'}. \end{aligned} \quad (\text{F39})$$

where  $\Pr(r, \vec{r}, \vec{r}' | s)$  is the multinomial distribution  $\text{Mul}(\{r, \vec{r}, \vec{r}'\}; \{\frac{1}{2}, \frac{\vec{r}}{4}, \frac{\vec{r}'}{4}\}; s)$ .

If we write  $V_2(x)$  in the exponential form, we have

$$V_2(x) = \exp\left(i \sum_{r=1}^{\infty} E_{2,r} x^r\right), \quad (\text{F40})$$

which can be obtained by applying the BCH formula to the definition of  $V_2(x)$  in Eq. (E45). Here,  $\{E_{2,s}\}$  are Hermitian operators due to the unitarity of  $V_2(x)$  for all  $x \in \mathbb{R}$ . Based on the order condition in Lemma 1, we have

$$E_{2,1} = E_{2,2} = 0. \quad (\text{F41})$$

We can then simplify  $V_2(x)$  as

$$V_2(x) = \exp(i(E_{2,3}x^3 + E_{2,4}x^4 + E_{2,5}x^5 + \dots)), \quad (\text{F42})$$

If we expand  $V_2(x)$  in Eq. (F42) as follows,

$$V_2(x) = I + \sum_{s=3}^5 F_{2,s}(x) + \sum_{s=6}^{\infty} F_{2,s}(x), \quad (\text{F43})$$

we have

$$F_{2,s}(x) = ix^s E_{2,s}, \quad s = 3, 4, 5, \quad (\text{F44})$$

This implies that the expansion terms  $\{F_{2,s}(x)\}$  with  $s = 3, 4, 5$  are anti-Hermitian, which can be paired with  $I$  to suppress the 1-norm. We call these terms the leading order terms in the expansion of  $V_2^{(p)}(x)$ . Compare the direct Pauli expansion of  $F_{2,s}$  in Eq. (F39) and Eq. (F44), we conclude that the summation of all the Hermitian terms in  $F_{2,s}(x)$  ( $s = 3, 4, 5$ ) is zero. Similar to the 1st-order case in Sec. F2, we introduce extra  $i$  phase for these Hermitian terms and modify the leading-order terms  $F_{2,s}(x)$  ( $s = 3, 4, 5$ ) as follows,

$$F_{2,s}(x) = i\eta_s V'_{2,s}(x) = i\eta_s \sum_{r,\gamma} \Pr(r, \gamma | s) (-i)^{\mathbb{1}[P_{2,s}(r,\gamma):\text{anti-Her}]} P_2(r, \gamma). \quad (\text{F45})$$

Here,  $\mathbb{1}[P_{2,s}(r, \gamma) : \text{anti-Her}]$  is the indicator of whether

$$P_2(r, \gamma) := (-i)^{2r-s} \overleftarrow{\prod} \vec{P}^{r'} P_{1:r}^{(r)} \overrightarrow{\prod} \vec{P}^{r'}, \quad (\text{F46})$$

is anti-Hermitian. In this way, the operator

$$P'_2(r, \gamma) := (-i)^{\mathbb{1}[P_{2,s}(r, \gamma) : \text{anti-Her}]} P_2(r, \gamma), \quad (\text{F47})$$

will always be a Hermitian Pauli operator. The higher-order terms  $F_{2,s}(x)$  with  $s \geq 6$  are kept invariant.

Now, we pair  $I$  with the Pauli operators in the leading-order terms  $F_{2,s}(x)$  ( $s = 3, 4, 5$ ),

$$\begin{aligned} V_2(x) &= I + \sum_{s=3}^5 \eta_s V'_{2,s} + \sum_{s=6}^{\infty} \eta_s V_{2,s}^{(p)} \\ &= \sum_{s=3}^5 \frac{\eta_s}{\eta_\Sigma} (I + \eta_\Sigma V'_{2,s}) + \sum_{s=6}^{\infty} \eta_s V_{2,s} \\ &= \sqrt{1 + \eta_\Sigma^2} \sum_{s=3}^5 \left( \frac{\eta_s}{\eta_\Sigma} R_{2,s}(\eta_\Sigma) \right) + \sum_{s=6}^{\infty} \eta_s V_{2,s} =: V_2^{(p)}(x) \end{aligned} \quad (\text{F48})$$

where  $\eta_\Sigma := \sum_{s=3}^5 \eta_s$ . In the third line, we apply the following pairing procedure based on the Euler's formula,

$$\begin{aligned} I + \eta_\Sigma V'_{2,s} &= I + i\eta_\Sigma \sum_{r, \gamma} \text{Pr}(r, \gamma | s) P'_{2,s}(r, \gamma) \\ &= \sum_{r, \gamma} \text{Pr}(r, \gamma | s) (I + \eta_\Sigma P'_{2,s}(r, \gamma)) \\ &= \sqrt{1 + \eta_\Sigma^2} \sum_{r, \gamma} \text{Pr}(r, \gamma | s) \exp(i\theta(\eta_\Sigma) P'_{2,s}(r, \gamma)) \\ &=: \sqrt{1 + \eta_\Sigma^2} R_{2,s}^{(p)}(\eta_\Sigma), \quad s = 3, 4, 5. \end{aligned} \quad (\text{F49})$$

In practice, we introduce a truncation  $s_c$  to the expansion. For the convenience of analysis, we set  $s_c > 5$ . The truncated LCU formula is

$$\begin{aligned} \tilde{V}_2^{(p)}(x) &= \sqrt{1 + (\eta_\Sigma)^2} \sum_{s=3}^5 \left( \frac{\eta_s}{\eta_\Sigma} R_{2,s}(\eta_\Sigma) \right) + \sum_{s=6}^{s_c} \eta_s V_{2,s} \\ &= \mu_2^{(p)}(x) \left( \sum_{s=3}^5 \text{Pr}_2^{(p)}(s) R_{2,s}^{(p)}(\eta_\Sigma) + \sum_{s=6}^{s_c} \text{Pr}_2^{(p)}(s) V_{2,s}^{(p)} \right), \end{aligned} \quad (\text{F50})$$

where the 1-norm and probabilities are

$$\begin{aligned} \mu_2^{(p)}(x) &= \sqrt{1 + \eta_\Sigma^2} + \sum_{s=6}^{s_c} \eta_s, \\ \text{Pr}_2^{(p)}(s) &= \frac{1}{\mu_2^{(p)}(x)} \begin{cases} \sqrt{1 + \eta_\Sigma^2} \frac{\eta_s}{\eta_\Sigma}, & s = 3, 4, 5, \\ \eta_s, & s = 6, 7, \dots, s_c. \end{cases} \end{aligned} \quad (\text{F51})$$

Combined with the deterministic second-order Trotter formula, the overall LCU formula for  $U(x)$  is

$$\tilde{U}_2^{(p)}(x) = \tilde{V}_2^{(p)}(x) S_2(x). \quad (\text{F52})$$

The derivation of the general  $2k$ th-order LCU formula  $\tilde{V}_{2k}^{(p)}(x)$  is similar to the second order case. We first simplify the expansion of  $V_{2k}$  in Eq. (E46),

$$V_{2k}(x) = \sum_{s=0}^{\infty} F_{2k,s}(x) = \sum_{s=0}^{\infty} \eta_s V_{2k,s}, \quad (\text{F53})$$

where

$$\begin{aligned}
F_{2k,s}(x) &= \eta_s \sum_{r,\gamma} \Pr(r, \gamma|s) P_{2k}(r, \gamma), \\
\Pr(r, \gamma|s) &:= \Pr(r, \vec{r}_{1:\kappa}, \vec{r}'_{1:\kappa}|s) \sum_{l_{1:r}} p_{l_{1:r}}^{(r)}, \\
P_{2k}(r, \gamma) &:= (-i)^{2r-s} \overleftarrow{\prod} \overleftarrow{P}^{\vec{r}'_{\kappa}} \dots \overleftarrow{\prod} \overleftarrow{P}^{\vec{r}'_2} \overleftarrow{\prod} \overleftarrow{P}^{\vec{r}'_1} \left( P_{l_{1:r}}^{(r)} \right) \overrightarrow{\prod} \overrightarrow{P}^{\vec{r}_1} \overleftarrow{\prod} \overleftarrow{P}^{\vec{r}_2} \dots \overrightarrow{\prod} \overrightarrow{P}^{\vec{r}_{\kappa}}.
\end{aligned} \tag{F54}$$

Here, we use  $\gamma$  to denote all the expansion variables  $\{\vec{r}_{1:\kappa}, \vec{r}'_{1:\kappa}, l_{1:r}\}$  besides  $r$ .

To study the properties of the expansion terms  $F_{2k,s}$  in Eq. (F54), we consider the exponential form of  $V_{2k}(x)$ ,

$$V_{2k}(x) = \exp \left( i \sum_{r=1}^{\infty} E_{2k,r} x^r \right). \tag{F55}$$

This can be derived from its definition in Eq. (D14) and the BCH formula. Here,  $\{E_{2k,r}\}$  are all Hermitian operators due to the unitarity of  $V_{2k}^{(p)}(x)$  for all  $x$ . Based on the order condition in Lemma 1, we have

$$E_{2k,1} = \dots = E_{2k,2k} = 0. \tag{F56}$$

Hence,

$$\begin{aligned}
V_{2k}(x) &= \exp \left( i(E_{2k,2k+1} x^{2k+1} + E_{2k,2k+2} x^{2k+3} + E_{2k,2k+3} x^{2k+5} + \dots) \right) \\
&= I + \sum_{s=2k+1}^{4k+1} F_{2k,s}^{(p)}(x) + \sum_{s=4k+2}^{\infty} F_{2k,s}^{(p)}(x),
\end{aligned} \tag{F57}$$

where the leading-order expansion terms  $\{F_{2k,s}\}$  with  $s = 2k+1, \dots, 4k+1$  satisfy

$$F_{2k,s}(x) = ix^s E_{2k,s}, \quad s = 2k+1, 2k+2, \dots, 4k+1. \tag{F58}$$

Comparing Eq. (F54) and Eq. (F58), we know that the summation of all the Hermitian terms in  $F_{2k,s}(x)$  ( $s = 2k+1, 2k+2, \dots, 4k+1$ ) in Eq. (F54) is zero. Similar to the 1st- and 2nd-order case, we introduce extra  $i$  phase for these Hermitian terms and modify the leading-order terms  $F_{2k,s}(x)$  ( $s = 2k+1, 2k+2, \dots, 4k+1$ ) as follows,

$$F_{2k,s}(x) = i\eta_s V'_{2k,s}(x) = i\eta_s \sum_{r,\gamma} \Pr(r, \gamma|s) (-i)^{\mathbb{1}[P_{2k,s}(r,\gamma):\text{anti-Her}]} P_{2k}(r, \gamma). \tag{F59}$$

Here,  $\mathbb{1}[P_{2k,s}(r, \gamma) : \text{anti-Her}]$  is the indicator of whether  $P_{2k}(r, \gamma)$  defined in Eq. (F54) is anti-Hermitian. In this way, the operator

$$P'_{2k}(r, \gamma) := (-i)^{\mathbb{1}[P_{2k,s}(r,\gamma):\text{anti-Her}]} P_{2k}(r, \gamma), \tag{F60}$$

will always be a Hermitian Pauli operator. The higher-order terms  $F_{2k,s}^{(p)}(x)$  with  $s \geq 4k+2$  will not participate in the pairing process, which are kept invariant.

Suppose the coefficient of  $V'_{2k,s}$  ( $s = 2k+1, \dots, 4k+1$ ) is  $y$ . If we pair the  $s$ th-order expansion term with the zeroth order term  $I$ , we will have

$$\begin{aligned}
I + yV'_{2k,s} &= \sum_{r,\gamma} \Pr(r, \gamma|s) \left( I + iy(-1)^{r-q} P'_{2k}(r, \gamma) \right) \\
&= \sqrt{1+y^2} \sum_{r,\gamma} \Pr(r, \gamma|s) e^{i\theta(y) P'_{2k}(r,\gamma)} \\
&=: \sqrt{1+y^2} R_{2k,2q+1}(y).
\end{aligned} \tag{F61}$$

where  $\theta(y) := \tan^{-1}(1+y^2)$ .

The LCU formula for the  $2k$ th-order Trotter remainder with paired Taylor-series compensation is then

$$\tilde{V}_{2k}^{(p)}(x) = \mu_{2k}^{(p)}(x) \left( \sum_{s=2k+1}^{4k+1} \Pr_{2k}^{(p)}(s) R_{2k,s}^{(p)}(\eta_{\Sigma}) + \sum_{s=4k+2}^{s_c} \Pr_{2k}^{(p)}(s) V_{2k,s}^{(p)} \right). \tag{F62}$$

where

$$\begin{aligned}
\mu_{2k}^{(p)}(x) &= \sqrt{1 + (\eta_\Sigma)^2} + \sum_{s=4k+2}^{s_c} \eta_s, \\
\eta_\Sigma &= \sum_{s=2k+1}^{4k+1} \eta_s, \\
\Pr(s) &= \frac{1}{\mu_{2k}^{(p)}(x)} \begin{cases} \sqrt{1 + (\eta_\Sigma)^2} \frac{\eta_s}{\eta_\Sigma}, & s = 2k+1, 2k+2, \dots, 4k+1, \\ \eta_s, & s = 4k+2, 4k+3, \dots, s_c. \end{cases}
\end{aligned} \tag{F63}$$

The Pauli rotation unitary  $R_{2k, 2q+1}^{(p)}$  is defined in Eq. (F61). Here, we introduce the truncation  $s_c$  in the formula. For the simplicity of analysis in Proposition 8, we assume  $s_c \geq 4k+1$ . When the truncation order is smaller than  $2k+1$ , there is no need to introduce LCU formulas since the accuracy of the  $2k$ th-order Trotter formula is enough; when the truncation order  $s_c$  satisfies  $2k+1 < s_c < 4k+1$ , we can then modify the definition of leading-order from  $(2k+1)$ th-order to  $(s_c)$ th-order. The analysis will be similar to the case of  $s_c \geq 4k+1$ .

Combined with the deterministic second-order Trotter formula, the overall LCU formula for  $U(x)$  is

$$\tilde{U}_{2k}^{(p)}(x) = \tilde{V}_{2k}^{(p)}(x) S_{2k}(x). \tag{F64}$$

The following proposition gives the performance characterization of  $\tilde{U}_{2k}^{(p)}(x)$  to approximate  $U(x)$ .

**Proposition 8** (*2kth-order Trotter-LCU formula by paired Taylor-series compensation*). *For  $0 < x < 1/(2\lambda)$  and  $s_c \geq 4k+1$ ,  $\tilde{V}_{2k}^{(p)}(x)$  in Eq. (F62) is a  $(\mu_{2k}^{(p)}(x), \varepsilon_{2k}^{(p)}(x))$ -LCU formula of  $V_{2k}(x)$  with*

$$\begin{aligned}
\mu_{2k}^{(p)}(x) &\leq e^{(e+c_k)(2\lambda x)^{4k+2}}, \\
\varepsilon_{2k}^{(p)}(x) &\leq \left( \frac{2e\lambda x}{s_c+1} \right)^{s_c+1}.
\end{aligned} \tag{F65}$$

Here,

$$c_k := \frac{1}{2} \left( \frac{e}{2k+1} \right)^{4k+2}, \tag{F66}$$

so that  $0.3 > c_k > 0$ . As a result,  $\tilde{U}_{2k}^{(p)}(x)$  in Eq. (F64) is a  $(\mu_{2k}^{(p)}(x), \varepsilon_{2k}^{(p)}(x))$ -LCU formula of  $U(x)$ .

*Proof.* We will focus on the case with  $k=1$ . The proof for a general  $k$  is similar. We first bound the normalization factor  $\mu_2^{(p)}(x)$ . When  $2\lambda x < 1$  we have

$$\begin{aligned}
\mu_2^{(p)}(x) &\leq \sqrt{1 + (\eta_\Sigma)^2} + \sum_{s=6}^{\infty} \eta_s \\
&\leq 1 + \frac{1}{2} \eta_\Sigma^2 + \left( e^{2\lambda x} - \sum_{s=0}^5 \eta_s \right) \\
&= \frac{1}{2} (2\lambda x)^6 \left( \frac{1}{3!} + \frac{2\lambda x}{4!} + \frac{(2\lambda x)^2}{5!} \right)^2 + \left( e^{2\lambda x} - \sum_{s=1}^5 \eta_s \right) \\
&\leq \frac{1}{2} (2\lambda x)^6 \left( \sum_{s=3}^{\infty} \frac{1}{3!} \right)^2 + \left( e^{2\lambda x} - \sum_{s=1}^5 \eta_s \right) \\
&\leq \frac{1}{2} \left( \frac{e}{3} \right)^6 (2\lambda x)^6 + e^{e(2\lambda x)^6} \\
&\leq e^{(e+c_1)(2\lambda x)^6}.
\end{aligned} \tag{F67}$$

In the fifth line, we use Corollary 2.

The distance bound can be derived in the same manner as the one in Proposition 5.  $\square$



Now, we consider the Trotter-LCU formula  $\tilde{U}_{2k}(x)$  in Eq. (E53) for both random-sampling and coherent usages. For the random-sampling implementation, we have the following theorem.

**Theorem 1** (Gate complexity of the  $K$ th-order random-sampling Trotter-LCU algorithm by paired Taylor-series compensation). *In a  $2k$ th-order Trotter-LCU algorithm, if the segment number  $\nu$  and the truncation order  $s_c$  satisfy*

$$\begin{aligned} \nu &\geq \max \left\{ \nu_{2k}^{(p)}(t), 2\lambda t \right\}, \\ s_c &\geq \max \left\{ \left\lceil \frac{\ln \left( \frac{\mu}{\varepsilon} \nu_{2k}^{(p)}(t) \right)}{W_0 \left( \frac{1}{2e\lambda t} \nu_{2k}^{(p)}(t) \ln \left( \frac{\mu}{\varepsilon} \nu_{2k}^{(p)}(t) \right) \right)} - 1 \right\rceil, 4k + 1 \right\}, \end{aligned} \quad (\text{F68})$$

we can then realize a  $(\mu, \varepsilon)$ -LCU formula for  $U(t)$  based on  $\nu$  segments of  $\tilde{U}_{2k}^{(p)}$  in Eq. (F64). Here,  $\nu_{2k}^{(p)}(t) := \left( \frac{2(e+c_k)\lambda t}{\ln \mu} \right)^{\frac{1}{4k+1}} 2\lambda t$  and  $c_k$  is defined in Eq. (F66). As a result, the gate complexity of random-sampling  $K$ th-order Trotter-LCU algorithm ( $K = 0, 1$  or  $2k$ ) based on paired Taylor-series compensation is

$$\mathcal{O} \left( (\lambda t)^{1+\frac{1}{2K+1}} (\kappa_K L + \frac{\log(1/\varepsilon)}{\log \log(1/\varepsilon)}) \right). \quad (\text{F69})$$

Here,  $\kappa_K = K$  if  $K = 0$  or  $1$ , or  $\kappa_K = 2 \cdot 5^{K/2-1}$  if  $K = 2k$ .

*Proof.* The case when  $K = 0$  or  $K = 1$  is discussed and analyzed in Proposition 6 and Proposition 7, respectively. We now focus on the case when  $K = 2k$ . For the random-sampling implementation, the overall LCU formula for  $U(t)$  is to repeat the sampling of  $\tilde{U}_{2k}^{(p)}(x)$  for  $\nu$  times,  $\tilde{U}_{2k,tot}^{(p)}(t) = \tilde{U}_{2k}^{(p)}(x)^\nu$ . Using Proposition 2 and 8, when  $0 < x < \frac{1}{2\lambda}$  and  $s_c \geq 4k + 1$ , we conclude that  $\tilde{U}_{2k,tot}^{(p)}(t)$  is a  $(\mu_{2k,tot}^{(p)}(t), \varepsilon_{2k,tot}^{(p)}(t))$ -LCU formula of  $U(t)$  with

$$\begin{aligned} \mu_{2k,tot}^{(p)}(t) &= \mu_{2k}^{(p)}(x)^\nu \leq e^{(e+c_k) \frac{(2\lambda t)^{4k+2}}{\nu^{4k+1}}}, \\ \varepsilon_{2k,tot}^{(p)}(t) &\leq \nu \mu_{2k,tot}^{(p)}(t) \varepsilon_{2k}^{(p)}(x) \leq \nu e^{(e+c_k) \frac{(2\lambda t)^{4k+2}}{\nu^{4k+1}}} \left( \frac{2e\lambda x}{s_c + 1} \right)^{s_c+1}. \end{aligned} \quad (\text{F70})$$

To realize a  $(\mu, \varepsilon)$ -LCU formula for  $U(t)$ , we only need to set the segment number  $\nu$  and the truncation order  $s_c$  to satisfy Eq. ((F68)). To derive the bound for  $s_c$  in the second line of Eq. ((F68)), we use Lemma 8. Based on Eq. (D33), the gate complexity of the  $2k$ th-order Trotter-LCU algorithm is then

$$\mathcal{O}(\nu(\kappa_K L + s_c)) = \mathcal{O} \left( (\lambda t)^{1+\frac{1}{4k+1}} (\kappa_K L + \frac{\log(1/\varepsilon)}{\log \log(1/\varepsilon)}) \right). \quad (\text{F71})$$

Here,  $\kappa_K$  is the stage number of the Trotter formula. When  $K = 0$ ,  $\kappa_K = 0$ . When  $K = 2k$ ,  $\kappa_K = 2 \cdot 5^{K/2-1}$ .  $\square$

We illustrate the random-sampling implementation of the PTSc formula in Eq. (F31) and Eq. (F64) in Fig. 9. The circuit of random-sampling implementation is the same as Fig. 8(a). We mainly set  $K = 1$  as an example due to its simplicity. For the higher-order case, the only difference is that the sampling of  $\vec{r}$  and  $\vec{r}'$  need to be the variables  $\vec{r}_{1:\kappa}$  and  $\vec{r}'_{1:\kappa}$  on multiple stages. The sampling probability  $\Pr(r, \vec{r}_{1:\kappa}, \vec{r}'_{1:\kappa} | s) := \text{Mul}(\{r, \vec{r}_{1:\kappa}, \vec{r}'_{1:\kappa}\}; \{\frac{1}{2}, \nu_{1:\kappa} \frac{\vec{p}}{2}, \nu_{1:\kappa} \frac{\vec{q}}{2}\}; s)$  is given in Eq. (E48).

For the coherent implementation of the PTSc formula in Eq. (F64), to apply Corollary 1, we need to set

$$\mu_{2k}^{(p)}(x) \leq 2 \Leftrightarrow x = \frac{1}{2\lambda} \left( \frac{\ln 2}{e + c_k} \right)^{\frac{1}{4k+2}}. \quad (\text{F72})$$

Therefore, the number of segments  $\nu$  is then

$$\nu = \frac{t}{x} = 2\lambda t \left( \frac{e + c_k}{\ln 2} \right)^{\frac{1}{4k+2}} = \mathcal{O}(\lambda t). \quad (\text{F73})$$

We can see that, the smaller value of  $\mu(x)$  for each segment is not helpful to reduce the number of segments  $\nu$  for the coherent implementation of LCU. The truncation order analysis for  $s_c$  is similar to the one in Sec. E1. We also have  $s_c = \mathcal{O}(\log(1/\varepsilon)/\log \log(1/\varepsilon))$ .

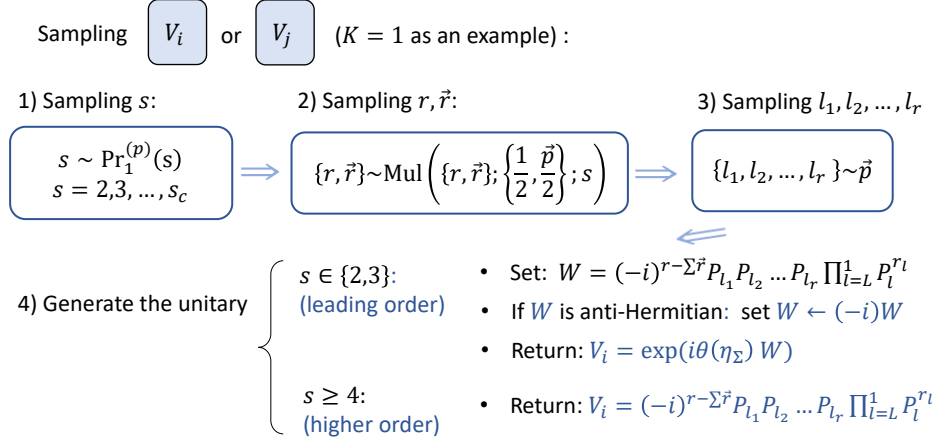

FIG. 9. The sampling procedure of  $V_i$  or  $V_j$  in the PTSc algorithm. We set  $K = 1$  as example.

### Appendix G: Trotter-LCU formula with nested-commutator compensation

In Sec. E and F, we discuss different ways to construct LCU formulas for the Trotter remainder  $V_K(x)$  or  $V_K^{(p)}(x)$  based on the Taylor-series expansion. By increasing the Trotter order  $K$  or introducing the expansion-order-pairing, we can suppress the 1-norm  $\mu$  of the formula from  $e^{\lambda x}$  to higher order  $e^{c(\lambda x)^{K+1}}$  or even  $e^{c(\lambda x)^{2K+2}}$  with some constant  $c$ . We notice that, the 1-norm  $\lambda$  always comes with the segment evolution time  $x$ . Fundamentally, this is because we always consider the Taylor-series expansion for different exponential terms in  $V_K(s)$  *separately*. For example, for the first-order Trotter remainder  $V_1(x) = U(x)S_1(x)^\dagger$  in Eq. (E18), we expand  $U(x)$  and each component in  $S_1(x)^\dagger = \prod_{l=L}^1 e^{ixH_l}$  separately and get

$$\begin{aligned}
 V_1(x) &= U(x)S_1(x)^\dagger \\
 &= \sum_{r; \vec{r}} \frac{(-ixH)^r}{r!} \prod_{l=L}^1 \frac{(ixH_l)^{r_l}}{r_l!} \\
 &= \sum_{s=0}^{\infty} F_{1,s}(x).
 \end{aligned} \tag{G1}$$

From Eq. (E22) we know that, the 1-norm of the  $s$ -order term  $F_{1,s}(x)$  is  $\eta_s = \frac{(2\lambda x)^s}{s!}$  which is a function of  $\lambda x$ . As a result, the 1-norm of  $\|V_1(x)\|$  based on this “product Taylor-series expansion” is always a function of  $\lambda x$ .

If we carefully check the expansion terms in  $V_1(x)$ , we can find many redundancies in the expansion. We now take the 2nd-order expansion term  $F_{1,2}(x)$  as an example. In Eq. (F17), we expand it as

$$F_{1,2}(x) = \sum_{\substack{r; \vec{r} \\ r + \sum \vec{r} = 2}} \frac{(-ixH)^r}{r!} \prod_{l=L}^1 \frac{(ixH_l)^{r_l}}{r_l!}. \tag{G2}$$

In Sec. F 2 we have shown that  $F_{1,2}(x)$  is anti-Hermitian based on the exponential form of  $V_1(x)$ . As a result, all the Hermitian expansion terms in Eq. (G2) will cancel out.

In this section, we are going to simplify the 2nd-order term  $F_{1,2}(x)$  as follows,

$$\begin{aligned}
 F_{1,2}(x) &= (ix)^2 \left( \sum_{l=1}^L \frac{H_l^2}{2!} + \sum_{l, l': l > l'} H_l H_{l'} \right) + (-ixH) \sum_{l=1}^L (ixH_l) + \frac{(-ixH)^2}{2!} \\
 &= \frac{x^2}{2} \sum_{l, l': l > l'} [H_{l'}, H_l],
 \end{aligned} \tag{G3}$$

which is a commutator form with  $L(L-1)$  commutators. In the second line, we expand the summation based on the value of  $r = 0, 1$ , and 2. Note that, the commutators of Hermitian operators are always anti-Hermitian. This

implies that the nested-commutator expansion of  $F_{1,2}(x)$  in Eq. (G3) is compact enough since there is no Hermitian expansion terms in it.

For a common physical Hamiltonian with locality constraints, we can take advantage of the commutator-form expression like Eq. (G3). For example, for an  $n$ -qubit lattice Hamiltonian with the form,

$$H = \sum_{j=0}^{n-1} H_{j,j+1}, \quad (\text{G4})$$

where the summand  $H_{j,j+1}$  acts on the  $j$ th and  $(j+1)$ th vertices. We can split the Hamiltonian to two components  $H = A + B$ , where

$$A := \sum_{j:\text{even}} H_{j,j+1}, \quad B := \sum_{j:\text{odd}} H_{j,j+1}, \quad (\text{G5})$$

so that the summands  $H_{j,j+1}$  commute with each other in each component. We denote the norm of each Hamiltonian summand as

$$\Lambda = \max_j \|H_{j,j+1}\|, \quad \Lambda_1 = \max_j \|H_{j,j+1}\|_1. \quad (\text{G6})$$

Now, suppose we estimate the 1-norm of  $F_{1,2}(x)$  of the lattice Hamiltonian based on Eq. (G3), we can see that there are only  $n$  non-zero terms: for any given Hamiltonian component  $H_{j,j+1}$ , only  $H_{j-i,j}$  and  $H_{j+1,j+2}$  do not commute with it. Then, the norm of  $F_{1,2}(x)$  is bounded by

$$\|F_{1,2}(x)\|_1 \leq n\Lambda_1 \frac{x^2}{2} = \mathcal{O}(nx^2). \quad (\text{G7})$$

Comparing with the original bound in Eq. (E22),  $\|F_{1,2}(x)\|_1 \leq \eta_2 = \mathcal{O}((\lambda x)^2) = \mathcal{O}(n^2 x^2)$ , we separate the system-size-related factor  $n$  with the time  $x$ .

In this section, we are going to formalize this idea: we express the expansion-order  $F_{K,s}$  of the  $K$ th-order Trotter remainder based on the nested commutators. This will help us to improve the system-size dependence in the gate-complexity analysis. Furthermore, since the leading-order terms  $F_{K,s}$  ( $s = K+1, K+2, \dots, 2K+1$ ) can all be expressed by the summation of nested commutators, they are all anti-Hermitian. Thanks to this property, we can also introduce the expansion-order pairing idea introduced in Sec. F to further suppress the 1-norm from  $\mathcal{O}(x^{K+1})$  to  $\mathcal{O}(x^{2K+2})$ .

In Sec. G1, we first sketch the procedure to derive the nested-commutator form LCU formula. In Sec. G2 and G3, we take the lattice Hamiltonians with nearest-neighbour interactions as examples and consider the 1st- and  $2k$ th-order Trotter-LCU formula, respectively. Afterwards, we generalized the results to a generic Hamiltonian in Sec. G4.

### 1. Derivation of the nested-commutator compensation formula

Our aim is to expand the LCU formula for the  $K$ th-order Trotter remainder  $V_K(x) := U(x)S_K(x)^\dagger$  ( $K = 1$  or  $2k$ ,  $k \in \mathbb{N}_+$ ) in the following form,

$$V_K(x) = I + \sum_{s=K+1}^{2K+1} F_{K,s}^{(nc)}(x) + F_{K,res}^{(nc)}(x), \quad (\text{G8})$$

where the leading-order terms  $F_{K,s}^{(nc)}(x)$  are written as a summation of nested commutators. To this end, we are going to apply the following lemma for the operator-valued differential equation.

**Lemma 3** (Variation-of-parameters lemma (Lemma A.1 in [14], see Theorem 4.9 in [37])). *Let  $H(x)$ ,  $R(x)$  be continuous operator-valued functions defined for  $x \in \mathbb{R}$ . Then, the first-order differential equation*

$$\frac{d}{dx}W(x) = H(x)W(x) + R(x), \quad W(0) \text{ known}, \quad (\text{G9})$$

has a unique solution given by the variation-of-parameters formula

$$W(x) = \mathcal{T} \exp\left(\int_0^x d\tau H(\tau)\right) W(0) + \int_0^x d\tau_1 \mathcal{T} \exp\left(\int_{\tau_1}^x d\tau_2 H(\tau_2)\right) R(\tau_1). \quad (\text{G10})$$

If we set  $W(x)$  to be the real-time evolution  $U(x) = e^{-iHx}$ , we can find that  $H(x) = -iH$  and  $R(x) = 0$ . Therefore,  $R(x)$  reflects the derivation of  $W(x)$  from the exponential function.

We are going to apply Lemma 3 for the conjugated Trotter formula  $S_K(x)^\dagger$ . That is, we set  $W(x) := S_K(x)^\dagger$ ,  $H(x) = iH$ . The deviation of  $S_K(x)^\dagger$  from  $U(x)^\dagger = e^{ixH}$  is characterized by the following function,

$$R_K(x) = \frac{d}{dx} S_K(x)^\dagger - iH S_K(x)^\dagger. \quad (\text{G11})$$

Applying Lemma 3, we will have

$$S_K(x)^\dagger = e^{ixH} + \int_0^x d\tau e^{i(x-\tau)H} R_K(\tau). \quad (\text{G12})$$

The Trotter remainder  $V_K(x)$  can then be expressed as

$$\begin{aligned} V_K(x) &= U(x)S_K(x)^\dagger = I + \int_0^x d\tau e^{-i\tau H} R_K(\tau) \\ &= I + \int_0^x d\tau U(\tau)S_K(\tau)^\dagger S_K(\tau)R_K(\tau) \\ &= I + \int_0^x d\tau V_K(\tau)J_K(\tau), \end{aligned} \quad (\text{G13})$$

where

$$J_K(x) := S_K(x)R_K(x). \quad (\text{G14})$$

Eq. (G13) provides a recurrence formula to solve the expansion terms in  $V_K(x)$ . To be more explicit, if we expand  $V_K(x)$  and  $J_K(x)$  based on the operator-valued Taylor-series,

$$\begin{aligned} V_K(x) &= \sum_{s=0}^{\infty} G_s \frac{x^s}{s!}, \\ J_K(x) &= \sum_{s=0}^{\infty} C_s \frac{x^s}{s!}, \end{aligned} \quad (\text{G15})$$

where  $G_s$  and  $C_s$  denotes the respective  $s$ -order term, then we have

$$\begin{aligned} G_{s+1} &= \frac{(s+1)!}{x^{s+1}} \int_0^x d\tau \sum_{m=0}^s G_m C_{s-m} \frac{\tau^s}{m!(s-m)!} \\ &= \sum_{m=0}^s \binom{s}{m} G_m C_{s-m} \end{aligned} \quad (\text{G16})$$

since Eq. (G13) holds for all  $x \in \mathbb{R}$ . This is a recurrence formula which can be used to solve all the expansion terms  $G_s$  of the remainder  $V_K(x)$  from the expansion terms  $C_r$  of  $J_K(x)$ .

To solve the explicit form of  $G_s$ , we need to study the form of expansion terms  $\{C_r\}_{r=0}^{s-1}$  for the function  $J_K(x)$ . We will use the following lemma.

**Lemma 4** (Lemma 1 in [13]). *Let  $F(x)$  be an operator-valued function that is infinitely differentiable. Let  $K \geq 1$  be a nonnegative integer. The following two conditions are equivalent.*

1. *Asymptotic scaling:*  $F(x) = \mathcal{O}(x^{K+1})$ .
2. *Derivative condition:*  $F(0) = F'(0) = \dots = F^{(K)}(0) = 0$ .

Based on Lemma 4, we have the following proposition.

**Proposition 9** (Order condition). *For the  $K$ th-order Trotter formula  $S_K(x)$  of a Hamiltonian  $H = \sum_l H_l$ , the multiplicative remainder  $V_K(x)$  and derivative remainder  $J_K(x)$  in Eq. (G8), Eq. (G11) and Eq. (G14), respectively. Then, the following statements are equivalent.*

1.  $S_K(x) = U(x) + \mathcal{O}(x^{K+1})$ .
2.  $(S_K(0))^{(j)} = (-iH)^j$ , for  $0 \leq j \leq K$ .
3.  $J_K(x) = \mathcal{O}(x^K)$ .
4.  $(J_K(0))^{(j)} = 0$ , for  $0 \leq j \leq K - 1$ .
5.  $V_K(x) = I + \mathcal{O}(x^{K+1})$ .
6.  $V_K(0) = I$  and  $(V_K(0))^{(j)} = 0$ , for  $1 \leq j \leq K$ .

*Proof.* First, we note that 1  $\Leftrightarrow$  2, 3  $\Leftrightarrow$  4, and 5  $\Leftrightarrow$  6 by applying Lemma 4 and setting  $F(x)$  to be  $S_K(x) - U(x)$ ,  $J_K(x)$ , and  $V_K(x) - I$ , respectively. So we only need to prove 2  $\Leftrightarrow$  4 and 2  $\Leftrightarrow$  6.

We first prove 2  $\Leftrightarrow$  4. From 2 we also have  $(S_K(x)^\dagger)^{(j)} = (iH)^j$  for  $0 \leq j \leq K$ . Based on Eq. (G11) and Eq. (G14), the derivatives of  $R_K(x)$  and  $J_K(x)$  are

$$\begin{aligned} (R_K(x))^{(j)} &= (S_K(x)^\dagger)^{(j+1)} - iH(S_K(x)^\dagger)^{(j)}, \\ (J_K(x))^{(j)} &= \sum_{l=0}^j \binom{j}{l} (S_K(x))^{(l)} (R_K(x))^{(j-l)}. \end{aligned} \quad (\text{G17})$$

Based on 2 we have  $(R_K(0))^{(j)} = 0$  for  $0 \leq j \leq K - 1$ . Hence  $(J_K(0))^{(j)} = 0$  for  $0 \leq j \leq K - 1$ .

For the reverse direction, we notice that  $R_K(x) = J_K(x)S_K(x)^\dagger$ . This implies

$$(R_K(x))^{(j)} = \sum_{l=0}^j \binom{j}{l} (J_K(x))^{(l)} (S_K(x)^\dagger)^{(j-l)}. \quad (\text{G18})$$

If we have  $(J_K(0))^{(j)} = 0$  for  $0 \leq j \leq K - 1$ , then  $(R_K(0))^{(j)} = 0$  for  $0 \leq j \leq K - 1$ . Then, from Eq. (G17) we have  $(S_K(x)^\dagger)^{(j)} = (iH)^j$  for  $0 \leq j \leq K$ , which is equivalent to 2.

Now, we prove 2  $\Leftrightarrow$  6. Based on Eq. (G8) we have

$$(V_K(x))^{(j)} = \sum_{l=0}^j \binom{j}{l} (U(x))^{(l)} (S_K(x)^\dagger)^{(j-l)}. \quad (\text{G19})$$

From 2 we have

$$(V_K(0))^{(j)} = \sum_{l=0}^j \binom{j}{l} (-iH)^l (iH)^{j-l} = 0, \quad (\text{G20})$$

for  $1 < j < K$ . The reverse direction can be proven similarly based on the derivative of the formula  $S_K(x) = V_K(x)^\dagger U(x)$ .  $\square$

From Proposition 9, we have the following order condition for the  $K$ th-order Trotter formula and remainders,

$$\begin{aligned} S_K(x) &= U(x) + \mathcal{O}(x^{K+1}), \\ J_K(x) &= \mathcal{O}(x^K), \\ V_K(x) &= I + \mathcal{O}(x^{K+1}). \end{aligned} \quad (\text{G21})$$

Compare the recurrence formula in Eq. (G13) and the order condition in Eq. (G21), we will obtain the following relationship for the Taylor-series expansion terms  $G_s$  and  $C_s$  for  $V_K(x)$  and  $J_K(x)$ , respectively,

$$\begin{aligned} G_s &= 0, \quad s = 1, 2, \dots, K, \\ C_s &= 0, \quad s = 0, 1, \dots, K - 1, \\ G_s &= C_{s-1}, \quad s = K + 1, K + 2, \dots, 2K + 1. \end{aligned} \quad (\text{G22})$$

Based on Eq. (G22), we are going to expand  $J_K(x)$  based on the operator-valued Taylor-series expansion with integral remainders,

$$J_K(x) = J_{K,L}(x) + J_{K,res,2K}(x) = \sum_{s=K}^{2K} C_s \frac{x^s}{s!} + J_{K,res,2K}(x), \quad (\text{G23})$$

where

$$\begin{aligned} C_s &= J_K^{(s)}(0), \quad s = K, K+1, \dots, 2K \\ J_{K,res,s}(x) &= \int_0^x d\tau \frac{(x-\tau)^s}{s!} J_K^{(s+1)}(\tau). \end{aligned} \quad (\text{G24})$$

$J_{K,L}(x) := \sum_{s=K}^{2K} C_s \frac{x^s}{s!}$  denotes the leading-order terms in  $J_K(x)$ . Then, from Eq. (G13) and Eq. (G22), the  $K$ th-order Trotter remainder can be expressed as

$$\begin{aligned} V_K(x) &= I + M_K(x) = I + \sum_{s=K+1}^{2K+1} F_{K,s}^{(nc)}(x) + F_{K,res}^{(nc)}(x), \\ F_{K,s}^{(nc)}(x) &= C_{s-1} \frac{x^s}{s!}, \quad s = K+1, K+2, \dots, 2K+1, \\ F_{K,res}^{(nc)}(x) &= \int_0^x d\tau (M_K(\tau) J_{K,L}(\tau) + V_K(\tau) J_{K,res,2K}(\tau)). \end{aligned} \quad (\text{G25})$$

Here,  $M_K(x) := V_K(x) - I$ .

From Eq. (G25) we can see that, the leading-order expansion terms  $F_{K,s}^{(nc)}(x)$  of  $V_K(x)$  with  $s = K+1, K+2, \dots, 2K+1$  owns a simple expression related to  $C_{s-1} := J_K^{(s-1)}(0)$ . Later we will show that,  $C_s$  can be simply written as a summation of nested commutators with the form,

$$\text{ad}_{H_{l_j}}^{m_j} \dots \text{ad}_{H_{l_2}}^{m_2} \text{ad}_{H_{l_1}}^{m_1} H_l, \quad (\text{G26})$$

where  $\sum_j m_j = s$ ,  $H_l, H_{l_1}, \dots, H_{l_j}$  are different summands in  $H$ . Furthermore, we will show that  $\{C_s\}$  are all anti-Hermitian. As a result, we can adopt the leading-order pairing method introduced in Sec. F. Since  $\{C_s\}$  are anti-Hermitian, we can expand them by the Pauli operators as follows,

$$C_s = i \|C_s\|_1 \sum_{\gamma} \text{Pr}(\gamma|s) P^{(nc)}(s, \gamma), \quad (\text{G27})$$

where  $\{P^{(nc)}(s, \gamma)\}$  are Hermitian Pauli operators with coefficients 1 or  $-1$ .  $\|C_s\|_1$  denotes the 1-norm of this expansion. The leading-order expansion term  $F_{K,s}^{(nc)}(x)$  can then be expressed as

$$\begin{aligned} F_{K,s}^{(nc)}(x) &= i \|C_{s-1}\|_1 \frac{x^s}{s!} \sum_{\gamma} \text{Pr}(\gamma|s-1) P^{(nc)}(s-1, \gamma) \\ &=: \eta_s^{(nc)} V_{K,s}^{(nc)}. \end{aligned} \quad (\text{G28})$$

Here,  $\eta_s^{(nc)} := \|C_{s-1}\|_1 \frac{x^s}{s!}$  is the 1-norm of the LCU formula of  $F_{K,s}^{(nc)}(x)$  in Eq. (G28).  $V_{K,s}^{(nc)}$  is the normalized LCU formula.

The residue term  $F_{K,res}^{(nc)}$  in Eq. (G25), however, is complicated and hard to be expressed simply using nested commutators. Due to the hardness to compensate  $F_{K,res}^{(nc)}$ , we will compensate the leading-order terms only in practice. The truncated Trotter remainder can be written as

$$\begin{aligned} \tilde{V}_K^{(nc)}(x) &= I + \sum_{s=K+1}^{2K+1} F_{K,s}^{(nc)}(x) \\ &= I + i \sum_{s=K}^{2K} \eta_s^{(nc)} V_{K,s}^{(nc)} \\ &= \sum_{s=K}^{2K} \frac{\eta_s^{(nc)}}{\eta_{\Sigma}^{(nc)}} \left( I + \eta_{\Sigma}^{(nc)} V_{K,s}^{(nc)} \right) \\ &= \sqrt{1 + (\eta_{\Sigma}^{(nc)})^2} \sum_{s=K}^{2K} \frac{\eta_s^{(nc)}}{\eta_{\Sigma}^{(nc)}} R_{K,s}^{(nc)}(\eta_{\Sigma}). \end{aligned} \quad (\text{G29})$$

Here,  $\eta_\Sigma^{(nc)} := \sum_{s=K+1}^{2K+1} \|C_{s-1}\|_1 \frac{x^s}{s!}$ . In the fourth line, we apply the following pairing procedure based on the Euler's formula, similar to Eq. (F28),

$$\begin{aligned}
I + \eta_\Sigma^{(nc)} V_{K,s}^{(nc)} &= I + i\eta_\Sigma^{(nc)} \sum_{\gamma} \Pr(\gamma|s-1) P^{(nc)}(s-1, \gamma) \\
&= \sum_{\gamma} \Pr(\gamma|s-1) (I + i\eta_\Sigma^{(nc)} P^{(nc)}(s-1, \gamma)) \\
&= \sqrt{1 + (\eta_\Sigma^{(nc)})^2} \sum_{\gamma} \Pr(\gamma|s-1) \exp\left(i\theta(\eta_\Sigma^{(nc)}) P^{(nc)}(s-1, \gamma)\right) \\
&=: \sqrt{1 + (\eta_\Sigma^{(nc)})^2} R_{2,s}^{(nc)}(\eta_\Sigma^{(nc)}), \quad s = K+1, K+2, \dots, 2K+1.
\end{aligned} \tag{G30}$$

Recall that  $\theta(x) := \tan^{-1}(x)$ .

$\tilde{V}_K^{(nc)}(x)$  in Eq. (G29) is the final LCU formula for the nested-commutator compensation of  $V_K(x)$ . In what follows, we solve the 1-norm  $\mu_K^{(nc)}(x)$  and distance  $\varepsilon_K^{(nc)}(x)$  of this LCU formula,

$$\begin{aligned}
\mu_K^{(nc)}(x) &:= \sqrt{1 + (\eta_\Sigma^{(nc)})^2}, \\
\varepsilon_K^{(nc)}(x) &:= \|\tilde{V}_K^{(nc)}(x) - V_K(x)\| = \|F_{K,res}^{(nc)}(x)\|.
\end{aligned} \tag{G31}$$

We have the following proposition to estimate  $\mu_K^{(nc)}(x)$  and  $\varepsilon_K^{(nc)}(x)$ .

**Proposition 10** (Bound the 1-norm and error of nested-commutator expansion formula).  $\tilde{V}_K^{(nc)}(x)$  in Eq. (G29) is a  $(\mu_K^{(nc)}(x), \varepsilon_K^{(nc)}(x))$  formula of the  $K$ th-order Trotter remainder  $V_K(x)$  with

$$\begin{aligned}
\mu_K^{(nc)}(x) &= \sqrt{1 + (\eta_\Sigma^{(nc)})^2} = \sqrt{1 + \left(\sum_{s=K}^{2K} \|C_s\|_1 \frac{x^{s+1}}{(s+1)!}\right)^2} \\
\varepsilon_K^{(nc)}(x) &\leq \int_0^x d\tau (\|M_K(\tau)\| \|J_{K,L}(\tau)\| + \|J_{K,res,2K}(\tau)\|),
\end{aligned} \tag{G32}$$

where

$$\begin{aligned}
\|J_{K,L}(\tau)\| &\leq \sum_{s=K}^{2K} \|C_s\| \frac{x^{s+1}}{(s+1)!}, \\
\|J_{K,res,2K}(\tau)\| &\leq \int_0^x d\tau \frac{(x-\tau)^s}{s!} \|J_K^{(s+1)}(\tau)\|, \\
\|M_K(\tau)\| &\leq \int_0^\tau d\tau_1 \int_0^{\tau_1} d\tau_2 \frac{(\tau_1 - \tau_2)^{(K-1)}}{(K-1)!} \|J_K^{(K)}(\tau_2)\|.
\end{aligned} \tag{G33}$$

*Proof.* The value of  $\mu_K^{(nc)}(x)$  is derived based on Eq. (G28) and Eq. (G29).

To calculate  $\varepsilon_K^{(nc)}(x)$ , we will use the following bound,

$$\begin{aligned}
\varepsilon_K^{(nc)}(x) &= \|F_{K,res}^{(nc)}(x)\| \leq \int_0^x d\tau (\|M_K(\tau)\| \|J_{K,L}(\tau)\| + \|V_K(\tau)\| \|J_{K,res,2K}(\tau)\|) \\
&= \int_0^x d\tau (\|M_K(\tau)\| \|J_{K,L}(\tau)\| + \|J_{K,res,2K}(\tau)\|).
\end{aligned} \tag{G34}$$

In the second line, we use the property that  $V_K(\tau)$  is a unitary. To bound  $\|J_{K,L}(\tau)\|$ , we have

$$\|J_{K,L}(\tau)\| \leq \sum_{s=K}^{2K} \|C_s\| \frac{x^{s+1}}{(s+1)!}. \tag{G35}$$

To bound  $J_{K,res,2K}(\tau)$  in Eq. (G34), from Eq. (G24) we have

$$\|J_{K,res,2K}(\tau)\| \leq \int_0^x d\tau \frac{(x-\tau)^s}{s!} \|J_K^{(s+1)}(\tau)\|. \tag{G36}$$

Finally, to bound  $\|M_K(\tau)\|$  in Eq. (G34), we have

$$\begin{aligned}
\|M_K(\tau)\| &= \left\| \int_0^\tau d\tau_1 V_K(\tau_1) J_K(\tau_1) \right\| \\
&\leq \int_0^\tau d\tau_1 \|J_K(\tau_1)\| \\
&= \int_0^\tau d\tau_1 \|J_{K,res,K-1}(\tau_1)\| \\
&\leq \int_0^\tau d\tau_1 \int_0^{\tau_1} d\tau_2 \frac{(\tau_1 - \tau_2)^{(K-1)}}{(K-1)!} \|J_K^{(K)}(\tau_2)\|.
\end{aligned} \tag{G37}$$

In the first line, we use the definition of  $M_K(\tau) = V_K(\tau) - I$  and the recurrence formula in Eq. (G13). In the second line, we use the property that  $V_K(\tau)$  is a unitary. In the third line, we use the order condition in Proposition 9. In the final line, we apply the operator-valued Taylor-series expansion on  $J_K(\tau)$  and set the truncation order  $s_c = K - 1$ .  $\square$

From Proposition 10 we can see that, to study the performance of the truncated LCU formula  $\tilde{V}_K^{(nc)}(x)$  in Eq. (G29), we only need to study the property of the function  $J_K(x)$  and its derivatives.

In the following section, we are going to derive the explicit formula of  $\tilde{V}_K^{(nc)}(x)$ . As a simple and useful example, we will first consider the lattice Hamiltonian with 1st- and 2kth-order Trotter formulas in Sec. G2 and Sec. G3, respectively. Then, we study the generic Hamiltonian in Sec. G4.

## 2. First-order case (lattice Hamiltonians)

Now, we focus on the lattice Hamiltonians with the form  $H = A + B$  in Eq. (G4). We start from the 1st-order case. For the lattice Hamiltonian, the 1st-order Trotter formula is

$$S_1(x) = e^{-ixB} e^{-ixA}. \tag{G38}$$

Here, we assume that the time-evolution of each two-qubit component  $e^{-ixH_{j,j+1}}$  is easy to be implement on the quantum computer.

To derive the explicit form of the LCU formula  $\tilde{V}_1^{(nc)}(x)$  in Eq. (G29), we first derive  $J_1(x)$  defined in Eq. (G14) and its derivatives  $C_s := J_1^{(s)}(x)$ . From Eq. (G11) and Eq. (G14) we have

$$\begin{aligned}
R_1(x) &= \frac{d}{dx} S_1(x)^\dagger - iH S_1(x)^\dagger = i[e^{ixA}, B] e^{ixB}, \\
J_1(x) &= S_1(x) R_1(x) = i e^{-ixB} e^{-ixA} [e^{ixA}, B] e^{ixB} \\
&= i (B - e^{-ixad_B} e^{-ixad_A} B).
\end{aligned} \tag{G39}$$

We are going to apply the following operator Taylor-series expansion formula with integral form of the remainder: for an operator-valued function  $Q(x)$ , we have

$$Q(x) = \sum_{s=0}^{s_c} \frac{x^s}{s!} Q^{(s)}(0) + \int_0^x d\tau \frac{(x-\tau)^{s_c}}{s_c!} Q^{(s_c+1)}(\tau). \tag{G40}$$

Applying the general Libniz formula, we obtain the derivatives of  $J_1(x)$  as follows,

$$J_1^{(s)}(x) = (-i)^{s+1} \sum_{\substack{m_1, n_1; \\ m_1 + n_1 = s}} \binom{s}{m_1} e^{-ixad_B} \text{ad}_B^{m_1} e^{-ixad_A} \text{ad}_A^{n_1} B. \tag{G41}$$

Then, if we set the truncation of  $J_1^{(s)}(x)$  to be  $s_c$ , it can be expanded as

$$J_1^{(s)}(x) = \sum_{s=0}^{s_c} C_s \frac{x^s}{s!} + J_{1,res}(x), \tag{G42}$$



where

$$C_s = J_1^{(s)}(0) = (-i)^{s+1} \sum_{\substack{m_1, n_1; \\ m_1 + n_1 = s}} \binom{s}{m_1} \text{ad}_B^{m_1} \text{ad}_A^{n_1} B, \quad (\text{G43})$$

$$J_{1, res, s_c}(x) = \int_0^x d\tau \frac{(x - \tau)^{s_c}}{s_c!} J_1^{(s_c+1)}(\tau).$$

We can see that,  $C_s$  can be written as the summation of nested commutators with concise form  $\text{ad}_B^{m_1} \text{ad}_A^{n_1} B$ . Note that,  $(-i)^{s+1} \text{ad}_B^{m_1} \text{ad}_A^{n_1} B$  with  $m_1 + n_1 = s$  is always anti-Hermitian when  $A$  and  $B$  are Hermitian. On the other hand, these nested commutators are all with the nice property that their spectral norm and 1-norm is linear to the system size  $n$ . To be more specific, we have the following norm bound.

**Proposition 11** (Upper bound of the norm of 1st-order nested commutators). *Consider a lattice Hamiltonian  $H = A + B$  with the form in Eq. (G4). Suppose the spectral norm and 1-norm of its components  $H_{j,j+1}$  are upper bounded by  $\Lambda$  and  $\Lambda_1$ . Then for the nested commutators appearing in Eq. (G43), we have the following bound*

$$\|e^{-i\tau \text{ad}_B} \text{ad}_B^{m_1} e^{-i\tau \text{ad}_A} \text{ad}_A^{n_1} B\| \leq \frac{n}{2} 3^{m_1} 2^{n_1} 2^s \Lambda^{s+1}, \quad (\text{G44})$$

where  $m_1, n_1$  are nonnegative integers satisfying  $m_1 + n_1 = s$ . As a result, we can bound the spectral norm of  $J_1^{(s)}$  as,

$$\|J_1^{(s)}(x)\| \leq \frac{n}{2} 10^s \Lambda^{s+1}. \quad (\text{G45})$$

The 1-norm upper bound is to simply replace  $\Lambda$  by  $\Lambda_1$ .

*Proof.* We first focus on one Hamiltonian term  $H_{j,j+1}$  contained in  $B$  and bound the norm,

$$\|e^{-i\tau \text{ad}_B} \text{ad}_B^{m_1} e^{-i\tau \text{ad}_A} \text{ad}_A^{n_1} (H_{j,j+1})\| \leq 3^{m_1} 2^{n_1} 2^s \Lambda^{s+1}. \quad (\text{G46})$$

To do this, we are going to decompose commutator to the elementary nested commutators in the following form,

$$e^{-i\tau \text{ad}_B} \text{ad}_{H_{j_s, j_{s+1}}} \dots \text{ad}_{H_{j_{n_1+1}, j_{n_1+1+1}}} \cdot \\ e^{-i\tau \text{ad}_A} \text{ad}_{H_{j_{n_1}, j_{n_1+1}}} \dots \text{ad}_{H_{j_1, j_1+1}} H_{j, j+1}, \quad (\text{G47})$$

where  $j_1, j_2, \dots, j_s$  are the possible vertice indices. For each elementary nested commutator, the spectral norm can be easily bounded by

$$(2\Lambda)^s \Lambda, \quad (\text{G48})$$

by simply expand all the commutators and applying triangle inequality. Here, we use the property that the spectral norm of all the exponential operator with anti-Hermitian exponent is 1.

Now, we count the number of the possible elementary commutators with the form in Eq. (G47). We will check the action of each adjoint operator  $\text{ad}_A$  or  $\text{ad}_B$  from the right to the left. For the first location, if we expand  $\text{ad}_A$ , there will be only two possible elementary nonzero components,  $\text{ad}_{H_{j-1, j}}$  and  $\text{ad}_{H_{j+1, j+2}}$ . If the next  $\text{ad}$  is still  $\text{ad}_A$ , the support will still be on the 4 qubits:  $j-1, j, j+1$ , and  $j+2$ . As a result, there will still be only two possible components,  $\text{ad}_{H_{j-1, j}}$  and  $\text{ad}_{H_{j+1, j+2}}$ . Similarly, the exponential operator  $e^{-i\tau \text{ad}_A}$  will not enlarge the support since one can expand it to the power of  $\text{ad}_A$ . The support will be enlarged when  $\text{ad}_B$  comes. In this layer, the support of the operator will be expanded to 6 qubits, and there will be 3 elementary components. The number of possible elementary commutators is then

$$3^{m_1} 2^{n_1}. \quad (\text{G49})$$

Combining the number of elementary nested commutators and the norm bound for each commutator and applying triangle inequality, we will obtain Eq. (G46). Finally, in the operator  $B$ , there are  $\frac{n}{2}$  possible summands. This finishes the proof of Eq. (G44).

Now, we apply Eq. (G44) to bound the norm of  $J_1^{(s)}(x)$ . From Eq. (G41) we have

$$\|J_1^{(s)}(x)\| \leq \sum_{\substack{m_1, n_1; \\ m_1 + n_1 = s}} \binom{s}{m_1} \|e^{-ix \text{ad}_B} \text{ad}_B^{m_1} e^{-ix \text{ad}_A} \text{ad}_A^{n_1} B\| \\ \leq \frac{n}{2} 2^s \Lambda^{s+1} \sum_{\substack{m_1, n_1; \\ m_1 + n_1 = s}} \binom{s}{m_1} 3^{m_1} 2^{n_1} \\ = \frac{n}{2} 10^s \Lambda^{s+1}. \quad (\text{G50})$$

In the third line, we apply the binomial theorem.

Since 1-norm can be estimated based on the same logic by counting the number of elementary nested commutators and the 1-norm of each nest commutator, the derivation for the 1-norm is similar by replacing  $\Lambda$  to  $\Lambda_1$ .  $\square$

As is introduced in Sec. G1, we set  $F_{1,s}^{(nc)}(x)$  with  $s = 2, 3$  to be the leading-order terms and set the truncation order  $s_c = 3$ . That is, we only compensate the 2nd- and 3rd-order error using LCU methods. In this way, we are not able to achieve the logarithmic accuracy anymore. Instead, we can achieve a higher accuracy of  $\mathcal{O}(\varepsilon^{-1/3})$ , which is cubically improved comparing to the bare 1st-order Trotter result  $\mathcal{O}(\varepsilon^{-1})$ .

Based on Eq. (G29), the truncated nested-commutator LCU formula for  $V_1(x)$  can be written as

$$\begin{aligned}\tilde{V}_1(x) &= I + \sum_{s=2}^3 F_{1,s}^{(nc)}(x), \\ &= \sqrt{1 + (\eta_\Sigma^{(nc)})^2} \sum_{s=2}^3 \frac{\eta_s^{(nc)}}{\eta_\Sigma^{(nc)}} R_{1,s}^{(nc)}(\eta_\Sigma).\end{aligned}\tag{G51}$$

Here,  $\eta_\Sigma^{(nc)} := \sum_{s=2}^3 \|C_{s-1}\|_1 \frac{x^s}{s!}$ . The explicit form of  $R_{1,s}^{(nc)}(\eta_\Sigma)$  can be obtained by the definitions in Eq. (G28), Eq. (G30) and the Pauli operator decomposition based on the nested-commutator form in Eq. (G43).

Combined with the deterministic first-order Trotter formula, the overall LCU formula for  $U(x)$  is

$$\tilde{U}_1^{(nc)}(x) = \tilde{V}_1^{(nc)}(x) S_1(x).\tag{G52}$$

Following Proposition 10 and Proposition 11, we can bound the 1-norm and error of the LCU formula in Eq. (G51) and Eq. (G52) as follows.

**Proposition 12** (1st-order Trotter-LCU formula by nested-commutator compensation for lattice Hamiltonians). *Consider a Lattice Hamiltonian with the form in Eq. (G4). For  $\min\{\frac{1}{4\Lambda}, \frac{3}{20\Lambda_1}\} > x > 0$  in Eq. (G51) is a  $(\mu_1^{(nc)}(x), \varepsilon_1^{(nc)}(x))$ -LCU formula of  $V_1(x)$  with*

$$\begin{aligned}\mu_1^{(nc)}(x) &\leq \exp(10n^2(\Lambda_1 x)^4), \\ \varepsilon_1^{(nc)}(x) &\leq 15n^2(\Lambda x)^4.\end{aligned}\tag{G53}$$

As a result,  $\tilde{U}_1^{(nc)}(x)$  in Eq. (G52) is a  $(\mu_1^{(nc)}(x), \varepsilon_1^{(nc)}(x))$ -LCU formula of  $U(x)$ . Here,  $\Lambda_1$  and  $\Lambda$  are defined in Eq. (G6).

*Proof.* We start from bounding the 1-norm  $\mu_1^{(nc)}(x)$ . From Proposition 10 we have

$$\begin{aligned}\mu_1^{(nc)}(x) &\leq \sqrt{1 + \left(\sum_{s=1}^2 \|C_s\|_1 \frac{x^{s+1}}{(s+1)!}\right)^2} \\ &\leq 1 + \frac{1}{2} \left(\sum_{s=1}^2 \|C_s\|_1 \frac{x^{s+1}}{(s+1)!}\right)^2 \\ &= 1 + n^2 \left(\frac{25}{8}(\Lambda_1 x)^4 + \frac{250}{12}(\Lambda_1 x)^5 + \frac{1250}{3!3!}(\Lambda_1 x)^6\right) \\ &\leq 1 + 3n^2 \frac{25}{8}(\Lambda_1 x)^4 \\ &\leq \exp(10n^2(\Lambda_1 x)^4).\end{aligned}\tag{G54}$$

In the third line, we use the fact that  $C_s = J_1^{(s)}(0)$  and Proposition 11. In the fourth line, we use the assumption that  $\Lambda_1 x \leq \frac{3}{20}$ .

Now, we bound the spectral norm distance  $\varepsilon_1^{(nc)}(x) = \|F_{1, res}^{(nc)}\|$ . From Proposition 10 we know that we only need to bound  $\|J_{1,L}(\tau)\|$ ,  $\|J_{1, res, 2}(\tau)\|$ , and  $M_1(\tau)$  based on Eq. (G33).

We start from  $\|J_{1,L}(\tau)\|$ . From Proposition 11 we have

$$\begin{aligned}\|J_{1,L}(\tau)\| &\leq \sum_{s=1}^2 \|C_s\| \frac{\tau^s}{s!} \\ &\leq \frac{n}{2} \sum_{s=1}^2 10^s \Lambda^{s+1} \frac{\tau^s}{s!}.\end{aligned}\tag{G55}$$

Then, we bound  $\|J_{1,res,2}(\tau)\|$  and  $\|M_1(\tau)\|$ . From Eq. (G33) and Proposition 11 we have

$$\begin{aligned}\|J_{1,res,2}(\tau)\| &\leq \int_0^\tau d\tau_1 \frac{(\tau - \tau_1)^2}{2!} \|J_1^{(3)}(\tau_1)\| \\ &\leq \frac{n}{2} 10^3 \Lambda^4 \frac{\tau^3}{3!}, \\ \|M_1(\tau)\| &\leq \int_0^\tau d\tau_1 \int_0^{\tau_1} d\tau_2 \|J_1^{(1)}(\tau_2)\| \\ &\leq \frac{n}{2} 10 \Lambda^2 \frac{\tau^2}{2!}.\end{aligned}\tag{G56}$$

Based on Eq. (G55), Eq. (G56) and Proposition 10 we have

$$\begin{aligned}\|F_{1,res}^{(nc)}\| &\leq \int_0^x d\tau (\|M_1(\tau)\| \|J_{1,L}(\tau)\| + \|J_{1,res,2}(\tau)\|) \\ &\leq \int_0^x d\tau \left( \frac{n^2}{4} \sum_{s=1}^2 10^{s+1} \Lambda^{s+3} \frac{\tau^{s+2}}{s!2!} + \frac{n}{2} 10^3 \Lambda^4 \frac{\tau^3}{3!} \right) \\ &= \frac{n^2}{4} \sum_{s=1}^2 10^{s+1} \frac{(\Lambda x)^{s+2}}{s!2!(s+3)} + \frac{n}{2} 10^3 \frac{(\Lambda x)^4}{4!} \\ &\leq 2 \cdot \frac{n^2}{4} 10^2 \frac{(\Lambda x)^4}{8} + \frac{n}{2} 10^3 \frac{(\Lambda x)^4}{4!} \\ &\leq 15n^2 (\Lambda x)^4.\end{aligned}\tag{G57}$$

In the fourth line, we use the assumption that  $x \leq \frac{1}{4\Lambda}$ . □

Now, we consider the Trotter-LCU formula  $\tilde{U}_1^{(nc)}(x)$  in Eq. (G52) for both random-sampling and coherent usages.

For the random-sampling implementation, the overall LCU formula for  $U(t)$  is to repeat the sampling of  $\tilde{U}_1^{(nc)}(x)$  for  $\nu$  times,  $\tilde{U}_{1,tot}^{(nc)}(t) = \tilde{U}_1^{(nc)}(x)^\nu$ . Using Proposition 2 and 12, when  $0 < x < \min\{\frac{1}{4\Lambda}, \frac{3}{20\Lambda_1}\}$ , we conclude that  $\tilde{U}_{1,tot}^{(nc)}(t)$  is a  $(\mu_{1,tot}^{(nc)}(t), \epsilon_{1,tot}^{(nc)}(t))$ -LCU formula of  $U(t)$  with

$$\begin{aligned}\mu_{1,tot}^{(nc)}(t) &= \mu_{2k}(x)^\nu \leq \exp\left(10n^2 \frac{(\Lambda_1 t)^4}{\nu^3}\right), \\ \epsilon_{1,tot}^{(nc)}(t) &\leq \nu \mu_{1,tot}^{(nc)}(t) \epsilon_1^{(nc)}(x) \leq \nu \exp\left(10n^2 \frac{(\Lambda_1 t)^4}{\nu^3}\right) \left(15n^2 \frac{(\Lambda t)^4}{\nu^4}\right).\end{aligned}\tag{G58}$$

To realize a  $(\mu, \epsilon)$ -LCU formula for  $U(t)$ , we need the segment number  $\nu$  satisfy all the requirements below,

$$\begin{aligned}\nu &\geq \max\left\{4\Lambda t, \frac{20}{3} \Lambda_1 t\right\}, \\ \nu &\geq \left(\frac{10}{\ln \mu}\right)^{\frac{1}{3}} n^{\frac{2}{3}} (\Lambda_1 t)^{\frac{4}{3}}, \\ \nu &\geq (15\mu)^{\frac{1}{3}} \epsilon^{-\frac{1}{3}} n^{\frac{2}{3}} (\Lambda t)^{\frac{4}{3}}.\end{aligned}\tag{G59}$$

Unlike the former Taylor-series-based algorithms, since we are not able to increase the truncation order  $s_c$  anymore, the accuracy requirement put another constraint on the segment number  $\nu$ . To fulfill all the requirements in Eq. (G59), it suffices to choice  $\nu = \mathcal{O}(n^{2/3} t^{4/3} \epsilon^{-1/3})$ .

Based on Eq. (D33), the gate complexity of the 1st-order Trotter-LCU algorithm is then

$$\mathcal{O}(\nu(L + s_c)) = \mathcal{O}\left(n^{\frac{5}{3}} t^{\frac{4}{3}} \varepsilon^{-\frac{1}{3}}\right). \quad (\text{G60})$$

For the coherent implementation, to apply Corollary 1, we need to set

$$\mu_1^{(nc)}(x) \leq 2 \Leftrightarrow x = \frac{1}{\Lambda_1} \left(\frac{\ln 2}{10}\right)^{\frac{1}{4}} n^{-\frac{1}{2}} \Leftrightarrow \nu = \left(\frac{10}{\ln 2}\right)^{\frac{1}{4}} n^{\frac{1}{2}} (\Lambda_1 t). \quad (\text{G61})$$

Similar to the random-sampling implementation, since we cannot increase the truncation order  $s_c$  to the value larger than 3, the accuracy requirement also put another constraint on the evolution time. Roughly speaking, we need

$$\nu \varepsilon_1^{(nc)}(x) \leq \varepsilon \Leftrightarrow \nu = (15)^{\frac{1}{3}} n^{\frac{2}{3}} (\Lambda t)^{\frac{4}{3}} \varepsilon^{-\frac{1}{3}}. \quad (\text{G62})$$

If we want to apply Corollary 1 accurately, we need to replace  $\varepsilon$  to  $\xi$  defined in Eq. (D44). When  $\varepsilon$  is much smaller than 1, we have  $\xi = 2\varepsilon$ .

Therefore, it suffice to choose  $\nu$  to be

$$\nu = \mathcal{O}(n^{\frac{2}{3}} t^{\frac{4}{3}} \varepsilon^{-\frac{1}{3}}). \quad (\text{G63})$$

In each segment, we need to implement 1st-order Trotter formula and the 2nd- and 3rd-order LCU formula. The number of elementary unitaries is  $\mathcal{O}(n)$ . Therefore, the overall gate complexity is

$$\mathcal{O}(n^{\frac{5}{3}} t^{\frac{4}{3}} \varepsilon^{-\frac{1}{3}}). \quad (\text{G64})$$

### 3. Second- and higher-order case (lattice Hamiltonians)

We can easily extend the methods for the 1st-order nested-commutation compensation to higher order case. In this section, we will take the 2nd-order case as an example and present the results for the general  $2k$ th-order ( $k \in \mathbb{N}_+$ ) Trotter-LCU cases.

For the lattice Hamiltonian, the 2nd-order Trotter formula is

$$S_2(x) = e^{-i\frac{x}{2}A} e^{-ixB} e^{-i\frac{x}{2}A}. \quad (\text{G65})$$

To derive the explicit LCU formula  $\tilde{V}_2^{(nc)}(x)$  in Eq. (G29), we first derive  $J_2(x)$  defined in Eq. (G14) and its derivatives  $C_s := J_2^{(s)}(x)$ . From Eq. (G11) and Eq. (G14) we have

$$\begin{aligned} S_2(x)^\dagger &= e^{ixH} + \int_0^x d\tau e^{i(x-\tau)H} R_2(\tau), \\ R_2(\tau) &= i[e^{i\frac{x}{2}A}, B]e^{ixB}e^{i\frac{x}{2}A} + \frac{i}{2}[e^{i\frac{x}{2}A}e^{ixB}, A]e^{i\frac{x}{2}A}, \\ J_2(x) &= S_2(x)R_2(x) = \frac{i}{2}(A - e^{-i\frac{x}{2}\text{ad}_A}e^{-ix\text{ad}_B}A) + i(e^{-i\frac{x}{2}\text{ad}_A}B - e^{-i\frac{x}{2}\text{ad}_A}e^{-ix\text{ad}_B}e^{-i\frac{x}{2}\text{ad}_A}B). \end{aligned} \quad (\text{G66})$$

If we expand  $V_2(x)$  and  $J_2(x)$  as follows,

$$\begin{aligned} V_2(x) &= \sum_{s=0}^{\infty} G_s \frac{x^s}{s!}, \\ J_2(x) &= \sum_{s=0}^{\infty} C_s \frac{x^s}{s!}, \end{aligned} \quad (\text{G67})$$

then based on the order condition in Proposition 9 and the recurrence formula Eq. (G13), we can prove that,

$$G_1 = G_2 = 0, \quad C_0 = C_1 = 0, \quad G_s = C_{s-1}, \quad s = 3, 4, 5. \quad (\text{G68})$$

Combining Eq. (G66) and Eq. (G68), we can show that

$$G_s = \mathcal{O}(n^{\lfloor \frac{s}{3} \rfloor}). \quad (\text{G69})$$

Therefore, the first three non-trivial terms  $G_3, G_4, G_5 = \mathcal{O}(n)$ . These terms will be set as the leading-order terms.

Based on Eq. (G68), we are going to expand  $J_K(x)$  based on the operator-valued Taylor-series expansion with integral remainders,

$$J_2(x) = J_{2,L}(x) + J_{2,res,4}(x) = \sum_{s=2}^4 C_s \frac{x^s}{s!} + J_{2,res,4}(x), \quad (\text{G70})$$

where

$$\begin{aligned} C_s &= J_2^{(s)}(0), \quad s = 2, 3, 4, \\ J_{2,res,s}(x) &= \int_0^x d\tau \frac{(x-\tau)^s}{s!} J_2^{(s+1)}(\tau). \end{aligned} \quad (\text{G71})$$

$J_{2,L}(x) := \sum_{s=2}^4 C_s \frac{x^s}{s!}$  denotes the leading-order terms in  $J_K(x)$ . Then, from Eq. (G13) and Eq. (G68), the 2nd-order Trotter remainder can be expressed as

$$\begin{aligned} V_2(x) &= I + \sum_{s=3}^5 F_{2,s}^{(nc)}(x) + F_{2,res}^{(nc)}(x), \\ F_{2,s}^{(nc)}(x) &= C_{s-1} \frac{x^s}{s!}, \quad 3, 4, 5, \\ F_{2,res}^{(nc)}(x) &= \int_0^x d\tau (M_2(\tau) J_{2,L}(\tau) + V_2(\tau) J_{2,res,4}(\tau)). \end{aligned} \quad (\text{G72})$$

We put the explicit nested-commutator expressions of the leading-order terms  $F_{2,s}^{(nc)}(x)$  ( $s = 3, 4$ , or  $5$ ) in Sec. H.

In practice, we truncate the formula with the order  $s_c = 5$ . Based on Eq. (G29), the truncated nested-commutator LCU formula for  $V_2(x)$  can be written as

$$\begin{aligned} \tilde{V}_2(x) &= I + \sum_{s=3}^5 F_{2,s}^{(nc)}(x), \\ &= \sqrt{1 + (\eta_\Sigma^{(nc)})^2} \sum_{s=3}^5 \frac{\eta_s^{(nc)}}{\eta_\Sigma^{(nc)}} R_{2,s}^{(nc)}(\eta_\Sigma). \end{aligned} \quad (\text{G73})$$

Here,  $\eta_\Sigma^{(nc)} := \sum_{s=3}^5 \|C_{s-1}\|_1 \frac{x^s}{s!}$ . The explicit form of  $R_{2,s}^{(nc)}(\eta_\Sigma)$  can be obtained by the definitions in Eq. (G28), Eq. (G30) and the Pauli operator decomposition based on the nested-commutator form in Eq. (H7).

Combined with the deterministic second-order Trotter formula, the overall LCU formula for  $U(x)$  is

$$\tilde{U}_2^{(nc)}(x) = \tilde{V}_2^{(nc)}(x) S_2(x). \quad (\text{G74})$$

The general  $2k$ th-order Trotter remainder can be expanded in the same manner. We put the generic derivation of the nested-commutator formula for the higher-order Trotter remainder of the lattice Hamiltonians in Sec. I. The nested-commutator expansion formulas for  $J_K(x)$  and  $J_K^{(s)}(x)$  are given in Eq. (I14) and Eq. (I17), respectively.

We have the following proposition to characterize the LCU formulas  $\tilde{V}_K(x)$  in Eq. (G29).

**Proposition 13** (Trotter-LCU formula by nested-commutator compensation for lattice Hamiltonians). *Consider a Lattice Hamiltonian with the form in Eq. (G4). We set  $\beta := 2(4\kappa + 5)$  where  $\kappa$  is the stage number of the  $K$ th-order Trotter formula ( $K = 1$  or  $2k$ ). For  $\min\{\frac{K+1}{\beta\Lambda}, \frac{K+2}{\beta\Lambda_1}\} > x > 0$ ,  $\tilde{V}_K^{(nc)}(x)$  in Eq. (G29) is a  $(\mu_K^{(nc)}(x), \varepsilon_K^{(nc)}(x))$ -LCU formula of  $V_K(x)$  with*

$$\begin{aligned} \mu_K^{(nc)} &\leq \exp\left(\frac{n^2 \kappa^2 \beta^{2(K+1)}}{2(K!)^2} (\Lambda_1 x)^{2K+2}\right), \\ \varepsilon_K^{(nc)} &\leq (n\kappa)^2 \frac{\beta^{2K+1}}{K!(K+1)!} (\Lambda x)^{2K+2}. \end{aligned} \quad (\text{G75})$$

As a result,  $\tilde{U}_K^{(nc)}(x)$  in Eq. (G29) is a  $(\mu_K^{(nc)}(x), \varepsilon_K^{(nc)}(x))$ -LCU formula of  $U(x)$ . Here,  $\Lambda$  and  $\Lambda_1$  are, respectively, the largest spectral norm and 1-norm of the lattice Hamiltonian components defined in Eq. (G6).

The proof of Proposition 13 is in Appendix I.

Now, we consider the Trotter-LCU formula  $\tilde{U}_K^{(nc)}(x)$  in Eq. (G29) for both random-sampling and coherent usages. For the random-sampling implementation, we have the following theorem.

**Theorem 2** (Gate complexity of the  $K$ th-order random-sampling Trotter-LCU algorithm by nested commutator compensation for lattice Hamiltonians). *In a  $K$ th-order Trotter-LCU algorithm ( $K = 1$  or  $2k$ ) based on nested commutator compensation, if the segment number  $\nu$  satisfy all the requirements below,*

$$\begin{aligned} \nu &\geq \max \left\{ \frac{\beta\Lambda}{K+1}t, \frac{\beta\Lambda_1}{K+2}t \right\}, \\ \nu &\geq \left( \frac{\kappa^2}{2 \ln \mu(K!)^2} \right)^{\frac{1}{2K+1}} \beta^{1+\frac{1}{2K+1}} n^{\frac{2}{2K+1}} (\Lambda_1 t)^{1+\frac{1}{2K+1}}, \\ \nu &\geq \left( \frac{\mu\kappa^2}{K!(K+1)!} \right)^{\frac{1}{2K+1}} \beta \varepsilon^{-\frac{1}{2K+1}} n^{\frac{2}{2K+1}} (\Lambda t)^{1+\frac{1}{2K+1}}, \end{aligned} \quad (\text{G76})$$

we can then realize a  $(\mu, \varepsilon)$ -LCU formula for  $U(t)$  based on  $\nu$  segments of  $\tilde{U}_K^{(nc)}(x)$  in Eq. ((G29)). As a result, the gate complexity of random-sampling  $K$ th-order Trotter-LCU algorithm based on nested commutator compensation for the lattice Hamiltonian is

$$\mathcal{O} \left( n^{1+\frac{2}{2K+1}} t^{1+\frac{1}{2K+1}} \varepsilon^{-\frac{1}{2K+1}} \right). \quad (\text{G77})$$

Here,  $\beta := 2(4\kappa + 5)$  where  $\kappa$  is the stage number of the Trotter formula.  $\Lambda$  and  $\Lambda_1$  are, respectively, the largest spectral norm and 1-norm of the lattice Hamiltonian components defined in Eq. (G6).

*Proof.* For the random-sampling implementation, the overall LCU formula for  $U(t)$  is to repeat the sampling of  $\tilde{U}_K^{(nc)}(x)$  for  $\nu$  times,  $\tilde{U}_{K,tot}^{(nc)}(t) = \tilde{U}_K^{(nc)}(x)^\nu$ . Using Proposition 2 and 13, when  $0 < x < \min\{\frac{K+1}{\beta\Lambda}, \frac{K+2}{\beta\Lambda_1}\}$ , we conclude that  $\tilde{U}_{K,tot}^{(nc)}(t)$  is a  $(\mu_{K,tot}^{(nc)}(t), \varepsilon_{K,tot}^{(nc)}(t))$ -LCU formula of  $U(t)$  with

$$\begin{aligned} \mu_{K,tot}^{(nc)}(t) &= \mu_K(x)^\nu \leq \exp \left( \frac{n^2 \kappa^2 \beta^{2(K+1)} (\Lambda_1 t)^{2K+2}}{2(K!)^2 \nu^{2K+1}} \right), \\ \varepsilon_{K,tot}^{(nc)}(t) &\leq \nu \mu_{K,tot}^{(nc)}(t) \varepsilon_K^{(nc)}(x) \leq \nu \mu_{K,tot}^{(nc)}(t) \left( (n\kappa)^2 \frac{\beta^{2K+1}}{K!(K+1)!} \frac{(\Lambda t)^{2K+2}}{\nu^{2K+2}} \right). \end{aligned} \quad (\text{G78})$$

To realize a  $(\mu, \varepsilon)$ -LCU formula for  $U(t)$ , we only need the segment number  $\nu$  satisfy all the requirements in Eq. ((G76)). To fulfill all the requirements in Eq. (G59), it suffices to choice

$$\nu = \mathcal{O} \left( n^{\frac{2}{2K+1}} t^{1+\frac{1}{2K+1}} \varepsilon^{-\frac{1}{2K+1}} \right). \quad (\text{G79})$$

Based on Eq. (D33), the gate complexity of the  $K$ th-order Trotter-LCU algorithm is then

$$\mathcal{O}(\nu(L + s_c)) = \mathcal{O} \left( n^{1+\frac{2}{2K+1}} t^{1+\frac{1}{2K+1}} \varepsilon^{-\frac{1}{2K+1}} \right). \quad (\text{G80})$$

Here we use the fact that  $s_c = 2K + 1 = \mathcal{O}(1)$  and  $L = \mathcal{O}(n)$  for lattice Hamiltonians.  $\square$

We illustrate the random-sampling implementation of the NCc formula in Eq. (G52) and Eq. (G74) in Fig. 9. The circuit of random-sampling implementation is the same as Fig. 8(a). We mainly set  $K = 1$  as an example due to its simplicity. Unlike the DTSc and PTSc algorithms, we cannot provide the explicit sampling probability  $\Pr(\gamma|s)$  of the Pauli operators  $P^{(nc)}(s-1, \gamma)$  in the nested-commutator expansion, which depends on the specific Hamiltonian structure. In practice, we need to expand the leading-order terms  $\{F_{K,s}\}$  to Pauli operators first, and then calculate the corresponding sampling probability  $\Pr(\gamma|s)$ .

For the coherent implementation of the NCc formula in Eq. (G74), to apply Corollary 1, we need to set

$$\mu_K^{(nc)}(x) \leq 2 \Leftrightarrow x = \frac{1}{\beta\Lambda_1} \left( \frac{2 \ln 2(K!)^2}{(n\kappa)^2} \right)^{\frac{1}{2K+2}} \Leftrightarrow \nu = \left( \frac{\kappa^2}{2 \ln 2(K!)^2} \right)^{\frac{1}{2K+2}} n^{\frac{1}{K+1}} (\beta\Lambda_1 t). \quad (\text{G81})$$

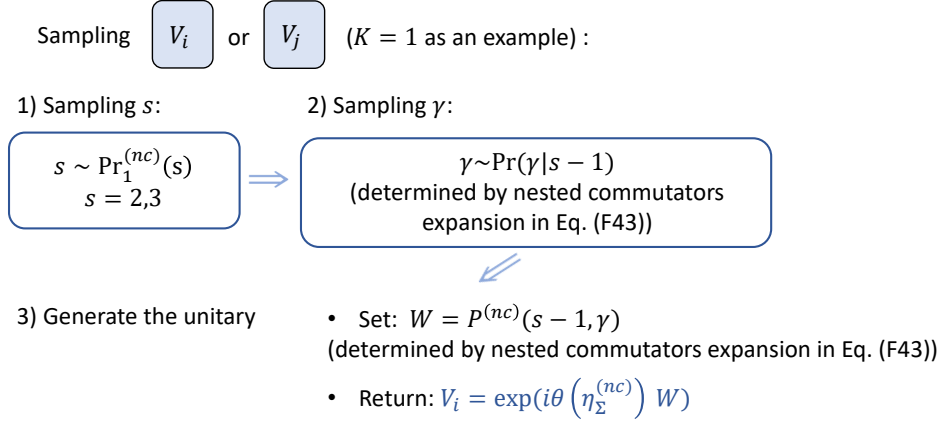

FIG. 10. The sampling procedure of  $V_i$  or  $V_j$  in the NCc algorithm. We set  $K = 1$  as example.

To achieve an overall simulation accuracy  $\varepsilon$ , we need

$$\nu \varepsilon_K^{(nc)}(x) \leq \varepsilon \Leftrightarrow \nu = \left( \frac{\kappa^2}{K!(K+1)!} \right)^{\frac{1}{2K+1}} \beta n^{\frac{2}{2K+1}} (\Lambda t)^{1+\frac{1}{2K+1}} \varepsilon^{-\frac{1}{2K+1}}. \quad (\text{G82})$$

Therefore, it suffice to choose  $\nu$  to be

$$\nu = \mathcal{O}(n^{\frac{2}{2K+1}} t^{1+\frac{1}{2K+1}} \varepsilon^{-\frac{1}{2K+1}}). \quad (\text{G83})$$

In each segment, we need to implement  $K$ th-order Trotter formula and the  $K+1$ th- to  $(2K+1)$ th-order LCU formula. The number of elementary unitaries is  $\mathcal{O}(n)$ . Therefore, the overall gate complexity is

$$\mathcal{O}(n^{1+\frac{2}{2K+1}} t^{1+\frac{1}{2K+1}} \varepsilon^{-\frac{1}{2K+1}}). \quad (\text{G84})$$

#### 4. General Hamiltonians

We can easily extend the methods to analyze the lattice model Hamiltonian to a general Hamiltonian. Now, we consider a  $L$ -sparse Hamiltonian with the form,

$$H = \sum_{l=1}^L H_l. \quad (\text{G85})$$

The  $K$ th-order Trotter formula ( $K = 1$  or  $2k$ ,  $k \in \mathbb{N}_+$ ) for the real-times evolution  $U(x) = e^{-ixH}$  can be written as

$$S_K(x) = \prod_{j=1}^{\kappa} \prod_{l=1}^L e^{-ix a_{(j,l)} H_{\pi_j(l)}}. \quad (\text{G86})$$

Here,  $\kappa$  is the stage number defined in Sec. D. We have  $\kappa = 1$  for  $K = 1$  and  $\kappa \leq 2 \cdot 5^{k-1}$  when  $K = 2k$ . The stage length coefficients  $a_{(j,l)}$  are determined based on Eq. (D9) and Eq. (D10). The permutation  $\pi_j$  indicates the ordering of the summands  $\{H_l\}$  within the  $j$ th-stage in the Trotter formula. In the Suzuki's constructions [8] of Trotter formulas considered in this work, we alternately reverse the ordering of summands between neighboring stages. In what follows, we omit the subscript  $K$  in  $S_K(x)$  for simplicity.

To further simplify the notation, we introduce the lexicographical order [14] for the pair of tuples  $(j, l)$  in Eq. (G86). For two pairs of tuples  $(j, l)$  and  $(j', l')$ , we have

1.  $(j, l) \succeq (j', l')$  if  $j > j'$ , or if  $j = j'$  and  $l > l'$ .
2.  $(j, l) \succ (j', l')$  if  $(j, l) \succeq (j', l')$  and  $(j, l) \neq (j', l')$ .

We can also define  $(j, l) \preceq (j', l')$  and  $(j, l) \succ (j', l')$  in the same way. We denote the number of different tuples  $(j, l)$  in  $S_K(x)$  as  $\Upsilon$ , which is usually equal to  $\kappa L$ . We can then express  $S_K(x)$  and  $S_K(x)^\dagger$  in the following way,

$$\begin{aligned} S_K(x) &= \prod_{(j,l)}^{\leftarrow} e^{-ixa_{(j,l)} H_{\pi_j(l)}}, \\ S_K(x)^\dagger &= \prod_{(j,l)}^{\rightarrow} e^{ixa_{(j,l)} H_{\pi_j(l)}}. \end{aligned} \quad (\text{G87})$$

Similar to the case of lattice Hamiltonians, based on Eq. (G13) and Eq. (G30), we can expand the Trotter remainder  $V_K(x)$  to the following form,

$$V_K(x) = I + F_L(x) + F_{K,res}(x), \quad (\text{G88})$$

where

$$\begin{aligned} F_L(x) &:= \sum_{s=K}^{2K} C_s \frac{x^{s+1}}{(s+1)!}, \\ F_{K,res}(x) &:= \int_0^x d\tau (M_K(\tau) J_L(\tau) + V_K(\tau) J_{K,res,2K}(\tau)). \end{aligned} \quad (\text{G89})$$

Here,  $F_L(x)$  indicates the leading-order terms to be compensated by LCU formula,  $F_{K,res}(x) = \mathcal{O}(x^{2K+2})$  is the high-order part.

In practice, we remove the high-order part with order  $s > 2K + 1$  and implement

$$\begin{aligned} \tilde{V}_K^{(nc)}(x) &= I + F_L(x) = I + \sum_{s=K+1}^{2K+1} C_{s-1} \frac{x^s}{s!} \\ &= \sqrt{1 + (\eta_\Sigma^{(nc)})^2} \sum_{s=K+1}^{2K+1} \frac{\eta_s^{(nc)}}{\eta_\Sigma^{(nc)}} R_{2,s}^{(nc)}(\eta_\Sigma). \end{aligned} \quad (\text{G90})$$

Here,  $\eta_\Sigma^{(nc)} := \sum_{s=K+1}^{2K+1} \|C_{s-1}\|_1 \frac{x^s}{s!}$ . The explicit form of  $R_{2,s}^{(nc)}(\eta_\Sigma)$  can be obtained by the definitions in Eq. (G28), Eq. (G30) and the Pauli operator decomposition based on the nested-commutator form in Eq. (H7).

To use  $\tilde{V}_K(x)$ , we need to solve the explicit form of  $C_s$  and calculate  $(\mu, \varepsilon)$ . In Appendix J, we explicitly solve the form of  $C_s$ ,

$$\begin{aligned} C_s &= i \sum_{(j,l)} \sum_{\substack{\sum_{(j',l')} m_{(j',l')} = s \\ (j',l') \succ (j,l)}} \binom{s}{\{m_{(j',l')}\}} \left( \prod_{(j',l') \succ (j,l)}^{\leftarrow} (-ia_{(j',l')} \text{ad}_{H_{\pi_{j'}(l')}})^{m_{(j',l')}} \right) (a_{(j,l)} H_{\pi_j(l)}) \\ &\quad - i \sum_{\sum_{(j',l')} m_{(j',l')} = s} \binom{s}{\{m_{(j',l')}\}} \left( \prod_{(j',l')}^{\leftarrow} (-ia_{(j',l')} \text{ad}_{H_{\pi_{j'}(l')}})^{m_{(j',l')}} \right) H. \end{aligned} \quad (\text{G91})$$

Here,  $\{m_{(j',l')}\}$  are a group of integers whose summation is  $s$ . Their corresponding multinomial coefficient is given by

$$\binom{s}{\{m_{(j',l')}\}} := \frac{s!}{\prod_{(j',l')} m_{(j',l')}!}. \quad (\text{G92})$$

Eq. ((G91)) is then a summation of nested commutators with the form,

$$\text{ad}_{H_{l_s}} \dots \text{ad}_{H_{l_2}} \text{ad}_{H_{l_1}} H_l. \quad (\text{G93})$$

Again, one can check that  $C_s$  is anti-Hermitian. Therefore, one can still pair the leading-order terms  $F_L(x)$  with  $I$  to suppress the 1-norm, shown in Eq. (G90).

We have the following proposition to characterize the LCU formula  $\tilde{V}_K(x)$  in Eq. ((G90)).



**Proposition 14** (Trotter-LCU formula by nested-commutator compensation for general Hamiltonians). *For  $x > 0$ ,  $\tilde{V}_K(x)$  in Eq. (G90) is a  $(\mu^{(nc)}(x), \varepsilon^{(nc)}(x))$ -LCU formula of  $K$ th-order Trotter remainder  $V_K(x) = U(x)S_K(x)$  with*

$$\begin{aligned}\mu^{(nc)} &\leq \sqrt{1 + 4\kappa^2 \left( \sum_{s=K}^{2K} \alpha_{H,1}^{(s)} \frac{x^{s+1}}{(s+1)!} \right)^2}, \\ \varepsilon^{(nc)} &\leq 4\kappa^2 \alpha_H^{(K)} \sum_{s=K}^{2K} \alpha_H^{(s)} \frac{x^{s+K+2}}{s!(K+1)!(s+K+2)} + 2\kappa \frac{x^{2K+2}}{(2K+2)!} \alpha_H^{(2K+1)}.\end{aligned}\tag{G94}$$

Here, we define the nested commutator norms to be

$$\begin{aligned}\alpha_H^{(s)} &:= \sum_{l=1}^L \alpha_{com}^{(s)}(\overleftarrow{\{H_{\pi_{j'}(l)}\}}; H_l), \\ \alpha_{com}^{(s)}(A_r, \dots, A_1; B) &:= \sum_{m_1 + \dots + m_r = s} \binom{s}{m_1, \dots, m_r} \|\text{ad}_{A_r}^{m_r} \dots \text{ad}_{A_1}^{m_1} B\|,\end{aligned}\tag{G95}$$

where  $\overleftarrow{\{H_{\pi_{j'}(l)}\}}$  indicates a sequence of  $\Upsilon = \kappa L$  summands with the lexicographical order given by the  $K$ th-order Trotter formula in Eq. (G87).  $\alpha_{H,1}^{(s)}$  is defined similarly by replacing the spectral norm to 1-norm in Eq. ((G95)).

The proof of Proposition 14 can be found in Appendix J. To characterize the performance of the Trotter-LCU algorithm, we only need to estimate the values of  $\alpha_H^{(s)}$  and  $\alpha_{H,1}^{(s)}$  for a given Hamiltonian.

We note that, the nested commutator norm  $\alpha_{com}^{(s)}$  is originally defined in Ref. [14] to analyze the performance of Trotter methods. In Ref. [14], the authors estimate the values of  $\alpha_H^{(s)}$  for typical Hamiltonian models like planewave-basis quantum chemistry models,  $k$ -local Hamiltonian, and Hamiltonians with power-law interactions. Following their estimation methods, we can also calculate  $\alpha_{H,1}^{(s)}$  for different models and consider their explicit nested-commutator expansions. We will leave the explicit evaluation of other typical Hamiltonians for a future work.

## Appendix H: Tighter nested-commutator analysis for second-order Trotter-LCU algorithm

For a better numerical simulation, we now provide tighter bounds for the 2nd-order Trotter-LCU algorithm. That is, for the LCU formula in Eq. (G73), we seek for a tighter bound of the 1-norm  $\mu_2^{(nc)}(x)$  and spectral norm accuracy  $\varepsilon_2^{(nc)}(x)$ .

### 1. Bound the 1-norm of recurrence function

From Eq. (G66) we know that

$$J_2(x) = \frac{i}{2} (A - e^{-i\frac{x}{2}\text{ad}_A} e^{-ix\text{ad}_B} A) + i (e^{-i\frac{x}{2}\text{ad}_A} B - e^{-i\frac{x}{2}\text{ad}_A} e^{-ix\text{ad}_B} e^{-i\frac{x}{2}\text{ad}_A} B).\tag{H1}$$

Hereafter, we redefine the operators to simplify the notation

$$\begin{aligned}A &\leftarrow -\frac{i}{2}A, \\ B &\leftarrow -iB.\end{aligned}\tag{H2}$$

We have

$$\begin{aligned}J_2(x) &= J_a(x) + J_b(x), \\ J_a(x) &= (e^{x\text{ad}_A} e^{x\text{ad}_B} A - A), \\ J_b(x) &= (e^{x\text{ad}_A} e^{x\text{ad}_B} e^{x\text{ad}_A} B - e^{x\text{ad}_A} B).\end{aligned}\tag{H3}$$

From the operator-form Taylor-series expansion in Eq. (G40) and the order condition in Proposition 9, we have

$$\begin{aligned} J_2(x) &= \sum_{s=2}^4 C_s \frac{x^s}{s!} + J_{2,res,4}(x) \\ C_s &:= J_K^{(s)}(0), \\ J_{2,res,4}(x) &:= \int_0^x d\tau \frac{(x-\tau)^4}{4!} J^{(5)}(\tau). \end{aligned} \quad (\text{H4})$$

Based on the Libniz rule, we have

$$\begin{aligned} J_a^{(s)}(x) &= \sum_{l=0}^s \binom{s}{l} e^{x\text{ad}_A} \text{ad}_A^l e^{x\text{ad}_B} \text{ad}_B^{s-l} A, \\ J_b^{(s)}(x) &= \sum_{\substack{l_1, l_2, l_3 \\ l_1+l_2+l_3=s, l_2+l_3 \neq 0}} \binom{s}{l_1, l_2, l_3} e^{x\text{ad}_A} \text{ad}_A^{l_1} e^{x\text{ad}_B} \text{ad}_B^{l_2} e^{x\text{ad}_A} \text{ad}_A^{l_3} B. \end{aligned} \quad (\text{H5})$$

Then,

$$C_s = \sum_{l=0}^{s-1} \text{ad}_A^l \text{ad}_B^{s-l} A + \sum_{\substack{l_1, l_2, l_3 \\ l_1+l_2+l_3=s, l_2+l_3 \neq 0}} \binom{s}{l_1, l_2, l_3} \text{ad}_A^{l_1} \text{ad}_B^{l_2} \text{ad}_A^{l_3} B. \quad (\text{H6})$$

We can solve the explicit form of the leading-order terms with  $s = 2, 3$ , and 4,

$$\begin{aligned} C_2 &= (\text{ad}_B^2 A + 2\text{ad}_A \text{ad}_B A) + (3\text{ad}_A^2 B + 2\text{ad}_B \text{ad}_A B), \\ C_3 &= (\text{ad}_B^3 A + 3\text{ad}_A \text{ad}_B^2 A + 3\text{ad}_A^2 \text{ad}_B A) + (7\text{ad}_A^3 B + 3\text{ad}_B \text{ad}_A^2 B + 6\text{ad}_A \text{ad}_B \text{ad}_A B + 3\text{ad}_B^2 \text{ad}_A B), \\ C_4 &= (\text{ad}_B^4 A + 4\text{ad}_A \text{ad}_B^3 A + 6\text{ad}_A^2 \text{ad}_B^2 A + 4\text{ad}_A^3 \text{ad}_B A) + (15\text{ad}_A^4 B + 4\text{ad}_B \text{ad}_A^3 B \\ &\quad + 12\text{ad}_A^2 \text{ad}_B \text{ad}_A B + 12\text{ad}_A \text{ad}_B \text{ad}_A^2 B + 6\text{ad}_B^2 \text{ad}_A^2 B + 12\text{ad}_A \text{ad}_B^2 \text{ad}_A B + 4\text{ad}_B^3 \text{ad}_A B), \end{aligned} \quad (\text{H7})$$

recall that here we use the notation in Eq. (H2).

We can then expand the operators  $A$  and  $B$  to Pauli operators and solve the 1-norm of  $C_2, C_3$ , and  $C_4$  under the Pauli decomposition based on Eq. (H7). The 1-norm of  $\tilde{V}_2^{(nc)}(x)$  is given by

$$\tilde{\mu}_2^{(nc)}(x) = \sqrt{1 + \left( \sum_{s=2}^4 \|C_s\|_1 \frac{x^{s+1}}{(s+1)!} \right)^2}. \quad (\text{H8})$$

We summarize the estimation procedure for the gate number of 2-order Trotter-LCU under nested-commutator compensation as follows.

1. For a specific lattice Hamiltonian, get the explicit Pauli expansion form of  $C_2, C_3, C_4$  by Eq. (H7).
2. Get the expression of the 1-norm  $\tilde{\mu}^{(nc)}(x)$  by Eq. (H8). Calculate  $x_U$  based on  $\tilde{\mu}^{(nc)}(x) = 2$ .
3. Solve the following residue operator,

$$V_{2,res}(x) = V_2(x) - \tilde{V}_2(x) = U(x)S_2(x)^\dagger, \quad (\text{H9})$$

calculate its spectral norm  $\|V_{2,res}(x)\|$  numerically. Check either the following requirement gets satisfied,

$$\|V_{2,res}(x)\| \frac{t}{x} \leq \varepsilon, \quad (\text{H10})$$

where  $\varepsilon$  is a preset accuracy requirement. If not, we search the largest  $x$  value in the region  $0 < x < x_U$  by dichotomy which makes Eq. (H10) satisfied.

4. The number of segments is given by  $\nu := t/x$ . We then calculate the number of gates accordingly.

We have a tighter count bound for the norm of  $J_a^{(s)}(x)$  and  $J_b^{(s)}(x)$ ,

**Proposition 15.** *Consider a lattice Hamiltonian  $H = A + B$  with the form in Eq. (G4). Suppose the spectral norm and 1-norm of its components  $H_{j,j+1}$  are bounded by  $\Lambda$  and  $\Lambda_1$ . Then for the recurrence function  $J_2(x)$ , we have the following norm bound for its derivatives,*

$$\begin{aligned}\|J_2^{(s)}(x)\| &\leq \frac{n}{2}(7^s + 12^s)\Lambda^{s+1}, \\ \|J_2^{(s)}(x)\|_1 &\leq \frac{n}{2}(7^s + 12^s)\Lambda_1^{s+1}.\end{aligned}\tag{H11}$$

*Proof.* From Eq. (H5) we have,

$$\begin{aligned}\|J_a^{(s)}(x)\| &\leq \sum_{l=0}^s \binom{s}{l} \|e^{x\text{ad}_A} \text{ad}_A^l e^{x\text{ad}_B} \text{ad}_B^{s-l} A\|, \\ \|J_b^{(s)}(x)\| &\leq \sum_{\substack{l_1, l_2, l_3 \\ l_1+l_2+l_3=s, l_2+l_3 \neq 0}} \binom{s}{l_1, l_2, l_3} \|e^{x\text{ad}_A} \text{ad}_A^{l_1} e^{x\text{ad}_B} \text{ad}_B^{l_2} e^{x\text{ad}_A} \text{ad}_A^{l_3} B\|.\end{aligned}\tag{H12}$$

Recall that we are using the convention in Eq. (H2) to simplify the notation.

To bound the norm of nested commutators, we use the same methods in Proposition 16. We have

$$\begin{aligned}\|e^{x\text{ad}_A} \text{ad}_A^l e^{x\text{ad}_B} \text{ad}_B^{s-l} A\| &\leq (3^l 2^{s-l})(\Lambda^l (2\Lambda)^{s-l}) \cdot \left(\frac{n}{2}\Lambda\right), \\ \|e^{x\text{ad}_A} \text{ad}_A^{l_1} e^{x\text{ad}_B} \text{ad}_B^{l_2} e^{x\text{ad}_A} \text{ad}_A^{l_3} B\| &\leq (4^{l_1} 3^{l_2} 2^{l_3})(\Lambda^{l_1} (2\Lambda)^{l_2} \Lambda^{l_3}) \cdot \left(\frac{n}{2}\Lambda\right).\end{aligned}\tag{H13}$$

Here, the first bracket of each bound corresponds to possible nest commutators, while the second bracket of each bound indicates the norm enlargement of each nested commutator. Recall that the norm of  $A$  is  $\frac{\Lambda}{2}$  when  $A$  is defined based on the convention in Eq. (H2).

Combining Eq. (H12) and Eq. (H13), we have

$$\begin{aligned}\|J_a^{(s)}(x)\| &\leq \sum_{l=0}^s \binom{s}{l} (3\Lambda)^l (2 \cdot 2\Lambda)^{s-l} \cdot \left(\frac{n}{2}\Lambda\right) \\ &\leq (7\Lambda)^s \left(\frac{n}{2}\Lambda\right), \\ \|J_b^{(s)}(x)\| &\leq \sum_{\substack{l_1, l_2, l_3 \\ l_1+l_2+l_3=s, l_2+l_3 \neq 0}} \binom{s}{l_1, l_2, l_3} (4\Lambda)^{l_1} (3 \cdot 2\Lambda)^{l_2} (2\Lambda)^{l_3} \cdot \left(\frac{n}{2}\Lambda\right) \\ &\leq (12\Lambda)^s \left(\frac{n}{2}\Lambda\right).\end{aligned}\tag{H14}$$

The 1-norm bound can be derived in the same way. □

We can derive the bounds for  $\tilde{\mu}_2^{(nc)}(x)$  and  $\varepsilon_2^{(nc)}(x)$  as follows,

$$\tilde{\mu}_2^{(nc)}(x) = \sqrt{1 + \left(\sum_{s=2}^4 \|C_s\|_1 \frac{x^{s+1}}{(s+1)!}\right)^2}\tag{H15}$$

$$\leq \sqrt{1 + \frac{n^2}{4} \left(\sum_{s=2}^4 (7^s + 12^s) \frac{(\Lambda_1 x)^{s+1}}{(s+1)!}\right)^2}\tag{H16}$$

$$\leq \exp((35n)^2 (\Lambda_1 x)^6)\tag{H17}$$

$$\varepsilon_2^{(nc)}(x) \leq \int_0^x \left(\frac{n}{2}(7^2 + 12^2)\Lambda^3 \frac{x^3}{3!}\right) \left(\frac{n}{2} \sum_{s=2}^4 (7^s + 12^s)\Lambda^{s+1} \frac{x^s}{s!}\right) + \left(\frac{n}{2}(7^5 + 12^5)\Lambda^6 \frac{x^5}{5!}\right)\tag{H18}$$

$$\leq \frac{n^2}{4}(7^2 + 12^2) \sum_{s=2}^4 (7^s + 12^s) \frac{(\Lambda x)^{s+4}}{3!s!(s+4)} + \frac{n}{2}(7^5 + 12^5) \frac{(\Lambda x)^6}{6!}\tag{H19}$$

$$\leq (3n^2 + 185n)(\Lambda x)^6 \leq 370n^2 (\Lambda x)^6,\tag{H20}$$

Here, Eq. (H17) holds when  $\Lambda_1 x \leq 1/3$ , Eq. (H20) holds when  $\Lambda x \leq 21/72$ .

## 2. Estimating the gate counts

To estimate the performance, i.e., gate complexity of the Trotter-LCU algorithm based on nested-commutator compensation, we need to first estimate the number of segments  $\nu = t/x$  in the algorithm. This is determined by the following three constraints,

$$\begin{aligned} \Lambda_1 x, \Lambda x \leq 1 &\Leftrightarrow \nu \geq \max\{\Lambda_1 t, \Lambda t\}, \\ (\tilde{\mu}^{(nc)})^\nu \leq 2 &\Leftrightarrow \nu \ln \tilde{\mu}^{(nc)} \leq \ln 2, \\ \nu \tilde{\mu}^\nu (\varepsilon^{(nc)}) \leq \varepsilon &\Leftrightarrow \nu \varepsilon^{(nc)} \leq \frac{1}{2} \varepsilon. \end{aligned} \tag{H21}$$

After we solve the required segment number  $\nu$  by Eq. (H21), we can estimate the gate number accordingly. Here, we introduce the method to estimate the gate number of the LCU part. The gate number in the implementation of 2nd-order Trotter formula can be evaluated following the methods in Ref. [32]. In the worst-case scenario, the Pauli weight of the gate is determined by the weight of Pauli operators contained in  $C_4$  in Eq. (H7). The largest Pauli weight is 6. As a result,, a controlled-Pauli rotation will cost at most 6 CNOT gates and no non-Clifford gate.

If we consider the paired algorithm, when we sample the 3-order term, it will be a Pauli rotation unitary on 4 qubits. In this case, it will cost 8 CNOT gates and 2 single-qubit Pauli rotation gates  $R_z(\theta)$ .

We summarize the whole procedure to estimate the gate complexity.

1. Input: Hamiltonian parameters:  $H = A+B$ ,  $n$ ,  $\Lambda$ ,  $\Lambda_1$ . Normalization requirements  $\mu = 2$ , accuracy requirements  $\varepsilon$ , time requirements  $t$ .
2. Normalization factor estimation.
  - (a) Analytical way (scalable). Using Eq. (H16) to get the function  $\tilde{\mu}^{(nc)}(x)$ .
  - (b) Numerical way (scalable). Using Eq. (H7) to get the form of  $C_2$ ,  $C_3$ , and  $C_4$ . Then get the function  $\tilde{\mu}^{(nc)}(x)$  by Eq. (H15).
3. Accuracy estimation.
  - (a) Analytical way (scalable). Using Eq. (H19) to get the function  $\varepsilon^{(nc)}(x)$ .
  - (b) Numerical way (unscalable). Calculate  $V_{2,res}(x) := U(x)S_2(x)^\dagger - I - \sum_{s=2}^4 C_s \frac{x^{s+1}}{(s+1)!}$  numerically. Solve its largest singular value, which is an upper bound of  $\varepsilon^{(nc)}(x)$ .
4. Based on the constraints in Eq. (H21), calculate the segment number  $\nu$ .
5. Analyze the CNOT and  $R_z(\theta)$  gate number.

### Appendix I: Explicit nested-commutator compensation for higher-order Trotter remainders

In this section, we provide detailed results for the nested-commutator compensation for higher-order Trotter remainders introduced in Sec. G. Here, we will focus on the lattice model Hamiltonians in Eq. (G4). The results for general Hamiltonians will be presented in Sec. J.

As is introduced in Sec. G 1, for the (asymmetric) multiplicative remainder  $V_K(x)$ , our aim is to construct a LCU formula with the following form

$$V_K(x) = I + \sum_{s=K+1}^{2K+1} F_{K,s}^{(nc)}(x) + F_{K,res}^{(nc)}(x), \tag{I1}$$

where  $F_{K,res}^{(nc)}(x)$  denotes the term with  $x$ -order  $O(x^{2K+2})$ . In practice, we will use the truncated LCU formula with

paired leading-order terms, derived in Eq. (G29),

$$\begin{aligned}
\tilde{V}_K^{(nc)}(x) &= I + \sum_{s=K+1}^{2K+1} F_{K,s}^{(nc)}(x) \\
&= I + i \sum_{s=K}^{2K} \eta_s^{(nc)} V_{K,s}^{(nc)} \\
&= \sum_{s=K}^{2K} \frac{\eta_s^{(nc)}}{\eta_\Sigma^{(nc)}} \left( I + \eta_\Sigma^{(nc)} V_{K,s}^{(nc)} \right) \\
&= \sqrt{1 + (\eta_\Sigma^{(nc)})^2} \sum_{s=K}^{2K} \frac{\eta_s^{(nc)}}{\eta_\Sigma^{(nc)}} R_{K,s}^{(nc)}(\eta_\Sigma),
\end{aligned} \tag{I2}$$

where  $\eta_\Sigma^{(nc)} = \sum_{s=K+1}^{2K+1} \eta_s^{(nc)} = \sum_{s=K}^{2K} \|C_{s-1}\|_1 \frac{x^{s+1}}{(s+1)!}$ .

We are going to finish the following tasks,

1. (Sec. I1) Derive the explicit formulas for the leading-order expansion terms  $F_{K,s}^{(nc)}(x)$  with  $s = K + 1, \dots, 2K + 1$ .
2. (Sec. I2) Prove the 1-norm  $\mu_K^{(nc)}(x)$  and error bound  $\varepsilon_K^{(nc)}(x)$  in Proposition 13.

### 1. Derivation of LCU formula with nested-commutator form

We first introduce the canonical expression of the  $K$ th-order Trotter formula,

$$S_K(x) := W(x) = \prod_{j=1}^{\kappa} W_j(x) = W_\kappa(x) \dots W_2(x) W_1(x), \tag{I3}$$

where

$$W_j(x) := e^{-ixb_j B} e^{-ixa_j A}, \tag{I4}$$

is the  $j$ th stage of the Trotter formula.  $\kappa$  is the stage number. We have  $\kappa = 1$  for  $K = 1$  and  $\kappa \leq 2 \cdot 5^{k-1}$  when  $K = 2k$ . The stage lengths  $a_j$  and  $b_j$  are determined based on Eq. (D9) and Eq. (D10). We have

$$\begin{aligned}
0 \leq a_j, b_j \leq 1, \quad \forall j = 1, 2, \dots, \kappa, \\
\sum_{j=1}^{\kappa} a_j = \sum_{j=1}^{\kappa} b_j = 1.
\end{aligned} \tag{I5}$$

For example, for the 2nd-order Trotter formula  $S_2(x) = e^{-ix\frac{A}{2}} e^{-ixB} e^{-ix\frac{A}{2}}$ , we set the stage number  $\kappa = 2$  with  $a_1 = \frac{1}{2}, b_1 = 1; a_2 = \frac{1}{2}, b_2 = 0$ .

The Hermitian conjugate of  $W(x)$  is

$$W(x)^\dagger = \prod_{j=\kappa}^1 W_j(x)^\dagger = W_1(x)^\dagger W_2(x)^\dagger \dots W_\kappa(x)^\dagger. \tag{I6}$$

As is discussed in Sec. G1, to derive the nested-commutator form of  $V_K(x)$ , we first solve  $J_K(x)$  defined in Eq. (G14). We have

$$\begin{aligned}
R_K(x) &= \frac{d}{dx} W(x)^\dagger - iHW(x)^\dagger, \\
J_K(x) &:= W(x)R_K(x).
\end{aligned} \tag{I7}$$

From Proposition 9, we can write the  $K$ th-Trotter remainder  $V_K(x)$  and  $J_K(x)$  as the following form.

$$\begin{aligned}
V_K(x) &:= I + M_K(x) = I + \sum_{s=K+1}^{2K+1} C_{s-1} \frac{x^s}{s!} + F_{K,res}(x), \\
J_K(x) &= \sum_{s=K}^{2K} C_s \frac{x^s}{s!} + J_{K,res,2K}(x),
\end{aligned} \tag{I8}$$

where  $F_{K,res}(x) = \mathcal{O}(x^{2K+2})$  and  $J_{K,res,2K}(x) = \mathcal{O}(x^{2K+1})$  are the higher-order remaining terms to be analyzed later. We also denote

$$\begin{aligned}
F_L(x) &:= \sum_{s=K+1}^{2K+1} C_{s-1} \frac{x^s}{s!}, \\
J_L(x) &:= \sum_{s=K}^{2K} C_s \frac{x^s}{s!},
\end{aligned} \tag{I9}$$

as the leading orders whose explicit forms will be calculated in this section. We will show that  $F_L(x)$  contains  $\mathcal{O}(n)$  term where  $n$  is the lattice size.

Now, we are going to solve the exact form of  $C_s$  for the leading orders. We first try to solve the succinct form of  $R_K(x)$  based on its definition in Eq. (I7). Taking the derivative for each Trotter stage, we have

$$\begin{aligned}
R_K(x) &= \frac{d}{dx} \left[ \prod_{j=\kappa}^1 W_j(x)^\dagger \right] - iH \prod_{j=\kappa}^1 W_j(x)^\dagger \\
&= \sum_{j=\kappa}^1 \prod_{l=j-1}^1 W_l(x)^\dagger \frac{d}{dx} W_j(x)^\dagger \prod_{l=\kappa}^{j+1} W_l(x)^\dagger - \sum_{j=\kappa}^1 (ia_j A + ib_j B) \prod_{l=\kappa}^1 W_l(x)^\dagger.
\end{aligned} \tag{I10}$$

Here we assume  $1 \leq j-1 < j+1 \leq \kappa$ . When  $j=1$  (or  $\kappa$ ), the value of the product  $\prod_{l=j-1}^1 W_l(x)^\dagger$  (or  $\prod_{l=\kappa}^{j+1} W_l(x)^\dagger$ ) will be regarded as  $I$ . Recall that  $W_j(x)^\dagger = e^{ixa_j A} e^{ixb_j B}$ . We further expand  $\frac{d}{dx} W_j(x)^\dagger$  and merge the two terms together,

$$\begin{aligned}
R_K(x) &= \sum_{j=\kappa}^1 \prod_{l=j-1}^1 W_l(x)^\dagger (ia_j A W_j(x)^\dagger + W_j(x)^\dagger ib_j B) \prod_{l=\kappa}^{j+1} W_l(x)^\dagger - \sum_{j=\kappa}^1 (ia_j A + ib_j B) \prod_{l=\kappa}^1 W_l(x)^\dagger \\
&= \sum_{j=\kappa}^1 \left[ \prod_{l=j}^1 W_l(x)^\dagger, ia_{j+1} A + ib_j B \right] \prod_{l=\kappa}^{j+1} W_l(x)^\dagger.
\end{aligned} \tag{I11}$$

Here, we assume  $a_{\kappa+1} = 0$ . Now, we simplify the commutator by splitting the product and then change the summation order,

$$\begin{aligned}
R_K(x) &= \sum_{j=\kappa}^1 \sum_{s=j}^1 \left( \prod_{m=s-1}^1 W_m(x)^\dagger [W_s(x)^\dagger, ia_{j+1} A + ib_j B] \prod_{m=j}^{s+1} W_m(x)^\dagger \right) \prod_{l=\kappa}^{j+1} W_l(x)^\dagger \\
&= \sum_{s=\kappa}^1 \sum_{j=\kappa}^s \left( \prod_{m=s-1}^1 W_m(x)^\dagger [W_s(x)^\dagger, ia_{j+1} A + ib_j B] \prod_{m=j}^{s+1} W_m(x)^\dagger \right) \prod_{l=\kappa}^{j+1} W_l(x)^\dagger \\
&= \sum_{s=\kappa}^1 \sum_{j=\kappa}^s \prod_{m=s-1}^1 W_m(x)^\dagger [W_s(x)^\dagger, ia_{j+1} A + ib_j B] \prod_{l=\kappa}^{s+1} W_l(x)^\dagger \\
&= \sum_{s=\kappa}^1 \prod_{m=s-1}^1 W_m(x)^\dagger [W_s(x)^\dagger, ic_{j+1} A + id_s B] \prod_{l=\kappa}^{s+1} W_l(x)^\dagger,
\end{aligned} \tag{I12}$$

where

$$c_s := \sum_{j=\kappa}^s a_j, \quad d_s = \sum_{j=\kappa}^s b_j, \quad s \leq \kappa. \quad (\text{I13})$$

We also set  $c_{\kappa+1} = 0$ .

Based on Eq. (I12), we now derive the succinct form of  $J_K(x)$ ,

$$\begin{aligned} J_K(x) &= W(x)R_K(x) = \prod_{l=1}^{\kappa} W_l(x)R_K(x) \\ &= \sum_{s=\kappa}^1 \prod_{l=s}^{\kappa} W_l(x)[W_s(x)^\dagger, ic_{s+1}A + id_sB] \prod_{m=\kappa}^{s+1} W_m(x)^\dagger. \end{aligned} \quad (\text{I14})$$

We expand each stage of the Trotter formula  $W_l(x)$  in the formula,

$$\begin{aligned} J_K(x) &= i \sum_{j=\kappa}^1 \left( \prod_{l=j+1}^{\kappa} W_l(x)^\dagger (c_{j+1}A + d_jB) \prod_{l=\kappa}^{j+1} W_l(x)^\dagger - \prod_{l=j}^{\kappa} W_l(x)^\dagger (c_{j+1}A + d_jB) \prod_{l=\kappa}^j W_l(x)^\dagger \right) \\ &= -i \sum_{j=\kappa}^1 \left( \prod_{l=j}^{\kappa} e^{-i\tau b_l \text{ad}_B} e^{-i\tau a_l \text{ad}_A} (c_{j+1}A + d_jB) - \prod_{l=j+1}^{\kappa} e^{-i\tau b_l \text{ad}_B} e^{-i\tau a_l \text{ad}_A} (c_{j+1}A + d_jB) \right). \end{aligned} \quad (\text{I15})$$

Finally, we apply the following operator-valued Taylor expansion formula with integral form of the remainder,

$$Q(x) = \sum_{s=0}^k \frac{x^s}{s!} Q^{(s)}(0) + \int_0^x d\tau \frac{(x-\tau)^k}{k!} Q^{(k+1)}(\tau). \quad (\text{I16})$$

By the general Libniz formula, we obtain the derivatives of  $J_K(x)$  as follows,

$$\begin{aligned} J_K^{(s)}(x) &= (-i)^{s+1} \sum_{j=\kappa}^1 \sum_{\substack{m_j, n_j, \dots, m_\kappa, n_\kappa \\ m_j, n_j \neq 0; \sum_{l=j}^{\kappa} m_l + n_l = s}} \binom{s}{m_j, n_j, \dots, m_\kappa, n_\kappa} \\ &\quad \prod_{l=j}^{\kappa} (b_l^{m_l} a_l^{n_l}) \prod_{l=j}^{\kappa} (e^{-itb_l \text{ad}_B} \text{ad}_B^{m_l} e^{-ita_l \text{ad}_A} \text{ad}_A^{n_l}) (c_{j+1}A + d_jB). \end{aligned} \quad (\text{I17})$$

We can then expand  $J_K(x)$  around  $t = 0$  as follows,

$$J_K(x) = \sum_{s=K}^{2K} C_s \frac{x^s}{s!} + J_{K, \text{res}, 2K}(x). \quad (\text{I18})$$

Here, we use the order condition in Proposition 9 so that the terms with expansion order from 0 to  $K - 1$  are all zeros. The  $s$ th-order term  $C_s$  and the  $2K$ th-order residue  $J_{K, \text{res}, 2K}(x)$  can then be expressed as

$$\begin{aligned} C_s &= J_K^{(s)}(0), \\ J_{K, \text{res}, 2K}(x) &= \int_0^x d\tau \frac{(x-\tau)^{2K}}{(2K)!} J_K^{(2K+1)}(\tau). \end{aligned} \quad (\text{I19})$$

## 2. Norm bounds for LCU formula

In Sec. I1 we have derived the explicit form of the LCU formula for the  $K$ th-order Trotter remainder  $V_K(x)$ . Based on Eq. (I15), Eq. (I17), Eq. (I19) and Proposition 10, we are going to prove the 1-norm bound  $\mu_K^{(nc)}(x)$  and error bound  $\varepsilon_K^{(nc)}(x)$  in Proposition 13.

First of all, we need to estimate the norms of  $J_K^{(s)}(x)$ . We have the following results.

**Proposition 16** (Upper bound of the norm of nested commutators). *Consider a lattice Hamiltonian  $H = A + B$  with the form in Eq. (G4). Suppose the spectral norm and 1-norm of its components  $H_{j,j+1}$  are bounded by  $\Lambda$  and  $\Lambda_1$ . Then for the nested commutators appearing in Eq. (I19), we have the following bound*

$$\left\| \prod_{l=j}^{\kappa} e^{-i\tau b_l \text{ad}_B} \text{ad}_B^{m_l} e^{-i\tau a_l \text{ad}_A} \text{ad}_A^{n_l} (c_{j+1}A + d_j B) \right\| \leq \frac{n}{2} 2^s \Lambda^{s+1}. \quad (\text{I20})$$

$$\left( c_{j+1} \prod_{l=j}^{\kappa} (2(l-j) + 2)^{m_l} (2(l-j) + 1)^{n_l} + d_j \prod_{l=j}^{\kappa} (2(l-j) + 3)^{m_l} (2(l-j) + 2)^{n_l} \right)$$

where  $\{m_l, n_l\}_{l=1}^{\kappa}$  are nonnegative integers satisfying  $\sum_{l=j}^{\kappa} (m_l + n_l) = s$ .  $\kappa$  is the stage number determined by the Trotter formula in Eq. (I3).  $\{a_l, b_l\}_{l=1}^{\kappa}$  are defined by the Trotter formula in Eq. (I4).  $\{c_l, d_l\}_{l=1}^{\kappa}$  are defined in Eq. (I13). As a result, we can bound the norm of  $J_K^{(s)}(x)$  defined in Eq. (I17) as follows,

$$\|J_K^{(s)}(x)\| \leq n\kappa(4\kappa + 5)^s 2^s \Lambda^{s+1}. \quad (\text{I21})$$

The 1-norm upper bound for  $J_K^{(s)}(x)$  is to simply replace  $\Lambda$  by  $\Lambda_1$ .

*Proof.* To begin with, we now focus on one Hamiltonian term  $H_{j,j+1}$  in  $A$  and bound the norm

$$\left\| \prod_{l=j}^{\kappa} e^{-i\tau b_l \text{ad}_B} \text{ad}_B^{m_l} e^{-i\tau a_l \text{ad}_A} \text{ad}_A^{n_l} (H_{j,j+1}) \right\| \leq 2^s \Lambda^{s+1} \prod_{l=j}^{\kappa} (2(l-j) + 2)^{m_l} (2(l-j) + 1)^{n_l}. \quad (\text{I22})$$

To this end, we decompose operator to the elementary nested commutators with the form,

$$\begin{aligned} & e^{-i\tau \text{ad}_B} \text{ad}_{H_{j_s, j_s+1}} \dots \text{ad}_{H_{j_s - m_{\kappa+1}, j_s - m_{\kappa+1} + 1}} \\ & \dots \\ & e^{-i\tau \text{ad}_B} \text{ad}_{H_{j_{m_j+n_j}, j_{m_j+n_j}+1}} \dots \text{ad}_{H_{j_{n_j+1}, j_{n_j+1}+1}} \\ & e^{-i\tau \text{ad}_A} \text{ad}_{H_{j_{n_j}, j_{n_j}+1}} \dots \text{ad}_{H_{j_1, j_1+1}} H_{j, j+1}, \end{aligned} \quad (\text{I23})$$

where  $j_1, j_2, \dots, j_s$  are the possible vertex indices. For each elementary nested commutator, the spectral norm can be bounded by

$$(2\Lambda)^s \Lambda. \quad (\text{I24})$$

This can be done by expand all the commutators and apply triangle inequality. Here, we use the property that the spectral norm of all the exponential operator with anti-Hermitian exponent is 1.

Now, we count the number of the possible elementary commutators with the form in Eq. (I23). We will check the action of the adjoint operators from right to left. For the first location, we know that  $\text{ad}_A H_{j,j+1} = 0$ . For simplicity, we keep the term  $\text{ad}_{H_{j,j+1}} H_{j,j+1}$  in the counting of elementary commutators. If the next ad is still  $\text{ad}_A$ , the support will still be on the 2 qubits  $j$  and  $j+1$ . As a result, there will be one possible elementary term  $\text{ad}_{H_{j,j+1}}$  left. Similarly, the exponential operator  $e^{-i\tau \text{ad}_A}$  will not enlarge the support since one can expand it to the power of  $\text{ad}_A$ . The support will be enlarged when  $\text{ad}_B$  comes into play. In this layer, the support of the operator will be expanded to 4 qubits:  $j-1, j, j+1$ , and  $j+2$ . We can decompose  $\text{ad}_B$  to 2 nonzero elementary elements,  $\text{ad}_{H_{j-1,j}}$  and  $\text{ad}_{H_{j+1,j+2}}$ . If the next operator is still  $\text{ad}_B$  or  $e^{-i\text{ad}_B}$ , it will not enlarge the support. Following this logic, we can see that the number of possible elementary commutators is bounded by

$$(2(\kappa - j) + 2)^{m_{\kappa}} (2(\kappa - j) + 1)^{n_{\kappa}} \dots 4^{m_{j+1}} 3^{n_{j+1}} 2^{m_j} 1^{n_j} = \prod_{l=j}^{\kappa} (2(l-j) + 2)^{m_l} (2(l-j) + 1)^{n_l}. \quad (\text{I25})$$

We remark that, the elementary nested commutators with  $n_j \neq 0$  is actually 0. Here, we keep these commutators for the simplicity of counting.

Combining the number of elementary nested commutators and the norm bound for each commutator and applying triangle inequality, we will obtain Eq. (I22).



Similarly, we can check one Hamiltonian term  $H_{j,j+1}$  in  $B$  and bound the norm with

$$\left\| \prod_{l=j}^{\kappa} e^{-i\tau b_l \text{ad}_B} \text{ad}_B^{m_l} e^{-i\tau a_l \text{ad}_A} \text{ad}_A^{n_l} (H_{j,j+1}) \right\| \leq 2^s \Lambda^{s+1} \prod_{l=j}^{\kappa} (2(l-j) + 3)^{m_l} (2(l-j) + 2)^{n_l}. \quad (\text{I26})$$

The counting logic is similar to the case for  $H_{j,j+1}$  in  $A$ . The only difference is that when counting the number of elementary nested commutators, the action of the first  $\text{ad}_A$  will enlarge the operator space to 4 qubits.

Applying Eq. (I22) and Eq. (I26) for all the components  $H_{j,j+1}$  in  $H$ , we will obtain Eq. (I20).

Now, we apply Eq. (I20) to bound the norm of  $J_K^{(s)}(x)$  in Eq. (I17). We have

$$\begin{aligned} \|J_K^{(s)}(x)\| &\leq \sum_{j=\kappa}^1 \sum_{\substack{m_j, n_j, \dots, m_\kappa, n_\kappa \\ \sum_{l=j}^{\kappa} m_l + n_l = s}} \binom{s}{m_j, n_j, \dots, m_\kappa, n_\kappa} \prod_{l=j}^{\kappa} (b_l^{m_l} a_l^{n_l}) \left\| \prod_{l=j}^{\kappa} (e^{-itb_l \text{ad}_B} \text{ad}_B^{m_l} e^{-ita_l \text{ad}_A} \text{ad}_A^{n_l}) (c_{j+1}A + d_j B) \right\| \\ &\leq 2^s \Lambda^{s+1} \frac{n}{2} \sum_{j=\kappa}^1 \sum_{\substack{m_j, n_j, \dots, m_\kappa, n_\kappa \\ \sum_{l=j}^{\kappa} m_l + n_l = s}} \binom{s}{m_j, n_j, \dots, m_\kappa, n_\kappa} \prod_{l=j}^{\kappa} (b_l^{m_l} a_l^{n_l}) \\ &\quad \left( c_{j+1} \prod_{l=j}^{\kappa} (2(l-j) + 2)^{m_l} (2(l-j) + 1)^{n_l} + d_j \prod_{l=j}^{\kappa} (2(l-j) + 3)^{m_l} (2(l-j) + 2)^{n_l} \right) \\ &\leq 2^s \Lambda^{s+1} \frac{n}{2} \sum_{j=\kappa}^1 c_{j+1} \left( \sum_{l=j}^{\kappa} b_l (2(l-j) + 2) + a_l (2(l-j) + 1) \right)^s + d_j \left( \sum_{l=j}^{\kappa} b_l (2(l-j) + 3) + a_l (2(l-j) + 2) \right)^s \\ &\leq 2^s \Lambda^{s+1} \frac{n}{2} \sum_{j=\kappa}^1 c_{j+1} (4(\kappa - j) + 3)^s + d_j (4(\kappa - j) + 5)^s \\ &\leq 2^s \Lambda^{s+1} \frac{n}{2} \sum_{j=\kappa}^1 (4(\kappa - j) + 3)^s + (4(\kappa - j) + 5)^s \\ &\leq 2^s \Lambda^{s+1} \frac{n}{2} \cdot 2\kappa(4\kappa + 5)^s = n\kappa(4\kappa + 5)^s 2^s \Lambda^{s+1}. \end{aligned} \quad (\text{I27})$$

In the third line, we use multinomial theorem. In the fourth line, we use the fact that  $a_l, b_l > 0$  and  $\sum_l a_l, \sum_l b_l \leq 1$ . The fifth line is due to  $0 \leq c_j, d_j < 1$  for all  $j$ . In the sixth line, we use the following bound,

$$\begin{aligned} \sum_{j=1}^{\kappa} (4(\kappa - j) + a)^s &= \sum_{l=0}^{\kappa-1} (4l + a)^s \\ &\leq \int_0^{\kappa} (4x + a)^s dx = \frac{1}{4} \frac{(4\kappa + a)^{s+1} - a^{s+1}}{s+1} \\ &= \kappa \frac{1}{s+1} \sum_{m=0}^s (4\kappa + a)^m a^{s-m} \leq \kappa(4\kappa + a)^s. \end{aligned} \quad (\text{I28})$$

Here,  $a$  is any real number.

Since 1-norm can be estimated based on the same logic by counting the number of nested commutators and the 1-norm of each nest commutator, the derivation for the 1-norm is similar by replacing  $\Lambda$  to  $\Lambda_1$ .  $\square$

Now, we prove the 1-norm bound  $\mu_K^{(nc)}(x)$  of  $\tilde{V}_K(x)$ . From Proposition 10 we have

$$\begin{aligned} \|\tilde{V}_K(x)\|_1 &= \sqrt{1 + \left( \sum_{s=K}^{2K} \|C_s\|_1 \frac{x^{s+1}}{(s+1)!} \right)^2} \\ &\leq 1 + \frac{1}{2} \left( \sum_{s=K}^{2K} \|C_s\|_1 \frac{x^{s+1}}{(s+1)!} \right)^2 \end{aligned}$$

$$\begin{aligned}
&\leq 1 + \frac{1}{2}n^2\kappa^2 \left( \sum_{s=K}^{2K} \beta^s \frac{(\Lambda_1 x)^{s+1}}{(s+1)!} \right)^2 \\
&\leq 1 + \frac{1}{2}n^2\kappa^2 \left( (K+1)\beta^{K+1} \frac{(\Lambda_1 x)^{K+1}}{(K+1)!} \right)^2 \\
&\leq 1 + \frac{n^2\kappa^2\beta^{2(K+1)}}{2(K!)^2} (\Lambda_1 x)^{2K+2} \\
&\leq \exp \left( \frac{n^2\kappa^2\beta^{2(K+1)}}{2(K!)^2} (\Lambda_1 x)^{2K+2} \right).
\end{aligned} \tag{I29}$$

Here, we set  $\beta := 2(4\kappa + 5)$ . In the third line, we use Proposition 16. In the fourth line, we use the assumption that  $\beta\Lambda_1 x \leq (K+2)$ .

Then, we prove the distance bound  $\varepsilon_K^{(nc)}(x) = \|F_{K,res}\|$ . From Proposition 10 we know that we only need to bound  $\|J_{K,L}(\tau)\|$ ,  $\|J_{K,res,2K}(\tau)\|$ , and  $M_K(\tau)$  based on Eq. (G33).

We start from  $\|J_{K,L}(\tau)\|$ . From Proposition 11 we have

$$\begin{aligned}
\|J_{K,L}(\tau)\| &\leq \sum_{s=K}^{2K} \|C_s\| \frac{\tau^s}{s!} \\
&\leq n\kappa \sum_{s=K}^{2K} \beta^s \Lambda^{s+1} \frac{\tau^s}{s!}.
\end{aligned} \tag{I30}$$

Then, we bound  $\|J_{K,res,2K}(\tau)\|$  and  $\|M_K(\tau)\|$ . From Eq. (G33) and Proposition 16 we have

$$\begin{aligned}
\|J_{K,res,2K}(\tau)\| &\leq \int_0^\tau d\tau_1 \frac{(\tau - \tau_1)^{2K}}{(2K)!} \|J_K^{(2K+1)}(\tau_1)\| \\
&\leq n\kappa \frac{(\beta\tau)^{2K+1}}{(2K+1)!} \Lambda^{2K+2}, \\
\|M_K(\tau)\| &\leq \int_0^\tau d\tau_1 \int_0^{\tau_1} d\tau_2 \frac{(\tau_1 - \tau_2)^{(K-1)}}{(K-1)!} \|J_K^{(K)}(\tau_2)\| \\
&\leq n\kappa \frac{\beta^K \tau^{K+1}}{(K+1)!} \Lambda^{K+1}.
\end{aligned} \tag{I31}$$

Based on Eq. (I30), Eq. (I31) and Proposition 10 we have

$$\begin{aligned}
\|F_{K,res}(x)\| &\leq \int_0^\tau (\|M_K(\tau)\| \|J_L(\tau)\| + \|J_{K,res,2K}(\tau)\|) \\
&\leq \int_0^x d\tau (n\kappa)^2 \sum_{s=K}^{2K} \frac{\beta^{s+K} \Lambda^{s+K+2} \tau^{s+K+1}}{(K+1)!s!} + (n\kappa) \frac{\beta^{2K+1} \Lambda^{2K+2} \tau^{2K+1}}{(2K+1)!} \\
&= (n\kappa)^2 \sum_{s=K}^{2K} \frac{\beta^{s+K} (\Lambda x)^{s+K+2}}{(K+1)!s!(s+K+2)} + (n\kappa) \frac{\beta^{2K+1} (\Lambda x)^{2K+2}}{(2K+2)!} \\
&\leq (n\kappa)^2 (K+1) \frac{\beta^{2K} (\Lambda x)^{2K+2}}{(2K+2)K!(K+1)!} + (n\kappa) \frac{\beta^{2K+1} x^{2K+2}}{(2K+2)!} \\
&\leq (n\kappa)^2 \frac{\beta^{2K+1}}{K!(K+1)!} (\Lambda x)^{2K+2}.
\end{aligned} \tag{I32}$$

In the fourth line, we assume  $\beta\Lambda x \leq K+1$ . In the fifth line, we use the fact that  $n\kappa > 1$ .

To summarize, from Eq. (I29) and Eq. (I32), we have proven that,

$$\begin{aligned}
\mu_K^{(nc)} &:= \|V_K(x)\|_1 \leq \exp \left( \frac{n^2\kappa^2\beta^{2(K+1)}}{2(K!)^2} (\Lambda_1 x)^{2K+2} \right), \\
\varepsilon_K^{(nc)} &:= \|\tilde{V}_K(x) - V_K(x)\| = \|F_{K,res}(x)\| \leq (n\kappa)^2 \frac{\beta^{2K+1}}{K!(K+1)!} (\Lambda x)^{2K+2}.
\end{aligned} \tag{I33}$$

Here,  $\beta := 2(4\kappa + 5)$ . We assume that  $\beta x \leq \max\{\frac{K+1}{\Lambda}, \frac{K+2}{\Lambda_1}\}$ . This finishes the proof of Proposition 13.

## Appendix J: Explicit nested-commutator compensation for generic Hamiltonians

In this section, we discuss the LCU constructions for the remainder of the  $K$ th-order Trotter formula of a generic  $L$ -sparse Hamiltonian. We will provide the LCU formulas with nested commutator forms and upper bound the 1-norm  $\mu$  and accuracy  $\varepsilon$  based on some simple commutator-related characteristics.

For the convenience of discussion, we introduce some notations originated from Ref. [14]. A generic  $L$ -sparse Hamiltonian is

$$H = \sum_{l=1}^L H_l. \quad (\text{J1})$$

We first generalize the canonical form of the Trotter formulas in Appendix I1. The  $K$ th-order Trotter formula for the real-time evolution  $U(x) = e^{-ixH}$  can be written as

$$S_K(x) = \prod_{j=1}^{\kappa} \prod_{l=1}^L e^{-ixa_{(j,l)} H_{\pi_j(l)}}. \quad (\text{J2})$$

Here,  $\kappa$  is the stage number defined in Sec. D. We have  $\kappa = 1$  for  $K = 1$  and  $\kappa \leq 2 \cdot 5^{k-1}$  when  $K = 2k$ . The stage length coefficients  $a_{(j,l)}$  are determined based on Eq. (D9) and Eq. (D10). The permutation  $\pi_j$  indicates the ordering of the summands  $\{H_l\}$  within the  $j$ th-stage in the Trotter formula.

To simplify the notation, we introduce the lexicographical order [14] for the pair of tuples  $(j, l)$  in Eq. (J2). For two pairs of tuples  $(j, l)$  and  $(j', l')$ , we have

1.  $(j, l) \succeq (j', l')$  if  $j > j'$ , or if  $j = j'$  and  $l > l'$ .
2.  $(j, l) \succ (j', l')$  if  $(j, l) \succeq (j', l')$  and  $(j, l) \neq (j', l')$ .

We can also define  $(j, l) \preceq (j', l')$  and  $(j, l) \prec (j', l')$  in the same way. We denote the number of different tuples  $(j, l)$  in  $S_K(x)$  as  $\Upsilon$ , which is usually equal to  $\kappa L$ .

Based on the lexicographical order of  $(j, l)$ , we also use a single-letter representation  $\gamma = (j, l)$  when no ambiguity occurs. The value of  $\gamma$  increases from 1 to  $\Upsilon$  based on the ascending order of  $(j, l)$ . In this way, we denote

$$a_\gamma = a_{(j,l)}, \quad H_\gamma = H_{\pi_j(l)}. \quad (\text{J3})$$

We can then express  $S_K(x)$  and  $S_K(x)^\dagger$  in the following way,

$$\begin{aligned} S_K(x) &= \prod_{(j,l)}^{\leftarrow} e^{-ixa_{(j,l)} H_{\pi_j(l)}} = \prod_{\gamma=1}^{\Upsilon} e^{-ixa_\gamma H_\gamma}, \\ S_K(x)^\dagger &= \prod_{(j,l)}^{\rightarrow} e^{ixa_{(j,l)} H_{\pi_j(l)}} = \prod_{\gamma=\Upsilon}^1 e^{-ixa_\gamma H_\gamma}. \end{aligned} \quad (\text{J4})$$

We are going to finish the following tasks,

1. (Sec. J1) Derive the explicit formulas for the leading-order expansion terms  $F_{K,s}^{(nc)}(x)$  with  $s = K+1, \dots, 2K+1$ .
2. (Sec. J2) Prove the 1-norm  $\mu_K^{(nc)}(x)$  and error bound  $\varepsilon_K^{(nc)}(x)$  in Proposition 14.

### 1. Derivation of LCU formula in nested-commutator form

Based on the Trotter formulas in Eq. (J4), we expand  $R_K(x)$  in Eq. (G11) as follows,

$$R_K(x) = i \sum_{\gamma=1}^{\Upsilon} \prod_{\gamma'=\gamma-1}^1 e^{ixa_{\gamma'} H_{\gamma'}} (a_\gamma H_\gamma) \prod_{\gamma'=\Upsilon}^{\gamma+1} e^{ixa_{\gamma'} H_{\gamma'}} - iH \prod_{\gamma'=\Upsilon}^1 e^{ixa_{\gamma'} H_{\gamma'}}, \quad (\text{J5})$$

$J_K(x)$  in Eq. (G14) can then be written as,

$$J_K(x) = i \sum_{\gamma=1}^{\Upsilon} \prod_{\gamma'=\gamma+1}^{\Upsilon} e^{-ix a_{\gamma'} \text{ad}_{H_{\gamma'}}} (a_{\gamma} H_{\gamma}) - i \prod_{\gamma'=1}^{\Upsilon} e^{-ix a_{\gamma'} \text{ad}_{H_{\gamma'}}} H. \quad (\text{J6})$$

The derivative of  $J_K(x)$  is

$$\begin{aligned} J_K^{(s)}(x) &= i \sum_{\gamma=1}^{\Upsilon} \sum_{\substack{m_{\gamma+1} \dots m_{\Upsilon} \\ \sum_{v=\gamma+1}^{\Upsilon} m_v = s}} \binom{s}{m_{\gamma+1}, \dots, m_{\Upsilon}} \left( \prod_{\gamma'=\gamma+1}^{\Upsilon} (-i a_{\gamma'} \text{ad}_{H_{\gamma'}})^{m_{\gamma'}} e^{-ix a_{\gamma'} \text{ad}_{H_{\gamma'}}} \right) (a_{\gamma} H_{\gamma}) \\ &\quad - i \sum_{\substack{m_1 \dots m_{\Upsilon} \\ \sum_{v=1}^{\Upsilon} m_v = s}} \binom{s}{m_1, \dots, m_{\Upsilon}} \left( \prod_{\gamma'=1}^{\Upsilon} (-i a_{\gamma'} \text{ad}_{H_{\gamma'}})^{m_{\gamma'}} e^{-ix a_{\gamma'} \text{ad}_{H_{\gamma'}}} \right) H. \end{aligned} \quad (\text{J7})$$

Using the operator-valued Taylor-series expansion in Eq. (I16), we have

$$\begin{aligned} C_s &= J_K^{(s)}(0) = i \sum_{\gamma=1}^{\Upsilon} \sum_{\substack{m_{\gamma+1} \dots m_{\Upsilon} \\ \sum_{v=\gamma+1}^{\Upsilon} m_v = s}} \binom{s}{m_{\gamma+1}, \dots, m_{\Upsilon}} \left( \prod_{\gamma'=\gamma+1}^{\Upsilon} (-i a_{\gamma'} \text{ad}_{H_{\gamma'}})^{m_{\gamma'}} \right) (a_{\gamma} H_{\gamma}) \\ &\quad - i \sum_{\substack{m_1 \dots m_{\Upsilon} \\ \sum_{v=1}^{\Upsilon} m_v = s}} \binom{s}{m_1, \dots, m_{\Upsilon}} \left( \prod_{\gamma'=1}^{\Upsilon} (-i a_{\gamma'} \text{ad}_{H_{\gamma'}})^{m_{\gamma'}} \right) H \\ &= i \sum_{\gamma=1}^{\Upsilon} \sum_{\substack{(j', l') m_{(j', l')} = s \\ (j', l') \succ (j, l)}} \binom{s}{\{m_{(j', l')}\}} \left( \prod_{(j', l') \succ (j, l)}^{\leftarrow} (-i a_{(j', l')} \text{ad}_{H_{\pi_{j'}(l')}})^{m_{(j', l')}} \right) (a_{(j, l)} H_{\pi_j(l)}) \\ &\quad - i \sum_{\sum_{(j', l') \succ (j, l)} m_{(j', l')} = s} \binom{s}{\{m_{(j', l')}\}} \left( \prod_{(j', l') \succ (j, l)}^{\leftarrow} (-i a_{(j', l')} \text{ad}_{H_{\pi_{j'}(l')}})^{m_{(j', l')}} \right) H \end{aligned} \quad (\text{J8})$$

which is the nested-commutator form. If we define

$$A_{(j, l)} = A_{\gamma} = -i a_{\gamma} H_{\gamma} = -i a_{(j, l)} H_{\pi_j(l)}, \quad (\text{J9})$$

we can simplify Eq. (J8) as

$$C_s = - \sum_{\gamma=1}^{\Upsilon} \sum_{\substack{m_{\gamma+1} \dots m_{\Upsilon} \\ \sum_{v=\gamma+1}^{\Upsilon} m_v = s}} \binom{s}{m_{\gamma+1}, \dots, m_{\Upsilon}} \prod_{\gamma'=\gamma+1}^{\Upsilon} \text{ad}_{A_{\gamma'}}^{m_{\gamma'}} A_{\gamma} + \sum_{\substack{m_1 \dots m_{\Upsilon} \\ \sum_{v=1}^{\Upsilon} m_v = s}} \binom{s}{m_1, \dots, m_{\Upsilon}} \prod_{\gamma'=1}^{\Upsilon} \text{ad}_{A_{\gamma'}}^{m_{\gamma'}} (-i H), \quad (\text{J10})$$

which is the summation of nested commutators.

## 2. Norm bounds for LCU formula

Now, we are going to bound the 1-norm  $\mu_K^{(nc)}(x)$  and distance  $\varepsilon_K^{(nc)}(x)$  of the truncated LCU formula  $\tilde{V}_K^{(nc)}(x)$  in Eq. (G29) for a general Hamiltonian. We introduce the following nested commutator norms used in Ref. [14] to simplify the notation,

$$\begin{aligned} \alpha_{com}^{(s)}(A_r, \dots, A_1; B) &:= \sum_{m_1 + \dots + m_r = s} \binom{s}{m_1, \dots, m_r} \|\text{ad}_{A_r}^{m_r} \dots \text{ad}_{A_1}^{m_1} B\|, \\ \alpha_{com,1}^{(s)}(A_r, \dots, A_1; B) &:= \sum_{m_1 + \dots + m_r = s} \binom{s}{m_1, \dots, m_r} \|\text{ad}_{A_r}^{m_r} \dots \text{ad}_{A_1}^{m_1} B\|_1. \end{aligned} \quad (\text{J11})$$

Then, from Eq. (J10) we can bound the 1-norm and spectral norm of  $C_s$  by

$$\begin{aligned}\|C_s\| &\leq \sum_{\gamma=1}^{\Upsilon} \alpha_{com}^{(s)}(A_{\Upsilon}, \dots, A_{\gamma+1}; A_{\gamma}) + \alpha_{com}^{(s)}(A_{\Upsilon}, \dots, A_1; H), \\ \|C_s\|_1 &\leq \sum_{\gamma=1}^{\Upsilon} \alpha_{com,1}^{(s)}(A_{\Upsilon}, \dots, A_{\gamma+1}; A_{\gamma}) + \alpha_{com,1}^{(s)}(A_{\Upsilon}, \dots, A_1; H).\end{aligned}\tag{J12}$$

Now, we are going to bound  $\|J_K(x)\|$  and  $\|J_{K,res,2K}(x)\|$ . We will use the following Lemma in the derivation.

**Lemma 5** (Thm 5 in [14]). *Let  $A_1, A_2, \dots, A_r$  and  $B$  be operators. Then, the conjugation has the expansion,*

$$e^{\tau \text{ad}_{A_r}} \dots e^{\tau \text{ad}_{A_2}} e^{\tau \text{ad}_{A_1}} B = G_0 + G_1 \tau + \dots + G_{s-1} \frac{\tau^{s-1}}{(s-1)!} + G_{res,s}(\tau).\tag{J13}$$

Here,  $G_0, G_1, \dots, G_{s-1}$  are operators independent of  $\tau$ . The operator-valued function  $G_{res,s}(\tau)$  is given by

$$G_{res,s}(\tau) := \sum_{\gamma=1}^r \sum_{\substack{m_1 + \dots + m_{\gamma} = s \\ m_{\gamma} \neq 0}} e^{\tau \text{ad}_{A_r}} \dots e^{\tau \text{ad}_{A_{\gamma+1}}} \int_0^{\tau} d\tau_2 \frac{(\tau - \tau_2)^{m_{\gamma}-1} \tau^{m_1 + \dots + m_{\gamma-1}}}{(m_{\gamma}-1)! m_{\gamma-1}! \dots m_1!} e^{\tau_2 \text{ad}_{A_{\gamma}}} \text{ad}_{A_{\gamma}}^{m_{\gamma}} \dots \text{ad}_{A_1}^{m_1} B.\tag{J14}$$

Furthermore, we have the spectral-norm bound,

$$\|G_{res,s}(\tau)\| \leq \alpha_{com}^{(s)}(A_r, \dots, A_1; B) \frac{|\tau|^s}{s!} e^{2|\tau| \sum_{\gamma=1}^r \|A_{\gamma}\|},\tag{J15}$$

for general operators and

$$\|G_{res,s}(\tau)\| \leq \alpha_{com}^{(s)}(A_r, \dots, A_1; B) \frac{|\tau|^s}{s!},\tag{J16}$$

when  $A_1, \dots, A_r$  are anti-Hermitian.  $\alpha_{com}^{(s)}(A_r, \dots, A_1; B)$  is defined in Eq. (J11).

From Eq. (J6) and using Lemma 5 we have

$$\begin{aligned}J_K(x) &= - \sum_{\gamma=1}^{\Upsilon} \prod_{\gamma'=\gamma+1}^{\Upsilon} e^{\text{ad}_{A_{\gamma'}}} (A_{\gamma}) + \prod_{\gamma'=1}^{\Upsilon} e^{\text{ad}_{A_{\gamma'}}} (-iH) \\ &= \sum_{\gamma=1}^{\Upsilon} G_{res,K}^{(\gamma)}(x) + G_{res,K}^{(0)}(x),\end{aligned}\tag{J17}$$

in the second line, we use Lemma 5 to expand all the conjugate matrix exponentials to the following form,

$$\begin{aligned}\prod_{\gamma'=\gamma+1}^{\Upsilon} e^{\text{ad}_{A_{\gamma'}}} (A_{\gamma}) &= G_0^{(\gamma)} + G_1^{(\gamma)} x + \dots + G_{K-1}^{(\gamma)} \frac{x^{K-1}}{(K-1)!} + G_{res,K}^{(\gamma)}, \quad \gamma = 1, 2, \dots, \Upsilon, \\ \prod_{\gamma'=1}^{\Upsilon} e^{\text{ad}_{A_{\gamma'}}} (-iH) &= G_0^{(0)} + G_1^{(0)} x + \dots + G_{K-1}^{(0)} \frac{x^{K-1}}{(K-1)!} + G_{res,K}^{(0)}.\end{aligned}\tag{J18}$$

The low-order terms  $G_s^{(\gamma)}$  with  $s = 0, 1, \dots, K-1$  in Eq. (J17) cancel out due to the order condition in Proposition 9.

Therefore, we have

$$\begin{aligned}
\|J_K(x)\| &\leq \sum_{\gamma=1}^{\Upsilon} \|G_{res,K}^{(\gamma)}(x)\| + \|G_{res,K}^{(0)}(x)\| \\
&\leq \frac{x^K}{K!} \left( \sum_{\gamma=1}^{\Upsilon} \alpha_{com}^{(K)}(A_{\Upsilon}, \dots, A_{\gamma+1}; A_{\gamma}) + \alpha_{com}^{(K)}(A_{\Upsilon}, \dots, A_1; H) \right) \\
&\leq 2 \frac{x^K}{K!} \sum_{\gamma=1}^{\Upsilon} \alpha_{com}^{(K)}(A_{\Upsilon}, \dots, A_1; H_{\gamma}) = 2 \frac{x^K}{K!} \sum_{(j,l)} \alpha_{com}^{(K)}(\overleftarrow{A_{(j',l')}}; H_{\pi_j(l)}) \\
&= 2\kappa \frac{x^K}{K!} \sum_{l=1}^L \alpha_{com}^{(K)}(\overleftarrow{a_{(j',l')} H_{\pi_{j'}(l')}}; H_l) \\
&\leq 2\kappa \frac{x^K}{K!} \sum_{l=1}^L \alpha_{com}^{(K)}(\overleftarrow{H_{\pi_{j'}(l')}}; H_l) =: 2\kappa \frac{x^K}{K!} \alpha_H^{(K)}.
\end{aligned} \tag{J19}$$

Here, we define

$$\begin{aligned}
\alpha_H^{(K)} &:= \sum_{l=1}^L \alpha_{com}^{(K)}(\overleftarrow{H_{\pi_{j'}(l')}}; H_l), \\
\alpha_{H,1}^{(K)} &:= \sum_{l=1}^L \alpha_{com,1}^{(K)}(\overleftarrow{H_{\pi_{j'}(l')}}; H_l).
\end{aligned} \tag{J20}$$

Following the same way, we can bound  $\|C_s\|$  and  $\|C_s\|_1$  in Eq. (J12) as

$$\begin{aligned}
\|C_s\| &\leq 2\kappa \alpha_H^{(s)}, \\
\|C_s\|_1 &\leq 2\kappa \alpha_{H,1}^{(s)}.
\end{aligned} \tag{J21}$$

Now, we are going to bound  $\|J_{K,res,2K}(x)\|$ . Similar to Eq. (J17), we expand all the conjugate matrix exponentials to  $2K$ th-order,

$$\begin{aligned}
J_K(x) &= \sum_{\gamma=1}^{\Upsilon} \prod_{\gamma'=\gamma+1}^{\Upsilon} e^{\text{ad}_{A_{\gamma'}}}(A_{\gamma}) + \prod_{\gamma'=1}^{\Upsilon} e^{\text{ad}_{A_{\gamma'}}}(-iH) \\
&= \sum_{s=K}^{2K} C_s \frac{x^s}{s!} + \sum_{\gamma=1}^{\Upsilon} G_{res,2K+1}^{(\gamma)}(x) + G_{res,2K+1}^{(0)}(x),
\end{aligned} \tag{J22}$$

in the second line, we use the expansion of  $J_K(x)$  in Eq. (G23). Based on Eq. (J19) we then have

$$\begin{aligned}
J_{K,res,2K}(x) &= \sum_{\gamma=1}^{\Upsilon} G_{res,2K+1}^{(\gamma)}(x) + G_{res,2K+1}^{(0)}(x) \\
\Rightarrow \|J_{K,res,2K}(x)\| &\leq \sum_{\gamma=1}^{\Upsilon} \|G_{res,2K+1}^{(\gamma)}(x)\| + \|G_{res,2K+1}^{(0)}(x)\| \\
&\leq 2\kappa \frac{x^{2K+1}}{(2K+1)!} \alpha_H^{(2K+1)}.
\end{aligned} \tag{J23}$$

We omit the derivation to the second line since it is the same as the one in Eq. (J19).

Then we can bound  $\|M_K(x)\|$  by

$$\begin{aligned}
\|M_K(x)\| &\leq \int_0^x d\tau \|J_K(\tau)\| \\
&\leq 2\kappa \frac{x^{K+1}}{(K+1)!} \alpha_H^{(K)}.
\end{aligned} \tag{J24}$$

Finally, by applying Proposition 10 and using Eq. (J21), we can bound the 1-norm  $\mu_K^{(nc)}(x)$  as follows,

$$\mu_K^{(nc)}(x) \leq \sqrt{1 + 4\kappa^2 \left( \sum_{s=K}^{2K} \alpha_{H,1}^{(s)} \frac{x^{s+1}}{(s+1)!} \right)^2}, \quad (\text{J25})$$

while the accuracy  $\varepsilon_K^{(nc)}(x)$  can be bounded using Eq. (J12), Eq. (J23), and Eq. (J24),

$$\begin{aligned} \varepsilon_K^{(nc)}(x) &= \|F_{K,res}(x)\| \leq \int_0^x d\tau (\|M_K(\tau)\| \|J_L(\tau)\| + \|J_{K,res,2K}(\tau)\|) \\ &\leq \int_0^x d\tau \left( 4\kappa^2 \frac{\tau^{K+1}}{(K+1)!} \alpha_H^{(K)} \sum_{s=K}^{2K} \alpha_H^{(s)} \frac{\tau^s}{s!} + 2\kappa \frac{\tau^{2K+1}}{(2K+1)!} \alpha_H^{(2K+1)} \right) \\ &\leq 4\kappa^2 \alpha_H^{(K)} \sum_{s=K}^{2K} \alpha_H^{(s)} \frac{x^{s+K+2}}{s!(K+1)!(s+K+2)} + 2\kappa \frac{x^{2K+2}}{(2K+2)!} \alpha_H^{(2K+1)}. \end{aligned} \quad (\text{J26})$$

### Appendix K: Some useful formulas in the proof

**Lemma 6** (Hoeffding bound). *For  $n$  independent random variables  $\{\hat{X}_i\}_{i=1}^n$  which are bounded by  $[a, b]$ , the average value*

$$\bar{X} := \frac{1}{n} \sum_{i=1}^n \hat{X}_i, \quad (\text{K1})$$

satisfies

$$\Pr(|\bar{X} - \mathbb{E}(\bar{X})| \geq \varepsilon) \leq 2 \exp\left(-\frac{2n\varepsilon^2}{(b-a)^2}\right). \quad (\text{K2})$$

**Lemma 7** (Tail bound for the Poisson distribution (Theorem 1 in [38])). *Suppose  $\hat{X}$  is a random variable with Poisson distribution so that  $\Pr(\hat{X} = s) = \text{Poi}(s; x) = e^{-x} \frac{x^s}{s!}$ , where  $x > 0$  is the expectation value. Then, for any  $\varepsilon > 0$ , we have,*

$$\Pr(\hat{X} \geq x + \varepsilon) \leq e^{-\frac{\varepsilon^2}{2x} h(\frac{\varepsilon}{x})}, \quad (\text{K3})$$

and, for any  $0 < \varepsilon < x$ ,

$$\Pr(\hat{X} \leq x - \varepsilon) \leq e^{-\frac{\varepsilon^2}{2x} h(-\frac{\varepsilon}{x})}. \quad (\text{K4})$$

Here,  $h(u) := 2 \frac{(1+u) \ln(1+u) - u}{u^2}$  for  $u \geq -1$ .

From Lemma 7 we have the following corollaries.

**Corollary 2.** *For  $x > 0$  and positive integer  $k$  such that  $x < k + 1$ , we have*

$$\sum_{s=k+1}^{\infty} \frac{x^s}{s!} \leq \left( \frac{ex}{k+1} \right)^{k+1}. \quad (\text{K5})$$

*Proof.* We set  $\varepsilon = (k+1) - x$ . From Lemma 7 we have

$$\begin{aligned} \Pr(\hat{X} \geq k+1) &\leq \exp\left(-\frac{(k+1-x)^2}{2x} h\left(\frac{k+1-x}{x}\right)\right) \\ &= e^{-x} \left( \frac{ex}{k+1} \right)^{k+1}. \end{aligned} \quad (\text{K6})$$

Therefore,

$$\begin{aligned} \Pr(\hat{X} \geq k+1) &= e^{-x} \sum_{s=k+1}^{\infty} \frac{x^s}{s!} \leq e^{-x} \left( \frac{ex}{k+1} \right)^{k+1} \\ \Rightarrow \sum_{s=k+1}^{\infty} \frac{x^s}{s!} &\leq \left( \frac{ex}{k+1} \right)^{k+1}. \end{aligned} \quad (\text{K7})$$

□

**Corollary 3.** For  $x > 0$  and positive integer  $k$  such that  $x < k+1$ , we have

$$e^x - \sum_{s=1}^k \frac{x^s}{s!} \leq e^{ex^{k+1}}. \quad (\text{K8})$$

*Proof.* When  $x < k+1$ , from Corollary 2 we have

$$\begin{aligned} e^{-x} \sum_{s=k+1}^{\infty} \frac{x^s}{s!} &\leq e^{-x} \left( \frac{ex}{k+1} \right)^{k+1} \\ \Rightarrow 1 - e^{-x} - e^{-x} \sum_{s=1}^k \frac{x^s}{s!} &\leq e^{-x} \left( \frac{ex}{k+1} \right)^{k+1} \\ \Rightarrow e^x - \sum_{s=1}^k \frac{x^s}{s!} &\leq 1 + \left( \frac{ex}{k+1} \right)^{k+1} \leq 1 + \frac{(ex)^{k+1}}{(k+1)!} \leq e^{ex^{k+1}}. \end{aligned} \quad (\text{K9})$$

□

**Lemma 8** (Proposition 9 in [23]). For any  $\beta > 0$ ,  $1 > \epsilon > 0$ , we have

$$\left( \frac{e\beta}{s} \right)^s \leq \epsilon, \quad (\text{K10})$$

for all

$$s \geq f(\beta, \epsilon) := \frac{\ln(\frac{1}{\epsilon})}{W_0\left(\frac{1}{e\beta} \ln(\frac{1}{\epsilon})\right)}. \quad (\text{K11})$$

Here,  $W_0(y)$  is the principle branch of the Lambert  $W$ -function.

**Lemma 9** (Theorem 2.7 in [39]). When  $y \geq e$  we have

$$\ln(y) - \ln \ln(y) + \frac{1}{2} \frac{\ln \ln(y)}{\ln(y)} \leq W_0(y) \leq \ln(y) - \ln \ln(y) + \frac{e}{e-1} \frac{\ln \ln(y)}{\ln(y)}. \quad (\text{K12})$$

**Proposition 17** (Summation of two poisson variables). For an integer  $r \geq 0$  we have

$$\sum_{s_1, s_2=0}^r \mathbb{1}[s_1 + s_2 = r] \frac{(x_1)^{s_1}}{s_1!} \frac{(x_2)^{s_2}}{s_2!} = \frac{(x_1 + x_2)^r}{r!}. \quad (\text{K13})$$

*Proof.* We have

$$\begin{aligned} \sum_{s_1, s_2=0}^r \mathbb{1}[s_1 + s_2 = r] \frac{(x_1)^{s_1}}{s_1!} \frac{(x_2)^{s_2}}{s_2!} &= \sum_{s=0}^r \frac{(x_1)^s}{s!} \frac{(x_2)^{(r-s)}}{(r-s)!} \\ &= \frac{1}{r!} \sum_{s=0}^r \binom{r}{s} (x_1)^s (x_2)^{r-s} \\ &= \frac{(x_1 + x_2)^r}{r!}, \end{aligned} \quad (\text{K14})$$

where the third line is based on the inverse binomial expansion formula. □



**Corollary 4** (Summation of multiple poisson variables). *For integers  $m \geq 2, r \geq 0$  we have,*

$$\sum_{s_1, s_2, \dots, s_m=0}^r \mathbb{1}[s_1 + s_2 + \dots + s_m = r] \frac{(x_1)^{s_1}}{s_1!} \frac{(x_2)^{s_2}}{s_2!} \dots \frac{(x_m)^{s_m}}{s_m!} = \frac{(x_1 + x_2 + \dots + x_m)^r}{r!}. \quad (\text{K15})$$

Corollary 4 can be inductively proven starting from Proposition 17.

## Appendix L: Additional numerical results

In this section, we provide more numerical results by comparing the gate costs of Trotter-LCU algorithms with other typical algorithms, especially the Trotter algorithm and “post-Trotter” algorithm with best performance, i.e., the 4th-order Trotter algorithm and the quantum signal processing (QSP) algorithm. We will mainly consider two different scenarios — generic  $L$ -sparse Hamiltonians and lattice Hamiltonians. In the former case, the previously known best result is given by the QSP algorithm [19]; in the latter case, since we can take advantage of the spacial locality and commutator information, the 4th-order Trotter algorithm is known to have the best performance [13, 32].

For the Trotter algorithms and Trotter-LCU algorithms, we first compile the circuit to CNOT gates, single-qubit Clifford gates and non-Clifford  $Z$ -axis rotation gate  $R_z(\theta) = e^{i\theta Z}$ . On the other hand, the circuit compilation for the QSP algorithm is more complicated: we need to decompose the state preparation oracles and the select- $H$  gates. We follow the qROM design in Ref. [40] based on a saw-tooth structure. The detailed gate resource analysis can be found in a companion work [41]. Based on the qROM design, we decompose all the state preparation oracles and the select- $H$  gates to Toffoli gates, which can be further decomposed to CNOT gates, single-qubit Clifford gates and  $T$  gates.

For a fair comparison between the gate costs of Trotter, Trotter-LCU and QSP algorithms, we need to further compile the  $Z$ -axis rotation gate  $R_z(\theta)$  to  $T$  gate. We follow the gate compilation work in Ref. [42], where the expected  $T$ -gate number to compile  $R_z(\theta)$  with random  $\theta$  is about

$$c_T = 1.149 \log_2(1/\epsilon) + 9.2, \quad (\text{L1})$$

where  $\epsilon$  is the compilation accuracy. We set the accuracy  $\epsilon = 10^{-15}$  in the later resource estimation. In this case,  $c_T \approx 66$ .

### 1. Generic $L$ -sparse Hamiltonians

For the generic  $L$ -sparse Hamiltonian, we choose the 2-local Hamiltonian

$$H = \sum_{i,j} J_{ij} X_i X_j + \sum_i Z_i, \quad (\text{L2})$$

with  $J_{ij} = 1$  as an example, in which case we ignore the commutator information between different Hamiltonian summands. This simple model works as a representative of many generic Hamiltonians where the commutator information is not helpful or too complicated to count on, e.g., quantum chemistry Hamiltonian for the molecules. Without the commutator information, the former best Hamiltonian simulation algorithm is QSP [19].

In Fig. 11 and Fig. 12, we estimate and compare the CNOT and  $T$  gate counts for the PTSc algorithms, QSP and 4th-order Trotter algorithm with respect to the evolution time. We choose 4th-order Trotter algorithm with random permutation since it performs the best over all the Trotter algorithms. The gate counting method for 4th-order Trotter with random permutation is based on the analytical bounds in Ref. [12]. For the QSP algorithm, we estimate the gate count based on the QROM construction in Ref. [40]. Only the high accuracy results  $\epsilon = 10^{-5}$  for our method and quantum signal processing are presented since our method and quantum signal processing has a logarithmic dependence and hence are less prone to the accuracy while the Trotter formulae has polynomial dependence on the accuracy.

From Fig. 11 and Fig. 12 we can see that, the PTSc algorithm owns a lower CNOT gate cost than the QSP algorithm because it does not need the qROM for classical data loading. On the other hand, the PTSc algorithms have a larger  $T$ -gate cost than QSP algorithm. This is mainly due to the compilation cost of arbitrary  $Z$ -axis rotation gate  $R_z(\theta)$  to  $T$  gates: for each  $R_z(\theta)$  gate with a random phase  $\theta$ , we need  $c_T = 66$   $T$  gates on average to compile it to the accuracy of  $\epsilon = 10^{-15}$ . In the Trotter or Trotter-LCU algorithms, the non-Clifford gate cost mainly originates from the  $R_z(\theta)$  gates: in each segment, there are roughly  $\kappa_K L$   $R_z(\theta)$  gates, leading to about  $\kappa_K c_T L$  compiled  $T$  gates. As

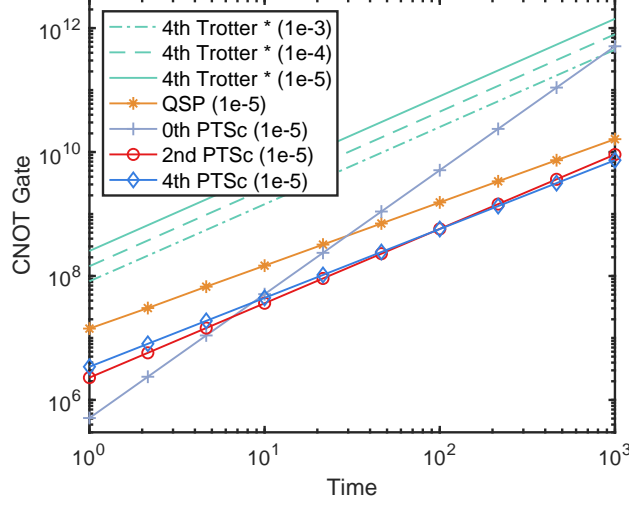

FIG. 11. CNOT gate number estimation for simulating the generic  $L$ -sparse Hamiltonian with an increasing time. The system size is set as  $n = 20$ . The simulation is exemplified with the 2-local Hamiltonian in Eq. (L2).

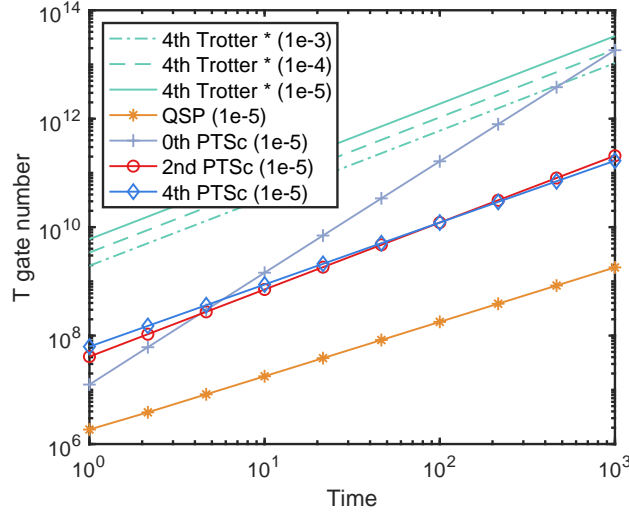

FIG. 12. T gate number estimation for simulating the generic  $L$ -sparse Hamiltonian with an increasing time. The system size is set as  $n = 20$ . The simulation is exemplified with the 2-local Hamiltonian in Eq. (L2).

a comparison, there are only few  $R_z(\theta)$  gates in QSP algorithm used for the phase iteration procedure to realize the Jacobi-Anger polynomials. The major non-Clifford gate cost lies in the compilation of state-preparation oracles and the select- $H$  gates, each of which can be realized by about  $4L$   $T$  gates based on the qROM design in Ref. [40].

In Fig. 13 we compare the qubit number required to implement the QSP and the PTSc algorithms, based on the 2-local Hamiltonian model. We can see a clear advantage of the spacial resource cost of PTSc to QSP algorithm.

## 2. Lattice Hamiltonians

Now, we consider the case of lattice Hamiltonians. We consider the Heisenberg model,  $H = J \sum_i \vec{\sigma}_i \vec{\sigma}_{i+1} + h \sum_i Z_i$ , where  $\vec{\sigma}_i := (X_i, Y_i, Z_i)$  is the vector of Pauli operators on the  $i$ th qubit and  $J = h = 1$ .

We compare the CNOT and  $T$  gate number of the 2nd-order NCc algorithm, QSP and 4th-order Trotter algorithm in Fig. 14 and Fig. 15, respectively. The 4th-order Trotter error analysis is based on the nested commutator bound (Proposition M.1 in Ref. [14]), which is currently the tightest Trotter error bound. The performance of our 2nd-order

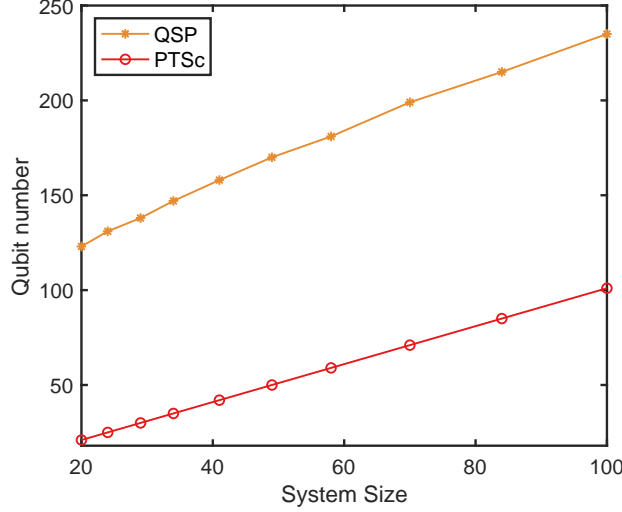

FIG. 13. Qubit number required for simulating the generic  $L$ -sparse Hamiltonian with an increasing system size. The simulation is exemplified with the 2-local Hamiltonian in Eq. (L2).

NCc algorithm is analyzed based on the detailed analysis in Appendix H. We explicitly calculate the 1-norm of the LCU formula and use the analytical bound for the accuracy analysis. Here, we do not introduce the empirical analysis for a fair comparison. Since the explicit evaluation of our 4th-order NCc algorithm is complicated, we mainly present the results for our 2nd-order algorithm.

As addressed in [13, 14], 4th-order Trotter formula shows a near-optimal scaling with respect to the system size for the lattice model, which is clearly shown in Fig. 14. From Fig. 14 we can see that, our 2nd-order NCc algorithm shows an advantage over the 4th-order Trotter algorithm. Furthermore, the  $n$  and  $t$  scaling of our 2nd-order NCc algorithm is similar to the 4th-order Trotter algorithm, which is near optimal.

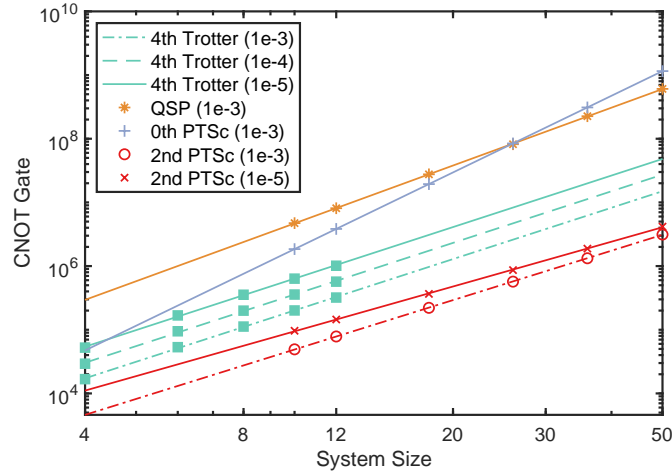

FIG. 14. CNOT gate number estimation for simulating the Heisenberg Hamiltonian using the nested commutator bound with an increasing system size  $n$ . The simulation time is set as  $t = n$ . The 4th-order Trotter formula uses the nested commutator bound shown in Proposition M.1 in [14]. Our result is based on 2nd-order NCc algorithm with the analysis in Appendix H.

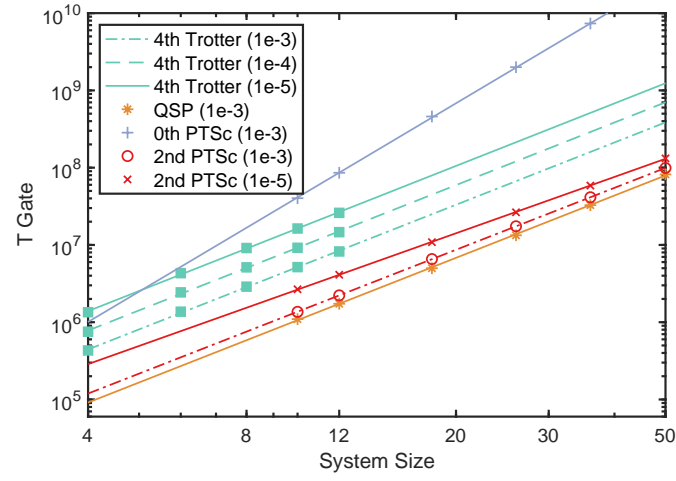

FIG. 15. T gate number estimation for simulating the Heisenberg Hamiltonian using the nested commutator bound with an increasing system size  $n$ . The stage is set up the same as that in Fig. 14.