

Characterization of single shallow silicon-vacancy centers in 4H-SiC

Harpreet Singh^{1,2}, Mario Alex Hollberg¹, Misagh Ghezellou³, Jawad Ul-Hassan³, Florian Kaiser⁴ and Dieter Suter¹

¹Fakultät Physik, Technische Universität Dortmund, Dortmund, Germany. ²Department of Chemistry, University of California, Berkeley, Berkeley, CA 94720, USA. ³Department of Physics, Chemistry and Biology, Linköping University, Linköping, Sweden. ⁴3rd Institute of Physics and Research Center SCOPE, University of Stuttgart, Stuttgart, Germany.

Shallow negatively charged silicon-vacancy centers have applications in magnetic quantum sensing and other quantum applications. Vacancy centers near the surface (within 100 nm) have different spin relaxation rates and optical spin polarization, affecting the optically detected magnetic resonance (ODMR) signal. This makes it essential to characterize these centers. Here we present the relevant spin properties of such centers. ODMR with a contrast of up to 6 %, which is better than the state of the art, allowed us to determine the zero field splitting, which is relevant for most sensing applications. We also present intensity-correlation data to verify that the signal originates from a single center and to extract transition rates between different electronic states.

I. INTRODUCTION

Silicon vacancies in silicon carbide (SiC) are excellent candidates for quantum sensing and information applications [1–4]. Negatively charged silicon vacancies (V_{Si}^-) have spin 3/2 [5, 6]. The spin of V_{Si}^- can be initialized into a particular spin groundstate by optical pumping [4, 5, 7] and it has sufficiently long coherence and relaxation times for many interesting applications [2, 3, 8–12]. Debye-Waller factors of about 6% were found for V_1 and V_2 type of V_{Si}^- [13, 14], which is vital for the quantum application that rely on indistinguishable photon emitters. The electronically excited state zero-field splitting of the V_2 centers in 4H -SiC exhibits a significant thermal shift, which makes them useful for thermometry applications [15]. V_{Si}^- in SiC provides a low-cost and simple approach to quantum sensing of magnetic fields and a sensitivity of 50 nT/ $\sqrt{\text{Hz}}$, which was achieved without complex photonic engineering, control protocols, or applying excitation (optical and radio-frequency) powers greater than a watt [16]. Absolute dc magnetometry, which is immune to thermal noise and strain inhomogeneity has been demonstrated using all four ground-state spin levels of V_{Si}^- [17]. Similar to NV in diamond, V_{Si}^- based magnetometers can also be applied to unique magnetic sensing challenges, such as resolving an individual nuclear spin in a molecule [18]. Since the magnetic field of a dipole decreases with distance as $1/r^3$, it is essential that the sensor can be brought close to the source [18], which is only possible if the V_{Si}^- is close to the surface.

Silicon vacancies can be created, e.g., by irradiating the sample with neutrons or electrons [19–21]. The charge on the silicon-vacancy depends on the Fermi-level: it is at least 1.24 eV above the valence band, the k lattice site becomes negatively charged and at 1.5 eV also the h lattice site [22]. Irradiation by proton or other charged ions allow one to create a plane of vacancies at a specific depth that depends upon the energy and type of the ions [23–25]. Here we focus on single silicon vacancy centers created with 6 keV He⁺ ion irradiation. Using a lithographic polymethyl methacrylate (PMMA) mask

with 100 nm holes, an array of silicon vacancies was created [23] at a depth of 30-40 nm below the surface. Additional details of the sample preparation are given in Appendix A.

In this work, we focus on the V_{Si}^- in the 4H-SiC polytype, specifically V_{Si}^- centers at hexagonal sites h and cubic sites k , which are commonly known as V_1 and V_2 [26]. We characterize the properties of several individual centers and obtain useful values for the optical transitions rates as well as for the radiation-less population dynamics. We demonstrate that the optical pumping results in spin polarization that is sufficiently high to observe optically detected magnetic resonance (ODMR) spectra of single silicon vacancy centers at room temperature with high contrast. From a series of ODMR spectra with different RF powers, we could extract the transverse dephasing time T_2^* .

This paper is organized as follows. Section II introduces the optical and magnetic properties of a single spin system. Section III provides details of correlation measurement experiments and analysis to estimate the rates involved in the population dynamics of the center during optical excitation. Section IV shows continuous-wave optically detected magnetic resonance (cw-ODMR) experiments at different RF powers. Finally, Sec.V contains a brief discussion and some concluding remarks.

II. SYSTEM AND SETUP

The V_2 center has C_{3v} symmetry and an electron spin $S = 3/2$. In the absence of a magnetic field, the spin Hamiltonian is

$$\mathcal{H} = D(S_z^2 - \frac{S(S+1)}{3}), \quad (1)$$

where the zero field splitting (ZFS) in the electronic ground state is $2D = 70$ MHz in frequency units ($\hbar = 1$) [3, 27]. $\vec{S} = \{S_x, S_y, S_z\}$ is the vector of spin opera-

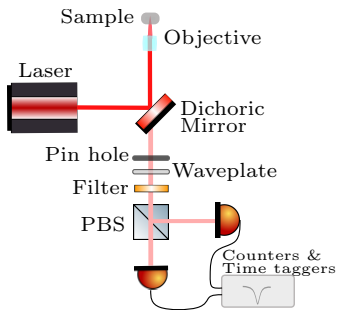

FIG. 1. (a) Experimental confocal setup used for PL and intensity autocorrelation measurements.

tors and we have chosen the z -axis parallel to the c -axis of the crystal (C_3 symmetry axis).

Figure 1 shows the experimental confocal setup for measuring photoluminescence (PL) and the second-order intensity autocorrelation. A 785 nm laser beam was focused on the sample with an objective lens of numerical aperture (NA) 1.3. With the help of a dichroic mirror, the PL emitted by the sample was filtered and allowed to pass through a $\lambda/2$ waveplate, a set of optical filters and a polarizing beam splitter (PBS). Two single-photon detectors (SPD) were used for the two possible paths. With the $\lambda/2$ waveplate, we controlled the ratio of photons detected by these two detectors. From the arrival time of the photons, we calculated the intensity autocorrelation function $g^{(2)}$. For taking PL scans, the counts of both SPDs were added and plotted against the XY position. For simplicity, some of the mirrors and lenses are not shown in Fig. 8, details are summarised in appendix A.

Figure 2 shows a confocal PL scan of a part of the sample. The plot shows that most V_{Si}^- centers lead to a photon detection rate of ~ 8000 cps (counts/s) at room temperature. Higher count rates are also observed in some locations, indicating multiple close centers. The counts due to impurities and dirt are higher than the counts of the vacancies and usually bleach away after a few minutes of laser illumination.

III. POPULATION DYNAMICS

We measured the second-order correlation function of the PL light emitted by a V_{Si}^- . This allowed us to verify that the light is emitted by a single center as well as to study the population dynamics. The second order correlation function

$$g^{(2)}(\tau) = \frac{\langle n_1(t)n_2(t+\tau) \rangle}{\langle n_1(t) \rangle \langle n_2(t+\tau) \rangle}$$

is the conditional probability of measuring two photons with a delay τ . Here, $n_i(t)$ are the number of photons detected at time t [28]. For an ideal single photon emitter the conditional probability of detecting two photons

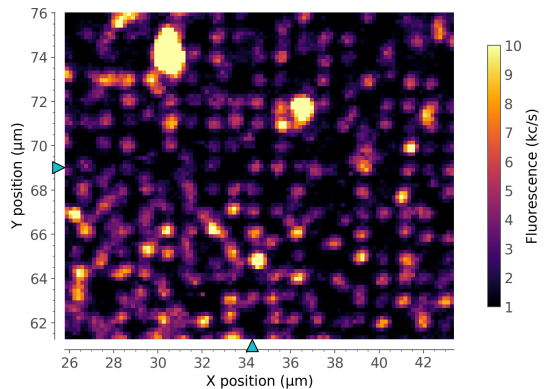

FIG. 2. Confocal scan of the defect center array in the XY plane. Large count rates are due to dirt and impurities. The count rate is color-coded, and its value can be taken from the bar on the right.

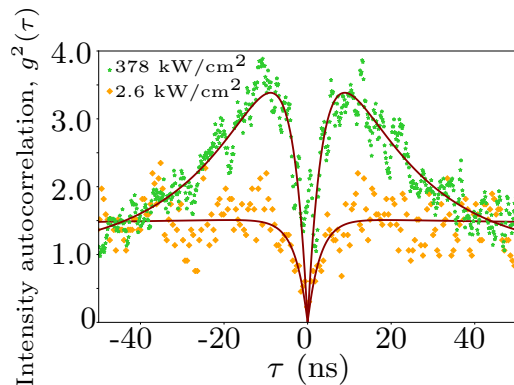

FIG. 3. Intensity autocorrelation measurements performed with 2.6 kW/cm^2 and 378 kW/cm^2 laser intensity in the focus. In the data recorded with intensity $I = 2.6 \text{ kW/cm}^2$, the background count rate was negligible, but it was significant for $I=378 \text{ kW/cm}^2$. We therefore performed a background correction. Each solid line follows the three-level correlation function from Eq. (5).

simultaneously drops to zero, $g^{(2)}(\tau = 0) = 0$ [28]. Experimentally $g^{(2)}(0) < 0.5$ is evidence for a single photon emitter. Figures 3 and 9 show the experimental correlation data. The minimum in the curve is shifted from $\tau = 0$ by $\tau_0 = 1.0 \pm 0.2 \text{ ns}$, which originates in unequal delays of the optical and electrical detection paths of the two SPDs.

We performed correlation measurements with different laser intensities. Figure 3, shows the intensity autocorrelation vs. the delay τ for laser intensities 2.6 kW/cm^2 and 378 kW/cm^2 with orange diamonds and green stars, respectively. The bin width, count rates, and background details used for normalizing the plots are given in appendix B along with data for additional laser intensities. Experimental correlation functions with $I < 135 \text{ kW/cm}^2$, reveal an antibunching dip, indicating that the selected PL source is a single photon emitter $g^{(2)}(\tau = 0) = 0.17$

for laser intensity $I = 2.6 \text{ kW/cm}^2$. As shown in Fig. 10, the signal increases linearly with the laser intensity I for low power but saturates for $I > 130 \text{ kW/cm}^2$. The background increases linearly with I , which results in a decreasing signal-to-background ratio at higher powers I and a reduced antibunching dip ($g^{(2)}(\tau = 0) > 0.5$), for data taken at $I > 135 \text{ kW/cm}^2$ (plotted in Fig. 9 in appendix B) [29]. A bunching behaviour is observed for $|\tau| > 9 \text{ ns}$ for the laser intensity of 378 kW/cm^2 in Fig. 3). These data can be modeled by considering at least a three-level system, as shown in Fig. 4. Absorption of laser light brings the system from the ground state $|G\rangle$ to the excited state $|E\rangle$ with a rate k_{ge} , which is proportional to the laser intensity I . Due to spontaneous emission from the excited state $|E\rangle$, most of the population returns to the ground state $|G\rangle$ with a rate k_{eg} and emits PL. Some of the population goes to the shelving state $|S_1\rangle$ due to the intersystem crossing (ISC) with a rate k_{es} . From the shelving state, the population returns to the ground state with a rate k_{sg} . From the shelving state population preferentially populates the $|\pm 1/2\rangle$ spin substates. The resulting population difference of up to 80% [5] makes ODMR measurements possible. Writing n_g , n_e , and n_s for the populations of the electronic ground state $|G\rangle$, excited state $|E\rangle$, and shelving state $|S_1\rangle$ respectively, the population dynamics can be written as

$$\frac{d}{dt}\vec{n} = \frac{d}{dt} \begin{pmatrix} n_g \\ n_e \\ n_s \end{pmatrix} = \begin{pmatrix} -k_{ge} & k_{eg} & k_{sg} \\ k_{ge} & -k_{eg} - k_{es} & \\ & k_{es} & -k_{sg} \end{pmatrix} \vec{n} \quad (2)$$

The eigenvectors \vec{v}_i are given in appendix D and the eigenvalues for Eq.(2) are

$$\vec{\lambda} = \frac{1}{2} \begin{pmatrix} 0 \\ A + \sqrt{A^2 - 4B} \\ A - \sqrt{A^2 - 4B} \end{pmatrix}, \quad (3)$$

where $A = k_{ge} + k_{eg} + k_{es} + k_{sg}$ and $B = k_{sg}(k_{eg} + k_{es} + k_{ge}) + k_{es}k_{ge}$. The resulting stationary state is

$$\vec{n}^{st} = \frac{1}{B} \begin{pmatrix} k_{sg}(k_{eg} + k_{es}) \\ k_{ge}k_{sg} \\ k_{es}k_{ge} \end{pmatrix}. \quad (4)$$

To calculate the theoretical correlation function $g^2(\tau)$, we need the excited state population at time τ when the system is initially in the ground state ($n_g(0) = 1$ and $n_e(0) = n_s(0) = 0$):

$$\frac{n_e(t)}{n_e^{st}} \stackrel{t=\tau}{=} g^{(2)}(\tau) = 1 - (1+c)e^{-\tau/\tau_1} + ce^{-\tau/\tau_2}, \quad (5)$$

with the inverse of the eigenvalues

$$\tau_{1,2} = 2/(A \pm \sqrt{A^2 - 4B}) \quad (6)$$

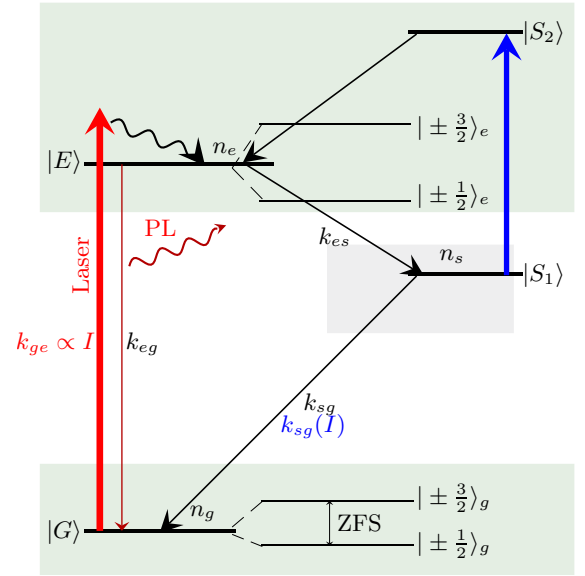

FIG. 4. Electronic energy levels scheme for V_{Si}^- on the cubic site (V_2). The optical excitation with a 785 nm laser, from the ground state to the excited state is indicated by the thick red arrow. Direct radiative (PL) relaxation from the excited state $|E\rangle$ to the ground state $|G\rangle$ is represented by a thin dark-red arrow. From the excited state the center can undergo inter-system crossing (ISC) to the shelving state $|S_1\rangle$, as indicated by black arrows. The ground state spin-sublevels are separated by the ZFS. k_{ge} , k_{eg} , k_{es} and k_{sg} are the transition rates from the ground to the excited state, excited state to ground state, excited state to shelving state and shelving state to ground state, respectively. The deshelling process, corresponds to a transfer of population from $|S_1\rangle$ to a higher energy level, $|S_2\rangle$, followed by another ISC.

and the bunching amplitude

$$c = \frac{1 - \tau_2 k_{sg}}{k_{sg}(\tau_2 - \tau_1)}. \quad (7)$$

In Fig. 3, the solid dark red lines are the fitted curves obtained using Eq. (5). In Fig. 5, we plot the extracted fit parameters τ_1 , τ_2 , and c vs. the laser intensity. The experimental data points are compared to theoretical curves that can be obtained from the intensity dependence of the effective rate coefficients

$$\begin{aligned} k_{sg} &= \frac{1}{(1+c^\infty)\tau_2^\infty}, \\ k_{es} &= k_{sg}c^\infty, \\ k_{eg} &= \frac{1}{\tau_1^0} - k_{23} (k_{eg} + k_{es}) > k_{sg}, \end{aligned} \quad (8)$$

where the values with superscript 0 refer to the low-intensity limit and those with superscript ∞ to the high intensity limit [19, 30]. The absorption cross section σ was obtained from the transition rate k_{ge} from the ground state to the excited state:

$$\sigma = \frac{h\nu}{I} \left(\frac{k_{ge}}{n_g} \right)$$

with the population n_g of the ground state and $I/h\nu$ the number of incident photons per second per unit area. At saturation intensity I_0 , the population n_g drops to $1/2$:

$$\frac{k_{ge}}{n_g(\infty)} = \frac{k_{sg}(k_{eg} + k_{es})}{k_{sg} + k_{eg}}. \quad (9)$$

The absorption cross section can be written as

$$\sigma = \frac{k_{ge}}{n_g} \frac{h\nu}{I_0} = \frac{k_{sg}(k_{eg} + k_{es})}{k_{sg} + k_{es}} \frac{h\nu}{I_0},$$

Fitting simultaneously the obtained values of $\tau_1^0 = (7.5 \pm 1.1)$ ns, $\tau_2^\infty = (17.2 \pm 1.4)$ ns and $c^\infty = 6.0 \pm 0.5$ from the data plotted in Fig. 5 after simultaneously fitting in Eqs. (3) and (7). As in previous works [19, 30], the three-level model describes well the antibunching decay time constant τ_1 (the black dashed line in Fig. 5(a)) and the bunching amplitude $c(I)$ (the black dashed line in Fig. 5 (c)). Table I shows the calculated rates and absorption cross section obtained from Eqs. (8). For low intensity ($I < 104$ kW/cm²) the bunching time constant reaches several hundred ns, much longer than the window considered in Fig. 3. At higher intensities, the bunching time gets shorter. In Ref. [19, 30], this is explained as a de-shelving process that can be described as shown in Fig. 4: The laser re-excites the system from the shelving state $|S_1\rangle$ to a higher-lying state $|S_2\rangle$ from where it can fall back to $|E\rangle$. The following are the rates for the 4-level model

$$\begin{aligned} k_{sg} &= \frac{dI}{I + I_0} + k_{sg}^0, \\ k_{sg}^0 &= \frac{1}{\tau_2^0}, \\ k_{sg}^\infty &= \frac{1}{\tau_2^\infty}, \\ k_{es} &= \frac{1}{\tau_2^\infty} - k_{sg}^0 - d \\ k_{eg} &= \frac{1}{\tau_1^0} - k_{es}, \end{aligned} \quad (10)$$

where $d = \frac{1/\tau_2^\infty - (1+c^\infty)/\tau_2^0}{1+c^\infty}$ [19, 30]. Inclusion of the deshelving process results in the intensity-dependent rate from shelving state to ground state k_{sg} [30]. Fitting simultaneously the obtained values of $\tau_1^0 = (6.7 \pm 1.4)$ ns, $\tau_2^0 = (204.4 \pm 166.3)$ ns, $\tau_2^\infty = (14.9 \pm 3.4)$ ns and $c^\infty = 6.3 \pm 0.9$ from the data plotted in Fig. (5) after simultaneously fitting in Eqs. (3) and (7), using 4-level rates given in Eqs. (10). The blue curves in Fig. 5

Model	Inverse rate coefficients in ns				Cross section σ (10^{-16} cm ²)
	$1/k_{eg}$	$1/k_{es}$	$1/k_{sg}^0$	$1/k_{sg}^\infty$	
3 levels	12 ± 3	20 ± 2	-	120 ± 13	1.1 ± 0.2
4 levels	11 ± 4	17 ± 8	204 ± 166	15 ± 3	4.9 ± 1.2

TABLE I. Inverse rate coefficients and absorption cross section of the V_{Si}^- center.

correspond to the 4-level model, which matches the experimental data better than the black dashed curves from the 3-level model. We now compare our results to previous work [19], in which silicon vacancies were created through high-energy neutron irradiation without post-annealing. The extracted transition times and cross-sections from the 4-level model were $1/k_{eg}=7.6$ ns, $1/k_{es}=16.8$ ns, $1/k_{sg}^0=150$ ns, $1/k_{sg}^\infty=123$ ns, and $\sigma=1.6 \times 10^{-16}$ cm² [19]. The transition times $1/k_{eg}$, $1/k_{es}$ and $1/k_{sg}^0$ measured by us for the shallow silicon vacancy center are compatible, within the experimental uncertainties, with those of Fuchs *et al.* [19]. Further the cross-section σ error bar's lower end is close to the cross-section measured by Fuchs *et al.* [19]. The main difference between the two samples is the defect generation method and the depth of the center. We tentatively assign the defect generation method to the $\approx 5\times$ increase that we observed in our rate k_{sg}^∞ . In our sample, emitters are created with low-energy Helium ion implantation, followed by 600°C annealing to remove parasitic lattice damage. As has been shown in previous work [23], high damage defect generation can significantly alter radiative and non-radiative decay processes, which may modify relaxation rates [31]. Since our emitters are located within ≈ 40 nm at the surface, we additionally expect coupling to surface charge states and traps, which may lead to a symmetry reduction through which additional decay channels can be allowed. We believe that a more thorough analysis on the modification of the rates as a function of the defect generation method would be useful, however, this would require low-temperature experiments [32], which go beyond the scope of this paper.

Over the duration of the intensity autocorrelation measurement, the count rate of the selected single center dropped significantly. We therefore used a different center (we call it center 2) for the ODMR experiment. The intensity autocorrelation measurement data for that center confirm that it is also a single center.

IV. OPTICALLY DETECTED MAGNETIC RESONANCE

In conventional electron spin resonance (ESR), spins are measured by inductive detection, which limits the sensitivity of the technique. Using optical polarization of the spin system and optical detection, it is possible to sufficiently increase the sensitivity for experiments on single spins [33, 34]. In this optically detected magnetic res-

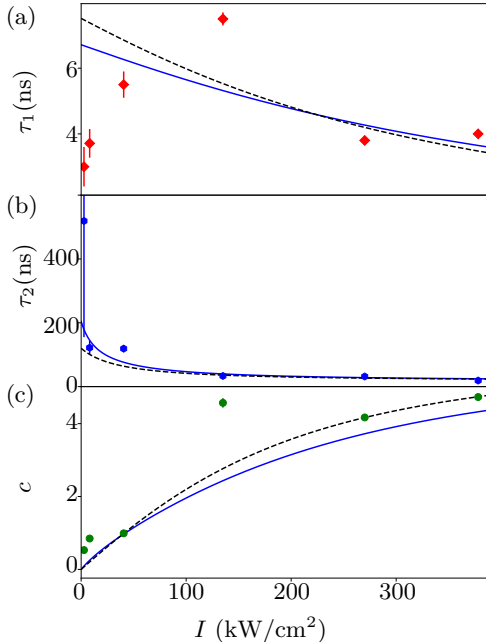

FIG. 5. Time constants τ_1 , τ_2 and bunching amplitude c of the second order correlation function for various laser power intensities. The experimental data are fitted with the functions of Eqs. (3) and (7). All three datasets are fitted simultaneously which results in the following parameters $\tau_1^0 = (7.5 \pm 1.1)$ ns, $\tau_2^\infty = (17.2 \pm 1.4)$ ns and $c^\infty = 6.0 \pm 0.5$ for the 3-level model (black dashed curves); $\tau_1^0 = (6.7 \pm 1.4)$ ns, $\tau_2^0 = (204.4 \pm 166.3)$ ns, $\tau_2^\infty = (14.9 \pm 3.4)$ ns and $c^\infty = 6.3 \pm 0.9$ for the 4-level model (blue curves).

onance (ODMR), the electron spin is excited with laser light to its optical excited state, and the PL emitted during re-emission is detected while a radio-frequency (RF) or microwave (MW) field drives the spin system. The different spin states contribute differently to the PL rate, so that a change in the spin polarization leads to a change of the PL rate, which can be used to measure spin polarization. We used this technique for measuring the ODMR of a single silicon vacancy in $4H$ -SiC.

For recording the single center’s continuous wave (CW) ODMR, the center was continuously illuminated with an optimized laser intensity of $68 \text{ kW}/\text{cm}^2$ where the signal to background ratio is maximal; more details are given in Appendix F. The ODMR was recorded in “lock-in mode”: while stepping the RF over the relevant frequency range, PL counts were recorded with and without RF. The difference between the two values $\Delta\text{PL} = \text{PL}_{\text{RF}} - \text{PL}_{\text{off}}$, is less sensitive to fluctuations of the laser intensity.

Figure 6 (a) shows the recorded ODMR signal at different RF powers (0.1 W, 0.5 W, 1.0 W and 1.8 W). The ODMR spectrum recorded with 0.1 W fitted in double Lorentzian function, and the obtained resonance frequencies are (72.8 ± 0.3) MHz for the main peak and $(36.4$

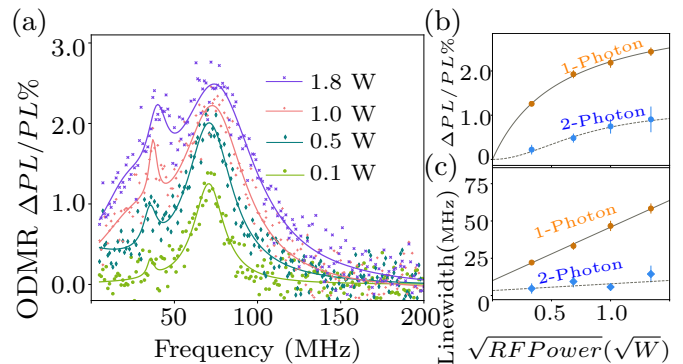

FIG. 6. (a) ODMR signal vs. frequency recorded for center 2 with different RF powers in absence of applied magnetic fields. The horizontal axis is the frequency in MHz, and the vertical axis is the relative change of the PL. (b) ODMR signal vs. RF field strength and (c) linewidth vs. RF field strength.

± 0.2) MHz for the smaller peak. The frequency of the larger peak matches the literature value of the zero-field splitting of the V_2 type V_{Si}^- in $4H$ -SiC [27]. At high RF power the Rabi frequency of the system is comparable to the resonance frequency of the system, the rotating wave approximation is no longer valid and causes nonlinear processes, such as multi-RF photon absorption [35]. In our previous work [35], we studied the multi-RF process in detail. In those experiment, the large signal-to-noise ratio of the V_3 spin ensemble in allowed detailed studies of the 1-, 2-, 3-, and 4-RF photon resonances. Here, the smaller peak is at half the frequency of the main peak, so we attribute it to the 2-RF photon peak. In the simulated spectra shown in Appendix G, Fig 13 (a), the multi-photon peaks are more clearly visible. In the experiment, the signal due to higher multi-photon absorption are not resolved due to limited signal-to-noise ratio. To take these unresolved signal contributions into account, we add a third Lorentzian component to the fitting function of the ODMR spectra when the applied RF power is higher than 0.5 W. Figures 6 (b) and (c) show the RF power dependence of the amplitudes and the linewidths for 1- and 2-photon peaks. The dependence of the amplitude is fitted with the function

$$S(P) = S_{max}[(P^{c/2}/(\Lambda_0 + P^{c/2}))], \quad (11)$$

where $S(P)$ is the ODMR signal amplitude and P is the RF power. The exponent c is 1 (2) for the 1- (2)-photon transitions [35]. The values for S_{max} and Λ_0 for the peaks are given in Table II.

The linewidth LW vs. the square root of the RF power \sqrt{P} is fitted to the function

$$LW(P) = LW_0 + a\sqrt{P}. \quad (12)$$

The obtained fitting parameters, intercept LW_0 and slope a are given in Table II. The low-power limit LW_0

Peak	c	$S_{max}(\%)$	$\mathcal{A}_0(W^{c/2})$	LW_0 (MHz)	a (MHz/ \sqrt{W})
1-photon	1	3.51 ± 0.25	0.59 ± 0.10	10.0 ± 2.3	35.9 ± 3.3
2-photon	2	1.2 ± 0.6	0.6 ± 0.6	$3.3_{-3.3}^{+4.0}$	5 ± 5

TABLE II. Obtained fitting parameters from Eq. (11) for the ODMR-signal amplitude and Eq. (12) for the linewidth vs RF field strength.

corresponds to the inverse dephasing time $1/(\pi LW_0)$ [36]. The low-power limit of the linewidth corresponds to a dephasing time of 32 ± 7 ns. One contribution to the linewidth are stray magnetic fields of about (0.5 G), which cause extra 2.8 MHz peak broadening. Apart from that, the contrast and the linewidth depend on the RF and laser intensity [37]. For the same kind of centers, $T_2^* = 34 \pm 4 \mu\text{s}$ was measured at 10 K using Ramsey interferometry in an external magnetic field of $B_0 = 36$ G oriented along the crystal's c -axis [23], and similar values were obtained in deep-bulk defects in similar SiC crystals [4, 38]. Due to differences in experimental conditions between the present work and the study by Babin et al. [23], a quantitative comparison of the dephasing rates estimated here from the low-power limit, LW_0 , and the T_2^* measured in their study is not meaningful. However, it is worth considering some conditions contributing to the differences. Babin et al. performed their measurements at a low temperature of 10 K, while the measurements presented here were obtained at room temperature. Additionally, Babin et al. used the Ramsey method to measure free precession, whereas the present measurements were obtained using the CW method. Furthermore, in Babin et al.'s study, selective low-power resonant excitation ensured the system was predominantly in the ground state. In contrast, in the present experiment, CW excitation led to the system being mostly in the metastable state, which contributes to the dephasing and line broadening. Lastly, Babin et al. applied a magnetic field to lift the degeneracy of the electron spin states, which reduces line-broadening from magnetic field noise and changes the dynamics of the nuclear spin bath and its contribution to the line broadening [39]. Fig. 13 (b) of Appendix H shows the linewidth of the simulated spectra vs. the RF coupling strength ($\Omega_1 = g\mu_B B_1$), which looks similar to the experimental data in Fig. 6 (c). As shown in Fig 13 (b) the width of the 2-photon resonance for low power tends to zero (which corresponds to $T_2^* \rightarrow \infty$ for 2-photon resonance) and the slope a_1 of the 2-photon resonance is smaller than that of the 1-photon resonance.

We recorded the ODMR of ten more centers with 9 W RF power and 185 kW/cm^2 laser intensity. We observed the contrast range and Fig. 7 shows the plot of number of centers vs. ODMR contrast. On average, we observed a $\approx 3 \%$ contrast per center, with a minimum contrast of 1% and a maximum contrast of 6%. We also recorded ODMR spectra of one of the high contrast center for the different RF and laser Powers; more details are given in

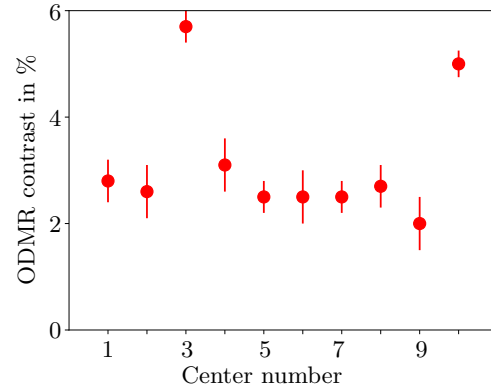

FIG. 7. ODMR contrast for different centers.

appendix G.

V. DISCUSSION AND CONCLUSION

Vacancy centers in silicon carbide are useful tools for sensing magnetic fields and for other quantum technologies. With existing fabrication technology, V_{Si}^- can be produced on-demand with a high probability, and reasonable resolution. Previously, the spin properties of a V_2 center deep inside a 4H-SiC sample have been studied using a solid immersion lens to enhance the PL of the V_2 center [3]. Here we characterized shallow single silicon-vacancy centers, which are very useful for quantum sensing applications. The single center is located approximately 40 nm below the surface, can be optically spin-polarized, and the measured optical transition rates are slightly different from the previously measured deep silicon-vacancy centers [3] and fitted well in 4-level model [19, 30].

The T_2^* of transition $\pm 3/2 \leftrightarrow \pm 1/2$ was 32 ns. Longer dephasing times are expected for the $+1/2 \leftrightarrow -1/2$ transition, since it is not affected by the zero-field splitting [7, 17]; this may be interesting for sensing applications. Observing this transition is possible in an external magnetic field, which lifts the degeneracy of these levels and can result in a population imbalance between them. The maximum ODMR contrast of $\approx 6 \%$ was obtained with 9 W RF power and 185 kW/cm^2 laser intensity.

To understand the exact cause of the difference between these transition rates and the ODMR contrast of the shallow and deep centers in our future work, we plan to perform experiments where we change the depth of the center, e.g. by etching technique. Illumination for more than 24 hours with an intensity of 378 kW/cm^2 reduces the count rates. The reduced count rate may be due to charge state conversion [40]. Here we used a 785 nm laser, i.e. non-resonant pumping. It may be possible to avoid the reduction of the count rate by using a different

laser wavelength close to zero phonon line. We will try this approach in our future work.

In conclusion, we reported room temperature ODMR data from single shallow V_{Si}^- centers in 4H-SiC. We observed higher ODMR contrast from the centers that were created with He^+ implantation than in previous studies where centers had been created by neutron irradiation [3, 19, 41]. Due to the higher contrast, we are able to record ODMR of a center with PL $\approx 8kcps$. An ensemble of V_{Si}^- in SiC has a single dipole orientation, in contrast to an ensemble of NV centers in diamond with four possible dipole orientations. For some applications, this increases the signal by a factor of four. So, this increased ODMR contrast due to shallowness makes the silicon-vacancy center a good candidate as NV center in diamonds for room temperatures sensing applications such as NMR of a small sample volume and MRI of single cells [18, 42–44].

APPENDIX A: SAMPLE

Arrays of V_{Si}^- centres via implantation of He^+ ions. He^+ ions were sent through a polymethyl methacrylate (PMMA) mask with 100 nm diameter holes, lithographed on the a face of an epitaxially grown SiC sample with a low nitrogen concentration in the $[N] = 4 \times 10^{13} \text{ cm}^{-3}$ range. The low He^+ ion energy of 6 keV was chosen to minimize the crystal damage. To remove residual lattice damage, the sample was annealed in argon atmosphere at 600° C for 30 min [23]. Figure 2 shows the room-temperature PL map of an implanted array using off-resonant excitation at 785 nm.

APPENDIX B: ODMR SETUP

The excitation path (Fig. 8, grey background) begins with a 785 nm 250 mW iBEAM-SMART-785-S-HP Laser (LA1) from Toptica which induces electronic transitions of the 4H-SiC-system. The 520 nm Lasertack 100 mW single mode diode laser (LA2) is used for alignment. Each laser beam is directed by two mirrors (M1 and M2 / M3 and M4) and coupled by the Thorlabs fiberports (C1/C2) into a Thorlabs 532 nm/ 785 nm NG71F1 y-fiber which combines both beams. To perform pulse experiments, an Acousto-Optic-Modulator (AOM) is placed in front of the red laser (LA1). The zero order beam is detected by a S2386-44K6K photodiode from Hamamatsu which monitors the stability of the laser output. The 1st order diffracted beam is coupled into the y-fiber. Finally the combined laser beam is coupled out of the y-fiber by fiberport (C3) and directed by mirror (M5) to the DMLP805 long-pass dichroic mirror (DM) from Thorlabs, which transmits wavelengths greater than 805 nm. Hence the combined light beam is reflected and directed by mirror (M6) into an Olympus UPLFLN100XO2 objective. It is mounted on a PI P-733.3CD XYZ-nanopositioner

which covers a range of 100 μm in X-/ Y- and 10 μm in Z-direction. This XYZ-nanopositioner is operated by a PI E-727 Digital Multi-channel Piezo Controller. The combined laser beam is focused onto the sample which is mounted onto a circuit board, where RF-fields are applied through a 50 μm copper wire. These RF-fields are generated by an Analog Devices AD9915 2.5 GSPS Direct Digital Synthesiser (DDS). The RF-power of range 20 MHz – 512 MHz can be increased for several watts by a 50 W Mini Circuit LZY-1 amplifier (AMP). It is important to connect a 50 Ω resistor at the other end of the circuit board to prevent damage of the electronic devices due to RF-reflections. Since the resistor is limited to 1 W, the RF-power is increased by an attenuator (AT) beforehand. The circuit board itself is screwed tight onto the sample stage that allows movements in Z-direction by a motorised Standa 8MT173 translation stage which is operated by the Standa 8SMC5-USB-B8-1 motor controller. In Fig. 8, the circuit board is shown in yellow whereas the objective is illustrated as a circle below it. All components of the detection path (Fig. 8, green background) are selected for the near-infrared range of 805 nm-1000 nm. PL emitted from the sample is collected by the microscope objective and directed by the mirror (M6) through the dichroic mirror (DM) (bright red line in Fig. 8). It is then directed by the mirrors (M7) and (M8) and focused by the lens (L1) with focal length of 100 mm, passes a 50 μm pinhole (PH) and is then collimated by the lens (L2) with a focal length of 150 mm. The following waveplate ($\lambda/2$) allows to adjust the ratio between transmitted and reflected PL at the polarized beam splitter (PBS) in the box. Before entering the box via a tube, the PL is filtered by a 850 nm long-pass-filter (F1). Depending on the type of measurement, a second filter (F2) like a (950 ± 25) nm band-pass-filter or a 850 nm long-pass-filter is used. The PL is splitted by the PBS and directed to the lens (L3/ L4), each with focal length of 100 mm, which focuses the PL onto the Laser Components Count-100N single photon detectors (SPD1 and SPD2, with photon detection efficiency at 810 nm is 68 % and 59%). When performing an ODMR-measurement, the registered events are counted by a Measurement Computing 1808X-USB DAQ-card (DAQ), which has a 50 Ω resistor at each input to prevent reflections. For intensity autocorrelation measurements, we used time tagger and counters of quPSI from quTools.

APPENDIX C: DETAILS OF INTENSITY AUTOCORRELATION MEASUREMENTS

All but one g^2 -measurements shown in Fig. 9 were taken with a bin width W_b of 486 ps, whereby the histogram data for $I = 378 \text{ kW/cm}^2$ was obtained with W of 162 ps. Eventually, all unnormalized histogram datasets were normalized by $N_{norm} = T W_b R_1 R_2$, with total time T , bin width W_b and count rates R_i of the detectors D_i and afterwards smoothed to a bin width of 972 ps. The to-

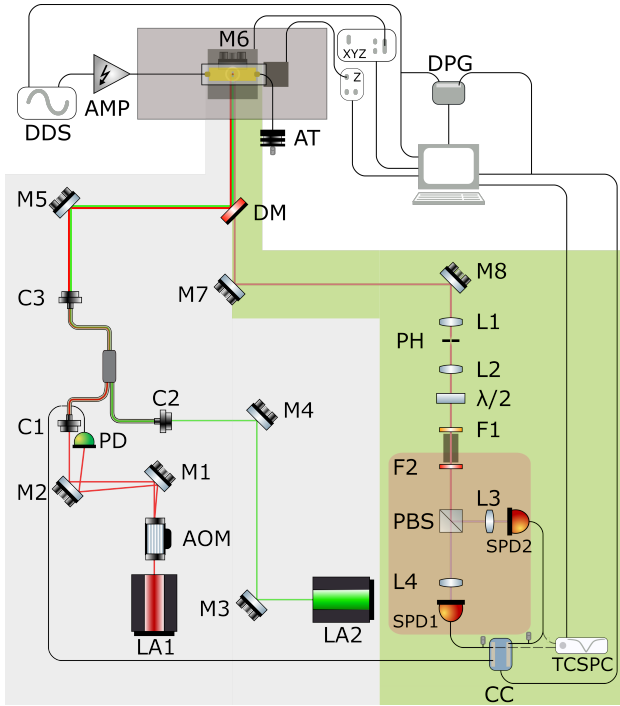

FIG. 8. Experimental confocal scan setup for the CW-ODMR (zfODMR), intensity autocorrelation and pulse measurements. The detectors are isolated in a box (in reddish-brown) to prevent noise from external light sources. PL can enter the box via a tube (between F1 and F2). Excitation path (gray background): the center is optically excited by a 785 nm laser. RF transitions are induced by a 50 μm copper wire over the sample. Detection path (green background): the PL is detected by two single-photon detectors (SPD1 and SPD2), which are connected to the DAQ-card (DAQ) for ODMR measurements. When performing a g^2 -measurement, the detectors are connected to the quPSI TCSPC device (indicated by dashed lines).

tal count rates $R = R_1 + R_2$ are obtained by dividing the total number of counts by the total time for the g^2 -measurement. Finally, the individual count rates were then obtained by $R_1 = 0.6 R$ and $R_2 = 0.4 R$. At $I = 2.6 \text{ kW/cm}^2$, only the dark count rates of R_1 , $D = 251 \text{ counts/s}$ and R_2 , $D = 129 \text{ counts/s}$ at each detector contribute to the background due to slightly different models. But a linear increase in background for increasing excitation power is observed in Fig. 10, which can be considered by applying a background-correction. Since the background-correction cannot be applied for a background which only consists of the detectors dark counts, it was applied on all histogram datasets except for the one at lowest excitation powers of 2.6 kW/cm^2 . Only the obtained normalized histogram data at smallest (orange diamond) and at greatest (green star) optical excitation power are shown in Fig. 3. All histogram datasets are shown in Fig. 9.

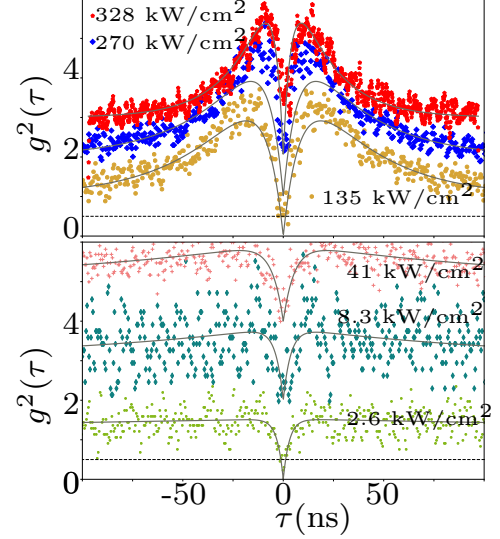

FIG. 9. Complete series of intensity autocorrelation measurements performed from 2.6 kW/cm^2 to 378 kW/cm^2 . The histogram data is first normalized by $N_{\text{norm}} = T W_b R_1 R_2$ and then smoothed to a bin width of 972 ps. Besides for the lowest $I = 2.6 \text{ kW/cm}^2$, all histogram dataset are corrected for their background. Each solid line follows the three-level correlation function from Eq. (5).

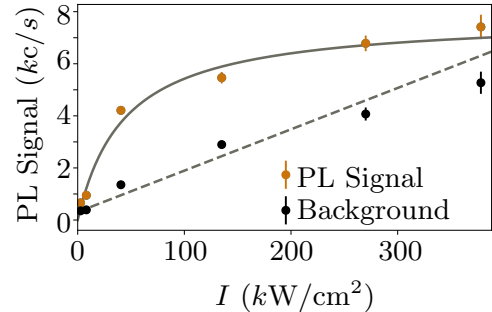

FIG. 10. PL-signal at different intensities I of the center on which g^2 -measurements were performed. The PL-signal is fitted by: $S = S_{\text{max}} I / (I_0 + I)$ with $(7.8 \pm 0.3) \text{ kcounts/s}$ and $I_0 = (44 \pm 3) \text{ kW/cm}^2$, whereas the background increases linearly with the slope $m = (15.9 \pm 0.6) \text{ counts cm}^2 / (\text{kW s})$ and intercept $b = (309 \pm 20) \text{ counts/s}$.

APPENDIX D: EIGENVECTORS

Eigenvectors of the three level model

$$\vec{v}_1 = \begin{pmatrix} 1 \\ \frac{k_{sg}}{k_{es}} \\ \frac{k_{sg}(k_{eg} + k_{es})}{k_{es}k_{ge}} \end{pmatrix}, \quad \vec{v}_2 = \begin{pmatrix} -1 \\ G \\ -F \end{pmatrix}, \quad \vec{v}_3 = \begin{pmatrix} -1 \\ -G \\ F \end{pmatrix},$$

where

$$F = \frac{H + k_{eg} - k_{es} + k_{ge} - k_{sg}}{2k_{es}};$$

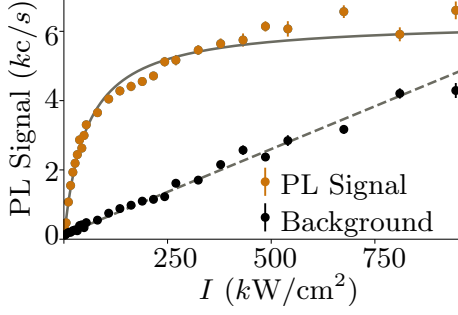

FIG. 11. PL-signal at different intensities I . The PL-signal is fitted by: $S = S_{max}I/(I_0 + I)$ with (6.3 ± 0.1) kcps and $I_0 = (53 \pm 2)$ kW/cm², whereas the background increases linearly with the slope $m = (4.9 \pm 0.1)$ counts cm²/(kW s) and intercept $b = (130 \pm 8)$ cps.

$$G = \frac{H + k_{eg} + k_{es} + k_{ge} - k_{sg}}{2k_{es}}$$

$$H = \sqrt{k_{eg}^2 + 2k_{eg}(k_{es} + k_{ge} - k_{sg})} - J$$

$$J = 2k_{sg}(k_{es} + k_{ge}) + (k_{es} - k_{ge})^2 + k_{sg}^2$$

APPENDIX F: OPTIMAL LASER POWER FOR ODMR

A suitable electrical excitation Intensity I can be obtained from the saturation behaviour of the PL-signal. In Fig. 11, a maximum PL-signal of (6.3 ± 0.1) kcps can be obtained, while the background increases linearly with increasing I . Therefore, $I_0 = (53 \pm 2)$ kW/cm² is chosen for ODMR-measurements, since the PL-signal is almost saturated while the background is relatively small. Even if a high background is mostly compensated by the references detection ΔPL , it has the advantage that the autofocus works more reliably at low background.

APPENDIX G: ODMR SIMULATIONS

For the numerical simulation, we used the Lindblad master equation

$$\frac{\partial \rho}{\partial t} = -2\pi i [\mathcal{H}_t(t), \rho] + \sum_{\alpha, \beta, \delta_1, \dots, 5} L_i^\dagger \cdot \rho \cdot L_i - \frac{1}{2} \left\{ L_i^\dagger L_i, \rho \right\}$$

here $\mathcal{H}_t(t) = \mathcal{H} + \mathcal{H}_{RF}(t)$, $L_\alpha = \sqrt{2} \begin{pmatrix} 0 & \sqrt{\gamma} & 0 & 0 \\ \sqrt{\gamma} & 0 & \sqrt{\alpha} & 0 \\ 0 & \sqrt{\alpha} & 0 & \sqrt{\gamma} \\ 0 & 0 & \sqrt{\gamma} & 0 \end{pmatrix} \approx \sqrt{2\alpha} S_x$ drives the

spin-lattice relaxation process, $\gamma = 3\alpha/4$, $L_\beta = \sqrt{2\beta} S_z$ is the Lindblad operator for the dephasing process, and $L_{\delta_1, \dots, 5}$ are the Lindblad operators for the optical pumping [35]

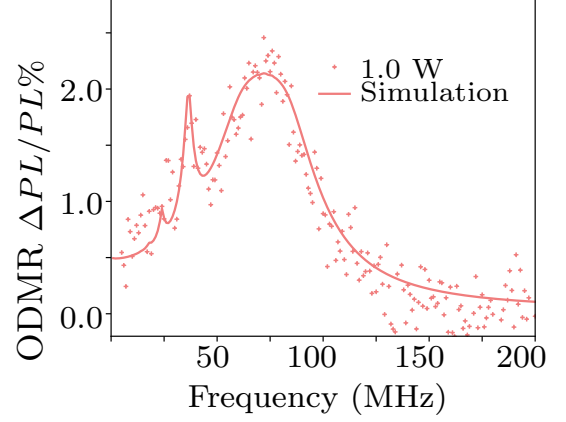

FIG. 12. Experimental and simulated ODMR plots for silicon vacancy with the RF Hamiltonian of Eq. 13.

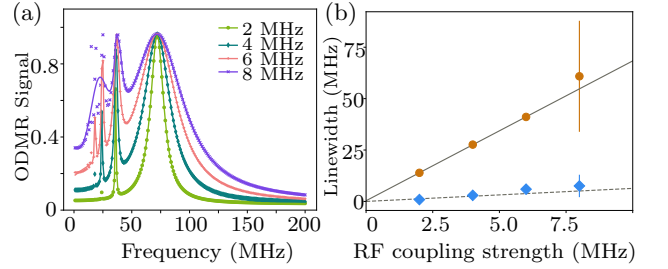

FIG. 13. (a) Simulated ODMR spectra at different RF strengths. (b) Linewidth of 1-photon and 2-photon resonances vs. RF coupling strength.

$$L_{\delta_1} = \sqrt{\delta} \begin{pmatrix} 0 & 0 & 0 & 0 \\ 1 & 0 & 0 & 0 \\ 0 & 0 & 0 & 0 \\ 0 & 0 & 0 & 0 \end{pmatrix}, L_{\delta_2} = \sqrt{\delta} \begin{pmatrix} 0 & 0 & 0 & 0 \\ 0 & 0 & 0 & 1 \\ 0 & 0 & 0 & 0 \\ 0 & 0 & 0 & 0 \end{pmatrix},$$

$$L_{\delta_3} = \sqrt{\delta} \begin{pmatrix} 0 & 0 & 0 & 0 \\ 0 & 0 & 0 & 0 \\ 1 & 0 & 0 & 0 \\ 0 & 0 & 0 & 0 \end{pmatrix}, L_{\delta_4} = \sqrt{\delta} \begin{pmatrix} 0 & 0 & 0 & 0 \\ 0 & 0 & 0 & 0 \\ 0 & 0 & 0 & 1 \\ 0 & 0 & 0 & 0 \end{pmatrix},$$

$$L_{\delta_5} = \sqrt{\delta} \begin{pmatrix} 0 & 0 & 0 & 0 \\ 0 & 0 & 1 & 0 \\ 0 & 1 & 0 & 0 \\ 0 & 0 & 0 & 0 \end{pmatrix}, \text{ and } \delta \text{ is the optical pumping}$$

rate [7].

The interaction Hamiltonian between the RF field and the spins is

$$\mathcal{H}_{RF}(t) = \Omega_1 \cos(2\pi\omega t)(S_x + S_z),$$

where $\Omega_1 = g\mu_B B_1$ represents the strength of the coupling to the RF field B_1 in frequency units and ω is the oscillation frequency of the field. Figure 12 shows the experimental and simulated ODMR spectra at 8 MHz RF

Peak	LW_0 (MHz)	a
1	0.34 ± 0.21	6.80 ± 0.05
2	≈ 0	0.63 ± 0.05

TABLE III. Obtained fitting parameters from Eq. (14) for the linewidth vs RF field strength.

coupling strengths with $\alpha = 7 \text{ ms}^{-1}$, $\beta = 10 \text{ } \mu\text{s}^{-1}$, and $\delta = 185 \text{ ms}^{-1}$; the simulated spectrum matches well with the experimentally recorded ODMR at 1 W RF power. Since we are using simple optical pumping model [7], the amplitude of the simulated spectrum is normalized to the maximal ODMR contrast for the plot. For the simulated spectrum, we integrated Eq. (13) for $1.5 \text{ } \mu\text{s}$ for every frequency. Additional details can be found in our previous work [35]. Figure 13 (a) shows the simulated ODMR spectra at different RF coupling strengths with the same parameters used for simulating ODMR spectrum in Fig 12 except for the value of β , which we reduced here to $2.5 \text{ } \mu\text{s}^{-1}$ to better resolve the multi-photon peaks.

In Fig 13, with an RF coupling strength of 2 MHz, we can see 1-photon, and 2-photon peaks at 72 MHz and 36 MHz and a small signal of 3-photon peak at 24 MHz. At 8 MHz, the 5-, 4- and 3-photon peaks are also visible and close to each other, and therefore difficult to resolve. The linewidth of the 1- and 2-photon peaks are extracted by fitting the simulated ODMR to a sum of Lorentzians. Fig 13 (b) shows the resulting dependence of the linewidth LW vs. the square root of the RF power A together with a fit to the function

$$LW(P) = LW_0 + a_1 \Omega_1. \quad (14)$$

The obtained fitting parameters, intercept LW_0 and the slope a are given in Table (III).

APPENDIX H: ODMR WITH DIFFERENT RF AND LASER POWERS

Figure 14 (a) shows the ODMR signal recorded for one of the high-contrast centers with different RF power, keep-

ing the laser intensity at 184 kW/cm^2 and (b) for different Laser intensity at 2 W RF power. At 9 W RF power, the ODMR signal contrast is 5.3 %, and the laser intensity does not affect the ODMR contrast significantly. In the course of recording these data, the PL count of the center fell from 8 kcps to 4 kcps which impacts the signal-to-noise ratio of the later recorded variable laser intensity ODMR spectra.

ACKNOWLEDGMENTS

This work was supported by the Deutsche Forschungsgemeinschaft in the frame of the ICRC TRR 160 (Project (a) (b)

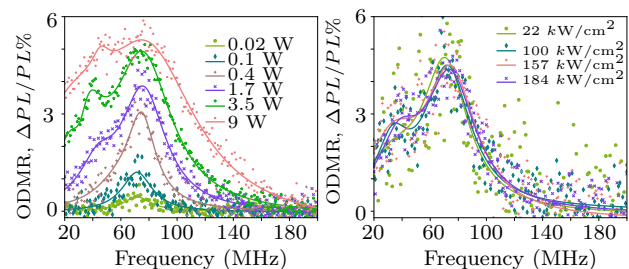

FIG. 14. ODMR spectra recorded for one of the high contrast centers (out of ten measured centers), (a) with different applied RF power and 184 kW/cm^2 laser intensity; (b) with different laser intensities and 2.6 W RF power. The horizontal axis is the frequency in MHz, and the vertical axis is the relative change of the PL%.

No. C7). J.U.H. acknowledge support from Swedish Research Council under VR grant No.2020-05444 and Knut and Alice Wallenberg Foundation (grant no. KAW 2018.0071). J.U.H. and F.K. acknowledge support from the European Union through the QuantERA grant In-QuRe. F.K. acknowledges support from the German ministry of education and research (BMBF, grant no. 16KIS1639K, 16KISQ013 and 13N16219).

[1] W. F. Koehl, B. B. Buckley, F. J. Heremans, G. Calusine, and D. D. Awschalom, Room temperature coherent control of defect spin qubits in silicon carbide, *Nature* **479**, 84 (2011).
[2] H. Kraus, V. A. Soltamov, D. Riedel, S. V ath, F. Fuchs, A. Sperlich, P. G. Baranov, V. Dyakonov, and G. V. Astakhov, Room-temperature quantum microwave emitters based on spin defects in silicon carbide, *Nature Physics* **10**, 157 (2013).

[3] M. Widmann, S.-Y. Lee, T. Rendler, N. T. Son, H. Fedder, S. Paik, L.-P. Yang, N. Zhao, S. Yang, I. Booker, *et al.*, Coherent control of single spins in silicon carbide at room temperature, *Nature materials* **14**, 164 (2015).
[4] R. Nagy, M. Niethammer, M. Widmann, Y.-C. Chen, P. Udvarhelyi, C. Bonato, J. U. Hassan, R. Karhu, I. G. Ivanov, N. T. Son, *et al.*, High-fidelity spin and optical control of single silicon-vacancy centres in silicon carbide, *Nature communications* **10**, 1954 (2019).

- [5] V. A. Soltamov, A. A. Soltamova, P. G. Baranov, and I. I. Proskuryakov, Room temperature coherent spin alignment of silicon vacancies in $4h$ - and $6h$ -sic, *Phys. Rev. Lett.* **108**, 226402 (2012).
- [6] D. Riedel, F. Fuchs, H. Kraus, S. Vath, A. Sperlich, V. Dyakonov, A. A. Soltamova, P. G. Baranov, V. A. Ilyin, and G. V. Astakhov, Resonant addressing and manipulation of silicon vacancy qubits in silicon carbide, *Physical review letters* **109**, 226402 (2012).
- [7] H. Singh, A. N. Anisimov, I. D. Breev, P. G. Baranov, and D. Suter, Optical spin initialization of spin- $\frac{3}{2}$ silicon vacancy centers in $6h$ -SiC at room temperature, *Phys. Rev. B* **103**, 104103 (2021).
- [8] S. G. Carter, O. O. Soykal, P. Dev, S. E. Economou, and E. R. Glaser, Spin coherence and echo modulation of the silicon vacancy in $4h$ - SiC at room temperature, *Phys. Rev. B* **92**, 161202(R) (2015).
- [9] D. Simin, H. Kraus, A. Sperlich, T. Ohshima, G. V. Astakhov, and V. Dyakonov, Locking of electron spin coherence above 20 ms in natural silicon carbide, *Phys. Rev. B* **95**, 161201(R) (2017).
- [10] D. J. Christle, A. L. Falk, P. Andrich, P. V. Klimov, J. U. Hassan, N. T. Son, E. Janzen, T. Ohshima, and D. D. Awschalom, Isolated electron spins in silicon carbide with millisecond coherence times, *Nature materials* **14**, 160 (2015).
- [11] H. Singh, A. N. Anisimov, S. S. Nagalyuk, E. N. Mokhov, P. G. Baranov, and D. Suter, Experimental characterization of spin-3/2 silicon vacancy centers in $6h$ -sic, *Phys. Rev. B* **101**, 134110 (2020).
- [12] I. Lekavicius, R.L. Myers-Ward, D.J. Pennachio, J.R. Hazzus, D.K. Gaskill, A.P. Purdy, A.L. Yeats, P.G. Brereton, E.R. Glaser, T.L. Reinecke, and S.G. Carter, Orders of magnitude improvement in coherence of silicon-vacancy ensembles in isotopically purified $4H$ -SiC, *PRX Quantum* **3**, 010343 (2022).
- [13] P. Udvarhelyi, G. m. H. Thiering, N. Morioka, C. Babin, F. Kaiser, D. Lukin, T. Ohshima, J. Ul-Hassan, N. T. Son, J. Vuckovic, J. Wrachtrup, and A. Gali, Vibronic states and their effect on the temperature and strain dependence of silicon-vacancy qubits in $4h$ -SiC, *Phys. Rev. Applied* **13**, 054017 (2020).
- [14] Z. Shang, A. Hashemi, Y. Berencen, H.-P. Komsa, P. Erhart, S. Zhou, M. Helm, A. V. Krasheninnikov, and G. V. Astakhov, Local vibrational modes of si vacancy spin qubits in sic, *Phys. Rev. B* **101**, 144109 (2020).
- [15] A. Anisimov, D. Simin, V. A. Soltamov, S. P. Lebedev, P. G. Baranov, G. V. Astakhov, and V. Dyakonov, Optical thermometry based on level anticrossing in silicon carbide, *Scientific reports* **6**, 33301 (2016).
- [16] J. B. S. Abraham, C. Gutgsell, D. Todorovski, S. Sperling, J. E. Epstein, B. S. Tien-Street, T. M. Sweeney, J. J. Wathen, E. A. Pogue, P. G. Brereton, T. M. McQueen, W. Frey, B. D. Clader, and R. Osiander, Nanotesla magnetometry with the silicon vacancy in silicon carbide, *Phys. Rev. Appl.* **15**, 064022 (2021).
- [17] V. A. Soltamov, C. Kasper, A. V. Poshakinskiy, A. N. Anisimov, E. N. Mokhov, A. Sperlich, S. A. Tarasenko, P. G. Baranov, G. V. Astakhov, and V. Dyakonov, Excitation and coherent control of spin qubit modes in silicon carbide at room temperature, *Nature Communications* **10**, 1678 (2019).
- [18] J. M. Taylor, P. Cappellaro, L. Childress, L. Jiang, D. Budker, P. Hemmer, A. Yacoby, R. Walsworth, and M. Lukin, High-sensitivity diamond magnetometer with nanoscale resolution, *Nature Physics* **4**, 810 (2008).
- [19] F. Fuchs, B. Stender, M. Trupke, D. Simin, J. Pflaum, V. Dyakonov, and G. Astakhov, Engineering near-infrared single-photon emitters with optically active spins in ultrapure silicon carbide, *Nature communications* **6**, 1 (2015).
- [20] T. C. Hain, F. Fuchs, V. A. Soltamov, P. G. Baranov, G. V. Astakhov, T. Hertel, and V. Dyakonov, Excitation and recombination dynamics of vacancy-related spin centers in silicon carbide, *Journal of Applied Physics* **115**, 133508 (2014), <https://doi.org/10.1063/1.4870456>.
- [21] C. Kasper, D. Klenkert, Z. Shang, D. Simin, A. Gottscholl, A. Sperlich, H. Kraus, C. Schneider, S. Zhou, M. Trupke, W. Kada, T. Ohshima, V. Dyakonov, and G. V. Astakhov, Influence of irradiation on defect spin coherence in silicon carbide, *Phys. Rev. Appl.* **13**, 044054 (2020).
- [22] T. Hornos, A. Gali, and B. G. Svensson, Large-scale electronic structure calculations of vacancies in $4h$ -sic using the heyd-scuseria-ernzerhof screened hybrid density functional, in *Materials Science Forum*, Vol. 679 (Trans Tech Publ, 2011) pp. 261–264.
- [23] C. Babin, R. Stohr, N. Morioka, T. Linkewitz, T. Steidl, R. Wornle, D. Liu, E. Hesselmeier, V. Vorobyov, A. Denisenko, *et al.*, Fabrication and nanophotonic waveguide integration of silicon carbide colour centres with preserved spin-optical coherence, *Nature materials* **21**, 67 (2022).
- [24] J. Wang, X. Zhang, Y. Zhou, K. Li, Z. Wang, P. Peddibhotla, F. Liu, S. Bauerdick, A. Rudzinski, Z. Liu, *et al.*, Scalable fabrication of single silicon vacancy defect arrays in silicon carbide using focused ion beam, *Acs Photonics* **4**, 1054 (2017).
- [25] S. P. Pavunny, A. L. Yeats, H. B. Banks, E. Bielejec, R. L. Myers-Ward, M. T. DeJarld, A. S. Bracker, D. K. Gaskill, and S. G. Carter, Arrays of si vacancies in $4h$ -sic produced by focused li ion beam implantation, *Scientific reports* **11**, 1 (2021).
- [26] V. Ivady, J. Davidsson, N. T. Son, T. Ohshima, I. A. Abrikosov, and A. Gali, Identification of si-vacancy related room-temperature qubits in $4h$ silicon carbide, *Phys. Rev. B* **96**, 161114(R) (2017).
- [27] P. G. Baranov, A. P. Bundakova, A. A. Soltamova, S. B. Orlinskii, I. V. Borovykh, R. Zondervan, R. Verberk, and J. Schmidt, Silicon vacancy in sic as a promising quantum system for single-defect and single-photon spectroscopy, *Phys. Rev. B* **83**, 125203 (2011).
- [28] A. M. Fox, M. Fox, *et al.*, *Quantum optics: an introduction*, Vol. 15 (Oxford university press, 2006).
- [29] T. Basche, W. E. Moerner, M. Orrit, and H. Talon, Photon antibunching in the fluorescence of a single dye molecule trapped in a solid, *Phys. Rev. Lett.* **69**, 1516 (1992).
- [30] E. Neu, D. Steinmetz, J. Riedrich-Moller, S. Gsell, M. Fischer, M. Schreck, and C. Becher, Single photon emission from silicon-vacancy colour centres in chemical vapour deposition nano-diamonds on iridium, *New Journal of Physics* **13**, 025012 (2011).
- [31] C. A. Kasper, *Engineering of Highly Coherent Silicon Vacancy Defects in Silicon Carbide*, Ph.D. thesis, Universitat Wurzburg (2021).
- [32] N. Morioka, D. Liu, O. O. Soykal, I. Gediz, C. Babin, R. Stohr, T. Ohshima, N. T. Son, J. Ul-Hassan, F. Kaiser,

- and J. Wrachtrup, Spin-optical dynamics and quantum efficiency of a single v1 center in silicon carbide, *Phys. Rev. Appl.* **17**, 054005 (2022).
- [33] D. Suter, Optical detection of magnetic resonance, *Magnetic Resonance* **1**, 115 (2020).
- [34] D. Suter and F. Jelezko, Single-spin magnetic resonance in the nitrogen-vacancy center of diamond, *Progress in Nuclear Magnetic Resonance Spectroscopy* **98-99**, 50 (2017).
- [35] H. Singh, M. A. Hollberg, A. N. Anisimov, P. G. Baranov, and D. Suter, Multi-photon multi-quantum transitions in the spin- $\frac{3}{2}$ silicon-vacancy centers of sic, *Phys. Rev. Research* **4**, 023022 (2022).
- [36] J. Wertz, *Electron spin resonance: elementary theory and practical applications* (Springer Science & Business Media, 2012).
- [37] K. Jensen, V. M. Acosta, A. Jarmola, and D. Budker, Light narrowing of magnetic resonances in ensembles of nitrogen-vacancy centers in diamond, *Phys. Rev. B* **87**, 014115 (2013).
- [38] A. Bourassa, C. P. Anderson, K. C. Miao, M. Onizhuk, H. Ma, A. L. Crook, H. Abe, J. Ul-Hassan, T. Ohshima, N. T. Son, *et al.*, Entanglement and control of single nuclear spins in isotopically engineered silicon carbide, *Nature Materials* **19**, 1319 (2020).
- [39] O. Bulancea-Lindvall, N. T. Son, I. A. Abrikosov, and V. Ivády, Dipolar spin relaxation of divacancy qubits in silicon carbide, *npj Computational Materials* **7**, 213 (2021).
- [40] G. Wolfowicz, C. P. Anderson, A. L. Yeats, S. J. Whiteley, J. Niklas, O. G. Poluektov, F. J. Heremans, and D. D. Awschalom, Optical charge state control of spin defects in 4h-sic, *Nature communications* **8**, 1 (2017).
- [41] J.-F. Wang, Q. Li, F.-F. Yan, H. Liu, G.-P. Guo, W.-P. Zhang, X. Zhou, L.-P. Guo, Z.-H. Lin, J.-M. Cui, *et al.*, On-demand generation of single silicon vacancy defects in silicon carbide, *Acs Photonics* **6**, 1736 (2019).
- [42] D. R. Glenn, K. Lee, H. Park, R. Weissleder, A. Yacoby, M. D. Lukin, H. Lee, R. L. Walsworth, and C. B. Connolly, Single-cell magnetic imaging using a quantum diamond microscope, *Nature methods* **12**, 736 (2015).
- [43] D. R. Glenn, D. B. Bucher, J. Lee, M. D. Lukin, H. Park, and R. L. Walsworth, High-resolution magnetic resonance spectroscopy using a solid-state spin sensor, *Nature* **555**, 351 (2018).
- [44] D. B. Bucher, D. R. Glenn, H. Park, M. D. Lukin, and R. L. Walsworth, Hyperpolarization-enhanced nmr spectroscopy with femtomole sensitivity using quantum defects in diamond, *Phys. Rev. X* **10**, 021053 (2020).